

~~Smithsonian~~
Zool.

5

P. N.

729909
Smithsonian
48

SMITHSONIAN MISCELLANEOUS COLLECTIONS

VOL. 82



"EVERY MAN IS A VALUABLE MEMBER OF SOCIETY WHO, BY HIS OBSERVATIONS, RESEARCHES, AND EXPERIMENTS, PROCURES KNOWLEDGE FOR MEN"—SMITHSON

(PUBLICATION 3132)



CITY OF WASHINGTON
PUBLISHED BY THE SMITHSONIAN INSTITUTION
1931

The Lord Baltimore Press
BALTIMORE, MD., U. S. A.

ADVERTISEMENT

The present series, entitled "Smithsonian Miscellaneous Collections," is intended to embrace all the octavo publications of the Institution, except the Annual Report. Its scope is not limited, and the volumes thus far issued relate to nearly every branch of science. Among these various subjects zoology, bibliography, geology, mineralogy, anthropology, and astrophysics have predominated.

The Institution also publishes a quarto series entitled "Smithsonian Contributions to Knowledge." It consists of memoirs based on extended original investigations, which have resulted in important additions to knowledge.

C. G. ABBOT,
Secretary of the Smithsonian Institution.

CONTENTS

1. ABBOT, C. G., AND FREEMAN, H. B., Absorption lines of the infra-red solar spectrum. 17 pp., 5 pls., Aug. 31, 1929. (Publ. 3026.)
2. SNODGRASS, R. E., The thoracic mechanism of a grasshopper and its antecedents. 111 pp., 54 text figs., Dec. 31, 1929. (Publ. 3027.)
3. ABBOT, C. G., The radiation of the planet earth to space. 12 pp., 2 pls., Nov. 16, 1929. (Publ. 3028.)
4. MILLER, GERRIT S., JR., The Characters of the Genus *Geocapromys* Chapman. 3 pp., 1 pl., Dec. 9, 1929. (Publ. 3029.)
5. MILLER, GERRIT, S. JR., Mammals eaten by Indians, owls, and Spaniards in the coast region of the Dominican Republic. 16 pp., 2 pls., Dec. 11, 1929. (Publ. 3030.)
6. BERRY, EDWARD W., The past climate of the North Polar region. 29 pp., 6 figs., Apr. 9, 1930. (Publ. 3061.)
7. CLAYTON, H. HELM, The atmosphere and the sun. 49 pp., 33 text figs., June 9, 1930. (Publ. 3062.)
8. NELSON, E. W., Four new raccoons from the keys of Southern Florida. 12 pp., 5 pls., July 10, 1920. (Publ. 3066.)
9. HERON-ALLEN, EDWARD, F. R. S., The further and final researches of Joseph Jackson Lister upon the reproductive processes of *Polystomella crispa* (Linné). 11 pp., 7 pls., Nov. 26, 1930. (Publ. 3067.)
10. SCHEDL, KARL E., Morphology of the bark-beetles of the genus *Gnathotrichus* Eichh. 88 pp., 40 figs., Jan. 24, 1931. (Publ. 3068.)
11. HAURY, EMIL W., AND HARGRAVE, LYNDON L., Recently dated Pueblo ruins in Arizona. 120 pp., 27 pls., 35 text figs., Aug. 18, 1931. (Publ. 3069.)
12. BUSHNELL, DAVID I., JR., The five Monacan towns in Virginia, 1607. 38 pp., 14 pls., Nov. 18, 1930. (Publ. 3070.)
13. MILLER, GERRIT S., JR., A note on the skeletons of two Alaskan porpoises. 2 pp., 1 pl., Dec. 23, 1930. (Publ. 3107.)
14. MILLER, GERRIT S., JR., The supposed occurrence of an Asiatic goat-antelope in the Pleistocene of Colorado. 2 pp., 2 pls., Dec. 22, 1930. (Publ. 3108.)

15. MILLER, GERRIT S., JR., Three small collections of mammals from Hispaniola. 10 pp., 2 pls., Dec. 24, 1930. (Publ. 3109.)
16. REESE, A. M., The ductless glands of *Alligator mississippiensis*. 14 pp., 3 pls., March 9, 1931. (Publ. 3110.)
17. KENNARD, A. S., A. L. S., SALISBURY, A. E., AND WOODWARD, B. B., F. L. S., The types of Lamarck's genera of shells as selected by J. G. Children in 1823. 40 pp., July 11, 1931. (Publ. 3112.)
18. McINDOO, N. E., Tropisms and sense organs of Coleoptera. 70 pp., 2 pls., 19 text figs., Apr. 18, 1931. (Publ. 3113.)



SMITHSONIAN MISCELLANEOUS COLLECTIONS

VOLUME 82, NUMBER 1

ABSORPTION LINES OF THE INFRA-RED
SOLAR SPECTRUM

(WITH FIVE PLATES)

BY

G. G. ABBOT AND H. B. FREEMAN



(PUBLICATION 3026)

CITY OF WASHINGTON
PUBLISHED BY THE SMITHSONIAN INSTITUTION
AUGUST 31, 1929

SMITHSONIAN MISCELLANEOUS COLLECTIONS
VOLUME 82, NUMBER 1

ABSORPTION LINES OF THE INFRA-RED SOLAR SPECTRUM

(WITH FIVE PLATES)

BY
G. G. ABBOT AND H. B. FREEMAN



(PUBLICATION 3026)

CITY OF WASHINGTON
PUBLISHED BY THE SMITHSONIAN INSTITUTION
AUGUST 31, 1929

The Lord Baltimore Press
BALTIMORE, MD., U. S. A.

ABSORPTION LINES OF THE INFRA-RED SOLAR SPECTRUM

BY C. G. ABBOT AND H. B. FREEMAN

(WITH 5 PLATES)

In the decade 1890 to 1900, the bolometer was used under Langley's direction at the Astrophysical Observatory of the Smithsonian Institution to feel out the positions of lines and bands in the infra-red solar spectrum. The results were published in Volume I of the *Annals of the Observatory*. In the spectral region A to Ω , about 550 lines were recorded as observed in the spectrum of a 60° prism of ordinary telescope flint.

At Mount Wilson, in the summer of 1928, Dr. H. D. Babcock urged that further bolographic studies of the infra-red solar spectrum should be undertaken with apparatus of higher resolving power. Our

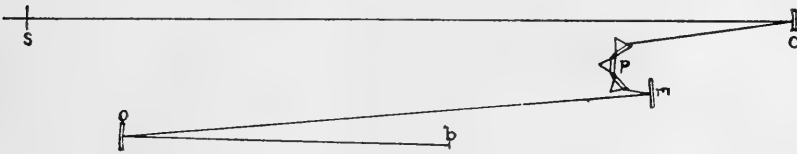

FIG. 1.

vacuum bolometer equipment, then on Mount Wilson, presents a sensitive strip of approximately 0.1 mm. width, and the combined outfit of bolometer and galvanometer was certainly not less than five times as sensitive as the most sensitive outfit employed at Washington 30 years before.

It appeared practicable to undertake a brief bolographic study of the upper infra-red solar spectrum from A to Ω in the time available. Accordingly we set up a spectroscope (fig. 1) comprising a slit 6 cm. high and (usually) 0.4 mm. wide; a collimating, cylindric mirror of 543 cm. focal length; a set of three telescope flint-glass prisms, two of 60° , the third of 64° angle, and all presenting faces approximately 6 cm. square. From thence a plane silver-on-glass mirror reflected the spectrum to an image-forming spherical mirror of 230 cm. focal length. The vacuum bolometer, above mentioned, whose sensitive strip was 16×0.1 mm., received the rays at focus. The spectroscope

was fed by a two-mirror coelostat with silver-on-glass mirrors. The solar rays were not concentrated on the slit. Hence they represented the integrated rays of the entire solar disk.

The infra-red solar energy spectrum was recorded on moving photographic plates 8 x 24 in. in surface. The clockwork was arranged so that 4 cm. of plate corresponds to 5' of spectrum, and the plate passed the recording light-spot of the galvanometer at the rate of 2 cm. in 1 minute.

The three prisms were set according to computations so that the beam of rays of wave-length 1.05μ would pass through each one of the prisms approximately in minimum deviation. This same setting was continued unchanged in all the observations. The total deviation of the rays of this wave-length was roughly 180° and the dispersion from A to Ω was about $5^\circ 25'$. Hence we were obliged to use five 61-cm. plates to cover the entire region with overlap sufficient for identification.

Generally three curves of each of the five regions were impressed on a single photographic plate. Care was taken to arrange them vertically in close superposition, so as to facilitate comparison. Plates 1 to 5 give reproductions of some of the most satisfactory observations.

Linear scales are drawn on plates 1 to 5 parallel to the direction of motion of the recording photographic plate. They have numbers closely agreeing with those of the extensive table 3 of linear measures and wave-lengths, given below. In each group of three curves the air-mass of observation decreases as between the several curves from the bottom upward and in each curve (except in pl. 5) from left towards right. In most plates there is a very considerable increase of air-mass between the upper and lower curves. This will facilitate the discrimination, by those interested, of solar and telluric lines. Details of times of observation and air-mass and notes on the conditions are given in table 2.

A very considerable increase of detail appeared in these energy curves when compared with those taken 30 years ago with a single glass prism. In the A line, for instance, not only could the doubles be recognized, but in many of them the individual components were resolved separately in the energy curve. Some of the bands near wave-length 0.82μ showed as many as five veridical lines in the new curves where only one broad band could be distinguished in the older work.

The identification of lines was done entirely by Mr. Freeman, and in the following manner. A series of several bolographs was superposed, either on millimeter cross-section paper or on a comparator

in which a stretched wire was displaceable over a milk-glass background. Lines were considered provisionally veridical when found as deflections of similar form and similar setting in three or more bolographs. After completing this preliminary study, the positions of all deflections considered possibly veridical were measured on three bolographs with the excellent Warner and Swasey comparator described on page 64 of Volume I of the Annals. Mean values were computed of positions on three (or in some cases two) of these bolographs on which the deflections were found. When found on only two of the three they were questioned, and rejected unless supported by further evidence.

In assigning intensities, Mr. Freeman used practically the same system that was used in Volume I of the Annals. Grades a, b, c, d, and d? were employed. All lines falling within great bands like A, $\rho\sigma\tau$, ϕ , ψ , and Ω are joined in a bracket and designated as a whole with "a." Bands hardly reaching this first-class prominence are similarly bracketed and marked "b." Individual deflections, or composites of several small deflections which altogether make a depression of 5 mm. or more in bolographs are marked "c." Smaller individual deflections, whether in the bands or outside of them, are marked "d." When considerable doubt remains as to the veridical character of such a deflection, it is marked "d?." We do not guarantee that all the lines included in the table are veridical, but we believe a very large proportion of them are so. The curves are very free from accidental deflections as deep as a single half millimeter, and the repetition on several bolographs of similar configurations of intensity "d" is regarded as strong presumptive evidence of reality of corresponding solar or terrestrial absorption lines.

To determine the wave-lengths of the lines observed, the advice of Dr. Babcock was sought. From his studies of all existing laboratory determinations of infra-red line spectra, amplified by his own extensive photographic work in the upper infra-red spectrum as far as $\lambda = 1.1018$ Angstroms, he sent a list of 112 identifications of wave-length places, given according to our bolographic work in Volume I of the Annals, as compared to more recent determinations. A curve of correction to the wave-lengths given in Volume I of the Annals has been prepared from this material. In summary it is as indicated in table 1.

The data for corrections beyond 1.18μ are so scanty and so conflicting that there seemed no justification for applying any corrections in that region.

TABLE 1.—*Corrections to Wave-Lengths of Annals, Volume I*
(*Corrections are stated in Angstroms, wave-lengths in microns.*)

Wave-lengths...	0.76 to 0.84	0.85	0.86	0.87	0.88	0.89	0.90	0.91	
Corrections.....	0	+5	+5	+5	+3	+2	0	-2	
Wave-lengths...	0.92	0.93	0.94	0.95	0.96	0.97	0.98	0.99	1.00
Corrections.....	-2	-1	0	+2	+2	+1	0	-3	-5
Wave-lengths...	1.01	1.02 to 1.06	1.07	1.08	1.09	1.10	1.11	1.12	1.13
Corrections.....	-8	-10	-9	-7	-6	-5	-4	-3	-1
Wave-lengths...	1.14 to end								
Corrections.....	0								

In further determination of wave-lengths, Mr. Freeman identified 81 deflections as corresponding each to each in the old and the new bolometric work. These deflections covered fairly uniformly the range from 0.76μ to 1.80μ . Having taken out from the tables of Volume I of the Annals the corresponding wave-lengths, he then applied to these values the corrections fixed by table 1. He then plotted on a sufficiently large scale the observed linear places of these 81 deflections as ordinates, and the corrected wave-lengths as abscissae. The curves thus defined could easily be read off to a single Angstrom. From them were read all the wave-lengths given in table 3, which contains over 1200 lines.

TABLE 2.—*Circumstances of Observation*

Date 1928	Curve	Time		Air-mass		Notes
		Start	Finish	Start	Finish	
Sept. 4.....	1	9:39	10:09	1.31	1.23	
	2	10:17	10:47	1.21	1.16	
	3	10:52	11:22	1.15	1.12	
Sept. 4.....	1	6:28	6:58	4.85	3.23	
	2	7:59	8:29	1.97	1.69	
	3	8:51	9:21	1.54	1.38	
Sept. 5.....	1	6:34	7:04	4.49	3.05	Slight earthquake
	2	9:11	9:41	1.43	1.31	
	3	9:50	10:20	1.28	1.20	
Sept. 1.....	1	6:29	6:59	4.70	3.15	
	2	9:19	9:49	1.36	1.27	
	3	9:58	10:28	1.24	1.17	
Sept. 1.....	3	3:34	3:54	1.82	2.18	Ends off plate
	2	2:58	3:28	1.54	1.76	
	1	1:13	1:43	1.17	1.23	

TABLE 3.—*Lines and Bands in the Infra-Red Solar Spectrum*

Linear measures	Intensity	Wave-length	Linear measures	Intensity	Wave-length
—34.130	d	7582	—25.233	d	7727
34.035	d?	7583	.122	d?	7728
33.103	d?	7598	25.019	d	7730
32.858	d	7602	24.831	d	7733
.767	d	7604	.418	d	7740
.682	d	7606	.322	d	7741
32.575	d?	7608	.233	d	7743
31.911	d	7618	.153	d	7744
.306	d	7628	24.036	d	7746
31.191	d	7630	23.801	d	7750
30.819	d	7636	.696	d	7752
.747	d	7638	.573	d	7754
.516	d	7641	.461	d?	7755
.451	d	7642	.176	d?	7760
.264	d	7645	23.079	d	7762
.190	d	7646	22.964	d	7764
30.119	d?	7647	.690	d	7760
29.895	d	7651	.621	d	7770
.827	d?	7652	.272	d	7776
.576	d	7656	.178	d	7778
.499	d	7658	22.046	d	7780
.266	d	7661	21.906	d	7782
29.185	d	7662	.807	d	7784
28.921	d	7665	.696	d	7786
.846	d	7668	.472	d	7790
.581	d	7672	.343	d	7792
.508	d	7674	.240	d	7794
.415	d?	7675	21.095	d?	7796
28.069	d	7680	20.871	d	7800
27.847	d	7684	.687	d	7803
.701	d	7686	.521	d	7806
.377	d	7691	.318	d?	7809
.281	d	7692	20.114	d	7812
27.173	d	7695	19.935	d	7816
26.898	d	7698	.826	d	7817
.769	d	7701	.756	d	7818
.664	d	7703	.650	d	7820
.545	d	7705	.547	d	7822
.431	d	7707	.226	d	7827
.242	d	7710	19.111	d	7820
.146	d	7711	18.951	d	7832
26.059	d	7712	.837	d	7834
25.929	d	7714	.755	d	7835
.696	d	7718	18.080	d	7846
.477	d	7722	17.949	d	7849
.361	d	7725	.830	d	7850

b

A

a

c

c

c

TABLE 3.—*Lines and Bands in the Infra-Red Solar Spectrum.*—Continued

Linear measures	Intensity	Wave-length	Linear measures	Intensity	Wave-length
—17.726	d	7852	—5.692	d?	8069
16.273	d?	7878	5.570	d	8071
15.621	d	7889	4.896	d	8084
.322	d	7894	.784	d	8086
15.136	d	7898	.635	d	8088
14.932	d	7901	.500	d?	8091
.823	d	7903	.400	d	8093
.644	d	7906	.286	d	8095
.470	d	7909	4.153	d	8097
14.207	d	7914	3.747	d	8106
13.910	d	7919	.645	d	8108
.625	d	7924	.543	d	8109
.509	d?	7926	.384	d	8112
.406	d?	7928	.296	d	8114
.196	d	7932	3.105	d?	8118
13.050	d	7934	2.967	d	8120
12.861	d	7937	.658	d	8126
.764	d	7939	.537	d	8129
.676	d	7941	.378	d	8132
.450	d	7945	2.255	d	8134
.275	d	7948	1.839	d	8142
12.055	d	7952	.536	d	8148
11.844	d	7956	.338	d	8152
.720	d?	7958	.238	d	8154
.604	d	7960	.142	d	8156
.324	d	7966	1.062	d	8157
.208	d	7968	0.812	d	8162
11.004	d	7972	.739	d?	8164
10.619	d	7979	0.000	c	8178
9.866	d	7992	.123	d	8181
.765	d	7994	.469	d	8188
.688	d	7996	.601	d	8190
.389	d	8001	0.775	d	8193
.283	d	8003	+1.037	d	8199
9.102	d	8006	.349	d	8206
8.908	d	8008	.751	d	8214
8.249	d	8022	1.854	d	8216
7.982	d?	8027	2.220	d?	8224
.818	d	8029	.296	d	8225
.530	d	8035	.392	d	8228
.311	d	8038	.468	d?	8229
7.011	d	8044	.700	d	8233
6.927	d	8045	2.800	d	8235
.769	d	8048	3.028	d	8240
.647	d	8051	.243	d	8244
6.541	d	8053	.336	d	8246
5.955	d	8063	.463	d	8249
.856	d	8065	.569	d	8251

TABLE 3.—*Lines and Bands in the Infra-Red Solar Spectrum.*—Continued

Linear measures	Intensity	Wave-length	Linear measures	Intensity	Wave-length
+3.612	d	8252	+12.086	d	8430
.691	d	8253	12.518	d	8440
.820	d	8256	13.006	d	8450
3.927	d	8258	.128	d?	8453
4.036	d	8260	.243	d	8455
.706	d	8274	.675	d	8465
.794	d	8275	13.948	d	8470
4.892	d	8277	14.416	d	8480
5.108	d	8282	14.599	d	8484
.191	d	8283	15.042	d	8494
.421	d	8288	.132	d	8496
.482	d	8289	.231	d	8498
.566	d?	8291	.333	d	8500
5.829	d	8297	.694	d	8508
6.124	d	8303	15.937	d	8513
.233	d	8305	16.046	d	8516
.304	d?	8307	.132	d	8517
.476	d	8310	.369	d	8523
.505	d	8311	16.468	d	8525
.668	d	8314	17.033	d	8537
6.996	d	8321	.218	d	8541
7.163	d	8325	17.947	d	8558
.431	d	8330	18.144	d	8562
.549	d	8333	.260	d?	8565
.666	d	8335	.456	d	8569
7.755	d	8337	.556	d	8572
8.003	d	8342	.761	d	8576
.209	d	8346	18.864	d	8579
.490	d	8352	19.044	d?	8583
.743	d	8358	.138	d	8585
8.888	d	8361	.242	d	8587
9.204	d	8368	19.722	d	8590
.317	d	8370	20.251	d	8611
.394	d?	8372	.398	d	8614
.467	d	8373	20.610	d	8620
.575	d	8376	21.060	d	8630
9.731	d	8379	.201	d	8633
10.023	d	8385	.488	d	8640
.260	d	8391	.591	d	8642
.499	d	8396	21.692	d	8645
.697	d	8400	22.256	d?	8658
10.814	d	8403	.381	d	8662
11.043	d	8407	.464	d	8663
.288	d	8413	22.625	d	8667
.590	d	8420	23.056	d?	8677
11.966	d	8428	.254	d	8682

TABLE 3.—*Lines and Bands in the Infra-Red Solar Spectrum.*—Continued

Linear measures	Intensity	Wave-length	Linear measures	Intensity	Wave-length
+23.472	d	8687	+32.148	d	8895
.562	d	8689	.226	d	8897
.684	d?	8692	.348	d?	8900
23.783	d	8694	.526	d?	8904
24.568	d?	8713	.733	d	8909
25.223	d	8728	32.961	d	8915
.392	d	8732	33.101	d	8918
.510	d	8735	.419	d	8926
.596	d?	8737	33.860	d	8937
.682	d	8739	34.014	d	8941
25.823	d	8742	.222	d?	8946
26.181	d?	8750	.414	d	8951
.288	d	8753	.746	d	8959
.460	d	8757	34.891	d	8962
.705	d	8763	35.090	c	8967
.802	d	8766	.448	d	8976
26.931	d?	8768	35.791	d	8984
27.052	d	8772	36.049	d	8990
.143	d	8774	.553	d	9004
.261	d	8777	.775	d	9010
.494	d	8782	36.895	d	9014
.689	d	8787	37.060	d	9018
27.996	d	8794	.680	d	9036
28.105	d	8797	37.819	d	9039
.223	d	8800	38.094	d	9047
.332	d	8803	.180	d?	9049
.385	d	8804	.562	d	9060
.687	d	8811	.892	d	9060
.783	d	8813	38.974	d?	9071
.879	d	8816	39.582	d	9087
28.973	d	8818	.783	d	9092
29.247	d?	8824	.878	d	9095
.402	d	8829	39.892	d	9096
.524	d	8832	40.040	d?	9100
.720	d	8837	.192	d	9104
.823	d	8839	.273	d	9106
29.903	d	8841	40.603	d	9115
30.036	d	8844	41.062	d	9127
.166	d?	8847	.120	d	9129
.395	d	8852	41.423	d	9137
.540	d	8856	42.046	d	9154
.667	d	8859	.165	d	9157
.843	d	8864	.255	d	9160
30.941	d	8866	.800	d	9175
31.128	d	8870	42.985	d	9179
.247	d	8873	43.047	d	9181
31.881	d	8880	.431	d	9192
32.064	d?	8893	.513	d?	9194

TABLE 3.—*Lines and Bands in the Infra-Red Solar Spectrum.*—Continued

Linear measures	Intensity	Wave-length	Linear measures	Intensity	Wave-length
+43.711	d	9200	+55.674	d	9548
43.884	d	9204	56.010	c	9558
44.101	d	9210	.369	c	9568
.278	d	9215	56.738	d	9580
.347	d?	9217	57.254	d	9596
.525	d	9222	57.503	d	9604
.623	d	9225	58.073	d	9621
.776	d	9229	.245	d	9626
44.977	d	9234	.352	d	9629
45.101	d	9238	.534	d	9634
.235	d	9241	58.667	d	9639
.310	d	9244	59.058	c	9651
.429	d	9247	.472	d	9663
.540	d?	9250	.568	d	9666
.729	d	9255	59.642	d	9668
.854	d	9258	60.482	d	9694
45.949	d?	9261	.773	d	9704
46.221	d	9269	60.975	d?	9710
.337	d	9272	61.069	d	9713
.836	d	9286	.544	d	9727
46.907	d	9288	61.931	d	9739
47.101	d	9294	62.229	d	9749
.212	d	9296	.532	d	9758
.533	d	9305	.634	d	9761
47.637	d	9308	62.745	d	9765
48.205	d	9324	63.103	d	9777
.295	d	9327	.666	d	9795
.509	d	9333	63.956	d	9804
48.817	d	9342	64.252	d	9814
49.124	d	9351	.724	d	9829
49.648	d	9366	.898	d	9834
50.022	d	9376	64.985	d	9837
51.122	d	9409	65.224	d	9845
.204	d	9412	.342	d	9848
.328	d	9415	.464	d	9853
.421	d	9418	.561	d	9856
51.737	d	9427	65.693	d	9860
52.107	c	9439	66.141	d	9874
52.523	c	9451	.285	d	9879
53.039	c	9467	.421	d	9883
.487	d	9480	.617	d?	9890
53.963	d	9495	66.923	d	9900
54.060	d	9498	67.250	d	9910
.174	d?	9502	.486	d	9917
54.278	d	9506	.675	d?	9924
55.098	b	9529	67.772	d	9927

TABLE 3.—*Lines and Bands in the Infra-Red Solar Spectrum.*—Continued

Linear measures	Intensity	Wave-length	Linear measures	Intensity	Wave-length
+68.099	d	9937	+74.504	d	10150
.248	d	9942	.626	d	10154
.643	d	9954	.750	d	10159
.751	d	9958	74.912	d	10164
.870	d	9962	75.211	d	10175
68.997	d	9966	.341	d?	10179
69.098	d	9969	.526	d	10186
.235	d	9973	.708	d	10192
.375	d	9978	75.830	d	10194
.517	d	9983	76.001	d?	10202
.615	d	9986	.108	d	10206
.772	d	9991	.329	d	10214
.863	d	9994	.519	d	10221
69.972	d?	9997	.631	d	10224
70.060	d	10000	76.765	d	10229
.179	d?	10004	77.033	d	10239
.401	d?	10010	.227	d	10245
.509	d	10014	.333	d	10249
.634	d	10018	.470	d	10254
.796	d	10024	.732	d	10263
70.944	d	10028	77.855	d	10268
71.061	d	10032	78.019	d	10274
.452	d	10044	.150	d	10278
.562	d	10048	.289	d	10283
.676	d	10053	.368	d?	10286
.780	d	10056	.517	d	10292
.878	d	10060	.649	d	10296
71.983	d	10063	.757	d?	10300
72.088	d	10067	.827	d?	10302
.220	d	10072	78.961	d	10308
.313	d	10075	79.088	d	10312
.389	d?	10077	.217	d?	10316
.494	d?	10081	.346	d	10321
.603	d	10084	.534	d	10327
.719	d	10088	.727	d	10334
72.821	d?	10092	.842	d	10338
73.023	d	10099	79.998	d?	10344
.139	d	10103	80.219	d?	10352
.238	d	10106	.320	d?	10356
.317	d?	10109	.521	d	10363
.401	d?	10112	.619	d	10367
.514	d	10116	.721	d?	10370
.691	d	10122	.833	d?	10374
73.990	d	10132	80.988	d	10379
74.208	d	10140	81.105	d	10384
.323	d	10144	.220	d	10388

TABLE 3.—*Lines and Bands in the Infra-Red Solar Spectrum.*—Continued

Linear measures	Intensity	Wave-length	Linear measures	Intensity	Wave-length
+81.324	d	10392	+89.892	d?	10714
.450	d	10396	89.995	d	10719
.569	d	10400	90.139	d	10724
81.680	d?	10405	.336	d	10732
82.016	d	10417	.441	d	10736
.120	d?	10421	.533	d	10740
.343	d	10428	90.753	d	10749
.444	d	10432	91.091	d?	10762
.560	d	10437	.249	d	10768
.671	d?	10441	.344	d	10772
82.933	d	10450	.467	d	10777
83.024	d?	10453	.566	d?	10781
.124	d	10457	.667	d	10785
.246	d	10462	.776	d	10789
.396	d	10467	91.953	d?	10796
.731	d	10479	92.269	d	10808
83.846	d	10484	.472	d	10816
84.002	d	10490	.556	d	10820
.122	d?	10494	.654	d	10823
.229	d	10498	.782	d	10828
.547	d	10510	.866	d?	10832
.788	d	10518	92.980	d	10836
84.957	d	10525	93.046	d?	10839
85.279	d	10537	.232	d	10845
.592	d	10547	.393	d	10852
.787	d	10556	.487	d?	10855
85.909	d	10561	.731	d	10866
86.356	d	10578	93.962	d	10874
.551	d	10585	94.050	d	10878
.772	d	10594	.469	d	10894
86.959	d	10601	.554	d?	10898
87.134	d	10607	.679	d	10902
.233	d	10611	94.777	d	10906
.472	d	10621	95.373	d	10930
.582	d	10623	.506	d	10936
87.851	d	10636	.625	d	10941
88.047	d	10643	95.860	d	10950
.233	d	10650	96.124	d	10960
.557	d	10662	.234	d	10964
88.832	d	10673	.353	d	10969
89.009	d	10680	96.782	d	10986
.130	d	10684	97.003	d	10996
.245	d	10688	.119	d	11000
.359	d	10694	.272	d	11006
.453	d	10697	.383	d	11011
.721	d?	10708	.485	d	11015

TABLE 3.—*Lines and Bands in the Infra-Red Solar Spectrum.*—Continued

Linear measures	Intensity	Wave-length	Linear measures	Intensity	Wave-length
+97.673	d	11023	+112.005	d	11634
97.898	d	11032	.187	d	11642
98.211	d	11045	.292	d	11646
.293	d	11048	112.888	d	11670
.400	d	11052	113.051	d	11678
.509	d?	11057	.152	d	11682
98.737	d	11066	.466	d	11696
99.101	d	11081	.614	d	11702
.435	d	11094	113.948	d	11716
.767	d	11106	114.119	d	11723
99.806	d	11113	.823	d	11754
100.387	d	11133	114.916	c	11758
.473	d	11137	115.428	d	11780
100.900	d	11155	115.821	c	11797
101.102	d	11165	116.084	d	11808
101.704	c	11190	.397	d	11822
102.378	d	11217	116.914	d	11845
.447	d	11220	117.034	d	11850
.862	d	11238	.140	d	11855
102.960	d	11242	117.726	d	11881
103.224	d	11254	118.034	d	11895
.761	d	11278	.154	d	11900
.832	d	11281	.322	d	11908
103.934	d	11285	.448	d	11914
105.179	b	11340	.600	d	11921
105.993	d	11376	.720	d	11927
106.242	d	11388	118.828	d?	11931
.595	d	11404	119.133	d	11945
.684	d	11407	.211	d	11949
106.790	d	11412	.334	d?	11954
107.588	d	11448	.440	d	11959
107.855	d	11460	119.738	d?	11972
108.607	d	11491	120.059	d	11988
.723	d	11496	.232	d	11996
108.808	d	11499	120.424	d	12000
109.102	d	11511	121.127	d	12038
.389	c	11524	.200	d	12042
109.702	d	11537	.303	d	12046
110.141	d	11555	.427	d	12052
.237	d	11559	.821	d	12071
.572	d	11574	121.914	d	12075
110.912	d	11588	122.022	d	12080
111.116	d	11596	.134	d	12085
.587	d	11616	.248	d	12091
111.660	d?	11620	.406	d?	12008

TABLE 3.—*Lines and Bands in the Infra-Red Solar Spectrum.*—Continued

Linear measures	Intensity	Wave-length	Linear measures	Intensity	Wave-length
+122.514	d	12104	+128.914	d	12416
.612	d	12108	129.000	d	12422
122.759	d?	12115	.219	d	12432
123.132	d	12133	.319	d	12437
.277	d	12140	.437	d	12443
.480	d	12150	.564	d	12450
.594	d	12156	129.903	d?	12468
.720	d?	12162	130.009	d	12473
.842	d	12168	.112	d	12478
123.957	d	12173	.248	d	12485
124.044	d?	12177	.338	d	12489
.177	d?	12183	.545	d	12501
.438	d	12196	130.767	d	12512
124.918	d	12219	131.216	d	12536
125.023	d	12224	.409	d	12546
.197	d	12232	.526	d	12552
.311	d?	12236	.620	d	12556
.396	d	12242	.711	d	12562
.495	d	12247	.838	d	12568
.627	d	12254	131.927	d	12572
.707	d	12257	132.006	d	12577
125.859	d?	12265	.193	d	12586
126.113	d	12277	.311	d	12593
.294	d	12286	.367	d	12596
.411	d	12294	.473	d	12601
.579	d	12300	.600	d	12608
.700	d	12306	.698	d	12613
.799	d	12310	132.799	d	12618
126.941	d	12317	133.551	b	12658
127.047	d	12322	134.119	d	12688
.173	d?	12329	.304	d	12698
.303	d	12335	134.469	d	12707
.406	d	12340	135.049	d	12739
.536	d	12347	.201	d	12748
.644	d	12352	.311	d	12753
.734	d	12356	.401	d	12759
.839	d	12362	.507	d	12764
127.914	d	12366	.629	d	12770
128.025	d	12372	135.961	d	12788
.111	d	12376	136.071	d	12794
.222	d	12381	.186	d	12799
.309	d	12386	.619	d	12822
.415	d	12391	.807	d?	12833
.546	d	12398	136.937	d?	12839
.667	d	12404	137.031	d	12845
.783	d	12409	.150	d	12851

TABLE 3.—*Lines and Bands in the Infra-Red Solar Spectrum.*—Continued

Linear measures	Intensity	Wave-length	Linear measures	Intensity	Wave-length
+137.264	d	12858	+143.603	d	13198
.411	d	12866	.727	d	13205
.493	d	12870	.834	d	13210
.578	d?	12874	143.940	d	13217
137.878	d	12891	144.013	d	13221
138.016	d	12898	.114	d	13226
.111	d	12903	.867	d	13267
.231	d	12909	144.959	d	13272
.301	d?	12913	145.434	d	13299
.427	d	12920	.508	d	13302
.806	d	12940	.732	d?	13314
138.930	d	12945	145.820	d	13319
139.048	d	12953	146.484	d	13355
.212	d	12962	146.565	d	13360
.324	d	12968	147.020	c	13385
.489	d	12976	.199	c	13396
.599	d	12983	147.738	c	13425
.735	d	12990	148.417	c	13464
.835	d	12995	.905	d?	13491
139.942	d	13001	148.991	d	13495
140.038	d	13006	149.095	d	13501
.114	d	13010	.350	d	13516
.210	d	13015	.446	d	13522
.313	d	13020	.549	d?	13527
.424	d	13026	.651	d	13532
.625	d	13037	149.744	d	13538
.719	d	13042	150.069	d	13555
.834	d	13048	.144	d	13560
.926	d	13053	.461	d	13578
140.997	d?	13057	.598	d	13586
141.086	d	13061	.793	d	13597
.308	d	13074	150.910	d	13604
.412	d	13080	151.259	d?	13623
.520	d	13085	.358	d	13628
.617	d	13090	.442	d	13634
141.877	d	13104	.815	d	13654
142.120	d	13118	151.920	d	13660
.236	d	13124	152.024	d?	13667
.339	d	13129	.284	d?	13681
.449	d	13136	.393	d	13687
.564	d	13142	.545	d?	13696
.708	d	13150	152.895	d?	13716
.844	d	13158	153.024	d	13724
142.962	d	13163	.163	d	13732
143.070	d	13170	.273	d?	13738
.216	d	13178	.467	d	13749
.331	d	13183	.866	d	13772
.446	d	13190	153.956	d	13777

TABLE 3.—*Lines and Bands in the Infra-Red Solar Spectrum.*—Continued

Linear measures	Intensity	Wave-length	Linear measures	Intensity	Wave-length
+154.208	d?	13781	+169.987	d	14708
.296	d	13796	170.791	d	14756
.617	d	13815	170.883	d	14760
.724	d	13821	171.330	c	14788
154.898	d	13833	.618	d	14804
155.010	d	13838	171.996	d	14826
.113	d	13843	172.090	d	14832
.222	d	13850	.501	c	14855
.408	d	13860	172.604	d	14862
.507	d	13866	173.270	c	14901
155.936	d	13890	.369	d	14907
156.826	d	13942	173.918	d	14938
157.693	b	13994	174.011	d	14944
158.425	c	14036	.311	d	14962
.759	d	14057	.436	d	14969
158.859	d	14060	174.805	d?	14991
159.280	c	14086	175.205	d	15014
.587	d?	14103	.332	d	15021
159.691	d	14109	175.987	d	15060
160.140	b	14135	176.097	c	15070
.632	d	14164	.589	d	15100
160.969	c	14184	.842	d	15112
161.049	d?	14188	176.967	d	15120
.379	d?	14206	177.361	d	15144
.534	d?	14216	.467	d	15150
161.675	c	14225	.677	d	15162
162.033	d	14245	177.799	d	15160
.104	d	14250	178.131	d?	15189
162.476	b	14271	.269	d	15198
163.155	b	14312	.498	d	15211
163.520	d	14333	.597	d	15217
164.095	c	14366	.715	d	15224
.433	d	14385	.775	d	15228
.515	d?	14390	.883	d	15234
.755	d	14404	178.980	d	15240
164.973	d?	14416	179.115	d	15248
165.479	b	14447	.201	d	15253
166.341	b	14495	.314	d?	15260
167.125	c	14542	.424	d?	15267
167.435	d	14560	.588	d	15276
168.031	c	14594	179.866	d	15293
.119	d	14599	180.145	d?	15310
.495	c	14621	.269	d	15317
168.933	d	14646	.389	d?	15324
169.060	b	14655	.766	d?	15347
.765	b	14696	180.902	d	15356

TABLE 3.—*Lines and Bands in the Infra-Red Solar Spectrum.*—Continued

Linear measures	Intensity	Wave-length	Linear measures	Intensity	Wave-length
+181.173	d	15371	+193.742	d	16122
.615	d	15397	193.897	d	16132
.690	d?	15402	194.049	d	16141
.824	d	15410	.245	d	16154
181.930	d	15416	.431	d	16165
182.058	d	15424	.507	d	16170
.266	d	15436	.682	d?	16180
.481	d	15447	.854	d	16190
182.959	d	15478	194.981	d	16198
183.182	d	15491	195.111	d	16206
.297	d	15499	.398	d	16223
.478	d	15509	.557	d	16232
.782	d?	15527	.789	d	16246
183.881	d	15533	195.958	d?	16256
184.429	d	15566	196.103	d?	16265
184.707	d	15583	.207	d	16272
185.016	d	15601	196.697	d	16301
.644	d	15639	197.052	d	16322
185.745	d	15644	.234	d?	16333
186.197	d	15671	.503	d	16350
.353	d	15680	.640	d	16358
.493	d	15689	.770	d	16362
186.705	d	15702	.900	d?	16373
187.001	d	15719	197.994	d	16379
.365	c	15740	198.157	d?	16390
187.759	d	15764	.312	d	16399
188.458	d	15806	.449	d?	16407
.661	d	15818	.825	d?	16430
188.908	d	15833	198.964	d	16438
189.338	c	15859	199.344	d?	16462
190.081	d	15904	.544	d	16473
.479	c	15927	.660	d	16481
190.754	d	15944	199.923	d?	16497
191.205	d	15971	200.085	d	16507
.313	d	15977	.235	d	16516
.551	d	15991	.365	d	16524
.694	d	16000	.521	d	16534
191.889	d	16012	.678	d	16543
192.065	d	16022	200.950	d	16560
.297	d	16037	201.054	d?	16566
.563	d	16052	.282	d	16580
192.713	d	16062	.695	d	16605
193.051	d	16082	201.778	d	16610
.148	d?	16088	202.134	d	16632
.278	d	16095	.244	d	16651
.501	d?	16108	202.775	d	16672

TABLE 3.—*Lines and Bands in the Infra-Red Solar Spectrum.*—Continued

Linear measures	Intensity	Wave-length	Linear measures	Intensity	Wave-length
+203.065	d	16689	+214.210	d	17380
.225	d	16699	214.591	c	17404
203.421	d	16711	215.326	c	17449
204.042	d	16748	215.855	d?	17482
.365	d	16768	216.083	d	17495
.417	d?	16772	.207	d	17504
.550	d?	16780	.322	d?	17510
204.851	d	16798	.754	d	17537
205.087	d	16812	.835	d	17542
.443	d	16834	216.959	d	17550
.517	d	16839	217.123	d	17560
.678	d	16848	217.662	c	17593
.789	d	16858	218.336	c	17634
205.082	d	16865	218.958	d	17673
206.140	d	16877	219.168	d	17686
206.630	d	16907	.288	d	17692
207.242	d	16944	.455	d	17704
.320	d	16950	219.697	c	17718
.630	d	16969	220.119	d	17744
207.863	d	16984	.724	c	17782
208.031	d?	16994	.857	d?	17790
.245	d	17006	220.988	d	17797
.492	d	17022	221.105	d	17805
208.960	d	17051	.743	d	17843
209.367	d	17077	221.933	d	17855
.490	d	17084	222.043	d	17862
209.758	d?	17102	222.538	d	17892
210.031	d	17119	223.297	d	17937
.544	d	17150	223.529	d	17952
.846	d	17168	224.172	c	17992
210.965	d	17176	.692	d	18024
211.706	d	17223	224.994	d	18042
211.822	d	17229	225.155	d	18052
212.284	c	17258	.742	d	18088
.889	d	17299	225.917	d	18100
212.981	d	17304	226.318	d	18124
213.537	d	17338	.469	d	18132
.668	d	17347	226.816	d	18154
.765	d	17353	227.152	d	18174
213.910	d?	17362	227.486	d	18194

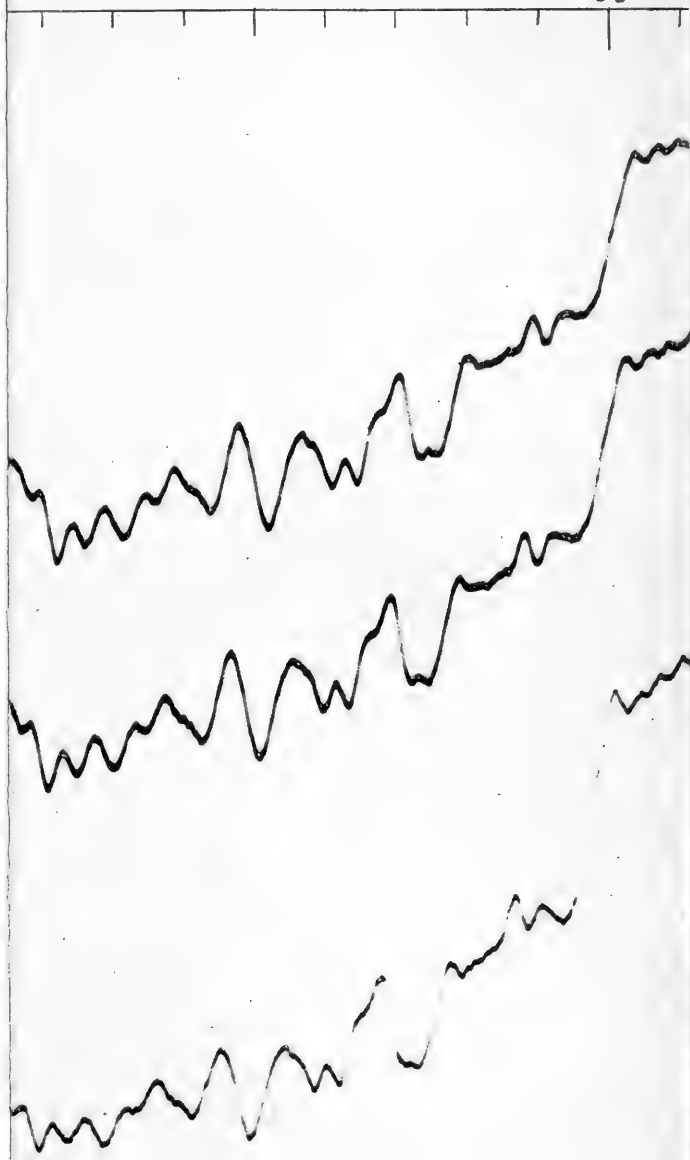

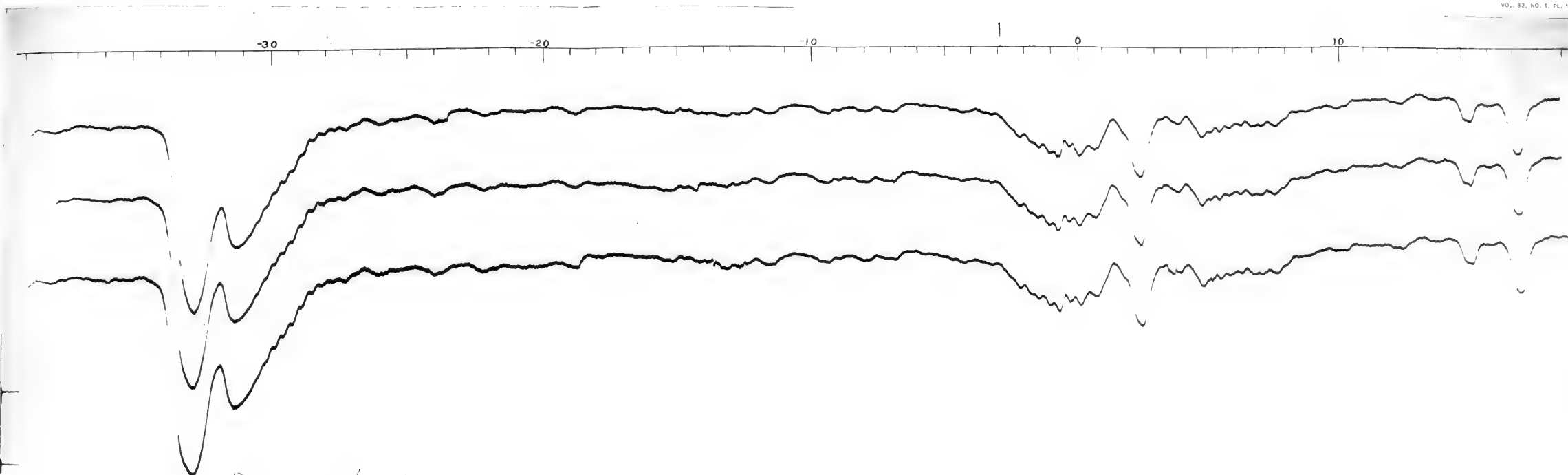

Sept 4 - 11 25

PHOTOGRAHS OF THE INTER-REGIOLAR SOLAR SPECTRUM
 The A-region. Wave-lengths 7000-8500 Angstroms

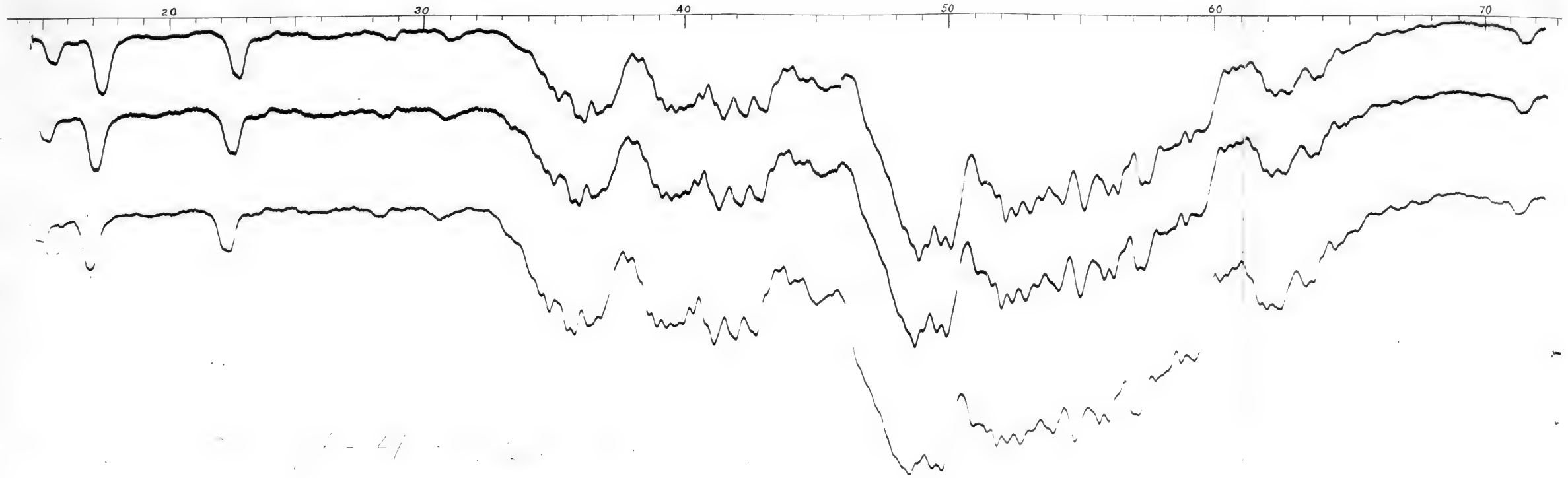

1-4f

FIGURE 1. — RECORDS OF THE T. C. P. ...

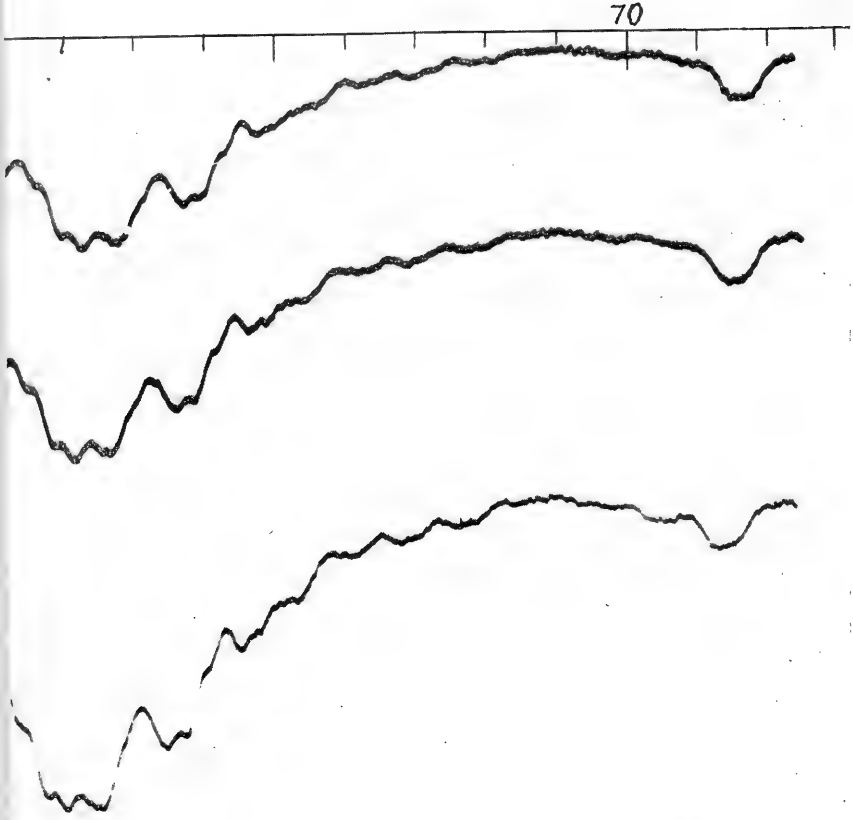

160

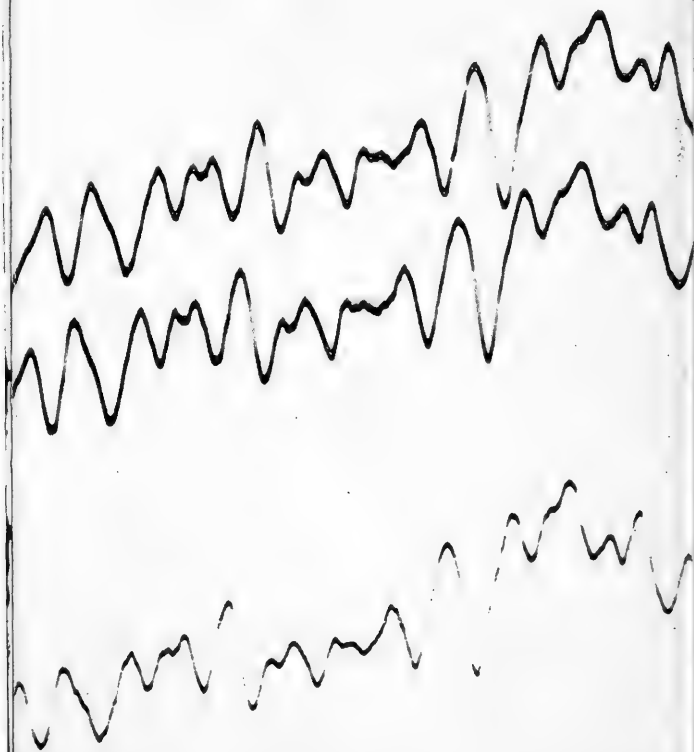

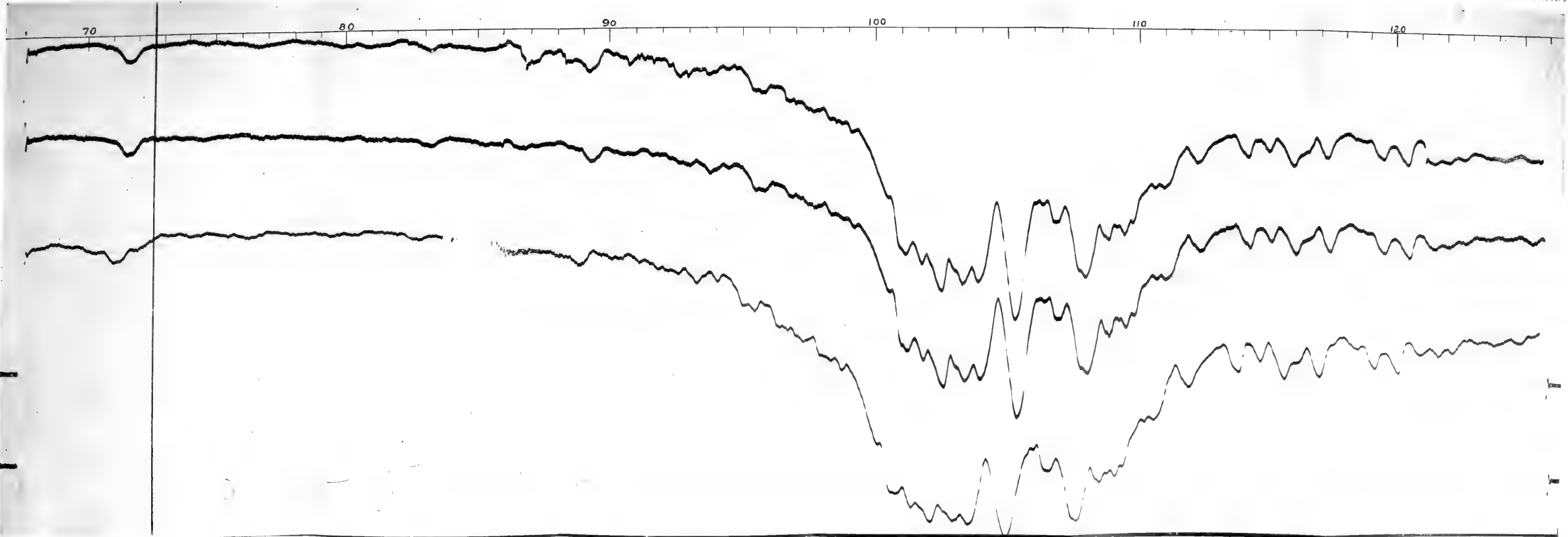

Electron spectra of the INDIAN P... AND S...
The 12200 Angstroms

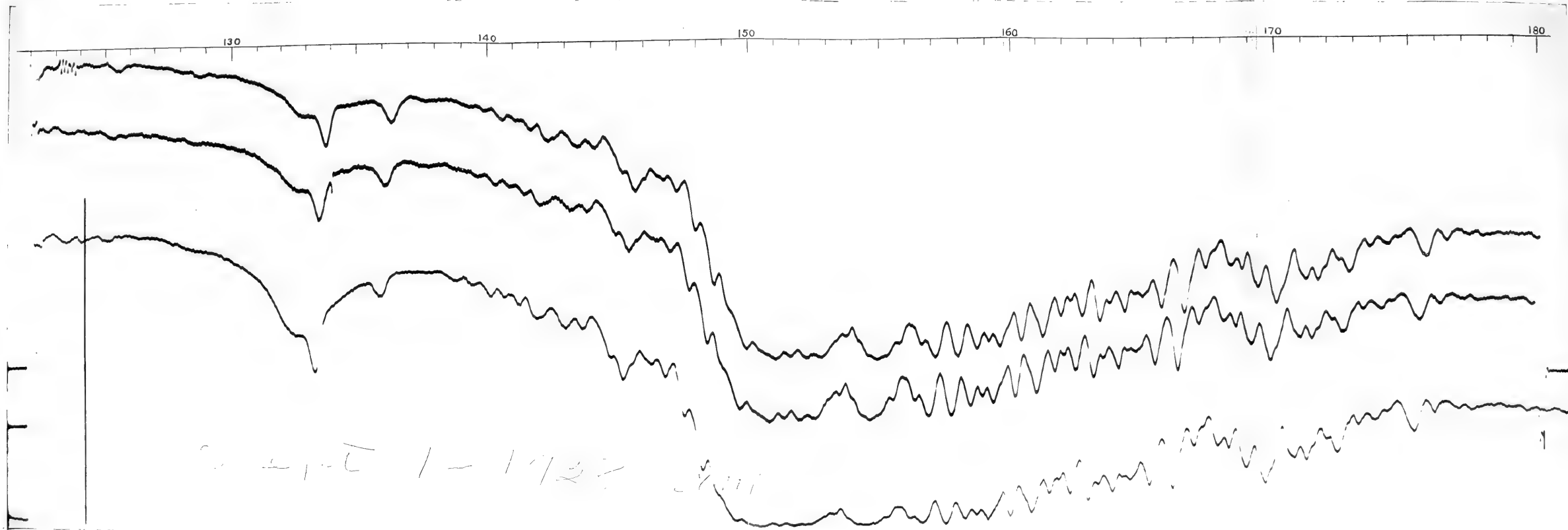

PHOTOGRAPHS OF THE ISAACS-RICE DISMATIC SOLAR SPECTRUM
The γ region, Wave lengths 1200 to 1800 Angstroms

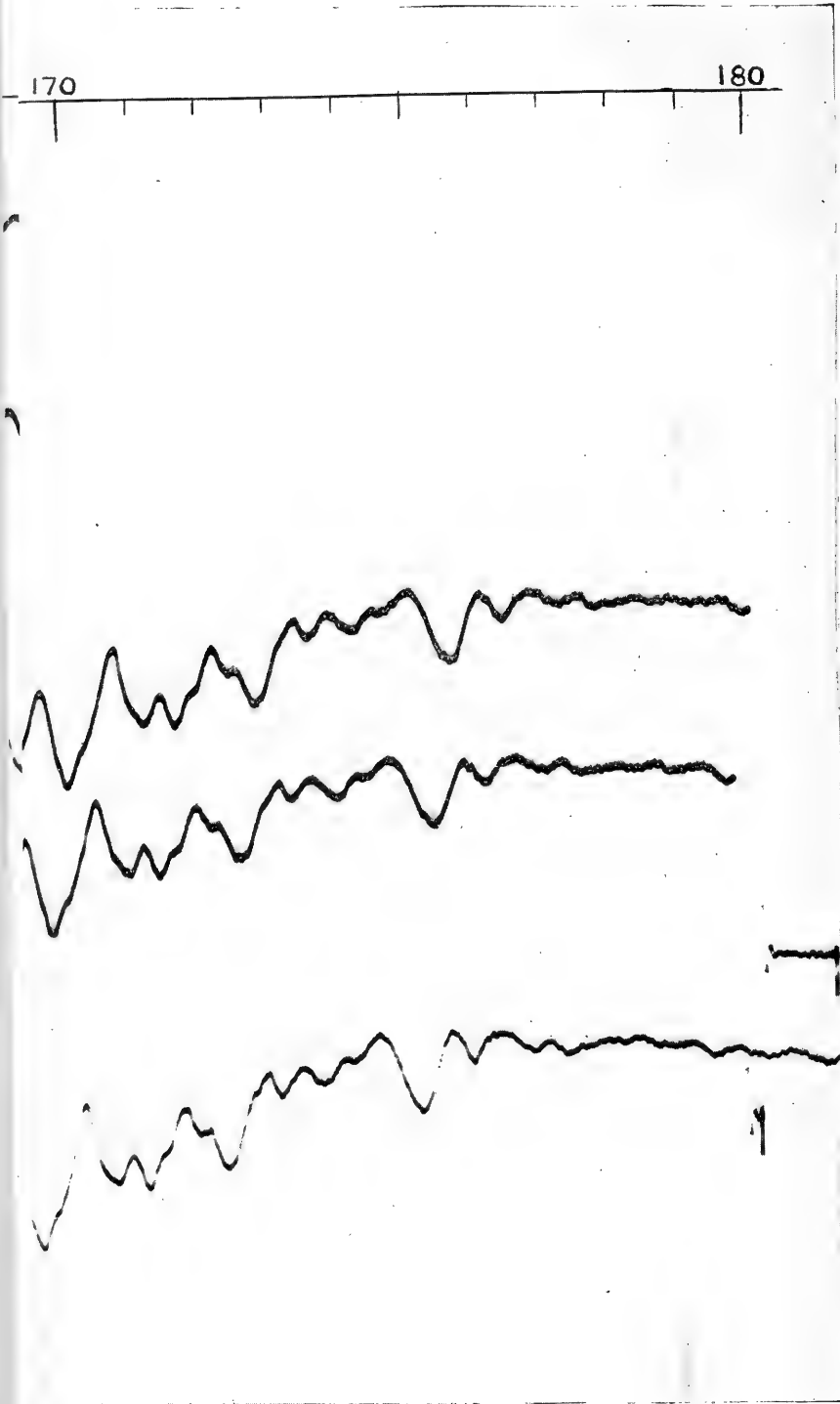

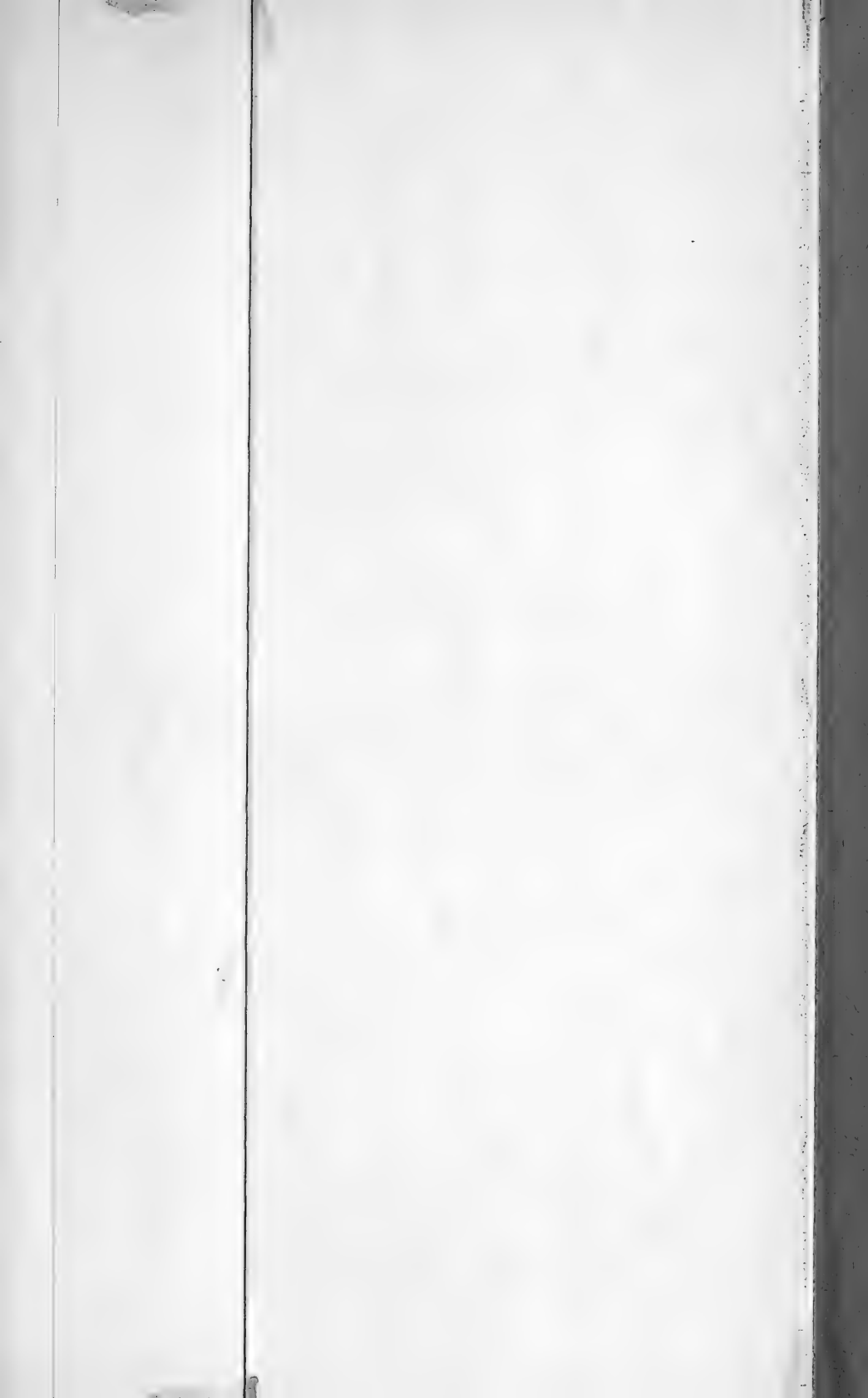

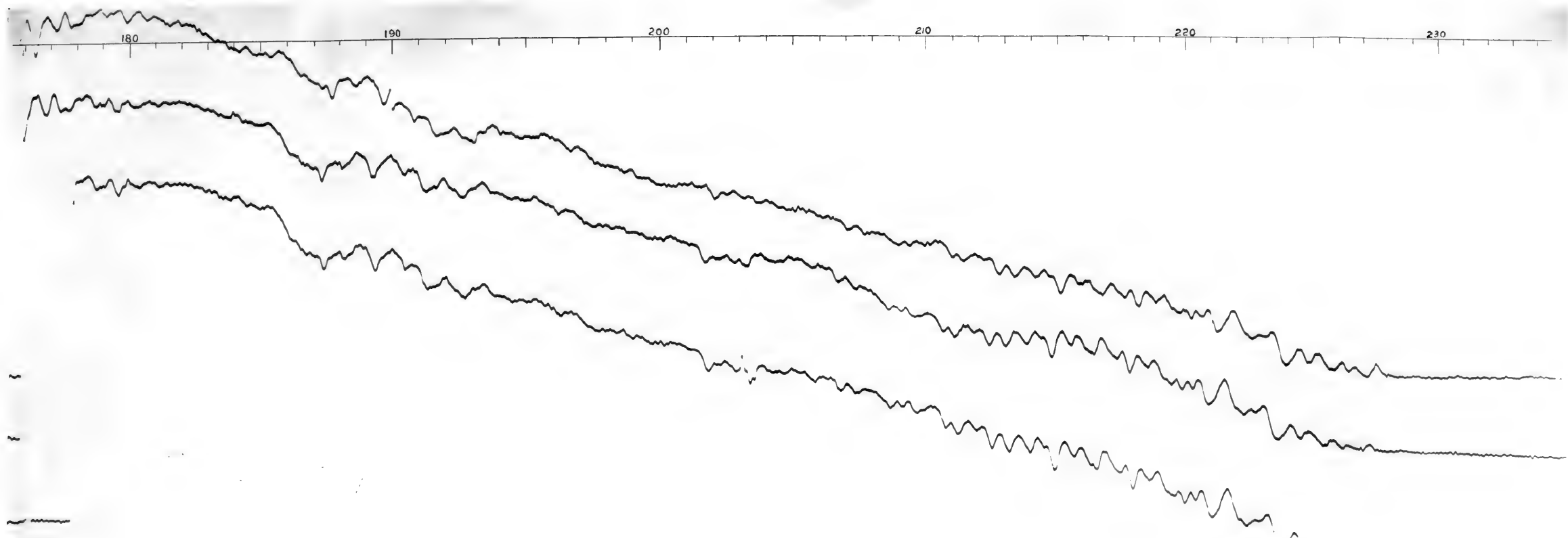

FIG. 1. SOLAR SPECTRUM
Wavelengths in Angstroms

SMITHSONIAN MISCELLANEOUS COLLECTIONS
VOLUME 82, NUMBER 2

THE THORACIC MECHANISM OF A
GRASSHOPPER, AND ITS
ANTECEDENTS

BY
R. E. SNODGRASS
Bureau of Entomology,
U. S. Department of Agriculture



(PUBLICATION 3027)

CITY OF WASHINGTON
PUBLISHED BY THE SMITHSONIAN INSTITUTION
DECEMBER 31, 1929

SMITHSONIAN MISCELLANEOUS COLLECTIONS
VOLUME 82, NUMBER 2

THE THORACIC MECHANISM OF A
GRASSHOPPER, AND ITS
ANTECEDENTS

BY
R. E. SNODGRASS
Bureau of Entomology,
U. S. Department of Agriculture



(PUBLICATION 3027)

CITY OF WASHINGTON
PUBLISHED BY THE SMITHSONIAN INSTITUTION
DECEMBER 31, 1929

The Lord Baltimore Press
BALTIMORE, MD., U. S. A.

THE THORACIC MECHANISM OF A GRASSHOPPER, AND ITS ANTECEDENTS

BY R. E. SNODGRASS
BUREAU OF ENTOMOLOGY
U. S. Department of Agriculture

CONTENTS

	PAGE
Introduction	1
I. General discussion	3
The thoracic terga.....	5
The thoracic pleura.....	10
The thoracic sterna.....	21
II. The thoracic skeleton of <i>Dissosteira</i>	33
The cervical sclerites.....	33
The prothorax	34
The pterothorax	37
III. The thoracic muscles of <i>Dissosteira</i>	51
Muscles of the neck and prothorax.....	53
Muscles of the pterothorax.....	59
The mesothoracic muscles.....	60
The metathoracic muscles.....	66
IV. The legs and their muscles.....	72
Structure of the legs.....	73
Muscles of the legs.....	78
V. The wings and their mechanism.....	84
Structure of the wings.....	84
The wing mechanism.....	92
VI. The spiracles	99
Abbreviations used on the figures.....	108
References	109

INTRODUCTION

The principal elements in the motor mechanisms of arthropods are the muscles and the body wall, though the blood often plays an important secondary part as a hydraulic medium. All movements, however, come primarily from muscle contractions. A contracted muscle, when it relaxes, must be actively extended before it can operate again, and therefore muscles generally occur in antagonistic sets. But the muscles of insects are not necessarily opposed by other muscles; the counter force may be produced by the elasticity of the part of the body wall on which a muscle is attached. For this reason it is often

found in studying the anatomy of insects that a muscle has no antagonist. Moreover, while most insect muscles are *muscles of motion*, some are *tensors* inasmuch as they appear merely to maintain rigidity between parts that are subject to strain from other muscles.

The ectodermal cell layer of the body wall, or epidermis (commonly known as the "hypodermis"), is covered externally by a cuticula of which the general constituent is probably chitin, but in which other substances are deposited to form hardened areas called *sclerites*. The nature of the sclerotizing substances in insects is not yet known, but it appears to be definitely established that the sclerotic areas of the cuticula are not places where the chitin is thicker or denser (Campbell, 1929). Sclerites are secondary formations in the body wall, and it would be both interesting and important to know the physiological processes that produce them, for we should then be better able to evaluate sclerites as morphological units.

The major plates of the body-wall of an insect are very definite structures that are consistently reproduced by the deposit of sclerotizing substances throughout the whole series of insect forms, and some of them appear to be homologous with corresponding plates in other arthropod groups. On the other hand, all parts of the insect skeleton called "sclerites" in descriptive entomology are not of equal value. Many of them are simply areas of larger plates which have become secondarily demarked by lines of inflection in the cuticula that have formed internal strengthening ridges. The so-called sclerites in such cases are in themselves of no significance. The important morphological features are the endoskeletal structures; these are the rafters, the joists, and the upright supports that give strength to the edifice and enable it to withstand the strain of the muscles pulling on its walls.

It frequently happens, however, that a primary region of sclerotization becomes broken up by a discontinuity in the hardening substance of the cuticula, thus producing true secondary sclerites. The intervening "membrane" may take the form of a narrow line of flexibility ("suture"), or it may cover a large part of the original hard surface and reduce the primary sclerotization to two or more widely separated plates. Or again, an original sclerotic area may be contracted to a relatively small sclerite, or it may be obliterated. It then becomes a question, if the primary plate has been given a name, whether we are to apply this name to the area originally occupied by the plate, or restrict it to the sclerotic remnants or remnant. It is the usual practice to apply the name only to the sclerite, whatever its extent, and, if the sclerite is obliterated, to say that the part in question is obsolete

or lost. This usage has convenience for descriptive purposes, but it is likely to confuse our morphological conceptions, since an anatomical part is the same thing regardless of the nature of its surface covering.

I. GENERAL DISCUSSION

If all that has been written about the thorax of insects were true, or could be made to fit with our present knowledge of insect struc-

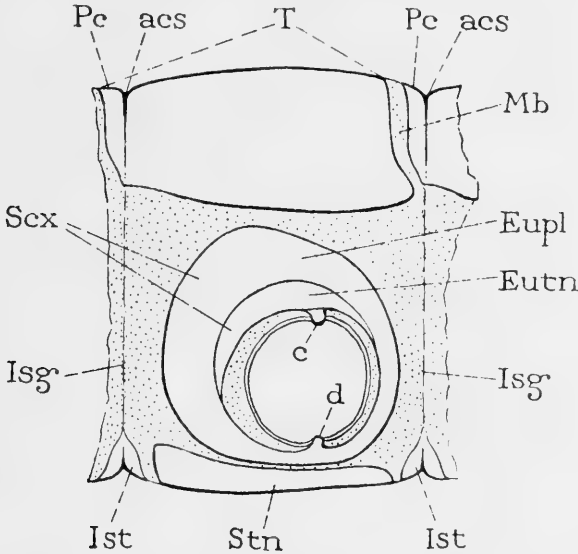

FIG. 1.—Diagram of the theoretical structure of a primitive thoracic segment.

The tergum (*T*) includes the segmental and preceding intersegmental sclerotization of the dorsum; the ventral sclerotization consists of a primary intersegmental sternal plate (*Stn*) and intersegmental intersternites (*Ist*); the pleural area is occupied by a basal subsegment of the leg, the subcoxa (*Scx*), divided dorsally into a eupleuron (*Eupl*) and a eutrochantin (*Eutn*).

acs, antecostal suture; *c, d*, dorsal and ventral subcoxo-coxal articulations; *Eupl*, eupleuron; *Eutn*, eutrochantin; *Isg*, primary intersegmental line; *Ist*, intersternite; *Mb*, secondary intersegmental membrane; *Pc*, precosta; *Scx*, subcoxa; *Stn*, primary sternite; *T*, tergum.

ture, there would be little need of prefacing a special description of the thoracic skeleton and musculature of the grasshopper with a general discussion. Science, however, is not a collection of facts but a concept in which to hold the facts. As our collections of facts become larger, our concepts must be altered and enlarged from time to time. Moreover, we often think that we have nicely fitted a fact into a mental container, only to discover presently that it does not fit at all, or that an important part of the fact has been left out. There is noth-

ing to do then but to discard the container or to remodel it as best we can to make it serve its intended purpose. The writer, therefore, finds it necessary to enlarge some general conceptions previously expressed concerning the nature of the thoracic mechanisms and their apparent evolutions from simpler origins, in order to accommodate new observations that must be admitted.

The primary intersegmental infoldings of the integument of arthropods are the original lines of attachment of the longitudinal muscles, and in most cases the principle longitudinal muscles are still attached on them. When the cuticula becomes sclerotized, the intersegmental inflections are usually converted into apodemal ridges, and a primary segmental plate is laid down in the dorsum and generally in the venter of each segment. In some cases the intersegmental sclerotizations take the form of narrow intersegmental sclerites alternating with the segmental plates. This condition is found more frequently in the ventral than in the dorsal region, though it exists dorsally in some insect larvae.

The typical sclerotization of the dorsum of any segment in an adult insect consists of a plate (fig. 1, *T*) which covers most of the dorsal area of the segment, and which is continuous anteriorly with the intersegmental sclerotization bearing the intersegmental fold or ridge (fig. 2 A, *Ac*). The definitive tergum, therefore, occupies a primary segmental region and the preceding intersegmental region; it bears anteriorly a submarginal, intersegmental ridge, or *antecosta* (fig. 2 A, *Ac*), marked externally by the *antecostal suture* (figs. 1, 2 A, *acs*), and it terminates anterior to this ridge and its suture in a narrow lip, or *precosta* (*Pc*).

The ventral sclerotization of the segment may take the same form as the dorsal sclerotization, as in the abdomen of most insects, where the definitive terga and sterna duplicate each other in structure (fig. 3). The functional intersegmental rings of the body in such cases are the posterior, non-sclerotized areas of the primary segments, and the definitive segmentation is clearly a *secondary* one. The sternal sclerotization, however, may preserve a more primitive condition, as in some of the chilopods (figs. 8, 15) and in the thorax of certain insects, where the primary sternal and intersternal plates remain independent (figs. 1, 2 A, *Stn*, *Ist*).

In the membranous areas of the lateral, or pleural, walls of the segment are implanted the bases of the segmental appendages. In most arthropods the basis of the appendage (coxopodite) is preserved as an integral limb segment. In the body segments of the chilopods, the thoracic segments of insects, and the ambulatory segments of decapod

crustaceans, however, it appears that the limb basis has become subdivided into a coxa and a subcoxa, and that the latter has been incorporated into the wall of the body segment (fig. 1, *Scx*), where it either forms a "pleuron" supporting the free part of the limb, or also the base of the wing, or it becomes degenerate and reduced to small sclerites having little significance or function.

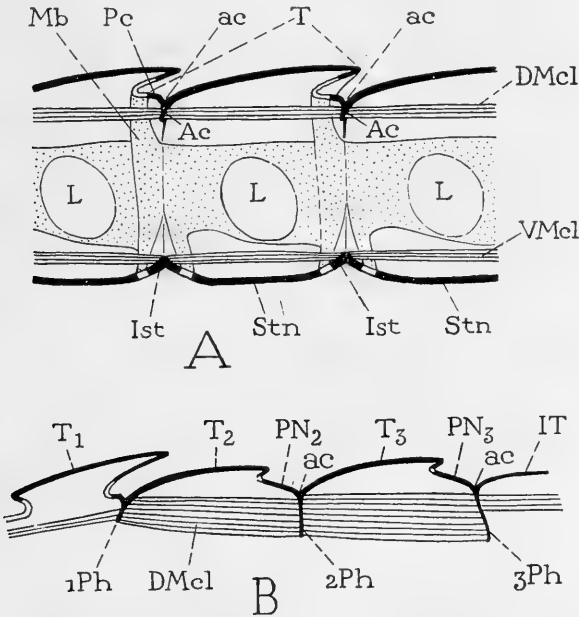

FIG. 2.—Diagram showing the relation of the longitudinal muscles to the tergal and sternal sclerites of the body.

A, three successive segments in which the terga include the primary intersegmental regions bearing the intersegmental ridges (*Ac*, *Ac*), but in which the primary sternites (*Stn*) and intersternites (*Ist*) are distinct. B, the tergal region of the thorax in an insect in which the precostae (*A*, *Pc*) are enlarged to form postnotal plates (*PN*).

Ac, antecosta; *ac*, antecostal suture; *DMcl*, dorsal longitudinal muscles; *Ist*, intersternites; *IT*, first abdominal tergum; *L*, positions of leg bases; *Mb*, secondary intersegmental membrane; *Pc*, precosta; *1Ph*, *2Ph*, *3Ph*, the three thoracic phragmata; *PN*, postnotal plates; *Stn*, primary sternite; *VMcl*, ventral longitudinal muscles.

THE THORACIC TERGA

The dorsal plates of the insect thorax never retain in all three segments the simple structure of the definitive abdominal terga, and in the Pterygota the mesothoracic and metathoracic terga are modified in various ways correlated with the development of the wings.

The prothoracic tergum (fig. 4, *T*₁) always lacks an antecosta, and the principal longitudinal muscles (*DMcl*) that extend forward from

the anterior phragma of the mesotergum (*IPh*) run continuously through the prothorax and the neck (*Cv*) to be inserted on the post-occipital ridge of the head (*PoR*). This ridge, as the writer has elsewhere contended (1928), is evidently the intersegmental fold between the first and second maxillary segments. The neck, therefore, must be derived from the posterior part of the second maxillary, or labial, segment and from the anterior part of the prothorax, there being no satisfactory evidence of the existence of a separate neck segment. If so, the first postcephalic intersegmental line, or that between the labial and prothoracic segments (fig. 4, *ISg*), must be contained in the membranized cervical region, where the protergal costa is lost. By the suppression of the primary intersegmental line between the head and

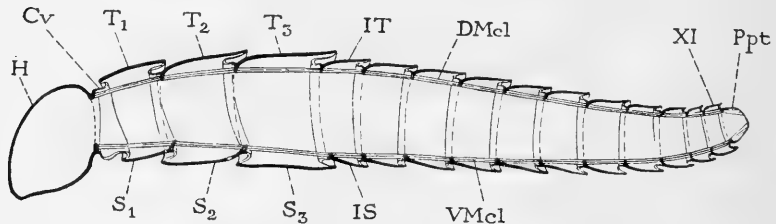

FIG. 3.—Diagram of the body segmentation of an insect, and the primitive relation of the longitudinal muscles to the definitive segmental plates of the body and to the head; showing the reversed overlapping of the sterna between the thoracic and abdominal regions.

Cv, cervix; *DMcl*, dorsal longitudinal muscles; *H*, head; *IS*, first abdominal sternum; *IT*, first abdominal tergum; *Ppt*, periproct, or terminal segment; *S₁*, *S₂*, *S₃*, thoracic sterna; *T₁*, *T₂*, *T₃*, thoracic terga; *VMcl*, ventral longitudinal muscles; *XI*, eleventh abdominal segment.

the thorax, giving continuity to the muscle fibers of two segments, the head acquires a much greater freedom of motion than it could have if it were attached to the body by an ordinary intersegmental membranous ring.

The loss of the protergal antecosta deprives the prothorax of the possibility of being a wing-moving segment, and there is nothing to suggest that the prothorax ever possessed movable organs of flight. The reduction of the primitive gnathal region of the body and its condensation into the head capsule, accompanying the transfer of the gnathal appendages to the head, shifted the center of gravity posteriorly in the insect's body, and the paranotal lobes of the second and third thoracic segments were developed into movable wings, leaving the prothorax as a free segment between the head and the pterothorax.

The most conspicuous modifications of the thoracic terga occur in the mesothorax and the metathorax of winged insects, where clearly

they are correlated with the part the terga of these segments play in the mechanism of flight. In the Apterygota the corresponding terga are simple plates showing none of the special characters of the wing-bearing plates of pterygote insects.

The first important tergal modifications connected with the development of the paranotal lobes into movable organs of flight pertain to the ridges upon which the dorsal muscles of the mesothorax and metathorax have their attachments. These ridges, which are the antecosta of the mesotergum, the antecosta of the metatergum, and the antecosta of the first abdominal tergum, bear each a pair of apodemal plates, varying in size, that project into the body cavity to give increased surfaces of attachment for the greatly enlarged dorsal muscles (fig. 2 B, *DMcl*) which have become depressors of the wings. The antecostal apodemes, primarily intersegmental, are the *thoracic phragmata* (*1Ph*, *2Ph*, *3Ph*).

The lengthwise pull of the dorsal muscles on the phragmata demands sclerotic continuity in the dorsum, since the function of these muscles as depressors of the wings depends on their ability to produce a dorsal curvature in the terga on the relaxation of the antagonistic tergo-sternal muscles. To insure action by the dorsal muscles the intersegmental membranes between the mesotergum and metatergum and between the latter and the first abdominal tergum must be practically eliminated, and their suppression has been accomplished either by a fusion of the succeeding terga, or by a forward extension of the precostal lips of the terga into the territory of the membranes. In the second case, the precostae become postnotal plates (fig. 2 B, *PN₂*, *PN₃*), often of large size, lying behind the true tergal plates of the mesothorax and metathorax (*T₂*, *T₃*), where they appear to be parts of these segments, to which, in fact, they do belong since they lie anterior to the antecostal sutures (*ac*, *ac*) which are the primary intersegmental lines.

In those insects in which the fore wings are the principal organs of flight, the second thoracic phragma becomes partially or wholly detached from the metatergum, and both the phragma and the postnotal plate establish a close association with the mesotergum, while the extremities of the postnotum commonly unite for security with the posterior dorsal angles of the mesothoracic epimera. In those insects in which the hind wings have taken on the chief function of flight, the middle phragma always remains attached to the metatergum, and the precosta is not enlarged. The third phragma may preserve its connection with the first abdominal tergum, as it does in the Orthoptera (fig. 25, *PN₃*), but in most cases it becomes more or less separated

from the abdomen and, together with the precosta, becomes transferred to the metathorax, where the precosta forms a distinct post-notal plate united laterally with the epimera. Thus it is usually found that the segment which assumes the leading rôle in the flight mechanism is provided with a phragma at both its anterior and its posterior end.

Since the tergal plates of the mesothorax and metathorax are the intermediary elements in the wing mechanism between the dorsal mus-

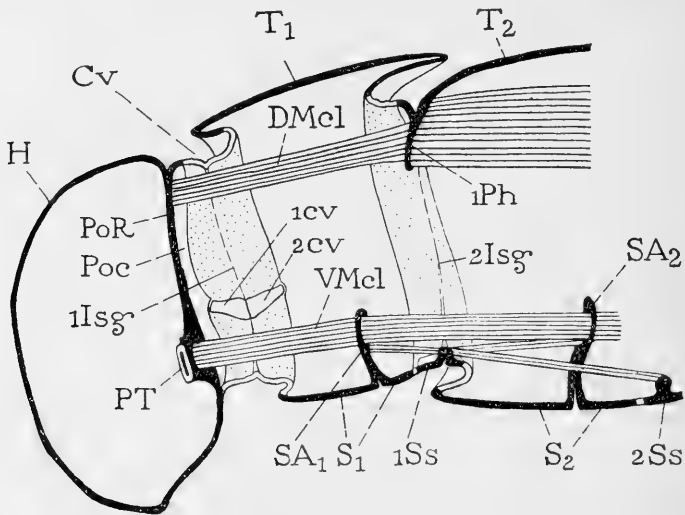

FIG. 4.—Diagram of the typical relation of the head and the prothorax in pterygote insects.

Cv, cervix; *1cv*, *2cv*, first and second lateral cervical sclerites; *DMcl*, dorsal longitudinal muscles; *H*, head; *1Isγ*, *2Isγ*, first and second primary intersegmental lines; *1Ph*, first thoracic phragma; *Poc*, postocciput; *PoR*, postoccipital ridge; *PT*, posterior arm of tentorium; *S₁*, *S₂*, thoracic sternae; *SA*, sternal apophyses; *Ss*, spinisternites; *T₁*, *T₂*, thoracic terga; *VMcl*, ventral longitudinal muscles.

cles of the segments and the bases of the wings themselves, it is clear that a proper execution of their function depends upon the ability of each to respond to the muscle tension at its ends with a dorsal curvature reaching its maximum at the transverse line between the wing bases. For this reason, as Weber (1924, 1925) has pointed out, the terga of the wing segments are provided with internal ridges so arranged that the force of the muscles will not merely deflect the anterior and posterior parts of the plates, but will be distributed gradually toward the middle from each extremity, and thus produce an even dorsal flexion with its apex between the fulcra of the wings.

The posterior gradient of an alar tergum usually has the form of a *V-shaped ridge* with the apex directed forward and the arms diverging toward the posterior lateral angles of the tergum (fig. 5 B, *VR*). The anterior gradient is less commonly developed than the posterior one, but, when present, it generally consists of two ridges, the *parapsidal ridges* (fig. 5 B, *PaR*), converging from the anterior margin of the tergum toward the middle, where they usually terminate without meeting. In some insects the anterior part of the tergum is strengthened by a transverse *prescutal ridge* (*PR*). In addition to these more general endoskeletal structures of the tergum, there may be present also

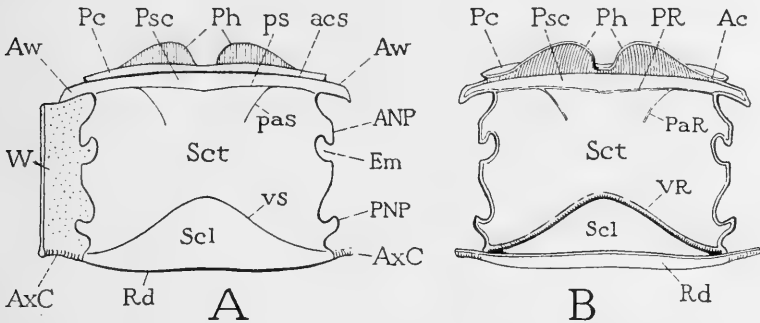

FIG. 5.—Structure of a wing-bearing tergum, not including a postnotum, diagrammatic.

A, dorsal. B, ventral. *Ac*, antecosta; *acs*, antecostal suture; *ANP*, anterior notal wing process; *AxC*, axillary cord; *Aw*, prealar process of tergum; *Em*, lateral emargination of tergum; *PaR*, parapsidal ridge; *pas*, parapsidal suture; *Pc*, precosta; *Ph*, phragma; *PNP*, posterior notal wing process; *PR*, prescutal ridge; *ps*, parapsidal suture; *Psc*, prescutum; *Rd*, posterior fold, or reduplication, of tergum; *Scl*, scutellum; *Sct*, scutum; *VR*, V-shaped ridge; *vs*, suture of the V-ridge, or scuto-scutellar suture; *W*, base of wing.

a variety of accessory ridges, or even lines of flexibility in the tergal cuticula; but all such features are highly variable in different groups of insects, and homologies can be traced between them only within limited groups.

On the outer surface of the tergum the positions of the endoskeletal ridges are marked by the lines, or "sutures," of their inflection (fig. 5 A, *ps*, *pas*, *vs*). The tergal areas defined in this manner by the more constant of the inner structures can be identified as homologous in different insects, and some of them have been given distinctive names used in descriptive works (fig. 5 A, *Psc*, *Sct*, *Scl*). It is quite impossible, however, to follow the lesser modifications consistently through the various orders of winged insects, and attempts to do so have only led to confusion. In any case, it must be recognized that

the external "divisions" of the wing-bearing terga have no significance in themselves; they are merely incidental to the formation of the internal ridges by cuticular inflections, the ridges being the true functional structures adapting the tergum to its part in the flight mechanism.

THE THORACIC PLEURA

The lateral walls of arthropod segments, or the areas along the sides of the body between the terga and the sterna, when dorsal and ventral plates are present, may properly be designated the *pleural regions*. The pleural areas of the segments are primarily membranous, and

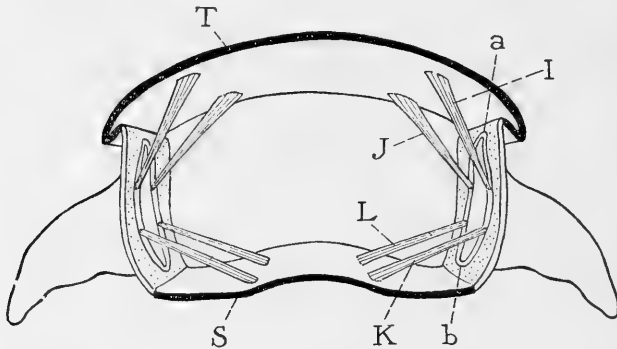

FIG. 6.—Diagram of the theoretical elementary musculature of the segmental appendages.

a-b, primitive dorsoventral axis of the appendage; *I*, tergal promotor muscle; *J*, tergal remotor; *K*, sternal promotor; *L*, sternal remotor; *T*, tergum; *S*, sternum.

within them are implanted the bases of the limbs (fig. 6). In some arthropods, as in many of the Arachnida, each limb basis occupies almost the entire space between the tergum and the sternum, and may be articulated to one or the other of these plates, or to both of them. In most cases, however, a membranous area partially or entirely surrounds the limb base. In this area there are sometimes developed true pleural sclerites, as in the chilopod family Geophilidae, where there is a series of lateral plates of the body wall lying between the terga and the leg bases (fig. 8 A, *pl*), or in the larvae of some insects where similar plates occur on the sides of the abdomen. In many arthropods, however, there are plates in the definitive lateral walls of certain segments that appear to have been derived from the bases of the appendages. While such sclerotizations are, therefore, not true pleural products, they are generally termed *pleurites*, and those of each side of each segment constitute collectively the so-called *pleuron* of the segment.

It is claimed by Becker (1923, 1924) that the pleurites, the coxae, and the trochanters in the Chilopoda are formed, during the development of the individual, from numerous sclerotizations in the lateral

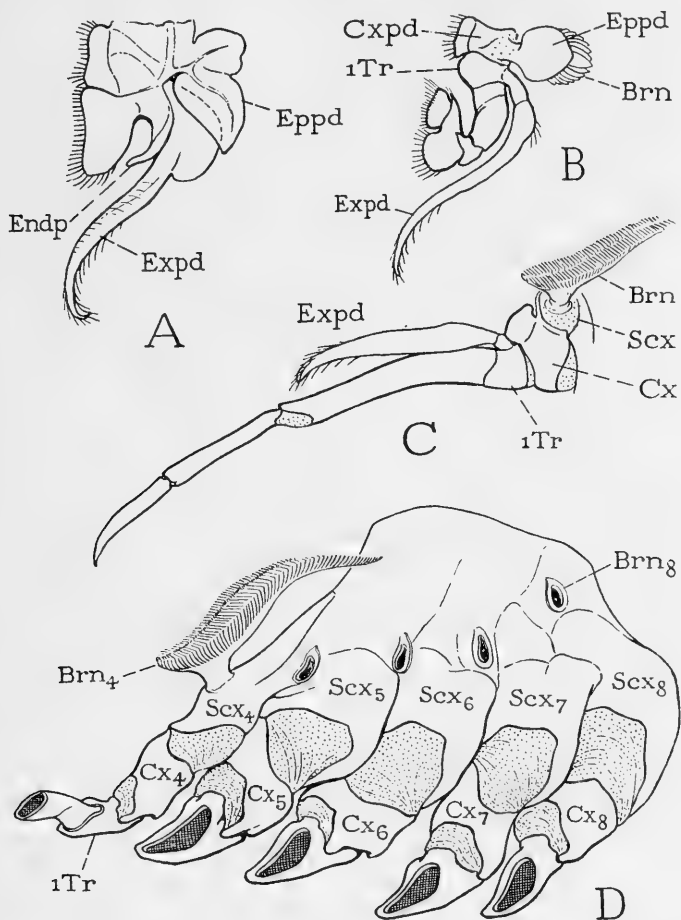

FIG. 7.—Maxillipeds and pleuron of a decapod crustacean, *Macrobrachium jamaicensis*.

A, first maxilliped, left, posterior. B, second maxilliped, right, anterior. C, third maxilliped, left, posterior. D, left pleuron, or inner wall of branchial chamber.

Brn, branchia, gill; Cx, coxa; Cxpd, coxopodite; Endp, endopodite; Eppd, epipodite; Expd, exopodite; Scx, subcoxa; iTr, first trochanter.

walls of the body segments, which unite to form the definitive leg bases and the pleural sclerites of the adult. Though the apparent facts in the development of the chilopods may be as Becker describes them, it is difficult to see how they can be interpreted literally as repre-

senting the phylogenetic origin of the definitive pleural plates and the leg bases. It would seem more probable that they are ontogenetic phenomena only, and that Becker's observations really show simply that the pleurites and the bases of the legs have a common origin.

In the decapod crustaceans the inner walls of the gill chambers, which are covered externally by lateral folds of the carapace, are formed of large cuticular plates bearing the gills (fig. 7 D). Each plate, or pleuron, shows subdivisions (Scx_4 - Scx_8) corresponding with the body segments of the ambulatory legs, and each subdivision bears a gill (Brn_4 - Brn_8). In the second maxilliped (B) the homologue of the gill is borne on an epipodite ($Eppd$) which is distinctly carried by

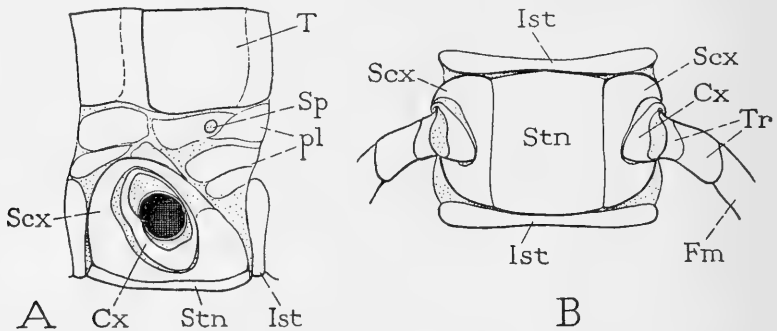

FIG. 8.—A body segment of *Strigamia bothriopus* (Chilopoda, Geophilidae).

A, lateral view, with leg removed beyond the coxa. B, ventral view, including bases of legs. *Cx*, coxa; *Ist*, intersternite; *pl*, pleurites between the tergum and the subcoxa; *Scx*, subcoxa; *Sp*, spiracle; *Stn*, primary sternite; *T*, tergum; *Tr*, trochanter.

the basal segment of the appendage, or coxopodite ($Cxpd$). In the third maxilliped (C), however, the gill arises from a subcoxal part of the limb basis (Scx). In the ambulatory region (D) the gills on the pleuron are successively more and more removed from the coxae. It thus becomes evident that the pleural wall of the branchial chamber in the decapod crustaceans has been formed from dorsal extensions of the subcoxal parts of the leg bases, and that the coxae have acquired special articulations with the subcoxae. In the majority of crustaceans the leg base is an undivided coxopodite.

In the Chilopoda there is a definitely circumscribed subcoxal area about the base of each leg, which may be continuously sclerotized, as in *Strigamia* (fig. 8 A, Scx), or which may contain one or more sclerites, as in *Lithobius* (fig. 9), *Scolopendra*, or *Scutigera* (fig. 10). The coxa is usually articulated to a sclerotized part of the subcoxa dorsally (fig. 10 A, *c*), or ventrally (figs. 9, 15, *d*); but since the axis

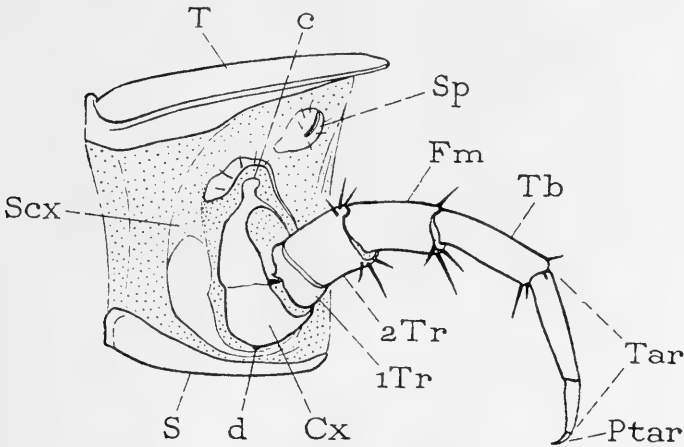

FIG. 9.—A body segment and leg of *Lithobius* (Chilopoda), left side.

c, dorsal articular point of coxa; *Cx*, coxa; *d*, ventral articulation of coxa with subcoxa; *Fm*, femur; *Ptar*, pretarsus; *S*, sternum; *Scx*, subcoxa; *Sp*, spiracle; *T*, tergum; *Tar*, tarsus; *Tb*, tibia; *1Tr*, first trochanter; *2Tr*, second trochanter.

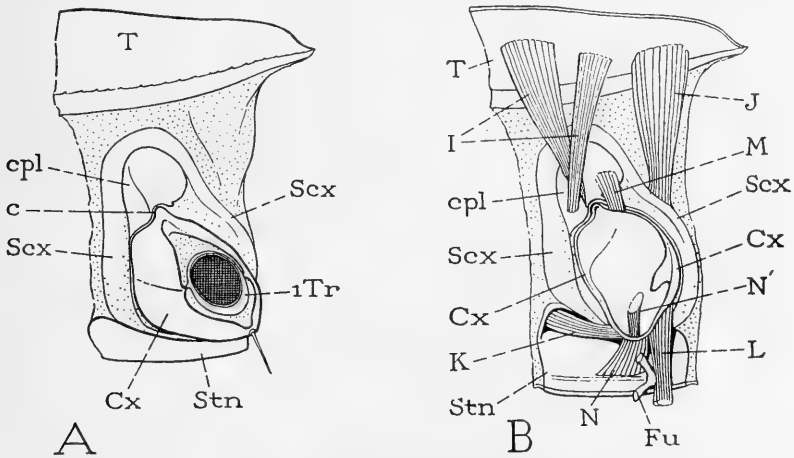

FIG. 10.—The leg base of *Scutigera forceps* (Chilopoda).

A, external view of base of a left leg and part of segment. B, internal view of base of right leg, showing muscles.

c, dorsal subcoxo-coxal articulation; *cpl*, supra-coxal plate of subcoxa; *Cx*, coxa; *Fu*, furca; *I*, tergal promotor muscles; *J*, tergal remotor muscle; *K*, sternal promotor; *L*, sternal remotor; *M*, subcoxo-coxal muscle; *N*, sternal adductor of coxa; *N'*, furcal adductor of coxa; *Scx*, subcoxa; *Stn*, segmental sternite; *T*, tergum; *1Tr*, first trochanter.

of movement in the coxa is always between its dorsal and ventral angles, we may presume that the chilopod coxa has had both a dorsal and a ventral articulation with the subcoxa (fig. 1, *c, d*), though one or the other, or both of the articulations (fig. 8) may lose the structure of definite articulating surfaces.

In the geophilid *Strigamia bothriopus* (fig. 8) the subcoxal area of the pleuron has the form of a complete basal limb segment (*A, Scx*), though its ventral margin is expanded and united with the sternum (*B*), and the coxa turns upon it by an obliquely vertical axis. In *Scolopendra*, *Lithobius* (fig. 9), and *Scutigera* (fig. 10) the subcoxal area is mostly membranous, but it contains one or more well-sclerotized plates.

The tergal muscles of the leg bases in the Chilopoda are inserted *not* on the coxae but *on the subcoxae*. In *Scutigera* the tergo-subcoxal muscles are strongly developed, those of each leg comprising a pair of anterior (promotor) muscles (fig. 10 B, *I*) inserted upon the dorsal plate (coxopleure, *cpl*) of the subcoxal region, and a single large posterior (remotor) muscle (*J*) inserted on the posterior dorsal margin of the subcoxal region.

The structure and musculature of the subcoxal region in the Chilopoda can leave little doubt that this area is the true base of the leg, which has become flattened into the lateral body wall, where, in most forms, its sclerotization has been more or less broken up and reduced. The sternal muscles of the leg base in the chilopods have gone over to the ventral rim of the coxa (fig. 10 B). They include an anterior (ventral promotor) muscle (*K*) and a posterior (ventral remotor) muscle (*L*). In *Scutigera* (fig. 10) the first of these muscles arises in the anterior lateral angle of the sternum, but in *Scolopendra* the corresponding muscle arises mesally on the anterior half of the sternum. The fibers of the posterior muscle in *Scutigera* (fig. 10 B, *L*) are mostly continuous from one coxa to the other, but a small anterior group on each side arises on the sternum at the base of the ligamentous endosternal furca (*Fu*). In *Scutigera* the coxa has no ventral articulation with the subcoxa or the sternum, but in those chilopods in which a ventral subcoxo-coxal articulation is present, the anterior and posterior ventral muscles (*K, L*) must act as promoters and remoters.

The base of the coxa in the Chilopoda is provided also with median dorsal and ventral muscle. The dorsal median muscle in *Scutigera* (fig. 10 B, *M*) consists of a flat band of short fibers arising on the dorsal plate of the subcoxa (*cpl*), and is inserted on the rim of the coxa just behind the dorsal articulation with the subcoxa. This muscle

appears to be a remotor of the coxa in *Scutigera*, though it may have an abductor function also. The ventral median muscles of *Scutigera* comprise two bundles of fibers, one arising medially on the sternum (fig. 10 B, *N*), the other (*N'*) arising on the lateral arm of the endosternal furca. These muscles are coxal adductors since the coxa has no fixed ventral articulation in *Scutigera*. The ventral coxal muscles are covered dorsally by large bands of trochanteral muscles that take their origin on the sternum.

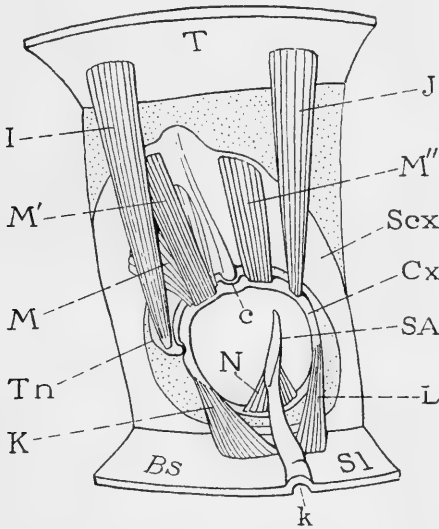

FIG. 11.—Diagram of the basal musculature of an insect leg.

Bs, basisternum; *Cx*, coxa; *I*, tergal promotor muscle; *J*, tergal remotor; *K*, sternal promotor (anterior rotator); *k*, furcal suture; *L*, sternal remotor (posterior rotator); *M*, abductor of the coxa; *M'*, *M''*, abductors of the coxa that become the basalar and subalar muscles in the wing-bearing segments of adult insects; *N*, adductor of the coxa; *SA*, sternal apophysis; *Scx*, subcoxa; *Sl*, sternellum; *T*, tergum; *Tn*, trochantin.

In the insects the sclerotic areas of the subcoxae of the legs evidently become the pleural plates of the thoracic segments. The tergal promotor muscle of the leg base (fig. 11, *I*) retains its connection with the subcoxa in the more generalized pterygote insects, being inserted on the trochantinal sclerite of the subcoxa (*Tn*) except when the trochantin is lost, the muscle then having its insertion on the anterior angle of the coxal base. The remotor muscle (*J*), which may be represented by several fiber bundles, is always inserted on the coxa or on coxal apodemes. The anterior and posterior sternal muscles (*K*, *L*) arise on the sterna or the sternal apophysis, or on the spinasternum.

The median coxal muscles are represented in insects by both dorsal (*M*) and ventral (*N*) fibers. In the wing-bearing segments of pterygote insects the first comprise three distinct groups of abductor fibers (*M*, *M'*, *M''*) arising dorsally on the pleuron, and inserted ventrally on the coxa both anterior and posterior to the dorsal articulation of the latter (*c*). The second and third muscles of this group (*M'*, *M''*)

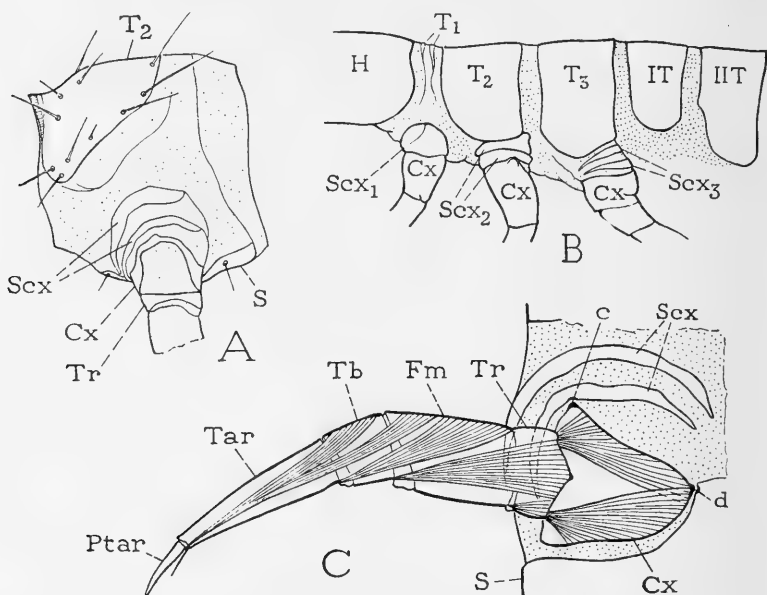

FIG. 12.—Thoracic pleural sclerites of Apterygota.

A, lateral view of left side of mesothorax of *Acerentomon doderoi* (from Berlese, 1910). B, thorax, base of head, and base of abdomen of *Isotoma sp.* (from Ewing, 1928). C, left mesothoracic leg turned forward, and lateral region of mesothorax of *Acerentulus barberi* (from Ewing, 1928).

c, dorsal articulation of coxa; *Cx*, coxa; *d*, ventral articulation of coxa; *Fm*, femur; *H*, head; *IT*, *IIT*, first and second abdominal terga; *Ptar*, pretarsus; *S*, sternum; *Scx*, subcoxa; *T₁*, *T₂*, *T₃*, thoracic terga; *Tar*, tarsus; *Tb*, tibia; *Tr*, trochanter.

become wing muscles in the adult by the partial or complete detachment of the epipleural areas on which they arise to form the basalar and subalar plates of the wing base. The ventral median muscle of the coxa (*N*) is present in insects that lack a ventral coxal articulation; it arises on the sternal apophysis and functions as a coxal adductor.

In the Apterygota the subcoxa becomes rudimentary. In most of the Protura its sclerotization is reduced to two slender plates arched concentrically over the base of the coxa (fig. 12 A, C, *Scx*), as shown by Berlese (1910) and by Ewing (1928), though Prell (1913) has

described the pleural sclerotizations of *Eosentomon germanicum* as consisting of a number of small sclerites, which, however, fall into two concentric series. (See Snodgrass, 1927, fig. 8.) In the Collembola, as shown by Ewing (1928), the subcoxal sclerotizations of the mesothorax and metathorax (fig. 12 B, Scx_2 , Scx_3) consist in each segment of two slender, supra-coxal arches; the subcoxal sclerotization of the prothorax (Scx_1) is a single plate with an incomplete subdivision. In the Thysanura the subcoxal pleurites likewise take the form of two arches over the coxal base, or they become reduced to a single sclerite. The coxal and subcoxal musculature of the Apterygota has been but little studied.

In the thoracic segments of the Pterygota the subcoxae evidently become the sclerotized parts of the lateral segmental walls known as the *pleura* (cf. figs. 1 and 13). The ventral rim of each subcoxa, lying between the coxa and the sternum (fig. 13 A), may be reduced to a membranous fold, though in rare cases it contains a large plate (fig. 17, Ls_2 , Ls_3), and in others a rudimentary sclerite (fig. 16 A, Ls). In the majority of insects, as has been shown by Weber (1928, 1928 a), the ventral arc of the subcoxa has apparently fused with the primary sternite to form a laterosternite of the definitive sternum (figs. 13 B, 18 D, Ls).

The coxa of insects is universally hinged to the subcoxa by a dorsal articulation (fig. 1, *c*); it may also have either an anterior articulation with the trochantal piece of the subcoxa (fig. 13 B, *e*), or a ventral articulation (*A*, *d*) with the ventral rim of the subcoxa or with the subcoxal laterosternite. The trochantal articulation of the coxa is peculiar to certain insects and is, therefore, probably a secondary one. The ventral articulation, however, so frequently recurs both in the Chilopoda (fig. 15, *d*) and in the more generalized insects (fig. 16 A, B, *d*) that there can be little doubt that the primitive axis of the subcoxo-coxal hinge was vertical or approximately so. The writer, therefore, would retract the opinion, expressed in a former study of the thorax (1927, pp. 34-36), that the primitive axis of the coxal movement was a horizontal one between anterior and posterior articulations with the eutrochantal arch of the subcoxa. The ventral articulation of the coxa is highly variable in insects; it is always absent in the more generalized Pterygota that have a well-developed trochantin. In the members of the higher orders lacking a trochantin it is commonly present, but it is to be suspected in such cases that the articulation is a secondary one developed between the coxa and the sternum.

The usual trochantin of the pterygote pleuron (fig. 13 B, *Tn*) is clearly a remnant of a more extensive, primitive, supra-coxal sclerotization (fig. 1, *Eutn*) carrying the dorsal articulation of the coxa (*c*), which Crampton (1914) has named the *eutrochantin*, and which is best preserved in the ventral arch of the apterygote pleuron (fig. 12). The eutrochantin is retained as an independent sclerite also in the prothorax of the Plecoptera, but in all other Pterygota (fig. 13,

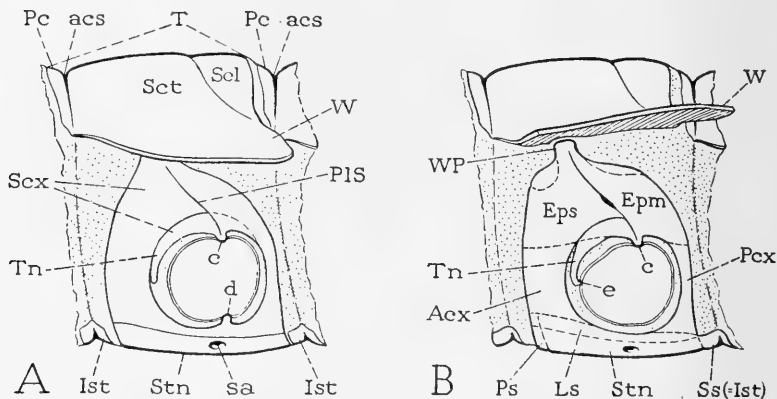

FIG. 13.—Diagrams suggesting the development of the pterygote pleuron from the subcoxa of the leg basis. (Compare with Fig. 1.)

A, subcoxal sclerotization (*Scx*) united ventrally with edge of primary sternite (*Stn*), its dorsal extremity prolonged upward as a wing support (B, *WP*), posterior part of entrochantin (fig. 1, *Eutn*) fused with eupleural arch (fig. 1, *Eupl*) of subcoxa.

B, a fundamental structural condition of pleuro-sternal region of a wing-bearing segment: the area of subcoxa differentiated into an episternum (*Eps*), an epimeron (*Epm*), a precoxal bridge (*Acx*), a postcoxal bridge (*Pcx*), a laterosternite (*Ls*), and a trochantin (*Tn*); the definitive sternum includes the primary segmental sternite (*Stn*), the following intersegmental intersternite, or spinasternite (*Ss*), and a subcoxal laterosternite (*Ls*) on each side; the ventral coxal articulation (A, *d*) is lost, and coxa has a secondary anterior articulation with trochantin (*e*).

A, B) its dorsal and posterior parts unite or fuse with the upper arch of the pleuron (eupleuron), and only its anterior part remains as a free sclerite (fig. 13 B, *Tn*) carrying the anterior coxal articulation (*e*).

The elaborate pterygote pleuron has evidently been developed to give support to the paranotal lobes, or to the wings evolved from the latter. It is therefore strengthened by an internal ridge formed from a linear inflection of its wall, the *pleural suture* (fig. 13 A, *PIS*), extending from the dorsal articulation of the coxa (*c*) upward to the wing support (B, *WP*). The area lying posterior to the pleural suture is the *epimeron* (B, *Epm*), that situated anterior to it and dorsal to

the trochantin is the *episternum* (*Eps*). The sclerotized parts of the subcoxa lying anterior and posterior to the coxa are the *precoxal* and *postcoxal bridges* (*Acx*, *Pcx*), or *precoxalia* and *postcoxalia*. The ventral wall, or infra-coxal arc, of the subcoxa, as already noted, probably unites in many cases with the edge of the primary sternum (*Stn*) to form a laterosternal element (*Ls*) in the definitive sternum, though it may be reduced to a separate sclerite or form a membranous fold between the coxa and the sternum.

All parts of the pleuron are subject to innumerable secondary modifications taking the form of sutures that subdivide the primary areas, or of membranous lines and spaces that break them up into separate sclerites. Such modifications are not necessarily homologous between different orders, but within an order or group of orders they may give valuable evidence of the evolution and interrelationships of the families and genera. An example of this is given by Shepard (1930) in a study of the secondary pleural sutures of Lepidoptera.

In the wing-bearing segments of the Pterygota two large pleuro-coxal muscles (fig. 11, *M'*, *M''*) become important muscles of the wings. These muscles evidently are derived from the abductor system of the coxa. In nymphal Orthoptera (fig. 27 C) the anterior muscle (*M'*) has its origin on the dorsal part of the episternum, the posterior muscle (*M''*) on the dorsal edge of the epimeron. In adult insects, however, the areas upon which these muscles are attached become partially or entirely separated from the pleuron and intimately associated with the base of the wing, the first lying before the pleural wing process, the second behind it. In this way the muscles come to function as wing muscles, though each retains its ventral attachment on the coxa.

The epipleurites ("paraptera"), or sclerites detached from the pleuron in connection with the coxo-alar muscles, include one or two episternal sclerites, or *basalares*, and usually a single epimeral sclerite, or *subalare*. The subalare is always completely detached from the epimeron in adult insects (fig. 14 A, B, *Sa*). A basalar plate, however, is not always present as a distinct sclerite; it frequently occurs as but an imperfectly separated lobe of the upper end of the episternum (fig. 14, *Ba*), and its area is sometimes marked only by the insertion of the anterior coxo-alar muscle (*M'*). Even when the basalar is distinct from the episternum, it is generally hinged to the upper edge of the latter in such a manner that it is deflected by the contraction of its muscle. Frequently there is present a second basalar muscle (figs. 27 C, E) having its origin on the pleuron or on the sternum.

The theory of the origin of the principal pleural sclerites of the Chilopoda and Hexapoda from subcoxal segments of the legs has much in its favor. There is little evidence, however, that a subcoxa is a primary segment in the general arthropod appendage. The limb bases of the Arachnida, Xiphosura, and most Crustacea are the primitive coxae (coxopodites), for there can be no doubt of the identity of the coxo-trochanteral articulation in all arthropods. The writer

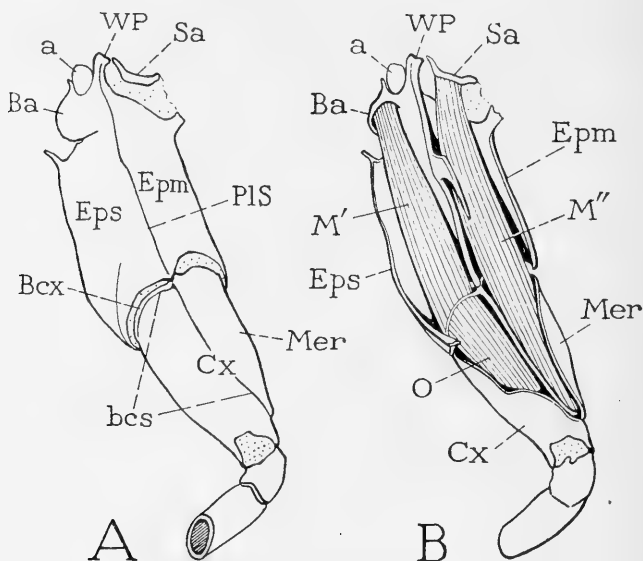

FIG. 14.—The mesopleuron and base of the middle leg of a scorpion fly, *Panorpa consuetudinis*.

A, external view. B, internal view, showing muscles. *a*, accessory sclerite of basalar lobe; *Ba*, basalar lobe of episternum; *bcs*, basicostal suture of coxa; *Bcx*, basicoxite; *Cx*, coxa; *Epm*, epimeron; *Eps*, episternum; *M'*, basalar muscle; *M''*, subalar muscle; *Mer*, meron; *O*, levator muscle of trochanter; *PLS*, pleural suture; *Sa*, subalar sclerite; *WP*, pleural wing process.

clearly was mistaken in suggesting in a former paper (1927, p. 33) that the large basal leg segments of the ticks (Ixodoidea) are subcoxal; and he now believes that the segmentation of the arachnid limb can be given an interpretation different from that proposed by Ewing (1928), who would make the basal segment in most cases a subcoxa. In the decapod crustaceans the inner walls of the gill chambers, as has already been pointed out, are evidently expansions of the subcoxal regions of the bases of the ambulatory legs, to which the coxae of the latter have become articulated; but there is no evidence of the presence of subcoxal segments in the limbs of the more generalized Crustacea. In the myriapods and insects, moreover, as the writer has else-

where shown (1928), there are no true subcoxal segments in the mouth part appendages. From the evidence at hand, therefore, it appears most in accord with the known facts to conclude that *the subcoxa, wherever it occurs as a basal leg segment, has been produced by a secondary subdivision in the primitive limb basis, or coxopodite.*

THE THORACIC STERNA

Sternal plates are by no means so constant a feature in the sclerotization of arthropod segments as are the tergal plates. They may be present or absent within the same major group, and, where present,

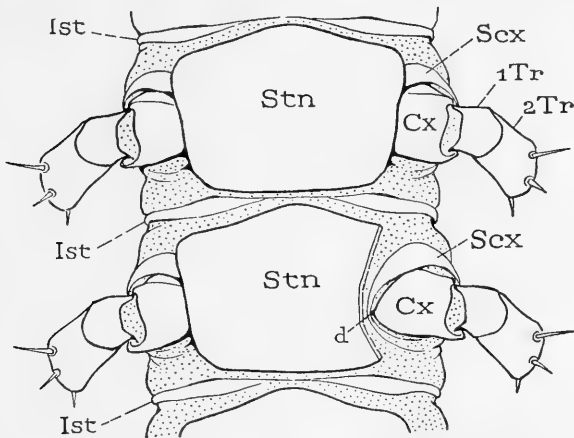

FIG. 15.—Sternites and leg bases of two consecutive segments of *Lithobius* (Chilopoda).

Cx, coxa; *d*, ventral subcoxo-coxal articulation; *Ist*, intersternite; *Scx*, subcoxa; *Stn*, segmental sternite; *1Tr*, first trochanter; *2Tr*, second trochanter.

they are often highly variable both in form and extent of development between closely related groups and in the different body regions of almost any species.

In adult insects the sternal mechanism of the thorax differs in three important respects from that of the abdomen, and the functional differences in the two body regions are reflected as three distinctive structural features in the sternal parts.

The first distinction to be noted in the sternal structure, as between the thorax and the abdomen, pertains to the segmental relations of the intersegmental sternites. In the abdomen of adult insects the intersegmental sclerotizations of both the dorsum and the venter are continuous with the segmental sclerotizations following, and the transverse inflections in the cuticula of the primary intersegmental regions,

on which the fibers of the longitudinal muscles are attached, become the *antecostae* of the definitive terga and sterna (fig. 3). In the thorax, on the other hand, the ventral intersegmental sclerotizations either remain as small, free sclerites (fig. 1, *Ist*), or they unite with the posterior parts of the segmental plates preceding. The intersegmental sternites, or intersternites, of the thoracic region are the *spinasternites* (fig. 18 D, *Ss*), so-called because each usually bears a small median apodemal process, the *spina* (fig. 4). A spinasternite occurs typically between the prothorax and the mesothorax, and between the mesothorax and the metathorax; there is never a free spinasternite following the metasternum because the corresponding intersegmental element goes with the first abdominal sternum to form the antecosta of the latter, except where it is lost as a result of the degeneration of the first abdominal sternum. The first spinasternite is more commonly persistent than the second which is usually fused into the posterior part of the mesosternum, where it may become entirely obliterated.

The second structural difference between the thoracic and abdominal sterna accompanies the difference in the relations of the intersegmental sclerites to the segmental plates, but is not necessarily correlated with it. It consists of a reversal in the overlapping of the sterna. The successive abdominal sterna overlap regularly in a posterior direction, as do the terga of both the abdomen and the thorax (fig. 3). The sterna of the thorax, on the other hand, overlap *anteriorly*. The metathoracic sternum, therefore, stands as a dividing plate between the anteriorly overlapping sterna of the thorax and the posteriorly overlapping sterna of the abdomen (fig. 3, *S₃*).

This reversal in the overlapping of the sternal plates as between the thorax and the abdomen is probably the oldest structural differentiation between the two regions of the body, for it is well shown in some of the Apterygota, particularly in *Japyx*, and is exhibited by all pterygote insects in which the thoracic sterna remain free from each other. It was probably, therefore, established when the thorax was first set apart as the locomotor center of the body, and has nothing to do with the development of the wings. Just what advantage accrues to the thoracic mechanism from the reversed relations of its sternal plates is not clear, but presumably it gives a better device for the movement of the legs or for the movement of the successive segmental plates on each other.

The third distinction between the thorax and the abdomen occurs in adult pterygote insects, and pertains to the attachments of the ventral muscles. We have assumed that the primitive attachments of the

fibers of the longitudinal muscles are on the intersegmental folds or on intersegmental sclerotizations (figs. 2, 3). The dorsal muscles throughout the length of the body, and the ventral muscles of the abdomen are thus attached, except where the anterior ends of the fibers may have migrated to the segmental regions of the definitive terga and sterna. In the thorax of adult pterygote insects, however, most of the sternal muscles are stretched between paired apodemal processes of the segmental sternites (fig. 4, SA_1, SA_2), except that the anterior-most fibers are inserted anteriorly on the head, while the posteriormost fibers extend into the abdomen. Only a few slender median muscles retain a connection with the intersternites ($1Ss, 2Ss$). The paired

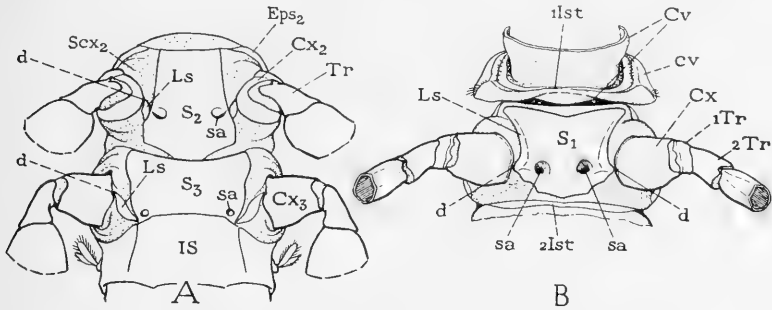

FIG. 16.—Sternal structure of ephemerid and odonate nymphs.

A, ventral surface of mesothorax, metathorax, and first abdominal segment of an ephemerid nymph, showing ventral articulations of coxae (*d*) with subcoxal, laterosternal sclerites (*Ls*).

B, ventral surface of neck and prothorax of an aeschnid nymph, showing direct articulation of coxae (*d*) with laterosternal parts (*Ls*) of the definitive sternum.

apophyses of the thoracic sterna are the so-called *furcal arms*, which in the higher orders are united upon a common median base and here constitute a true *furca*.

The anterior ends of the ventral muscle fibers, as we have noted, are attached on the back of the head. In orthopteroid insects the attachment is with the posterior arms of the tentorium (fig. 4, *PT*), but this condition is clearly a secondary one since the posterior tentorial arms are tergal apodemes. In many adult insects, and in most holometabolous larvae, the anterior ventral muscles are inserted on the posterior part of the head wall. Morison (1927) enumerates three pairs of prothoracic sternal muscles in the honeybee, all of which are attached anteriorly on the lateral occipital regions of the head. In the caterpillars the corresponding muscles are inserted on apodemes of the ventral margin of the foramen magnum. In all such cases the insertion points of the ventral head muscles must have acquired their present positions

by a migration from the true sternal region of the last head segment, which is the membranous floor of the neck behind the base of the labium.

The ventral muscles of the thorax retain apparently the primitive condition in the larvae of most holometabolous insects. In the caterpillar, for example, the principal longitudinal ventral muscles consist of two wide bands of fibers lying to each side of the ventral nerve cord, extending through the entire length of the body, and attached regularly on the intersegmental folds as are the dorsal longitudinals. External to the dorsal and ventral intersegmental muscles of the caterpillar there is an intricate complex of small muscles disposed in all directions against the wall of each segment.

In certain larval forms, as in some Coleoptera, the attachment of the ventral body muscles shows a condition intermediate between the usual larval condition and that of the adult. In the larva of *Dytiscus*, for example, as shown by Speyer (1922), though most of the ventral thoracic muscles are intersegmental, being attached either to processes of the intersegmental folds or to transverse ligaments arising from the folds, some of the fibers extend between segmental furcal apophyses, which are present on each primary sternal region of the thorax. The ventral muscle bands of the thorax are continued into the abdomen, some of the fibers of the first abdominal segment being attached anteriorly on the intersegmental fold behind the metathorax, others on the furcal arms of the metasternum. In the adult of *Dytiscus* (Bauer, 1910) all the ventral muscles of the thorax are interfurcal in their attachments, and none extends from the thorax into the abdomen.

Ventral muscles from the thorax into the abdomen are absent in the adult stage of many pterygote insects (fig. 35), though they may be present in the larval or the nymphal stages. In the nymph of *Psylla mali*, according to Weber (1929), two bundles of fibers diverge from the base of the metafurca to the anterior edge of the second abdominal sternum, but these muscles, Weber says, are lost in the adult.

In some insects, however, the ventral thoracico-abdominal muscles are present in the adult stage. They are well developed in the cockroach (*Blatta orientalis*), comprising here three pairs, the first arising on the second spina, the second on a ligamentous bridge between the bases of the metasternal apophyses, the third on the apophyses, all of which are inserted posteriorly on the anterior margin of the second abdominal sternum. The fibers arising on the metapophyses form the anterior ends of the ventral longitudinal muscle bands of the abdomen. In *Gryllus*, Voss (1905) describes a median pair of muscles arising on the metafurca which branch posteriorly to the third, fourth, and

fifth abdominal sterna, and two lateral groups on each side which go to the parasternal plates of the second abdominal segment. In the Cicadidae ventral muscles extend from the metathorax to the second abdominal sternum. In the Tenthredinidae, according to Weber (1927), a pair of muscles extends from the metafurcal arms to the second sternum of the abdomen, and in the honeybee Morison (1927) describes two corresponding pairs of muscles going from the metafurca to the anterior margin of the second abdominal segment. Inasmuch as these muscles, which represent the ventral muscles of the first abdominal segment, have no connection with the first abdominal sternum, it is evident, as Morison points out, that their insertions, normally on the intersegmental anterior edge of the first abdominal sternum, have been secondarily transferred to the furcal apophyses of the metathoracic sternum. In the Ephemera, however, Dürken (1907) records the presence of a pair of muscles attached anteriorly on the bases of the metasternal apophyses and posteriorly on the anterior margin of the *first* abdominal sternum. These muscles would appear to correspond with the furco-spinal muscles, which are present in the prothorax of the grasshopper (fig. 35, 61).

Even a brief review of the comparative musculature of larval and adult holometabolous insects thus shows that there takes place during metamorphosis a rearrangement in the attachments of the ventral muscles of the thorax, and, in some cases, of those of the first abdominal segment, as a result of which most of the persisting fibers lose their intersegmental connections and acquire segmental attachments on the furcal apophyses of the thoracic sternal plates.

The larval condition of intersegmental muscle attachments is clearly a more primitive one than that of the adult. The adults of insects with incomplete metamorphosis resemble those of holometabolous forms in having the principal ventral muscles attached on the furcal arms. Therefore, we must suspect that the latter condition is one secondarily acquired in all pterygote insects, and that it has come about during the evolution of the thorax as a specialized locomotor region of the body. Since the transposition of the ventral muscles takes place in the prothorax as well as in the other two thoracic segments, we cannot attribute its inception to the development of the wings. As yet, however, we may draw only tentative conclusions concerning the evolution of the ventral musculature of the thorax, since our knowledge of the nymphal muscles in hemimetabolous insects and of both the larval and adult muscles in the more generalized holometabolous forms is very incomplete; but the facts known point strongly to the transformation suggested above.

An alteration in the attachment of the ventral muscles similar to that which evidently has taken place in insects may be observed also in the Chilopoda, here between members of different families. In the Geophilidae and in *Lithobius* the ventral longitudinal muscles consist principally of two flat, widely-separated bands of fibers lying close against the body wall and inserted on intersegmental sclerotizations.

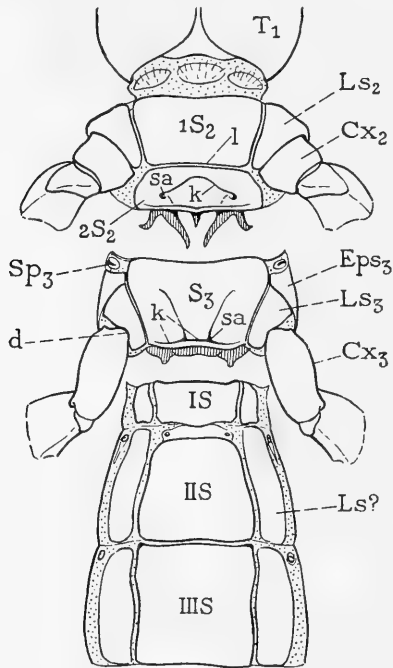

FIG. 17.—Ventral view of the base of the prothorax, the mesothorax, the metathorax, and the base of the abdomen of the large South American embiid, *Cylindrachaeta spagazzinii*.

d, ventral articulation of coxa with subcoxal laterosternite (*Ls*); *k*, furcal suture; *l*, secondary suture of mesosternum; *Ls*, laterosternite; *1S₂*, anterior plate of mesosternum; *2S₂*, posterior plate of mesosternum (furcasternite); *T₁*, ventral fold of protergum.

In *Scolopendra* and *Scutigera*, on the other hand, both the longitudinal ventral muscles and many other muscles of each segment are attached on two ligamentous supports that arise from the posterior parts of the segmental sternites. In *Scolopendra* each ligament has a separate origin on the sternum; in *Scutigera* the two ligaments in each segment arise from a common base, forming thus a furca-like structure (fig. 10 B, *Fu*) suggesting that of the higher pterygote insects.

It is scarcely possible that there is any genetic relation between the furcal apophyses of insects and the muscle-supporting structures of

Scolopendra and *Scutigera*, but it is clear that the muscle attachments have been altered by a transposition which is of a parallel nature in the two cases.

In the Chilopoda the sternal plates are uniformly developed throughout the length of the body. In *Strigamia*, *Lithobius*, and *Scolopendra* there is a series of alternating segmental *sternites* (figs. 8 B, 15, *Stn*) and intersegmental *intersternites* (*Ist*). The intersternites are lacking in *Scutigera*; they are highly developed in the geophilid *Strigamia bothriopus*, where their lateral ends extend upward on the sides of the body between the subcoxae (fig. 8 A), but they are small and inconspicuous in *Lithobius* (fig. 15). In both the geophilid and lithobiid as we have seen, the longitudinal ventral muscle bands have their attachments on the intersternites.

The presence of alternating sternites and intersternites in the chilopods might suggest that this condition was the primitive one in insects, and that the intersternites (spinasternites) have remained free in the thoracic region or have united with the preceding sterna, while they have fused with the segmental sternites following in the abdomen. In the odonate larva shown at B of figure 16 there is a long intersegmental sclerite (*2Ist*) between the posternum (S_1) and the mesosternum suggestive of the intersternites of the Chilopoda, and the fold (*1Ist*) in the ventral side of the neck (*Cv*), which bears the cervical sclerites laterally (*cv*), appears to be likewise an intersternite between the labial segment and the prothorax. In the Acrididae the spinasternite between the prothorax and mesothorax (fig. 21, S_s) is a well-formed plate attached to the prosternum (*S*); that between the mesothorax and metathorax is indistinguishably fused into the posterior border of the mesosternum, though the spina persists (fig. 31, *2Spn*). In many insects the first spinasternite is a free sclerite, and in the Blattidae both the first and the second are distinct plates (fig. 19 A, *1Ss*, *2Ss*).

The definitive thoracic sterna of most insects are undoubtedly composite structures. The first and second intersternites are usually contained in the posterior parts of the prosternum and mesosternum, respectively, or at least are closely associated with them, though the first frequently retains its independence. The ventral arcs of the subcoxae contribute laterosternal elements in many insects. The evident union of the ventral rim of the subcoxa with the sternum has been noted in the Hemiptera (Heymons, 1899, Snodgrass, 1927), but Weber (1928, 1928a) has given ample reasons for believing that this fusion of subcoxal elements with the primary sternum has taken place in the majority of insects. The frequent ventral articulation of the

coxae with the lateral margins of the sternum in generalized insects (figs. 12 C, 16 B, *d*) is further evidence that the sternum in such cases includes the infracoxal parts of the subcoxae, especially since it is found that, where distinct subcoxal laterosternal sclerites exist (figs. 16 A, 17, *Ls*), the coxae articulate with these sclerites (*d*).

It is difficult to find in the insects a good example of a simple primary sternal plate, comparable with the sterna of the Chilopoda (fig. 15), that does not contain either the following intersternite or subcoxal laterosternal elements, or both. In the mesothorax and metathorax of the ephemerid nymph shown in figure 16 A, the sterna (S_2, S_3) may contain the intersternites, but the two small sclerites in each segment (*Ls, Ls*) that articulate between the sternum and the coxa on each side appear to be the only remnants of subcoxal laterosternites. In the large embiid *Cylindrachaeta* (fig. 17) laterosternal plates (Ls_2, Ls_3) likewise are distinct, though the intersternites are clearly united with the primary sternites. In the prothorax of the aeschnid larva shown in figure 16 B the intersternite ($2Ist$) is independent of the sternum, but the laterosternites (*Ls*) are fused into the lateral sternal margins.

These several forms make it clear that the definitive thoracic sternum of insects is typically a compound plate. It consists of a *primary sternite* (fig. 18 A, B, *Stn*), to which may be added the succeeding *intersternite* (*Ist*), which becomes the *spinasternum* (C, D, S_s), and a pair of *laterosternites* (D, *Ls, Ls*) derived from the ventral arcs of the adjoining subcoxae (B, C, *Scx*).

The possession of paired apophyses, or *furcal arms*, is characteristic of the thoracic sterna of all pterygote insects. The apophyses arise from the sternal plates between the bases of the legs, and their outer ends are usually closely attached, either by fusion or by short muscle fibers, to the inner ends of the corresponding pleural apophyses.

Weber (1928, 1928a) advances the view that the sternal apophyses are primarily invaginations formed on the line of union between the primary sternites and the subcoxal laterosternites. In some insects, however, in which there are laterosternal plates not united with the sterna (figs. 16 A, 17), the origins of the sternal apophyses (*sa*) are still well within the sternal margins; and in an aeschnid nymph (fig. 16 B) the apodemal invaginations (*sa, sa*) are removed from the apparent margins of the laterosternite sections (*Ls*) of the definitive sternum. From evidence of this nature the writer would regard the sternal apophyses as invaginations in the primary sternal plate itself (fig. 18 B, *Stn*), though there is much in favor of Weber's view. The mesosternum of wingless females of the black aphid, *Aphis fabae*,

Weber (1928a) says, presents a case in which there can be no doubt that the furca arises at a point between the basisternite, the furcaster- nite, and the subcoxal laterosternite.

In the higher insects the sternal apophyses approach each other in each segment and unite upon a common basis produced by a median

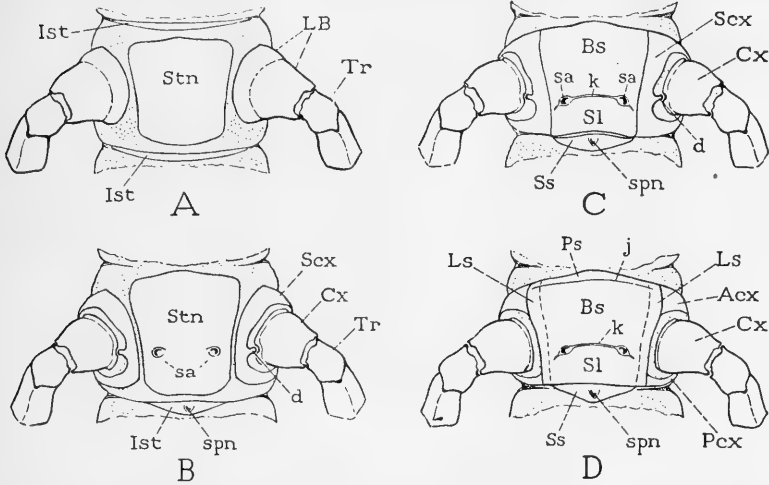

FIG. 18.—Diagrams suggesting the theoretical evolution of a thoracic sternum.

A, primitive condition in which the ventral sclerotization consists of alternating segmental sternites (*Stn*) and intersegmental intersternites (*Ist*); the leg basis (*LB*) is an undivided coxopodite.

B, primary sternite marked by the pits (*sa*) of a pair of internal apophyses, intersternite (*Ist*) by the pit (*spn*) of a median process, or spinasternum (*A, LB*) subsegmented into subcoxa (*Scx*) and coxa (*Cx*), articulated dorsally and ventrally (*d*).

C, area of primary sternite (*A, B, Stn*) divided into basisternum* (*Bs*) and sternellum (*Sl*) by a furcal suture (*k*) forming an internal furcal ridge between bases of sternal apophyses; the following intersternite has become a spinasternum (*Ss*) by union with segmental sternite; subcoxa (*Scx*) united ventrally with sternum.

D, typical definitive sternum, composed of primary sternite (*A, B, Stn*), a pair of subcoxal laterosternites (*Ls, Ls*), and the spinasternite (*Ss*); area of primary sternite divided into basisternum (*Bs*) and sternellum (*Sl*) by the furcal suture (*k*), and with a narrow presternum (*Ps*) set off by a secondary presternal suture (*j*).

inflection of the sternal wall. In this way is formed the typical, forked endosternal structure known as the *furca*, the evolution of which has been portrayed by Weber (1928). The part of the sternum bearing the furca lies between the coxae, and is usually much narrowed by comparison with the region of the sternum anterior to it.

The definitive sternal plate, whether it includes subcoxal laterosternal elements and the following intersternite, or does not, is commonly subdivided into an anterior and a posterior region. Fundamentally the

dividing line is a transverse inflection, or "suture," passing through the bases of the sternal apophyses (fig. 18 C, *k*). The inflection is usually strongly sclerotized, forming an internal ridge evidently designed to brace the sternum and to support the apophyses (figs. 21 B, 31, *k*); it sometimes remains weak, however, and establishes a line of flexibility in the sternum. In either case the sternum is demarked by the furcal ridge and its suture (*k*) into a *prefurcal area* (fig. 18 C, *Bs*) and into a *postfurcal area* (*Sl*).

The anterior region of the sternum has been variously named *sternum*, in a restricted sense, *antesternum*, *mesosternum*, *basisternum*, *eusternum*, and *sternannum*; the second has been called *sternellum*, *poststernum*, *metasternum*, and *furcasternum*. There are objections to all but one of these terms. "Antesternum" and "poststernum" (Amans, 1885) are applicable in some cases, but there is often a pre-sternal piece before the "antesternum," and very commonly the intersegmental spina-bearing plate forms an actual poststernal element of the definitive sternum behind the "poststernum." "Mesosternum" and "metasternum" (Berlese, 1909) violate the priority of the segmental prefixes. "Basisternum" and "furcasternum" (Crampton, 1909) are misleading because the part designated by the first is not basal, and that bearing the second name does not always carry the furcal apophyses. "Eusternum" (Snodgrass, 1910) implies that the part so named is the "true" sternum, which it is not. "Sternannum" (Mac Gillivray, 1923) has no grammatical standing, so far as the writer can find. "Sternellum" (MacLeay, 1830) alone can be given a clean bill. Of the terms applied to the prefurcal area, however, "basisternum" appears to be the least objectionable. In the present paper, therefore, the writer adopts the following terms for the principal divisions of the definitive sternum (fig. 18 D): *presternum* (*Ps*), *basisternum* (*Bs*), *sternellum* (*Sl*), and *spinasternum* (*Ss*). The first three are secondary subdivisions of the primary segmental sternum; the fourth is the intersegmental intersternite. To the primary sternal region there may be added on each side a subcoxal *laterosternite* (*Ls*).

The parts of the definitive thoracic sternum as described here fit exactly with the definitions of the sternal sclerites given by Weber (1928, pp. 250, 251), with the understanding that the term "sternellum" is substituted for "furcasternum," and that the poststernite is the intersegmental spinasternite. This idea of the sternal composition differs from Crampton's (1909) conception in that the fundamental transverse dividing line of the sternum is assumed to be the furcal suture (*k*) between the bases of the sternal apophyses, and not a divi-

sion anterior to the apophyses. A prefurcal division sometimes does occur (fig. 17, *l*), but it is clearly of a secondary nature and is variously produced.

The furcal suture is subject to much diversity in form, being sometimes produced forward and branched laterally, or curved posteriorly, thus giving a variety of structure to its apodemal ridge, and often obscuring the primary line of the sternal division.

The form and size of the sternal plates are frequently altered by a variation in the extent of the ventral sclerotization in the different thoracic segments. In the Blattidae it is evident that a partial desclerotization of the sternal cuticula has produced the unusual shapes and relationships of the sternal sclerites of the thorax (fig. 19). The prosternum most nearly preserves the typical form (B). It comprises two median plates (*A*, BS_1 , Sl_1) separated by a transverse fold (*k*) across the sternal region, from which arise the prosternal apophyses (SA_1). A comparison with the assumed generalized structure of a thoracic sternum (B) will easily suggest that the transverse fold is the furcal suture (*k*), and that the pattern of the prosternal plates (C) has been produced by suppression of sclerotization in the lateral fields of the sternal area. In the mesothorax of *Blatta* (A) the ventral sclerotization is reduced to a pair of basisternal plates (BS_2), and a Y-shaped furca-bearing sclerite (Sl_2), the two separated by an ample membranous area. In the latter are remnants of the sternal fold (*k*) from which arise the sternal apophyses (SA_2) at the ends of the sternellar arms. The diagram D shows more clearly the relation of the mesosternal structure in the roach to the fundamental sternal structure (B), and again suggests that the peculiar features of the thoracic-sterna of the roach are results merely of a reduction in the extent of the sclerotized areas. The metasternum of *Blatta* (A) is essentially the same as the mesosternum, but the sternal fold appears to be suppressed and the apophyses (SA_3) arise from the sternellum (Sl_3).

In some insects a thoracic sternum may be divided into two parts by a suture that is quite independent of the furcal suture. A clear case of this is seen in the thorax of the large embiid *Cylindrachaeta* (fig. 17), where a suture (*l*) cuts the mesosternum into an anterior plate ($1S_2$) and a posterior plate ($2S_2$). The second plate is marked by the usual furcal suture (*k*) and bears the furcal arms; it is a true furca-sternite. The metasternum has the usual structure, though the sternellum is reduced to a narrow band behind the furcal suture (*k*).

Most entomologists have believed that the sternum of a thoracic segment of an insect is "composed of" two principal plates, and the

pattern of the sternal sclerites in the cockroach (fig. 19) has had much to do with establishing this idea, for students have not recognized that the separated plates here are products of sclerotic degeneration, and that the fundamental structure, as shown best in the prothorax, is the same as in insects with undivided thoracic sterna. While the Blattidae undoubtedly retain some relatively generalized structural

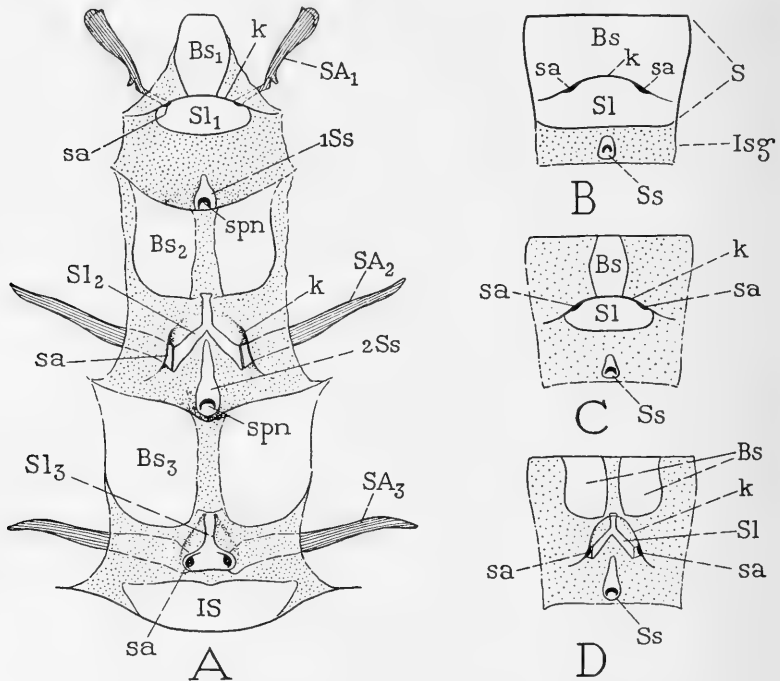

FIG. 19.—The thoracic sterna of a cockroach, *Blatta orientalis*.

A, general view of the three thoracic sterna and their paired apophyses. B, diagram of typical structure of a sternum. C, diagram of prosternum of *Blatta*. D, diagram of mesosternum of *Blatta*.

Bs, basisternum; *IS*, first abdominal sternum; *k*, furcal suture; *SA*, sternal apophysis; *sa*, external pit of sternal apophysis; *Sl*, sternellum; *spn*, external pit of spina; *Ss*, spinasternum; *S*, segmental sternum.

characters, they are in many respects highly specialized insects adapted to a particular kind of habitat, though to one almost universally distributed. The flattening of the body has been accompanied by a structural alteration in most of the under parts of the thorax, and there is every reason to believe that the sterna, covered as they are by the bases of the legs, have become largely membranized to allow of an inflection of their posterior parts. We should be on very unsafe ground, therefore, if we take the fragmented condition of the sternal sclerotization

in the thorax of the roach as representative of the primitive structure of the thoracic sterna in insects.

A search for a generalized thoracic sternum among all groups of insects, the writer believes, would reveal nowhere the thing sought for, because it does not exist. A study of the arthropods as a whole, however, suggests that the original area or areas of sclerotization in the ventral region of each segment spread into a continuous plate between the leg bases. The thoracic sterna of insects have been variously modified by the development of apodemal braces where rigidity is demanded, and by secondary divisions or by reductions in the areas of sclerotization where flexibility is important. This theory recommends itself by the fact that it permits all kinds of specific structures and sclerotic patterns to arise, and does not assume that homologies must exist where none can be established.

II. THE THORACIC SKELETON OF DISSOSTEIRA

The Carolina locust, *Dissosteira carolina*, is here used as the subject for a special study of the thorax and its mechanisms because it is an insect sufficiently large for work on internal structure and is readily obtained, and because its muscular system is simple and comparatively easy to dissect. The thorax of the Acrididae is by no means generalized, but for this reason it offers a good test for the application of general principles to the solution of specific problems. The structural features of the thorax in the locust, however, are those common to all insects, and in the musculature there is almost no addition of special muscles such as are found in most of the higher insect orders and to some extent in the other orthopteran families.

The thorax of the jumping Orthoptera is so distinctly divided into a *prothorax* and a *pterothorax* that it is scarcely to be regarded as a unit in the organization of the body. The box-like structure of the combined mesothorax and metathorax, the oblique slant of the pleurites of these segments, and the firm connection of the first abdominal segment with the metathorax are characters evidently correlated with the development of the hind legs as saltatorial organs.

THE CERVICAL SCLERITES

The grasshopper ordinarily keeps its head retracted against the prothorax, in which position the insect appears to have no neck, for the ample neck membrane (fig. 20 B, *Cv*), as well as the back part of the head, is thus concealed within the projecting anterior rim of the pronotum.

The neck skeleton of *Dissosteira* consists of two pairs of small *cervical sclerites* situated ventro-laterally in the membranous walls of the neck (fig. 20 B, *1cv*, *2cv*). The two sclerites of each pair in the grasshopper are closely hinged to each other, and form a bridge on each side between the head and the prothorax. The first sclerite (*1cv*) is an irregularly triangular plate articulating with the occipital condyle (fig. 32, *g*) of the posterior rim of the head, situated just above the base of the posterior tentorial arm (*A*, *PT*). Immediately behind its articulation this plate bears externally two small lobes that are conspicuous by their covering of short hairs. The second cervical sclerite (fig. 20, B, *2cv*) is a slender bar articulating posteriorly with the anterior margin of the prothoracic episternum (*Eps*) just within the overlapping edge of the protergum. The two cervical sclerites of each pair are movably hinged to each other at an angle directed ventrally. They are mostly concealed when the head is in the usual retracted position, but they form a small prominence of the neck projecting just behind the base of the maxilla. The probable function and mechanism of the cervical sclerites will be described in connection with the account of the muscles inserted upon them.

The lateral, muscle-bearing cervical sclerites are probably homologous structures in all insects in which they occur. Dorsal and ventral neck plates are present in some insects, but they are variable in size and arrangement and are probably secondary sclerotizations of the neck membrane.

THE PROTHORAX

The prothorax of the grasshopper is a highly individualized segment of the body, for, though its posterior dorsal and lateral parts widely overlap the anterior part of the mesothorax, it is separated from the latter by an ample intersegmental membrane (fig. 20 B, *Mb*).

The external parts of the prothorax comprise tergal, pleural, and sternal sclerites. The principal plate is the tergum, a large bonnet-like piece that covers the back and most of the sides of the segment (fig. 20 A, *T*). Only a corner of each pleuron shows externally: this is the small triangular lobe lying anteriorly between the base of the leg and the lower margin of the tergum (fig. 20 A, *Eps*). The rest of the pleuron is deeply invaginated within the lateral wall of the tergum (B, *Eps*). The prosternum consists of two sclerites in the ventral wall of the segment between the bases of the first legs (fig. 21 A, *S*, *Ss*), the anterior one connected by the precoxal bridges (*Acx*) with the pleura. The prothoracic legs appear to be inserted between the sternum and the lower edges of the tergum, but the lateral connections of

the legs are really with the inflected pleura covered by the tergal extensions. The procoxal cavities are "open" behind, that is, there are no postcoxal sclerotizations. Lying before the coxa of each leg in the articular membrane of the leg base is a small trochantal sclerite (fig. 20 A, *Tn*).

The protergum.—The tergum of the prothorax, besides covering the back and sides of its own segment, projects posteriorly over the dorsum of the mesothorax in a wide, triangular lobe which fits between the bases of the folded front wings. The top of the tergal bonnet

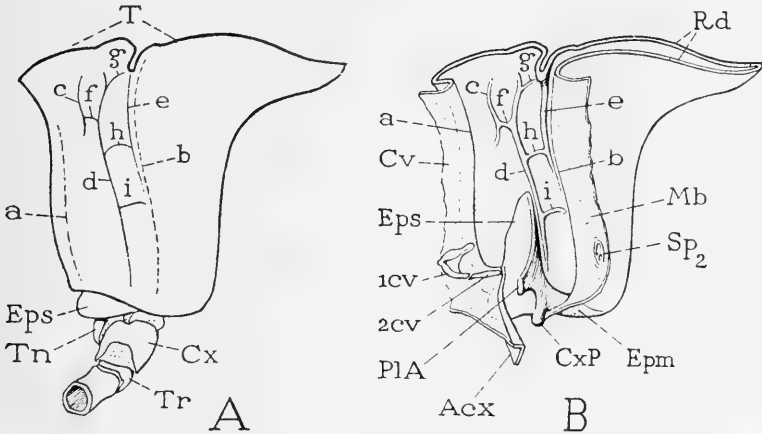

FIG. 20.—The prothoracic tergum and pleuron of *Dissosteira carolina*.

A, outer view of left side. B, inner view of right side, showing episternum invaginated within the tergum.

a, posterior edge of anterior fold of tergum; b, anterior edge of posterior fold (B, *Rd*) of tergum; c, d, e, the external vertical grooves or sutures of the tergum (A) forming the internal tergal ridges (B); f, g, h, i, horizontal sutures and their ridges connecting the vertical sutures and ridges.

(fig. 20 A, *T*) is cut by a deep transverse notch somewhat before the middle, and the part before the notch is compressed into a median ridge.

Each lateral area of the protergum is marked by a number of grooves forming a definite pattern, and by two non-impressed lines. The first non-impressed line (fig. 20 A, *a*) lies near the anterior border of the tergum and runs parallel with it; the second (*b*) extends downward in a sinuous course just posterior to the dorsal tergal notch. These two lines mark the limits of the inner folds of the anterior and posterior inflections of the tergal wall (B, *a*, *b*). The grooves of the tergal surface (A, *c-i*) lie in the space between the two non-impressed lines. They have no significance in themselves, but it is important to note

their positions because they form ridges on the inner surface (B) which have definite relations to the muscle attachments of the protergum. The first (*c*) is a short curved line on the upper lateral part of the tergum; the second (*d*) is a longer line extending from the back almost to the ventral margin of the tergum; the third (*e*) begins at the dorsal notch and reaches ventrally just before the second non-impressed line (*b*) to the middle of the side. Connecting the three vertical grooves are four short longitudinal grooves, one (*f*) lying between the first and second vertical grooves (*c*, *d*), the other three (*g*, *h*, *i*) between the second and third vertical grooves (*d*, *e*).

A study of the inner surface of the tergum (fig. 20 B) will show the endoskeletal ridges (*c-i*) formed by the external grooves. There

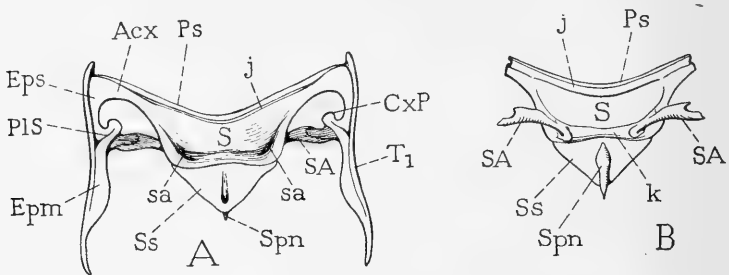

FIG. 21.—The prothoracic sternum and pleura of *Dissosteira*.

A, ventral view of sternum and lower edges of pleura, showing the spina-sternum (*Ss*) united with the segmental sternal plate (*S*), the latter continuous with the episterna (*Eps*) by the antecoxal bridges (*Acx*). B, dorsal surface of sternum, showing bases of sternal apophyses (*SA*, *SA*) united by a furcal ridge (*k*).

will also be noted the anterior and posterior inflections of the tergal walls. From the margin of the first inflection (*a*) the neck membrane (*Cv*) is reflected forward, and from the margin (*b*) of the posterior fold or reduplication (*Rd*) the intersegmental membrane (*Mb*) is reflected posteriorly to the mesothorax. The first spiracle (*Sp₂*) is located in this membrane.

The propleura.—We have already noted that each pleuron of the prothorax appears externally only as a small plate projecting from beneath the edge of the tergum anterior to the base of the leg (fig. 20 A, *Eps*). It is to be seen on the internal surface of either half of the segment (B), however, that the pleural piece exposed externally is merely the lower anterior corner of a much larger triangular sclerite (B, *Eps*) extended upward within the lateral tergal wall by a deep inflection of the tergo-pleural membrane. The posterior margin of the sclerite is turned inward, forming the pleural ridge, which gives off

the pleural arm (*PIA*) and ends ventrally in the articular process of the coxa (*CxP*). Behind the lower part of the pleural ridge is a small epimeral piece (*Epm*) fused with the lower border of the tergum and concealed just within the edge of the latter. The anterior ventral angle of the episternum is continuous through the precoxal bridge (*Acx*) with the anterior lateral angle of the prosternum (fig. 21 A).

The prosternum.—The sternum of the prothorax in the grasshopper consists of two distinct plates (fig. 21 A, *S*, *Ss*) separated by a transverse suture. The anterior plate (*S*) is the larger and the more strongly sclerotized. It is continuous laterally with the precoxal bridges (*Acx*) from the episterna (*Eps*). The definitive sternal plate of the prothorax, then, evidently includes laterosternal elements derived from the pleura (subcoxae), but the true pleuro-sternal limits are entirely obliterated. The anterior rim of the sternum is set off as a narrow presternal strip (*Ps*) by a submarginal external suture (*A*, *j*) and a corresponding internal ridge (*B*, *j*). Posteriorly the first sternal plate is marked by a deep transverse groove which forms a strong ridge on its inner surface (fig. 21 B, *k*) between the bases of the sternal apophyses (*B*, *SA*, *SA*), which latter are indicated externally by a pair of pits (*A*, *sa*, *sa*). The first prosternal plate in the grasshopper, therefore, is divided in the primitive fashion (fig. 18 C) into a basisternal and a sternellar region by the suture of a ridge connecting the bases of the apophyses. The prosternal apophyses are simple arms (fig. 21 B, *SA*) diverging dorsally and laterally. Their distal ends are solidly united with the corresponding pleural apophyses.

The second prosternal plate (fig. 21, *Ss*) is a spinasternite, and is, therefore, the intersternite between the prothorax and the mesothorax which has become closely associated with the primary sternite of the prothorax. It is mostly overlapped by the anterior margin of the mesosternum. The spinasternite of *Dissosteira* is triangular in shape, and is marked by a deep median impression (fig. 21 A) which forms the spina internally (*B*, *Spn*).

THE PTEROTHORAX

The united mesothorax and metathorax of the grasshopper constitute a unit in the body mechanism. The pleural and sternal walls of the two segments are solidly united, forming a trough-like structure perforated only by the openings of the coxal cavities. The leaping force of the hind legs is thus applied to a rigid middle section of the body, which also bears the wings. The dorsum of this body section is covered by the mesothoracic and metathoracic terga, but these plates

are freely attached to the upper pleural margins of the pterothoracic trough by the ample membranes of the wing bases, and they are movably joined to each other. As we shall later see, the wing mechanism demands at least a limited freedom of movement in the wing-bearing terga.

In the grasshopper the back plates of the pterothorax (figs. 22, 24) differ somewhat in shape and in details of form and proportion, but the two have the same essential structure. They are relatively small, and when the insect is at rest they are hidden beneath the folded wings. The pleurites are defined externally by distinct grooves (fig. 26) forming strong ridges internally (fig. 28), which slant posteriorly and downward in a manner to suggest that they serve thus to brace the pleural walls against the projectile force of the hind legs. The sterna of the wing-bearing segments are wide plates fused laterally with the pleura before the leg bases (fig. 30).

The mesotergum.—The tergum of the mesothorax (fig. 22 A) is a rectangular plate ending posteriorly in a distinct, transverse fold (*Rd*), the extremities of which are continued into the posterior thickened margins, or axillary cords (*Axc*), of the wing bases. Close to the anterior margin of the tergum is a deep groove (*acs*). This is the antecostal suture, or primary intersegmental inflection which forms the antecosta of the internal surface of the definitive tergum (*B, Ac*). The antecosta bears laterally two wide, flat apodemal plates (*iPh*) projecting into the cavity of the thorax (fig. 25), which are the first pair of thoracic phragmata.

On the external surface of the mesotergum, two sutures (fig. 22 A, *ps, ps*) diverge laterally and posteriorly from the antecostal suture (*acs*). They form internally a pair of strong ridges (*B, PR*) extending to the bases of the anterior wing processes (*ANP*). The large, irregular, triangular regions (*A, Psc, Psc*) forming the anterior lateral angles of the tergum, set off by the divergent sutures (*ps, ps*), constitute the prescutal areas of the tergum. In the metathorax the prescutal sutures do not meet the antecostal suture, and the lateral prescutal lobes are continuous by a narrow median bridge behind the antecostal suture (fig. 24). In some other Acrididae, as in *Melanoplus*, the continuity of the prescutal area is more pronounced. In other orthopteran families the prescutum is narrow, but in the Blattidae and Gryllidae there is a suggestion of its separation from the scutal area. In any case, however, the prescutum of the Orthoptera must be regarded as a secondary differentiation of the anterior part of the tergum. Its lateral parts become most sharply defined in the mesotergum of the Acrididae by the strong development of the prescutal ridges (fig.

22 B, *PR*) that brace the anterior wing processes. Upon the irregular surfaces of the prescutal lobes are attached the tergo-sternal muscles which are the principal elevators of the wings.

A prescutum similar to that of the Orthoptera occurs also in certain other insects, though very likely it may be an independent differentiation formed as an adaptation to similar demands. In many insects of the higher orders, however, such as the Hemiptera, Diptera, and Hymenoptera, a prescutal area of quite a different nature is set off in the anterior median part of the tergum by the development of two

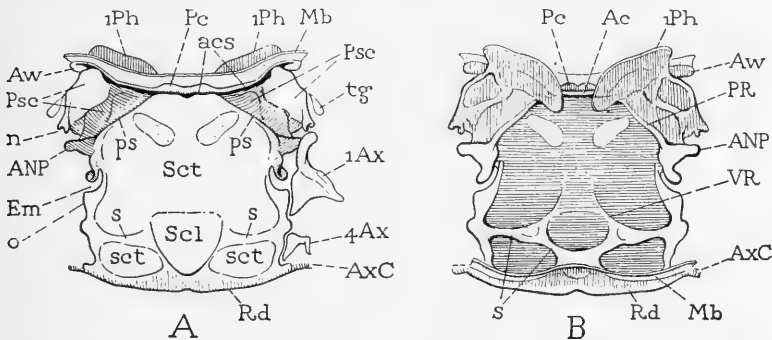

FIG. 22.—The mesothoracic tergum of *Dissosteira*.

A, dorsal surface. B, ventral surface. *Ac*, antecosta; *acs*, antecostal suture; *ANP*, anterior notal wing process; *Aw*, prealar arm of tergum; *1Ax*, first axillary; *4Ax*, fourth axillary; *AxC*, axillary cord; *Em*, lateral emargination of tergum; *Mb*, secondary intersegmental membranes; *n*, lobe of prescutum articulating with base of subcostal wing vein; *o*, lobe of scutum articulating with posterior part of first axillary; *Pc*, precosta; *1Ph*, first phragma; *ps*, prescutal suture; *Psc*, *Psc*, lateral prescutal areas; *Rd*, posterior reduplication of tergum; *Scl*, scutellum; *Sct*, principal part of scutum; *sct*, *sct*, posterior lateral subdivisions of scutum; *s*, *s*, secondary ridges of tergum; *tg*, tegular rudiment; *VR*, remnant of V-ridge of tergum.

lateral ridges, the parapsidal gradients (fig. 5 B, *PaR*), which extend a varying distance posteriorly from the anterior tergal margin, and usually converge. These ridges and their sutures apparently lie in the scutal region of the tergum, for there is sometimes present a narrow transverse prescutal band anterior to their bases. Parapsidal ridges are absent in the Orthoptera.

The area of the mesotergum of *Dissosteira* posterior to the antecostal and prescutal sutures is differentiated topographically into a large anterior scutal region (fig. 22 A, *Sct*), a median, posterior, triangular scutellar region (*Scl*), two small, lateral, posterior scutal regions (*sct*, *sct*), and a posteriormost, deflected marginal region (*Rd*). The structure here presented is quite different in appearance from that of a typical wing-bearing tergum (fig. 5 A) in which the surface

is divided into scutal and scutellar areas (*Sct*, *Scl*) by the suture (*vs*) of an internal V-shaped ridge (*B*, *VR*), the arms of which are convergent forward from the posterior lateral angles of the tergum.

In the Acrididae the V-shaped endotergal ridge (fig. 22 *B*, *VR*) is almost obliterated, and the tergum is braced by two secondary ridges, one on each side (*s*), that converge posteriorly from the posterior lateral margins of the scutal area and intercept the arms of the rudimentary V-ridge (*VR*). The altered structure of the acridid tergum

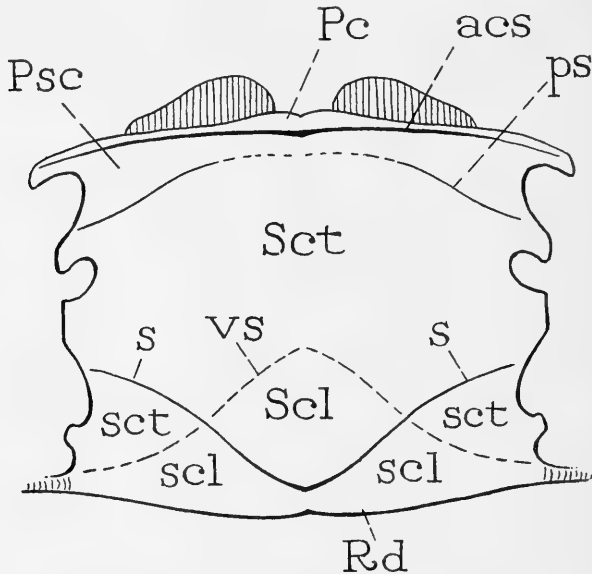

FIG. 23.—Diagram of the structure of a wing-bearing tergum of Acrididae.

The prescutal suture (*ps*) is either continuous, or suppressed medially; the usual V-ridge and its suture (*vs*) are partially suppressed and subordinated to a secondary ridge of similar shape but having its arms (*s*, *s*) convergent posteriorly.

may be expressed diagrammatically as in figure 23, where the suppressed suture (*vs*) of the obsolete V-ridge is crossed by the dominant suture (*s*) of a secondary ridge of similar shape but having its arms convergent posteriorly. Thus the scutum consists of a principal anterior scutal area (*Sct*) and of two small postero-lateral scutal areas (*sct*, *sct*); and the scutellum is divided into a median scutellar area (*Scl*) and two lateral scutellar areas (*scl*, *scl*), including the posterior fold of the tergum (*Rd*). The evolution of this condition can be traced in other Orthoptera from the primary structure which occurs in the Blattidae. A similar modification has taken place in the mesotergum of Hemiptera and Coleoptera, producing the triangular elevated shield of the scutellum that lies between the bases of the folded wings.

It is clear that the external "divisions" of the wing-bearing tergum are incidental to the development of the internal ridges, which are adaptations to the part the tergum plays in the mechanism for moving the wings. The old idea that the tergum is "composed of" sclerites gave undue emphasis to surface features. Though a study of the latter may have a value for descriptive purposes, the student must look to the internal characters for a true understanding of the skeleton of insects.

There is no postscutellar plate in the mesothorax of the grasshopper. The posterior deflected margin of the scutellum ends in a narrow intersegmental membrane (fig. 25, *2Mb*) uniting the mesotergum with the anterior margin of the precosta of the metatergum. The tergum of the mesothorax of the grasshopper, therefore, is a typical dorsal plate of a secondary segment, comprising the primary segmental sclerotization and the preceding primary intersegmental sclerotization of the back. In the latter the primary intersegmental fold is marked by the antecosta (fig. 25, *Ac*) and the antecostal suture (*acs*).

The lateral margins of the mesotergum are very irregular (fig. 22). The wings are extended from the tergal edges between the middle of the prescutal borders and the posterior reduplication of the scutellum. Anterior to the wing bases the anterior angles of the tergum are extended as short prealar arms (fig. 22 A, *Aw*) to which are articulated the dorsal processes of the first basalar plates (fig. 26, *Ba*). The lateral margin of the prescutal area forms posteriorly a small process bearing a socket-like surface (*n*) in which the base of the subcostal wing vein turns when the wing is flexed or extended. Posterior to this process the anterior angle of the scutum is produced to form the large *anterior notal wing processes* (*ANP*), which support the neck of the first axillary sclerite of the wing base (*1Ax*). The inner edge of the first axillary bridges the *lateral emargination* of the tergum (*Em*) and articulates with a marginal lobe (*o*) behind the latter. There is no posterior notal wing process in the mesotergum of the grasshopper; the fourth axillary (*4Ax*), which is itself probably a detached piece of the tergal margin, articulates with the edge of the scutellum.

The metatergum.—The tergal plate of the metathorax (fig. 24) is somewhat longer than that of the mesothorax, since it must support the wider bases of the hind wings; but in many respects it is more weakly developed than the mesotergum, there being extensive non-sclerotized areas in the posterior part of the scutal region.

The precostal rim of the metatergum (fig. 24, *Pc*) is narrow, except medially where it forms a conspicuous lip before the deeply inflected

antecostal suture (*acs*). The prescutal ridges and their sutures (*ps*, *ps*) are much weaker than those of the mesotergum, but they are not confluent medially with the antecostal ridge and suture, and the lateral prescutal triangles (*Psc*, *Psc*) appear to be continuous across the back in a narrow, weakly sclerotized area deflected into the antecostal suture (*acs*).

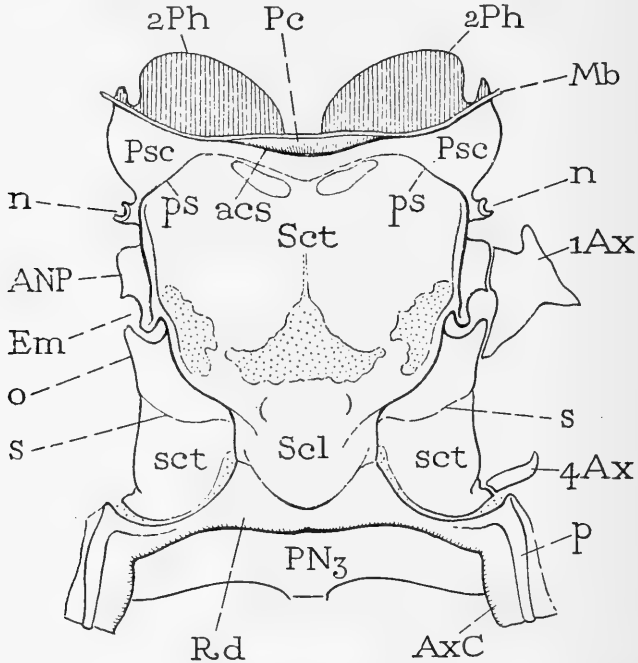

FIG. 24.—The metathoracic tergum and postnotal plate of *Dissosteira*.

acs, antecostal suture; *ANP*, anterior notal wing process; *1Ax*, first axillary; *4Ax*, fourth axillary; *AxC*, axillary cord; *Em*, lateral emargination of tergum; *n*, prescutal lobe to which base of subcostal wing vein is attached; *o*, tergal lobe to which posterior end of first axillary articulates; *p*, tergal arm supporting anal veins of wing (see fig. 47 B); *Pc*, precosta; *2Ph*, second phragma; *PN₃*, postnotum; *ps*, prescutal suture; *Psc*, prescutum; *Rd*, posterior fold of tergum (see fig. 25, *Rd_i*); *s*, *s*, sutures of secondary tergal ridges; *Scl*, scutellum; *Sct*, principal part of scutum; *sct*, *sct*, subdivisions of scutum.

The surface features of the scutal and scutellar regions of the metatergum have even less relation to the generalized structure of a wing-bearing tergum than do those of the mesotergum, because the tergal ridges (fig. 23) are here almost completely suppressed, and the external characters are the result of secondary inflections which produce a topographical pattern quite independent of the primary divisions of the tergum (fig. 5). Most of the scutal region (fig. 24, *Sct*) and the

median triangle of the scutellar region (*Scl*) are confluent in a large shield-shaped area that forms the principal part of the tergal plate. The depressed posterior lateral parts of the scutum (*sct*, *sct*) are cut transversely by the faintly-marked sutures (*s*, *s*) of the posteriorly convergent ridges, which are obsolete in the metatergum, though strongly developed on the mesotergum (fig. 22 B, *s*). The posterior marginal area of the metatergum (fig. 24, *Rd*), which is a part of the true scutellar region, is sharply inflected (fig. 25, *Rd*₃) and is continuous with the greatly extended precosta of the first abdominal segment, which constitutes a postnotal plate of the metathorax (figs. 24, 25, *PN*₃).

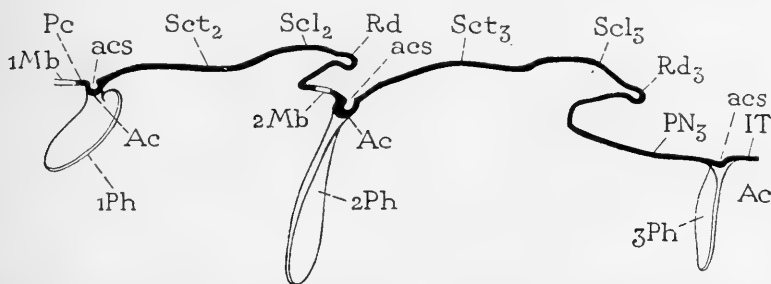

FIG. 25.—Median longitudinal section of mesotergum, metatergum, and meta-thoracic postnotal plate of *Dissosteira*, showing the phragmatal lobes of the right side.

Ac, antecosta; *acs*, antecostal suture; *IT*, first abdominal tergum; *1Mb*, *2Mb*, secondary intersegmental membranes; *1Ph*, *2Ph*, *3Ph*, first, second, and third phragmata; *PN*₃, postnotal plate of metathorax, or greatly enlarged precosta of first abdominal tergum; *Rd*, posterior reduplication of tergum; *Sct*, scutum; *Scl*, scutellum.

The lateral margins of the metatergum present the same features as do those of the mesotergum. The posterior angle of each prescutal area projects as a small marginal process (fig. 24, *n*) which is connected with the head of the subcostal wing vein by a ligament-like thickening of the basal wing membrane; it does not articulate with the vein as in the mesothorax. The anterior notal wing process (*ANP*) is a flat lobe of the scutum, to which the first axillary (*1Ax*) is closely hinged. Behind the wing process is a deep emargination (*Em*) of the scutellum, posterior to which is a second lobe (*o*) articulating with the posterior end of the first axillary. The slender fourth axillary (*4Ax*) articulates with the extreme posterior angle of the lateral scutellar area (*sct*). Each extremity of the posterior marginal fold of the tergum (*Rd*) gives off into the anal membrane of the wing a long arm (*p*) that supports the anal veins (fig. 47 B).

The pterothoracic pleura.—The pleurites of each side of the mesothorax and metathorax are firmly united to form continuous lateral walls of the pterothoracic region (fig. 26) in which the episterna and epimera (*Eps*, *Epm*) are distinct plates separated by oblique grooves sloping from above downward and posteriorly. The first principal groove is the pleural suture of the mesothorax (*PIS*₂), the second is the intersegmental line, the third is the pleural suture of the metathorax (*PIS*₃). Each pleural suture terminates above in a large wing

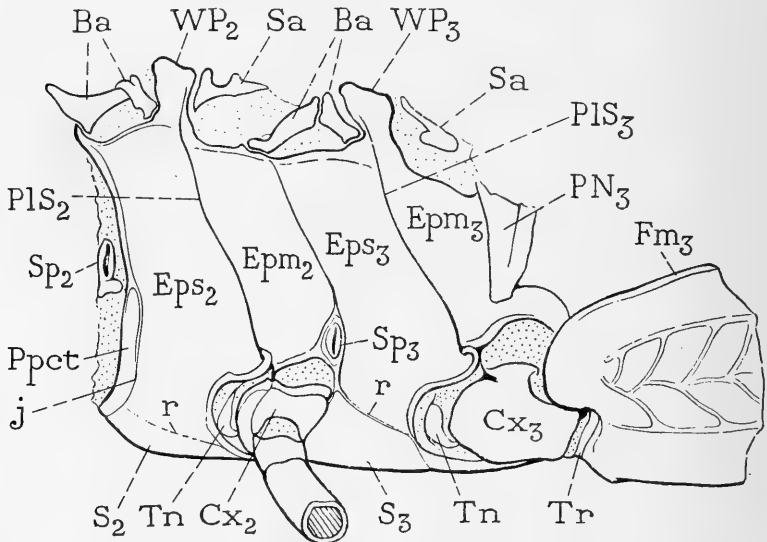

FIG. 26.—The pterothoracic pleura of *Dissosteira*.

Ba, basal sclerites; *Cx*, coxa; *Epm*, epimeron; *Eps*, episternum; *Fm*₃, base of hind femur; *j*, prepectal suture; *PIS*, pleural suture; *PN*₃, lateral arm of metathoracic postnotum; *Ppct*, prepectus; *r*, pleuro-sternal suture; *S*, sternum; *Sa*, subalare; *Sp*₂, mesothoracic spiracle; *Sp*₃, metathoracic spiracle; *Tn*, trochantin; *Tr*, trochanter; *WP*, pleural wing process.

process (*WP*₂, *WP*₃), and below in the pleural articulation of the coxa. The episternum of each segment (*Eps*₂, *Eps*₃) is united ventrally before the coxal cavity with the edge of the sternum, the line of union (*r*) in the adult insect being obsolete in the mesothorax, but distinct in the metathorax. In the nymph of *Dissosteira* and of other Acrididae (fig. 27 A) the ventral edge of the precoxal part of the pleuron in both the mesothorax and the metathorax is distinctly separated from the sternum; in the nymph of *Gryllus* (B) a precoxal plate (*Acx*) is separated from the pleuron and intervenes between the episternum and the sternum. The episternum of the mesothorax of *Dissosteira* (fig. 26, *Eps*₂) is marked anteriorly by a submarginal

suture (*j*) which is continuous through the anterior part of the mesosternum (S_2) and sets off from the sternum and the two episterna a narrow anterior marginal piece, or *prepectus* (*Ppct*), which is analogous to the similar sclerite of the Ichneumonidae and some other Hymenoptera. To the posterior margin of the epimeron of the metathorax (Epm_3) is attached the large lateral extension of the metathoracic postnotum (PN_3).

The two pairs of spiracles of the thorax are presumably the mesothoracic spiracles and the metathoracic spiracles, each pair being displaced anteriorly. The first spiracle on each side (fig. 26, $S\beta_2$) is

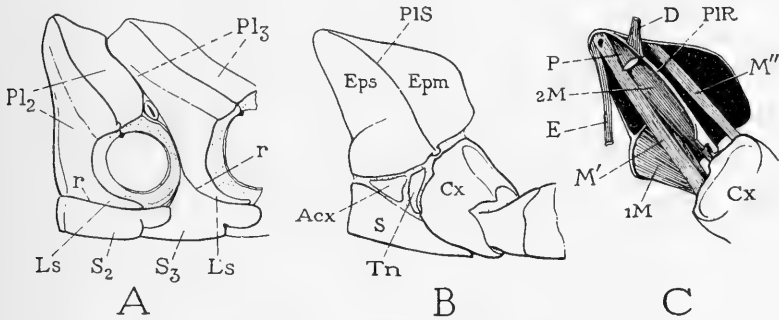

FIG. 27.—Pterothoracic pleura of orthopteran nymphs.

A, pterothoracic pleura of an acridid nymph, showing laterosternal arms of pleura (*Ls*) separated from sternum (S_2, S_3) by the pleuro-sternal sutures (*r, r*). B, mesopleuron and coxa of young nymph of *Gryllus assimilis*, showing a distinct precoxal sclerite (*Acx*) between episternum (*Eps*) and sternum (*S*). C, inner view of B, showing the basalar and subalar muscles of the nymph (*M', M''*) attached dorsally on edges of episternum and epimeron, respectively.

situated laterally in the intersegmental membrane between the prothorax and the mesothorax, where it is covered by the posterior fold of the protergum. The second spiracle (fig. 26, $S\beta_3$) appears in the adult to lie in the lower posterior angle of the mesepimeron (Epm_2) just above the base of the middle leg, and anterior to the fold between the mesothorax and the metathorax (fig. 28), but in the nymph (fig. 27 A) it occurs in the intersegmental fold.

The structural pattern of the internal surface of the pleural wall of the pterothorax (fig. 28) is a replica of that of the outer surface, except that the impressed lines of the latter are represented by ridges. Each pleural ridge (PIR_2, PIR_3), however, gives off from its lower end a large pleural arm, or pleural apophysis (PIA_2, PIA_3), that projects inward across the coxal cavity, where it is closely associated with the lateral arm of the corresponding sternal apophysis (fig. 31,

PLA, SA), and the two are connected by a dense mass of short muscle fibers (figs. 34, 35, 86, 115).

Of particular interest in the pterothoracic pleuron are the *epipleurites*, or the small plates situated in the membranes below the bases of the wings (figs. 26, 28, 29, *Ba, Sa*). Upon these plates are inserted the principal so-called *direct* muscles of the wing mechanism. In the grasshopper there are three epipleurites in each segment, two (*Ba*)

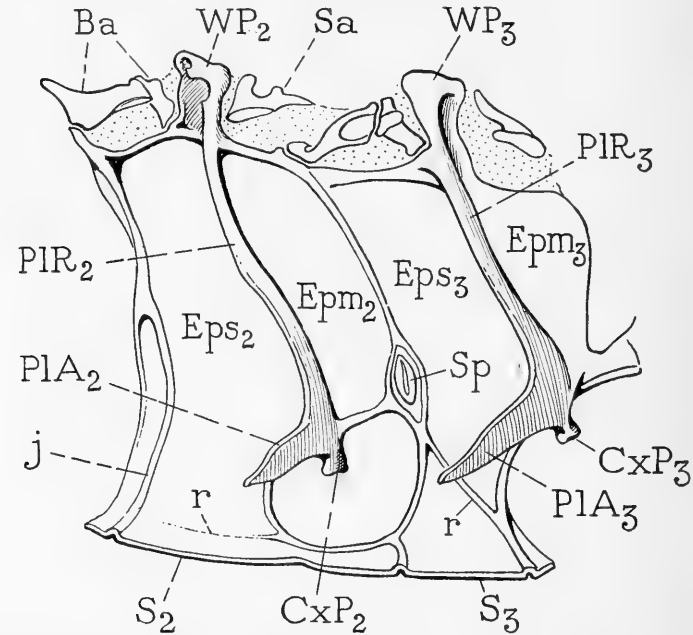

FIG. 28.—Inner surface of right pterothoracic pleura of *Dissosteira*, showing the endoskeletal features.

Lettering as on figure 26, with the following additions: *CxP*, pleural coxal process; *PLA*, pleural arm; *PIR*, pleural ridge.

situated before the wing process and articulated to the episternum, and one (*Sa*) in the membrane behind the wing process and above the epimeron. The episternal epipleurites are distinguished as the *basalares*, or *basalar sclerites* (*Ba*), the epimeral epipleurite as the *subalar* or *subalar sclerite* (*Sa*). In most insects there is but a single basalare. In *Dissosteira* the basalare sclerites are freely hinged to the upper margin of the episternum before the wing process (fig. 29, *1Ba, 2Ba*) so that they can be turned inward and downward by the muscle inserted on their inner faces (fig. 49, *E, M'*). The function of the epipleurites in connection with the movement of the wings will be described in Section V.

There can be little doubt that the epipleurites are derived from the upper parts of the pleura. In a nymphal orthopteron the muscles that are inserted on the epipleurites in the adult (fig. 49) are attached directly to the upper edges of the episternum and epimeron (fig. 27 C, *M'*, *M''*). In many adult insects the basalare remains as an undetached lobe of the episternum (fig. 14 A, *Ba*).

In the membranous corium at the base of each leg there is a small plate (fig. 26, *Tn*) situated before the coxa and loosely attached by its lower end to the rim of the coxa. These scierites are evidently remnants of the trochantins (fig. 13 A, B, *Tn*) since they exactly cor-

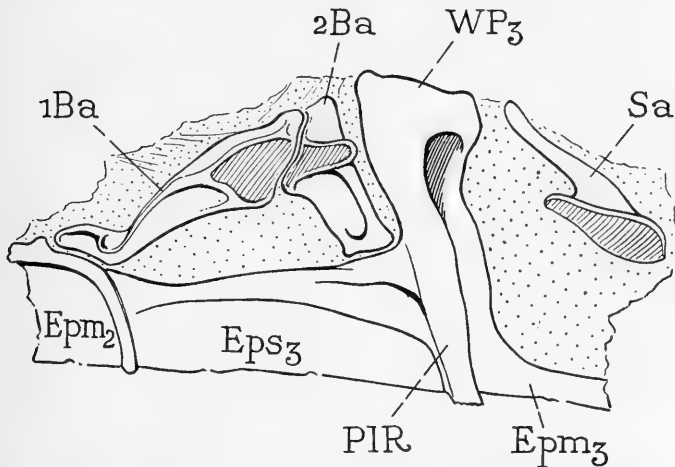

FIG. 29.—Upper edge of the metathoracic pleuron and epipleurites of *Dissosteira*, inner view.

1Ba, first basalare; *2Ba*, second basalare; *Epm*, epimeron; *Eps*, episternum; *Sa*, subalare; *WP*, pleural wing process.

respond with the small trochantin of the prothorax (fig. 20 A, *Tn*), which is identified as such by the attachment of the promotor leg muscle upon it (fig. 33 A, *62*).

The pterothoracic sterna.—The sternal plates of the mesothorax and metathorax are united in a broad plastron covering the ventral surface of the pterothorax, and continuous laterally, in the adult, with the pleura by a fusion with the precoxal parts of the latter (fig. 30 A). In the nymph of *Dissosteira* and of other Acrididae, as already noted, the pleural plates of the mesothorax and metathorax (fig. 27 A, *Pl*₂, *Pl*₃) are distinctly separate from the sterna (*S*₂, *S*₃), and the precoxal part of each pleuron is extended ventrally and posteriorly as a slender arm (*Ls*, *Ls*) between the sternum and the coxal corium. These arms are clearly remnants of the infra-coxal arcs of the sub-

coxae (fig. 18 B). In the adult grasshopper they form the ventral rims of the coxal cavities, that of the mesothorax becoming a weakly sclerotized plate, that of the mesothorax a membranous fold. The definitive sterna of the pterothorax in the Acrididae, therefore, do not appear to contain subcoxal laterosternal elements as integral parts of their areas. In the adult of *Dissosteira* the pleuro-sternal suture (fig. 30 A, *r*) is obsolete in the mesothorax anterior to the coxa, but remains distinct in the metathorax.

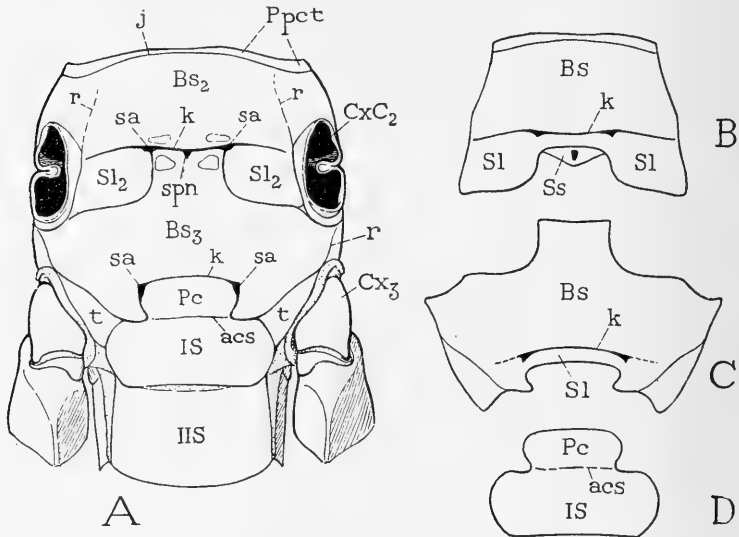

FIG. 30.—Pterothoracic sterna and the base of the abdomen of *Dissosteira*.

A, general view of pterothoracic sterna and first two abdominal sterna. B, diagram of probable structure of mesosternum. C, diagram of probable structure of metasternum. D, diagram of structure of first abdominal sternum.

acs, antecostal suture of first abdominal sternum; *Bs*, basisternum; *Cx*, coxa; *CxC*, coxal cavity; *IS*, *IIS*, first and second abdominal sterna; *j*, prepectal suture; *k*, furcal suture; *Pc*, precosta; *Ppct*, prepectus; *r*, *r*, pleuro-sternal sutures; *sa*, *sa*, roots of sternal apophyses; *Sl*, sternellum; *t*, *t*, infra-coxal lobes of metasternum.

The mesosternum of *Dissosteira* is a broad plate (fig. 30 A, *Bs*₂, *Sl*₂) bounded laterally by the obsolete lines of the pleuro-sternal sutures (*r*) and the rims of the coxal cavities. Its anterior edge is slightly convex; its posterior border is deeply emarginated to receive a median rectangular extension of the mesosternum (*Bs*₃) which is dove-tailed into the mesosternal notch. A prominent transverse suture (*k*), which forms internally a ridge through the bases of the sternal apophyses and extends laterally toward the coxal cavities (fig. 31, *k*, *k*) is coincident with the posterior edge of the median part of the sternum and

contains the external impressions of the sternal apophyses (fig. 30 A, *sa, sa*). The suture, therefore, is the furcal suture of the mesosternum, and the two postero-lateral, quadrate mesosternal lobes (Sl_2 , Sl_2) lying laterad of the median projection of the metasternum must belong to the sternellar region of the mesosternum. A median pit (*spn*) opening just behind the furcal suture (*k*) marks the site of the internal spina (fig. 31, $2Spn$), which normally is intersegmental between the mesosternum and the metasternum, but which is here fused with the mesosternal furcal ridge (*k*). There can be no doubt, therefore, that a part of the mesosternum normally intervening between the furcal ridge and the spinasternum, which is the median area of the mesosternellum (fig. 30 B, *Sl*), has been obliterated in *Dissosteira*, and that the spinasternum itself has been reduced to little more than the base of the spina.

The mesosternum of *Dissosteira* is thus to be analyzed into the same structural elements that are preserved in a less modified form in the prosternum. The sternellar region of the sternum (fig. 30 B, *Sl, Sl*) has been cut into a pair of lateral lobes (A, Sl_2, Sl_2) by the suppression of its median area, and the following spinasternum (B, *Ss*) has been reduced to the base of the spina (fig. 31, $2Spn$), which is united with the furcal ridge (*k*).

The endoskeletal features of the mesosternum consist principally of the strong furcal ridge (fig. 31, *k, k*) and the two sternal apophyses (*SA, SA*). The latter are broad, tapering plates arising from thick bases and extending laterally beneath the pleural apophyses, to which they are attached by short muscle fibers (figs. 34, 35, *86*). Each has a triangular basal lobe directed forward. Anteriorly the mesosternum is marked by the sternal part of the prepectal ridge (fig. 31, *j*) which cuts off a marginal presternal strip continuous laterally with the pre-episternal areas of the prepectus (figs 26, 30, *Ppct*).

The metasternum of *Dissosteira* (fig. 30 A, Bs_2) is wider than the mesosternum and is separated laterally by distinct sutures (*r*) from the precoxal parts of the metapleura. Its anterior margin, as just observed, is extended in a large, median, quadrate lobe which is dove-tailed between the scutellar lobes of the mesosternum. Its posterior edge is broadly emarginate to receive a corresponding extension of the first abdominal sternum (*Pc*). The median scutellar region of the metasternum, shown diagrammatically at C of figure 30, is suppressed in the same manner as is that of the mesosternum, and the suture of the transverse sternal ridge (*k*) is here also coincident with the transverse margin of the sternal notch; but the suture does not extend laterad of the apophyses (*sa, sa*), and the lateral sternellar lobes are, therefore,

not set off by sutures as in the mesosternum. The small triangular plates (*t*, *t*) bordering the coxal cavities appear to be subdivisions of the sternellar lobes rather than subcoxal laterosternal pieces, since the ventral arms of the pleurites in the nymph (fig. 27 A, *Ls*) form only the membranous folds beneath the coxal cavities in the metathorax.

There is no spina associated with the metasternum. Crampton (1918) says the spinal pit has disappeared from the metasternum, but he gives no evidence of its former existence. As we have seen, the intersternal sclerotization between the metasternum and the first abdominal sternum remains as an integral part of the latter, or disappears

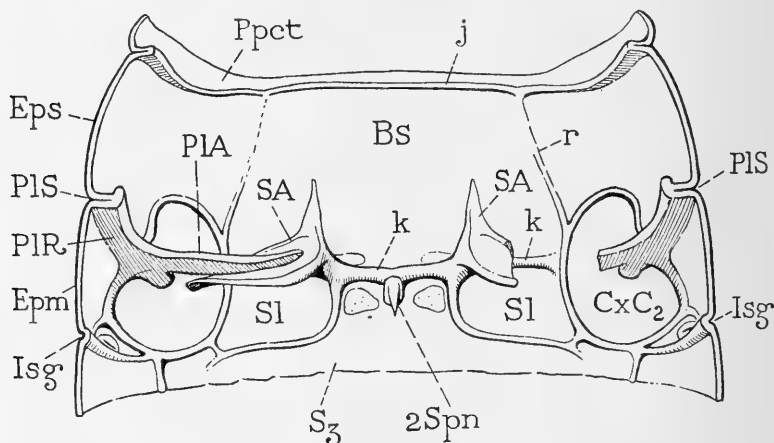

FIG. 31.—Inner surface of ventral pleuro-sternal region of mesothorax.

Bs, basisternum; *Cx C2*, coxal cavity; *Epm*, epimeron; *Eps*, episternum; *Isg*, intersegmental groove; *j*, ridge of prepectal suture; *k*, furcal ridge; *PIA*, pleural arm; *PIR*, pleural ridge; *PLS*, pleural suture; *Ppct*, prepectus; *S3*, anterior part of metasternum; *SA*, sternal apophysis; *Sl*, sternellum; *2Spn*, second spina, united with furcal ridge of mesosternum.

when the first abdominal sternum becomes rudimentary. In *Dissosteira* the ventral muscles of the first abdominal segment (fig. 35, *IS*) are attached anteriorly on a weakly developed ridge (*Ac*) which crosses the first abdominal sternum between the angles of the sternellar lobes of the metasternum. The line of this ridge appears externally as a faint transverse suture (fig. 30 A, D, *acs*). The ridge (fig. 35, *Ac*), therefore, is the antecosta of the first abdominal sternum, and the representative of the spinae of the prothoracic and metathoracic sterna. The median plate dovetailed into the metasternum (figs. 30 A, D, 35, *Pc*) is the enlarged precosta of the first abdominal sternum. It corresponds exactly with the postnotal plate of the metathorax (fig. 25, *PN3*), which is an extension of the precosta of the first abdominal tergum.

III. THE THORACIC MUSCLES OF DISSOSTEIRA

The evolution of insect structure has been largely an evolution of mechanisms made up of the cuticula and the muscles. Though the study of the insect skeleton will remain the most important branch of insect anatomy for purposes of taxonomic description, it is becoming evident that the morphology of the skeleton is not to be understood without a knowledge of the relations that exist between the cuticular modifications and the muscles. Systematists and anatomists have consumed much time and have occupied much printed space with discussions of homologies between sclerites, which, in many cases, are of little value because the fundamental structure of the parts in question has not been studied and because mechanical relationships have been entirely ignored. The time is at hand when we must understand insects as living creatures rather than as museum specimens. Morphology must become a basis for the study of function, including both the physiological processes by which the insect is maintained as a living thing, and the mechanisms by which it directs its bodily activities.

A grasshopper furnishes a particularly good subject for the study of insect musculature. Not only are the individual muscles easily distinguished in dissections, but the muscles present are principally those that are common to all generalized insects. Fresh specimens do not serve well for the purpose of muscle study, but after twenty-four hours' immersion in 80 per cent alcohol the fiber bundles become more compact and are more readily seen as separate muscles. Since most of the insect's muscles are arranged laterally, a median sagittal section of the body will give the best approach to the muscles for an initial examination; but eventually it will be necessary to cut specimens into numerous pieces, for each muscle must be followed from one attachment to the other. Never accept a supposed observation for a fact until it is seen alike in at least two preparations—not that specimens differ, but that observations frequently do.

It is customary in describing muscles to follow them from their origins (fixed ends) to their insertions (movable ends), but the muscles of insects are in general more easily *studied* by finding the insertion points first and then tracing the bundles of fibers out to their basal attachments. The origins of muscles are likely to vary more in different segments and in different species than are the insertions, and branched muscles are often confusing until their common parts or apodemes of insertion are determined.

The student will find that the principal thoracic muscles of *Dissosteira* more nearly correspond with the description of the muscles of the field cricket, *Liogrillus (Acheta) campestris*, given by Carpen-

tier (1923) than with the description of the muscles of *Gryllus domesticus* given by Voss (1905). The musculature of the cricket is in some respects more elaborate than that of the locust; but the extra fibers constitute small and apparently secondary muscles that are not definitely repeated in insects generally. The account of the musculature of *Gryllus pennsylvanicus* given by DuPorte (1920) contains inaccuracies, especially with regard to the muscles of the legs; the leg muscles of *Gryllus* are in no essential way different from those of *Dissosteira*.

No attempt will be made in this paper to homologize the muscles of *Dissosteira* with those of other insects, or to correlate them with the muscles described by other writers, since this would add too much to the size of the paper. The student, however, should consult the recent descriptions of the thoracic musculature of insects contained in the works of Bauer (1910, 1924, adult *Dytiscus*), Speyer (1922, 1924, larval *Dytiscus*), Carpentier (1923, *Acheta campestris* and *Tachycinus asynamorus*), Weber (1927, *Tenthredinidae*; 1924, 1928, Lepidoptera; 1928a, *Aphis fabae*; 1929, *Psylla mali*), and Morison (1927, *Apis mellifera*). Berlese's (1909) review of the musculature of insects will need some revision in the light of more extensive comparative studies of insect muscles; but a general myology of insects can not yet be undertaken since we need more extensive information concerning such groups as Apterygota, Plecoptera, and Neuroptera.

The terminology of insect musculature offers some difficulty for the reasons that in different species the number of muscles in a functional group is variable, the attachments may shift from one point to another, and the functions of muscles undoubtedly homologous are often changed as a consequence of altered relations in the skeletal parts. In the following description of the thoracic musculature of the grasshopper individual muscles are designated numerically for convenience of reference only, and the series of numbers (46 to 139) follows the enumeration of the head muscles of *Dissosteira* given in a former paper by the writer (1928).

Dissection of the thoracic muscles is simplified when the general plan of the segmental musculature is understood. The thoracic muscles of insects fall into a few major groups which, in a general way, are as follows: (1) dorsal body muscles; (2) ventral body muscles; (3) tergo-sternal muscles; (4) special wing muscles; (5) pleuro-sternal muscles; (6) coxal wing muscles; (7) body leg muscles; (8) muscles of the leg segments; (9) muscles of the spiracles. In addition there are the muscles of the neck plates, and often oblique, lateral intersegmental muscles.

MUSCLES OF THE NECK AND PROTHORAX

The prothoracic and neck muscles of the grasshopper are best studied from the mesal plane of the body. They may be exposed by cutting into lateral halves a specimen that includes the back of the head, the prothorax, and the mesothorax. Before removing the alimentary canal, a branched muscle should be observed going from the side of the protergum to the crop and the gastric caeca, which is,

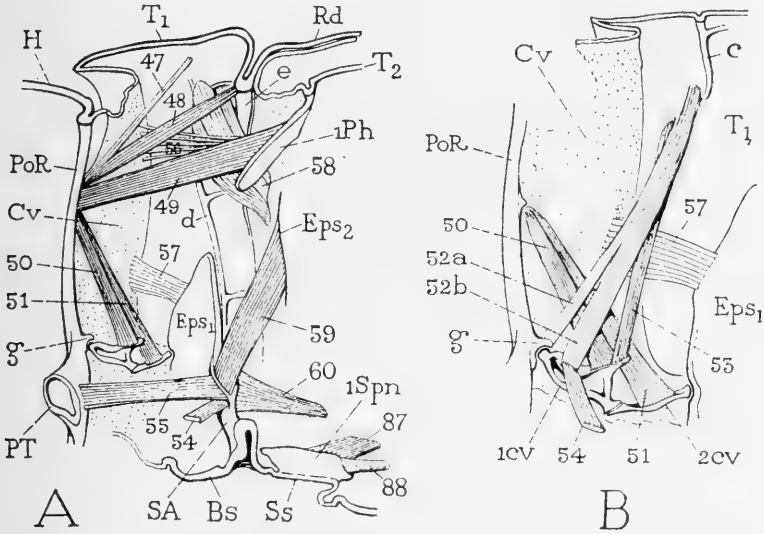

FIG. 32.—Muscles of the neck of *Dissosteira*, right side, internal view.

A, muscles extending between head and prothorax, omitting 52, 53, and 54, shown in B, inserted on first cervical sclerite. B, muscles of cervical sclerites. Bs₁, basisternum of prothorax; c, first ridge of protergum; Cv, neck; 1cv, first cervical sclerite; 2cv, second cervical sclerite; d, second ridge of protergum; c, third ridge of protergum; Eps₁, prothoracic episternum; Eps₂, mesothoracic episternum; g, process of head articulating with first cervical sclerite; H, head; iPh, first phragma; PoR, postoccipital ridge of head; PT, base of posterior tentorial arm; Rd, posterior fold of protergum; SA, prosternal apophysis; 1Spr, first spina; Ss, spinasternum; T₁, protergum.

46. *Posterior protractor of the crop and gastric caeca* (fig. 33 A).—A slender, branched muscle arising on lateral surface of protergum from lower end of first tergal ridge (c) just before base of tergal promotor of coxa (62); branching posteriorly to lateral wall of crop and tips of gastric caeca.

The alimentary canal and fat tissue should now be removed in order to expose the muscles in the side of the neck and prothorax, some of which extend from the mesothorax to the head. Functionally there are three groups of these muscles, namely, those that move the head, those that move the prothorax, and those that move the fore leg.

It is impossible to determine, from an anatomical study alone, the individual action of the muscles attached on the back of the head and on the cervical sclerites (fig. 32 A, B), since their functions may vary according to whether opposed sets of them act together or as antagonists. It is evident that the dorsal muscles (fig. 32 A, 47, 48, 49) and the ventral muscles (55) may tilt the head up or down respectively by pulling on opposite sides of the fulcrum of the cervical sclerites (*g*), or also that they may turn the head laterally if both sets on either side act as antagonists to those of the other side, while, finally, if they all act together they would become retractors of the head. The dorsal muscles of the cervical sclerites (A, B, 50, 51, 52, 53) must be the protractors of the head, since their combined pull would straighten the angles between the two sclerites of each pair and thus push the head forward. The oblique ventral muscles of the cervical sclerites (fig. 35, 54) would appear to be accessory to the lateral movement of the head.

47. *First protergal muscle of the head* (fig. 32 A).—A slender muscle arising dorsally on protergum; inserted dorso-laterally on postoccipital ridge of head (*PoR*).

48. *Second protergal muscle of the head* (fig. 32 A).—A larger muscle arising dorsally on third ridge (*c*) of protergum; inserted with 47 on postoccipital ridge of head.

49. *Longitudinal dorsal muscle of the neck and prothorax* (fig. 32 A).—A broad muscle from first thoracic phragma (*1Ph*) to postoccipital ridge of head just below 48.

50, 51. *Cephalic muscles of the cervical sclerites* (fig. 32 A, B).—Origins on postoccipital ridge below 49; both extend ventrally and posteriorly, the first (50) inserted on first cervical plate, the second (51) on second cervical plate.

52, 53. *Protergal muscles of the cervical sclerites* (fig. 32 B).—Origins dorso-laterally on protergum at lower end of first tergal ridge (*c*); both extend ventrally and anteriorly, crossing internal to 50 and 51, to insertions on first cervical sclerite, the first muscle with a branch (52*a*) to articular process (*g*) of head.

54. *Prosternal muscle of the first cervical sclerite* (figs. 32 A, B, 33 C, 35).—A horizontal, diagonal muscle arising on prosternal apophysis (figs. 32, 35); inserted anteriorly on first cervical sclerite of opposite side (figs. 32 B, 35), the right and left muscles crossing each other medially (fig. 35).

55. *First ventral longitudinal muscle* (figs. 32 A, 33 A, 35).—A broad, flat muscle from base of posterior arm of tentorium to apophysis of prosternum (figs. 32 A, 35, *SA*).

56. *Dorsal lateral neck muscle* (fig. 32 A).—A band of slender fibers from first phragma (*IPh*) inserted on base of neck membrane (*Cv*).

57. *Ventral lateral neck muscle* (fig. 32 A, B).—A short, flat muscle from anterior edge of prothoracic episternum (*Eps₁*), inserted on base of neck membrane (*Cv*).

The prothorax is movable on the mesothorax by two oblique, lateral intersegmental muscles on each side (fig. 32 A, 58, 59), and by three pairs of ventral intersegmental muscles (figs. 32 A, 35, 60, 87, 88).

58. *Tergo-pleural intersegmental muscle* (fig. 32 A).—A broad muscle of several sections, attached anteriorly on protergum behind upper end of ridge *d*; extends posteriorly and ventrally to intersegmental membrane just before upper end of mesepisternum (*Eps₂*).

59. *Sterno-pleural intersegmental muscle* (figs. 32 A, 33 A, 35).—Attached anteriorly on upper end of prosternal apophysis (figs. 32 A, 33 A, *SA*); extends posteriorly and dorsally to dorsal end of anterior margin of mesepisternum (*Eps₂*). In some insects this muscle is attached posteriorly on the anterior angle of the mesotergum.

60. *Second ventral longitudinal muscle* (figs. 32 A, 33 A, 35).—Extends between prosternal and mesosternal apophyses. Attached anteriorly by broad base on prosternal apophysis; tapers posteriorly to attachment on anterior margin of mesosternal apophysis (fig. 35).

The other two sternal muscles that move the prothorax are the third and fourth ventral longitudinals (figs. 32 A, 35, 87, 88) attached anteriorly on the first spina (*ISpn*), but they will be described with the mesothoracic muscles.

61. *Sterno-spinal muscle* (figs. 33 C, 35).—A very small muscle arising on base of prosternal apophysis (*SA*); the two from opposite sides converging posteriorly to insertions on anterior end of first spina (*ISpn*). Since the spinasternum (*Ss*) is but little movable on the prosternum (*S₁*) in the grasshopper, this pair of muscles can act only as tensors or levators of the spinasternum.

The muscles that move the prothoracic leg of *Dissosteira* represent the *tergal promotor* (fig. 11, *I*), the *tergal remotor* (*J*), and the *sternal remotor* (*L*) of the primitive limb base, and the *abductors* (*M*) and the *adductors* (*N*) of the coxa. A representative of the *sternal promotor* (*K*) is absent in the prothorax of *Dissosteira*. The sternal remotors function as posterior rotators of the coxa by reason of the single articulation of the latter with the pleuron only; in *Dissosteira* one branch of the sternal remotor arises on the spina.

62. *Tergal promotor of the coxa* (fig. 33 A).—The largest muscle of the prothorax. Origin on upper lateral wall of protergum, posterior to lower end of first ridge (*c*); insertion ventrally on the small trochantin (fig. 33 A, B, D, *Tn*).

63. *First tergal remotor of the coxa* (fig. 33 A).—Origin on lateral wall of protergum mesad of upper end of 62 below ridge *f*; extends ventrally and posteriorly external to 59 and 60 to insertion on posterior angle of base of coxa (fig. 33 B, C, D).

64. *Second tergal remotor of the coxa* (fig. 33 A, B, C, D).—A short muscle arising on lateral wall of protergum (D) beneath ridge *i*; insertion on posterior angle of coxa (C, D).

65. *Third tergal remotor of the coxa* (fig. 33 A, B, C, D).—A slender muscle arising on protergum (D) in angle between ridges *e* and *h*; insertion ventrally on posterior angle of coxa.

66. *First posterior rotator of the coxa* (figs. 33 C, D, 35).—Origin on base of sternal apophysis (figs. 33 C, 35, *SA*); insertion on posterior angle of coxa.

67. *Second posterior rotator of the coxa* (figs. 33 C, D, 35).—Origin on side of spina (figs. 33 C, 35, *ISpn*); insertion on posterior angle of coxa.

68. *Abductor of the coxa* (fig. 33, B, D).—A flat, two-branched muscle arising on inner face of episternum (*Eps*), the larger branch (68*b*) dorsally, the smaller branch (68*a*) in anterior ventral angle; both inserted by a common stalk on outer rim of coxa (D) just before pleural coxal articulation (*CxP*).

69. *Adductor of the coxa* (fig. 33 C).—Origin on outer end of sternal apophysis (*SA*), or at union of the latter with pleural apophysis (*PLA*); insertion on inner rim of base of coxa (*Cx*).

The following nine muscles (70 to 78) pertain to the segments of the telopodite of the prothoracic leg. Three branches of the depressor of the trochanter (71) have their origins within the body.

70. *Levator of the trochanter* (fig. 36 A).—Origin dorsally in anterior part of coxa; fibers converge to insertion on tendon arising from dorsal lip of base of trochanter. This is the lifting muscle of the telopodite.

71. *Depressor of the trochanter* (figs. 33 A, B, C, 36 A).—A five-branched muscle, two groups of fibers arising in the coxa and three in the prothorax, all converging upon a strong apodeme arising from ventral lip of base of trochanter (fig. 36 A, 71*Ap*). The coxal branches arise anteriorly (71*a*) and posteriorly in ventral part of coxa; of the three body branches the first (71*b*) arises dorsally on anterior margin

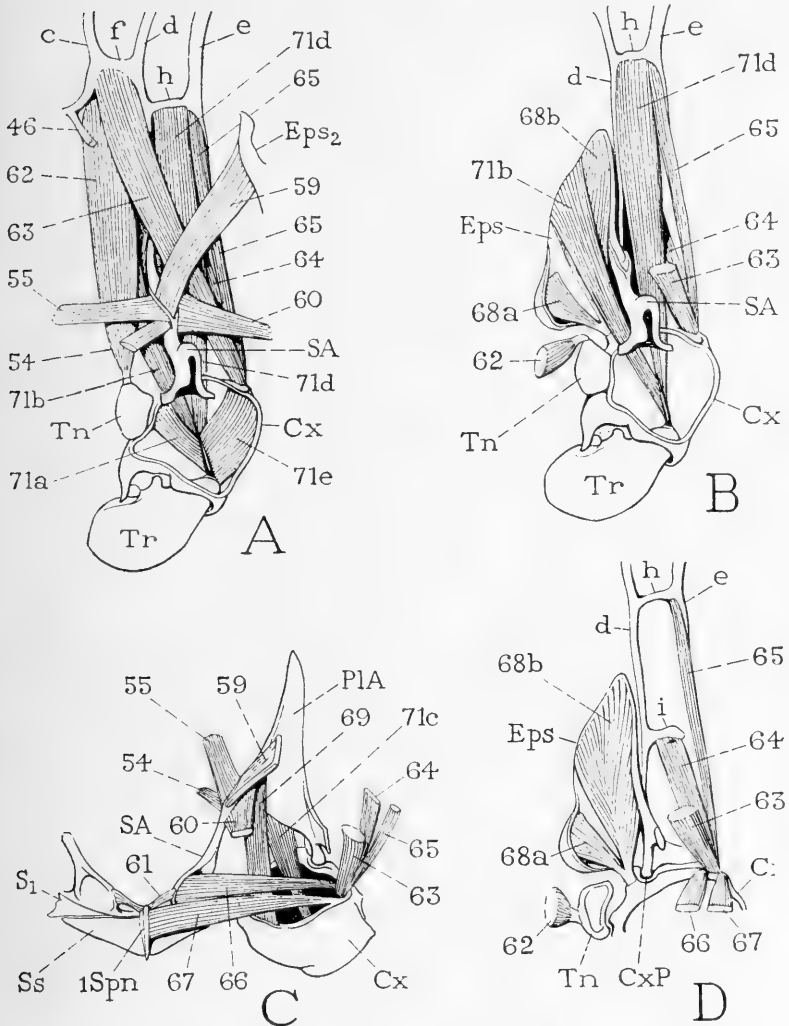

FIG. 33.—Musculature of the base of the fore leg of *Dissosteira*.

A, inner view of base of right leg, showing coxal and trochanteral muscles arising on lateral walls of protergum; tergal ridges lettered as on figure 20 B.
 B, same as A but with inner muscles removed, showing coxal and trochanteral muscles arising on episternum, and posterior group on tergum.
 C, posterior view of prosternum, right pleuron, and right coxa, showing leg muscles arising on sternum and pleural arm.
 D, articular region of base of right coxa, and associated muscles, inner view.

of episternum (fig. 33 B, *Eps*), the second (*71c*) on ventral edge of pleural arm (fig. 33 C, *PIA*), the third (*71d*) on lateral wall of protergum (fig. 33 A, B) just below ridge *h*. These groups of fibers constitute the most powerful muscle of the leg and function as the depressor of the telopodite as a whole.

72. *Reductor of the femur* (fig. 36 A).—A short, broad muscle in posterior part of trochanter (*Tr*) arising on ventral wall of the segment; fibers extending dorsally and posteriorly to posterior rim of base of femur, giving the latter a slight posterior flexion.

73. *Anterior levator of the tibia* (fig. 36 A).—An extremely slender muscle arising anteriorly in base of femur; inserted by long, thread-like apodeme on a process from anterior side of base of tibia (as in middle leg, fig. 36 B, *105A β*).

74. *Posterior levator of the tibia* (fig. 36 A).—Origin dorsally in proximal part of femur; insertion by a strong tendon on posterior dorsal angle of base of tibia (as in middle leg, fig. 36 E, *106*).

75. *Depressor of the tibia* (fig. 36 A).—Origin anteriorly (*75a*) and posteriorly on ventral wall of femur, with branch (*75c*) from base of trochanter (*Tr*); inserted by a strong tendinous apodeme arising from small ventral plate in membrane of femoro-tibial joint.

76. *Levator of the tarsus*.—Origin on distal third of dorsal wall of tibia; insertion on dorsal lip of base of tarsus.

77. *Depressor of tarsus*.—Origin on ventral wall of tibia; insertion on ventral lip of base of tarsus.

78. *Depressor of the pretarsus: retractor of the claws* (fig. 36 A).—This muscle comprises three branches, the principal one arising posteriorly in base of femur (fig. 36 A, *78*), the other two in upper part of tibia; all inserted on a long tendon extending from femur through tibia and tarsus to unguitractor plate at base of claws.

The following two muscles are those of the first spiracle, but since the first spiracle is situated within the region of the prothorax, its muscles are to be classed as prothoracic. The mechanism of the spiracles will be discussed in Section VI.

79. *Closing muscle of the first spiracle* (fig. 51 B).—Origin on ventral process of peritreme (*l*); insertion on lever of posterior lip of spiracle (*i*).

80. *Opening muscle of the first spiracle* (fig. 51 B).—Origin on ventral process of peritreme; insertion on base of posterior lip of spiracle.

MUSCLES OF THE PTEROTHORAX

The musculature of the wing-bearing segments differs in many respects from that of the prothorax, particularly in the great development of the dorsal longitudinal muscles (fig. 34, 81, 112), in the presence of large tergo-sternal muscles (83, 84, 113) and special wing muscles which are lacking in the prothorax, and in the presence of two pleuro-coxal muscles that become wing muscles in the adult.

The dorsal longitudinals and the tergo-sternals constitute a group known as the *indirect wing muscles* because they effect movements of

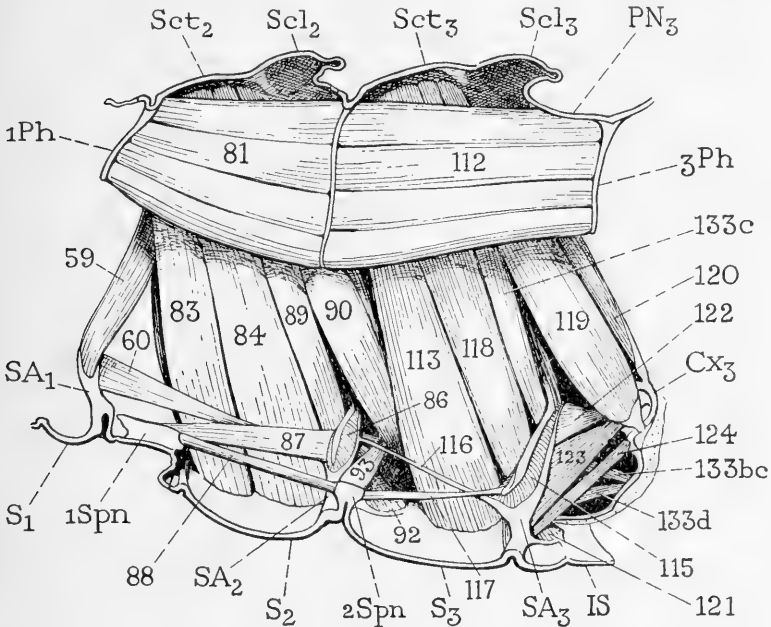

FIG. 34.—General view of the musculature in the right half of the pterothorax of *Dissosteira*. Median section, seen from the left.

the wings by alternate changes in the curvature of the tergum. There is but one special wing muscle in *Dissosteira* connected with each wing: this is the wing flexor (figs. 37 A, 85; 49, D), a short muscle having its origin on the pleuron and its insertion on the third axillary sclerite of the wing base. In many insects there are several small muscles from the upper parts of the pleuron to the edge of the tergum or to the base of the wing, but representatives of these muscles are absent in the grasshopper. The two pleuro-coxal muscles that become important wing muscles in the adult are apparently abductors of the coxa in the nymph (fig. 27 C, M', M''). The first is the pronator-

extensor of the wing (fig. 49, *M'*), having its dorsal insertion on the basalar plates of the adult; the second is the depressor-extensor (*M''*) with its insertions on the subalar plate. Associated with the first is a large muscle (*E*) arising ventrally on the sternum. These three epipleural muscles (*E*, *M'*, *M''*) together with the wing flexor (*D*) constitute the so-called *direct wing muscles*, though only the flexor is a true wing muscle.

The ventral muscles of the pterothorax are small; those of the mesothorax (figs. 34, 35, 60, 87, 88) serve to move the prothorax; those of the metathorax (116, 117) can have but little motor function, since the mesothorax and metathorax are immovable on each other, and they are reduced mostly to tendinous strands. The muscles of the middle and hind legs are essentially the same as those of the prothoracic leg, but the muscles of the hind tibia are particularly large and not of the same relative size as those of the fore and middle legs.

A first dissection of the pterothoracic musculature should be made from the median plane of the body in a specimen cut into lateral halves (fig. 34) from which the alimentary canal and other visceral tissues have been removed.

THE MESOTHORACIC MUSCLES

81. *Longitudinal dorsal muscles* (fig. 34).—A large mass of fibers in each side of upper median part of mesothorax, attached anteriorly on lobes of first phragma (*IPh*) and posteriorly on middle phragma.

82. *Oblique dorsal muscles* (not shown in figures).—A small muscle laterad of longitudinal dorsals; arising on lateral part of scutum, extending posteriorly and ventrally to insertion on outer part of middle phragma.

83. *First tergo-sternal muscle* (fig. 34).—Attached dorsally on posterior part of lateral prescutal lobe; attached ventrally on anterior part of mesosternum.

84. *Second tergo-sternal muscle* (fig. 34).—A very large muscle immediately posterior to 83; attached dorsally by inner branch on middle of lateral scutal area, and by outer branch on marginal lobe of scutum behind posterior articulation of first axillary; attached ventrally on mesosternum before inner margin of coxal cavity.

85. *Pleuro-alar muscle: flexor of the wing* (fig. 37 A).—This muscle lies laterad of the series of dorsoventral muscles in the side of the segment and may be noted after the latter are removed. It arises by a broad base on upper part of pleural ridge (*PIR*), and goes dorsally and posteriorly between 98 and 99 into wing base where it is inserted on the third axillary (fig. 49, 3*Ax*).

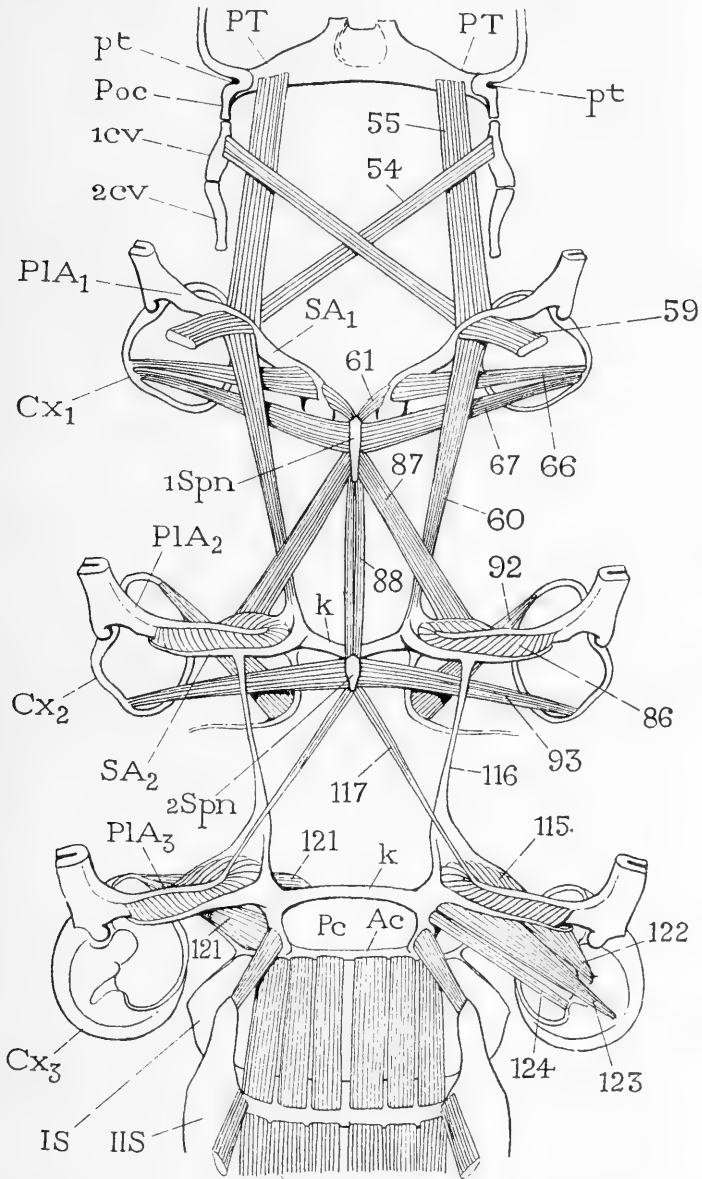

FIG. 35.—General view of the ventral musculature of *Dissosteira* from the head to the second abdominal segment.

86. *Pleuro-sternal muscle* (figs. 34, 35).—A dense mass of very short fibers connecting the approximated ends of the pleural apophysis and the sternal apophysis.

87. *Third ventral longitudinal muscle* (figs. 34, 35).—Attached laterally on first spina ($1Spn$); extends posteriorly and laterally over posterior end of 60 to anterior edge of apophysis of mesosternum (SA_2).

88. *Fourth ventral longitudinal muscle* (figs. 34, 35).—A slender muscle attached anteriorly on first spina ($1Spn$) and posteriorly on second spina ($2Spn$).

The following thirteen muscles (89-101) include the muscles of the base of the leg and the principal direct muscles of the wing.

89. *Tergal promotor of the coxa* (fig. 34).—Lies close behind 84 in the innermost series of lateral muscles. Origin on scutum; insertion on stalked disc (fig. 37 A, B, C, 89) arising from articular membrane at anterior angle of coxa close to lower end of trochantin (B, C, Tn). The representative of this muscle in the prothorax (fig. 33 A, 62) is inserted on the trochantin, as it is in most insects in which the trochantin is well developed.

90. *First tergal remotor of the coxa* (fig. 34).—Origin on scutum; goes ventrally posterior to pleural arm to insertion on stalked disc arising from inner posterior angle of coxa (fig. 37 A, B, 90).

91. *Second tergal remotor of the coxa* (fig. 37 A).—A slender muscle arising on scutum from outer end of ridge s (fig. 22 B); goes obliquely ventrally and posteriorly to slender apodeme arising from extreme posterior angle of coxa (fig. 37 A, B, 91). This muscle is the last of the tergal muscles of the mesothorax; it lies just external to posterior border of 90 and is partially visible from median plane (fig. 34) between 90 and 113.

The group of mesothoracic muscles attached dorsally on the tergum includes two segmental branches of the depressor of the trochanter (103) which will be described later. When the tergal muscles have been removed there is exposed a second or outer set of lateral muscles having their origin on the pleuron (fig. 37 A). These muscles include the abductors of the coxa, and the direct muscles of the wing. The wing flexor (85) of the latter group has already been described as a pleuro-alar muscle; the others are pleuro-coxal, with one pleuro-sternal muscle. Ventrally there will be seen also the sterno-coxal muscles, or rotators of the coxa, a description of which will logically follow that of the tergo-coxal muscles.

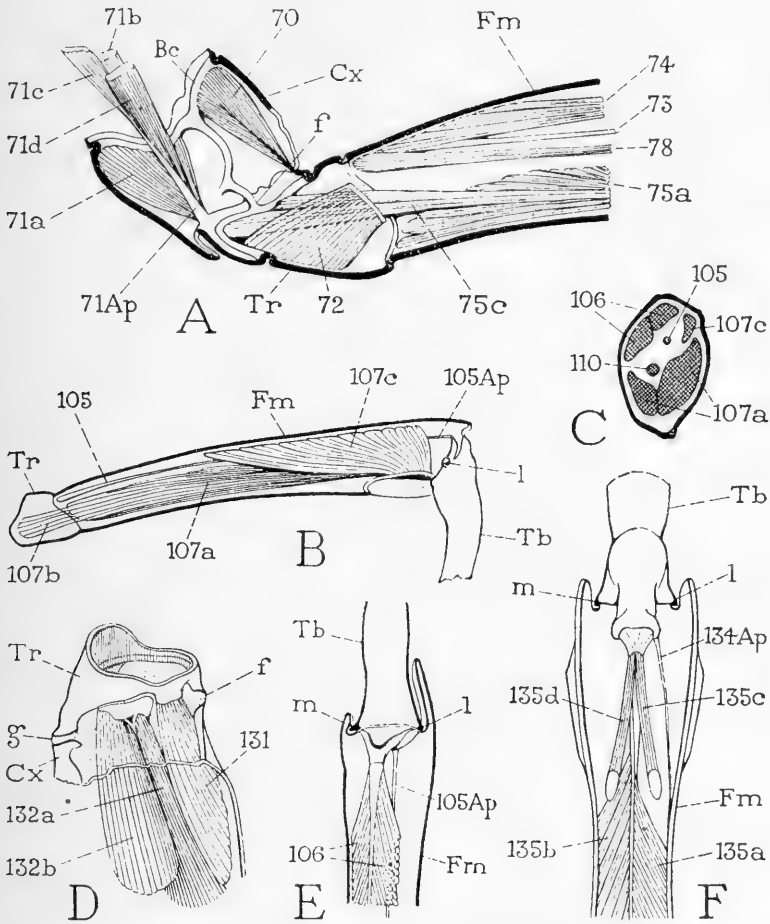

FIG. 36.—Leg musculature of *Dissosteira*.

A, posterior view of muscles in proximal part of right fore leg, including coxa (*Cx*), trochanter (*Tr*), and base of femur (*Fm*).

B, anterior and ventral muscles of tibia arising in femur and trochanter of left middle leg.

C, cross-section near middle of second left tibia, proximal surface of distal half, showing positions of tibial muscles.

D, dorsal view of trochanter (*Tr*) of left hind leg, showing anterior and posterior coxo-trochanteral articulations (*f*, *g*), and levator muscles of trochanter arising in coxa.

E, dorsal view of femoro-tibial joint of left middle leg, showing anterior and posterior articulations (*l*, *m*), and bases of levator muscles of tibia.

F, corresponding view of femoro-tibial joint of left hind leg.

92. *Anterior rotator of the coxa* (figs. 34, 35, 37).—Origin on sternellar lobe of mesosternum (figs. 34, 35); extends anteriorly and outward to anterior angle of coxa (figs. 35, 37 A, B, C).

93. *Posterior rotator of the coxa* (figs. 34, 35, 37).—Origin on second spina (figs. 34, 35); extends outward, above 92, to posterior inner angle of coxa (figs. 35, 37 A, B).

94, 95. *First and second abductors of the coxa* (fig. 37 A).—Origin on anterior ventral area of episternum (*Eps*); fibers of each converge to a pair of long, flat apodemes arising anteriorly on outer margin of coxa (fig. 37 B, C, 94, 95).

96. *Third abductor of the coxa* (fig. 37 A).—A wide, flat, fan-shaped muscle arising on episternal area posterior and dorsal to 95; fibers converging to insertion on a slender apodeme arising in articular membrane laterad of base of coxa just anterior to pleural articulation (fig. 37 B, 96).

97. *First pronator-extensor of the forewing* (fig. 37 A).—A large muscle inserted dorsally on first basalar plate (*IBa*); extending ventrally to attachment on lateral part of sternum before base of middle leg.

98. *Second pronator-extensor of the forewing* (fig. 37 A).—Insertion dorsally close to 97 on first basalar plate (*IBa*); attached ventrally on bases of apodemes of first and second abductors of coxa (fig. 37 B, C, 98).

99. *Depressor-extensor of the forewing* (fig. 37 A).—Inserted dorsally on subalar plate of wing base (*Sa*); attached ventrally on flat extension of basicoxal ridge (fig. 37 B, 99) in meral region of coxa (*Mer*) posterior to pleural articulation (*c*).

100. *First adductor of the coxa* (fig. 37 A).—A broad flat muscle arising on posterior margin of mesosternal apophysis; insertion on inner rim of coxa (A, B, 100).

101. *Second adductor of the coxa* (fig. 37 A).—A smaller muscle arising on mesosternal apophysis; inserted on posterior angle of coxa (A, B, 101) between attachments of 90 and 91.

The telopodite of the middle leg, or that part of the limb beyond the coxa, has the same musculature as the telopodite of the first leg; its muscles are the following:

102. *Levator of the trochanter*.—Origin dorsally in base of coxa; insertion on dorsal lip of base of trochanter.

103. *Depressor of the trochanter*.—A five-branched muscle with all branches inserted on a tongue-like apodeme arising from ventral lip of base of trochanter. Two branches arise ventrally in the coxa, one

anteriorly, the other posteriorly; the others take their origin in the mesothorax. The first and second body branches arise on scutum, one medially the other on lateral margin, both pass into coxa anterior to pleural arm; the third body branch arises on ventral margin of mesosternal apophysis. The trochantal muscles effect the movement of the telopodite as a whole.

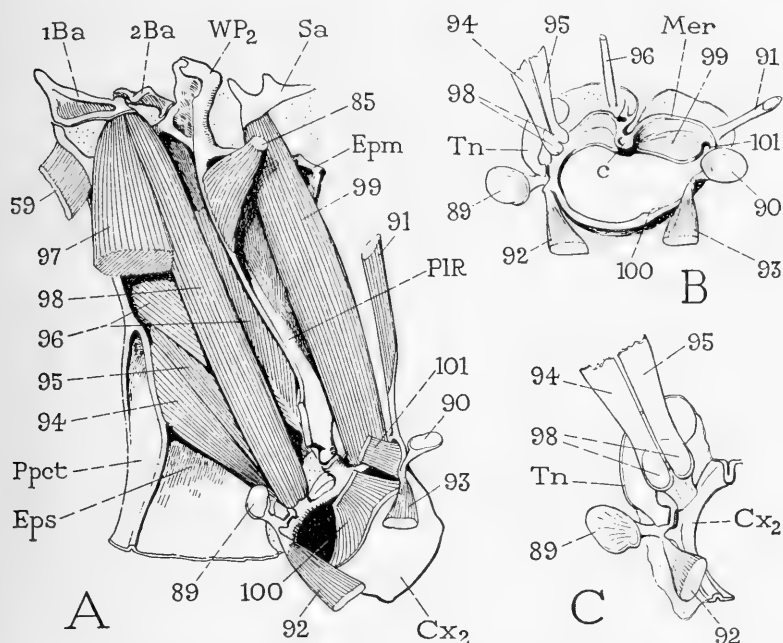

FIG. 37.—Coxal musculature of the middle leg of *Dissosteira*.

A, general view of pleural muscles, right side, inner view, and bases of sternal coxal muscles.

B, base of coxa, inner view, showing muscle attachments.

C, anterior rim of coxa (*Cx*), trochantin (*Tn*), and attachments of associated muscles, inner view.

104. *Reductor of the femur*.—A sheet of very delicate fibers in posterior part of trochanter, arising in base of latter, inserted on posterior rim of base of femur. This muscle is much weaker than the corresponding muscle of the prothoracic leg (fig. 36 A, 72), the femur of the middle leg being scarcely movable on the trochanter.

105. *Anterior levator of the tibia* (fig. 36 B, C).—A delicate, attenuate muscle arising anteriorly in base of femur; inserted by a long tendon-like apodeme arising from dorsal end of a slender process from anterior margin of base of tibia (fig. 36 E, 105*Ap*).

106. *Posterior levator of the tibia* (fig. 37 C, E).—A long, pinnate muscle with fibers arising on almost entire length of dorso-posterior wall of femur; inserted by strap-like tendon on dorsal angle of base of tibia (E, 106).

107. *Depressor of the tibia* (fig. 36 B, C).—The largest muscle in the middle femur, comprising three groups of fibers, all inserted on a long apodeme arising from small plate in ventral membrane of knee joint. Principal group of fibers (B, 107a) forms a long pinnate muscle arising ventrally in proximal part of femur; second group a small bundle of fibers (107b) arising in base of trochanter and joining with those of first group; fibers of third group (107c) arise anteriorly and dorsally in distal two-thirds of femur and converge ventrally to insertion on base of depressor apodeme.

108. *Levator of the tarsus* (fig. 42 A).—Origin dorsally in distal third of tibia; insertion on dorsal lip of base of tarsus.

109. *Depressor of the tarsus* (fig. 42 A).—Origin ventrally in distal three-fourths of tibia; insertion on ventral lip of base of tarsus.

110. *Depressor of the pretarsus: retractor of the claws* (figs. 36 C, 42 A, C).—Fibers arising in femur and tibia; inserted on long, thread-like apodeme arising from unguitactor plate at base of claws (fig. 42 C, 110Ap) and extending through tarsus (A) and tibia, and into femur. Principal group of fibers a long, tapering bundle (fig. 36 C, 110) arising proximally on posterior wall of femur and inserted on end of tendon; two smaller groups of fibers in upper end of tibia, one arising anteriorly in base of tibia, the other dorsally, both inserted on tendon just above middle of tibia.

Since the second thoracic spiracle lies within the region of the mesothorax, its muscle belongs to the same segment.

111. *Closing muscle of the second spiracle* (fig. 52 B).—Origin on small lobe (*o*) of posterior dorsal margin of mesocoxal cavity; insertion on ventral lobe of spiracular lips (*n*).

THE METATHORACIC MUSCLES

The musculature of the metathorax almost duplicates that of the mesothorax, with the principal difference that there are no oblique dorsal muscles and that there is only one pair of tergo-sternals in the metathorax.

112. *Longitudinal dorsal muscles* (fig. 34).—Most of the fibers extend between middle phragma and third phragma (*3Ph*), though a few dorsal ones are attached posteriorly on the postnotal plate (*PN₃*).

113. *Tergo-sternal muscle* (fig. 34).—A large muscle, the first of the inner lateral series in metathorax, attached dorsally on lateral prescutal lobe, and below by a wide base on lateral part of sternum before coxal cavity. This muscle corresponds with 83 of the mesothorax, a scuto-sternal muscle (84) being absent in the metathorax.

114. *Pleuro-alar muscle: flexor of the hind wing* (fig. 38, 114).—This muscle consists of two bundles of fibers in metathorax, one external, the other internal, both arising from upper end of pleural ridge, and inserted on ventral surface of third axillary sclerite of wing base. The outer muscle is not visible from mesal plane until the first is removed.

115. *Pleuro-sternal muscle* (figs. 34, 35).—A dense mass of very short fibers connecting pleural apophysis with apophysis of metasternum.

116. *Fifth ventral longitudinal muscle* (figs. 34, 35).—A strong fiber, apparently a sclerotized muscle, extending from posterior edge of mesosternal apophysis (SA_2) to median anterior angle of metasternal apophysis (SA_3).

117. *Sixth ventral longitudinal muscle* (figs. 34, 35).—A slender muscle arising on second spina ($2Spn$), becoming tendinous posteriorly; extends posteriorly and laterally to inner extremity of pleural apophysis of metathorax.

The ventral longitudinal muscles of the metathorax have evidently lost their contractile nature because of the fusion of the mesosternum and metasternum, and are converted mostly into sclerotic strands to brace the pull of the mesothoracic ventral muscles (60, 87, 88) on the sternal plates of the prothorax.

The following thirteen muscles (118 to 130) are muscles of the metacoxa and the hind wing.

118. *Tergal promotor of the coxa* (figs. 34, 38 A).—Lies immediately behind the tergo-sternal (fig. 34, 113). Arises dorsally on lateral area of scutum (fig. 38 A); inserted ventrally on apodemal disc of anterior angle of coxa (fig. 38 D, F, 118).

119. *First tergal remotor of the coxa* (figs. 34, 38 A).—A large muscle arising from posterior scutal margin; goes downward and posteriorly, behind pleural arm, to apodemal disc on posterior inner angle of coxa (fig. 38 D, F, 119).

120. *Second tergal remotor of the coxa* (figs. 34, 38 A).—A slender muscle lying close behind 119, tapering ventrally to slender apodeme arising from extreme posterior angle of coxa (fig. 38 B, D, F, 120).

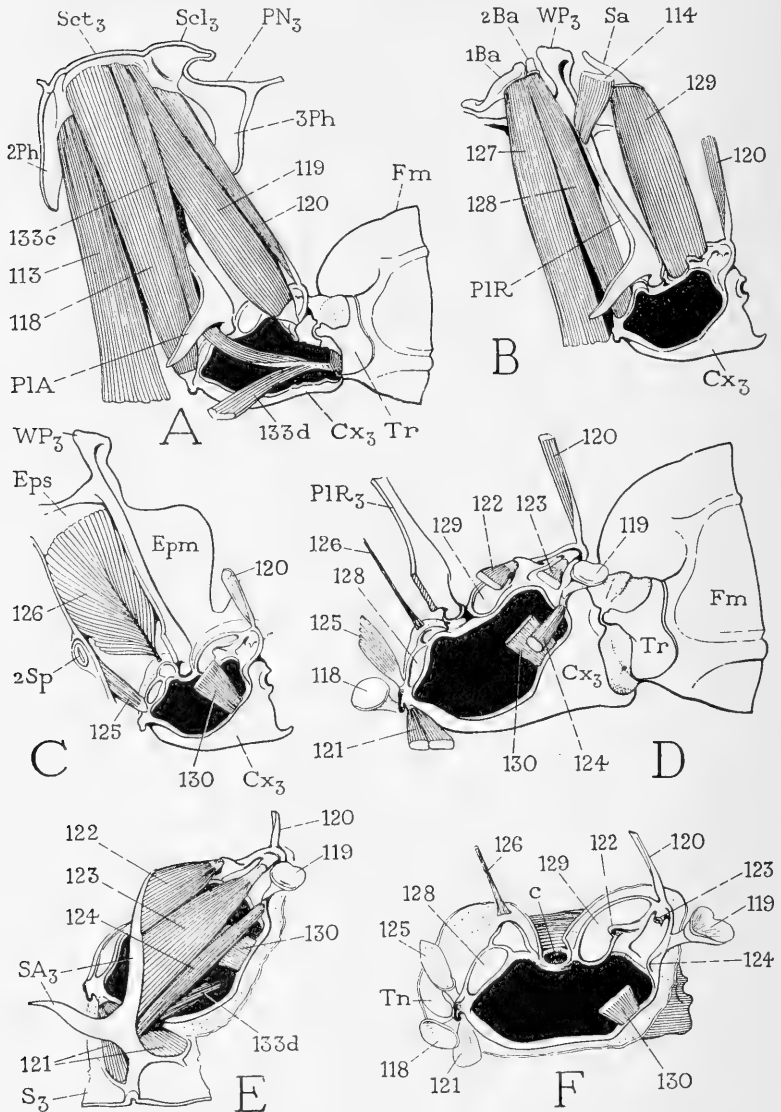

FIG. 38.—Muscles of the hind coxa and trochanter of *Dissosteira*.

A, tergal muscles of leg base, and the tergo-sternal muscle (113), right side, inner view.

B, sternal and coxal muscles of basalar and subalar sclerites (1Ba, 2Ba, Sa).

C, abductor muscles of coxa.

D, general view of muscle attachments on base of right coxa, inner view.

E, sternal muscles of leg base, dorsal view.

F, coxal muscle attachments, dorsal view.

The innermost series of lateral muscles includes two body branches of the trochanteral depressor (fig. 38 A, 133c) which will be described later. By removing the muscles attached on the tergum, there is exposed the outer series of pleural lateral muscles pertaining to the leg and wing, and the sternal muscles of the coxa.

121. *Anterior rotator of the coxa* (figs. 34, 35, 38 E).—A large muscle with fibers arising in two groups, one from lateral part of sternum before base of sternal apophysis, the other from sternellar lobe behind the apophysis; all fibers converge to insertions on anterior angle of coxa just mesad of stalked apodeme of 118 (fig. 38 D, F, 121).

122, 123, 124. *First, second, and third posterior rotators of the coxa* (figs. 34, 35, 38 E).—Origins on posterior margin of lateral arm of metasternal apophysis; insertions posteriorly on base of coxa, the first (fig. 38 D, E, F, 122) on process of meral region, the second (123) just within posterior angle of coxa, the third (124) on posterior part of meral rim of coxa.

The innermost pleural muscles are the large basalar and subalar wing muscles (fig. 38 B, 127, 128, 129); external to them are the abductors of the coxa.

125. *First abductor (accessory promotor) of the coxa* (fig. 38 C).—A small muscle arising from anterior edge of metepisternum just behind and below second spiracle (2Sp); insertion anteriorly on external margin of coxa (fig. 38 C, D). Anatomically this muscle evidently belongs to the abductor system of the coxa, but apparently it functions as an accessory of the tergal promotor (D, 118).

126. *Second abductor of the coxa* (fig. 38 C).—A large flat muscle arising on inner face of episternum and on anterior surface of pleural ridge; fibers converging to insertion on slender apodeme (fig. 38 D, F, 126) arising in articular membrane at base of coxa just before pleural articulation.

127. *First pronator-extensor of the hind wing* (fig. 38 B).—A large muscle attached dorsally on first basalar plate (1Ba), and ventrally on lateral part of sternum before coxa and laterad of base of the tergo-sternal muscle (figs. 34, 38 A, 113).

128. *Second pronator-extensor of the hind wing* (fig. 38 B).—Lies close behind 127; attached dorsally on second basalar plate (2Ba), ventrally on lateral rim of coxa (fig. 38, D, F, 128) anterior to pleural articulation (c).

129. *Depressor-extensor of the hind wing* (fig. 38 B).—A powerful muscle, attached dorsally on inner disc of subalar plate (Sa), and ventrally on wide basicostal surface of meral region of coxa (fig. 38 D, F, 129).

130. *Adductor of the coxa* (fig. 38 C, D, E, F).—Origin on posterior surface of lateral arm of sternal apophysis (E) beneath base of first posterior rotator (122); goes posteriorly and downward below 123 and 124 to posterior part of inner margin of coxa (C, D, E, 130).

The following muscles belong to the telopodite of the hind leg. The total number is the same as in the fore and middle leg, but there are two distinct levators of the trochanter, and a reductor of the femur is lacking.

131. *Anterior levator of the trochanter* (figs. 36 D, 39).—Origin on dorsal part of anterior wall of coxa; insertion on anterior lobe of dorsal rim of trochanter (fig. 36 D).

132. *Posterior levator of the trochanter* (figs. 36 D, 39).—A two-branched muscle arising dorsally in base of coxa; both branches (132a, 132b) inserted on levator apodeme and supporting plate in dorsal articular membrane close to rim of trochanter (fig. 36 D).

133. *Depressor of the trochanter* (figs. 38 A, E, 39).—This muscle, as in the other legs, consists of five branches, two of which arise in the coxa, and three in the metathorax; all are inserted on ventral rim of trochanter and together constitute a strong depressor of the telopodite. The coxal branches arise one anteriorly (fig. 39, 133a), the other posteriorly in ventral part of coxa. Two of the body branches arise on scutum of metatergum, one from lateral margin, the other (fig. 38 A, 133c) from center of lateral field. These two branches converge downward and unite before the pleural arm in a broad, tough band of fibers that curves posteriorly beneath the pleural arm (PLA) to enter the coxa. The third body branch arises from under surface of lateral arm of sternal apophysis (fig. 38 A, E, 133d).

134. *Anterior levator of the tibia* (figs. 36 F, 39).—This muscle appears to be represented in the hind leg of *Dissosteira* by only a very delicate tendinous strand arising from the anterior angle of the tibial base (134Ap), and extending proximally for a short distance against the anterior wall of the distal part of the femur. The writer was unable to discover muscle fibers attached to this tendon.

135. *Posterior levator of the tibia* (figs. 36 F, 39).—This great muscle occupies most of the cavity of the femur (fig. 39 A, B). The fibers arise in short, overlapping bundles from anterior and posterior walls of femur where they are attached on the spaces between the "fish-bone" ridges, with dorsal fibers of posterior set (135b) arising in dorsal crest of femur. Anterior and posterior fibers converge to sides of a large, thin, flat apodeme that tapers distally to a thick stalk

(fig. 39 A, 135Ap) arising from dorsal margin of base of tibia. On the base of this apodeme are inserted two short, strap-like branches (fig. 36 F, 135c, 135d) arising dorsally in distal part of femur.

136. *Depressor of the tibia* (fig. 39).—A relatively small muscle with long, slender fibers (136a) arising in ventral part of femur and converging to sides of long, tapering apodeme arising in ventral membrane of knee joint. The terminal, strap-like part of this apodeme slides over a strong, internal process (a) of ventral wall of femur.

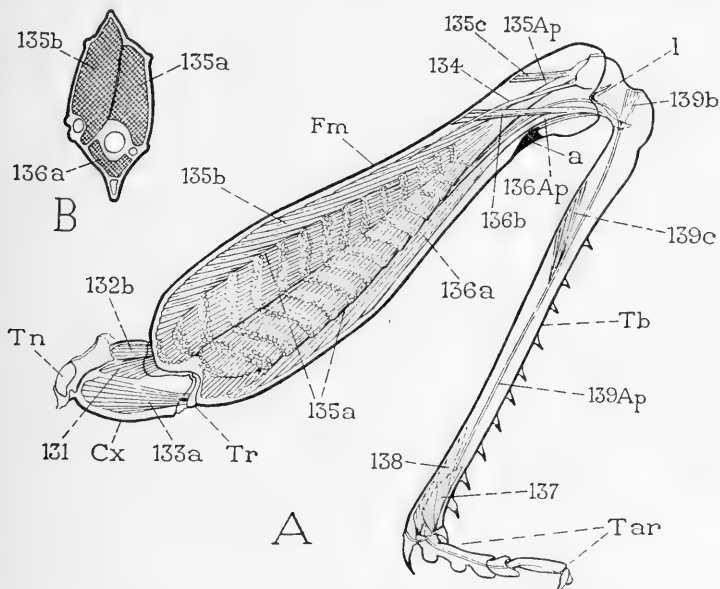

FIG. 39.—Musculature of the hind leg of *Dissosteira*.

A, left leg, anterior (outer) view. B, cross-section through basal half of left femur, proximal end of distal piece, showing positions of levator and depressor muscles of tibia and of principal tracheae.

Two small, anterior and posterior bands of fibers, arising on dorsal wall of femur, are inserted on apodeme near its base, the anterior one (136b) shown in the figure.

137. *Levator of the tarsus* (fig. 39).—A very small dorsal muscle in distal end of tibia, inserted on dorsal rim of base of tarsus.

138. *Depressor of the tarsus* (fig. 39).—A small muscle, but longer than the levator, arising ventrally in distal part of tibia, inserted on ventral lip of base of tarsus.

139. *Depressor of the pretarsus: retractor of the claws* (fig. 39).—Comprises three small groups of fibers, one arising posteriorly in ventral part of femur among fibers of tibial depressor, the second (139b)

in proximal end of tibia, the third (*I39c*) on ventral wall of basal half of tibia; all inserted on fine, tendon-like apodeme (*I39 Ap*) arising from unguitractor plate at base of claws.

IV. THE LEGS AND THEIR MUSCLES

The legs of the grasshopper are all of typical form and segmentation, but the hind legs, being specially developed as organs of leaping, are not only of greater size than the others but differ from them in certain details of structure and in the relative proportions of some of the muscles. When the grasshopper sits in an ordinary resting position it supports itself principally on the first and second pairs of legs, the tibiae of the hind legs being flexed against the under surfaces of

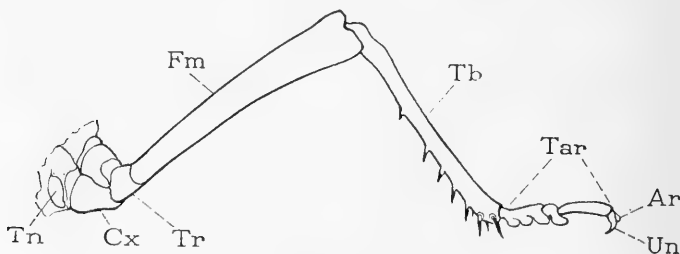

FIG. 40.—Middle leg of *Dissosteira*, anterior surface.

Ar, arolium; *Cx*, coxa; *Fm*, femur; *Tar*, tarsus; *Tb*, tibia; *Tn*, trochantin; *Tr*, trochanter; *Un*, claw.

the femora, with the knees usually held low and the tarsi barely touching the ground. (The grasshopper of illustrations commonly rests on all three pairs of legs, with the hind knees elevated and the tibiae extended.) In its natural resting attitude, the insect is always ready for a leap, the spring being caused by a forcible extension of the hind tibiae, probably accompanied by a strong depression of the trochanterofemoral parts of the legs. The chief function of the first and second legs is the support of the body and the directing of the few movements of walking or of changing the resting position; the first legs are actively used also during feeding for grasping and manipulating the edge of the leaf. When the grasshopper walks the hind legs are used with the others in the usual fashion.

In describing the legs it is customary to use terms of orientation as they would apply if the appendage were extended laterally at right angles to the body. Preaxial and postaxial surfaces are called *anterior* and *posterior*, and upper and lower surfaces are *dorsal* and *ventral*.

STRUCTURE OF THE LEGS

The general form of a grasshopper's leg is shown in the illustration of the middle leg of *Dissosteira* (fig. 40). The appendage consists of a *coxa* (*Cx*), a *trochanter* (*Tr*), a *femur* (*Fm*), a *tibia* (*Tb*), a three-segmented *tarsus* (*Tar*), and a *pretarsus* comprising a pair of lateral claws (*Un*) and a median *arolium* (*Ar*). In the articular membrane before the base of each coxa there is a small trochantinal sclerite (*Tn*), best developed in the prothorax.

Each leg is set into a membranous area, or *coxal corium* (fig. 26), occupying an oval interruption in the sclerotic wall of the body between the pleuron and the sternum, known as the *coxal cavity*, the rim of which is reinforced by a submarginal inflection. The coxa is hinged to the body wall by only a single articulation, which is with the pleuron. The rudimentary trochantin (fig. 40, *Tn*) does not restrict the movement of the coxa. The anterior and middle coxae are free to move in any direction, but the hind coxae, which are directed posteriorly, have a more limited range of motion. The number of muscles inserted upon the hind coxae, however, suggests that what little movement these coxae possess is of much importance in the function of the hind legs.

It should be noted that the articulating surfaces of the pleuro-coxal hinge are formed by inflections of the body and coxal walls, and therefore lie on the *inner* surfaces of the latter (fig. 41 D). In this respect the basal joint of the leg differs from the basal articulations of the head appendages with the head wall, for the latter are external surfaces of contact lying outside the articular membranes. The peculiar character of the pleuro-coxal (subcoxo-coxal) articulations attests, therefore, that these articulations are not homologous with the basal articulations of the gnathal appendages on the edge of the epicranium.

The coxo-trochanteral joint and the articulations between the segments of the telopodite, except the trochantero-femoral joint, which is but little movable, are all of the dicondylic hinge type with anterior and posterior articulating points on a horizontal axis transverse to the length of the leg segments. Movement at these joints is approximately in the same vertical plane. The trochanters are closely attached to the femora, but the hinge lines lie in a vertical plane, and the presence of a posterior femoral muscle in the trochanter of the first and the second leg (fig. 36 A, 72) shows that the primitive motions at the trochantero-femoral joint were movements of production and reduction. The segments of the tarsus are movable on each other, but since they have no musculature, they can be moved only as they are influenced by the tendon of the unguis retractor which passes through them (fig. 44. x).

The coxae.—The three coxae of the grasshopper differ somewhat in their positions on the body. The first is the most freely movable; it projects downward and its base is almost horizontal. The second coxa is directed outward, downward, and posteriorly; its base lies in an oblique plane between the pleuron and the sternum. The hind coxa is directed posteriorly; its basal aperture is on the inner face and lies in an approximately vertical, longitudinal plane.

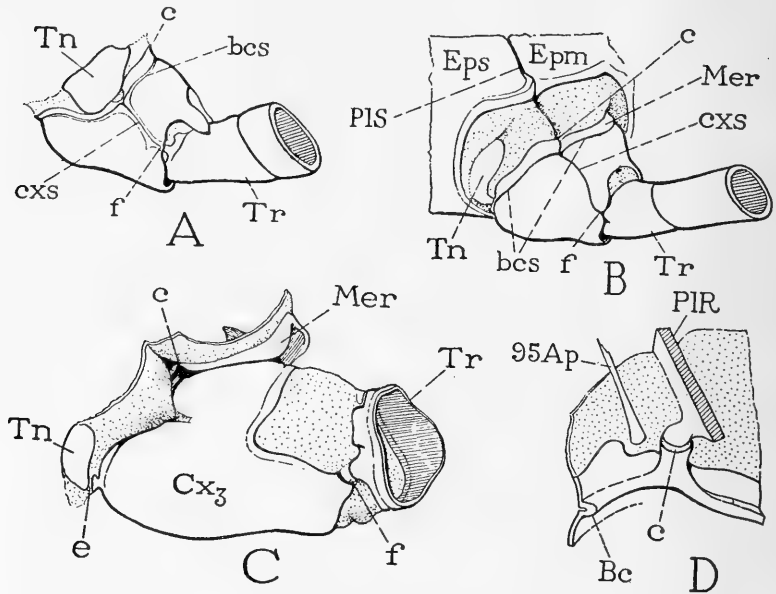

FIG. 41.—Structure of the coxae of *Dissosteira*.

A, first coxa and base of telopodite, left, anterior surface. B, base of middle leg, left, anterior surface. C, hind coxa and trochanter, left, anterior (outer) surface. D, articulation of middle coxa to pleural process, right, inner view.

95Ap, apodeme of second abductor of middle coxa; Bc, basicosta of coxa; bcs, basicostal suture; c, pleural articulation of coxa; Cx₃, hind coxa; cxs, coxal suture; Epm, epimeron; Eps, episternum; f, anterior coxo-trochanteral articulation; Mer, meron; PLS, pleural suture; Tn, trochantin; Tr, trochanter.

Each coxa presents a well-marked basal rim, or *basicoxite*, set off by a submarginal *basicostal suture* (fig. 41 A, B, *bcs*) which forms internally a strong *basicosta* (D, *Bc*). Laterally the costa of the middle coxa (fig. 37 B) and of the hind coxa (fig. 38 D, F) are enlarged into wide, shelf-like plates for the accommodation of muscle attachments. The basicoxite is very narrow or obsolete on the mesal surface of the coxa, but on the lateral surface it forms a distinct prearticular and a postarticular lobe, the latter being known as the *meron* (fig. 41 B, *Mer*). The basicostal lobes are well developed on the hind coxa (C)

but they are inconspicuous externally because each is bent outward and flattened upon the dorsal wall of the coxa. The articular surface (*c*) by which the coxa is hinged to the internal coxal process of the pleuron (*D*) is strongly inflected mesally in such a manner as to bring the point of suspension near the central axis of the coxa, thus giving the coxal muscles a leverage on all sides of it (fig. 43). Each coxa has a dicondylic hinge with the trochanter (fig. 36 *D, f, g*), the axis of which is horizontal and transverse to the length of the leg. The dorsal surface of the coxa is deeply emarginate between the hinge points, and the ample articular membrane that occupies the notch allows a free upward movement of the telopodite. When the latter is deflexed, the ventral lip of the trochanter passes inside the lower edge of the coxa.

The anterior wall of the prothoracic coxa is marked by a *coxal suture* (fig. 41 *A, cxs*) which extends from the anterior trochanteral articulation (*f*) to the basicostal suture at the articulation of the trochantin (*Tn*). The middle coxa (*B*) has a similar suture (*cxs*) ending at the trochanteral articulation (*f*), but it begins basally at the pleural articulation (*c*) and thus falls in line with the pleural suture (*PLS*) of the mesopleuron. The suture is absent in the hind coxa (*C*). The coxal suture, when present, forms a ridge on the inner surface of the coxal wall (fig. 36 *A*), the purpose of which is evidently to strengthen the latter.

A coxal structure such as that of the middle leg of the grasshopper (fig. 41 *B*), in which the anterior wall is divided by a groove (*cxs*) continuous with the pleural suture, is likely to be confused with the quite different structure illustrated by the coxa of *Panorpa* (fig. 14 *A*), in which the postarticular part of the basicostal suture (*bcs*) bends distally in the coxal wall and also falls in line with the pleural suture (*PLS*). The fundamental differences in the two cases, however, are quite apparent: in the grasshopper (fig. 41 *B*) the outer wall of the coxa itself is divided; in *Panorpa* (fig. 14 *A*) the meron (*Mer*) is greatly enlarged and is extended into the posterior coxal wall.

The internal ridge of the coxal suture in the prothoracic and mesothoracic legs of *Dissosteira* is continued through the anterior coxotrochanteral articulation (fig. 36 *A, f*), giving a firm but flexible union between the two articulating segments. The posterior articulation between the coxa and trochanter of the first and second legs consists of a condyle on the trochanter opposed by a concave surface on the coxa, but the two are united by membrane. In the hind leg both coxotrochanteral articulations consist of opposing processes united by ligament-like thickenings of the articular membrane (fig. 36 *D, f, g*).

The trochanters.—The trochanteral segments of the prothoracic and mesothoracic legs have the usual form of the trochanter in insects, each being a short segment articulating as just noted with the coxa, and united distally with the femur. The trochantero-femoral union has an obliquely vertical hinge line and is perhaps slightly movable, since a femoral reductor muscle is present in each of the first and second legs (fig. 36 A, 72). The trochanter of the hind leg is a short ring-like segment (fig. 36 D, *Tr*) expanded on the posterior (mesal) surface, but so narrow externally as to be scarcely perceptible here (fig. 39, *Tr*) between the coxa and the base of the femur. It is immovably connected with the femur but not fused with it, and there is no trochantero-femoral muscle in the hind leg (fig. 39 A). The apodemes of the levator and depressor muscles of the trochanter arise from small sclerites at the base of the trochanter in the dorsal and ventral articular membranes (fig. 36 D).

The femora.—In the first and the middle leg the femur is a simple elongate segment (fig. 40, *Fm*) somewhat flattened in its antero-posterior diameter (fig. 36 C). At the distal end of the femur the anterior wall is expanded into a broad lobe that conceals the anterior femoro-tibial articulation (fig. 36 E, *l*); the ventral wall is deeply emarginate and occupied by an ample articular membrane (fig. 36 B) which allows a free flexion of the tibia beneath the femur.

The femur of the hind leg (fig. 39, *Fm*) contains the principal leaping muscles, which are the extensors of the tibiae (135); the hind femur is consequently greatly enlarged and is provided with special structural features. Its length is more than twice that of the middle femur, and its greatest vertical diameter is equal to the length of the prothoracic femur. The flat anterior and posterior surfaces (fig. 39 B) are ridged longitudinally above and below, and the space between is marked by the "fish-bone" pattern of a double series of oblique ridges. The latter separate the lines of attachment of the fiber bundles of the extensor muscles of the tibia on the inner walls of the femur (fig. 39, 135a). The distal end of the hind femur (fig. 36 F) is structurally similar to that of the first and second femora (E), but its anterior and posterior walls are strengthened by strongly sclerotized plates.

The tibiae.—The tibiae are of similar form and structure in all the legs, each being a slender shaft used as a lever rather than as a container for muscles, and so constructed that it can be folded beneath the femur. The femoro-tibial articulation is a strong dicondylic hinge (fig. 36 E, F, *l*, *m*), and the dorsal lip of the tibial base projects well within the end of the femur to give an efficient leverage to the extensor

muscles (fig. 44). The ventral, flexor muscles are inserted upon an apodeme that arises from a small sclerite in the ventral membrane of the knee joint. The knee mechanism is most strongly developed in the hind leg (figs. 36 F, 39). The base of the tibia here forms a well differentiated articular head bent toward the femur almost at right angles

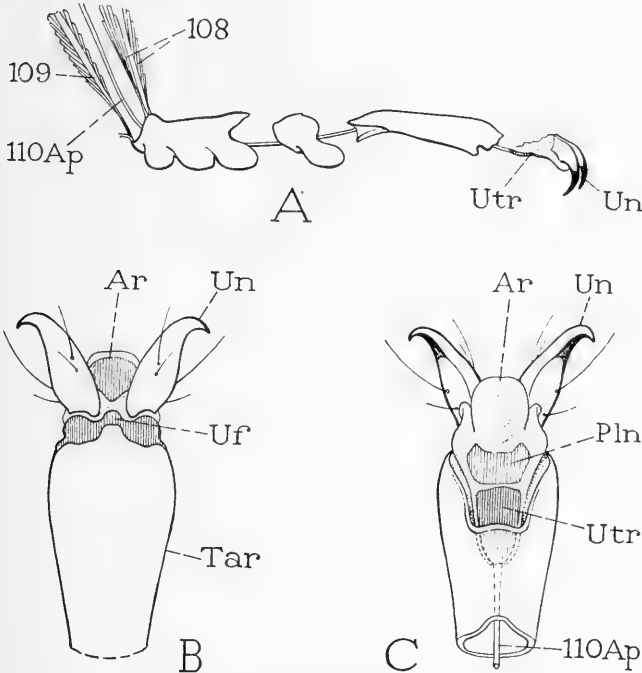

FIG. 42.—Tarsus and pretarsus of *Dissosteira*.

A, tarsus of middle leg disjunct, showing levator and depressor muscles (108, 109) inserted on basal subsegment, and tendon-like apodeme (110Ap) of retractor of claws (Un) arising on unguitractor plate (Utr) and extending through tarsus.

B, dorsal view of distal end of tarsus (Tar), arolium (Ar), and claws (Un), the latter articulated to unguifer (Uf) of tarsus.

C, ventral view of pretarsus and end of tarsus, showing planta (Pln) and unguitractor plate (Utr) in base of pretarsus.

to the length of the segment (fig. 39), and the dorsal lip of the tibial base is produced far into the end of the femur by an inflection of the articular membrane. The first and second tibiae are each provided with two rows of large, flexible, hollow spines on the distal half of the under surface, while the hind tibia has two rows of similar spines on its dorsal surface, but none on the ventral surface except at the end.

The tarsi.—The tarsi are each composed of three segment-like pieces (fig. 40, *Tar*) ; but the tarsal subdivisions, or articles, are clearly not

segments equivalent to the other parts of the leg, for they are interconnected only by infolded membranes in which there are no sclerotic points of articulation, and none, except the basal one, is ever provided with muscles (fig. 42 A). The large basal subsegment of the grasshopper's tarsus bears three pairs of cushion-like pads on its under surface; the middle subsegment has a single pair; the longer terminal one has no pads. The presence of three pads on the basal subsegment is suggestive that this piece is a composite of three primary tarsal articles. The tarsal pads have been termed *euplantulae* by Crampton (1923).

The pretarsi.—The terminal segment in each leg of the grasshopper bears a pair of large lateral *claws* (fig. 42 A, *Un*), but it is itself reduced to a simple median lobe, the *arolium* (B, C, *Ar*), and has two sclerites in its ventral wall (C, *Pln*, *Utr*). The proximal sclerite is the *unguigractor plate* (*Utr*); its base is invaginated into the end of the tarsus and gives attachment to the tendon-like apodeme (*IIoAp*) of the depressor muscle of the pretarsus, known as the retractor of the claws. A levator of the pretarsus is lacking in all insects. The distal ventral sclerite, possibly a subdivision of the unguigractor, is distinguished as the *planta* (*Pln*). The claws arise from the dorso-lateral parts of the base of the pretarsus and are articulated dorsally to the unguifer area on the end of the tarsus (fig. 42 B, *Uf*).

MUSCLES OF THE LEGS

The muscles of an insect's leg are comprised in three groups: (1) muscles that move the limb as a whole; (2) muscles that move the telopodite; (3) muscles that move the segments of the telopodite upon each other. The muscles of the first group have their origins entirely within the body; they are inserted on the base of the coxa, on the trochantin, or on apodemes arising in the coxal corium. The muscles of the telopodite arise in the coxa and within the body; they are inserted on the trochanter or on apodemes arising close to the base of the trochanter in the articular membrane of the coxo-trochanteral joint. The muscles of the individual segments of the telopodite beyond the trochanter arise in the segments proximal to their insertions; they are inserted either on the bases of the segments they move or on apodemes arising in the articular membranes.

Muscles of the leg base.—The muscles associated with the coxa that move the leg as a whole fall into three groups according to their points of origin; namely, muscles that arise on the tergum, muscles that arise on the sternum, and muscles that arise on the pleuron.

The basal leg muscles arising on the tergum comprise anterior and posterior groups of fibers, or *tergal promotors* (fig. 43 A, *I*) and *tergal remotors* (*J*). The tergal promotors are usually contained in a single muscle, which is inserted on the trochantin (*B*, *Tn*) when this sclerite is present and well developed, otherwise in the articular membrane or on the base of the coxa. The tergal remotors often form a

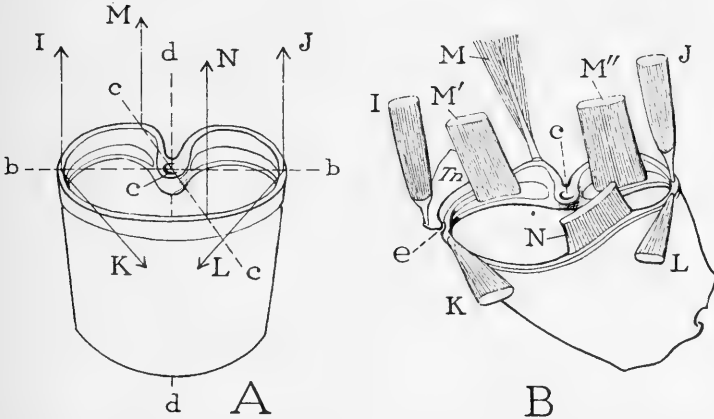

FIG. 43.—Diagrams of the cardinal axes of motion in a coxa articulated to the body by a pleural articulation only, and the coxal musculature in a wing-bearing segment.

A, mechanism of the coxal movements on the pleural articulation (*c*), inner view. The cardinal movements are: (1) *promotion* and *remotion* on a transverse axis (*c c*) by tergal promotor and remotor muscles (*I*, *J*); (2) *rotation* on a vertical axis (*d d*) by anterior and posterior sternal rotator muscles (*K*, *L*); and *abduction* and *adduction* on a longitudinal axis (*b b*) by a pleural abductor muscle (*M*), and a sternal adductor muscle (*N*) arising on sternal apophysis.

B, diagram of typical musculature of a coxa in a wing-bearing segment freely movable on the pleural articulation. *I*, promotor of coxa, tergum to trochantin; *J*, remotor, tergum to coxa; *K*, anterior rotator, sternum to coxa; *L*, posterior rotator, sternum or spinasternum to coxa; *M*, abductor, episternum to coxa; *M'*, basalar muscle, basalare to coxa; *M''*, subalar muscle, subalare to coxa (*M'* and *M''* are pleural abductors of coxa in the nymph, fig. 27 C); *N*, adductor, sternal apophysis to coxa.

group of muscles. In *Dissosteira* the tergal promotor is a single muscle for each leg: that of the prothorax (fig. 33 A, 62) is inserted on the trochantin (*Tn*); that of the middle leg is inserted by an apodeme (fig. 37 A, B, C, 89) arising between the trochanter and the coxa; whereas that of the hind leg (fig. 38 A, 118) is attached directly on the anterior angle of the coxa (A, D, F, 118). The tergal remotors of the first leg comprise a group of three muscles (fig. 33 A, B, C, D, 63, 64, 65) inserted on the posterior angle of the coxa; those of the middle leg include two muscles inserted by apodemes on the posterior angle of the coxa (fig. 37 A, B, 90, 91); and those of the hind leg em-

brace two muscles (fig. 38 A, 119, 120) similarly inserted (D, F). The two sets of tergal muscles, promoters and remoters, are clearly antagonists pulling on opposite extremities of the longitudinal basal axis of the coxa (fig. 43 A, *b-b*), the fulcrum of which is at the pleural articulation (*c*).

The sternal musculature of the coxa, when complete, includes three groups of fibers, one inserted on the anterior angle of the coxal base, one on the posterior angle, and one on the mesal rim. The first two are the *anterior* and *posterior rotators* (fig. 43 B, *K, L*) serving to turn the coxa in the plane of its base (A) on the pleural articulation (*c*). In the foreleg of *Dissosteira* an anterior rotator is lacking, but there are two posterior rotators (fig. 33 C, 66, 67), the first arising on the base of the sternal apophysis (*SA*), the other on the spina (*1Spn*); both are inserted on the posterior angle of the coxa (C, D). The middle leg has a single anterior rotator (fig. 37 A, B, 92) and a single posterior rotator (93), the first arising on the sternellar lobe of the mesosternum (fig. 35, 92), the second (93) on the spina (*2Spn*). In the hind leg there is a single, large two-branched anterior rotator of the coxa arising on the metasternum laterad of the base of the sternal apophysis (fig. 35, 121), and inserted on the anterior angle of the coxa (fig. 38 D, 121); and there are three posterior rotators (figs. 35, 38 E, 122, 123, 124) all arising from the arm of the sternal apophysis.

The mesal sternal muscle of the coxa (fig. 43 B, *N*) is the *adductor*. It pulls upward (A, *N*) on the inner end of the transverse axis (*c-c*) of the coxal base passing through the pleural articulation (*c*). In each segment of *Dissosteira* the coxal adductor arises on the under surface of the arm of the sternal apophysis (figs. 33 C, 69; 37 A, 100, 101; 38 C, D, E, F, 130).

The pleural muscles of the coxa include the functional *abductor* fibers (fig. 43 B, *M*) which directly oppose the adductor (*N*), and, in the wing-bearing segments, two other muscles (B, *M'*, *M''*) that appear to be derived from the primitive abductor system.

In the foreleg of *Dissosteira* the abductor of the coxa is a two-branched muscle (fig. 33 D, 68a, 68b) arising on the inner surface of the invaginated episternum (*Eps*). In the middle leg the abductor group comprises three distinct muscles (fig. 37 A, 94, 95, 96) all arising on the episternum. The first two are inserted by flat apodemes anteriorly on the outer rim of the coxa (B, C, 94, 95) and perhaps function here as accessory promoters. The large third muscle (A, 96), however, is inserted close before and distinctly laterad of the pleural articulation (B, *c*) by a slender apodeme (96) arising in the coxal corium, and it must be the functional abductor of the coxa. In

the hind leg there are two muscles in the abductor group (fig. 38 C, 125, 126), one being a small anterior muscle (125), apparently accessory to the promotor (A, 118), the other a large posterior muscle (C, 126) which unquestionably functions as an abductor.

The pleural muscles associated with the functional abductor muscles of the coxa in the wing-bearing segments are attached on the outer rim of the coxa (fig. 43 B, *M'*, *M''*) and, in adult insects, arise typically on the epipleural basalar and subalar sclerites (figs. 37 A, 98, 99; 38 B, 128, 129), and function as wing muscles. In some adult insects, as in *Panorpa* (fig. 14 B), the first of these muscles (*M'*) arises on a dorsal lobe of the episternum (*Ba*), which is clearly the homologue of the basalar plate or plates in other insects, such as are present in the adult of *Dissosteira* (fig. 26, *Ba*). The posterior epipleural muscle (*M''*) is always attached to the subalar sclerite in adult insects (figs. 14 B, 37 A, 38 B, *Sa*). Both muscles, however, in the nymph of *Dissosteira* (fig. 27 C, *M'*, *M''*) and in other nymphal Orthoptera, arise directly from the upper edge of the pleuron, one on the episternum, the other on the epimeron, and, if they act together, they must be abductors of the coxa. The epipleural muscles, therefore, appear to be groups of coxal abductor fibers that have become specially developed as secondary wing muscles in the adult. The first is a pronator-extensor of the wing; the second is the depressor-extensor of the wing (fig. 49, *M'*, *M''*).

The foregoing analysis of the basal leg musculature of *Dissosteira* shows that the coxa is provided with six sets of muscles, including an anterior and a posterior group of fibers arising on the tergum (fig. 43 B, *I*, *J*), an anterior and a posterior group arising on the sternum (*K*, *L*), a lateral group arising on the pleuron (*M*, and also *M'* and *M''* in the wing-bearing segments), and a mesal group arising on the sternum (*N*). The anterior and posterior dorsal and ventral muscles may be supposed to represent the theoretical primary tergal and sternal promotors and remotors of a primitive limb basis (fig. 6, *I*, *J*, *K*, *L*), which have become transferred to the coxal region (fig. 11) after the subdivision of the basis into subcoxa and coxa. The lateral and mesal muscles, therefore, are subcoxo-coxal muscles, the fibers of the first (*M*) retaining their origins on the subcoxal pleuron, those of the second (*N*) having been transferred to the sternum, perhaps by the incorporation of the ventral rim of the subcoxa into the definitive sternal plate.

Muscles that move the telopodite.—The muscles that operate the telopodite, or that part of the leg beyond the coxo-trochanteral hinge,

comprise the muscles normal to the trochanter, which are a levator and a depressor arising in the coxa (fig. 44, *O*, *Q*), and also special depressor muscles (*P*) that have their origin in various parts of the body segment carrying the leg. The basal lip of the trochanter usually projects into the coxa well beyond the line of the coxo-trochanteral hinge, thereby giving a strong leverage to the depressor muscles inserted upon it.

The branches of the trochanteral depressor arising within the body segment vary much in different insects and in different segments of

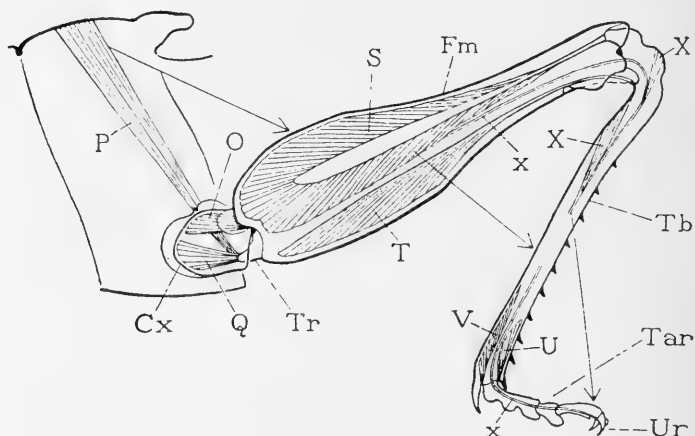

FIG. 44.—Diagram of the mechanism of the hind leg of a grasshopper.

O, levator muscle of trochanter, or extensor of telopodite, origin in coxa; *P*, body branch of depressor of trochanter, or flexor of telopodite, origin on tergum; *Q*, coxal branch of depressor of trochanter; *S*, levator of tibia; *T*, depressor of tibia; *U*, levator of tarsus; *V*, depressor of tarsus; *X, X*, tibial branches of retractor of claws; *x*, tendinous apodeme of retractor of claws arising on base of unguitractor plate.

the same insect. In the prothorax of *Dissosteira* there are three body branches of the trochanteral depressor, one arising on the episternum (fig. 33 B, *71b*), the second on the pleural arm (*C*, *71c*), and the third on the tergum (*B*, *71d*). In the mesothorax there are two body branches of the muscle, both arising on the tergum. In the metathorax a long outer branch and an inner branch (fig. 38 A, *133c*) arise on the tergum, and a short branch takes its origin on the under surface of the lateral arm of the metasternal apophysis (fig. 38 A, E, *133d*). These muscles ordinarily serve to lift the body on the legs, but those of the hind legs of the grasshopper are probably accessory to the extensor muscles of the tibiae in the act of leaping (fig. 44, *P*).

Muscles of the telopodite segments.—Since the trochantero-femoral joint usually has but little movement in insects, the muscles of the

femur arising in the trochanter are small or absent. In *Dissosteira* a posterior, or reductor, muscle only is present in the trochanter of the first leg (fig. 36 A, 72) and in that of the second leg. In the hind leg there is no movement at the trochantero-femoral joint and femoral muscles are lacking. The usual flexion between the trochanter and the femur of insects is anterior and posterior (production and reduction), and generally only a reductor muscle is present, called the "rotator" of the femur by some writers (Morison, 1927; Weber, 1929).

The femur is occupied mostly by the tibial muscles (fig. 44, *S*, *T*), but it contains also the most proximal branch of the flexor of the claws (*X*). The tibial musculature comprises levator muscles (*S*) and depressor muscles (*T*). In *Dissosteira* there are two levator muscles in each leg, a larger posterior one (fig. 36 E, 106, F, 135), and a very small anterior one (E, 105, F, 134). In the fore and middle legs the depressor of the tibia (fig. 36 B, C, 107) is larger than the levator, and it has a basal branch arising in the trochanter (*B*). In the hind leg the relative proportions of the two muscles are reversed, the posterior levator, or extensor, of the tibia consisting of the great masses of fibers arising on the ridged anterior and posterior walls of the femur (fig. 39, 135a, 135b), and including smaller branches (135c) arising on the dorsal wall in the distal part of the femur. The anterior levator of the tibia in each leg consists of a very slender bundle of fibers arising anteriorly in the base of the femur (fig. 36 A, 73) and inserted by a long, thread-like apodeme on the head of the tibia (E, 105Ap, F, 134Ap).

The tibiae contain the levator and depressor muscles of the tarsus, and the tibial branches of the flexor of the claws. The tarsal muscles are relatively largest in the fore and middle legs of *Dissosteira*; in the hind leg they occupy only the distal part of the tibia (fig. 39, 137, 138).

The tarsus contains no muscles, the tarsal segments, as before noted, being flexible upon one another but not independently movable. This condition pertains to all insects. The tarsus is traversed by the "tendon," or thread-like apodeme, of the flexor of the claws (figs. 39, 139Ap, 44, x).

The claws of insects are provided with only a flexor, or retractor, muscle, which is the depressor of the pretarsus (fig. 44 X), or the homologue of the depressor of the dactylopodite in arthropods generally. The fibers of the claw muscle arise in several groups in the tibia and femur, and are inserted on a long tendon-like apodeme that arises from the base of the unguis plate (fig. 42 C, *Utr*) and

extends through the tarsus and tibia into the femur. In *Dissosteira* two small groups of fibers of the claw muscle arise in the upper part of the tibia (fig. 39, 139*b*, 139*c*), and one arises posteriorly in the base of the femur (fig. 36 A, 78). The pull of the muscles on the tendon retracts the unguitractor plate and flexes the claws ventrally. The extension of the claws probably results from the elasticity of their basal connections and the pressure on the supporting surface.

Typically, the muscles of the pretarsus should arise in the tarsus. It is probable, therefore, that the extension of the fibers into the tibia and femur in insects (and also in chilopods and diplopods) is a secondary condition produced by a proximal migration of the primitive muscle. In Crustacea and Arachnida the pretarsus, or dactylopodite, is provided with levator and depressor muscles, both of which have their origin in the tarsus, or propodite. In some Arachnida there are two pretarsal claws, as in most insects, but the pretarsus has *lateral* articulations with the end of the tarsus, and is provided with dorsal and ventral muscles.

V. THE WINGS AND THEIR MECHANISM

The wing mechanism of the grasshopper is equally developed in each segment of the pterothorax. The hind wings, though much more extensive than the forewings, or tegmina, and probably the chief organs of flight, have no advantage over the latter except in the stronger development of the flexor apparatus. The forewings, on the other hand, have a more powerful levator equipment than the hind wings because of the presence in the mesothorax of the second pair of tergo-sternal muscles attached dorsally on the scutum (fig. 34, 84). In structure, the hind wings (fig. 45 B) differ from the forewings (A) only in the reduction of the costal area and in the great expansion of the anal area.

STRUCTURE OF THE WINGS

In general structure, articulation, and mechanism the acridid wings differ little from the wings of other Orthoptera. The tegmina when at rest are flexed over the body in a manner to form a high roof with steeply sloping sides (fig. 50 A, W_2) covering the back of the abdomen and inclosing the folded hind wings (W_3) in the space above the latter. The anal areas of the tegmina overlap dorsally in a median horizontal plane, the left tegmen being usually on top; the pre-anal areas form the lateral inclines of the tegminal roof. The bend be-

tween the two wing areas takes place along the anal fold (figs. 45 A, 50 A, *AF*), and is produced mechanically during the flexion of the wing. The broad hind wings are folded in a complicated manner, to

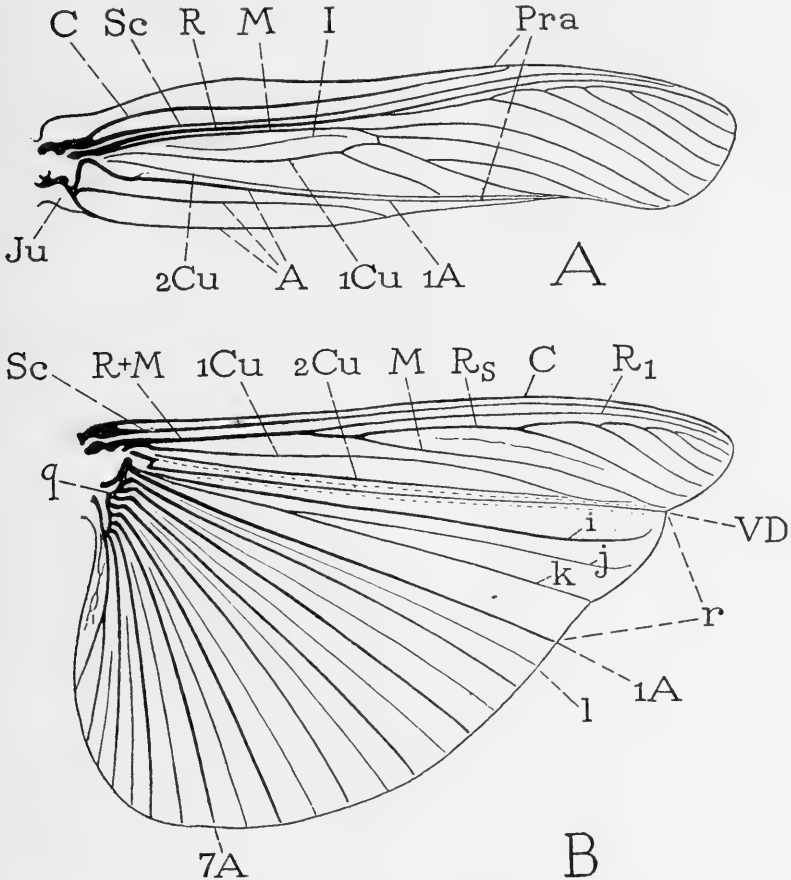

FIG. 45.—The wings and wing veins of *Dissosteira*.

A, fore wing, or tegmen. B, hind wing. A, anal veins, anal area of wing; 1A, first primary anal vein; 7A, seventh primary anal; C, costa; 1Cu, first cubitus; 2Cu, second cubitus; I, intercalary vein; i, j, secondary anal veins of first anal plait; k, first concave anal vein; Ju, jugal area of wing; l, second concave anal vein; M, media; Pra, preanal area of wing; R, radius; R₁, first branch of radius; R_s, radial sector; r, first anal plait of wing; R + M, united shafts of radius and media; Sc, subcosta; VD, vena dividens.

be described later, and when fully flexed are concealed beneath the overlying tegmina (fig. 50 A).

The area of an insect's wing presents usually three well-defined regions, namely, a *preanal region*, an *anal region*, and a small, pos-

terior, basal region, generally membranous, which Martynov (1925) terms the *jugal region*. The three wing regions are shown in typical form in the forewing of the grasshopper (fig. 45 A). The preanal region (*Pra*) is that lying anterior to the anal fold; the anal region is the region of the anal veins (*A*), the jugal region (*Ju*) is the membranous basal fold of the wing. In many insects the jugal region contains one or two definite veins unconnected basally, or an irregular network of small veins.

The hind wing of the grasshopper (fig. 45 B), and of other insects with similar fan-shaped wings, is usually regarded as differing from the forewing in the great expansion of the anal region. According to Martynov (1925), however, the true anal region of the hind wing in *Acridium* is that part (fig. 45 B, *r*) between the anal fold, or vena dividens (*VD*), and the first vein springing directly from the basal support (*q*) of the anal fan (designated *IA* in fig. 45 B). Three veins (*i*, *j*, *k*), branching from a common base, lie in this region in the wing of *Dissosteira*. The following part of the wing, or that containing the veins attached directly to the basal support (*q*) of the anal fan, Martynov claims is a development of the jugal region of the more primitive type of wing. A jugal area thus developed into a functional wing region he calls the "neala."

Martynov deduces his interpretations of the morphology of the acridid wing from a general study of the wings in other orders of insects. In *Dissosteira*, however, the vein designated *IA* in the hind wing (fig. 45 B) is so clearly the homologue of *IA* in the forewing (*A*), considering the basal relations and the connection with the third axillary sclerite (fig. 47 A, B, *3Ax*), that Martynov's interpretation is not convincing. The area (*r*) of the hind wing (fig. 45 B), lying between *VD* and *IA*, forms the first fold of the anal region (fig. 50 B) in which the vein *k* occupies the position of a "concave" vein at the bottom of the fold, while the two preceding veins (*i*, *j*) strengthen the anterior wall of the fold. The three veins of this region (fig. 45 B, *i*, *j*, *k*) are branches of the first primary anal vein (*IA*). Martynov's general study of the wing regions, however, throws much light on the wing mechanism and morphology.

Venation of the wings.—While the venation of the grasshopper's wings is comparatively simple, it is difficult to make a satisfactory interpretation of the homologies of the veins in the posterior parts of the preanal regions. If the relation of the vein bases to the axillary sclerites is taken as a guide to the identities of the veins themselves, the veins of the adult may be named consistently in the two wings, but their relation to the nymphal wing tracheae is not clear in all cases.

The forewing (fig. 45 A) has a broad anterior, or costal, area in which there is no vein represented by a costal trachea in the nymph (fig. 46 A), though the anterior margin is strengthened by a vein-like thickening. The first vein (fig. 45 A, C) is evidently the costa branching from the *subcosta* (*Sc*), though the common basal stalk has the usual relation of the subcosta to the first axillary sclerite (fig. 47 A, *1Ax*). The next vein (*R*) is unquestionably the *radius*, as shown by its distal branches and by its basal connection with the second axillary (fig. 47 A, *2Ax*). The *media* (*M*) is united proximally with the radius and with one of the median sclerites of the wing base (*m'*). The first long vein following the media is a two-branched cubitus (*1Cu*), between which and the basal part of the media is the intercalary vein (*I*). Then comes an unbranched vein, here designated *2Cu*, lying close before the anal fold (*AF*), and finally a group of three veins (*A*) connected basally with the third axillary, or flexor sclerite of the wing base (fig. 47 A, *3Ax*).

If we identify the "anal veins" as those veins lying posterior to the anal fold and connected basally with the third axillary, there are then but three anal veins in the forewing of *Dissosteira* (fig. 45 A, *A*, fig. 47 A, *1A*, *2A*, *3A*). An incomplete vein (fig. 47 A, *s*) lying just behind the anal fold (*AF*) is apparently a secondary vein. The vein immediately before the anal fold (*2Cu*) is the "first anal" of the Comstock-Needham system, but probably it is the vein regarded as a part of the cubitus by Tillyard (1919) and others, designated *Cu*₂ by Tillyard and *cubital sector* by Karny. In *Dissosteira* the vein in question has no basal connections and is here termed the *second cubitus* (*2Cu*). It clearly belongs to the cubital area of the wing. In the nymphal wing of an acridid, as illustrated by Comstock and Needham (fig. 46 A), tracheal precursors of the cubitals are not evident, since the final group of three tracheae springing from a common basal stem would appear to represent the group of three anals in the adult wing (fig. 45 A, *A*). According to Comstock (1918), however, the first vein of this group is the "cubitus" (fig. 46 A, *Cu*), and the second the "first anal" (*1A*). The identity between the nymphal tracheae and the adult veins in the forewing is certainly not clear, and no solution of the problem can be offered here.

The vein tentatively called "second cubitus" in this paper (figs. 45 A, 47 A, *2Cu*) is, by nomenclatural priority, the true anal vein, and the name "anal," though a poor designation, should be retained for it, while a new term should be devised for the veins lying posterior to the anal plica associated with the third axillary sclerite. The fan-

like wing region between the anal and jugal plicae might appropriately be called the *vannus* (Latin, fan), and its veins termed the *vannal veins*. This region plays a passive part in flight. The pre-vannal part of the wing is the true remigium (Latin, oar) of the flight mechanism, being the region of the wing directly productive of motion. We might then say that the area of the wing distal to the basal axillary region is divided into a *remigial*, a *vannal*, and a *jugal* region. The separating folds, when present, would then become the *vannal* and the *jugal* plicae. The jugal region expanded is the neala of Martynov.

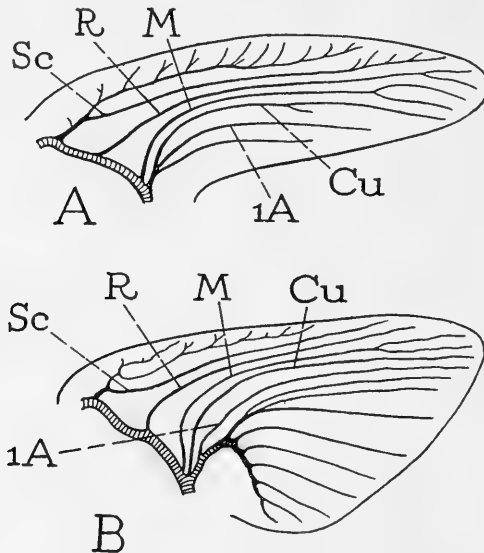

FIG. 46.—Wings of an acridid nymph. (From Comstock, after Comstock and Needham.)

A, fore wing. B, hind wing. The tracheal identifications as given by Comstock and Needham: *1A*, first anal; *Cu*, cubitus; *M*, media; *R*, radius; *Sc*, subcosta.

In the hind wing (fig. 45 B) the costa (*C*) forms the anterior margin of the wing and is united basally with the subcosta (*Sc*). The base of the subcosta (fig. 47 B, *Sc*) does not reach the first axillary sclerite (*1Ax*), evidently by reason of the reduction of the anterior process of the latter, neither does it articulate with the pre-scutal lobe of the tergum (fig. 22 A, *n*), but it is connected with the latter by a ligament-like thickening of the wing membrane (fig. 47 B, *d*). The radius (*R*) is well developed, branched distally, and connected basally with the second axillary (fig. 47 B, *2Ax*). The apparent media is united proximally with the radius; its free part con-

sists of a single branch (M) given off from the radial sector (R_s). Between the basal radio-medial shaft ($R + M$) and the first anal fold, there are two veins in the cubital area ($1Cu$, $2Cu$); the first (fig. 47 B, $1Cu$) is united proximally with the radio-media, the second ($2Cu$) has no basal connections. In the hind wing, therefore, as in the forewing, there are two distinct cubitals, here named the *first cubitus* ($1Cu$) and the *second cubitus* ($2Cu$). Each of these veins is represented by a trachea in the hind wing of the nymph (fig. 46 B); the first is the "cubitus" (Cu) of Comstock, and the second the "first anal" ($1A$). Since both of these veins lie anterior to the anal fold in the adult wing (figs. 45 B, 47 B), however, the writer would agree with Tillyard (1919) that the second is a cubital rather than an anal vein. The orthopteran wing suggests that the second cubitus has the status of an independent vein rather than that of a basal branch of the first cubitus.

The anal fold of the hind wing is double (fig. 50 B), consisting of two plicae, or lines of flexion in the wing membrane, between which lies the *vena dividens* (figs. 45 B, 47 B, 50 B, VD). According to Tillyard the *vena dividens* is the "first anal," but since it has no basal connection with the other anals (fig. 47 B), the writer would regard it as a secondary, interpolated vein. The incomplete vein of the forewing lying just behind the anal fold (fig. 47 A, s) may represent the *vena dividens* of the hind wing, but it appears rather to correspond with the vein i of the hind wing (figs. 45 B, 47 B).

The anal veins of the hind wing form a distinct group lying posterior to the anal fold. All the primary anals spring from a basal support (fig. 47 B, q) which is attached anteriorly to the distal arm of the third axillary ($3Ax$), and which, in the grasshopper, is braced posteriorly by an arm from the tergum (figs. 24, 47 B, p). There are ten primary anal veins. A fork from the first ($1A$) divides into three branches (i , j , k) lying in the first lap of the wing that folds beneath the preanal region when the wing is flexed (fig. 50 B). Alternating with the primary, or "convex," anal veins are nine secondary "concave" veins lying in the troughs of the folds between the primary anals, while the vein (k) branching from the first anal is the concave vein of the fold between the *vena dividens* and the first anal (fig. 50 B, k).

Articulation of the wings.—In the membrane of each wing base are four *axillary sclerites*. The first and the fourth (fig. 47 A, B, $1Ax$, $4Ax$) are hinge plates articulating with the edge of the tergum; the second ($2Ax$) is the pivotal sclerite of the wing base; the third ($3Ax$)

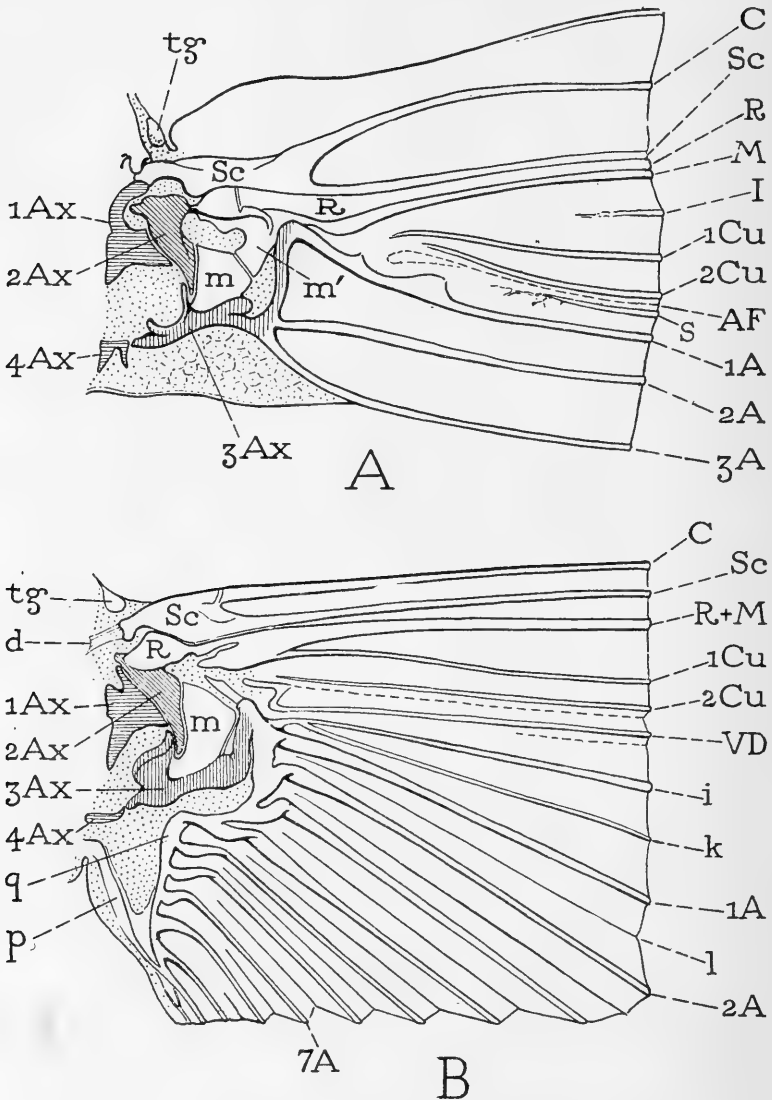
FIG. 47.—The wing bases of *Dissosteira*.

A, base of tegmen. B, base of hind wing. *1A*, *2A*, *3A*, *7A*, first, second, third, and seventh primary anal veins; *AF*, anal fold; *1Ax*, *2Ax*, *3Ax*, *4Ax*, first, second, third, and fourth axillary sclerites; *C*, costa; *1Cu*, first cubitus; *2Cu*, second cubitus; *d*, attachment of base of subcosta to prescutal lobe of tergum; *I*, intercalary vein; *i*, secondary vein of first anal plait; *k*, first concave anal vein; *l*, second concave anal vein; *M*, media; *m*, *m'*, median plates of wing base; *p*, posterior arm of tergum supporting the anal veins; *q*, basal support of anal veins; *R*, radius; *R + M*, united basal shafts of radius and media; *s*, secondary vein of fore wing behind anal fold; *Sc*, subcosta; *tg*, tegular rudiment; *VD*, vena divdens.

is the flexor sclerite. In addition to the axillaries there are two plates in the median area of the forewing (A, m, m'), and a single median plate in the hind wing (B, m).

The first axillary intermediates between the edge of the tergum and the second axillary, with each of which it is movably connected, and usually, by an anterior process, it articulates with the base of the subcostal vein. The first axillary is confined to the dorsal membrane of the wing base. In the forewing of *Dissosteira* the first axillary (fig. 47 A, $1Ax$) is a flat plate with a narrow anterior process curved outward to meet the base of the subcosta. The sclerite bridges the lateral emargination of the tergum (fig. 22 A, Em); its anterior end is supported on the anterior notal wing process (ANP), and its posterior part is hinged to the lobe of the scutum (o) behind the emargination; its oblique outer margin articulates with the second axillary (fig. 47 A). The first axillary of the hind wing of *Dissosteira* ($B, 1Ax$) is exceptional in the reduction of its anterior process which does not meet the base of the subcosta (Sc).

The second axillary presents an exposed surface in both the dorsal and the ventral membranes of the wing base. Its dorsal part forms a triangular plate (fig. 47 A, B, $2Ax$) lying lateral of the first axillary, and closely hinged to the oblique outer margin of the latter; its posterior outer margin articulates with the proximal median sclerite (m); to its anterior end is attached the base of the radius (R). The ventral part of the second axillary forms a strong, concave plate (fig. 48, $2Ax$) resting by its lower edge on the pleural wing process (WP). The second axillary differs somewhat in shape in the two wings of *Dissosteira*, as shown in the figures, but its structure and associations are the same in both.

The third axillary is developed principally in the dorsal wing membrane (fig. 47 A, B, $3Ax$), but it includes also a small sclerotization in the ventral membrane (fig. 48, $3Ax$). The dorsal part of the third axillary (fig. 47) has the form of a strong bar extending outward, in the fully-expanded wing, from the small fourth axillary ($4Ax$) to the anal veins, which latter it supports by an arm bent forward from its distal end. The mesal part of the sclerite bears a strong, elevated process on its anterior margin upon which is inserted the flexor muscle of the wing. Distal to the muscle process, the proximal median plate (m) is firmly attached to the third axillary and is functionally a part of it. In the forewing (fig. 47 A) the distal median plate (m') is hinged to the outer margin of the proximal plate.

The fourth axillary (fig. 47 A, B, *4Ax*) is a plate of the dorsal wing membrane only. It is small in each wing and serves merely as a connective between the edge of the tergum and the third axillary. It is probably a detached lobe of the tergum, since it is usually absent in insects that have a posterior notal wing process.

Beneath the base of each wing are the *epipleurites*, or small sclerites derived from the pleuron, which are intimately associated with the wing mechanism in the adult insect. In *Dissosteira* there are in each segment two episternal epipleurites, or *basalares*, (fig. 48, *1Ba₂*, *2Ba₂*, *1Ba₃*, *2Ba₃*), and a single epimeral epipleurite, or *subalare* (*Sa*). The basalares are hinged to the upper edge of the episternum (*Eps*), and are connected with the subcostal region of the wing base by a ligamentous thickening (*a*) of the ventral wing membrane. The subalare (*Sa*) lies free in the subalar membrane behind the wing process, but it is connected with the ventral plate of the second axillary (*2Ax*) by a thickening (*b*) of the intervening membrane.

THE WING MECHANISM

Flying insects are unquestionably descended from wingless ancestors. When paranotal lobes were first evolved on the thoracic segments, the insect was already organized for terrestrial locomotion—there was no provision for future organs of flight. When movable wings were evolved from the paranotal lobes, they had available for their purposes only a motor mechanism developed for other purposes. It needed but an area of flexibility at the base of each paranotal extension to convert the lobe into a movable flap. The dorsal ends of the pleura, previously supporting the bases of the paranotal lobes, easily became fulcra on which the wing flaps could rock up and down. A contraction of the longitudinal muscles of the dorsum could now give a down-stroke to the wing flaps by producing an upward curvature in the tergal plates of the wing-bearing segments, and probably at first the elasticity of the terga sufficed to produce the up-stroke. Thus, apparently, by the simple device of becoming flexible at their bases, the paranotal lobes became wings that could be weakly flapped up and down by the simple motor equipment already at hand.

Modern insects, however, have added much to the primitive wing mechanism. In each of the wing-bearing segments there are powerful tergal-depressor muscles, which, since they do not occur in the prothorax or in the segments of the abdomen, are probably specially developed wing muscles, though they may be supposed to have been evolved from small, lateral tergo-sternal muscles such as are usually

present in the abdomen. Being attached ventrally on the sternum, these muscles indirectly impart a strong up-stroke to the wings by flattening the dorsal curvature of the tergum. The down-stroke of the wings produced by the contraction of the longitudinal dorsal muscles has been strengthened in two principal ways: first, by the obliteration of the secondary intersegmental membranes between the terga, thus eliminating lost motion; and second, by the great enlargement of the dorsal muscles themselves in the wing-bearing segments.

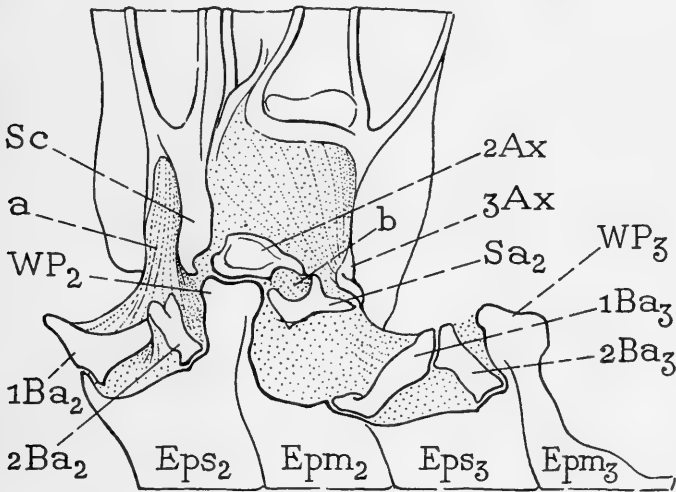

FIG. 48.—Ventral surface of the base of the left tegmen, and upper part the pleuron of *Dissosteira*.

a, thickening of membrane uniting basal sclerites with humeral angle of wing; *2Ax*, ventral plate of second axillary; *3Ax*, ventral plate of third axillary; *b*, connection between subalar sclerite and ventral plate of third axillary; *1Ba*, first basalare; *2Ba*, second basalare; *Sc*, base of subcostal vein; *Sa*, subalare; *WP*, pleural wing process.

The suppression of the intertergal membranes has been accomplished by a fusion between the successive tergal plates, or by a forward extension of the precostal lip of the tergum until it meets the posterior edge of the preceding tergum. Thus are produced the post-notal plates between the mesothoracic and metathoracic terga, and between the metathoracic and first abdominal terga. The enlargement of the dorsal muscles has been accompanied by the development of supporting plates (phragmata) from the ridges of the muscle attachments on the primary intersegmental folds. Furthermore, each tergal plate has been strengthened and better adapted to its function in the flight mechanism by the development of internal ridges, the principal

ones of which are so arranged as to bring the peak of the curvature in the tergum on a transverse line between the wing bases.

The Odonata are commonly said to have a wing mechanism quite different from that of other insects. On the basis of von Lendenfeld's (1881) description of the odonate wing muscles, the dragonflies have been supposed to be equipped with a special set of muscles inserted directly on the wing bases. A study of the thoracic musculature in either the Anisoptera or the Zygoptera, however, will show that there are only two small muscles that can be regarded as special wing muscles; one of these is accessory to the pronator of the wing, the other to the depressor. The large pronator and depressor muscles, though they arise ventrally on the lower edge of the pleuron and are inserted directly on the two basal plates of the wing, are evidently the homologues of the basalar and subalar muscles of other insects. Two smaller muscles lying mesad of the pronator are clearly leg muscles since they have their origins on the coxa and their insertions on the extreme lateral edge of the tergum. Von Lendenfeld ascribed these muscles to the wings; he describes them as arising on the pleuron and as inserted on the wings. Each wing has a homologue of the flexor muscle in other insects, though it does not function as such because of the lack of a flexor mechanism in the base of the odonate wing. The tergo-sternal muscles are highly developed, their ventral attachments are on the sternum and their dorsal attachments on the antero-lateral lobes of the tergum. The dorsal longitudinal muscles are reduced to a pair of small, divergent fiber bundles attached anteriorly on the median apodemal spine of the tergum, and posteriorly on the anterior margin of the following tergum. The wing mechanism of the dragonflies is thus merely an extreme modification of that common to all insects.

A wing, in order to be an efficient organ of progressive flight, must be capable not only of an up-and-down movement, but also of anterior and posterior movements accompanied by a partial rotation on its long axis. The anterior margin of the wing must be brought forward and deflected during the down-stroke, and lifted with a posterior movement during the up-stroke. The rotary movement of the insect's wing is caused partly by the structure of the wing itself and its response to air pressure, and partly by the nature of the wing articulation on the body, but it is greatly augmented by muscles that pull downward on the base of the wing, one before the pleural fulcrum, the other behind it. These muscles are inserted on the basalar and subalar sclerites beneath the wing base (fig. 48, *Ba*, *Sa*). Two of them

are evidently muscles of the leg that have been taken over into the service of the wing, for they are attached ventrally on the coxa (fig. 49, M' , M''); the other (E) arises on the sternum, or in some insects on the pleuron, and is perhaps a specially developed wing muscle. The two muscles of the basalar sclerites (E , M') are called *pronators* because they deflect the costal wing margin. The muscle of the subalar sclerite (M'') not only deflects the posterior part of the wing, but it acts as a powerful depressor of the entire wing by reason of its connection (b) with the ventral plate (c) of the second axillary ($2Ax$). These muscles probably also enable the insect to alter its course during flight, and, by changing the plane of the wing movements, to hover in the air, or to fly sidewise or backward.

Finally, most insects have found it advantageous to fold the wings posteriorly over the body. The folding of the wings has involved the development of a mechanism for their flexion and extension. The ability of the wing to be flexed depends upon the mechanism of its axillary region, but the flexing is caused by one or more *flexor muscles* arising on the pleuron and inserted on the third axillary sclerite (fig. 49, D). The extension of the wing is produced by the basalar and subalar muscles (E , M' , M''). Considering the other functions of these muscles, the first, therefore, is a *pronator-extensor* of the wing, the second a *depressor-extensor*.

The special features in the mesothorax and the metathorax of the grasshopper that contribute to the mechanism of the wings have been described in Section II of this paper. It was there shown that the fusion of the pleurites and sterna of the mesothorax and metathorax converts these segments into a strong trough-like structure covered dorsally by the two wing-bearing terga. The union of the pleural and sternal elements in the pterothorax is probably a direct adaptation to the leaping function of the hind legs, but the resulting structure also gives a strong framework for the support of the wings and the wing muscles. The tergal plates are separated from the edges of the pleurosternal trough by the ample membranes of the wing bases, and they are thus free to respond to the downward pull of the tergo-sternal muscles. The close union of the terga (fig. 25) and the great size of the dorsal muscles (fig. 34) give efficiency to the latter as elevators of the wings. When the wings are spread they are pivoted on the pleural wing processes by the second axillary sclerites of their bases, and, being closely hinged to the terga by the first and fourth axillaries, they are sharply thrown upward when the tergal plates are depressed, and are turned downward when the terga are elevated.

The mechanism for extending and flexing the wing is highly complex. The muscles that produce the movements of extension and flexion depend for their effect on the details of shape and inter-relationships in the axillary sclerites, on the articulation of the sclerites with the tergum and pleuron, on their connections with the bases of the wing veins, and on the structure of the wings themselves.

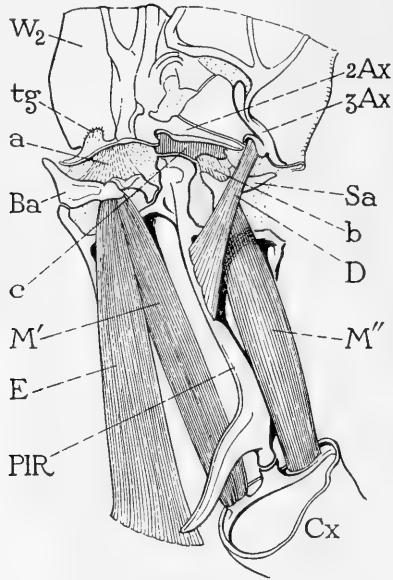

FIG. 49.—The pleural elements of the wing mechanism in the mesothorax of *Dissosteira*.

a, thickening of cuticular membrane uniting basalare sclerites with humeral angle of wing (see fig. 48); *2Ax*, second axillary; *3Ax*, third axillary (first and fourth axillaries removed); *b*, thickening of cuticular membrane uniting subalare sclerite (*Sa*) with ventral plate (*c*) of second axillary; *Ba*, first basalare; *c*, ventral plate of second axillary resting on pleural wing process (see fig. 48); *D*, flexor muscle of wing, inserted on third axillary; *E*, pleuro-sternal muscle, or first pronator-extensor of the wing, inserted on basalare sclerite; *M'*, episternal pleuro-coxal muscle, or second pronator-extensor of the wing, inserted on basalare sclerite; *M''*, epimeral pleuro-coxal muscle, or depressor-extensor of the wing, inserted on subalare sclerite; *PIR*, pleural ridge; *Sa*, subalare; *tg*, tegular rudiment; *W₂*, base of tegmen, showing dorsal surface.

During extension and flexion the wings do not simply turn forward and backward on the pleural wing processes, since each wing is attached to the tergum by its entire basal width. The horizontal movements of the wings are made possible mainly by the flexible lines in the wing bases and by the articulations of the axillary sclerites on one another. The working of the parts involved may be easily observed in a freshly killed specimen if the extended wing is slowly flexed.

In the fully extended wing of *Dissosteira* the axillary sclerites lie approximately flat and in the same plane as the general wing surface (fig. 47 A, B). When the wing is turned posteriorly, however, the axillaries take different positions. In the living grasshopper it is probable that the first movement of flexion is produced by the elasticity of the wing base when the extensor muscles are relaxed, for the wing of a dead specimen automatically assumes a partly flexed position. The fully flexed and folded condition, however, undoubtedly depends on the pull of the flexor muscle (fig. 49, D) on the third axillary.

On the relaxation of the wing, the initial flexing causes the outer end of the third axillary to turn upward, and the pull of the flexor muscle brings this sclerite to a vertical position. The movement of the third axillary turns the attached median plate (m) likewise to a vertical position on its hinge with the second axillary ($2Ax$). In the forewing (A), the revolution of the first median plate (m) draws the second median plate (m') inward. The second median plate, however, is firmly attached to the united bases of the median, radial, and subcostal veins, and the head of the radius (R) is flexibly attached to the anterior end of the second axillary. As a consequence, the movement of the first median plate turns the entire anterior part of the wing posteriorly on the hinge between the radius and the second axillary. But, since the basal connection of this part of the wing forms an oblique line from the head of the first axillary to the articulation between the two median plates, the entire preanal area of the wing is deflected as it turns posteriorly. At the same time, the anal area is lifted but maintains its horizontal plane as the third axillary assumes a vertical position. When the wing finally comes to a longitudinal position over the back, therefore, the anal area is uppermost and the preanal area slants downward on the side (fig. 50 A). During the final revolution of the wing the first axillary turns upward on its hinge with the tergum, the second axillary rotates slightly on the pleural wing process, and the third axillary revolves posteriorly in its vertical position on the fourth axillary.

In the hind wing the mechanism of flexion is in general the same as that of the forewing, but, in addition to the posterior turning of the wing, the great anal area is folded fan-like into many plaits. The third axillary of the hind wing (fig. 47 B, $3Ax$) is relatively much larger than that of the forewing (A), its muscle process stands out prominently from the shaft, and the flexor muscle inserted on it consists of two bundles of fibers. A distal median plate is lacking in the hind wing, but the single plate (A, m) attached to the third ax-

illary affects the anterior group of veins in the same manner as does the corresponding plate of the forewing.

When the distal part of the third axillary is lifted by the pull of the flexor muscle, the median plate turns the preanal area of the wing posteriorly and toward the body, and at the same time deflects it to an almost vertical position, with the costal margin downward. The wing surface makes a double fold along the vena dividens (figs. 45 B, 50 B, *VD*), and the area between the vena dividens and the

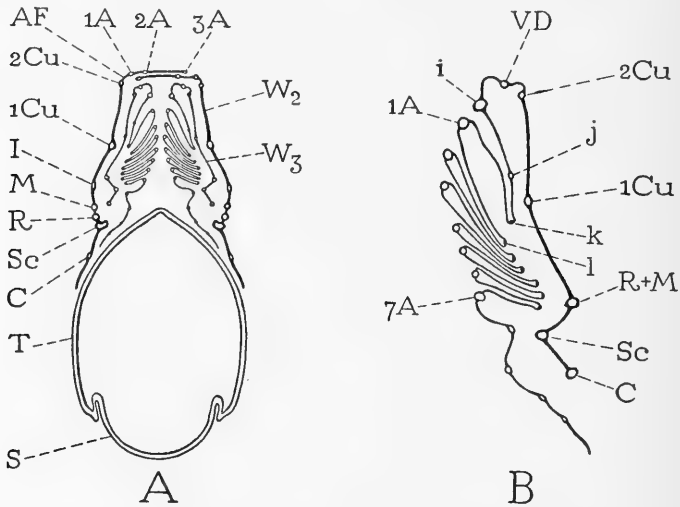

FIG. 50.—Positions of the flexed wings of *Dissosteira*.

A, vertical cross-section through fourth abdominal segment, with wings folded over body, seen from behind. B, section of right hind wing more enlarged.

1A, *2A*, *3A*, *7A*, first, second, third, and seventh primary anal veins; *AF*, anal fold; *C*, costa; *1Cu*, first cubitus; *2Cu*, second cubitus; *I*, intercalary vein; *i*, *j*, secondary veins of first anal plait; *k*, first concave anal vein; *l*, second concave anal vein; *M*, media; *R*, radius; *R + M*, combined basal shafts of radius and media; *S*, sternum; *T*, tergum; *VD*, vena dividens.

first principal anal vein (*1A*) is folded outward beneath the preanal area, with the secondary vein *k* in the ventral angle of the fold (fig. 50 B). While these maneuvers are taking place in the anterior and middle parts of the wing, the anal fan is bent downward as it comes against the side of the abdomen, and its ventral surface is turned outward beneath the deflected preanal area. The membrane of the fan is plaited between each two of the first seven principal anal veins (fig. 50 B, *1A-7A*), with the secondary veins occupying the ventral lines of the folds. The posterior part of the fan spreads out against the upper part of the side of the abdomen (A).

A careful study of the forms of the folded wings of the grasshopper, as seen in transverse section (fig. 50), will suggest that many details of structure, both in the tegmina and in the hind wings, are adaptations to the passive state of flexion rather than to the active phases of flight.

The extension of the wings is effected probably by the action of both the basalar and the subalar muscles (fig. 49 E, M' and M''). The basalar sclerites (fig. 48, $1Ba$, $2Ba$) are connected by a tough membranous fold (a) with the base of the wing anterior to the wing process. A depression of these sclerites on their episternal articulations, caused by the contraction of their muscles (fig. 49, E, M'), must therefore release the flexed wing from its position over the body and turn it outward. The principal extensor of the wing, however, appears to be the muscle of the basalar sclerite (fig. 49, M''). In the flexed wing, the second axillary sclerite is elevated between the first axillary on the one hand, which now stands in a vertical plane on its tergal hinge, and the median plate (m) on the other, which rises vertically from its hinge on the second axillary. The ventral plate of the second axillary is connected with the subalar sclerite by a thickening of the intervening membrane (figs. 48, 49, b). The downward pull of the basalar muscle (fig. 49, M'') is therefore exerted on the second axillary. It is easy to demonstrate that a downward pressure on the second axillary flattens the entire wing base by restoring the first axillary, the median plate, and the third axillary to the horizontal plane, and thereby extends the wing.

When the wings are extended, the mechanism of flight becomes operative. This includes the direct and indirect muscles, which accomplish the movements of levation, depression, and rotation, and which have already been described.

VI. THE SPIRACLES

The generalized ancestors of modern insects possibly had a pair of tracheal invaginations on each of the 17 body segments between the primitive head, or procephalon, and the periproct. Evidence of the existence of such invaginations has been found, however, on only 14 segments, namely, the second maxillary segment, the three thoracic segments, and the first ten abdominal segments.

Tracheal invaginations of the second maxillary segment have been reported by Nelson (1915) to be present in the embryo of the honeybee. They arise, Nelson says, on the lateral surfaces of the anterior half of the segment above the bases of the rudiments of the second

maxillae, shortly behind the boundary between the first and second maxillary segments. The second maxillary spiracles have thus the same relative position on their segment as have all the body spiracles in the embryo, or the abdominal spiracles in adult insects. The embryonic invaginations of the labial segment, according to Nelson, give rise to a part of the tracheal system of the head, but are later closed and leave no external trace of their existence in the adult insect.

Prothoracic spiracles are known to exist as functional organs of the adult only in some of the Sminthuridae (Collembola). They are situated laterally in the neck membrane close to the posterior margin of the head, but Davies (1927) claims that the region bearing the spiracles belongs to the prothorax. These cervical or prothoracic spiracles are the only spiracles present in the Sminthuridae, and no other collembolan is known to possess either spiracles or tracheae in any part of the body. Temporary prothoracic spiracles, followed by the usual series of spiracular invaginations, have been described in the embryo of *Blattella* by Cholodkowsky (1891), and in the embryo of *Leptinotarsa* by Wheeler (1889).

The usual first pair of thoracic spiracles of adult, nymphal, and larval insects is always situated either in the posterior part of the prothorax or in the intersegmental membrane between the prothorax and the mesothorax. In the embryos of most insects, however, these spiracles are said to lie anteriorly in the mesothorax; they would appear, therefore, to be the true mesothoracic spiracles which have become prothoracic in position by a secondary forward migration. The usual second pair of adult thoracic spiracles are the embryonic metathoracic spiracles, and they sometimes occur on the anterior part of the metathorax in the adult, though more commonly they lie in the membrane between the mesothorax and the metathorax, or in the posterior part of the mesothorax. The segmental relations of the thoracic spiracles is somewhat complicated by the fact that the muscles of their closing apparatus have their origins in the segments on which the spiracles are situated in the adult. Since, however, the musculature of the thoracic spiracles is not alike in different groups of insects and is often different in the two spiracles of the same insect, it is probably of secondary development in all cases.

Contrary to the embryological evidence of the segmental relations of the spiracles, there are many points in the anatomy of the tracheal system, and in the innervation of the spiracular muscles, that suggest, as now claimed by several writers, that the spiracles are primarily intersegmental invaginations, and that their definitive positions are

the result of migrations either forward or rearward into the segmental regions of the body.

The abdominal spiracles are situated, with few exceptions, on the anterior lateral parts of the abdominal segments, where they lie in the tergal plates, between the terga and the sterna, or in the edges of the sterna. There are usually eight pairs of abdominal spiracles in adult and larval insects, though the number may be variously reduced. There is evidence, however, of more than eight spiracles having been present on the abdomen of primitive insects. Cholodkowsky (1891) reports the existence of a pair of tracheal invaginations on the first nine abdominal segments of *Blattella*, and Heymons (1897) says there are apparent rudiments of spiracles on the tenth abdominal segment of *Lepisma*. In certain insects the spiracles of the first abdominal pair are situated very close to the base of the metathorax, and long discussions recur as to whether these spiracles belong to the thorax or to the abdomen. In all cases, however, it will be found that the spiracles in question lie posterior to the third phragma, which marks the intersegmental line between the metathorax and the first abdominal segment, or behind the lateral extensions of the postnotal plate in the metathorax. The spiracles are therefore abdominal, as is shown also by the destination of their tracheae.

The external aperture of a spiracle may be a simple opening leading directly from the exterior into the trachea. In most cases, however, there is a pre-tracheal chamber, or *atrium* (fig. 53 A, B, *Atr*), formed by an inflection of the body wall, from the inner end of which arises the trachea (*Tra*). The atrium of the spiracle, therefore, appears to be a secondary invagination of the body wall, which has carried the mouth of the original tracheal invagination to a more protected position beneath the surface. In some cases the edges of the atrial orifice are elevated to form a pair of protruding lips guarding the entrance (fig. 53 A, *c, d*), in others the opening is fringed with opposing brushes of hairs, usually thickly branched, or it is itself reduced to a very small diameter.

Spiracles are usually provided with a closing apparatus. In the Apterygota the spiracles are said to lack an oclucosor mechanism (Du Buisson, 1926; Davies, 1927), and the thoracic spiracles of Plecoptera are simple apertures giving open passages into the tracheae. In general, however, the spiracles have either a device for closing the outer lips of the atrial chamber, or an apparatus for blocking the passage from the atrium into the tracheae. The oclucosor mechanism of the abdominal spiracles is of the second type; that of the thoracic

spiracles may be of similar structure (caterpillars and other larvae), but usually the closing apparatus of the thoracic spiracles in adult insects effects a movement of one or both of the outer lips of the atrial chamber.

The Acrididae possess the two usual pairs of thoracic spiracles and eight pairs of abdominal spiracles. The first thoracic spiracle on each side is situated laterally in the ample intersegmental membrane between the prothorax and the mesothorax (fig. 20 B, 26, *Sp*₂) where it is covered externally by the lateral part of the large posterior fold of the protergum (fig. 20 B, *Rd*). The second spiracle lies in the posterior ventral angle of the mesothoracic epimeron just above the base of the middle leg and immediately before the intersegmental groove between the mesopleuron and the metapleuron (fig. 26, *Sp*₃). The abdominal spiracles are carried by the first eight abdominal terga, each being placed in the lower anterior angle of the corresponding tergal plate. The first of the series, therefore, lies in the tympanal cavity of the first segment, where it is situated on the small triangular area before the tympanal membrane and just in front of the support of the chordotonal organ. All the spiracles are well developed, and each is provided with an efficient closing apparatus, the mechanism of which presents the usual two types of structure, the first pertaining to the thoracic spiracles, the second to the abdominal spiracles. The details of structure, however, are quite different between the two thoracic spiracles.

The first thoracic spiracle.—The first spiracle of the thorax of *Disosteira carolina* is contained in a small, irregular plate, or *peritreme* (fig. 51 A, *Ptr*), lying laterally in the intersegmental membrane between the prothorax and mesothorax (fig. 20 B, *Sp*₂), covered externally by the overlapping fold of the protergum. The lower end of the peritreme is produced posteriorly and upward in a small, free process (fig. 51 A, *a*), bearing on its base a flat-topped, pale-colored tubercle (*b*) projecting outward. The tubercle is a little higher than the lips of the spiracle and evidently serves as a stop to prevent the covering flap of the protergum from resting too closely against the spiracle. The spiracular opening is an obliquely vertical slit with a slight italic curve and strongly protruding anterior and posterior lips (*c*, *d*). The length of the slit is about 0.60 mm. in the male grasshopper, and about 0.75 mm. in the female. The anterior lip (*c*) is a rigid elevation of the wall of the peritreme; its inner face is soft and deeply grooved parallel with the outer edge. The posterior lip (*d*) is a weaker and freely-movable flap, but it has a sharp,

strongly-sclerotized marginal band (*e*) which, when the spiracle is closed, fits into the groove of the anterior lip.

The cleft of the first spiracle opens into a shallow atrium from which are given off two tracheae, a larger dorsal one (fig. 51 B, *f*) and a smaller ventral one (*g*). From without, therefore, the first spiracle appears to have a double opening (A, *f*, *g*). In some of the Orthoptera that have tympanal organs on the front legs, the trachea of the ventral (or posterior) opening of the spiracle appears to have become specialized as an "acoustic" trachea since it goes only to the

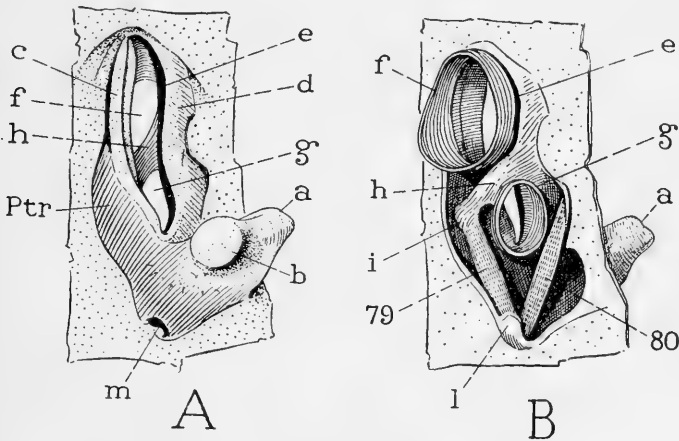

FIG. 51.—First thoracic spiracle of *Dissosteira*.

A, outer view of left spiracle. B, inner view of right spiracle. *a*, ventral lobe of peritreme; *b*, process of peritreme protecting spiracle from covering flap of pronotum; *c*, anterior lip of spiracle; *d*, posterior lip of spiracle; *e*, hard edge of posterior lip; *f*, dorsal trachea; *g*, ventral trachea; *h*, internal lever of posterior lip forming a septum between the tracheae; *i*, head of lever on which closing muscle (*79*) is inserted; *l*, ventral internal process of peritreme on which spiracular muscles arise; *m*, external pit forming internal process *l*; *Ptr*, peritreme; *79*, opening muscle; *80*, closing muscle.

front leg, where it branches into the two tracheae of the tympanal organ. This fact led Graber to the conclusion that the double structure of the first spiracle in Orthoptera originated from the separation of an "acoustic" trachea from the general respiratory tracheae of the prothorax. Carpentier (1924, 1925), however, has shown that the double first spiracle is a character of Orthoptera in general, whether tympanal organs are present in the front legs or not, and that in most forms the tympanal trachea is not isolated from the rest of the respiratory system. The specialization, he says, is carried to its highest degree in the tettigoniid *Phasgoneura viridissima*, where the spiracular orifice of the leg trachea is enormously enlarged. Here, ap-

parently, is a case of an advantage derived by a specific organ from a general structure first developed for some other reason.

In the septum between the two spiracular openings in *Dissosteira* (fig. 51 A, *h*) is a strong internal bar (B, *h*) projecting anteriorly and ventrally from the posterior lip of the spiracle, and terminating in a free process (*i*) that extends anterior to the spiracular opening. Upon this process is inserted a short muscle (79) which has its origin ventrally on an inner process (*l*) of the lower angle of the peritreme, the site of which is marked externally by a pit (A, *m*). A second muscle (B, 80) arises from the base of the same process (*l*) and extends dorsally and posteriorly to its insertion on the base of the posterior lip of the spiracle behind the ventral trachea. The first muscle (79) is the occlusor of the spiracle; the second (80) is evidently its antagonist. A downward pull on the head of the septal arm (*i*), where the anterior muscle is inserted, closes the spiracle by rotating the movable posterior lip forward on its dorsoventral axis and bringing thus its sharp free edge into the groove of the anterior lip. Conversely, a downward pressure on the base of the posterior lip, at the point where the posterior muscle (80) is inserted, rotates the lip in the reverse direction and opens the spiracle. The differential action of the two muscles results from the opposition of their two points of insertion on either side of the long axis of the posterior lip, and is accentuated by the difference in their points of origin on the ventral process (*l*) of the peritreme. Vinal (1919), Lee (1925), and other writers have regarded both muscles of the first spiracle in Acrididae as occlusors.

The second thoracic spiracle.—The second thoracic, or metathoracic, spiracle of *Dissosteira* is located in the lower, posterior angle of the mesothoracic epimeron of the adult (fig. 26, *Sp*₃), where it is surrounded by a narrow membranous area (fig. 52 A, *mb*). Externally this spiracle presents two thick, elongate oval, valve-like lips, (fig. 52 A, *c*, *d*) separated by a sinuous vertical cleft having a length of about 0.50 mm. in the male insect. Both lips of the second spiracle are movable, though they are united ventrally in a broad lobe (*n*). The spiracular lips stand out prominently from the body wall (fig. 53, A, *c*, *d*), and between them is a shallow atrium (*Atr*) from which arises a single large trachea (*Tra*) that soon divides into a dorsal and a ventral branch. The closing mechanism of the second spiracle includes but a single short occlusor muscle (fig. 52 B, *III*). The muscle arises ventrally from a small process (*o*) on the posterior dorsal margin of the mesocoxal cavity, and is inserted on the ventral

lobe (*n*) of the spiracle. There is no special device for opening this spiracle; the lips diverge by their own elasticity, as is shown by the fact that the spiracle is always open in a dead insect. The occlusor muscle brings the edges of both lips together.

The abdominal spiracles.—The eight spiracles of the abdomen in *Dissosteira* are quite different from either of the thoracic spiracles. They are not provided with projecting external lips (fig. 53 B), the body wall being directly inflected in each spiracle to form an open atrial chamber (*Atr*). The atrium leads by a narrowed aperture at

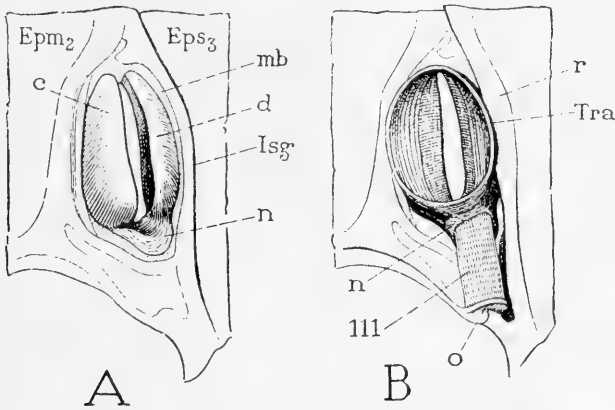

FIG. 52.—Second thoracic spiracle of *Dissosteira*.

A, outer view of left spiracle. B, inner view of right spiracle. *c*, anterior lip of spiracle; *d*, posterior lip of spiracle; *Epm*₂, epimeron of mesothorax; *Eps*₃, episternum of metathorax; *Isq*, intersegmental fold; *mb*, membrane surrounding spiracle; *n*, ventral lobe of spiracle uniting the lips and giving insertion to spiracular muscle (*III*); *o*, internal lobe on rim of coxal cavity on which spiracular muscle arises; *r*, internal intersegmental fold; *Tra*, trachea; *III*, closing muscle of spiracle.

its inner end into the spiracular trachea (*Tra*), and the occlusor mechanism regulates this opening.

The longer axis of the first abdominal spiracle is obliquely horizontal (fig. 54 A) with the anterior end a little higher than the posterior. The other spiracles (C, D) are placed more nearly vertical, so that the dorsal end of each corresponds with the anterior end of the first spiracle. In each spiracle one wall of the atrium is rigid (fig. 53 B, *t*), and the other (*s*) is movable. The rigid wall is dorsal in the first spiracle (fig. 54 A, *t*) and posterior in the other spiracles (C, D). It is strengthened by a thickening in the external body wall (figs. 53 B, 54 A, *u*) from which it is inflected. The movable wall of the atrium (*s*), which is ventral in the first spiracle (fig. 54 A)

and anterior in the others (C, D), is flexible because the body wall immediately external to it is weak, and because the two end walls of the atrial chamber are membranous. The posterior or ventral end of the movable wall is produced into a long, free manubrium (fig. 54 B, D, *q*) that projects into the body cavity and gives attachment to two muscles, one dorsally, the other ventrally. These muscles, acting antagonistically, either close or open the passage from the atrium into the trachea (fig. 53 B) by means of their attachments on the movable wall of the atrium.

The short dorsal muscle of the first abdominal spiracle (fig. 54 B, *CMcl*) arises on the rim of the tympanum (*p*) above the spiracle;

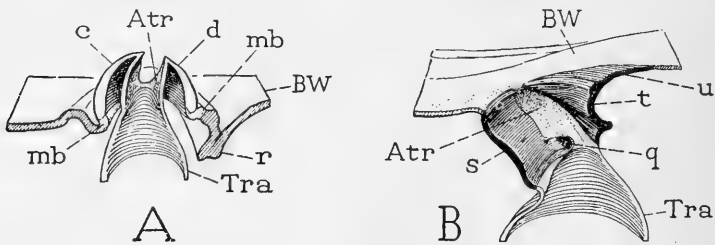

FIG. 53.—Sections of spiracles of *Dissosteira*.

A, longitudinal section through second thoracic spiracle, showing anterior and posterior lips (*c*, *d*) as projecting folds of body wall (*BW*) inclosing an atrium (*Atr*), or entrance to trachea (*Tra*).

B, vertical section through first abdominal spiracle, showing direct inflection of body wall to form atrial chamber (*Atr*), of which anterior wall (*s*) is movable, and posterior wall (*t*) immovable.

Atr, atrium; *BW*, body wall; *c*, anterior lip of spiracle; *d*, posterior lip of spiracle; *mb*, membrane surrounding lips of spiracle; *q*, manubrium or muscle process of ventral wall of atrium; *r*, intersegmental fold; *s*, ventral wall of atrium; *t*, dorsal wall of atrium; *Tra*, trachea; *u*, plate in tergal wall supporting dorsal wall of atrium.

the long, slender ventral muscle (*OMcl*) arises ventrally on an inflection of the integument mesad of the hind coxa and posterior to the triangular coxal plate of the metasternum (fig. 30 A, *t*). It is easy to demonstrate that the dorsal muscle (fig. 54 B, *CMcl*) is the closer of the spiracle and the ventral one (*Omcl*) the opener. A dorsal pull upon the manubrium (*q*) of the movable ventral wall of the atrium (*s*) brings the inner edge of the latter against the inner edge of the fixed dorsal wall (*t*) and thus closes the passage from the atrium into the spiracular trachea. By a counter movement the passage is opened.

The mechanism of the other abdominal spiracles is the same as that of the first. The short, fan-shaped occluder muscle (fig. 54 C, D,

CMcl) arises on the wall of the tergum immediately behind the spiracle, and is inserted on the manubrium of the movable wall of the atrium (*q*), which projects ventrally and posteriorly. The long opening muscle (*OMcl*) arises on the lateral edge of the corresponding sternum and extends posteriorly and dorsally to its insertion on the manubrium.

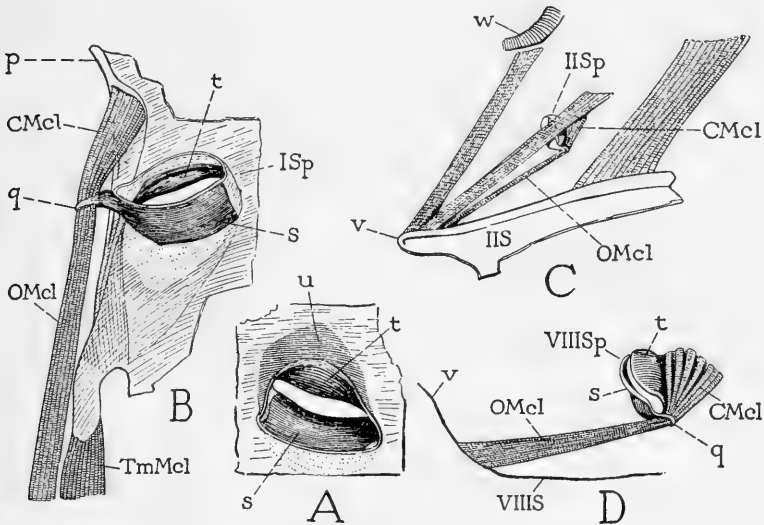

FIG. 54.—Abdominal spiracles of *Dissosteira*.

A, first abdominal spiracle, left, outer view. B, inner view of the same spiracle, showing muscles. C, second abdominal spiracle, right, inner view, with tergo-sternal muscles of second abdominal segment. D, eighth abdominal spiracle, right, inner view.

CMcl, closing muscle of spiracle; *ISp*, first abdominal spiracle; *IIS*, second abdominal sternum; *IISp*, second abdominal spiracle; *OMcl*, opening muscle of spiracle; *p*, anterior margin of tympanal cavity; *q*, manubrium of ventral or anterior wall of atrial chamber; *s*, movable ventral or anterior wall of atrial chamber; *t*, fixed dorsal or posterior wall of atrial chamber; *u*, thickening of tergal wall supporting dorsal or anterior wall of atrial chamber; *v*, anterior apodermal arm of abdominal sternum; *VIIS*, eighth abdominal sternum; *VIISp*, eighth abdominal spiracle; *w*, posterior angle of tympanal cavity.

The grasshoppers are abdominal breathers. A discussion of the mechanism of respiration would, therefore, lead too far beyond the anatomical limits of the present paper. Recent studies on the breathing of Orthoptera give such varied and conflicting results that we must conclude either that the subject still needs a critical investigation or that the insects have no fixed methods of respiration. The weight of evidence is rather in favor of inconsistency on the part of the insects.

ABBREVIATIONS USED ON THE FIGURES

- A*, Anal veins. *1A*, *2A*, etc., first anal, second anal, etc.
Ac, antecosta.
acs, antecostal suture.
Acx, precoxal bridge.
AF, anal fold.
ANP, anterior notal wing process.
Ap, apodeme.
Ar, arolium.
Atr, atrium.
Aw, prealar arm of tergum.
Ax, axillary sclerite. *1Ax*, *2Ax*, *3Ax*, *4Ax*, first, second, third, and fourth axillaries.
AxC, axillary cord.

Ba, basalar.
Bc, basicosta, basal ridge of coxa.
bcs, basicostal suture of coxa.
Bcx, basicoxite.
Brn, branchia, gill.
Bs, basisternum.
BW, body wall.

CMcl, closing muscle of spiracle.
cpl, supra-coxal plate of subcoxa.
Cu, cubitus. *1Cu*, *2Cu*, first and second cubitus.
Cv, cervix, neck.
1cv, *2cv*, first and second lateral cervical sclerites.
Cx, coxa.
CxC, coxal cavity.
CxP, pleural coxal process.
Cxpd, coxopodite.
cxs, coxal suture.

D, flexor muscle of wing.
DMcl, dorsal longitudinal muscles.

E, basalar-sternal muscle.
Em, lateral emargination of tergum.
Endp, endopodite.
Epm, epimeron.
Eppd, epipodite.
Eps, episternum.
Eupl, eupleuron.
Eutn, entrochantin.
Expd, exopodite.

Fm, femur.
Fu, furca.

H, head.

I, intercalary vein.
 tergal promotor muscle of coxa.
I-XI, abdominal segments.
IS-XIS, abdominal sterna.
Isg, intersegmental fold.
ISp, *IISp*, first and second abdominal spiracles.
Ist, intersternite.
IT-XIT, abdominal terga.

J, tergal remotor muscle of coxa.
Ju, jugal area of wing.

K, sternal promotor, anterior rotator of coxa.

L, leg.
 sternal remotor, posterior rotator of coxa.
LB, leg basis.
Ls, laterosternite.

M, media.
 abductor muscle of coxa.
m, *m'*, distal median plates.
M', basalar-coxal muscle.
M'', subalar-coxal muscle.
Mb, secondary intersegmental membrane.
mb, membrane
Mer, meron.

N, *N'*, adductor muscle of coxa.

O, levator muscle of trochanter.
OMcl, opening muscle of spiracle.

P, body branch of depressor muscle of trochanter.
PaR, parapsidal ridge.
pas, parapsidal suture.
Pc, precosta.

- Pcx*, precoxal bridge.
Ph, phragma. *1Ph*, *2Ph*, *3Ph*, first, second, and third phragmata.
Pl, pleuron.
pl, pleural sclerites between tergum and subcoxa.
PLA, pleural apophysis.
Pln, planta.
PIR, pleural ridge.
PLS, pleural suture.
PN, postnotum.
PNP, posterior notal wing process.
Poc, postocciput.
PoR, postoccipital ridge.
Ppct, prepectus.
Ppt, periproct.
PR, prescutal ridge.
Pra, preanal area of wing.
Ps, presternum.
ps, prescutal suture.
Psc, prescutum.
PT, posterior arm of tentorium.
Ptar, pretarsus.
Ptr, peritreme.
Ptv, postalar arm of postnotum.

Q, coxal branch of depressor muscle of trochanter.

R, radius.
Rd, posterior fold, reduplication, of tergum.

S, levator muscle of tibia sternum.
SA, sternal apophysis.
Sa, subalare.
sa, external pit of sternal apophysis.
Sc, subcosta.
Scl, scutellum.
scl, subdivision of scutellum.

Sct, scutum.
sct, subdivision of scutum.
Scx, subcoxa.
SI, sternellum.
Sp, spiracle. *Sps*, *Sps*, first and second thoracic spiracles.
Spn, spina.
spn, external pit of spina.
Ss, spinasternum.
Stn, primary segmental sternite.

T, depressor muscle of tibia. tergum.
Tar, tarsus.
Tb, tibia.
tg, tegular rudiment.
TmMcl, tympanal muscle.
Tn, trochantin.
Tr, trochanter. *1Tr*, *2Tr*, first and second trochanters.
Tra, trachea.

U, levator muscle of tarsus.
Uf, unguifer of tarsus.
Un, unguis, claw.
Utr, unguitractor plate.

V, depressor muscle of tarsus.
VD, vena dividens.
VIIISp, eighth abdominal spiracle.
VMcl, ventral longitudinal muscle.
VR, ridge between scutum and scutellum.
vs, scuto-scutellar suture.

W, wing.
WP, pleural wing process.

X, depressor muscle of pretarsus, retractor of claws.

REFERENCES

- BAUER, A. (1910). Die Muskulatur von *Dytiscus marginalis*. *Zeitschr. wiss. Zool.*, **95**: 594-646, 19 figs. Also in Korschelt (1924), Chapter 12.
 BECKER, E. (1923). Zum Bau und zur Genese des coxotrochanteralen Teiles des Ateloceratenbeins. *Zool. Anz.*, **57**: 137-144, 4 figs.
 — (1924). Zur morphologische Bedeutung der Pleuren bei Ateloceraten. *Zool. Anz.*, **60**: 169-185, 6 figs.
 BERLESE, A. (1909). *Gli insetti*, Vol. I. Milan.

- (1910). Monografia dei Myrientomata. *Redia*, **6**: 1-182, pls. 1-17.
- DU BUISSON, M. (1926). Observations sur la ventilation trachéenne des insectes (3me Note). *Bull., Cl. Sci., Acad. Roy. Belgique*, 5th Ser., **12**: 127-138.
- CAMPBELL, F. L. (1929). The detection and estimation of insect chitin; and the irrelation of chitinization to hardness and pigmentation of the American cockroach, *Periplaneta americana* L. *Ann. Ent. Soc. Amer.*, **22**: 401-426.
- CARPENTIER, F. (1923). Masculature et squelette chitineus. *Mem. Acad. Roy. Belgique*, Cl. Sci., Collection in 8°, **7**, fasc. 3: 1-56.
- (1924). Sur le double stigmaté de quelques Orthoptères. *Bull. Soc. Entom. Belgique*, **6**: 123-140, 11 figs.
- (1925). Sur le double stigmaté de quelques Orthoptères (2me Note). *Bull. & Ann. Soc. Entom. Belgique*, **65**: 205-208.
- CHOLODKOWSKY, N. (1891). Die Embryonalentwicklung von *Phyllodromia* (*Blatta*) germanica. *Mém. Acad. Sci. St. Petersbourg*, 7 Ser., **38**, No. 5, 120 pp., 6 pls.
- COMSTOCK, J. H. (1918). The wings of insects. Ithaca, N. Y.
- CRAMPTON, G. C. (1909). A contribution to the comparative morphology of the thoracic sclerites of insects. *Proc. Acad. Nat. Sci. Philadelphia*, **1909**: 3-54, pls. 1-4.
- (1914). The ground plan of a typical thoracic segment in winged insects. *Zool. Anz.*, **44**: 56-67, 1 fig.
- (1918). The thoracic sclerites of the grasshopper, *Dissosteira carolina*. *Ann. Ent. Soc. Amer.*, **11**: 347-366, pl. 32.
- (1927). The thoracic sclerites and wing bases of the roach, *Periplaneta americana*, and the basal structures of the wings of insects. *Psyche*, **34**: 59-72, pls. 1-3.
- DAVIES, W. M. (1927). On the tracheal system of *Collembola*, with special reference to that of *Sminthurus viridis*. *Lubb. Quart. Journ. Micr. Sci.*, **71**: 15-30, 6 figs.
- DU PORTE, E. M. (1920). The muscular system of *Gryllus assimilis* Fabr. *Ann. Ent. Soc. Amer.*, **8**: 16-52, pls. 1-7.
- DÜRKEN, B. (1907). Die Tracheenkiemenmuskulatur der Ephemeriden unter Berücksichtigung der Morphologie des Insektenflügels. *Zeitschr. wiss. Zool.*, **87**: 435-550, pls. 24-26.
- EWING, H. E. (1928). The legs and leg-bearing segments of some primitive arthropod groups, with notes on leg-segmentation in the Arachnida. *Smithsonian Misc. Coll.*, **80**, No. 11, 41 pp., 12 pls.
- HEYMONS, R. (1897). Entwicklungsgeschichtliche Untersuchungen an *Lepisma saccharina* L. *Zeitschr. wiss. Zool.*, **62**: 583-631, pls. 29, 30.
- (1899). Beiträge zur Morphologie und Entwicklungsgeschichte der Rhynchoten. *Nova Acta. Abh. Kaiserl. Leop.-Carol. Deut. Akad. Naturf.*, **74**: 349-456, pls. 15-17.
- KORSCHULT, E. (1924). *Dytiscus marginalis*, 2 vols. Leipzig.
- LEE, M. O. (1925). On the mechanism of respiration in certain Orthoptera. *Journ. Exp. Zool.*, **41**: 125-154.
- VON LENDENFELD, R. (1881). Der Flug der Libellen. *Sitz. Ber. Akad. Wiss. Wien, Math-Natur.*, **83**, Abth. I: 289-376, pls. 1-7.
- MACGILLIVRAY, A. D. (1923). External insect-anatomy. Urbana, Ill.
- MACLEAY, W. S. (1830). Explanation of the comparative anatomy of the thorax in winged insects, with a review of the present state of nomenclature. *Zool. Journ.*, **5** (1835): 145-179, pls. 5, 6.

- MARTYNOV, A. B. (1925). Ueber zwei Grundtypen der Flügel bei den Insekten und ihre Evolution. *Zeitschr. Morph. u. Ökol. Tiere*, **4**:465-501, 24 figs.
- MORISON, G. D. (1927). The muscles of the adult honey-bee (*Apis mellifera* L.). Part I. Somatic musculature. *Quart. Journ. Micr. Sci.*, **71**:395-463, 12 figs.
- NELSON, J. A. (1915). Embryology of the honey bee. Princeton Univ. Press.
- PRELL, H. (1913). Das Chitinskelett von Eosentomon. *Zoologica. Orig-Abhandl. Gesamtg. Zool.*, **25**, 58 pp., 6 pls.
- SHEPARD, H. H. (1930). The pleural and sternal sclerites of the lepidopterous thorax. *Ann. Ent. Soc. Amer.*, **23** (in Press).
- SNODGRASS, R. E. (1909). The thorax of insects and the articulation of the wings. *Proc. U. S. Nat. Mus.*, **36**:511-595, pls. 40-69.
- (1910). The thorax of the Hymenoptera. *Proc. U. S. Nat. Mus.*, **39**:37-91, pls. 1-16.
- (1927). Morphology and mechanism of the insect thorax. *Smithsonian Misc. Coll.*, **80**, No. 1, 108 pp., 44 figs.
- (1928). Morphology and evolution of the insect head and its appendages. *Smithsonian Misc. Coll.*, **81**, No. 3, 158 pp., 57 figs.
- SPEYER, W. (1922). Die Muskulatur der Larve von *Dytiscus marginalis* L. *Zeitschr. wiss. Zool.*, **119**:423-492, 21 figs. Also in Korschelt (1924), Chapter 13.
- TILLYARD, H. J. (1919). The Panorpid Complex. Pt. 3, The wing-venation. *Proc. Linn. Soc. N. S. W.*, **44**:533-718, pls. 31-35.
- VINAL, S. C. (1919). The respiratory system of the Carolina locust (*Dissosteira carolina* Linne). *Journ. New York Ent. Soc.*, **27**:19-32, pls. 3-5.
- VOSS, F. (1905). Ueber den Thorax von *Gryllus domesticus* (Pts. 1-4). *Zeitschr. wiss. Zool.*, **78**:268-521, 645-759, pls. 15, 16, 24.
- WEBER, H. (1924). Das Thorakalskelett der Lepidopteren. Ein Beitrag zur vergleichenden Morphologie des Insektenthorax. *Zeitschr. Anat. und Entwickl.*, **73**:277-331, 9 figs.
- (1925). Der Thorax der Hornisse. Ein Beitrag zur vergleichenden Morphologie des Insektenthorax. *Zool. Jahrb., Anat.*, **47**:1-100, pls. 1-4.
- (1927). Die Gliederung der Sternalregion des Tenthredinidenthorax. *Zeitschr. wiss. Insektenbiol.*, **22**:161-198, pls. 1-6.
- (1928). Die Gliederung der Sternopleuralregion des Lepidopteren thorax. Eine vergleichend morphologische Studie zur Subcoxaltheorie. *Zeitschr. wiss. Zool.*, **131**:181-254, 21 figs.
- (1928). Skelett, Muskulatur und Darm der schwarzen Blattlaus, *Aphis fabae* Scop. *Zoologica. Orig-Abhandl. Gesamtg. Zool.*, **28** (Heft 76), 120 pp., 12 pls.
- (1929). Kopf und Thorax von *Psylla mali* Schmidb. (Homoptera-Homoptera). Eine morphogenetische Studie. *Zeitschr. Morph. u. Ökol. Tiere*, **14** (Heft 1): 59-165, 35 figs.
- WHEELER, W. M. (1889). The embryology of *Blatta germanica* and *Doryphora decimlineata*. *Journ. Morph.*, **3**:291-386, pls. 15-21.

SMITHSONIAN MISCELLANEOUS COLLECTIONS
VOLUME 32, NUMBER 3

Hodgkins Fund

THE RADIATION OF THE PLANET
EARTH TO SPACE

(WITH TWO PLATES)

BY
C. G. ABBOT



(PUBLICATION 3028)

CITY OF WASHINGTON
PUBLISHED BY THE SMITHSONIAN INSTITUTION
NOVEMBER 16, 1929

SMITHSONIAN MISCELLANEOUS COLLECTIONS
VOLUME 82, NUMBER 3

Hodgkins Fund

THE RADIATION OF THE PLANET
EARTH TO SPACE

(WITH TWO PLATES)

BY
C. G. ABBOT



(PUBLICATION 3028)

CITY OF WASHINGTON
PUBLISHED BY THE SMITHSONIAN INSTITUTION
NOVEMBER 16, 1929

The Lord Baltimore Press
BALTIMORE, MD., U. S. A.

Hodgkins Fund

THE RADIATION OF THE PLANET EARTH TO SPACE

BY C. G. ABBOT

(WITH TWO PLATES)

In an illuminating series of papers, G. C. Simpson recently has approached the subject of terrestrial and atmospheric radiation to outer space. The first of these papers is entitled "Some Studies in Terrestrial Radiation."¹ Here Simpson makes the unsatisfactory assumption that the atmospheric water vapor behaves like a "grey body" in absorbing radiation. That is, he assumes that general coefficients of absorption and of transmission may be employed, without regard to the wave length of the radiation considered. Arriving in this way at unexpected and questionable results, Simpson then modified his procedure in a second paper entitled "Further Studies in Terrestrial Radiation."² Here he makes the following important assumptions: (a) The stratosphere contains 0.3 mm. of precipitable water. (b) The absorptive properties of atmospheric water vapor may be regarded as so similar to those of steam that Hettner's³ observations of the absorption of a layer of steam may be taken as representing the coefficients of absorption of atmospheric water vapor between wave lengths 4μ and 34μ .⁴ (c) "The stratosphere absorbs all radiation between wave lengths $5\frac{1}{2}\mu$ and 7μ , and from wave length 14μ to the end of the spectrum."

As the Smithsonian Institution has hitherto published considerable evidence relating to these three subjects, it has occurred to me to see whether the use of our independently derived data would check well the

¹ Mem. Roy. Meteorol. Soc., Vol. 2, No. 16, 1928.

² *Ibid.*, Vol. 3, No. 21, 1928.

³ Hettner, G., Ann. Physik. Leipzig, 4th Folge., Band 55, p. 476, 1918.

⁴ Simpson nevertheless calls attention to the incomplete similarity between the absorption of concentrated and unconcentrated vapors, and therefore corrects Hettner's curve between 8μ and 11μ from other data derived from atmospheric experiments.

results of Simpson in this important field. Fowle¹ carried on for several years, 1908 to 1917, experiments on the absorption of radiation of long wave lengths by the atmosphere contained in tubes of large diameter and up to 800 ft. in length. These tubes were laden with water vapor ranging from 0.2 up to 2.5 mm. of precipitable water, and of carbon dioxide content ranging from 7 grams up to 160 grams per meter cross-section at normal temperature and pressure.

In his early experiments, Fowle had established means for determining the quantity of precipitable water in atmospheric air by means of measurements on the bands $\rho\sigma\tau$, ϕ , and ψ of the upper infra-red solar spectrum. These experiments are fortunately very definite as to the determination of water vapor equivalent to 0.3 mm. of precipitable water.

In the summer of the years 1909 and 1910, Abbot observed the infra-red solar spectrum from Mount Whitney, California, altitude 4,420 m. Bolographs of the spectrum were obtained, having very satisfactory quality as far as the delineation of the bands $\rho\sigma\tau$, ϕ , and ψ is concerned.² From these, Fowle determined the quantity of total precipitable water in a vertical path of atmosphere above Mount Whitney. On August 14, 1910, he observed 0.6 mm. Considering the moderate altitude and the summer season, this small observed water-vapor content hardly prepares one to accept Simpson's assumption that the stratosphere, which begins at 12,000 m., and is at a temperature about 50° C. lower than that which prevailed at the summit of Mount Whitney on that occasion, can contain half of the precipitable water above that station. We have other evidence leading to the same view.

At Mount Montezuma, Chile, altitude 2,710 m., we have observed spectroscopically the total precipitable water in a vertical column above the station almost daily for about 10 years at all seasons. The following table gives average values for the 12 months, and also extreme values for each of these months, together with associated surface temperatures.

In illustration of the great alterations in the appearance of the solar energy spectrum depending on the quantity of atmospheric humidity, we give reproductions of two days' observations at Montezuma, plates 1 and 2. Note the bands $\rho\sigma\tau$, ϕ , ψ and Ω .

¹ Fowle, F. E., *Ann. Astrophys. Observ.*, Vol. 4, pp. 274-286. *Astrophys. Journ.*, Vol. 38, p. 393, 1913; Vol. 42, p. 394, 1915. *Smithsonian Misc. Coll.*, Vol. 68, No. 8, 1917.

² See *Annals*, Vol. 4, fig. 50.

TABLE I.—*Monthly Mean Results at Montezuma, Years 1923 to 1928*

Month	Temp. for year 1924 Mean dry bulb 8 o'clock a. m.	Precipitable Water in Centimeters										Surface pressure aqueous vapor mm.
		Mean of years 1923-1928 cm.	Total no. of days	Mean of absolute minima cm.	Year of absolute minimum	Mean of absolute maxima cm.	Year of absolute maximum	Absolute daily minimum cm.	Absolute daily maximum cm.	No. of days values less than 0.10 cm.		
Jan.....	17.0	0.89	114	0.34	1924	1.44	1927	0.08	2.16	2	3.0	
Feb.....	14.7	1.04	108	0.41	1928	1.84	1925	0.16	2.38	0	4.9	
Mar.....	13.5	0.80	140	0.36	1923	1.52	1927	0.19	2.13	0	4.2	
Apr.....	13.7	0.46	140	0.12	1924	1.12	1925	0.06	1.73	2	2.9	
May.....	9.2	0.31	140	0.10	1924	0.75	1925	0.04	1.40	8	1.9	
June.....	9.1	0.30	130	0.08	1923	0.64	1923	0.03	1.14	9	1.8	
July.....	8.7	0.23	149	0.05	1926	0.74	1926	0.02	0.97	24	1.4	
Aug.....	9.0	0.23	137	0.05	1924	0.64	1926	0.04	0.93	26	1.9	
Sept.....	12.0	0.26	138	0.07	1928	0.71	1924	0.05	0.87	12	1.9	
Oct.....	14.0	0.29	159	0.07	1924	0.68	1926	0.03	1.02	10	2.1	
Nov.....	14.9	0.37	145	0.12	1924	0.87	1923	0.05	1.24	7	2.3	
Dec.....	15.7	0.65	122	0.22	1924	1.33	1927	0.10	1.54	0	3.3	

Numbers of days observed of precipitable water

Total 1923 to 1928	With values less than 0.10 cm.						With values in centimeters:					
	0.02	0.03	0.04	0.05	0.06	0.08	0.07	0.08	0.09	0.10	0.12	
1622.....	3	7	12	9	19	21	17	21	12	12		

From the tabular data, it is clear that values of total precipitable water are frequently observed at Montezuma closely approaching the value assumed by Simpson for the stratosphere. These values are found in winter, with a surface air temperature of $+9^{\circ}$ C., on the edge of the tropics at 2,710 m. altitude.

In view of these observations at Montezuma, and considering the rapid decrease of humidity with temperature (the vapor pressure at -50° and 0° C. being respectively 0.03 and 4.58 mm.) and also the fact that three-fourths of the superincumbent atmosphere lies between Montezuma station and the bottom of the stratosphere, one is forced to conclude that the value of the precipitable water contained by the stratosphere is vanishingly small, rather than 0.3 mm. as assumed by Simpson. This materially affects his argument, especially that part which relates to cloudy skies.

As an independent approach, instead of Simpson's two other basic assumptions, which we have designated as (b) and (c), we have employed Fowle's two summaries of the results obtained in his long-tube experiments.¹ To make these results of Fowle's applicable to the problem of atmospheric radiation and absorption, as set by Simpson, we have prepared a large scale plot, reproduced in reduced size in figure 1. From this plot we take table 2. In choosing the quantities of precipitable water to be used, we have doubled the values given by Simpson for successive layers in the table he designates as "Fig. I," page 72, of his paper "Some Studies in Terrestrial Radiation." This doubling we do because of the following consideration.

We are proposing to ascertain the radiation which certain layers of the free atmosphere, containing natural loads of water vapor and carbon dioxide, will send upwards in all directions within a solid angle filling a complete hemisphere. We assume, as does Simpson, that for monochromatic rays the emission of such a layer bears the same proportion to the emission of the perfect radiator that the absorption of the layer in question bears to unity. While some rays are emitted vertically, most rays are emitted obliquely, so that the average emission and absorption of a layer exceeds that which corresponds to the precipitable water vapor and carbon dioxide found in a vertical path. It is readily proved by performing the integration over a complete hemisphere that the average upward path is double the vertical one. Hence we have doubled Simpson's figures for the precipitable water contained in the layers he has chosen. These data appear in table 2.

¹ See *Annals*, Vol. 4, Table 102, p. 286; also *Smithsonian Physical Tables*, 7th Rev. Ed., 4th reprint, p. 308.

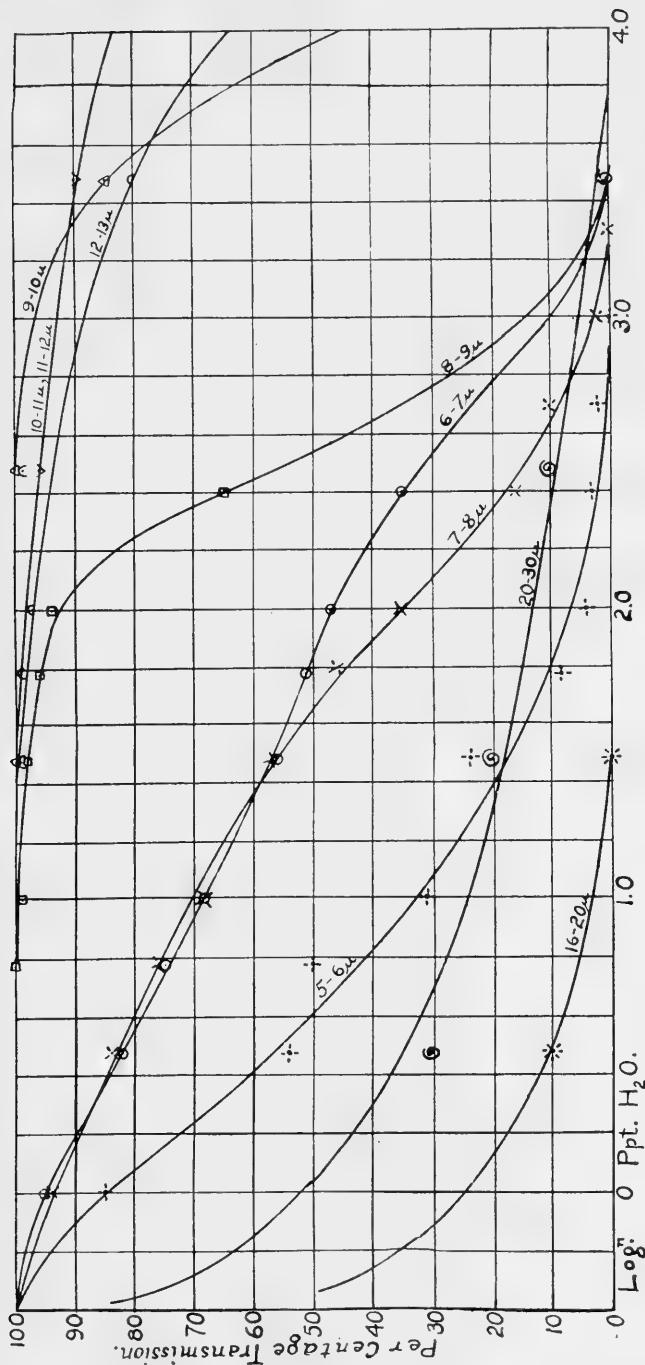

FIG. 1.—Absorption and Transmission of Radiation by Air Laden with Water Vapor and Carbonic Acid Gas. (After Fowle.)

As a second step, we consider the spectral distribution and intensity of emission of the perfect radiator at different temperatures.¹ By interpolation on large scale plots we have prepared table 3. This gives the approximate² intensity of emission of the perfect radiator at temperatures corresponding to the mean temperatures of Simpson's layers, and to those of his selected latitudes of the earth's surface.

Multiplying the values in table 2 by corresponding ones in table 3, we obtain the emission of radiation outwards from each Simpson atmospheric layer towards a complete hemisphere. The values are given in table 4.

Again interpolating in the plots (fig. 3) we next obtained the transmission coefficients for each superincumbent atmospheric mass lying above the respective Simpson layers. Allowance is made for the ozone absorption between 9μ and 11μ . These values are given in table 5.

Multiplying these values by corresponding ones in tables 3 and 4, we obtained the contributions of the Simpson atmospheric layers and also of the earth's surface³ at the latitudes 90° , 70° , 60° , 50° , 40° , and 0° to the intensity of emission of the earth as a planet towards outer space.⁴ These results are given in table 6.

All of these results apply to cloudless skies. We now assume, with Simpson, that the earth is 50 per cent cloudy; that the clouds totally absorb all radiation arising from beneath them; that they radiate quite as efficiently as the perfect radiator; and that their upper surfaces maintain the same average temperature as the earth at 70° latitude. We are not able to compute their radiation in Simpson's manner, since we have shown reasons to believe that the stratosphere is almost destitute of water vapor, instead of containing 0.3 mm. of precipitable water as he supposes. We simply assume that the combined emission of clouds and atmosphere during one-half the time at all latitudes is the same as that of the earth's surface and the superincumbent atmosphere at latitude 70° . That is: For the atmosphere 0.151 cal. per cm^2 per min.; for the cloud surface 0.100 cal., giving a total for completely overcast sky of 0.251 cal. During the other half of the time,

¹ See Smithsonian Physical Tables, p. 248.

² We do not guarantee these values to within 2 per cent.

³ We assume, with Simpson, that the earth's surface may be regarded as a perfect radiator.

⁴ Notwithstanding our previous evidence that the water-vapor content of the stratosphere is vanishingly small, we have thought best to estimate 30 per cent of black-body efficiency as applicable to the stratospheric radiation in the wave-length region 13μ to 50μ , where water vapor is so very active. We have allowed 16 per cent of black body efficiency to the ozone band, 9μ to 11μ .

TABLE 2.—Percentage Emission of Simpson Layers (after Fowle) Compared to Perfect Radiator = 100

Simpson Layer	Precipitable H ₂ O (Doubled)	Log. ppt. H ₂ O X 1000	Wave lengths, microns															
			5-6	6-7	7-8	8-9	9-10	10-11	11-12	12-13	13-16	16-20	20-30	30-40	40-50			
— 3	.0002	1.30	1	3	1	0	0	0	0	0	0	0	0	0	15	10	100	100
— 2	.0006	1.78	3	9	3	0	0	0	0	0	0	0	0	0	45	30	100	100
— 1	.0012	0.08	8	20	7	0	0	0	0	0	0	0	0	0	78	52	100	100
+ 1	.0020	0.30	13	33	13	0	0	0	0	0	0	0	0	0	85	60	100	100
2	.006	0.78	26	58	24	0	0	0	0	0	0	0	0	0	94	72	100	100
3	.012	1.08	34	70	32	0	0	0	0	0	0	0	0	0	98	77	100	100
4	.024	1.38	41	79	41	2	2	0	0	0	0	0	0	0	100	80	100	100
5	.048	1.68	47	87	51	4	4	0	0	1	1	2	2	3	100	84	100	100
6	.092	1.96	53	93	63	7	18	0	0	2	2	3	3	4	100	87	100	100
7	.172	2.24	59	96	75	18	44	0	0	3	3	4	4	6	100	89	100	100
8	.312	2.49	68	98	85	44	68	0	0	4	4	6	6	8	100	91	100	100
9	.548	2.74	78	99	93	68	84	1	1	6	6	8	8	100	93	100	100	100
10	.910	2.96	89	100	97	84	93	3	3	7	7	11	11	100	95	100	100	100
11	1.456	3.16	95	100	99	93	99	6	6	8	8	14	14	100	96	100	100	100
12	2.280	3.36	99	100	100	99	99	11	11	10	10	17	17	100	98	100	100	100
13	3.540	3.55	100	100	100	100	100	20	20	11	11	22	22	100	99	100	100	100

TABLE 3.—*Energy Distribution in Spectra of Perfect Radiator*
 (To reduce to cal. per cm^2 per min., multiply by .0001)

Simpson Layer	Temperature Absolute C	Wave lengths, microns												
		5-6	6-7	7-8	8-9	9-10	10-11	11-12	12-13	13-16	16-20	20-30	30-40	40-50
-3.....	205	...	3	24	33	51	60	60	60	210	261	396	162	60
-2.....	211	3	6	30	42	60	75	75	75	246	291	435	174	63
-1.....	217	3	12	36	57	75	90	90	90	285	324	474	186	69
+1.....	223	6	21	48	72	90	105	105	105	324	357	513	198	75
2.....	229	9	30	60	87	108	120	120	120	360	390	555	210	81
3.....	235	12	39	75	102	123	138	138	138	402	420	594	225	87
4.....	241	18	51	90	120	144	156	156	156	441	453	630	237	90
5.....	247	27	63	108	141	165	174	174	174	480	486	669	249	96
Pole.....	250	30	72	119	152	176	186	187	187	503	506	690	256	99
6.....	253	33	81	129	162	186	198	198	198	525	525	711	261	102
7.....	259	39	99	150	186	210	222	222	222	573	561	750	273	108
Lat. 70°.....	262	47	110	164	198	225	234	234	230	598	581	768	281	111
8.....	265	54	120	177	210	240	246	246	240	624	600	786	288	114
Lat. 60°.....	268	58	132	189	225	254	258	258	251	650	617	807	292	117
9.....	271	63	144	201	240	267	270	270	261	675	633	828	300	120
10.....	277	84	171	231	270	297	300	300	285	732	681	870	312	126
Lat. 50°.....	280	95	186	248	287	315	316	315	297	762	703	888	320	129
11.....	283	105	201	264	303	333	336	330	309	792	726	906	327	132
Lat. 40°.....	286	119	216	282	325	353	354	345	324	825	753	925	333	135
12.....	289	132	231	300	348	372	372	360	339	858	780	945	339	138
13.....	295	165	270	345	396	420	411	396	369	930	834	987	354	144
Equator.....	298	180	288	372	426	444	432	414	390	960	864	1005	360	150

TABLE 4.—Radiation of Layers of Atmosphere Depending on H₂O and CO₂
(To reduce to cal. per cm.² per min., multiply by .0001)

Simpson Layer	Wave lengths, microns												
	5-6	6-7	7-8	8-9	9-10	10-11	11-12	12-13	13-16	16-20	20-30	30-40	40-50
-3.....	0	0.1	0.2	0	0	0	0	0	210.0	39.1	39.6	162.0	60.0
-2.....	0.1	0.5	0.9	0	0	0	0	0	246.0	130.9	130.5	174.0	63.0
-1.....	0.2	2.4	2.5	0	0	0	0	0	285.0	252.7	246.5	186.0	69.0
+1.....	0.8	7.0	6.2	0	0	0	0	0	324.0	303.4	307.8	198.0	75.0
2.....	2.3	17.4	14.4	0	0	0	0	0	366.6	366.6	399.6	210.0	81.0
3.....	4.0	27.3	24.0	0	0	0	0	0	402.0	411.6	457.4	225.0	87.0
4.....	7.4	40.3	36.9	2.4	0	0	0	0	441.0	453.0	504.0	237.0	90.0
5.....	12.7	54.8	55.1	5.6	0	1.7	1.7	3.5	480.0	486.0	562.0	249.0	96.0
6.....	17.5	75.3	81.3	11.3	0	3.9	3.9	5.8	525.0	618.6	618.6	261.0	102.0
7.....	23.0	95.0	112.5	33.5	0	6.7	6.7	8.7	573.0	561.0	667.5	273.0	108.0
8.....	36.3	117.6	150.4	92.4	0	9.8	9.8	14.4	624.0	600.0	715.3	288.0	114.0
9.....	49.1	142.6	186.9	163.2	2.7	16.2	16.2	20.9	633.0	633.0	770.0	300.0	120.0
10.....	74.8	171.0	224.1	226.8	8.9	21.0	21.0	31.3	732.0	681.0	826.5	312.0	126.0
11.....	100.0	201.0	261.4	281.8	19.9	26.9	26.4	43.3	792.0	726.0	869.8	327.0	132.0
12.....	131.0	231.0	300.0	344.5	40.9	37.2	36.0	57.6	858.0	780.0	926.1	339.0	138.0
13.....	165.0	270.0	345.0	396.0	84.0	45.2	43.6	81.2	930.0	834.0	977.1	354.0	144.0

TABLE 5.—Percentage Transmission through *Superincumbent H₂O, O₃ and CO₂* (after Foule)
(Absorption of ozone, 9-11 μ , from Fig. 41, Annals, Vol. 4)

Simpson Layer	Superin- cumbent ppt. H ₂ O (Doubled)	Log. H ₂ O	Wave lengths, microns														
			5-6	6-7	7-8	8-9	9-10	10-11	11-12	12-13	13-16	16-20	20-30	30-40	40-50		
-3	.0002	-.70	99	97	99	100	84	84	84	100	100	100	0	85	90	0	0
-2	.0008	-.10	94	89	96	100	84	84	100	100	100	100	0	40	70	0	0
-1	.0020	+.30	87	67	87	100	84	84	100	100	100	100	0	14	40	0	0
+1	.0040	.60	79	51	80	100	84	84	100	100	100	100	0	8	32	0	0
2	.0100	1.00	68	33	70	100	84	84	100	100	100	100	0	3	24	0	0
3	.024	1.38	59	21	59	99	84	84	100	100	100	100	0	1	19	0	0
4	.048	1.68	53	12	49	97	84	83	99	98	98	98	0	0	16	0	0
5	.096	1.98	47	7	36	93	84	82	98	97	97	95	0	0	13	0	0
6	.188	2.27	39	3	23	78	84	82	97	95	95	95	0	0	10	0	0
7	.360	2.56	29	1	12	48	84	80	95	93	93	93	0	0	8	0	0
8	.672	2.83	17	0	5	25	82	79	94	91	91	91	0	0	6	0	0
9	1.22	3.08	7	0	2	10	81	77	92	88	88	88	0	0	4	0	0
10	2.13	3.33	2	0	0	2	76	76	91	83	83	83	0	0	3	0	0
11	3.59	3.55	0	0	0	0	67	75	89	78	78	78	0	0	1	0	0
12	5.87	3.77	0	0	0	0	55	73	87	72	72	72	0	0	0	0	0
13	9.41	3.97	0	0	0	0	38	70	83	63	63	63	0	0	0	0	0

the values at different latitudes are as given in table 6 for clear skies. For half-cloudy skies we take the mean of the two conditions.

We are now prepared to assemble our results and compare them with those of Simpson (table 7).

It is clear that our employment to a considerable extent of independent data and methods has made no very great difference in the totals from those of Simpson. The range of our totals for half-cloudy sky is indeed considerably greater than his as between the equator and the poles. Our method has enabled us to segregate the contributions of the atmosphere and of the earth's surface, which in Simpson's second paper are not computed separately. We find the earth's surface almost equally contributing at all latitudes, but the

TABLE 7.—*Radiation of Earth and Atmosphere to Space*
Calories per cm^2 per min.

Latitude	Smithsonian results						Simpson results		
	Clear sky			Half-cloudy sky			Atmosphere plus surface		
	Atmosphere	Surface	Total	Atmosphere	Surface or cloud	Total	Clear	Over-cast	Half-cloudy
0°	0.220	0.105	0.325	0.186	0.102	0.288	0.316	0.213	0.264
40°	0.192	0.107	0.299	0.171	0.103	0.274	0.307	0.243	0.275
50°	0.182	0.105	0.287	0.166	0.102	0.268	0.291	0.249	0.270
60°	0.162	0.104	0.266	0.156	0.102	0.258	0.274	0.252	0.265
70°	0.151	0.100	0.251	0.151	0.100	0.251	0.253	0.253	0.253
90°	0.129	0.096	0.225	0.140	0.098	0.238	0.245

atmosphere, which contributes much more than half the total (even more than two-thirds the total on cloudless days at the equator) emits very much lesser proportions as we approach the poles. The two sources are very different as regards wave lengths of principal contribution; the atmosphere emitting mostly in the region exceeding 16μ in wave length, the surface emitting principally in the region 9μ to 13μ .

If we sum up the results in the seventh and tenth columns, which represent our own and Simpson's totals for half-cloudy sky, and assign weights to them proportional to the areas of earth which they respectively represent, we find that the earth as a planet radiates averages of 0.277 or 0.265 cal. per square centimeter per minute according as our results or Simpson's are taken. If we compute the same quantity from the solar constant, 1.94 cal., and Aldrich's albedo, 43 per

cent, the result is $\frac{1.94}{4} \times 0.57 = 0.276$ cal. The discrepancies are very small and far within the probable error of the determinations.

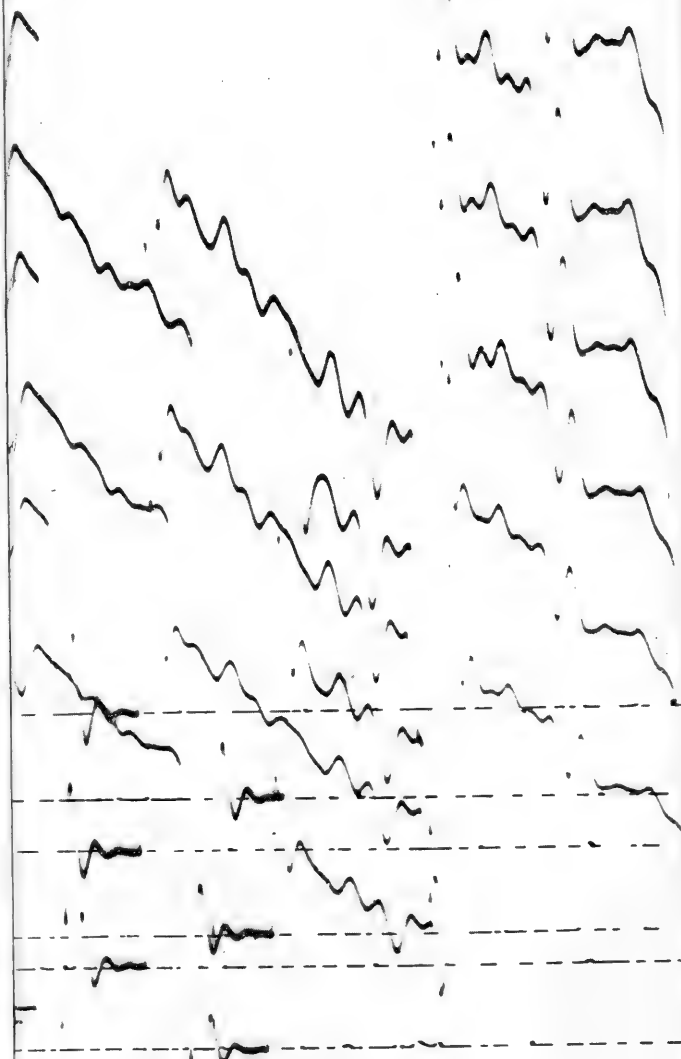

le

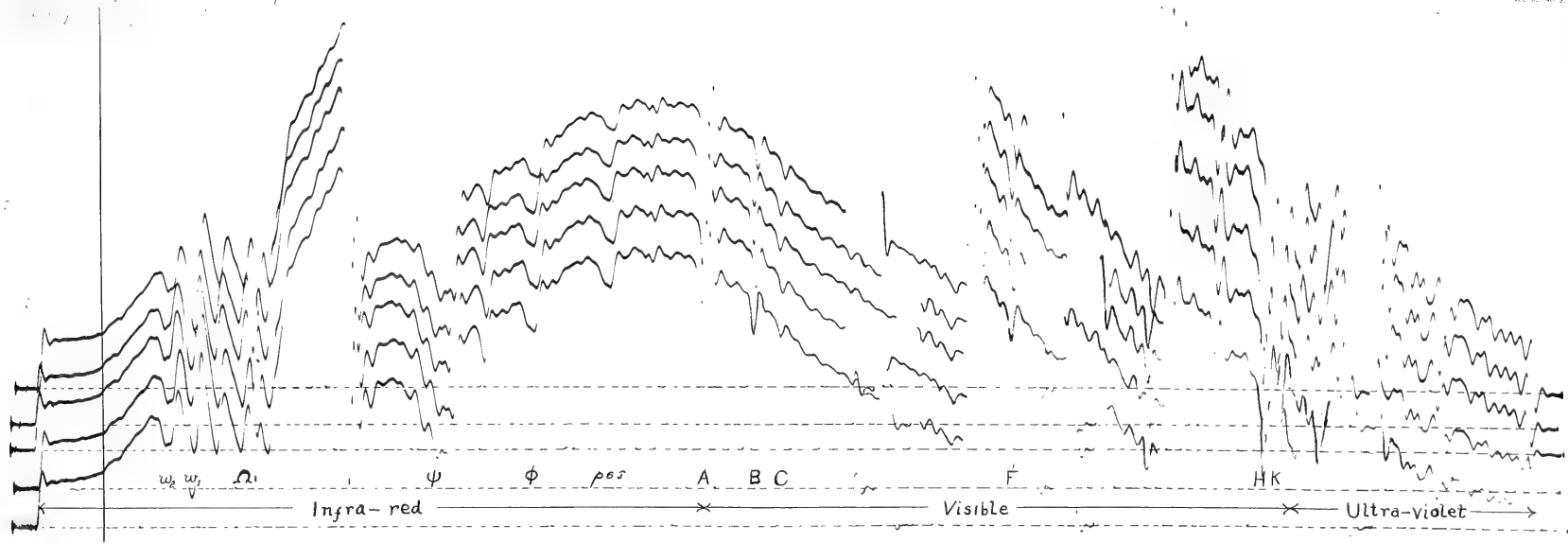

P. 4 graphs of the Solar Energy Spectrum. Observed at Montezuma, Colo. July 7, 1924.
Precipitable water 103 centimeters.

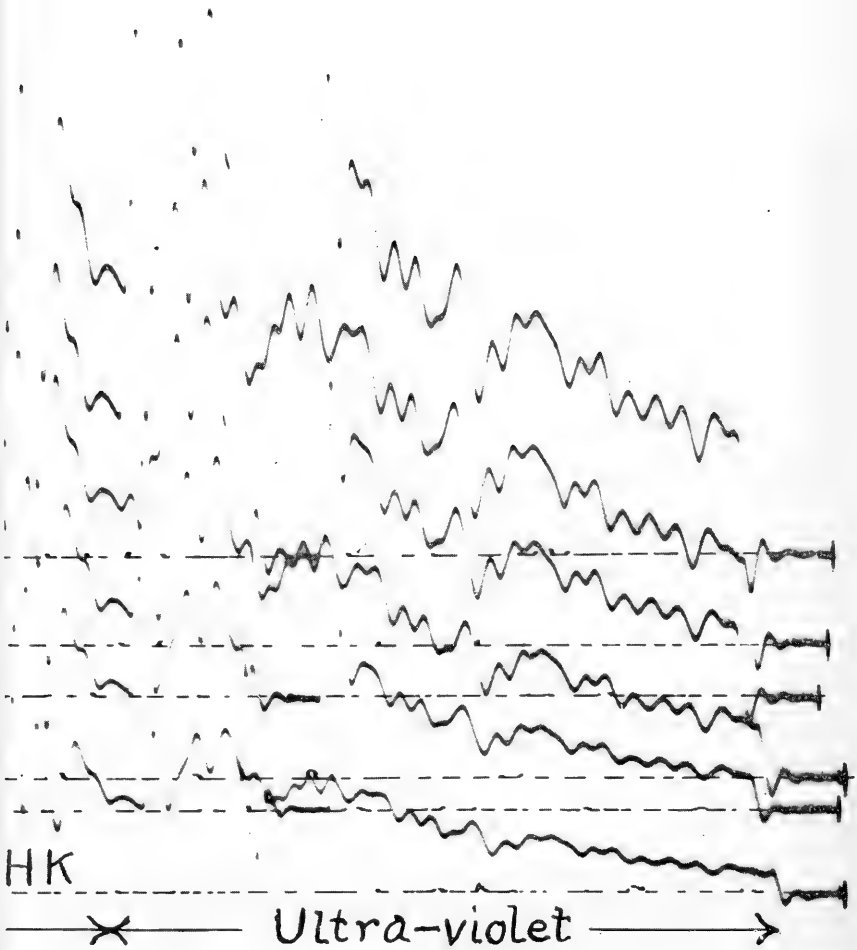

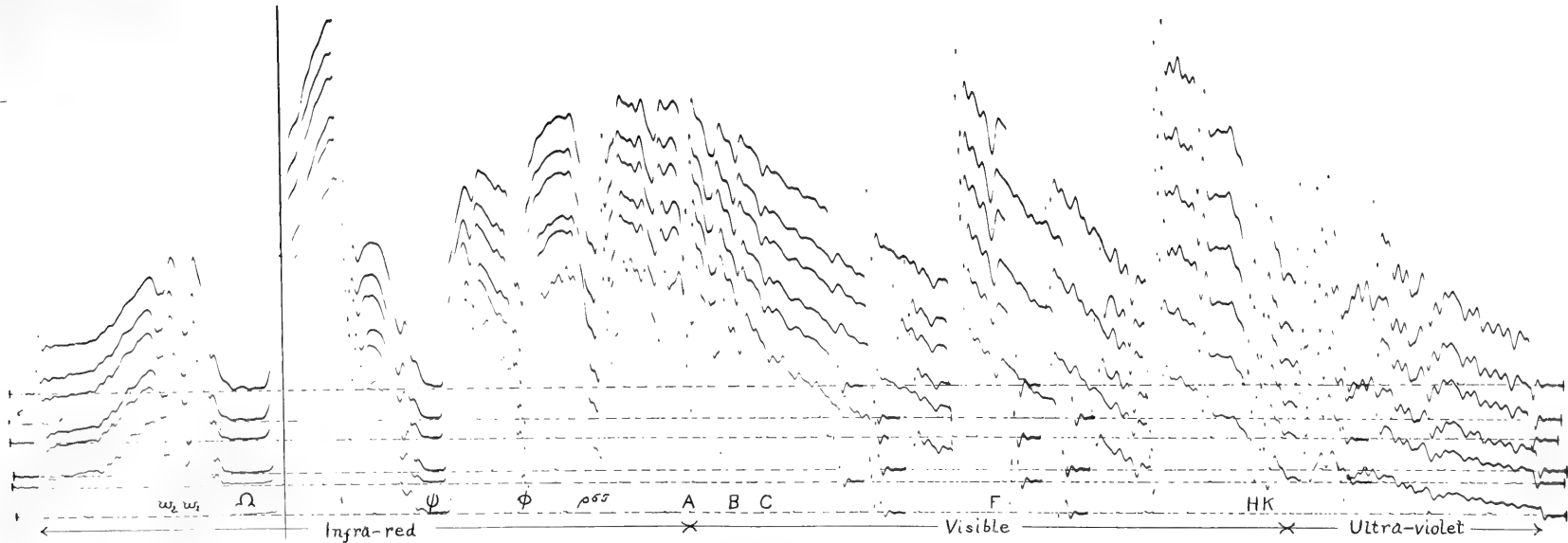

Diagrams of the Solar Energy Spectrum. Observed at M. Azunus, Chile, March 18, 1925.
Precipitable water, 1.47 centimeters.

SMITHSONIAN MISCELLANEOUS COLLECTIONS
VOLUME 82, NUMBER 4

THE CHARACTERS OF THE GENUS
GEOCAPROMYS CHAPMAN

(WITH ONE PLATE)

BY

GERRIT S. MILLER, JR.

Curator, Division of Mammals, U. S. National Museum



(PUBLICATION 3029)

CITY OF WASHINGTON
PUBLISHED BY THE SMITHSONIAN INSTITUTION
DECEMBER 9, 1929



SMITHSONIAN MISCELLANEOUS COLLECTIONS
VOLUME 82, NUMBER 4

THE CHARACTERS OF THE GENUS GEOCAPROMYS CHAPMAN

(WITH ONE PLATE)

BY

GERRIT S. MILLER, JR

Curator, Division of Mammals, U. S. National Museum



(PUBLICATION 3029)

CITY OF WASHINGTON
PUBLISHED BY THE SMITHSONIAN INSTITUTION
DECEMBER 9, 1929

The Lord Baltimore Press
BALTIMORE, MD., U. S. A.

THE CHARACTERS OF THE GENUS GEOCAPROMYS CHAPMAN

By GERRIT S. MILLER, JR.

CURATOR, DIVISION OF MAMMALS, U. S. NATIONAL MUSEUM

(WITH ONE PLATE)

In his "Revision of the Genus *Capromys*" (Bull. Amer. Mus. Nat. Hist., Vol. 14, pp. 313-323, Nov. 12, 1901) Mr. Frank M. Chapman established a sub-genus *Geocapromys* (p. 314) to include *Capromys brownii* J. B. Fischer, *C. thoracatus* True and *C. ingrahami* J. A. Allen, animals that were supposed to have skulls and teeth essentially like those of the species of true *Capromys*, but to have unusually short tails and poorly developed thumbs. Sixteen years later Dr. Glover M. Allen raised *Geocapromys* to generic rank and added to its characters the presence of a small supplemental reentrant angle near the front of the lingual side of the first mandibular molariform tooth (Bull. Mus. Comp. Zool. Vol. 61, p. 9, Jan., 1917). In 1919 Mr. H. E. Anthony noticed that the course of the upper incisor of *Geocapromys* is clearly shown on the face of the maxillary as a prominent swelling on the wall of the antorbital foramen, while in *Capromys* no such swelling is present (Bull. Amer. Mus. Nat. Hist., Vol. 41, p. 631, Dec. 30, 1919). In his 1917 paper Dr. Allen, misled by Chapman's imperfect specimens of *Geocapromys columbianus*, made his own better material of the Cuban animal the basis of the new name *G. cubanus* (p. 9), and proposed (p. 5) the generic name *Synodontomys* for the original *C. columbianus*. These errors he later recognized and corrected (Bull. Mus. Comp. Zool., Vol. 62, p. 145, May, 1918). When preparing the copy for my "List of North American Recent Mammals 1923" I concluded that the dental features pointed out by Allen and Anthony did not warrant the generic separation of the group from *Capromys*. Not knowing of any other characters I relegated *Geocapromys* to subgeneric rank again. More recently, while examining broken skulls from caves in Cuba, I found that there are important and constantly present features of both skull structure and tooth arrangement that fully justify the generic separation of the two groups. The diagnostic characters may be tabulated as follows:

- Preorbital bar of maxillary sloping obviously forward; root capsule of upper incisor terminating in contact with outer half of anterior border of alveolus of pm^4 ; bases of alveoli of right and left pm^4 separate, not encroaching on floor of narial passage; pm_4 with only two reentrant angles on lingual side. *Capromys*
- Preorbital bar of maxillary vertical or sloping slightly backward; root capsule of upper incisor terminating above and ectad to anterior half of outer border of alveolus of pm^4 ; bases of alveoli of right and left pm^4 in contact, encroaching on floor of narial passage; pm_4 with a small third reentrant angle on lingual side *Geocapromys*

REMARKS ON GEOCAPROMYS

Skull.—The ascending branch of the maxillary dividing the orbit from the antorbital foramen is vertical (*G. ingrahami*) or backward-sloping (*G. brownii* and *G. thoracatus*) in relation to alveolar line instead of conspicuously forward-sloping as in *Capromys* (pl. I, figs. 1 and 2). By this character alone any one of the three living species can be distinguished from any of the four living *Capromys*. (I have not seen a specimen of the extinct *G. columbianus* in which the ascending branch is preserved). The backward slope in *Geocapromys* is never so strong as the forward slope in *Capromys*, but the difference is obvious when the general direction of the ascending branch is compared with the line of the alveolar margin.

Teeth.—Root of upper incisor encapsuled in the lower half of the maxillary wall of the antorbital foramen (see pl. I, fig. 1), the distance between the outer surfaces of the very obvious incisor capsules of opposite sides greater than that between the outer sides of the basal capsules of the opposite first molars. In *Capromys* the root of the incisor terminates opposite the antero-inner edge of the lower lip of the antorbital foramen (pl. I, fig. 2), and the transverse diameter of the rostrum through the scarcely evident capsules is less than that through the bases of the first molars. The base of pm^4 , which is hidden by the incisor capsule in *Geocapromys*, often forms an obvious external swelling in *Capromys* (as in pl. I, fig. 2).

These characters indicate that the members of the two genera have been developing along consistently different lines. In *Capromys* the incisor root has pushed back to a position where more advance is prevented by contact with the base of pm^4 ; in *Geocapromys* its position is such that it could be extended much farther back in a capsule lying along the outer surface of the molar shafts as in *Spalacopus*. The *Capromys* condition is nearly paralleled in *Octodontomys*. In correlation with the position of the incisor roots the molar roots are

farther apart in *Capromys* than in *Geocapromys*. This character is not visible in complete skulls, but is evident in the broken-away palates so often found in caves. The upper surface of such a fragment of the maxillary (lower floor of nares) in the region between the anterior zygomatic roots is traversed by a deep median sulcus in *Capromys* occupying the space between the rather widely separated bases of the opposite premolars; in *Geocapromys* there is no median sulcus between the premolars, but the maxillary rises as a broad flat plate to the level of the connate bases of these teeth. Immediately behind this level the groove begins, passing backward to the posterior nares between the progressively more separated roots of the molars.

The genus *Geocapromys* contains four species—the living *G. brownii* (Fischer) of Jamaica, *G. thoracatus* (True) of Little Swan Island, Gulf of Honduras, *G. ingrahami* (Allen) of Plana Keys, Bahamas, and the extinct though geologically Recent *G. columbianus* (Chapman) of Cuba (with its synonym *G. cubanus* G. M. Allen).

EXPLANATION OF PLATE

All figures natural size

- FIG. 1. *Geocapromys brownii* (Fischer). Adult female. No. 143851, U. S. Nat. Mus. Jamaica. *i* = base of incisor capsule.
- FIG. 1a. *Geocapromys brownii* (Fischer). Adult male. No. 141908, U. S. Nat. Mus. Jamaica. Palate cut away from skull and viewed from above. *pm* = base of premolar, *i* = base of incisor capsule.
- FIG. 2. *Capromys pilorides* Desmarest. Small individual, No. 103884, U. S. Nat. Mus. Cuba. *pm* = capsule at base of premolar, *i* = base of incisor capsule.
- FIG. 2a. *Capromys pilorides* Desmarest. Large individual. No. 253232, U. S. Nat. Mus. Palate cut away from skull and viewed from above. *pm* = base of premolar, *i* = base of incisor capsule.
- FIG. 2b. *Capromys* sp. No. 254679, U. S. Nat. Mus. Cuba (cave deposit). Palate cut away from skull and viewed from above. *pm* = base of premolar, *i* = base of incisor capsule.

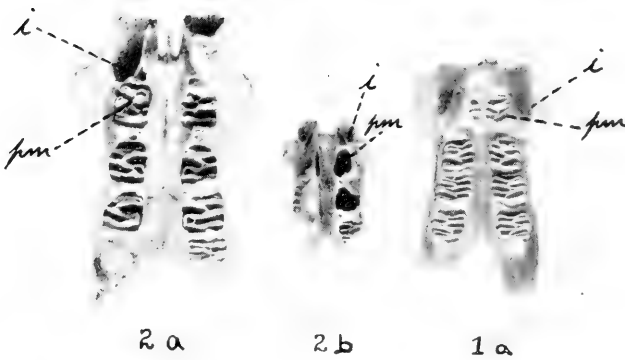
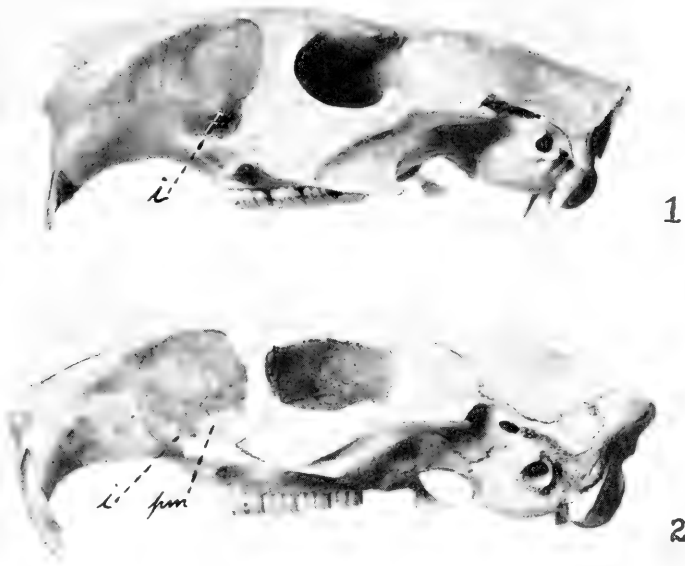

1. *Geocapromys*.
2. *Capromys*.
(All figures natural size)

SMITHSONIAN MISCELLANEOUS COLLECTIONS

VOLUME 82, NUMBER 5

MAMMALS EATEN BY INDIANS, OWLS, AND
SPANIARDS IN THE COAST REGION OF
THE DOMINICAN REPUBLIC

(WITH TWO PLATES)

BY

GERRIT S. MILLER, JR.

Curator, Division of Mammals, U. S. National Museum



(PUBLICATION 3030)

CITY OF WASHINGTON

PUBLISHED BY THE SMITHSONIAN INSTITUTION

DECEMBER 11, 1929



SMITHSONIAN MISCELLANEOUS COLLECTIONS
VOLUME 82, NUMBER 5

MAMMALS EATEN BY INDIANS, OWLS, AND
SPANIARDS IN THE COAST REGION OF
THE DOMINICAN REPUBLIC

(WITH TWO PLATES)

BY

GERRIT S. MILLER, JR.

Curator, Division of Mammals, U. S. National Museum



(PUBLICATION 3030)

CITY OF WASHINGTON
PUBLISHED BY THE SMITHSONIAN INSTITUTION
DECEMBER 11, 1929

The Lord Baltimore Press
BALTIMORE, MD., U. S. A.

MAMMALS EATEN BY INDIANS, OWLS, AND
SPANIARDS IN THE COAST REGION OF
THE DOMINICAN REPUBLIC

By GERRIT S. MILLER, JR.

CURATOR, DIVISION OF MAMMALS, U. S. NATIONAL MUSEUM

(WITH TWO PLATES)

In February and March, 1928, I visited the Samaná Bay region, northeastern Dominican Republic with the special object of obtaining remains of mammals in the Indian deposits that had been previously examined by Gabb in 1869-1871 and Abbott in 1916-1923. I was accompanied by Mr. H. W. Krieger, who had charge of the strictly ethnological side of the work. Together or separately we obtained material from six localities: four on the south shore of Samaná Bay; one, Anadel, near Samaná town, on the north shore of the bay; and one, a large Indian site at the mouth of the Río San Juan, on the Atlantic coast, across the peninsula from Samaná.¹ Mr. Krieger returned alone the following winter and revisited the places that we had previously worked. He also made excavations in two village sites not far from Monte Cristi at the northeastern extremity of the Republic.

At all of these localities we obtained many bones of mammals from the heaps of Indian refuse. Only once, however, in a lateral recess about half way up the sloping floor of the cave that occupies most of the islet of San Gabriel, off the south shore of the bay, did we find an owl-made deposit of extinct mammals. Here, as at St. Michel, Haiti, the small living barn owl had plentifully bestrewn the surface with dejecta containing bones of bats, small birds, and the introduced European rats and mice. Immediately beneath its surface the cave floor material was intermingled with the bones of the larger native rodents that had been devoured by the great extinct owl. This deposit was not more than two feet deep, and, unlike the kitchenmidden lying in the lower level of the cave, it was considerably hardened

¹ A general account of this work was published in *Expl. and Field-Work Smithsonian Inst.*, 1928, Smithsonian Publ. No. 3011, pp. 43-54, March 22, 1929.

by infiltrated lime drip. Other owl deposits of the same kind may have once existed in the neighboring caves, but if so, they all appear to have been removed years ago by guano diggers. The specimens that we obtained in these caves and village sites form the subject matter of the present paper.

While no hitherto unknown species are represented in our collections the material proves to be of much interest. It throws additional light on the characters and distribution of the two species of *Plagiodontia* that I recognized in 1927 as occurring in the Dominican Republic (Proc. U. S. Nat. Mus., Vol. 72, Art. 16, pp. 1-8, Sept. 30, 1927); it furnishes the means to identify all four of the native mammals, the hutia, the quemi, the mohuy and the cori, that Oviedo said were habitually eaten by both natives and Spaniards during the early years of the sixteenth century; and finally it shows beyond the possibility of reasonable doubt that this recently extinct fauna included a ground sloth.

The identity of only two of the mammals that Oviedo ascribed to the island of Hispaniola remains to be determined—the “dumb dog” and the indigenous rat. The few dog bones collected appear to differ in no way from the corresponding parts of European dogs, and there is nothing to prove that they represent the native breed. Hence the status of the famous “perro mudo,” the dog that was unable to bark, is still as much of a mystery as ever. Equally obscure is the question as to whether or not there were rats on the island at the time of its discovery. Oviedo relates that on inquiring into this matter he found those who told him that “mures ó ratones” did in fact then exist; a circumstance that appeared to him quite believable because these animals were so well known to be generated, like flies, mosquitoes, wasps, and grubs, anywhere, out of any kind of putrifying matter, a not unnatural belief at the time when he wrote, more than 125 years before Francisco Redi had published his “Esperienze Intorno Alla Generazione Degl' Insetti.” Nevertheless our search has failed to reveal a trace of rats or mice other than the European species that could have easily been brought by the Spaniards on their ships. After enumerating the specimens that we obtained I shall return to the subject of Oviedo's mammals in greater detail.

DESCRIPTION OF COLLECTING STATIONS

1. *Railroad cave*.—A large cave situated about 15 minutes walk inland along the abandoned railroad on the south shore of San Lorenzo Bay. There is an extensive kitchenmidden at the entrance. I was not able to find any trace of a bone deposit made by the extinct owl,

though pellets of the living bird were abundant in one of the chambers.

This may be the "Cuèva del Templo" of Rodriguez (Geografia fisica, politica e historica de la Isla de Santo Domingo o Haiti, p. 367, Santo Domingo City, 1915).

2. *Boca del Infierno*.—Two large caves, one in each of the projecting points at the locality marked Pta. de Boca del Infierno on the Hydrographic Office chart of Samaná Bay.

The larger cave is in the smaller, inner point. It has been extensively worked for guano, but some of the original floor material remains. Near the outer entrance there is a small kitchenmidden. A few leg bones of extinct rodents were found in this cave, but no skulls or jaws.

At the inner entrance to the other cave we found the remnant of a kitchenmidden left intact by the guano diggers. From this deposit we unearthed bones of both the "quemi" and the ground sloth, mammals whose remains have not been found elsewhere among the Indian refuse.

These caves appear to be, respectively, the "Boca del Infierno" and the "Cueva del Infierno" of Rodriguez. It is probable that in one or the other of them Gabb collected the bones of *Plagiodontia* that I recorded in 1916.

3. *San Gabriel*.—An islet about two miles west of Boca del Infierno. Most of its interior is occupied by a large cave, the floor of which slopes rather steeply upward from an opening on the south side facing the shore to another on the north side overlooking Samaná Bay. There is a large kitchenmidden near the lower entrance, and a deposit made by the extinct owl on the left side of the passage leading up to the north aperture.

4. *Rio Naranjo Abajo*.—A kitchenmidden was found on a nearly level rock ledge, perhaps one-fourth acre in extent, on a key lying about half a mile east of the stream mouth.

These four localities are all on the south shore of Samaná Bay in the region known as the Playa Honda coast. Rodriguez describes the caves under the general title: "Cuevas de los Haitís."

5. *Anadel*.—A large village site at a stream mouth on the north shore of Samaná Bay about $1\frac{1}{2}$ miles east of Santa Bárbara de Samaná.

6. *Rio San Juan*.—Another large village site on the Samaná Peninsula. It lies at the point where the Rio San Juan flows into the Atlantic Ocean, almost directly north of Santa Bárbara de Samaná.

7 and 8. *Kilometer 2 site and Kilometer 4 site*.—Two very extensive village sites in the foothills of the mountains southeast of Monte Cristi. Both of these localities differ from those in the Samaná Bay region in being situated in the semiarid portion of the island.

LIST OF MAMMALS COLLECTED

NESOPHONTES PARAMICRUS Miller

Railroad cave.—Humerus, 1.

San Gabriel (owl deposit).—Mandibles, 3; humeri, 4; femora, 6; innominate, 1.

It is impossible to determine whether or not the presence of the humerus in the Railroad cave kitchenmidden indicates that *Nesophontes* was eaten by the Indians. In this cave such a bone might as well have been dropped by an owl as by a man.

NESOPHONTES HYPOMICRUS Miller

San Gabriel (owl deposit).—Mandibles, 4; humerus, 1; femur, 1; innominate, 1.

The remains of both species of *Nesophontes* agree perfectly in size and other characters with topotypes from St. Michel, Haiti.

SOLENDON PARADOXUS Brandt

Railroad cave.—Perfect right humerus, 1.

Naranjo Abajo.—Mandible, 1; distal half of left humerus, 1.

Rio San Juan.—Mandible, 1.

Kilometer 2 site.—Distal half of humerus, 1.

These specimens do not differ in any way from the corresponding parts of the living animal. Their presence in three widely separated kitchenmiddens is sufficient indication that *Solenodon* was customarily eaten by the Indians.

EPTESICUS HISPANIOLAE Miller**MACROTUS WATERHOUSII WATERHOUSII** Gray**ARTIBEUS JAMAICENSIS JAMAICENSIS** Leach

A few remains of these common Dominican bats were found in the owl deposit in San Gabriel cave.

CANIS FAMILIARIS Linnaeus

Kilometer 2 site.—Right mandible, immature, 1; both mandibles of a very young individual, 1 pair; separate milk pm⁴, 1; adult m², 2 (not from same individual); adult canine, 1; adult incisor, 1; auditory bulla, 1; vertebrae, 8; ribs, 2; fragments of pelvis, 4 (representing at least 2 individuals); tibia, proximal end, 1; tibia, distal end (probably of another individual), 1; calcanea, 2 (opposites); astraga-

lus, 1 (apparently belongs with the calcanea); metapodials, 9; imperfect scapula, 1; ulna, 1; radius (perfect) 1; radius (proximal end only), 1.

The remains pertain to at least two adult dogs and two puppies. Taking the radius (total length 127.6 mm.) scapula, and teeth as guides, the animal must have been about the size of a Scotch terrier whose skeleton is now in the National Museum, No. 21997 (total length of radius 120.2 mm.).

I am unable to find characters in any of these specimens that suggest specific or racial peculiarities as compared with domestic dogs of European origin or with pre-Columbian dogs from either North or South America. Furthermore, as the middens near Monte Cristi yielded bones of both pig and cow, there is no reason to suppose that the dog had any other than European origin. The apparent absence of dog bones from all the other deposits of Indian refuse is a clear indication that the natives did not habitually use these animals as food.

CERCOPITHECUS ? sp. ?

Plate 2, fig. 4

Naranjo Abajo.—Distal end of tibia, 1.

The well preserved distal end (42 mm.) of a monkey's tibia was found among the miscellaneous long bones dug from the kitchen-midden on the Naranjo Abajo key. The exact level at which it lay was not determined. In state of preservation the bone is essentially like the rodent leg bones from the same deposit.

I cannot identify this fragment with the corresponding part of any American primate, chiefly because the shaft of the bone, immediately above the articular enlargement is too robust. By this character the fragment (pl. 2, fig. 4) can at once be distinguished from specimens of *Cebus* (pl. 2, fig. 6) *Ateles*, and *Alouatta*, the only common genera containing species large enough to approach it in size. When compared with *Cercopithecus* (pl. 2, fig. 5), however, the discrepancy is less obvious, though I have not been able to find an African tibia that I should regard as certainly pertaining to the same species. As members of this genus were early introduced into the Lesser Antilles I am inclined to believe that the monkey of the Naranjo Abajo key had been brought over alive before the Indians abandoned the coast of Samaná Bay.

BROTOMYS VORATUS Miller

Plate 1, fig. 3

Railroad cave.—Skull, lacking braincase and all teeth except pm⁴, 1; fragments from interorbital region, 2; mandibles, 7.

Boca del Infierno.—Humerus, 1.

San Gabriel (owl deposit).—Lower incisor, 1; humeri, 3.

San Gabriel (culture deposit).—Mandible, 1.

Naranjo Abajo.—Right side of palate with pm^4 and m^1 in place, 1; mandibles, 3.

Anadel.—Mandibles, 14.

Rio San Juan.—Right side of palate with all four teeth in place, 1; fragment of premaxilla with incisor in place, 2; mandibles, 43.

Kilometer 2 site.—Right premaxilla and anterior portion of palate with pm^4 in place, 1; palate with all the alveoli and pm^4 left and pm^4 and m^1 right in place, 1. Left side of palate with alveoli of all four teeth, 1; mandibles, 61.

Kilometer 4 site.—Mandibles, 16.

The frequency with which the bones of this animal occur in the Indian deposits indicates that *Brotomys* must have been abundant and generally distributed in pre-Columbian days. It was probably much like the living South American spiny-rats in size and general form, but with heavier, less elongated head. I have little doubt that this animal was the mohuy described by Oviedo as the most eagerly sought for of the native edible quadrupeds (see p. 13).

This material agrees in all essential features with the original specimens from San Pedro de Macoris and with those that have been collected in the Haitian cave deposits. Except for individual peculiarities that appear to be due to age the jaws are very constant in all their characters. I can detect no differences between those collected in the humid Samaná Bay region and those from the semiarid country near Monte Cristi.

In one jaw from Kilometer 2 site, the premolar is in a stage of wear to show that the small enamel "lake" usually present in the anterior lobe of the crown is the remnant of a reentrant fold penetrating from the outer side of the tooth.¹ In two others from Rio San Juan, the lake has been joined to the tip of the anterior inner reentrant fold, while in one specimen from the same locality, the crown, though not excessively worn, shows no trace of the anterior "lake," its pattern thus resembling that of the molars.

ISOLOBODON PORTORICENSIS Allen

Plate 1, fig. 6

Railroad cave.—Imperfect skulls, 4; left half of rostrum, 1; right premaxillary with incisor, 1. Left half of palate, without teeth, 1; right half of palate, m^1 in place, 1; mandibles, 20.

¹ An even better specimen in the same stage was collected by Arthur J. Poole in the small cave near St. Michel, Haiti.

Boca del Infierno.—Imperfect palate with left m^2 in place, 1; mandibles, 7.

San Gabriel (culture deposit).—Palate, 1; fragment of left premaxilla with incisor, 1; mandibles, 3.

Naranjo Abajo.—Palate with right m^2 in place, 1; upper molar of a larger individual, 1; mandibles, 3.

Anadel.—Palate with all teeth, 1; fragments of rostrum with incisor, 5; occipitals, 1; mandibles, 41. Numerous odd teeth.

Rio San Juan.—Broken skull, 1; complete palate with all teeth, 1; palate lacking left m^3 , 1; fragments of palate, 9; fragments of rostrum with incisor, 10; mandibles, 184.

Kilometer 2 site.—Imperfect skull, 1; fragments of palate, 3; mandibles, 10.

ISOLOBODON LEVIR (Miller)

Plate 1, fig. 5

San Gabriel (owl deposit).—Imperfect skulls, 2; palate with right molars in place, 1; separate maxillary teeth, 2; mandibles, 13.

Kilometer 2 site.—Palates and fragments, 21; mandibles, 281.

These specimens agree with the original series from caves near St. Michel, Haiti, and differ obviously from the remains of *Isolobodon portoricensis* recovered from the kitchenmiddens in the Samaná region. Among 15 jaws selected for large size, the length of mandible from articular process ranges from 44.6 to 48 mm., height of ascending ramus through articular process from 20.6 to 23 mm., and alveolar length of toothrow from 16 to 17.6 mm. In 11 jaws of *I. portoricensis* from the San Juan River, also selected for large size, the extremes of the same measurements are respectively 50 to 52.6 mm., 24 to 26.6 mm. and 19 to 20.8 mm.

After examining the entire series of Santo Domingan *Isolobodon* remains I am still as unable to distinguish the large form from the Porto Rican *I. portoricensis* as I was in 1918 on the basis of the very few specimens then collected. It seems improbable that such a distribution could exist without human intervention. No other species of rodent has been found to be common to the two islands and no species could be expected to remain constant in two areas that have been separated as long as these two land masses. Finally, Porto Rico and the eastern part of the Dominican Republic, together with the Virgin Islands, where the same large *Isolobodon* also occurred, are in a region known to have been freely traded over by pre-Columbian man in his sea-going canoes. It must be admitted, however, that the hypothesis of human transportation meets with a difficulty

not easy to dispose of, namely, the fact that no *Plagiodontia* or *Brotomys* seems to have been carried in the opposite direction to Porto Rico or the Virgin Islands.

At only two localities have the large and small forms of *Isolobodon* thus far been found together, in the kitchenmidden at the Kilometer 2 site near Monte Cristi and in San Gabriel cave. In the kitchenmidden the remains of the two were mingled together—ten jaws of the large animal among a total of 290. In the cave they occurred separately—the large animal in the culture deposit at the main (south) opening, the small one in the owl deposit near the middle of the long, ascending passage that leads up to the aperture facing north. All the bones in the owl deposit have the appearance of much greater age than those in the midden. The material in which they were found is heavily and uniformly impregnated with lime, while that in the midden, like that in the human deposits in all the neighboring caves, shows no such infiltration except at spots where actual drip from the ceiling is now taking place. The presence of *Aphætreus montanus* among the owl refuse may also be an indication of greater age, as this rodent has not yet been found in any midden, though it is the second most common species in the owl-made cave deposits near St. Michel, Haiti.

On the assumption that *Isolobodon portoricensis* was introduced by man in the Samaná Bay region, these facts would be explained by supposing that the San Gabriel owl deposits were formed before the importation of this larger species and the subsequent extermination of the smaller indigenous form. The process of replacement of the smaller animal by the larger would have afterward become so complete throughout the Samaná region that no remains of the native species have been found in the deposits left by the Indians. Extending its range westward, *Isolobodon portoricensis* would have just begun to establish itself near Monte Cristi when both it and the Indians became extinct.

APHÆTREUS MONTANUS Miller

San Gabriel (owl deposit).—Mandibles, 3.

These specimens show no peculiarities as compared with jaws from the type locality, near St. Michel, Haiti.

No bones of *Aphætreus* have yet been found in any culture deposit.

PLAGIODONTIA ÆDIUM F. Cuvier

Plate I, fig. 2

Anadel.—Imperfect skulls, 2; fragments of palate, 2; mandibles, 20; odd teeth, 9.

Rio San Juan.—Rostrum with incisors and first two cheekteeth, 1; fragments of premaxilla with incisor, 1; mandibles, 30; odd teeth, 25.

Kilometer 2 site.—Fragments of palate, 2; complete mandible, 1; fragments of mandibles, 2; odd teeth, 3.

Kilometer 4 site.—Fragment of palate, 1; mandibles, 6; odd teeth, 5.

PLAGIODONTIA HYLÆUM Miller

Plate 1, fig. 1

Railroad cave.—Imperfect skulls, 2; right side of rostrum with incisor, 1; palate lacking m^3 of both sides, 1; mandibles, 4.

San Gabriel (owl deposit).—Mandible, 1 young; left lower incisor, adult, 1.

The specimens now at hand enable me to confirm the original diagnosis of *Plagiodontia hylæum* and also to add two important characters.

That the living animal is decidedly smaller than *Plagiodontia ædium* is abundantly shown by comparison of the skulls and jaws from Guarabo and the south shore of Samaná Bay with the remains of the larger animal collected on the Samaná peninsula and near Monte Cristi. The 12 jaws of *P. hylæum* whose measurements are given in the original description range from 51 to 55.2 mm. in length. An additional specimen from the Railroad cave is slightly imperfect but its length must have been about 51 mm. One mandible of *P. ædium* from San Pedro de Macoris was recorded as slightly more than 62 mm. long. Unfortunately most of the jaws from the Samaná Peninsula are injured at one end or the other, so that their length cannot be determined, but two from Anadel give measurements of approximately 61 and 62 mm. A measurement that is more useful, because mandibles are seldom so badly broken that it cannot be taken, is the depth from the alveolar margin to the protuberance made by the root of pm_4 . In 10 jaws of *Plagiodontia ædium* this depth averages 16.3 mm. with extremes of 15.4 and 17.4 mm. In an equal number of jaws of the smaller animal the average depth is 13.2 mm., the extremes 12.2 and 14.0 mm. Similarly obvious and constant is the difference between the alveolar length of mandibular toothrow in the two species. Ten specimens of each give the following averages and extremes: *P. hylæum*, 19.8 mm. (18.6 to 20.6 mm.); *P. ædium*, 24.2 mm. (23.2 to 25.4 mm.).

The most important character brought to light by the new material is, however, the difference in relative length of the first and second maxillary cheekteeth. In *Plagiodontia hylæum* the crown length in-

creases gradually and rather uniformly from the fourth tooth to the first; in *P. ædium* there is the same gradual increase from fourth to second, and then an obviously and abruptly greater increase from second to first (see pl. 1, figs. 1 and 2). The relative lengths of the first and second teeth, measured along the median line of the grinding surface is as follows in seven specimens of each species: *P. hylæum*, pm⁴, average 6.1; m¹, average 5.1; ratio of premolar to molar 119.8; *P. ædium*, pm⁴, average 7.6; m¹, average 5.6; ratio of premolar to molar 135.7.

CAPROMYS PILORIDES Desmarest

Plate 1, fig. 4

San Gabriel (culture deposit).—Complete nasals and turbinates, 1; right mandibles (all toothless), 5; upper incisors, 2.

These specimens were found near together in the San Gabriel kitchenmidden at a depth of about three feet. They do not differ from the corresponding parts of Cuban skulls of *Capromys pilorides* in any way that I can discover. Consequently I have no doubt that the animals to which they pertained were brought to the cave as food, either by the Indians or by early European sailors.

QUEMISIA GRAVIS Miller

Plate 2, fig. 3

Boca del Infierno.—Distal half of right femur, 1; proximal extremity of left ulna, 1.

Both fragments (pl. 2, fig. 3) were found at a depth of about four feet in the kitchenmidden near the south entrance to the outermost of the two caves.

As compared with the corresponding part in the Porto Rican *Elasmodontomys* the distal extremity of the femur has a reduced antero-posterior diameter (ratio to lateral diameter about 78 instead of 92.5 and 93.6 in two *Elasmodontomys*); the shaft is more flattened on its anterior aspect and less flattened on its posterior aspect; and the antero-posterior diameter at middle of shaft is less in proportion to the transverse diameter.

As compared with the femurs of *Isolobodon* and *Plagiodontia* from the Samaná region this fragment is at once distinguishable by its strikingly greater size. It appears to correspond perfectly with the opposite end of the femur of *Quemisia* that I found in one of the caves near the Atalaye Plantation, St. Michel, Haiti; and its presence

in a kitchenmidden confirms my belief that this large rodent is Oviedo's "quemi."

CAVIA sp.

Anadel.—Mandibles, 2 (opposites but not from one individual).

I cannot distinguish these jaws from specimens of *Cavia porcellus*. They present every appearance of having been buried as long as the remains of *Brotomys voratus* and *Plagiodontia adium* with which they were associated.

ACRATOCNUS COMES Miller ?

Plate 2, fig. 2

Boca del Infierno.—Penultimate phalangeal bone, probably of second or fourth pedal digit, 1.

This bone was found in the kitchenmidden at the south entrance to the outermost of the two caves. It was unearthed at a depth of not more than four feet, near the femur of *Quemisia*, with which it agrees in its perfect and seemingly unmodified condition of preservation. Both bones, in fact, seem to be, so far as it is possible to determine from superficial inspection, in essentially the same state as bones of the living species of *Plagiodontia* with which they were associated. There appears to be no longer the slightest reason to doubt that a ground sloth was a member of the recently man-exterminated fauna of Hispaniola.¹

This bone (pl. 2, fig. 2) is similar in general form to the second right pedal phalanx of the Patagonian *Hapalops elongatus* as figured by Scott (Rep. Princeton Univ. Exped. Patagonia, Vol. 5, Palaeont, 2, pl. 41, fig. 2), but it is about 2 mm. longer and its proximal extremity appears to be deeper. It also resembles in a general way an isolated phalangeal bone of *Acratocnus* from Porto Rico figured by Anthony (Mem. Amer. Mus. Nat. Hist., n. s. Vol. 2, Pt. 2, fig. 53 f, p. 425, 1918). From an imperfect specimen that may represent the corresponding bone in *Acratocnus comes* it differs rather noticeably in the less diameter of the distal articular region (compare pl. 2, figs. 1 and 2) and the more abrupt deepening toward the proximal end.

TRICHECHUS MANATUS Linnaeus

Rio San Juan.—Fragments of palate, 2 (large and small); imperfect ribs, 2.

¹ I have already discussed the evidence to this effect furnished by the conditions existing in the caves near St. Michel, Haiti (Smithsonian Misc. Coll., Vol. 81, No. 9, pp. 25-26, March 30, 1929).

Kilometer 2 site.—Palate, 1; odd teeth, 8; vertebrae, 2.

Kilometer 4 site.—Fragments of occipital region, 2; fragments of mandible, 2; broken ribs, 13; humerus, 1; distal end of humerus, 1; fragment of scapula, 1; fragment of femur, 1.

These specimens do not differ appreciably from Florida material, except that the alveoli in the palate found at the Kilometer 2 village site appear to be exceptionally large.

THE MAMMALS DESCRIBED BY OVIEDO

Gonzalo Fernandez de Oviedo y Valdés (1478-1557), the first European chronicler of things West Indian, was alcalde of Santo Domingo City from January, 1536, to August, 1546. In his *HISTORIA GENERAL Y NATURAL DE LAS INDIAS*, Book 12, Chapters 1 to 6 (pp. 389-392 of the edition issued by the Royal Academy of History, Madrid, 1851) he described the following mammals as known or believed by him to inhabit the island of Hispaniola: the hutia, the quemi, the mohuy, the cori, the dumb dog ("perro mudo") and the mice ("mures ó ratones").

Hitherto there has been much doubt as to the exact identification of these animals, for the reason that *Plagiodontia ædium* and *Solenodon paradoxus* were, up to a few years ago, the only indigenous mammals known, other than bats and sea-cows. It now seems possible, however, to allocate all of Oviedo's names, with the exception of the "dumb dog." I shall take them up in order.

THE HUTIA

Oviedo writes that there occur in this island of Hispaniola, and in others lying in the seas near it, animals called hutia, four-footed, and resembling a rabbit, but smaller sized, smaller eared and rat-tailed. The natives, he says, kill them with small dogs that they have in domestication, dumb and not knowing how to bark; and the Christians do this much better with the dogs they brought from Spain. "These animals are grizzled gray (pardo gris) in color according to the evidence of many who have seen and eaten them and who praise them as food; and there are now many persons in this city of Santo Domingo and in this island who say so. But at present these animals are no longer found except very rarely."

This account would apply so well to the species of *Plagiodontia*, and presumably also to the *Isolobodons*, that there seems to be no reason to doubt that these were the animals that Oviedo had in mind. By the present day Dominicans the name seems to have been trans-

ferred to *Solenodon*; at least, such persons whom I met as knew of an animal called hutia expatiated on the great length and pointedness of the creature's snout. The very few who were acquainted with *Plagiodontia hylæum* happened to be English speaking descendants of negroes from the United States. They always spoke of the animal as the "muskrat," and they told me that many of these creatures had been killed by the workmen who cleared the narrow San Lorenzo Peninsula for coconut planting 20 or more years ago.

THE QUEMI

The quemi resembled the hutia in color and general appearance, but was much larger, its size equaling that of a medium-sized hound. Oviedo did not see it himself, and he believed it to be extinct. However, he assures his readers that: "There are many persons in this island and in this city who have seen and eaten these animals and who declare that they were good food; but in truth, according to what has been said and known about the hardships and deprivations that the first colonists endured in this island it can be presumed that everything that could be eaten must have then appeared to them very good and delicious, even when it was not."

The qualifications of an animal resembling the hutia, good to eat, and as big as an ordinary hound seemed to me to be fulfilled by the large rodent whose remains I found in the caves near St. Michel, Haiti, in 1925. Consequently I proposed for it the generic name *Quemisia*. The presence of the same creature in the Boca del Infierno kitchenmidden appears to confirm my guess.

THE MOHUY

"The mohuy is an animal somewhat smaller than the hutia: its color is paler and likewise gray. This was the food most valued and esteemed by the caciques and chiefs of this island; and the character of the animal was much like the hutia except that the hair was denser and coarser (or more stiff), and very pointed and standing erect or straight above. I have not seen this animal, but there are many who declared it to be as aforesaid; and in this island there are many persons who have seen it and eaten it, and who praise this meat as better than all the others we have spoken about."

There can be little, if any doubt that the animal Oviedo thus described was *Brotomys voratus*. This rodent was smaller than either *Plagiodontia hylæum* or *Isolobodon levir*, and its remains have been found in every kitchenmidden that has been examined in the Domini-

can Republic (the type specimen came from San Pedro de Macoris), a fact that shows how universally it was liked as food. Finally the account of stiff, pointed, erect-standing hairs of the back seems especially applicable to a relative of the South American spiny-rats.

THE CORI

Oviedo had first-hand knowledge of the cori. Consequently his description of it is more detailed and accurate than in the case of the three preceding animals. He writes: "The cori is a small quadruped, the size of a half grown young rabbit. These coris appear to be a species of the rabbit kind although they have a muzzle like a rat but not so pointed. They have very small ears which they hold so close that it appears as if they lacked them or did not have any. They have no tail whatever; they are very slender as to feet and hands from the joints or hams downward; they have three fingers and another smaller, and very slender. They are wholly white, and others everywhere black, and the most of them spotted with both colors. Also some are wholly reddish and some spotted with reddish and white." Continuing his account he says that the coris are kept in the house and fed on grass, with some cassava to fatten them. He has eaten them and found them to taste like young rabbit. When he wrote they were plentiful in Santo Domingo City. They were also to be found on other islands and on the mainland.

It is not difficult to recognize the guineapig in this account of the cori; but if any doubts might have existed, in the absence of more tangible evidence, they are disposed of by Mr. Krieger's discovery of the two *Cavia* jaws in the kitchenmidden at Anadel. It remains an open question whether the guineapig was introduced by the Spaniards or by native trade with South America. I incline to the first alternative, chiefly because remains of the animal have been found in only one midden. Bones of cow, horse, and pig, as well as artifacts of European origin occasionally occur in the Indian deposits, showing that the native village sites continued to be used for some time after the Spanish conquest began, and that material brought in by the newcomers found its way to the aboriginal refuse heaps. Such might easily have been the history of the guineapig jaws at Anadel.

THE DUMB DOG

In his account of the hutia we found Oviedo alluding to a native dog that could not bark, but which was, nevertheless, very useful as a game getter. On pages 390-391 of the 1851 edition of his book

he gives an extended account of the dogs formerly and at the time of his residence (1536-1546) occurring on the island of Hispaniola. Parts of this account I translate as follows: "Domestic cur dogs were found in this island of Hispaniola and in all the other islands of these seas (inhabited by Christians). They were bred by the Indians in their houses. At present there are none; but when they had them the Indians used them to capture all the other animals [that is, the hutia, the quemi, the mohuy and the cori] that have been spoken of in the preceding sections. These dogs were of all the colors that dogs have in Spain; some of a single color and others spotted with white and blackish or reddish or ruddy or any color that the coat is accustomed to have in Castile. Some woolly, others silky, others short-haired; but the most of them between silky and short-haired, and the hair of all of them more harsh than our dogs have, and the ears lively and alert like those of wolves. All of these dogs, here in this island and the other islands, were mute, and even though they might be beaten and killed they did not know how to bark: some of them yelped or whined when they were hurt."

Continuing, he tells us that he has seen dogs of the same kind on the mainland in the province of Santa Marta as well as in Nicaragua, and that in the latter country the natives regularly used them as food. He makes no mention of the eating of dogs by the natives of Hispaniola, and the complete absence of bones of this animal from the collections made by us in the Samaná region and by Theodoor de Booy at San Pedro de Macoris makes it seem probably that this habit did not exist, or at least that it was not very general. If the dumb dog was anything else than a special breed of *Canis familiaris* we have as yet no evidence of the fact.

The five animals thus described are, Oviedo insists (p. 391), the only furred terrestrial quadrupeds, other than rats or mice, native to Hispaniola. It therefore seems evident that he knew nothing about *Solenodon* or the ground sloth.

With regard to the mice, which he believed to be indigenous, there is no reason to suppose that they were not brought over by the Spaniards themselves. No native mammal the size of a mouse, except *Nesophontes*, has been found in any owl deposit or kitchenmidden on the island, and it seems improbable to the highest degree that this small insectivore could have been the animal known to Oviedo and supposed by him to have been spontaneously generated from some kind of corruption in this remote part of the world.

EXPLANATION OF PLATES

PLATE I

All figures natural size

- FIG. 1. *Plagiodontia hylæum* Miller. Adult male. No. 239891, U. S. Nat. Mus. The largest specimen of the living animal collected by Dr. W. L. Abbott. Guarabo, Dominican Republic, Nov. 24, 1923.
- FIG. 1a. *Plagiodontia hylæum* Miller. Adult female. No. 239888, U. S. Nat. Mus. Guarabo, Nov. 23, 1923.
- FIG. 2. *Plagiodontia ædium* Desmarest. Adult. No. 254376, U. S. Nat. Mus. Anadel, Dominican Republic.
- FIGS. 3 and 3a. *Brotomys voratus* Miller. Nos. 254683 and 254684, U. S. Nat. Mus. Railroad cave, San Lorenzo Bay, Dominican Republic.
- FIG. 4. *Capromys pilorides* Desmarest. Adult. No. 254449, U. S. Nat. Mus. San Gabriel cave, Samaná Bay, Dominican Republic. (Observe spacing of ridges in alveoli as compared with that of the ridges in alveoli of *Isolobodon*, fig. 6.)
- FIG. 5. *Isolobodon levir* (Miller). Adult. No. 254686, U. S. Nat. Mus. Near Monte Cristi, Dominican Republic.
- FIG. 6. *Isolobodon portoricensis* Allen. Adult. Railroad cave, San Lorenzo Bay, Dominican Republic.

PLATE 2

All figures natural size

- FIG. 1. *Acratocnus comes* Miller. Phalangeal bone from cave near St. Michel, Haiti. No. 253210, U. S. Nat. Mus.
- FIG. 2. *Acratocnus comes* Miller? Phalangeal bone from kitchenmidden in Boca del Infierno cave, Samaná Bay, Dominican Republic. No. 254680, U. S. Nat. Mus.
- FIG. 3. *Quemisia gravis* Miller. Parts of femur and ulna from kitchenmidden in Boca del Infierno cave, Samaná Bay, Dominican Republic. No. 254681, U. S. Nat. Mus.
- FIG. 4. Monkey. Lower end of tibia from kitchenmidden on Naranjo Abajo Key, Samaná Bay, Dominican Republic. No. 254682, U. S. Nat. Mus.
- FIG. 5. *Cercopithecus pygerythrus*. Lower end of tibia. Changamwe, British East Africa. No. 163327, U. S. Nat. Mus.
- FIG. 6. *Cebus capucinus*. Lower end of tibia. North Ecuador. No. 113418, U. S. Nat. Mus.

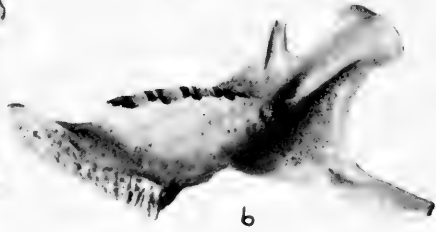
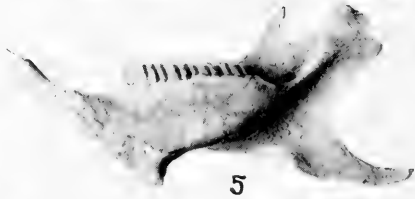
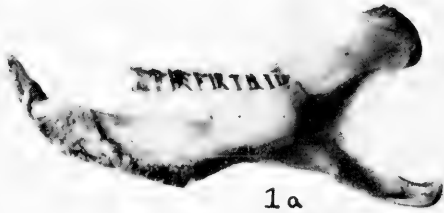
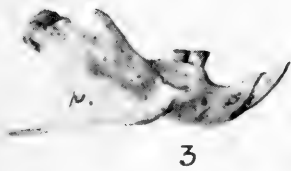

1. *Plagiodontia hyleum*.
2. *Plagiodontia redium*.
3. *Brotomys voratus*.

4. *Capromys pilorides*.
5. *Isolobodon levir*.
6. *Isolobodon portoricensis*.

(All figures natural size.)



1. *Acratocnus comes*.
 2. *Acratocnus comes?*
 3. *Quemisia gravis*.

4. Monkey (not identified).
 5. *Cercopithecus pygerythrus*.
 6. *Cebus capucinus*.

(All figures natural size.)

SMITHSONIAN MISCELLANEOUS COLLECTIONS
VOLUME 82, NUMBER 6

THE PAST CLIMATE OF THE NORTH
POLAR REGION

BY
EDWARD W. BERRY
The Johns Hopkins University



(PUBLICATION 3061)

CITY OF WASHINGTON
PUBLISHED BY THE SMITHSONIAN INSTITUTION
APRIL 9, 1930



SMITHSONIAN MISCELLANEOUS COLLECTIONS
VOLUME 82, NUMBER 6

THE PAST CLIMATE OF THE NORTH
POLAR REGION

BY
EDWARD W. BERRY
The Johns Hopkins University



(PUBLICATION 3061)

CITY OF WASHINGTON
PUBLISHED BY THE SMITHSONIAN INSTITUTION
APRIL 9, 1930

The Lord Baltimore Press
BALTIMORE, MD., U. S. A.

THE PAST CLIMATE OF THE NORTH POLAR REGION ¹

By EDWARD W. BERRY

THE JOHNS HOPKINS UNIVERSITY

The plants, coal beds, hairy mammoth and woolly rhinoceros; the corals, ammonites and the host of other marine organisms, chiefly invertebrate but including ichthyosaurs and other saurians, that have been discovered beneath the snow and ice of boreal lands have always made a most powerful appeal to the imagination of explorers and geologists. We forget entirely the modern whales, reindeer, musk ox, polar bear, and abundant Arctic marine life, and remember only the seemingly great contrast between the present and this subjective past. Nowhere on the earth is there such an apparent contrast between the present and geologic climates as in the polar regions and the mental pictures which have been aroused and the theories by means of which it has been sought to explain the fancied conditions of the past are all, at least in large part, highly imaginary.

Occasionally a student like Nathorst (1911) has refused to be carried away by his imagination and has called to mind the marvelously rich life of the present day Arctic seas, but for the most part those who have speculated on former climates have entirely ignored the results of Arctic oceanography. Recently, Kirk ² has marshalled some of the evidence of the abundance of the present marine life in the Arctic, and he concludes from this survey that marine organisms are not dependable as indicators of geologic climates. I think this conclusion is impregnable, and therefore if we are ever to get any information regarding past climates, the evidence will be furnished by fossil plants, and not too precisely either. Here again prudence is the watchword; imagination must be entirely suppressed, and the distribution of recent plants must be understood and used.

A correct solution of the problem is not only of prime interest to geologists and paleontologists but it offers assurance to geophysicists confronted with the now fashionable belief in wandering poles, and

¹ Given in summary before the Paleontological Society at the December, 1928, meeting.

² Kirk, Edwin, Fossil marine faunas as indicators of climatic conditions. *Ann. Rep. Smithsonian Inst. for 1927*, pp. 299-307, 1928.

likewise comfort to meteorologists confronted with the traditional view of a lack of climatic zones during most of the eons of earth history. I propose to pass in review what we know of the past distribution of plants in the Arctic, after which I will endeavor to evaluate what they mean in terms of climate.

Aside from some very scrappy plant fragments from the Silurian of Norway, the oldest traces of land plants in the north occur in rocks of Devonian age. Devonian plants have been discovered within the Arctic Circle at the three localities shown on the accompanying map (fig. 1). These range from a few scraps, such as those found in Ellesmere Land and Spitzbergen, to the extensive flora found on Bear Island which embraces 31 named forms. These three floras are of upper Devonian age but not necessarily synchronous, since an earlier and a later horizon is represented on Bear Island and probably on Spitzbergen.

I have shown on the map (fig. 1) the occurrence of some other Devonian floras outside the Arctic Circle and some in lower latitudes in order to give an idea of the known geographical range of Devonian plants in the present North Temperate Zone. The oldest of these is the Lower Devonian flora of Røragen, Norway, embracing eight very interesting forms. Of particular interest are the Middle Devonian plants found in silicified peats at Rhynie in northern Scotland and the flora described recently from Germany, since these give us our first considerable insight into the structure of these ancient plants.

In looking over the list of identifications from Bear Island, all except *Pseudobornia* are seen to belong to widely distributed types, several are identical with species from the south of Ireland, and similar forms occur rather generally in lower latitudes. There are several seams of coal at both the older and younger horizons, to which *Bothrodendron* contributed a large amount of material. Beneath the coal seams are underclays with roots in place and the plant remains show no sorting—that is, delicate material is mixed with stems and branches of all sizes—both facts indicating conclusively that the bulk of the material was not transported but grew in the immediate vicinity. The same statement is true of the Devonian of Ellesmere Land.

The plants of the Devonian are so remote from living forms that I do not feel that any conclusions regarding the climate are warranted beyond the statement that they show that there were no climatic barriers to prevent most of the types found in Latitude 45° to 50° extending northward to Latitude 75°. There are, however, certain types which have not yet been found in the north, such as *Eosper-*

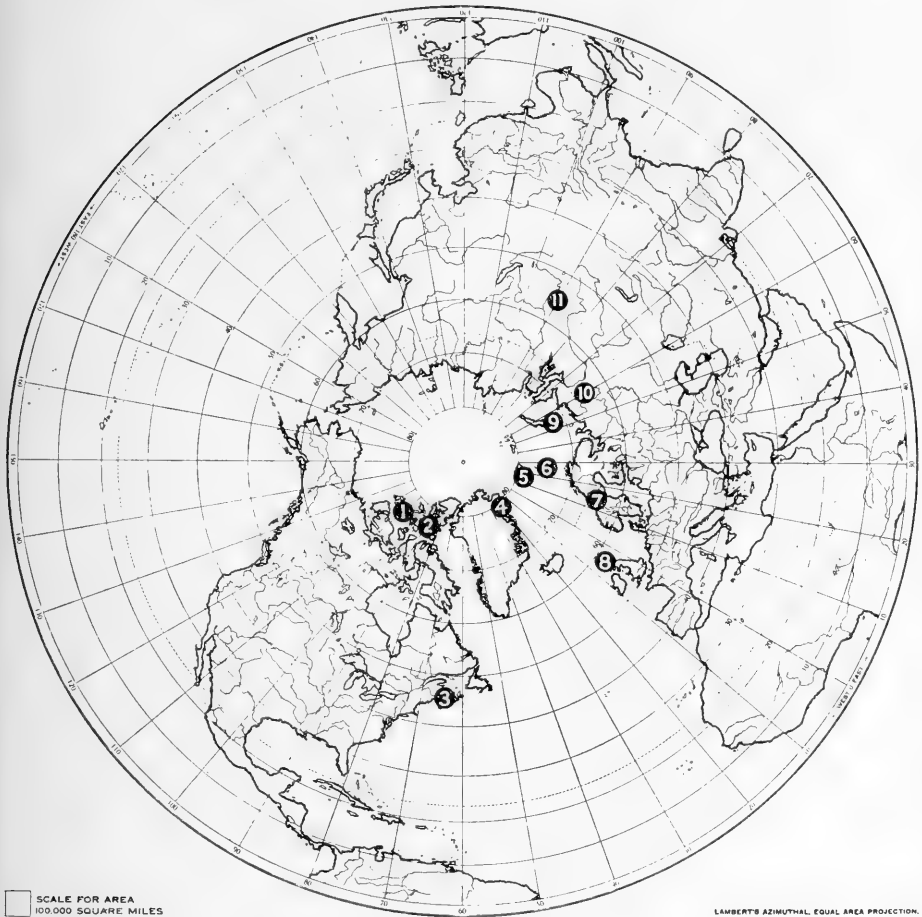

FIG. 1.—Location of Devonian and Lower Carboniferous northern floras.

1. Melville Island. Devonian
2. Ellesmere Land. Devonian
3. New Brunswick, Maine, etc. Devonian
4. Northeast Greenland. Lower Carboniferous
5. Spitzbergen; Devonian and Lower Carboniferous
6. Bear Island. Devonian and Lower Carboniferous
7. West Norway. Devonian
8. Rhynie, etc. Scotland. Devonian
9. Nova Zembla. Lower Carboniferous
10. Northern Urals. Lower Carboniferous
11. Siberia. Devonian.

matopteris from New York and Cladoxylon and Aneurophyton from Germany, that may possibly indicate more genial climates in those places than obtained farther north, and Pseudobornia seems to be a northern type, but until Devonian floras become much better known no adequate conclusions can be reached.

There are one or two points that deserve emphasis in this connection. These northern Devonian floras all consist of plants belonging to the Pteridophyte, Arthrophyte, Psilophyte, Lepidophyte and Pteridosperm phyla, and such existing representatives of these phyla as have survived to the present, though few and not directly filiated, such as Equisetum and Lycopodium, are singularly unaffected by temperature. For example, there are now two species of Equisetum and one of Lycopodium found within 10 degrees of the pole in northwestern Greenland (Ostenfeld, 1925). To be sure these modern Greenland forms do not reach the size of their Devonian relatives, but this is true of all existing members of these genera irrespective of latitude.

Moreover, all of these northern Devonian plants appear to have been bog types. This conclusion is indicated by their forming coal in place and by the structures disclosed in the silicified peats of Rhynie. Therefore, we conclude that the chief climatic factor was moisture rather than temperature. The fact that many of the Devonian plants were palustrine also gives force to an observation which I have elaborated in another place¹ that these Devonian plants while ancient and simple were not primitive and ancestral, but were the reduced descendants of more highly organized ancestors. Since speculation was to have no part in this discussion I refrain from elaborating my own belief regarding the more precise character of Devonian climate.

LOWER CARBONIFEROUS

(DINANTIAN OR CULM)

Fossil plants have been found in the Lower Carboniferous, or Mississippian as Americans prefer to call it, at five or six localities within or near the Arctic Circle. These floras range in extent from a few doubtful specimens at some localities to the 59 nominal species described by Nathorst from Spitzbergen. The latter extend to 79° North Latitude, and a considerable flora of similar species to the number of ten at least is found between 80° and 81° North Latitude in northeast Greenland.

¹ Berry, Edward W., Devonian Floras. Amer. Journ. Sci., Vol. 14, pp. 109-120, 1927.

The Spitzbergen flora comprises 12 fernlike plants, 5 pteridosperms, 1 arthrophyte, 25 lepidophytes, 1 cordaites (wood), and 15 of uncertain botanical affinities. Stigmarias and various roots occur in place beneath the coal seams, showing that the vegetation was preserved essentially in place; and *Lepidodendron* stems have been collected up to 16 inches in diameter. There are no peculiar Arctic types in this most extensive known Culm flora nor are there any genera that are not common to floras of the same age from lower latitudes. The single wood, *Dadoxylon spetsbergense* Gothan, fails to disclose any seasonal growth changes, which might be expected to result from the Arctic night. No other traces of the Cordaitales other than this wood have been discovered here, which leads Nathorst to suggest that the wood may have been carried by currents from some more southern clime, where also the woods fail to show growth rings. This may be true, but on the other hand there is great specific variation in the degree to which growth rings develop in existing conifers, as Antevs has pointed out, and they tend to be absent under fairly uniform conditions of humidity. That this is an individual trait of this particular species and is probably without climatic significance is shown by the presence or absence of rings in Devonian and Mississippian *Dadoxylon* woods from lower latitudes. For example, *Dadoxylon beinertianum* Endlicher from Silesia, *Dadoxylon Tchichatcheffianum* Endlicher from Russia, and *Dadoxylon vogesiacum* Unger from the Vosges, all of the same age as the Spitzbergen species, show distinct seasonal rings, but other contemporaneous European species fail to show them.

I cannot see any very conclusive indications of climate in these Lower Carboniferous floras, other than the fact that they extended in places to within 10 degrees of the pole. Palustrine types predominate as in the case of the Devonian, and more than half the known forms are Lepidophytes which we have reason to believe show little response to temperature. Sphenophyllums are entirely wanting in Spitzbergen, but are found farther north in Greenland and occur on Bear Island, so that their absence in Spitzbergen is merely an accident of preservation or discovery. In general Arthrophytes are much rarer in the far north than in middle latitudes at this time and the same seems to be true of a number of genera of large fronded fern-like plants, which is taken to indicate differences due to latitude.

TRIASSIC

Triassic plants except in the latest or Rhaetic stage are scarcely, if at all known in the north polar region. There is a species of

Schizoneura recorded from the New Siberian Islands which may be Rhaetic and there are scattered Rhaetic plants in Greenland and Spitzbergen; and somewhat farther south in northwestern Norway (Andö) and southern Sweden.

The most extensive northern Rhaetic flora is that from Scoresby Sound, East Greenland, between 70° and 71° North Latitude. This comprises 51 named forms and several additional ones which are not named. Cycads and ferns predominate, and so far as we can judge at this lapse of time all belong to cosmopolitan Rhaetic types. Harris, who has given an excellent account of these plants concludes that they indicate a temperate climate, largely on the ground of the predominance of certain forms indicative of relatively pure stands and the absence of mixtures such as occur in recent tropical assemblages. He concludes also, from a study of the cuticles of many of the species, that moisture was plentiful. The wood of *Dadoxylon* in the Rhaetic of Spitzbergen has very feebly marked seasonal rings.

JURASSIC

Supposed Jurassic floras completely surround the pole and are extensively developed throughout Siberia, in Alaska, Greenland, Spitzbergen, Franz Josef Land, New Siberian Islands, and elsewhere. Formerly, many of these, as those in Siberia, were considered Middle Jurassic, but Nathorst is the authority for the statement that all of the more northern ones are post Oxfordian, and several, such as that of Spitzbergen, are on the border between the Jurassic and the Lower Cretaceous.

The Spitzbergen flora is the most extensive and, according to Nathorst, includes 2 horizons, one Portlandian and the other possibly as young as Neocomian. A combined list of these comprises 57 species, including 11 fern-like plants, 1 lepidophyte (*Lycopodites*), 1 arthropyte (*Equisetites*), 4 cycadophytes, 4 Ginkgoales, 23 conifers and 13 of uncertain affinities. Nine different types of coniferous woods have been described and all show pronounced seasonal growth rings. Most of the generic types have a very great geographical range, but several, such as *Phoenicopsis*, *Torellia* and *Drepanolepis*, appear to be distinctly northern, and the predominance of conifers suggests a cool temperate climate. They are found in sandstones associated with coal seams and freshwater mollusks (*Lioplax*, *Unio*) and evidently grew in the vicinity of their burial place.

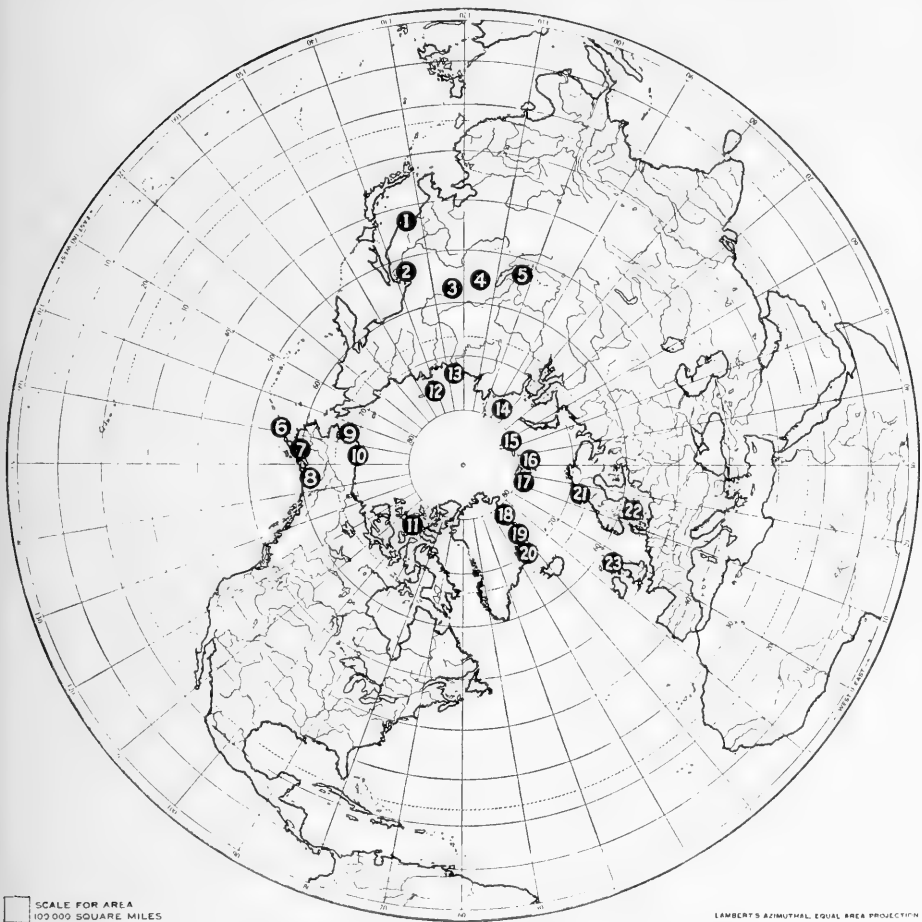

For class use in Geography, History, Civics, Economics, etc.—Prepared by J. Paul Goode. Published by The University of Chicago Press, Chicago, Ill.
Copyright 1920, by the University of Chicago

FIG. 2.—Location of Triassic and Jurassic northern floras.

- | | |
|--|--|
| 1. Manchuria. Triassic and Jurassic | 14. Solitude Island. Jurassic |
| 2. Ussuri. Jurassic | 15. Franz Josef Land. Jurassic |
| 3. Amur. Jurassic | 16. King Charles Land. Jurassic |
| 4. Trans Baikal. Jurassic | 17. Spitzbergen. Triassic and Jurassic |
| 5. Irkutsk, etc. Jurassic | 18. Northeast Greenland. Jurassic |
| 6-10. Alaska. Jurassic (?) | 19. East Greenland. Jurassic |
| 11. Bathurst Island. Jurassic | 20. Scoresby Sound. Triassic |
| 12. New Siberian Islands. Triassic (?)
and Jurassic | 21. Andö, Norway. Triassic |
| 13. Mouth of Lena. Jurassic | 22. Scania. Triassic and Jurassic |
| | 23. Scotland. Triassic and Jurassic. |

LOWER CRETACEOUS

Lower Cretaceous floras are found along the east coast of Asia, in Alaska, Greenland, and King Charles Land. From the last a number of coniferous woods have been described by Gothan. These show pronounced growth rings, said to be more prominent than in woods of the same age from central Europe. Nathorst records an incomplete trunk 32 inches in diameter and showing 210 seasonal rings. The most extensive Arctic flora of Lower Cretaceous age is that described by Heer from the Kome beds of western Greenland, but this, although generally considered to be of Barremian age, is subject to doubt as to age and content because collectors appear to have mixed several Cretaceous horizons. As it stands in the literature it comprises over 100 species, including 46 ferns (no less than 15 are referred to *Gleichenia*, and although these surely represent that genus they are artificially multiplied), 1 marsilea, 1 lycopod, 3 equisetums, 13 cycads, 20 conifers, 2 ginkgos, 5 monocotyledons, 3 or 4 dicotyledons, and 6 of uncertain identity. The abundance of ferns indicates a humid climate as does the presence of coal. This flora differs very little from those of corresponding age in lower latitudes (*e. g.*, the Kootenai of western Canada and Montana).

UPPER CRETACEOUS

Strictly Arctic Upper Cretaceous floras are limited to Alaska and Greenland but others of this age are found in northern Europe and eastern Asia. The most extensive is that from the two horizons in West Greenland known as the Atane and Patoot beds. These have in large part been described by Heer and there is a great and unwarranted multiplication of species. That from the Atane beds has 184 recorded species. It includes 31 ferns, 1 equisetum, 1 selaginella, 1 marsilea, 12 cycads, 2 ginkgos, 25 conifers, 4 monocotyledons, 94 dicotyledons and 14 of uncertain affinities.

The seemingly most incompatible plant is the authentically determined *Artocarpus* and this raises a question which cannot be decided without prejudice. If a genus which is tropical at the present time is found fossil associated with a preponderatingly temperate flora, which is to be given the most weight? The one or the many, bearing in mind the latitude where they occur? My own feeling is that the majority are less likely to have altered their environmental requirements than the minority, but this falls short of actual proof.

The Patoot flora includes 19 ferns, 1 equisetum, 19 conifers, 2 monocotyledons, 80 dicotyledons, and 2 uncertain.

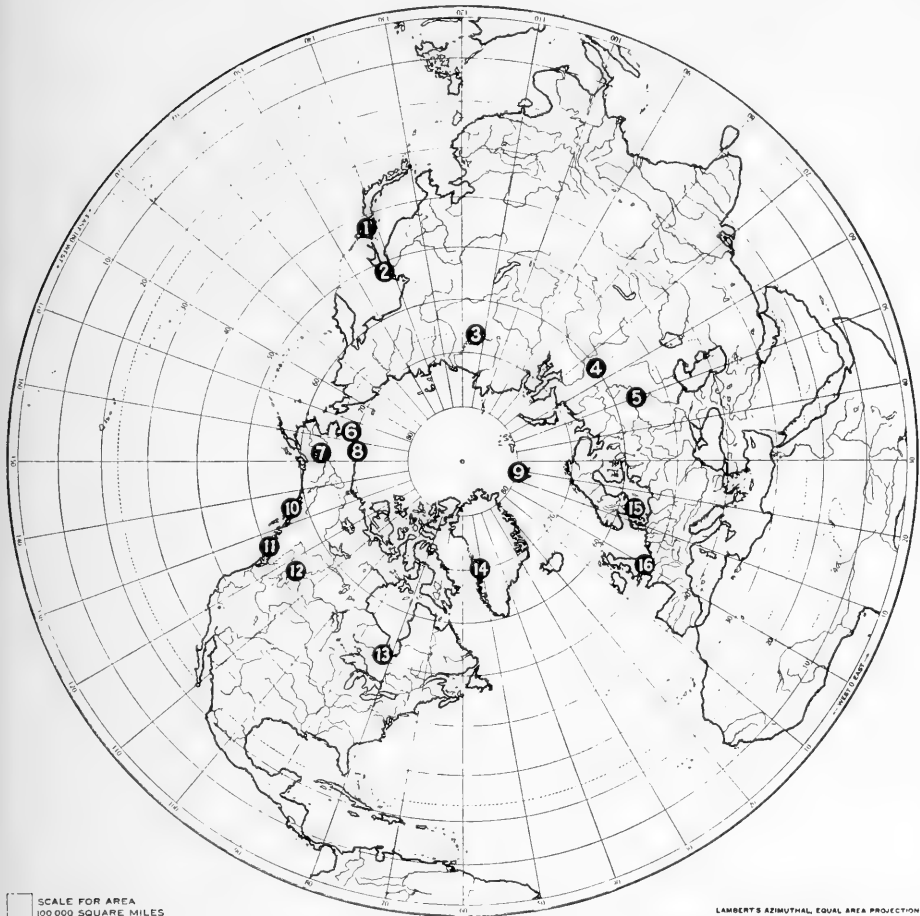

For class use in Geography, History, Civics, Economics, etc. Prepared by J. Paul Goode. Published by The University of Chicago Press, Chicago, Ill. Copyright 1920, by the University of Chicago.

FIG. 3.—Location of Cretaceous northern floras.

- | | |
|-----------------------------|--|
| 1. Japan | 11. Vancouver Island |
| 2. Sakhalin Island | 12. Kootenai |
| 3-4. Siberia | 13. Mattagami, Ontario |
| 5. Klin | 14. West Greenland (Kome, Atanc, Patoot) |
| 6-8. Alaska | 15. Scania |
| 9. Spitzbergen | 16. Wealden. |
| 10. Queen Charlotte Islands | |

TERTIARY

Tertiary plants from the Arctic have been encountered at very many localities, usually associated with coal. This, and plants with their roots in place as in the case of *Equisetum* in Spitzbergen; the association with fresh water mollusks, as in Greenland; or aquatic beetles, as in Spitzbergen and Iceland; as also the presence of fresh water diatoms in the matrix and the mixtures of branches and delicate foliage, prove conclusively that these Arctic floras and the associated coals cannot represent drift material from lower latitudes as some have supposed.¹

The similarity in facies and their mode of occurrence, as well as the similar petrographic character of the intimately associated basalts suggest that all of these Tertiary Arctic floras are essentially similar in age, although it is clear that in Spitzbergen, Alaska and probably elsewhere, more than a single horizon is represented. Heer, the pioneer in this field, called them Miocene, just as Lesquereux called the Fort Union and Wilcox floras Miocene, but the Arctic Tertiary floras are certainly older than Miocene and younger than Ft. Union. This is indicated by the determination of the so-called Kenai flora of Alaska as of upper Eocene age, and if any one of them is proved to be upper Eocene none of the others can be older than middle Eocene or younger than Oligocene. Collateral evidence of their age is furnished by the age of the greatest extension of subtropical floras into the Temperate Zone, which is in upper Eocene (Jackson) to middle Oligocene (Vicksburg) time.

Plants or coal of Tertiary age are found at the numerous widely distributed localities shown on the accompanying sketch map (fig. 4). These completely encircle the pole and reach to within $8\frac{1}{2}^{\circ}$ of it (Grinnell Land). These will be treated at greater length than the older floras because in some cases they are more extensive and also because they consist very largely of species belonging to existing genera, and hence can be discussed more intelligently than the older floras.

It may be well at the start to dispose of an oft quoted assertion, as for instance "most of Heer's determinations were based upon leaves, which give no data for generic identification" (Gregory, *op. cit.*, p. 413). I would readily admit that much of Heer's material was fragmentary, that he was over sanguine in some of his determinations,

¹ Gregory makes much of this idea, which as we have seen is easily disproved.

Gregory, J. W., *Congres Géol. Intern. Compte rendu Xème Session Mexico*, 1906, p. 413, 1907.



For class use in Geography, History, Civics, Economics, etc. Prepared by J. Paul Goolsby. Published by The University of Chicago Press, Chicago, Ill.
Copyright 1920, by the University of Chicago

FIG. 4.—Location of Tertiary northern floras.

- | | |
|----------------------------|-----------------------------|
| 1. Commander Islands | 21. Prince Patrick Island |
| 2. Japan | 22. Melville Island |
| 3. Sakhalin Island | 23. Bathurst Island |
| 4-8. Eastern Siberia | 24. North Devon |
| 9-11. Northern Siberia | 25-26. Ellesmere Land |
| 12. Central Siberia | 27-28. West Greenland |
| 13. Vancouver Island | 29. New Siberian Islands |
| 14. British Columbia | 30. Nova Zembla |
| 15-18. Kenai | 31. Spitzbergen |
| 19. Mouth of the Mackenzie | 32. Iceland |
| 20. Banks Land | 33. North Ireland and Mull. |

and described a great many more species than he should have done. Some genera do not have a characteristic leaf form, but to make such a statement of genera such as *Liquidambar*, *Betula*, *Corylus*, *Ulmus*, *Platanus*, *Sassafras*, *Liriodendron*, *Acer*, *Potamogeton*, *Cornus*, and *Nymphæa*, to mention but a few of those recorded from the Arctic Tertiary, is the height of misunderstanding. Moreover, as I pointed out in 1922 (*op. cit.*, p. 4): "Plant fossils have this merit aside from any question of botanical identification, and this feature seems to have been lost sight of by numerous critics of paleobotanical practise: that the size and form of leaves, their texture, the arrangement and character of their stomata, and the seasonal changes in wood, afford criteria that are quite as valuable climatically even though the species or genus to which they belong remains undetermined." Furthermore, a great many of the generic determinations are corroborated by fruits and seeds, as for example, the genera *Vitis*, *Acer*, *Nyssa*, *Hicoria*, *Juglans*, *Liriodendron*, *Fraxinus*, etc.

As recorded in the literature the number of species varies from the single *Pinus* recorded from Bathurst Island, 5 species from Ellesmere Land, 6 species from Banks Land to 55 species from Iceland, 168 species from Spitzbergen, and 283 species from Greenland, the last being greatly overelaborated. I have shown¹ that Heer's 30 species of fossil plants from Grinnell Land (Lat. 81° 42') represent not more than half that number; and that *Viburnum*, *Alnus*, *Ulmus* and *Tilia* represent *Populus* and *Corylus*. As thus revised the Grinnell Flora contains nothing extraordinary unless it be the supposed *Nymphæa* rootstock and this may really belong to one of the plants represented by fragments of grasses or sedges.

I will consider only the four most extensive of these floras in any detail. These are Iceland, Spitzbergen, Greenland and Alaska.

The Icelandic flora is preserved in tuffs, along with fresh-water diatoms, *Unios*, *Potamogeton*; and the wood and branches appear to have been broken off and buried by showers of ashes. The woods show sharply marked seasonal rings; and conifers, willows, alders, birch, and hazel are prominent. The only plants certainly determined that might not justly be considered cool temperate are the following: *Platanus*, *Liriodendron*, *Acer*, *Juglans*, *Ginkgo*, *Fraxinus*, *Hicoria*. Representatives of all of these except *Ginkgo*, which is not a native, and *Liriodendron*, which reaches its northern limit in southern New England, are hardy in northern New England (*Platanus*) or eastern Canada (*Acer*, *Juglans*, *Hicoria*, *Fraxinus*) at the present time.

¹ Berry, Edward W., Proc. Amer. Phil. Soc., Vol. 61, pp. 8-9, 1922.

The Spitzbergen flora comes from two horizons and the two total 168 species and are not essentially different in facies. They are associated with coal seams and are clearly continental palustrine associations. There are 4 ferns, a Ginkgo, 27 conifers, 27 monocotyledons and 80 dicotyledons. Three woods described by Gothan show marked seasonal rings. The warmer elements are *Taxodium*, *Platanus*, *Juglans*, *Nymphæa*, *Magnolia* and *Nyssa*. Here also oaks, hazels, willows, poplars and conifers predominate. There is not a single tropical or subtropical type and not one justly considered warm temperate.

The Greenland Tertiary flora comprises 283 nominal species and includes 8 fungi, 1 moss, 1 lycopod, 1 equisetum, 19 ferns (all temperate types), 1 Ginkgo, 28 conifers, 21 monocotyledons and 202 dicotyledons. The petrified coniferous woods show well marked seasonal rings and the only genus that is seemingly out of place in the far north is *Taxodium*, whose abundance in all Arctic floras and in proved temperate floras of other regions and other horizons shows that it was not out of place here. The monocotyledons include mostly miscellaneous leaf fragments, not generically determinable, as well as two supposed palms (*Flabellaria*). It has frequently been pointed out by others as well as by myself that the nature of the last cannot be considered as proving the presence of palms. The dicotyledons are very much overelaborated. Probably 100 species is nearer the correct figure than the 202 which Heer differentiated.

In Greenland as in all known Tertiary Arctic floras the leaves of willows, poplars, birches, and hazels predominate, but there are many other genera whose identification cannot be disputed, such as *Liquidambar*, *Alnus*, *Fagus*, *Quercus*, *Ulmus*, *Platanus*, *Sassafras*, *Fraxinus*, *Cornus*, *Liriodendron*, *Acer*, etc. *Vitis* is represented by both leaves and seeds, and other genera also show fruits. The genera that appear to me to be highly questionable are the following: *Castanea*, *Juglans*, *Pterocarya*, *Benzoin*, *Laurus*, *Myrsine*, *Apeiobopsis*, *Pterospermites*, *Zizyphus*, *Colutea*, *Dalbergia*, *Diospyros*, *Sapindus*, and several others. I base this conclusion on the fossils and not on the probabilities of their presence. Some, such as *Zizyphus* and *Ficus* clearly do not represent those genera, in fact Heer's discussion shows his lack of conviction of the latter and he queried his determination.

Heer devoted considerable space to a discussion of the climatic significance of this as well as other Arctic floras and concluded that the Greenland plants indicated a mean annual temperature of 53.6° F., or a considerably lower figure than he estimated by the same methods for the supposed contemporaneous flora of Switzerland, thus clearly recognizing a climatic zonation.

The so-called Kenai flora of Alaska was originally described by Heer and additions to it have been published by Lesquereux and Knowlton. Hollick has been engaged in a revision of this and related floras from Alaska for a number of years, but his results are not yet published. That from the type locality as listed by Hollick in 1915¹ comprised but 40 named species and contains not a single tropical or subtropical type. Associated with the plants are thick coal seams and fresh water mollusca (*Unio*, *Anadon*, *Amicola*, *Melania*), as well as beetle elytra.

He states in a recent letter that localities in the southeastern coastal region of Alaska (Alexander Archipelago) have yielded a Tertiary flora that is distinctly indicative of warmer climatic conditions than those from farther north, including cycads, palms, and such dicotyledonous genera as *Anona*, *Dillenia*, etc., but he has not yet determined whether they are the same or different in age. In either case they support the conclusion that climatic zoning is indicated.

As listed by Knowlton² in 1919 the Kenai flora (so called) comprised about 120 species. The most abundant forms are willows, oaks, poplars, walnuts, beeches, birches, hazels, and alders—distinctly temperate, and cool rather than warm temperate types. Perhaps the most abundant plants individually, certainly the widest ranging geographically in northern latitudes (Holarctica), are the leaves of hazel bushes (*Corylus*). Of the 54 genera of Knowlton's list, the following nine are not present in the existing flora of North America: *Ginkgo*, *Glyptostrobus*, *Taxites*, *Hedera*, *Paliurus*, *Elaeodendron*, *Pterospermites*, *Trapa*, and *Zizyphus*.

It may seem that I am juggling the evidence in omitting these nine genera from further consideration, but let me point out that the three of these about which there seems to be no doubt regarding their identity, namely, *Ginkgo*, *Trapa*, and *Glyptostrobus*, are all temperate types in the existing flora. The remaining six genera are under more or less suspicion of quite a different order from any differences of opinion among paleobotanists regarding the identification of the hazels, birches, alders, etc., with which they are associated. Opinion might differ as to whether a particular species of the latter was a *Betula* or *Alnus*, an *Ulmus* or a *Carpinus*, or a *Planera*; or whether one or several species of *Corylus* should be recognized as distinct species; but opinion is unanimous that the choice is thus narrowed, whereas in the case of such things as *Taxites*—all any one knows is that it represents

¹ Hollick, A., U. S. Geol. Surv. Bull. 587, pp. 88-89, 1915.

² Knowlton, F. H., U. S. Geol. Surv. Bull. 696, pp. 786-789, 1919.

some Conifer. Why waste time trying to explain the climatic significance of *Paliurus*, a mostly extinct genus, when the particular fossil is probably not a *Paliurus*; or why concern oneself with an Arctic species of *Zizyphus* when the form in question is probably a *Ceanothus*? I ask, can any one prove that the form-genus *Pterospermites* is genetically related to the existing genus *Pterospermum*? or that *Elaeodendron* is a sound botanical identification? I think not!

On the other hand, the great mass of not only the Kenai but of all the Arctic Tertiary floras are the readily recognizable, normal units of a natural assemblage, which individually leave but slight room for differences of opinion regarding their identity. If fruits chance to be found in association with the leaves, they are such things as birch or alder cones, never the fruits of the "suspects" above mentioned.

Of the remaining genera listed in the Kenai flora, all but the following six are represented in the existing flora of Canada: *Æsculus*, *Diospyros*, *Ficus*, *Liquidambar*, *Sequoia*, and *Taxodium*. It may be said of these that the *Æsculus* may not be an *Æsculus*, but a *Hicoria*; that the two species that have been referred to *Ficus* do not belong in that genus; and that *Sequoia* is on the verge of extinction at the present time and its modern range bears little relation to its former range. The case of *Sequoia* is of especial interest in its bearing on my thesis. Formerly a Holarctic type, it survives today in a most restricted area particularly favored by humidity.

The remaining genera of the Kenai flora appear to be determined with reasonable certainty. Not only are 39 of these represented in the existing flora of Canada, but the following are still represented in the existing flora of Alaska, or adjacent areas in northwestern Canada, or as far north as Labrador and Hudson Bay in eastern Canada: *Abies*, *Acer*, *Alnus*, *Alnites*, *Andromeda*, *Betula*, *Carex*, *Corylus*, *Equisetum*, *Fraxinus*, *Myrica*, *Osmunda*, *Phragmites* (grass), *Picea*, *Pinus*, *Populus*, *Prunus*, *Pteris*, *Quercus*, *Sagittaria*, *Salix*, *Spiraea*, *Thuites*, and *Vaccinium*.

Seventeen of the Kenai species are conifers, and the only types that would seemingly be out of place in a cool temperate climate with well-distributed moisture are *Liquidambar*, *Paliurus*, *Taxodium*, and *Zizyphus*. I have already given reasons for discrediting the determinations of some of these, and all of them have frequently been found fossil in temperate assemblages.

The significant feature about these Eocene Arctic floras is that they show a comparable northward swing of not alone their northern limits, but also of their southern limits, which in turn is comparable to the northward advance of the Jackson flora that I have considered

to be of the same age. The Jackson flora reaches Latitude 37° North. The most similar existing flora to that of the Jackson does not extend above Latitude 26° North, and then only under especially favorable conditions of situation with respect to warm ocean currents. This is a difference of 11 degrees. The flora of the Jackson was, moreover, a coastal flora, and I have not the slightest doubt but that had the Mississippi embayment extended five degrees farther North, its shores would have been clothed with the same Jackson flora, for at that time similar floras are found in the Paris Basin in Latitude 49° North, in southern England in Latitude 51° North, and along the expanded Mediterranean sea of the Old World.

The southern limit of the contemporaneous "Arctic flora" is about Latitude 45° North in North America (British Columbia), and about 57° North in Europe (Isle of Mull). It seems to me that the essential concordance of these facts is significant, and whatever may be thought of them, it would certainly seem to be difficult for any one to claim that these various Eocene floras mentioned do not show a climatic change in passing northward from the equator toward the pole. Moreover, at present—a time of, in many ways, an abnormal climate in a geologic sense; with rather sharp zoning, although not nearly so sharp as the textbooks would have us believe; a time of almost, if not quite, unprecedented land expansion in the Northern Hemisphere, which I believe expresses a casual relationship—the reliable members of these Eocene Arctic floras range much farther southward than they did in late Eocene time.

EXISTING ARCTIC FLORAS

Greenland is the most illuminating of Arctic Lands because it is much the largest, and therefore more likely to preserve endemic species, and to receive immigrants from other Holarctic lands. Although mostly covered by ice which rises to an altitude of more than 8,000 feet in the interior, it has island peaks (nunataks) with recent plants. Moreover the northeastern part appears never to have been glaciated.

About 400 species of recent vascular plants have been recorded from Greenland and at the south trees may reach heights of 10 or 12 feet. North of the Arctic Circle the number of plants is fewer, but Ostenfeld (1925) records 125 species north of Latitude 76° and 108 between Latitudes 78° and 80° , including 2 equisetums, a lycopod, 3 ferns, 32 monocotys and 70 dicotys, including *Salix* and *Vaccinium*.

In an earlier paper (Ostenfeld, 1923) this author describes the flora of the north coast and records 70 species of plants from Latitude 82° .

This brief statement will be sufficient to indicate that there are other and more important factors than cold. The almost entire absence of vascular plants (a single species as I recall it) from Antarctica shows the part geography plays in the problem. The absence of trees in Lapland (Kihlman) shows the part taken by cold desiccating winds. The northern limits of many tree species in coastal Alaska and Norway will indicate the ameliorating climatic effects of warm ocean currents and humidity.

EXISTING ARCTIC CLIMATES

This is a complex subject which cannot be discussed in this connection beyond pointing out certain observed facts which support the thesis of the present discussion. These are the slower heating and cooling of water bodies as compared with land areas, with their respective influence on air temperatures and pressures, their influence on the amount of water vapor in the air and the resulting effect of humidity on equability.

The climatic influence of the northward drift of oceanic waters may be illustrated by the course of the present day isotherms over the north Atlantic, a somewhat hackneyed illustration but nevertheless the most striking. I am showing a few of the isotherms for January and July in figures 5 and 6. Those for January which show the full effect of the rapid radiation and quick cooling of the land, contrast most markedly with the slow radiation and cooling of the ocean. At this time the zero isotherm reaches Latitude 35° in Asia and about Latitude 74° north of Norway, a difference of 39° . Much the coldest place is in northern Siberia which is 10° to 20° colder than at the pole itself.

The -30° isotherm reaches almost to the pole north of the Atlantic and swings to approximately Latitude 55° in Siberia—a difference of about 35° of latitude. The midsummer isotherms naturally smooth out these curves somewhat but even at this season the isotherm of 5° swings from about 62° in southern Greenland to 80° just west of Spitzbergen and the oceanic effect is clear as far eastward as Nova Zembla.

A few figures quoted from Sir John Murray's calculations will serve to emphasize the relations referred to. The energy radiated by the lowering of the temperature of a cubic meter of water 1° is sufficient to raise the temperature of more than 3,000 cubic meters of air 1° , and a second calculation shows that the heat released by lowering by 1° a stratum of water 200 meters deep and of 700,000 square kilometers area would suffice to raise the temperature of a stratum

of air 4,000 meters deep over the whole of Europe on an average of 10° .

I have not attempted to evaluate the effects of the present ice cap on Greenland or of the present altitude of the land surface, as all

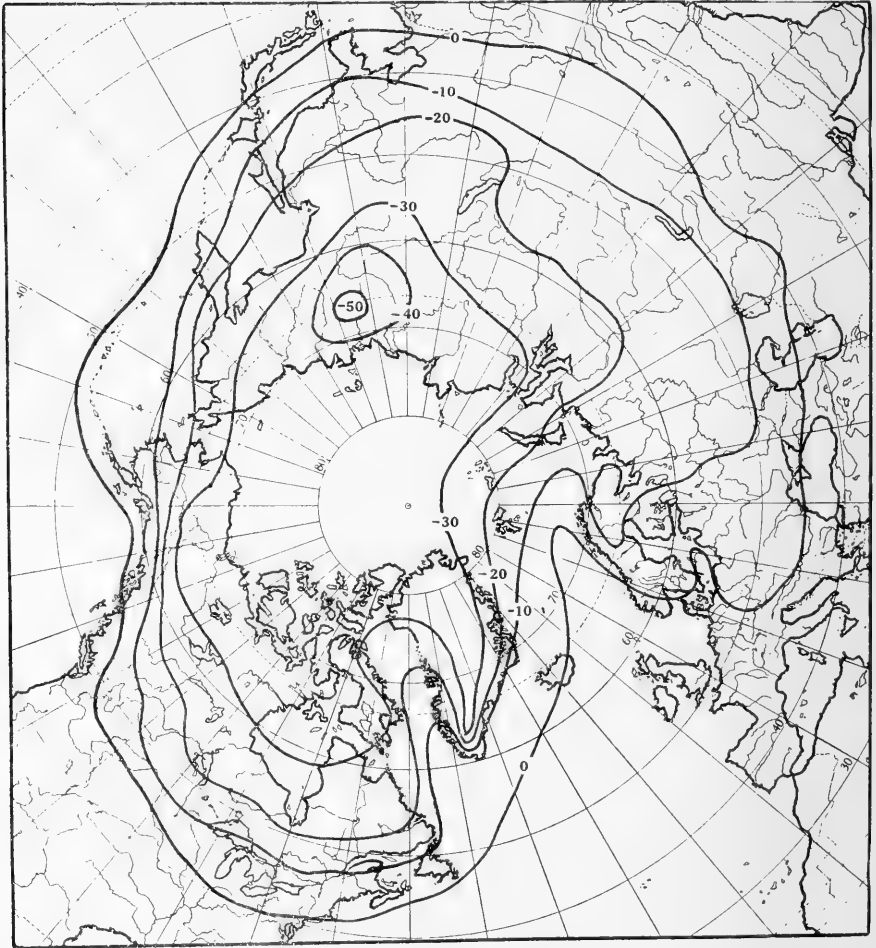

FIG. 5.—Midwinter isotherms at the present time.

I wish to do in this brief discussion is to emphasize in a graphic way the major thermal effect of land and water.

The Arctic is an oceanic basin and shows a remarkable climatic contrast with the elevated glacier-covered Antarctic continent. A few of the probable climatic effects which would follow if the Arctic re-

ceived ocean waters from the Pacific or across Eurasia from ancient Tethys, or became ice free during the summer are discussed very briefly in a subsequent section of this paper.

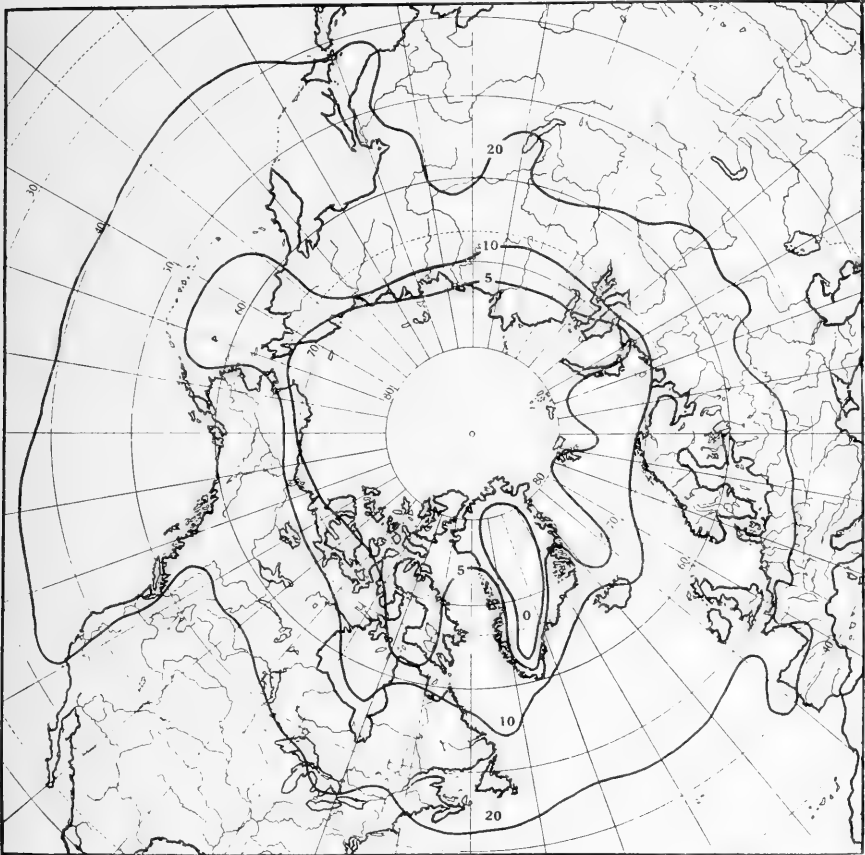

FIG. 6.—Midsummer isotherms at the present time.

SOME PALEOBOTANICAL MISCONCEPTIONS

Although I have on previous occasions emphasized the lack of climatic value of most of the plant types which paleobotanists have relied upon as indicating tropical climates, this subject should not be passed over without some comment in the present connection.

The principal evidence upon which tropical climates have been predicated falls into three somewhat dissimilar categories. First it rests upon tradition which never had any basis. For example the concep-

tion that the flora of the Carboniferous grew in a supertropical climate with a humid atmosphere charged with carbon dioxide, of which Köppen and Wegener make such specious use, had as its original basis the 18th century idea that the strange plants associated with the coal had been swept to Europe from the tropics by Noah's flood and the further fact that the habit and venation of certain fern-like Carboniferous plants, now referred with strong probability to the Pteridosperms, resembled certain existing tropical ferns.

European students accustomed to the modern accumulations of peat in high latitudes concluded quite as illogically that peat could not accumulate in the present equatorial region because of the rapid oxidation there, so added carbon dioxide to make growth extraordinarily rapid and great moisture to prevent rapid oxidation. The carbon dioxide stimulation would also conveniently account for the enormous size of some of the calamites and lepidodendrons as compared with their diminutive survivors the equisetums and clubmosses.

Then Koorders and Potonié described a peat bog from Sumatra and others have been subsequently described from other tropical lands, and there has been much readjustment of views, which might have been accomplished much earlier if the experts on geological climates had ever visited the tropics or even consulted the report on the peat deposits of Florida published by the Geological Survey of that state.

There is not space at my disposal to follow the vagaries of opinion, but it may be stated in the most positive way that *temperature* or the position of any region with respect to the equator,¹ that is between hot or cold climate, is not a factor in the formation of either peat or coal. Second the tropical idea relies on representatives of long lived, vigorous groups with very many species, which either in the past or in the present have become adapted to a variety of habitats, as is usually the case in large vigorous groups of all kinds of organisms.

As outstanding examples I may cite just a few types such as the palms, and figs, or such genera as *Cinnamomum* and *Zizyphus*. The great bulk of the existing palms are tropical and they are one of the first types of plants visualized when we think of tropical climates, whether we picture the Arab and his date palms or the South Sea Islander and his cocoanut palms. Nevertheless certain palms extend to approximately 39° South in Chile, 44° South in New Zealand, 34° North in California, 35° North in North Carolina and 36° North in Japan, and commonly are hardy several degrees north of their natural limits, as in the Sacramento valley in California, or in southern

¹ Not considering the subtropical arid belts of high pressures.

France. The greater limits of cultivated forms is usually not a result of cultivation so much as it is of selecting the species that will grow in a particular environment. In nature the proper species is subject to the historical factor of there having been ancestors in the region or in a region offering access to the particular region. For example our native Californian palm (*Neowashingtonia*) is a plant of sandy alkaline soils whose range seems to be conditioned by the geologically late submergence of the Colorado Desert area, and to bear no relationship to latitude. In the present tropics certain palms range upward to nearly 10,000 feet, as in the wet parts of the northern Andes (*Ceroxylon*, *Geonoma*, etc.).

The genus *Ficus*, to which the cultivated fig belongs, is one with upwards of 600 existing species of a great variety of habitats, and with probably as many fossil species, extending back to the dawn of the Upper Cretaceous. Various members range well into the temperate zone, both geographical and altitudinal. The cultivated fig generally ripens its fruits in Baltimore. I have seen it in the temperate altitudinal zone in Bolivia, and Weberbauer¹ records an altitudinal range for it through 8,255 feet in Peru.

Cinnamomum is the genus to certain members of which the names cinnamon and camphor trees are applied. The genus is large and ranges from the Upper Cretaceous to the present. Although the majority of existing species are confined to the tropics some extend for considerable distances into the Temperate Zone, in fact the commercial supply of camphor comes in large part from Formosa and Japan, and the tree is hardy in the southern parts of the latter country. Introduced into Florida it has been widely seeded by birds and is perfectly hardy throughout that state.

Zizyphus is a large genus also going back to the Upper Cretaceous, whose present center of population is southern Asia and the Sunda Islands. The new world species are practically confined to the tropics, but in the old world there are distinctly temperate species in southern Europe and eastern Asia. It has run wild in Louisiana, and characteristic fruits occur in the Pleistocene of the Atlantic coastal plain as far north as Long Branch, New Jersey. Obviously as a fossil *Zizyphus* entirely lacks a tropical significance.

A third source of error is the common assumption that because a particular type of plant has its home in the equatorial zone it is necessarily a tropical plant. The type most frequently alluded to in fossil Arctic floras as indicative of a once tropical climate is the tree ferns, the term embracing a variety of species in several genera.

¹ Weberbauer, A., *Archiv. Asoc. Peruiana Progreso Ciencia*, tomo 2, p. 60, 1922.

As a matter of fact tree ferns reach their maximum development in temperate rain forests, as in New Zealand (Lat. 40° S.), or in similar situations in tropical uplands, as was pointed out by Alexander von Humboldt over 100 years ago. They reach their greatest profusion in South America in the temperate part of the montaña zone of the eastern Andes. They grow luxuriantly on the mountains of central Africa at altitudes where they are buried in snow for part of each year, and as fossils their climatic significance is wet temperate and not tropical.

There are a great many other genera or species in the same category. I have seen *Anonas* and *Ingas* (cultivated) at 10,000 feet in the Andes perfectly hardy, and a large number of generic types that are commonly thought of as lowland tropical above the tropical altitudinal zone—such things as *Dodonaea viscosa*, *Sapindus saponaria* and *Swietenia mahagoni*. In fact it was my own observations in the Andes that first turned me from the paleobotanic tropical tradition.

Another misinterpreted type is the *Gleichenia* type of ferns (now segregated in several genera) very common in the Cretaceous floras of Greenland, but largely absent from the northern hemisphere in recent floras. Although commonly confined to low latitudes at the present time, it is by no means confined to the tropical altitudinal zone; in fact, where I have seen it (Yungus of Bolivia) it is prominent above the tropical zone, as it is also in Hawaii, Peru, Ecuador, Asia, etc. Representatives reach 54° South in Chile and 40° South in New Zealand.

All this is related in any account of fern distribution (*e. g.*, Die natürlichen Pflanzenfamilien, 1902), and still *Gleichenias*, along with palms, cycads, and tree ferns always appear in the paleobotanists tropical repertoire.

I suppose that constant reiteration of facts like the foregoing will have to be continued over many years before the news reaches those who write on paleoclimatology, and at least another generation will elapse before writers of geological text books cease to talk about the tropical climate of Tertiary Greenland.

Juniperus communis Linné is found as far north as the North Cape, which is at least 20° farther north than any other member of the family Cupressinaceae is found in the Eastern Hemisphere (Nathorst, 1911). Sassafras, of the mostly tropical family Lauraceae, extends northward to southern Maine, or about 13° beyond the bulk of the family. Diospyros, of the mostly tropical family Ebenaceae, extends northward to southern Connecticut, or about 12° beyond the bulk of the family.

Nor must it be lost sight of that at those times in the past when certain groups were varied and abundant, as were the seed ferns in the Paleozoic or the cycads in the Mesozoic, they were quite likely to have shown the features of dominant organisms, both plant and animal, and to have occupied more environmental niches than the depleted survivors of the cycad phylum do at the present time.

In Newfoundland and western Labrador the larch (*Larix americana*), the balsam poplar (*Populus balsamifera*), the paper birch (*Betula papyrifera*), and the balsam (*Abies balsamea*) fail to reach the Straits of Belle Isle (52°) whereas they all extend far above Latitude 60° in Alaska and the first crosses the Arctic Circle. Podocarpus just fails to reach the Tropic of Cancer in Cuba. A Chilean species reaches 42° South Latitude in Chile. The northern limit of forests crosses the Arctic Circle in Alaska and reaches 70° North Latitude in Norway, the latter 20° north of the tree line on the Atlantic coast of North America.

EXPLANATION OF PAST ARCTIC CLIMATES

It is perhaps fatuous to point out that climate, either present or past, depends upon a variety of factors, both cosmic and terrestrial. Of the former the only one that is of practical importance is solar—that is, radiant energy from the sun, since it is inconceivable that other heavenly bodies or the introduction of kinetic energy by meteorites exert any appreciable effect.

The amount of solar energy reaching the earth depends upon the sun's activity, which is variable; on the distance of the earth from the sun, which is also variable; and more practically in so far as terrestrial climates are concerned, on the condition of the earth's atmosphere, especially with respect to the amount of ozone, water vapor, carbon dioxide, and dust present, all of which again are variable. The latitude, determining the angle of incidence of the sun's rays, is an obvious factor, as is also the geographic pattern and the topography, including altitude under the latter. The geography determines whether the sun's energy falls on the land or the water, it determines the temperature gradient between the equator and the poles and the consequent force of the planetary winds and ocean currents, and in less obvious ways is of the greatest significance, as the following illustration will make clear.

The North and South Equatorial currents in the Atlantic are so situated that the South Equatorial, the stronger and the larger of the two, is divided by Cape San Roque into a larger, northern or Guiana current; and a smaller, southern or Brazil current. Some authors,

c. g., Guppy, are inclined to consider the South Equatorial as bipartite throughout, calling the Guiana current the Main Equatorial current. The point is immaterial in the present connection since all I desire to show is that the shape of eastern South America and the latitude of Cape San Roque are purely fortuitous in so far as their relation to climate is concerned, and yet if the latter had happened to lie a few degrees north of its present position much of the water that ultimately contributes to the Gulf Stream would have turned southward to augment the Brazilian current, and the climate, especially of Europe and the Arctic, would be profoundly modified. It has been estimated that if Cape San Roque were 2° north of its present position there would be a shift of 40% of the Equatorial current which would be deflected southward instead of northward. The same results would be attained if the southern trades were not stronger and more constant than the northern trades, because of the relative amounts of land and water in the northern and southern hemispheres.

Scant attention will be devoted to the various theories that have been advanced to explain geological climates. These range from that of Croll, in its original or modified form, based upon the eccentricity of the earth's orbit and the obliquity of the ecliptic, which was doubtless a factor at all times, but hardly a controlling one; through those theories that rely on changes in the atmosphere, such as alterations in the amount of carbon dioxide (Tyndall, Arrhenius, Chamberlin)¹ amounts of volcanic dust (Humphreys), to the extreme form of the hypothesis advanced by Manson, and elaborately defended by Knowlton, that a combination of cloudiness progressively diminishing during earth history, and a terrestrial control due to a cooling earth, instead of a solar control as at present, are the primary factors which explain past climates. Finally there are those highly speculative hypotheses such as Chamberlin's reversal of the oceanic circulation, and a group which predicate a wandering of the poles in various ways, now fashionable in the revived form put forward by Wegener.

I have quite possibly omitted other proposals that might be mentioned, and I have now to mention the theory, if it can be called a theory, which is the main thesis of the present paper, namely: that it seems to me possible to interpret geological climates in the light of demonstrated changes in topography and geography, including under the latter differences in the distribution of land and water and the transfer of energy by currents.

¹ It is of interest to note that Neumayr in 1883 pointed out that excesses of CO_2 would be impossible since the absorption by the oceans would maintain an almost perfect balance.

This idea, as applied to the Pleistocene glaciation, was first advanced, I believe, by Lyell, and in its more general application has been recently put upon a scientific basis by Brooks, with whom I am in perfect agreement to the extent of the evaluation of these as major factors, but also in my firm conviction that arm chair philosophy with its fondness for highly speculative and catastrophic hypotheses, has no place in a uniformitarian world or in 20th century science, but belongs in the medieval age of human thought.

Climate, in a uniformitarian geology, occupies a somewhat anomalous position, which the scientific world has been slow to recognize, namely, that the history of the human race has been run under climatic conditions which, from the point of view of earth history, are exceptional. Man was evolved subsequent to the relative elevation and the great extension of the continents which ushered in the Pleistocene glaciation, and therefore what is normal in human experience, is abnormal for the bulk of geological climate.

While, therefore, we recognize that the climatic factors and the meteorological elements are the same now as always, their combination to form actual climates has depended upon a great many factors, among the chief of which was the size, shape, position, and relative elevation of the land masses. It may be remarked parenthetically that numerous theories of the causes of, or descriptions of geological climates have been advanced by students ignorant of meteorology, and also usually ignorant of the relationship of organisms to their environments, and the last is strikingly true of Köppen & Wegener's recent *Die Klimate der geologischen Vorzeit* (1924).

In attempting, a few years ago, to explain the extension of floras nearly to the poles during the late Eocene, I relied chiefly on the submergence of continental areas in the middle Eocene and the resulting free oceanic connections at that time between equatorial and Arctic waters, pointing out that these Arctic floras were coastal floras and therefore under the régime of an oceanic climate.¹ Essentially the same explanation was put forward independently in connection with Jurassic climates a few months later by Kerner von Marilaun.² An additional and important factor has since been brought forward by Brooks,³ who points out that the temperate gradient is a simple function, whereas the influence of the ice increases as the square of the

¹ Berry, Edward W., A possible explanation of upper Eocene climates. *Proc. Amer. Phil. Soc.*, Vol. 61, pp. 1-14, 1922.

² Kerner von Marilaun, F., *Sitz. k. Akad. Wiss. Wien*, 1922.

³ Brooks, C. E. P., The problem of mild polar climates. *Quart. Journ. Roy. Meteor. Soc.*, Vol. 51, pp. 83-94, 1925.

radius. Hence a coincidence of minor factors sufficient to effect an overturn in the one or the other direction, that is, toward ice formation or melting, would suffice to induce a wide extension of polar ice, or to prevent the polar regions from maintaining a permanent ice cap. If this is true then it seems quite probable that there was little polar ice during those times already enumerated when temperate floras invaded the polar regions. This would mean profound changes in the distribution of barometric pressures and consequent wind circulation, and in fact, in all of the elements which constitute climate. It would mean that in western Greenland, for example, where the most extensive late Eocene Arctic flora has been found, the present day glacial anti-cyclonic winds would be replaced by westerly or south-westerly winds blowing from the relatively warmed waters of Baffins Bay, and this would satisfactorily explain the details of the floral facies. This does not mean that there would be tropical climates in the Arctic or that the region would not be ice bound in the winter season. The protective effect of snow, and cold sufficient to cause a cessation of plant activity during the Arctic night are a physiological necessity. Otherwise most vascular plants could not maintain themselves. They tend to die either if active in darkness or if exposed to desiccation by air and wind when the ground water is frozen.

Regarding the general history of discussions of geologic climates I believe that most paleontologists who have written on this topic, especially those dealing with the pre Cenozoic periods, have had little basis in fact for their speculations. They seem to me to be utterly oblivious to the great amount of modern work on the distribution of marine organisms; and their ideas of the climatic significance of a trilobite, eurypterid, or ammonite is purely a tradition inherited from the distant past when all strange organisms were associated with torrid climates.

In stating my belief in a greater uniformity of climate during the past than obtains at the present I do not wish to be understood as advocating such unsound beliefs as the entire absence of zonation, such as many paleobotanists have defended (Jeffrey, Knowlton), or a similar uniformity throughout all time. Both are equally disproved both by geological observations and meteorological principles. Jeffrey, for example (*Anatomy of Woody Plants*, Chapter XXX, 1917), holds that the more ancient the epoch the warmer the climate, and that there has been a gradual and progressive refrigeration during geologic time; that the organization of secondary wood in extinct plants furnishes the most reliable evidence of climatic conditions; that toward the end of the Paleozoic, growth rings appeared in woods in high latitudes; that in the Triassic, growth rings were developed ten degrees

nearer the equator than had been the case during the Paleozoic; that in the Jurassic, the tracheids first developed tangential pitting which was at the end of the annual ring, and accompanied by storage elements (wood parenchyma).

None of the statements in the foregoing paragraph are facts of observation. There is no geological or paleontological evidence indicating a progressive climatic cooling during geologic time, and the Permo-Carboniferous glaciation was admittedly more extensive than that of the Pleistocene. The presence or absence of growth rings exhibits what might be called constitutional variations quite independent of climate, not that they really are independent, but two associated species under an identical climate will behave differently with respect to this feature of their anatomy. Growth rings appear in some Paleozoic woods many degrees nearer the equator than Jeffrey admits,¹ and in marine formations deposited off low coasts so that they cannot be considered to have been upland types. Several Lower Carboniferous examples have already been cited. The Paleozoic genus *Mesoxylon* shows tangential pitting, which, according to Jeffrey, first appeared in the Jurassic; and the citation of a wood from the Triassic of Arizona as an argument for the advance equatorward of cooler climates during the early Mesozoic is particularly disingenuous, as it is perfectly clear that the growth rings in this case have nothing to do with temperature, but are due to periodic lack of moisture in that region, as exemplified by the contemporaneous gypsum deposits.

Similarly in the recent elaborate work on geologic climates by Köppen & Wegener, already alluded to, these authors offer explanations to account for climates during the successive geologic periods, which climates have not been proved to have ever existed.

As I have pointed out on previous occasions, paleobotanists in general have entirely lacked objective experience outside the temperate zone, and have invariably overestimated temperatures. They have been prone to use the present distribution of the fancied or real relatives of their fossil forms as if temperature were the sole factor in the environment, and have stopped with the geographic occurrence, with the apparently simple trust that all lands in the equatorial zone were at sea level and wet tropical. A sojourn in the Arctic climate beneath the equator on the backbone of South America would do much to correct this misapprehension, as would also some experience in the temperate rain forests of different regions.

I had intended to indicate current conceptions of contemporaneous paleogeography on the maps showing the plant localities but have

¹ Several have been named in the preceding paragraph devoted to Mississippian Arctic plants and others could be added.

not done so although I did publish such a map for the Eocene in 1922. This intention was abandoned for the reason that it was not possible to compile maps that did not cover too much time nor in which the extrapolation was not so great as to destroy any real value.

Arlt has compiled maps which represent a synthesis of opinions and showing the areas of agreement and disagreement among specialists and to these the reader is referred. The debatable North Atlantic continent and the Gondwana continent would, if they ever existed, have had a profound effect on climate. Whether or not they were ever realities I am not prepared to say. I can, however, make the following statements with a considerable degree of certainty, namely: That there was a wide extent of land in the Northern Hemisphere from late Mississippian through the Permian. That the Arctic was landlocked in early and middle Triassic and that there was a wide transgression of the sea in the Neo Triassic. That the maximum Jurassic transgression was about Oxfordian; that of the Lower Cretaceous was in the Neocomian; that of the Upper Cretaceous was in the Emscherian; that the late middle Eocene was a time of wide sea transgression and low lying lands; and that during the Miocene, the age to which Heer assigned the Arctic Tertiary floras, the amount of land in the Northern Hemisphere was nearly as great as it is at the present time.

It will be seen that there is a correspondence between times of sea extension and Arctic floras and times of land extension and no traces of Arctic floras. This correspondence is not exact, and so little of paleogeography is objective, that I would not want to appraise it for more than it is worth, but in so far as it is known it does offer corroboration of my thesis.

I had expected to attempt an estimate of the meteorological conditions at the various times at which fossil floras are found in the Arctic, but after abandoning any hope of getting reliable paleogeographic data I have also abandoned the former. Brooks has published some interesting meteorological estimates using as a basis those parts of Arlt's maps where authorities agree, but it should be pointed out that majorities are quite as likely to be wrong in science as in politics, and if generalizations are valid (which of course they are not) then minorities are usually right.

There are, however, a few considerations that may be put forward as having a high degree of validity, namely the importance of ice as a third factor, added to the long recognized rotational (planetary) and geographic (distribution of land and water and altitude) factors in influencing the distribution of pressures and consequently of prevailing winds. And also the effect of the volume of fresh water car-

ried into the Arctic basin by rivers in the formation of ice and the effect of current-borne ice in maintaining subnormal density and consequently the identity of the present day cold currents as they move southward. Once they become of normal density they disappear below the surface and lose their climatic influence.

Another factor of considerable importance climatically, especially in connection with the theory of Brooks, is the amount of reflection from the earth's surface. I do not have the exact figures, but estimates given to me orally by W. J. Humphreys, are about 7 per cent from land or water and about 70 per cent, or ten times as much, from the surface of snow and ice. If there has been the wide fluctuations in polar ice as Brooks predicts, then reflection is a factor which can not be safely neglected.

At the present time in high latitudes the prevailing wind circulation is easterly with a southward moving component at the surface. If the ice cap were gone we would have westerly winds in high latitudes with a poleward component at the surface.

If Bering Strait was open and less shallow, a great volume of warm Pacific water would pour into the Arctic and greatly ameliorate the climate, as would also be the case if a Cretaceous seaway bisected North America, or a Devonian or Eocene seaway bisected Eurasia, such as are shown on current paleogeographic maps. If the best available sources are utilized in plotting Eocene seaways nearly all the Tertiary coal occurrences and floras in the Arctic range themselves along the easterly coasts of such seaways.

CONCLUSIONS

The major factor in the polar extent of temperate floras is not primarily the direct effect of temperature so much as it is the fact that above 32° F. water is a liquid and below 32° F. it is a solid. Asa Gray said "Plants are the thermometers of the ages." I have no doubt that terrestrial vegetation when properly interpreted is the safest guide to geological climates, but as thermometers they are pretty poor and we have no means of calibrating them.

There is no unequivocal botanical evidence of tropical or subtropical climates at any time in the Arctic. There is no evidence from paleobotany of a lack of climatic zonation at any geological period from which fossil plants are known, although at such times the evidence points to a relative mildness and a lack of sharp zonation, as compared with the present.

The distribution of the known fossil Arctic floras with respect to the present pole proves conclusively, as Seward pointed out in 1892 (p. 53), that there could have been no wandering pole.

SMITHSONIAN MISCELLANEOUS COLLECTIONS

VOLUME 82 NUMBER 7

THE ATMOSPHERE AND THE SUN

BY

H. HELM CLAYTON



(PUBLICATION 3062)

CITY OF WASHINGTON
PUBLISHED BY THE SMITHSONIAN INSTITUTION

JUNE 9, 1930

SMITHSONIAN MISCELLANEOUS COLLECTIONS

VOLUME 82, NUMBER 7

THE ATMOSPHERE AND THE SUN

BY

H. HELM CLAYTON



(PUBLICATION 3062)

CITY OF WASHINGTON
PUBLISHED BY THE SMITHSONIAN INSTITUTION

JUNE 9, 1930

The Lord Baltimore Press
BALTIMORE, MD., U. S. A.

THE ATMOSPHERE AND THE SUN

By H. HELM CLAYTON

CONTENTS

	PAGE
Introduction	1
I. Solar changes	1
II. Latitude effect of solar changes on the earth's atmosphere.....	4
III. Seasonal influences	14
IV. Atmospheric waves	18
V. Relation of the weather waves to solar changes.....	29
VI. Solar cycles and weather cycles.....	32
VII. The use of weather cycles in forecasting.....	44
Summary	48

INTRODUCTION

This paper is the fifth of a series giving the results of investigations of the relation of solar activity to atmospheric changes. The earlier ones were published as Smithsonian Miscellaneous Collections, Vol. 68, No. 3; Vol. 71, No. 3; Vol. 77, No. 6; and Vol. 78, No. 4. The author has been stimulated to continue these researches because he believes in their great importance. The interest of Dr. C. G. Abbot and the sympathy and aid of Mr. John A. Roebing have encouraged him in the task and enabled him to undertake much work that otherwise would not have been possible. Miss M. I. Robinson has aided in the calculations needed for the discussion.

I. SOLAR CHANGES

It has long been known that spots appear on the surface of the sun and that the number and size of these spots varies from day to day, from month to month, and from year to year. More recently it has been discovered by Dr. C. G. Abbot and his associates that the radiation coming from the sun varies; so that, in general, it is known that the sun is hotter when there are many spots on its surface than when there are few or none.

There is also evidence that the heat of the sun varies from day to day and from week to week in short cycles of change. The most convincing evidence of this fact is the comparison of measurements

of solar radiation made at observatories thousands of miles distant from each other, one in the northern hemisphere and the other in the southern hemisphere; so that the chance of both being affected by the same weather changes becomes very small. The solar radiation reaching the earth is measured in calories per square centimeter per minute, and averages about 1.940 calories. Table I shows a comparison of observations of solar radiation made simultaneously in northern Chile and in the United States (first in California and then in Arizona) during the years 1918 to 1924. The table shows the frequency of different values observed in the United States for each increase of .010 calorie in Chile.

TABLE I.—*Comparison of Solar Radiation Values in Chile and the United States (Number of Cases)*

Values in United States	Values observed in Chile					
	1.910-9	1.920-9	1.930-9	1.940-9	1.950-9	1.960-9
1.890-9.....	1	6	6	6	0	0
1.900-9.....	11	11	1	0	0	0
1.910-9.....	20	25	11	5	4	0
1.920-9.....	18	38	21	5	4	2
1.930-9.....	7	23	29	11	11	0
1.940-9.....	4	6	12	15	16	4
1.950-9.....	0	4	10	10	13	6
1.960-9.....	0	1	3	4	7	5
1.970-9.....	0	1	0	1	3	2

If there were no relation between the measurements at the two stations, the observed values would be scattered through the different classes at random. The tabulation shows that a random distribution does not exist; but for each group of observations in Chile, there is a maximum near the same values in the observations in the United States. There is, therefore, a progressive displacement of the maximum frequency as the solar values increase from 1.910-9 to 1.960-9, or nearly three per cent of the mean value. The probable error of the measurements is $\pm .006$ calorie; so that the solar variation during the interval covered by the observations was more than eight times the probable error of each group of observed values.

Since variability in solar radiation has been questioned by some investigators, it is well to state that the evidence of this variability rests on three fundamental and independent facts:

(1) The changes in radiation are alike when measured at two widely separated stations, allowing for variations from a middle value due to errors of observation.

(2) The changes both of short period and of long period in solar radiation are related to visible changes in the number and area of spots, faculae and flocculi seen on the sun.

(3) The changes in solar radiation are correlated with other phenomena such as certain changes in terrestrial magnetism, in radio-receptivity, and meteorological changes which are known by other evidence to be related to solar conditions.

The critics of solar variability have pointed out that the measured variations have decreased as the accuracy of the observations increased and that in the earlier observations the effects of water vapor

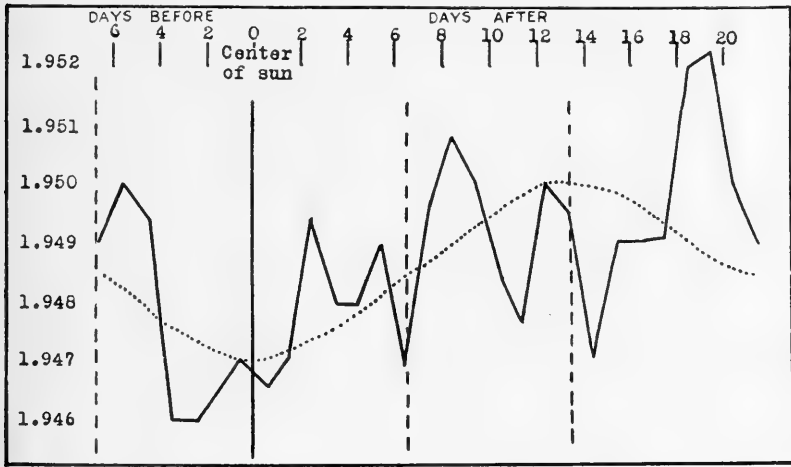

FIG. 1.—Calcium flocculi and solar radiation. The mean values of solar radiation received at the earth in calories per square centimeter per minute on days before and days after the passage of calcium flocculi across the central meridian of the sun. 1918-1920. Flocculi of 400 or more on the Ebro scale of values.

in the air, of dust, of ozone, and of turbidity were not entirely eliminated; but they have in no manner destroyed or impaired these fundamental evidences of variability.

Abbot and his associates¹ have given evidence of the relation of solar radiation changes to solar contrast and to groups of spots on the sun, Fowle² has shown a relation to groups of flocculi, and I³ have shown a relation to faculae. Bauer⁴ has shown a relation to certain changes in terrestrial magnetism, and Austin⁵ has found a

¹ Smithsonian Misc. Coll., Vol. 66, No. 5, 1916.

² *Idem*, Vol. 77, No. 5, 1925.

³ *Idem*, Vol. 77, No. 6, p. 53, 1925.

⁴ Terr. Mag., Vol. 20, pp. 143-158, Dec., 1915.

⁵ Smithsonian Misc. Coll., Vol. 80, No. 2, p. 13, 1927.

marked parallelism between radio-receptivity and changes in monthly values of solar radiation.

In order to study further the relation of clouds of calcium and hydrogen as seen in faculae and flocculi to solar radiation I took from the publication of the Ebro Observatory all days on which the area of observed clouds of flocculi exceeded 400 millionths on the Ebro scale. The day on which this area crossed the central meridian of the sun as seen from the earth was called zero day. Then, the solar radiation measured on that day and on each of the seven days preceding was averaged. The same was done for each of the following days up to 21 days later. The mean values for each day are shown plotted in figure 1. This plot shows that the radiation from the sun averaged lowest when the flocculi were near the center of the sun. This fact indicates changes of transparency in the sun's atmosphere and is interpreted to mean that the clouds of calcium and hydrogen in the flocculi cut off the radiation from the surface of the sun, just as water-vapor clouds cut off radiation from the surface of the earth beneath them. When near the limb of the sun, however, these clouds add to the total radiation.

II. LATITUDE EFFECT OF SOLAR CHANGES ON THE EARTH'S ATMOSPHERE

Studies of the relation of solar radiation changes to meteorological changes have been published in four preceding papers in this series. The results of recent researches and deductions drawn from the whole mass of data follow. Some readers may be inclined to think that the generalizations given are based on too small an amount of data, but in reality they are based on a large amount of data accumulated during 20 years of research. Where one example is given, many others might have been presented.

In the earlier papers of this series the first finding of importance was that there was a marked latitude effect of solar radiation changes on the pressure and temperature of the earth's atmosphere. Accompanying or immediately following short-period changes in radiation, there was an increase in temperature and a fall of pressure in equatorial regions, a rise of pressure and a fall of temperature between 40° and 60° latitude, while at latitudes above 70° the pressure fell and the temperature rose. These conditions hold true for both the northern and southern hemispheres. The chart illustrating this fact is reproduced in figure 2.

Figure 3 shows how, in the average of many cases, day to day changes of pressure at Honolulu are associated with simultaneous

changes of pressure at Nome and also with day to day changes in solar radiation. During the interval covered by the data from which

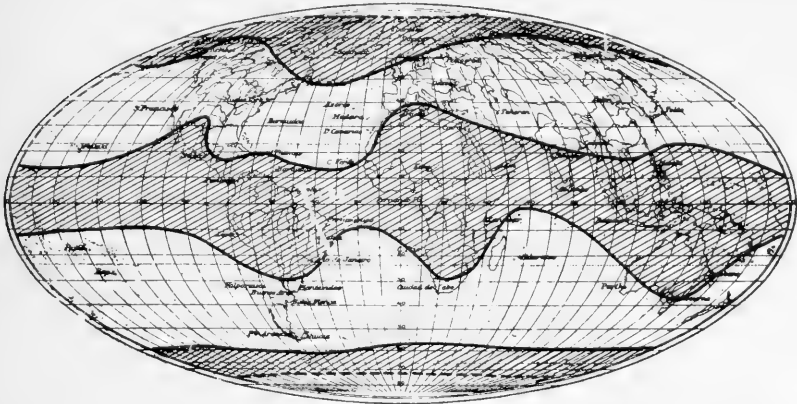

FIG. 2.—Zonal effect of increased solar activity. Shaded areas show regions where the pressure falls and the temperature rises with short period changes of solar radiation. Unshaded areas show regions where the reverse conditions occur.

these curves were constructed, January to April, 1928, the pressure at Nome followed the solar radiation changes directly, and the pressure at Honolulu followed inversely. The changes are nearly simul-

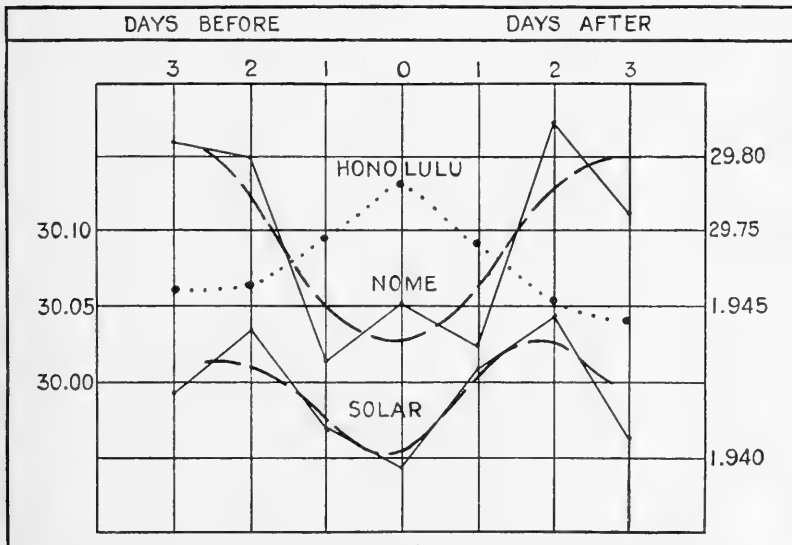

FIG. 3.—Maxima of pressure at Honolulu compared with pressure at Nome and with solar radiation.

taneous except that the solar minimum and maximum appear to occur slightly earlier.

A later investigation disclosed that there were also latitude differences in pressure correlated with changes in the monthly number of sun spots.¹ Using the data from about 200 stations, the average pressure when sun spots were near their maximum frequency was compared with the average pressure in the same latitudes when the sun spots were near a minimum of frequency and differences obtained. These differences are plotted in figure 4.

Figure 4, shows that when sun spots are more frequent in number, the pressure is lower in the equatorial region from about 30°N. to 30°S., while from about latitude 35° to 65° in both hemispheres, the pressure is higher when the sun spots are most numerous. This result is in good agreement with that found for short period changes

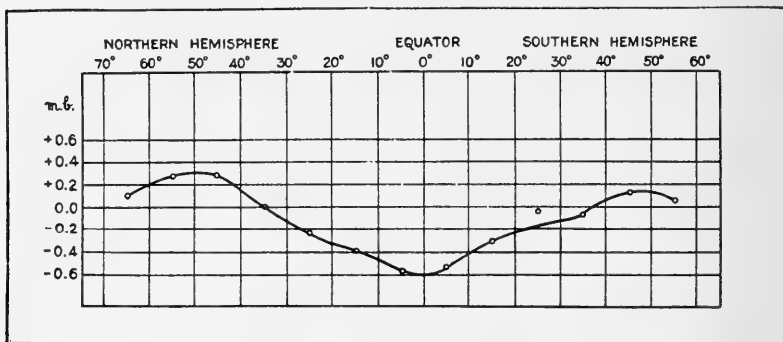

FIG. 4.—Mean difference of pressure at sun-spot maximum from that at sun-spot minimum.

of solar radiation and with the fact disclosed by the measurements of the Smithsonian Astrophysical Observatory that more radiation from the sun reaches the earth when sun spots are more frequent. A recent research by Ekhart² shows clearly the opposing oscillations of the pressure in high and in low latitudes. When the pressure falls in low latitudes, it rises in high latitudes and vice versa.

In order to investigate this relation further with the data which appeared in "World Weather Records,"³ 24 cases were selected in which solar activity was above normal as shown both by the Wolfer sun-spot numbers and by the Smithsonian values of solar radiation; and 24 cases where the opposite condition prevailed, namely, a small monthly sun-spot value and a low value of solar radiation. Where

¹ Clayton, H. H., *World Weather*, p. 262. New York, Macmillan & Co., 1923.

² Ekhart, E., "Untersuchungen der jährlichen Schwankungen der atmosphärischen Zirkulation," *Meteorologischen Zeitschrift*, Heft 2, February, 1930.

³ *Smithsonian Misc. Coll.*, Vol. 79, 1927.

no values of solar radiation were available, only sun-spot numbers were used and an equivalent value of solar radiation was derived from Abbot's¹ plots of equivalent values and placed in parentheses.

Since both sun-spot numbers and increased solar radiation are considered in forming this table, the results derived from a comparison of the data in the table with meteorological conditions rest on

TABLE 2.—*Relative Sun-spot Numbers and Average Values of Solar Radiation Used in Study*

High solar values			Low solar values		
Date summer	Sun-spot number	Solar radiation	Date summer	Sun-spot number	Solar radiation
Apr. 1916.....	72	(1.952)	Apr. 1912.....	4	(1.928)
" 1918.....	81	1.953	" 1913.....	1	(1.925)
May 1917.....	114	1.956	May 1910.....	22	1.916
" 1920.....	34	1.953	" 1913.....	0	(1.923)
June 1905.....	49	1.968	June 1909.....	23	1.930
" 1919.....	111	1.955	" 1912.....	4	1.930
July 1906.....	103	1.962	July 1910.....	14	1.913
" 1917.....	120	1.989	" 1911.....	3	1.917
Aug. 1917.....	154	1.956	Aug. 1909.....	23	1.926
" 1918.....	102	1.954	" 1910.....	11	1.912
Sept. 1917.....	129	1.948	Sept. 1909.....	39	1.908
" 1918.....	80	1.944	" 1910.....	26	1.915
Mean	95.7	1.958	Mean	8.3	1.917
Winter			Winter		
Oct. 1917.....	72	1.952	Oct. 1911.....	3	1.915
" 1918.....	85	1.939	" 1913.....	3	1.866
Nov. 1917.....	96	(1.954)	Nov. 1911.....	4	1.903
" 1919.....	42	(1.953)	" 1913.....	1	1.866
Dec. 1917.....	129	(1.957)	Dec. 1911.....	2	(1.926)
" 1920.....	40	1.955	" 1913.....	4	(1.928)
Jan. 1918.....	96	(1.954)	Jan. 1911.....	3	(1.927)
" 1920.....	59	1.964	" 1913.....	2	(1.925)
Feb. 1918.....	65	(1.951)	Feb. 1912.....	0	(1.923)
" 1920.....	51	1.956	" 1913.....	3	(1.927)
Mar. 1917.....	95	(1.954)	Mar. 1912.....	5	(1.929)
" 1920.....	72	1.945	" 1913.....	0	(1.923)
Mean	75.2	1.955	Mean	2.5	1.913

Values in parentheses are derived from sun-spot data and are taken from Abbot's curve of equivalent values, Smithsonian Misc. Coll., Vol. 80, No. 2.

increased solar activity, whether measured by sun spots, faculae and flocculi, or by an increase in solar radiation reaching the earth. Solar radiation values are missing for a number of the spring and winter months because no observations were made during these months in the earlier years. These months are included because it

¹ A group of solar changes, Smithsonian, Misc. Coll., Vol. 80, No. 2, p. 8, 1927.

was desirable to have an equal distribution of the observations throughout the months in order to study and to eliminate seasonal influences. If, however, only those months had been used in which both values were present, the main conclusions which follow would

TABLE 3.—*Mean Departures of Pressure from Normal in Millibars with High Solar Activity*

Winter Half-Year							
	180°-120° W.	120°-60° W.	60°-0° W.	0°-60° E.	60°-120° E.	120°-180° E.	Mean
80°-70° N.	(-0.5)	(+1.0)	+1.2	-1.7	(-1.0)	(0.0)	-0.2
70 -60	+1.2	(+1.6)	-0.6	-0.7	+0.5	+0.2	+0.4
60 -50	+0.6	+1.6	+1.4	+1.2	+0.6	+1.1	+1.1
50 -40	+1.6	+0.4	+1.0	+1.1	+0.7	+0.2	+0.8
40 -30	+0.5	+0.2	+1.5	+1.0	+0.1	+0.4	+0.6
30 -20	-0.8	+0.4	+0.2	+0.1	-0.1	+0.2	0.0
20 -10	(-0.4)	+0.4	+0.3	+0.2	-0.6	-0.6	-0.1
10 -0	(-0.3)	0.0	+0.3	0.0	-0.3	-0.6	-0.1
Summer Half-Year							
80°-70° N.	(-2.0)	0.0	+0.2	-0.6	+1.5	(-1.2)	-0.4
70 -60	-1.8	(+1.1)	+0.7	+3.8	+2.4	-1.4	+0.8
60 -50	+1.2	+1.5	+1.1	+0.7	-0.1	+0.2	+0.8
50 -40	+0.6	+1.1	+0.5	+0.3	-0.7	-0.1	+0.3
40 -30	+0.1	+0.3	+0.4	0.0	-0.3	-0.2	+0.1
30 -20	-0.4	+0.2	-0.7	-0.2	0.0	-0.2	-0.2
20 -10	(-0.3)	+0.2	+0.1	-0.1	-0.2	-0.2	-0.1
10 -0	(-0.2)	+0.1	+0.7	0.0	-0.1	+0.1	+0.1
Year							
80°-70° N.	(-1.2)	(+0.5)	+0.7	-1.2	+0.2	(-0.6)	-0.3
70 -60	-0.3	(+1.3)	+0.1	+1.6	+1.4	-0.6	+0.6
60 -50	+0.9	+1.6	+1.3	+0.9	+0.3	+0.6	+0.9
50 -40	+1.1	+0.8	+0.8	+0.7	0.0	+0.1	+0.6
40 -30	+0.3	+0.3	+0.9	+0.5	-0.2	+0.1	+0.3
30 -20	-0.6	+0.3	-0.3	-0.1	-0.1	0.0	-0.1
20 -10	(-0.4)	+0.3	+0.2	0.0	-0.4	-0.4	-0.1
10 -0	(-0.2)	0.0	+0.8	0.0	-0.2	-0.3	0.0

Values in parentheses are interpolated from a synoptic chart (polar projection).

not have been greatly impaired, although the quantitative values would have been different.

The monthly values of pressure for the months when solar activity was above normal were separated into zones of 10° of latitude, namely all between 80° N. and 70° N., between 70° N. and 60° N., etc. Because the stations were not equally distributed, but were mostly

land stations, a further selection was made by grouping the stations into areas of 20° of longitude and 10° of latitude and taking means for each group. Finally, the means for the different groups were obtained for each 10° of latitude. The average departures of the

TABLE 4.—*Mean Departures of Pressure from Normal in Millibars with Low Solar Activity*

Winter Half-Year							
	$180^\circ-120^\circ$ W.	$120^\circ-60^\circ$ W.	$60^\circ-0^\circ$ W.	$0^\circ-60^\circ$ E.	$60^\circ-120^\circ$ E.	$120^\circ-180^\circ$ E.	Mean
$80^\circ-70^\circ$ N.	(+0.7)	(-0.5)	-3.9	-2.6	(-2.0)	(-1.2)	(-1.6)
70 -60	+1.2	(0.0)	-4.6	-2.3	-2.3	-1.6	-1.6
60 -50	+1.1	-0.2	-2.8	-1.3	-2.5	+0.4	-0.9
50 -40	+1.3	+0.8	-0.6	+0.5	-0.4	-0.1	+0.2
40 -30	+0.3	+0.9	+0.7	+1.3	0.0	+0.2	+0.6
30 -20	+0.7	+0.6	+1.0	+0.4	+1.7	+0.4	+0.8
20 -10	(+0.5)	+1.0	+0.7	+0.8	+0.4	+0.7	+0.7
10 -0	0.0	-0.2	+1.3	+0.7	-0.1	+0.6	+0.4
Summer Half-Year							
$80^\circ-70^\circ$ N.	(+1.5)	(+1.0)	+0.1	+1.3	(-0.3)	(-1.0)	(+0.4)
70 -60	+1.0	(+0.6)	+0.6	+0.8	-0.6	-1.5	+0.1
60 -50	+0.5	+0.4	+1.1	+0.1	+0.6	-2.4	-0.1
50 -40	+0.4	+0.8	-0.5	-0.7	+0.4	-0.4	0.0
40 -30	+0.4	+0.8	+0.7	-0.2	-0.2	-0.7	+0.1
30 -20	+0.8	+0.6	-0.2	-0.2	-0.3	-0.7	0.0
20 -10	(+0.7)	+0.7	+0.4	+0.1	0.0	+0.2	+0.4
10 -0	+0.6	+0.2	+0.3	-0.3	-0.5	+0.3	+0.1
Year							
$80^\circ-70^\circ$ N.	(+1.1)	+0.3	-1.9	-0.6	(-1.1)	(-1.1)	(-0.5)
70 -60	+1.1	+0.3	-2.0	-0.8	-1.5	-1.6	-0.7
60 -50	+0.8	+0.1	-0.9	-0.7	-1.0	-1.0	-0.5
50 -40	+0.8	+0.8	-0.6	-0.2	0.0	-0.3	+0.1
40 -30	+0.4	+0.8	+0.7	+0.5	-0.1	-0.2	+0.3
30 -20	+0.8	+0.6	+0.4	+0.1	+0.7	-0.1	+0.5
20 -10	+0.6	+0.8	+0.6	+0.5	+0.2	+0.5	+0.5
10 -0	+0.3	0.0	+0.8	+0.2	-0.3	+0.5	+0.3

Values in parentheses are interpolated from a synoptic chart (polar projection).

pressure from normal, in millibars, with high solar activity are shown in table 3, and the average departures from normal with low solar activity are shown in table 4.

The means in the last columns of these two tables show clearly that with high solar radiation there is a defect of pressure in the equatorial belt from the Equator to 30° N. latitude, an excess of pres-

sure from 40° to 70°N., and a defect in the vicinity of the pole, while the opposite signs are found in the same latitudes during low solar activity.

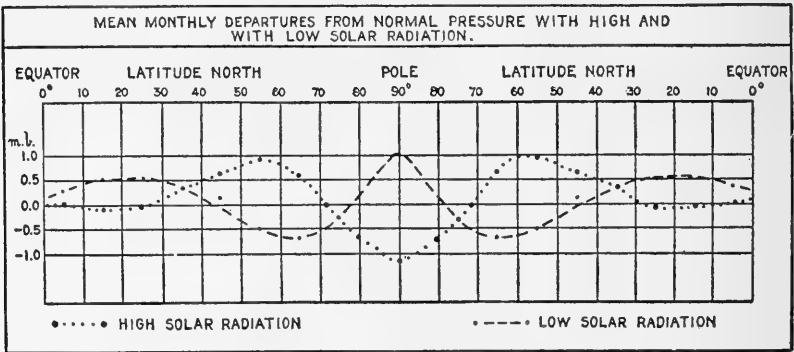

FIG. 5.—Mean monthly departures from normal pressure with high and with low solar radiation.

Figure 5 shows a plot across the pole of the means for the year in each case. The dotted line connects the values for high solar activity, and the broken line connects the values for low solar activity. Data are missing from points north of 80° so that the part of the curve near the pole is interpolated.

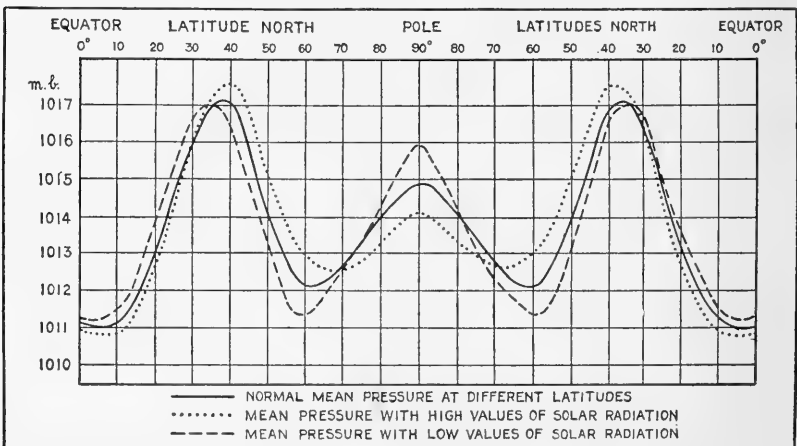

FIG. 6.—Mean pressure at different latitudes with different solar conditions.

This diagram brings out clearly the opposite oscillation of the pressure in latitude with high and with low solar activity.

Figure 6 shows how these departures appear when they are added to the normal distribution of pressure. In this figure the normal dis-

tribution of pressure with latitude is shown by a continuous line. The dotted line shows the distribution with high solar activity. With high solar activity the equatorial low pressure belt and the high pressure belts in middle latitudes are both intensified and the polar anticyclone diminished. This clearly means an intensification of the

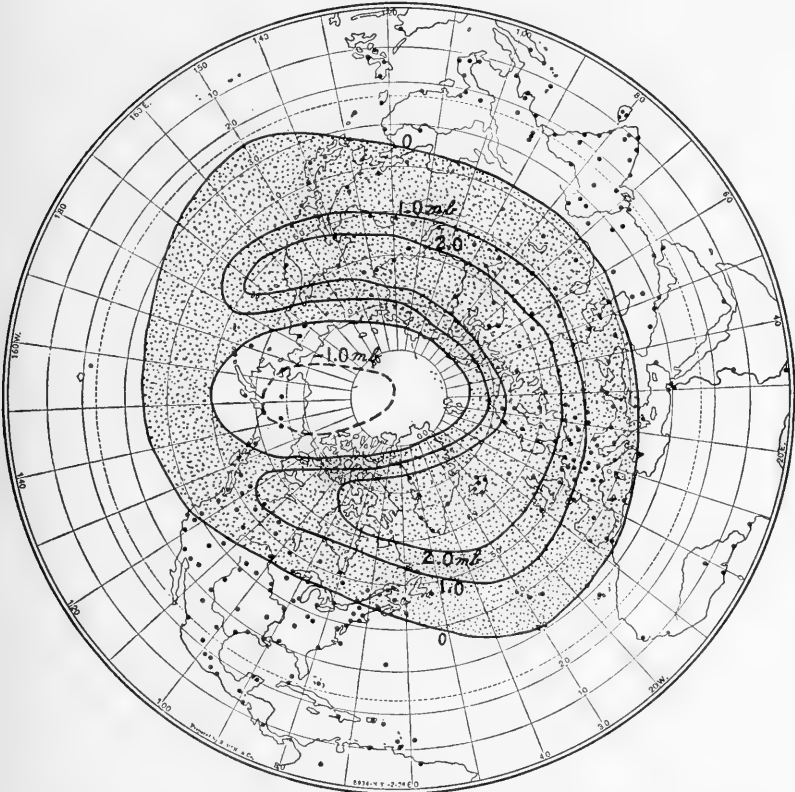

FIG. 7.—Differences in pressure with change from low to high solar activity. Shaded area shows increased pressure, unshaded areas decreased pressure. (Difference between yearly means in tables 3 and 4.)

normal atmospheric circulation. The decrease in the polar anticyclone is attributed to the increased circulation around the pole, the centrifugal action developed in the circulating winds causing a fall of pressure in the polar basin. The effect of the earth's rotation on the wind increases with latitude, and for this reason the fall of pressure in the equatorial belt is greater at latitude 20° than at the Equator. (See fig. 5.) The broken line shows the distribution of pressure with

low solar activity. The opposite conditions are here found; the pressure is higher in the tropics and near the pole, and lower in middle latitudes than the normal pressure.

Another fact to be noted is that the maximum of pressure between 30° and 40° latitude and the minimum of pressure between 60° and 70° latitude are nearer the pole when solar activity is high than when solar activity is low. This same condition prevails in both the northern and southern hemispheres.

The changes of pressure due to a change from low to high solar activity are shown in figure 7, where the changes for each 20° of longitude and 10° of latitude are plotted on a chart of the northern hemisphere with a polar projection. This map shows a decreased pressure all around the world in latitudes of 0° to 30° with increased solar activity. It shows increased pressure between latitudes 40° to 60° and diminished pressure in the polar basin. But there is evidently a longitude effect also. The excess of pressure in latitudes 40° to 70° is greatest over the Eurasian continent and least over the Pacific Ocean.

If the values in tables 3 and 4 are corrected for latitude effect by subtracting the mean values in the last column of the tables, there is seen to be a distinct tendency for the pressure in all latitudes to be low over the Pacific and high over Eurasia, with increased solar activity. Subtracting the yearly means in table 4 from those in table 3 and correcting for the latitude effect, the data were obtained from which figure 8 was drawn. The tabulated results are shown in table 5.

TABLE 5.—*Longitude Differences. Differences in Millibars between the Yearly Means in Tables 3 and 4 Corrected for Latitude*

	180°-120° W.	120°-60° W.	60°-0° W.	0°-60° E.	60°-120° E.	120°-180° E.
80°-70° N.
70 -60	-2.7	+0.8	+1.0	+1.6	-0.3
60 -50	-1.3	+0.1	+0.8	+0.2	+0.1	+0.2
50 -40	-0.2	-0.5	+0.9	+0.4	-0.5	-0.1
40 -30	-0.1	-0.5	+0.2	0.0	-0.1	+0.3
30 -20	-0.8	+0.3	-0.1	+0.4	-0.2	+0.7
20 -10	+0.1	+0.2	+0.1	0.0	-0.3
10 -0	+0.3	+0.3	-0.1	+0.4	-0.5

Figure 8 brings out clearly an excess of pressure over the Eurasian continent with increased solar activity, the maximum being in latitude 50° to 80°N.; while a defect is evident over the Pacific Ocean and North America, the greatest depression being in high lati-

tudes over the North Pacific. This longitude distribution is apparently another effect of centrifugal action developed by increased atmospheric circulation with increased solar activity. In regions where the air flows more freely, as over the great expanse of the Pacific, the centrifugal force developed tends to lower the pressure, especially in high latitudes, more over the water surfaces than over the land areas.



FIG. 8.—Longitude differences between high and low solar activity.

The primary cause of the general atmospheric circulation is believed to be the contrast in temperature between equator and pole. This circulation and all its attendant phenomena changes in unison with changes in the amount of solar radiation received by the earth, just as the regulator on a steam engine varies with the amount of heat received by the boiler.

Once in operation there are at least four modifying forces of importance acting on the general atmospheric circulation:

The first of these modifying forces is the earth's rotation. The effect of this rotation is to cause a high pressure belt in middle latitudes and a diminished pressure in the polar basin, although it cannot entirely destroy the central high pressure at the pole due to increased cold without stopping the circulation. Hence, any increase in solar radiation should intensify the pressure belt in middle latitudes and lower the pressure in the polar basin, and the reverse with decreased solar radiation. This is exactly what happens.

A second modifying force is the change in cloudiness caused by increased or decreased atmospheric circulation. Clouds and water vapor¹ have an important influence on incoming and outgoing radiation, so that the belts of cloudiness near the Equator and near 60° of latitude have an important influence on the temperature and pressure and thus should aid materially in maintaining the latitude effects of changes in solar radiation reaching the atmosphere of the earth.

A third modifying force is the movement of ocean water under the influence of wind. An increase in the general circulation should cause an increased flow of ocean waters, with all the modifications in weather which such an increase implies.

A fourth modifying force is the distribution of land and water.

The influence of all these modifying causes can be seen in the latitude and seasonal effects, with differences in solar activity.

III. SEASONAL INFLUENCES

When the influences of solar changes on the pressure are worked out separately for each month of the year for different places, it is found that the effect is different at different seasons of the year.

At continental stations in high latitudes, such as Dawson, the pressure increases much more in mid-winter with increased solar radiation than at other seasons, and at mid-summer the effect may even be the reverse of that in mid-winter. Figure 9 shows the annual period in the effect of increased solar activity at Dawson. At other stations such as Stykkisholm in the North Atlantic and Nome in the North Pacific there is a dominant semi-annual period in the solar influence. (See fig. 9.) The dotted curves in figure 9 are sine curves derived from the first and second terms of the harmonic formula in a

¹ Simpson, G. C., Further studies in terrestrial radiation. *Mem. Roy. Meteor. Soc.*, Vol. 3, No. 21, 1928. Manson, M., The evolution of climates, Baltimore, Md., 1922. Ångström, A. K., On radiation and climate, *Geogr. An.*, Vol. 7, p. 122, Stockholm, 1925. Brooks, C. E. P., *Climate through the ages*, p. 138, London, 1926. Abbot, C. G., The radiation of the planet earth to space, *Smithsonian Misc. Coll.*, Vol. 82, No. 5, 1929.

12-month period. The 6-month period and the annual period in pressure were computed in this way for stations all over the northern hemisphere from the data in "World Weather Records" for the

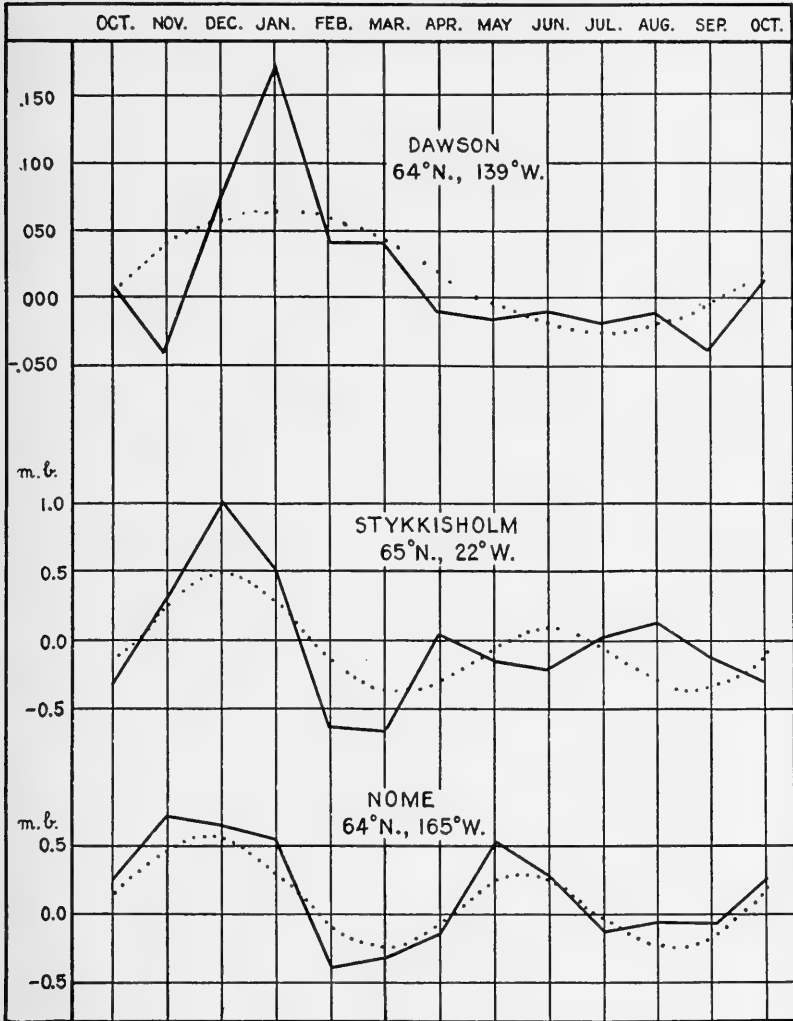

FIG. 9.—Departure from normal pressure by months with high solar activity.

months when solar activity was high and for the months when solar activity was low as given in table 2. The results for the 6-month period when solar activity was high at the epochs April and October are shown in figure 10 plotted on a map of the northern hemisphere.

It is seen from this map that the latitude effect as pictured in figure 7 is increased twice a year when the sun crosses the Equator in March and October. At that time the effect of high solar activity on the pressure is accentuated. The decreased pressure at the Equator, the increased pressure in middle latitudes and the decreased pressure at the poles are greater than at other times of the year.

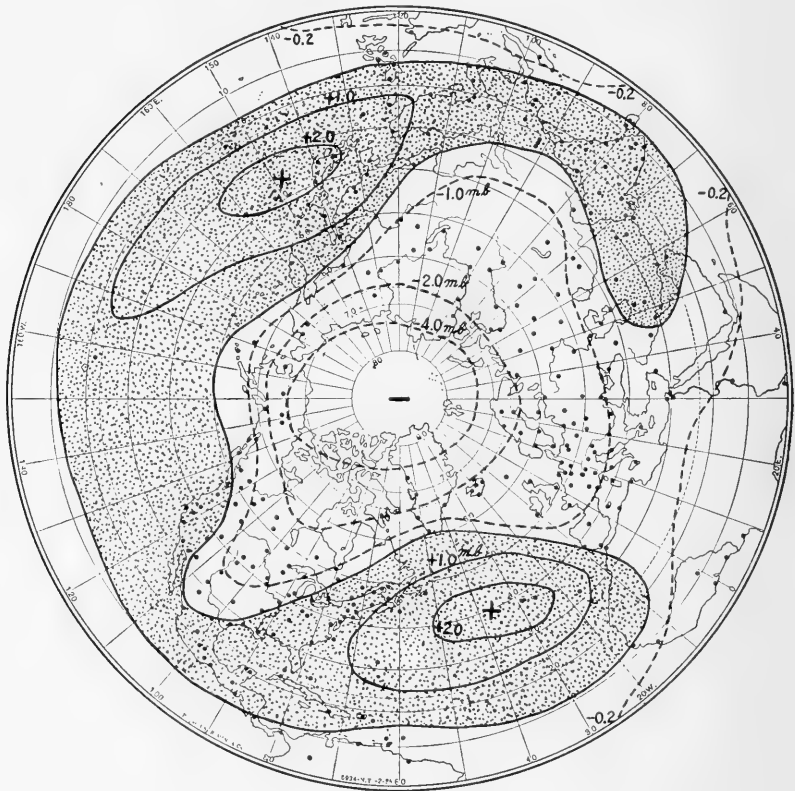

FIG. 10.—Excess or defect of pressure at the Equinoxes (March and September) with increased solar activity.

On the other hand, when the sun is at the solstices in June and December the latitude differences are diminished and effects due to contrasts between land and water are accentuated. The greatest increase of pressure with increased solar activity is over the continents in winter and over the oceans in summer. This is an annual change in contrast to the semi-annual period in latitude effects. The annual effect is shown in figure 11.

This chart is derived from the annual period in pressure as computed from the data by harmonic analysis. The areas outlined on the chart show where the maximum increase of pressure occurs at different seasons when solar activity is greater than normal. In mid-winter the excess of pressure is greatest over the continents in high latitudes. There is a defect in the same regions in summer.



FIG. 11.—Regions in which highest pressure occurs at different seasons with increased solar activity. Annual period.

In spring the greatest excess occurs over the North Atlantic and North Pacific, and there is a defect in autumn. In autumn there is an excess in middle latitudes and a defect in spring.

The results both for the semi-annual period and for the annual period were checked by an analysis of the data during periods of low solar radiation which give in general the opposite effect.

The shifting in position of maximum effect on the atmosphere in the annual period is clearly related to surface conditions and may be

explained by changes in the balance between incoming and outgoing radiation. In summer the land masses in high latitudes absorb solar heat and this absorption increases with increased solar radiation. There is also an increase of cloudiness at that time which should play an important rôle in determining the effect of increased solar radiation on the atmosphere. In autumn an increased atmospheric circulation causes an excess of warm water and of cloudiness in the North Atlantic and North Pacific with an accompanying diminution of pressure. The same increase in atmospheric circulation determines an increased flow of cold water along the north coast of Africa and of Western Mexico and thus determines the opposite annual period in these regions to that in the northern part of the same oceans.

The seasonal shifting in the centers of maximum solar action in the atmosphere are thus plausibly related to changing physical conditions in the atmosphere and in the surface conditions of the earth.

IV. ATMOSPHERIC WAVES

When atmospheric changes, whether of pressure, temperature, or wind movement are analyzed into oscillations of different lengths they are usually found not to be stationary but to progress from point to point. The short oscillations move fastest and the longer oscillations progress more and more slowly with increasing length. They thus have some analogy to ocean waves and are frequently called waves.

Meteorological data may be analyzed into longer and shorter oscillations by means of smoothing, by means of using changes of successively greater length, by means of sine curves derived from individual periods, or by the process of averaging successive periods, using trial periods of different length. These processes are described and illustrations given in "World Weather."¹

The method adopted for the present research was to select from plotted curves the cases where an oscillation of some particular length was unusually strong and then to get the average of several successive oscillations, so as to eliminate oscillations of longer period. This process was repeated successively for each particular oscillation selected, dropping one and adding another later in time. An example of the method is shown in table 6 for St. Paul, Minnesota. The data were obtained from the Washington 8 a. m. weather map.

The consecutive means of four successive periods, obtained as shown in table 6 for the months of November and December, 1927, are plotted in figure 12 for a series of stations running from Nome,

¹ Clayton, H. H., *World Weather*, p. 114. New York, Macmillan & Co., 1923.

TABLE 6.—Means of 4 Periods of 7 Days Each, St. Paul, Minnesota

Day	Observed pressure, 29.00 + inches							Consecutive means of 4 periods, 29.00 + inches						
	1	2	3	4	5	6	7	1	2	3	4	5	6	7
Nov. 4	.68*	1.02	1.32	1.24	1.16	1.26	.86							
11	.66*	1.42	1.26	1.14	.92*	1.38	1.28	.88	1.12	1.18	.98	.86*	1.29	1.13
18	1.30	1.28	.94	.84*	.94	1.26	1.02	1.06	1.24	1.17	.87	.81*	1.18	1.22
25	.88	.76	1.18	.70	.42*	1.26	1.36	.98	1.20	1.15	.79	.76*	1.12	1.04
Dec. 2	1.40	1.48	1.30	.78*	.96	.82	1.20	1.02	1.10	1.22	.94	.89*	1.13	1.14
9	1.34	1.28	1.18	.84	.70*	1.14	.58	1.16	1.26	1.26	1.10	1.05	.93*	.97
16	.46*	.88	1.20	1.46	1.48	1.32	1.40	etc.						
23	1.46	1.42	1.38	1.32	1.08	.42*	.68							

* Minimum.

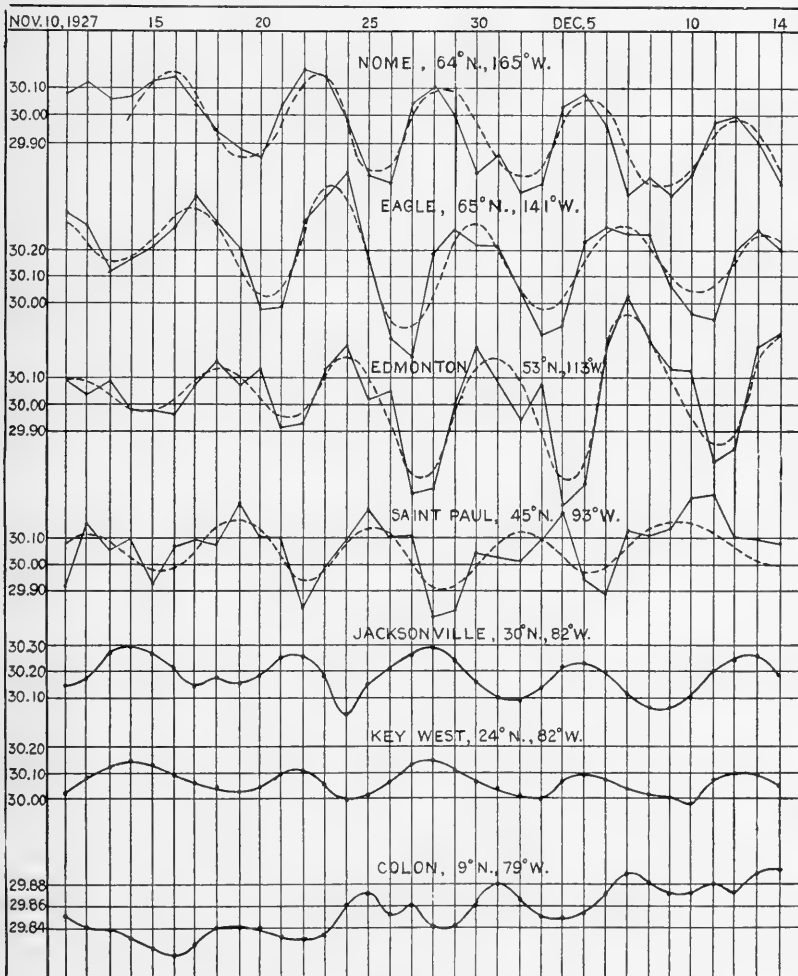

FIG. 12.—7-day pressure wave.

Alaska, southeastward to Key West, Florida, and to Colon, Panama. It is evident from the plot that the maxima and minima occur later at southern stations, so that at Williston, North Dakota (not shown in fig. 12), the oscillations are opposite in phase to those at Nome;

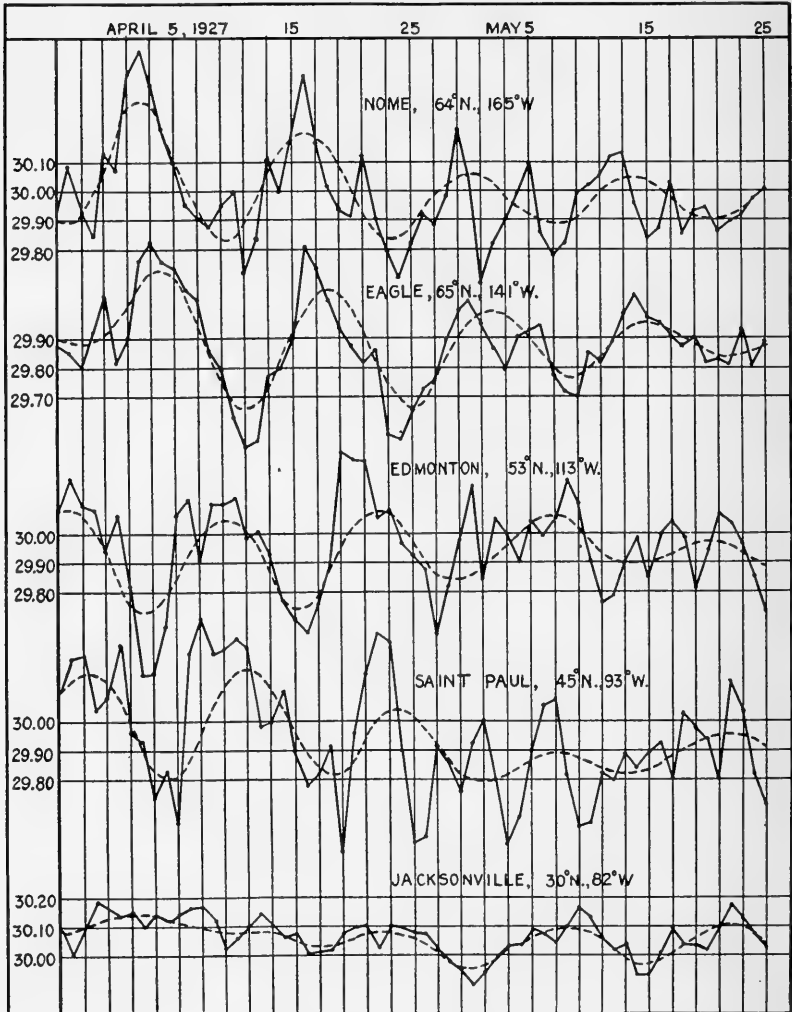

FIG. 13.—14-day pressure wave.

but further southward at Key West they are in the same phase as at Nome, although much diminished in intensity.

Figure 13 shows an oscillation of 13.6 days averaged in overlapping two-period intervals. The continuous lines were plotted from

the averages; sine curves computed from the data by harmonic analysis are shown by dotted lines. Here, again, it is found that the maxima and minima of the oscillations occur later at the more southern stations and the phase is inverted at St. Paul, showing that the progressive movement is only about one half as rapid as the 7-day period. In other words the ratio, rate of progress divided by length of period, is the same for both periods and apparently for all periods, as will be shown later.

That atmospheric pressure and temperature may be analysed into waves or oscillations which move at different speeds inversely proportional to their wave length was advanced by me in the monthly *Weather Review*, April, 1907, and has been confirmed by a number of research workers, Defant, Vercelli, Danilow,¹ Clough,² Weickmann,³ and others. These waves do not always move from the same direction, as Danilow and Weickmann have pointed out; but the dominant direction of motion is from northwest to southeast in the northern hemisphere and from southwest to northeast in the southern hemisphere.⁴

The rate of progress for all classes of moving atmospheric waves appears to follow a very simple law. This may be illustrated by the progress of the 7-day wave. Using the data from about 16 stations, the progress of the wave from Alaska is illustrated in figure 14 by a series of heavy lines giving the wave front on successive days as it passed across the North American Continent. Small circles show the positions of the stations used. It is seen that the wave moved from about 180° W. longitude at a rate which would carry it half around the world in one period of oscillation, namely in seven days, and hence entirely around in two periods. At the same time the wave front advanced from the Arctic Circle near Nome to the Tropic of Cancer near Key West also in a period of seven days or at a rate which would carry it, from pole to Equator in the time of two periods of oscillation.

If, however, the rate of progress is taken not along the wave front but along a meridian—in this case the 90th meridian west is a good example—the rate of progress southward from the Arctic Circle to the Tropic of Cancer takes place in $3\frac{1}{2}$ days, or at a rate

¹ Wetterwellen, Podoleschen Abtheilung des Ukrainischen Meteorologisches Dientes, 1926.

² Monthly Weather Review, Vol. 52, No. 9, p. 436, Sept. 1924.

³ Weickmann, L., Das Wellenproblem der Atmosphäre. Meteor. Zeitschr., S. 241, 1927.

⁴ Clayton, H. H., World Weather, p. 111. New York, Macmillan & Co., 1923.

which would carry it from pole to Equator in one period of oscillation. This is evidently a law which applies to wavelike changes of all lengths.

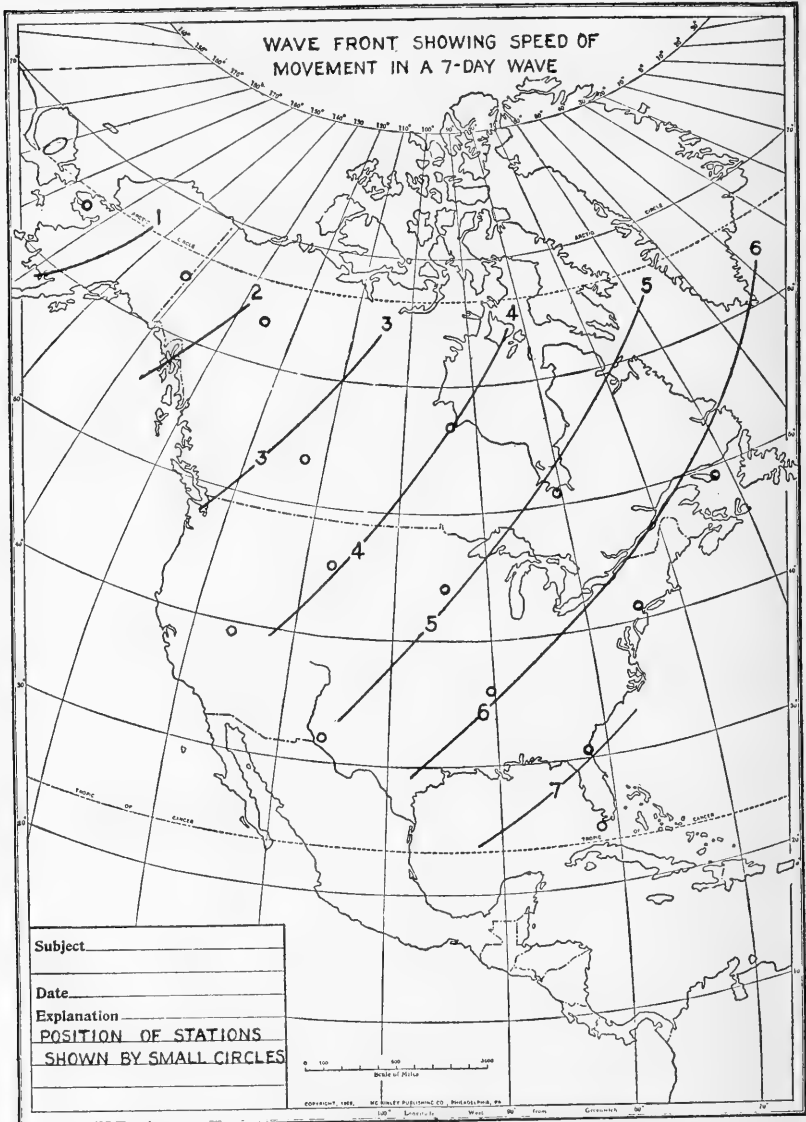

FIG. 14.—Wave front showing speed of movement in a 7-day wave.

In Dr. Weickmann's¹ able analysis of the 24-day wave of pressure of the winter of 1923-24, it is shown that the wave originated

¹ Petermanns Mitteilungen, Ergänzungsheft No. 191, 1927.

in the polar basin and spread southward toward the Equator. Figure 15 is derived from a plot made by Dr. Weickmann. The plot is made to show the wave at successive dates along the meridian of 45° E. longitude. The dotted curve No. 1 in figure 15 shows that on December 10 there was a minimum of pressure in the arctic basin north of Spitzbergen and a high pressure over Central Asia about 60° N. Six days later, on December 16, as shown by the broken curve No. 2, the low pressure was about 70° N. and a high pressure about 45° N. Twelve days later on December 22, as shown by the continuous curve No. 3, the period was in opposite phase and

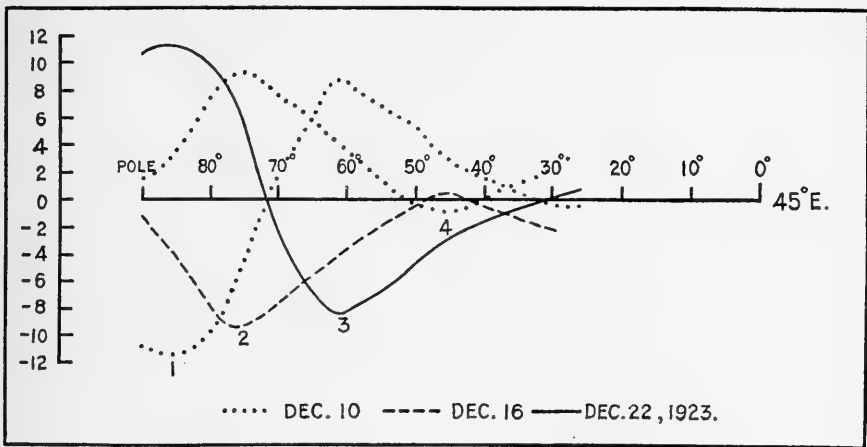

FIG. 15.—Pressure departures in 24-day period (data derived from diagram by Weickmann).

the low pressure is found at 60° N. with a high pressure south of 30° latitude and also in the polar basin. Eighteen days later, on December 28, as shown by the dotted curve, No. 4, the low pressure is at 45° and a high pressure is advancing southward.

The plot brings out clearly the decrease in amplitude of the oscillations with decreasing latitude. Owing to the decrease of amplitude with latitude the velocity of progress of the wave is best obtained from the points where the curve crosses the zero line. The first zero point is at 72° latitude and the second about 30° latitude. This is the distance traversed by the wave in 12 days, a rate which would carry it from pole to Equator in about one period of 24 days.

In Mr. Clough's¹ study of a period of about $2\frac{1}{2}$ years in pressure he says: "The epochs of the short period for St. Paul, St. Louis,

¹ Monthly Weather Review, Vol. 52, No. 9, p. 436, Sept., 1924.

Memphis, Vicksburg and New Orleans have been derived and it is found that there is an average lag of 0.19 year from St. Paul to St. Louis and a lag of 0.37 year between St. Paul and New Orleans." The distance from St. Paul to New Orleans is 15° of latitude and 0.37 year is about one-sixth of the period, so that the rate of prog-

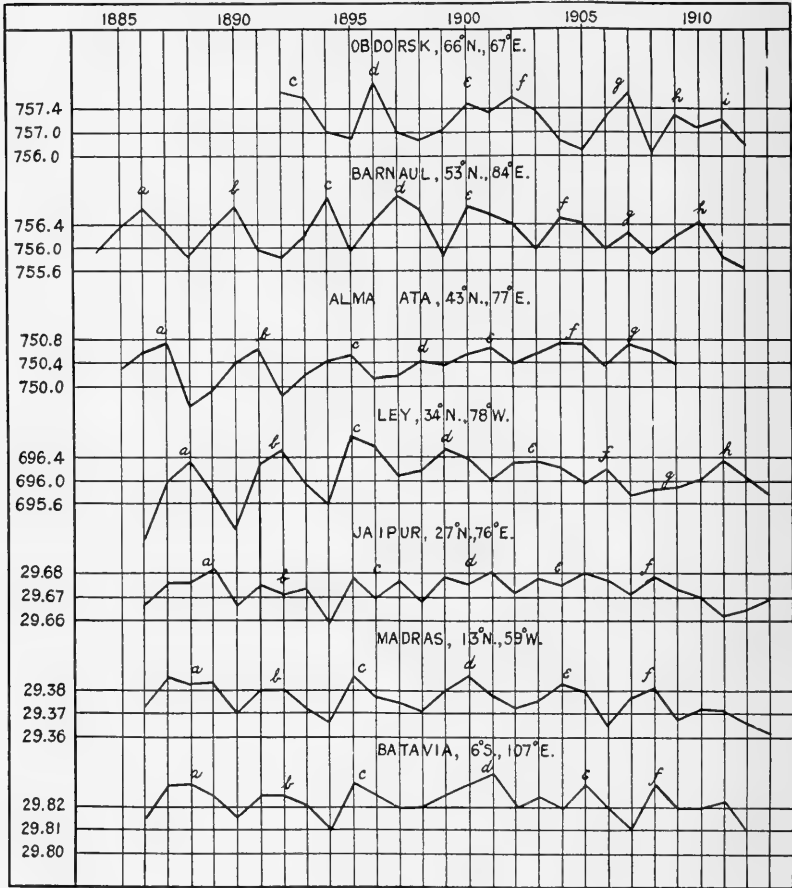

FIG. 16.—Pressure in 3.77-year period.

ress here indicated would carry the wave from pole to Equator in one period.

In figure 16 is found a period in which the unit of time is years instead of days. The period of oscillation in pressure is about four years. It was taken to be 3.75 years, or one-third of a sun-spot period of 11.3 years, and averages were made for each three successive oscillations of 3.75 years. The continuous curves show the

averages. The letters a, b, c, etc., show successive maxima. The data were derived from "World Weather Records" and cover the continent of Asia where the data are more complete for different latitudes than in North America.

It is seen from the plot that the maxima and minima of the period occur first in high latitudes and successively later at stations nearer the Equator, at least down to about 30° latitude, taking about three years to move from Obdorsk, 66° N., 66° E., to Ley, 34° N., 77° E. In the equatorial belt between 20° N. and 20° S. the maxima and minima occur simultaneously at all stations as shown by the results for Madras and Batavia. However, from figure 16 it is seen that the pressures at Alma Ata, 43° N., and at Batavia, near the Equator, are opposite in phase, which is further evidence that this wave traversed 90° of latitude in one period of about 3.75 years.

A recent study of 2- and $3\frac{1}{2}$ -year waves in temperature by Ernest Rietschel¹ shows a rather complex movement indicating a combination of standing and moving waves.

That the law of wave progress quoted above holds true in the Southern Hemisphere as well as in the northern is shown by the rate of progress of a temperature wave of about 18 days shown plotted on page 223 of "World Weather."⁴ This wave progressed from Santa Cruz, 50° S., to Cuyaba, 16° S., in seven days, a rate which would carry it from pole to Equator along a meridian in one period of 18 days.

The rate of progress of a 7.5-year wave is indicated in figure 22 where the maxima and minima of the waves occur successively later at Stykkisholm, Rome, and Calcutta, the minima and maxima at Calcutta being about 7 years later than at Stykkisholm.

These facts render it evident that the rate of latitude displacement is a general law for periodic oscillations of all lengths. This law may be stated as follows:

Law of latitude displacement of periodic waves.—Periodic oscillations in atmospheric conditions progress in latitude from point to point along a meridian at a rate that would carry the wave from pole to Equator in one period, whatever the period of oscillation.

It is probable that the law of displacement in longitude is equally simple. Figure 14 shows that the 7-day wave progressed in longitude about 180° , or half around the world, in seven days.

¹Die $3\frac{1}{2}$ jährige und die 2 jährige Temperaturschwankung, von Ernst Rietschel. Geographical Institute of the University of Leipzig, Vol. IV, No. 1, 1929.

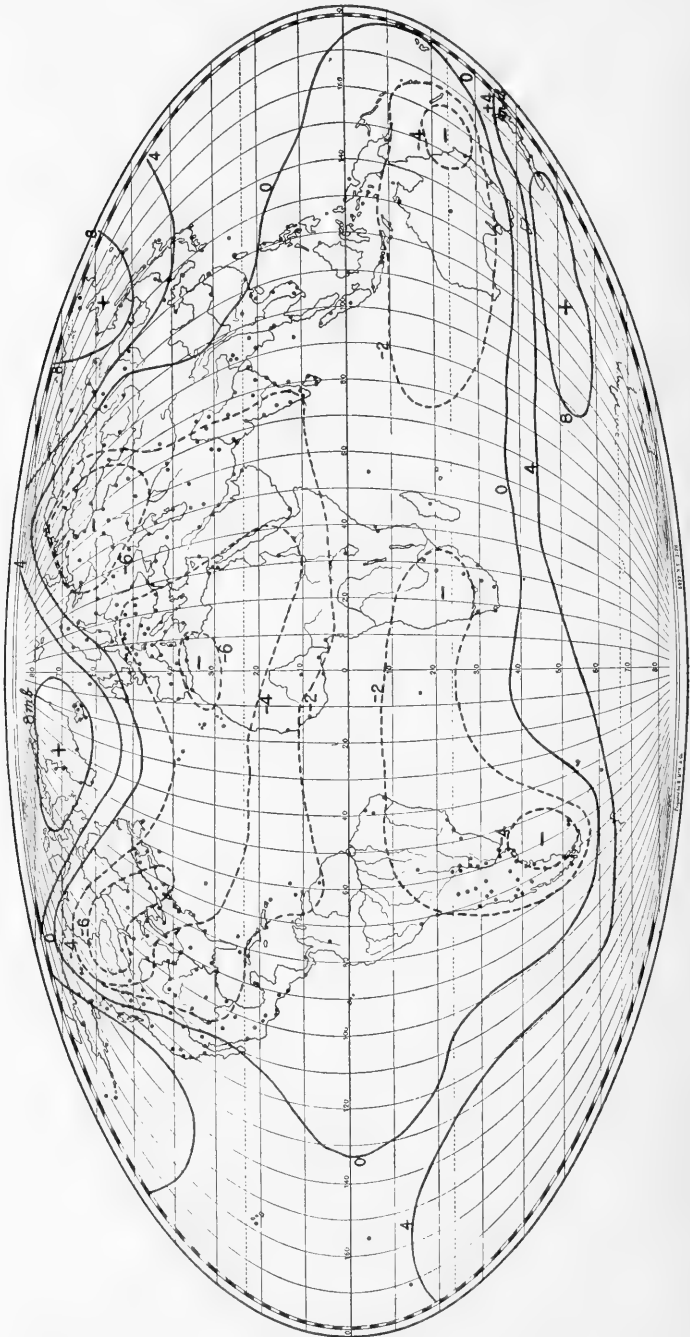

FIG. 17.—Departures of pressure from mean in 7.5-year period. Epochs 1885, 1893, 1900.

A proportional rate of progress appears to occur in the periodic wave of about 7.5 years. Figure 17 shows the centers of oscillation in a 7.5-year wave on a world map. This map is derived from harmonic values computed from groups of three periods between 1883 and 1913 at 117 stations scattered over the world. It shows the centers of oscillations at the epochs, 1885, 1893, 1900, etc. Continuous lines show equal values above normal and broken lines show equal values below normal. It is not possible with available data to follow the progressive movement of all the centers, but the center over Greenland shows a distinct progress from west to east. This progress will be evident from figure 18 which shows the centers of oscillation in the area between 50° W. and 120° E. north of the Equator when the epochs are taken successively two years later. The results in figure 18 are derived from the data of 48 stations taken from "World Weather Records."

In 1885 there was a marked excess of pressure over Greenland (see fig. 17); in 1887 this center of excess pressure is displaced to Norway; in 1889 this center is over the northern part of central Siberia; two years later, in 1891, it is over the northern part of western Siberia. The progress of the centers is shown by small circles in the upper chart of figure 18. The circles show that the center was displaced eastward about 180° in a period of 7.5 years or at a rate which would carry it around the world in two oscillations of this period.

In his study of the $2\frac{1}{2}$ -year period Mr. Clough¹ found that the epochs at Portland, Oregon, preceded those at Toronto by about 0.75 year. The difference in longitude is 43° . At that rate the epoch would move about 150° of longitude in one period, or approximately around the world in two periods.

The charts given by Dr. Weickmann in his study of the 24-day period referred to previously do not show the drift in longitude so clearly as the drift in latitude. However, in his charts there are found centers of maximum departure which show a drift in longitude. A center in the Aleutian Islands on December 10, 1923, moved eastward across Canada to Labrador in 11 days, which is at the rate of about one period for 180° of longitude; but a center near Greenland moved eastward to northern Siberia and then retreated.

The longitude drift of the waves is, hence, not so clearly defined as the latitude drift; but there is undoubtedly a trend which may be stated as follows:

¹ Monthly Weather Review, Vol. 52, No. 1, p. 39, Jan., 1924.

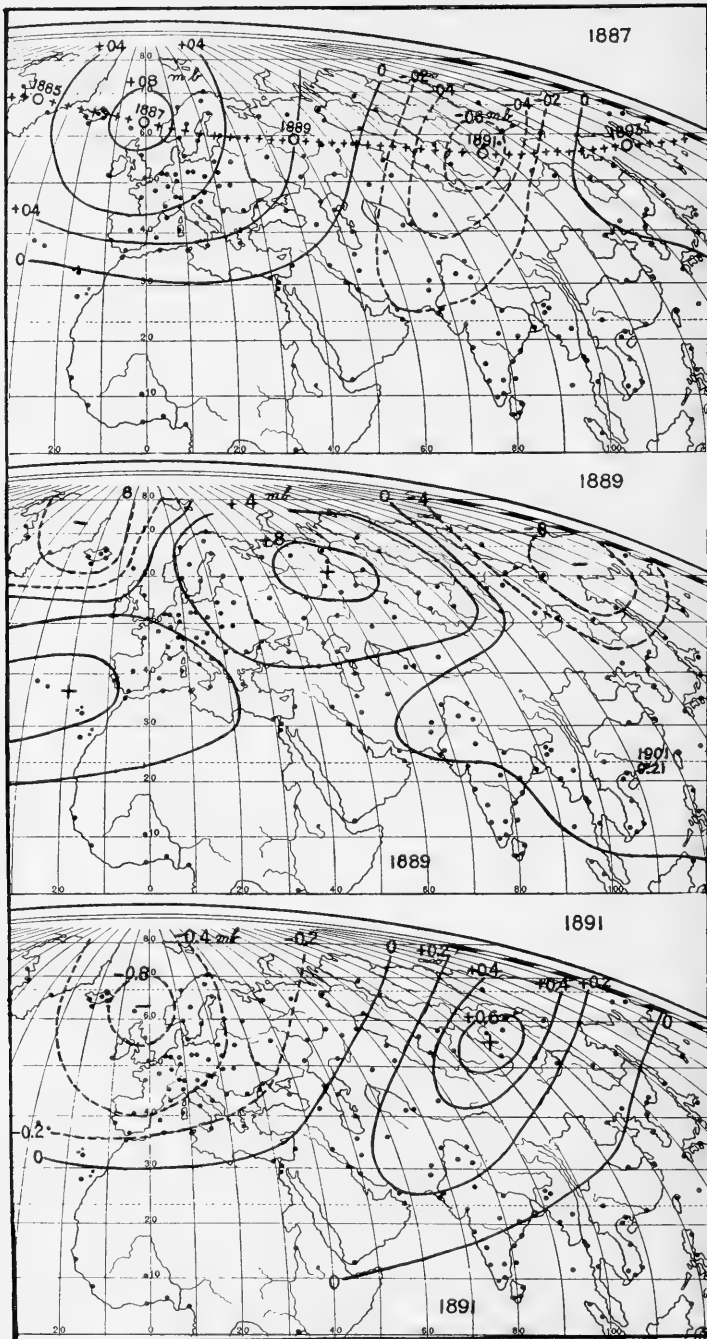

FIG. 18.—Departures of pressure in 7.5-year period, epochs 1887, 1889, 1891.

Law of longitude displacement of periodic waves.—Periodic waves tend to drift eastward at a rate of 180° of longitude in one period, whatever the length of the period. The centers of greatest departure are found in high latitudes, 60° to 80° from the Equator.

There are several factors which make this drift toward the east difficult to follow. First there are the factors depending on solar changes described in the latitude effect and which are nearly instantaneous with solar changes. There are also seasonal factors and probably others which influence the results.

Examining the successive charts in figure 18 it is found that the magnitude of the departures in the 7.5-year period decreased rapidly as the central areas passed into Siberia and increased again over Kamchatka. This enhanced intensity in the departures coincided with a maximum of solar activity as will be seen later.

Another disturbing factor is the formation of centers of disturbance moving at right angles to the normal waves. When waves of high pressure and low temperature are advancing from the northwest, low pressure areas form in front of them and advance from southwest to northeast. These disturbances advancing toward the northeast are particularly frequent over the warm ocean waters to the east of Asia and of North America. These cross currents greatly complicate the normal movement of atmospheric waves and make analysis of the data difficult.

V. RELATION OF THE WEATHER WAVES TO SOLAR CHANGES

If the values of solar radiation observed by the Smithsonian Astrophysical Observatory simultaneously with the pressure waves are treated in the manner just described they show in each case wavelike changes of the same length as the pressure waves.

Figure 19 shows the successive means of four periods of seven days in solar radiation during November and December, 1927, compared with the atmospheric pressure observed at the same time at Eagle, Alaska, and treated in the same manner as in table 6. The dotted curves in each case show the harmonic values of the 7-day wave computed from the data. Compare this diagram with the plots in figure 12.

Figure 20 shows the means of successive values of a period of 13.6 days in solar radiation and in pressure derived from the means of two periods. This diagram may be compared with the plots in figure 13. The dotted curves in figure 20 show harmonic curves computed from the data.

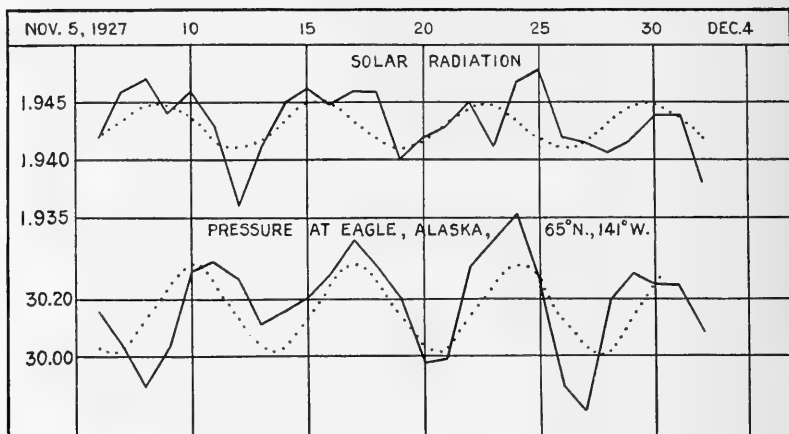

FIG. 19.—7-day period in solar radiation and pressure.

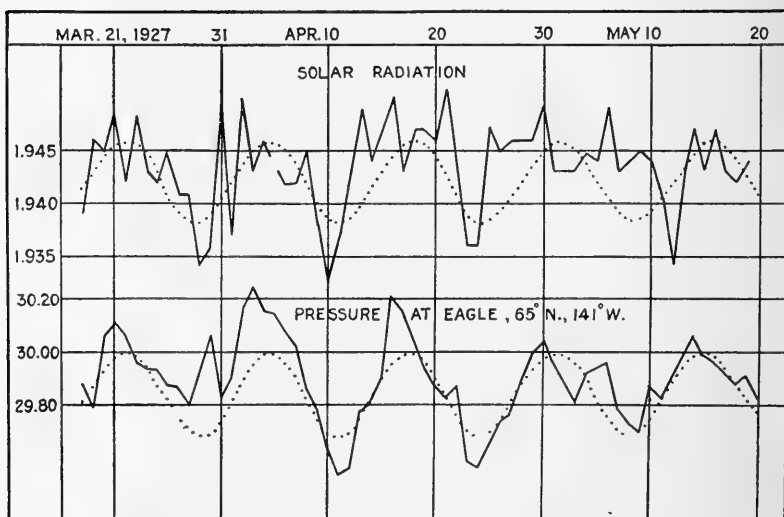

FIG. 20.—13.6-day period in solar radiation and pressure.

Figure 21 shows the observed values of solar radiation during December, 1923, and January and February, 1924. These values are compared with the observed values of pressure at Spitzbergen and at Hamburg. A 24-day period of oscillation is evident in each case and this oscillation is shown by the dotted curves computed from the data in each case by harmonic analysis. Pressure data from all

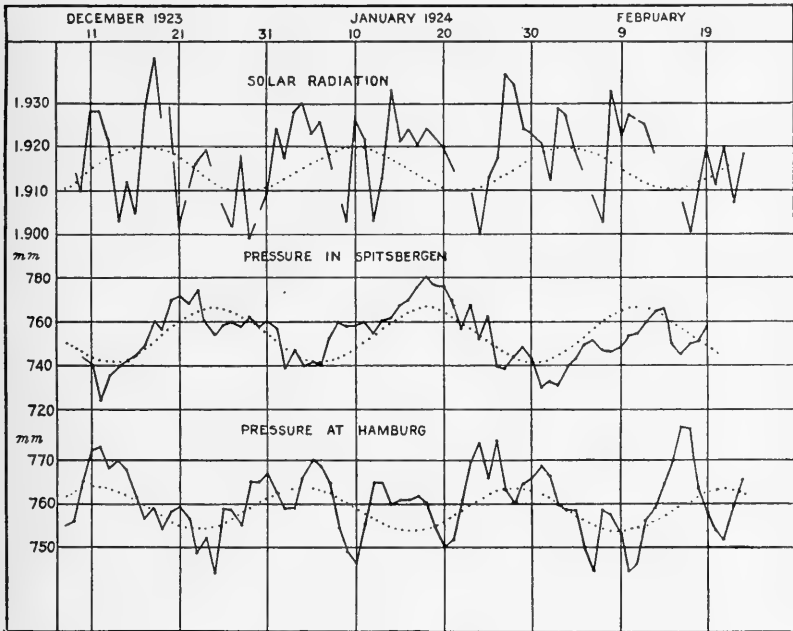

FIG. 21.—24-day period in solar radiation and pressure.

over the northern hemisphere were treated in this way for a period of 24 days by Dr. Weickmann and showed a systematic wave movement from the polar basin southward.

For the study of long periods, no values of solar radiation are available; but the 7.5-year period shows a distinct relation to sun-spot changes. Figure 22 shows a plot of consecutive means of three periods of 7.5 years. This period is one-third of Hale's sun-spot period of 22.5 years, and the mean of the three periods eliminates the 11.3-year sun-spot period which is one-half of Hale's period.

Pressure curves are plotted for five widely separated stations. These plots show distinctly an oscillation in the atmosphere of the length of 7.5 years and a progress southward from high latitudes.

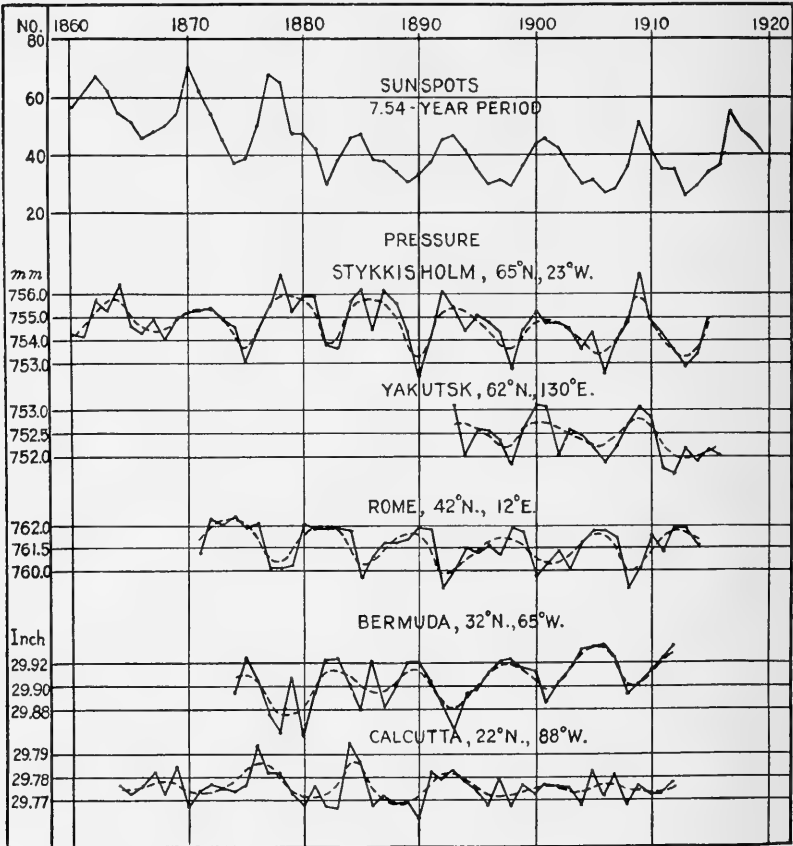

FIG. 22.—7.54-year period in sun spots and pressure means of 3 periods.

VI. SOLAR CYCLES AND WEATHER CYCLES

From the preceding investigation it is evident that atmospheric and solar conditions show wavelike changes of a periodic nature. The question has long been a challenge to investigators, as to whether there are fixed and regular cycles in weather and in solar changes. If such regular cycles could be found, it would greatly assist in unraveling the complexities of the weather and in forecasting future occurrences. There is a dominating period of about 11 years in sun-spot numbers, and many efforts have been made to find this same

dominating period in weather changes. Such a relation has not been found and the reason appears to be that weather changes follow changes in solar radiation more closely than they do sun-spot numbers, and solar radiation is more variable and shows a more complex periodicity than do sun spots.

When the 11-year period 1917 to 1928 is analysed harmonically for sun spots and solar radiation, the results in table 7 are obtained.

TABLE 7.—*Harmonic Terms for 11¼-Year Period in Sun Spots and Solar Radiation*

Sun-spot numbers		Solar radiation	
Epoch 1917.5	Amplitude in numbers	Epoch 1917.5	Amplitude in calories
$A_1 = 104^\circ$	$a_1 = 35.3$	$A_1 = 64^\circ$	$a_1 = .009$
$A_2 = 274^\circ$	$a_2 = 7.9$	$A_2 = 238^\circ$	$a_2 = .004$
$A_3 = 305^\circ$	$a_3 = 10.6$	$A_3 = 50^\circ$	$a_3 = .008$
$A_4 = 333^\circ$	$a_4 = 6.0$	$A_4 = 339^\circ$	$a_4 = .005$

These results show that in a general way the oscillation in the number of sun spots and in the intensity of solar radiation are in the same phase—that is, when one increases the other increases; but the amplitudes of the changes are very different. The amplitude of the primary oscillation, a_1 , in the sun spots (the 11¼-year period) is decidedly predominant while in the solar radiations the amplitudes of the harmonics of $\frac{1}{2}$, $\frac{1}{3}$, and $\frac{1}{4}$ of 11.3 years, a_2 , a_3 , and a_4 are almost as large as the primary a_1 . The pressure data for tropical stations for the 11 years 1917 to 1928 are not available at present, so that a computation of pressure changes was made by going back two periods of 11¼ years to January, 1890, and computing the harmonic terms from the mean pressure of nine equatorial stations extending from Quixeramobim in Brazil eastward across Africa and the Indian Ocean to Malden Island in the Pacific. The data covered two 11-year periods, 1890-1913, and the epochs were taken at 1895.0 = 1917.5.

TABLE 8.—*Harmonic Terms for 11¼-Year Period in Pressure, 1890-1913*
Mean Pressure of 9 Equatorial Stations
Epoch 1895.0 = 1917.5

$A_1 = 325^\circ$	$a_1 = 0.36$ mb.
$A_2 = 29^\circ$	$a_2 = 0.32$ mb.
$A_3 = 265^\circ$	$a_3 = 0.25$ mb.
$A_4 = 150^\circ$	$a_4 = 0.35$ mb.

This comparison indicates that in the 11¼-year period in pressure in the Tropics, the phase is in general terms opposite to that of sun spots and solar radiation, and hence when these increase the

pressure decreases. This fact is also made very apparent by comparing the individual periods in sun spots with pressure from 1870 to 1920. It is also evident that the amplitude a_1 of the 11-year period is not dominant as in the sun-spot period; but as in the case of solar radiation the subharmonic terms a_2 , a_3 , and a_4 , are almost as large as the primary a_1 .

In order to compare the harmonic terms of the 11 $\frac{1}{4}$ -year period in pressure in equatorial regions with those in other latitudes, the mean pressure was obtained for each 10° of latitude in the northern hemisphere for each year from 1890 to 1913. A period of 23 years was taken because from Hale's observations of magnetism in sun spots the complete period of the sun spots is about 22.6, so that 11.3 years becomes the second harmonic of this period. From the data thus obtained harmonic terms were computed for each zone of latitude and are given in table 9. The phases of the periods varied for

TABLE 9.—Amplitudes of the Harmonics of a 22.6-Year Period in Pressure

Zones of latitude	No. of sta.	a_2 11.3 yr.	a_3 7.54 yr.	a_4 5.65 yr.	a_6 3.77 yr.	a_8 2.83 yr.	a_{24} 11.3 mo.	a_{48} 5.7 mo.	a_{72} 3.8 mo.
70°–80° N.	2	0.60 mb.	0.65 mb.	0.94 mb.	0.92 mb.	1.12 mb.	2.40 mb.	2.50 mb.	3.75 mb.
60°–70°	14	0.59	0.61	0.77	0.88	0.86	2.09	2.78	2.31
50°–60°	21	0.34	0.38	0.46	0.61	0.76	1.32	1.60	1.28
40°–50°	25	0.32	0.42	0.43	0.45	0.51	1.22	1.10	1.23
30°–40°	30	0.24	0.33	0.40	0.31	0.31	0.67	1.02	0.88
20°–30°	13	0.36	0.21	0.29	0.24	0.23	0.62	0.63	0.53
10°–20°	15	0.42	0.25	0.35	0.21	0.33	0.42	0.45	0.40
0°–10°	6	0.36	0.27	0.32	0.25	0.35	0.39	0.25	0.38

NOTE.—In computing the harmonics in Table 9 the means of three or of four periods were used in each case except the case of a_2 where two periods were used. The observed values from which a_2 were computed covered the entire interval of 22.6 years, while the values from which a_{72} were computed covered only one twenty-fourth of this interval.

each latitude as it was evident they must do from the preceding investigation of wave movement. The striking facts brought out are: (1) The amplitudes of the periods increase greatly in high latitudes where they are much greater than in low latitudes and, (2) the amplitudes of the smaller subharmonics in high latitudes are much greater than that of the period of 11.3 years.

This last finding is of the utmost importance to meteorology, because it shows that the shorter periods are of much more importance in the meteorology of high latitudes than the longer periods of 11 years or more. These meteorological and solar periods are all believed to be harmonics of longer solar periods.

Clough found solar periods of 300, 11.3, 7, and 2.5 years, and an analysis of the sun-spot data by Schuster disclosed a number of other

periods besides the 11-year period. Turner found evidences of a period of 260-280 years from a study of tree rings, Nile floods, Chinese earthquakes, and sun spots. (Mon. Not. Roy. Astron. Soc., 1919 and 1920.) According to a recent analysis of the Wolfer sun-spot data made by Dinsmore Alter, published in the Monthly Weather Review of October, 1928, there are solar periods of more than 200 years in length, and the 11-year sun-spot period is a subharmonic of much longer periods. This view agrees with that put forward by Ellsworth Huntington and S. S. Visser in "Climatic Changes," 1922, p. 45. My own investigations are in accord with this view, except that recently the longer periods seems somewhat greater than that given by Alter.

Beginning with a period of 90 years, instead of 84 as given by Alter, I find periods of approximately the following length: *Length of solar periods in years*: 90, 56, 45, 35, 30, 28, 22.5, 18, 15, 12.9, 11 $\frac{1}{4}$, 10, 9, 8.2, 7 $\frac{1}{2}$, etc. All of these shorter periods are subharmonics of 90 years, except 56, 35, and 28, which are harmonics of a longer period.

They agree very well with meteorological cycles found by Prof. A. E. Douglass¹ from rings indicating the annual growth of trees in the southwestern part of the United States where rainfall is the most essential factor in growth. The periods found by Professor Douglass are: 35, 31, 28, 22.5-24.0, 20.5, 17.2, 14.2, 11.2-11.7, 10.2, 8.6, 7.6, 6.8 years.

A study of periodicities in the Nile floods by C. E. P. Brooks² leads him to pick out the following periods in years: 76.8, 64.6-67.4, 39.85, 33.49, 24.43, 21.81-22.43, 18.32, 16.68, 14.87, 12.50, 10.86-11.36, 8.33, 7.33, 6.83, 5.52, 3.66, 2.86. It is pointed out that 11 out of 16 of these periods are multiples or submultiples of a period of 22.12 years. This period is somewhat shorter than Hale's period of 22.6 years; but the difference may be due to the fact that the period actually was shorter during the intervals covered by Brook's data which go back to the year 641. His data indicate a systematic variation in the phase of this period, so that at the end of about 200 years the phase is inverted as regards epochs 200 years earlier.

The researches of D. Brunt³ also indicate that there are a great many meteorological cycles, or else there are none. His periods in years derived from the Greenwich temperatures are: 23, 17.5, 15, 8.17,

¹ Climatic cycles and tree growth, Vol. 2, p. 123. Carnegie Inst. of Washington, 1928.

² Mem. Roy. Meteorol. Soc., Vol. II, No. 12, 1928.

³ Quart. Journ. Roy. Meteorol. Soc., Vol. 53, No. 221, Jan., 1927.

7.34; and in months, 64, 60, 42, 37, 26, 25, $21\frac{1}{3}$, 19.3-19.5, 14.5-14.7, 13, $12\frac{1}{3}$. The researches of Dinsmore Alter¹ published in the *Monthly Weather Review* also bear testimony to the multiplicity of meteorological cycles.

My own researches have dealt largely with shorter periods of days and months rather than years, principally because there was a much larger mass of data available for discussion. In my earlier studies of pressure and temperature data in the United States.² I found the following periods in days: 3, 3.6, 4.6, 5.45, 6.14, 7.24, 9.1, 11, 18, 22, 29, 44, 58, etc. My recent studies indicate that there are many more cycles and that all are probably harmonics of the sun-spot cycle.

A. Defant³ in a world-wide study in 1912 found the following periods in days: 4.4, 7.9-8.7, 12.0-13.0, 16.8, 24.5, 31.2-31.5. Arctowski, Turner, Simpson, Wallén, Myrback, Wasserfall, Schostakowitsch, and Kidson have all found short meteorological cycles of various lengths. Even the short period cycles of a few days are probably submultiples of much longer solar cycles, the most prominent of which is the 11-year sun-spot cycle, or its double value, the 22.5-year cycle.

In most cycles the subharmonics of small length are not important, but it has been shown in table 9 that in high latitudes the subharmonics of the 11-year period in meteorological cycles are of greater amplitude than the primary period of 11 years and that the amplitude increases with decreasing length of the harmonic. The sequence has not been followed through for the entire Northern Hemisphere beyond the period of about four months, but the amplitudes of meteorological cycles at stations in the northern United States and Canada apparently increase down to a length of about three days. These shorter periods determine the origin and movement of the ordinary cyclones and anticyclones seen on the weather map.

Most investigators of meteorological cycles assume at the beginning of their work that any cycle which may exist is constant in amplitude and phase and may by repetition be separated from other changes by which it is masked. This belief is the basic assumption underlying the analysis by the Fourier series or the Schuster periodogram. Prolonged investigation usually convinces the research worker that this assumption cannot be maintained. I early became

¹ *Monthly Weather Review*, Vol. 54, p. 44, and Vol. 55, pp. 60 and 263.

² *Amer. Meteorol. Journ.*, Feb., 1895, p. 376; also *Amer. Journ. Sci.*, March, 1894.

³ *Sitzungsberichte d. Wiener Akad.*, Bd. 121, Heft 3.

convinced that meteorological cycles change both in amplitude and phase. (Science, 1898, p. 243.)

Figure 23 shows an analysis of the Wolfer sun-spot numbers between 1890 and 1913 into a period of 22.6 years and its harmonics. It is seen that the chief period is one of 11.3 years, but some of the other periods show a fairly large amplitude of oscillation.

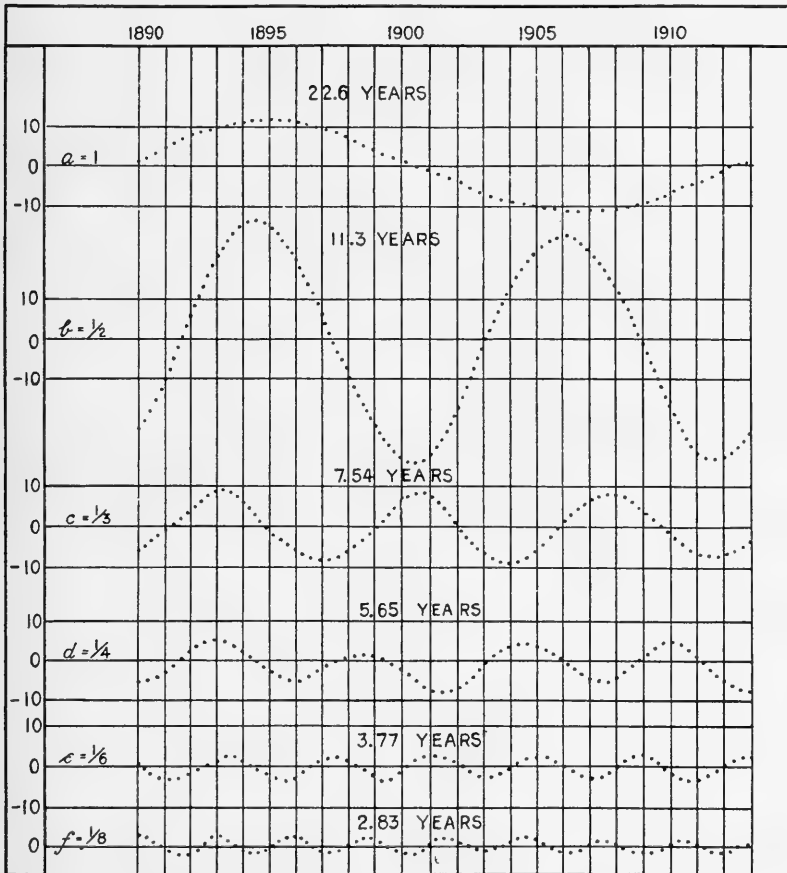

FIG. 23.—Harmonic analysis of 22.6-year sun-spot period, 1890-1913.

The meteorological data at more than a hundred stations in various parts of the world were analyzed in the same manner. Figures 24, 25, 26, and 27 show lines of equal departure of pressure for the various periods at the time of maxima of the solar periods of the same length. A chart showing the departures at the time of the solar maxima of the 7.5 year period is given in figure 17.

Certain common features stand out clearly in all these charts. First, in the equatorial belt, except possibly over parts of the Pacific Ocean, the pressure is lower than normal at the time of maximum

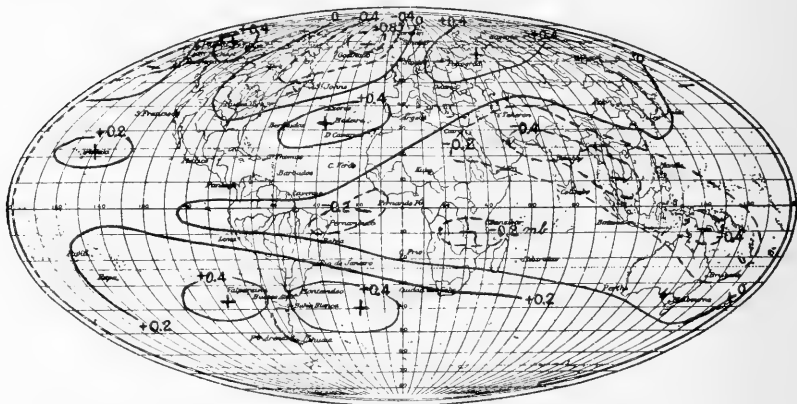

FIG. 24.—11.3-year period in pressure = $\frac{1}{2}$ of 22.6 years. Departures at time of maximum of solar period of same length.

solar activity in each period. Second, in middle latitudes of the Southern Hemisphere there is a tendency to a belt of pressure above normal which cannot be well outlined on account of insufficient

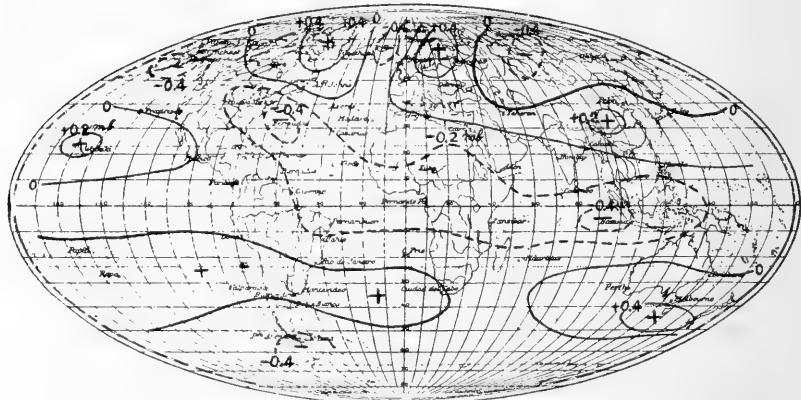

FIG. 25.—5.65-period in pressure = $\frac{1}{4}$ of 22.6 years. Departures at time of maximum of solar period of same length.

observations. Third, in the Northern Hemisphere in high latitudes there is a tendency for the departures to form centers of positive and negative departures, usually two centers of positive departure, and

two centers of negative departure. Fourth, these centers are not in the same geographical position for the different periods and do not remain fixed for successive epochs of the same period. The reasons

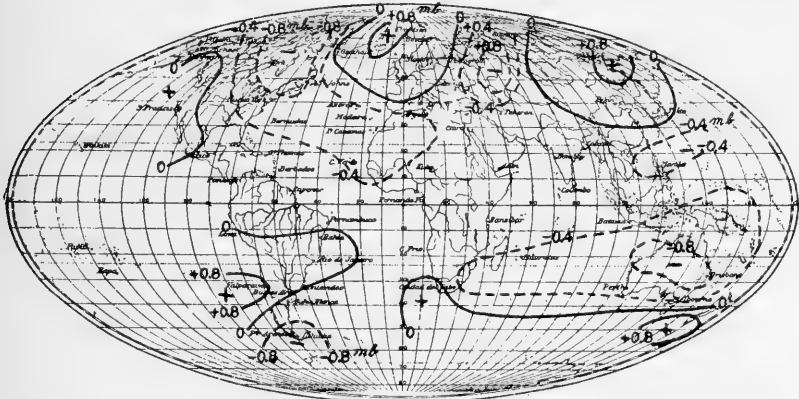

FIG. 26.—3.77-year period in pressure = $\frac{1}{6}$ of 22.6 years. Departures at time of maxima of solar period of same length.

for these shifting centers are not clear. They are associated with changes in the phase and amplitude of the cycles.

Changes in amplitude are both apparent and real. Apparent changes occur where two periods of nearly the same length first

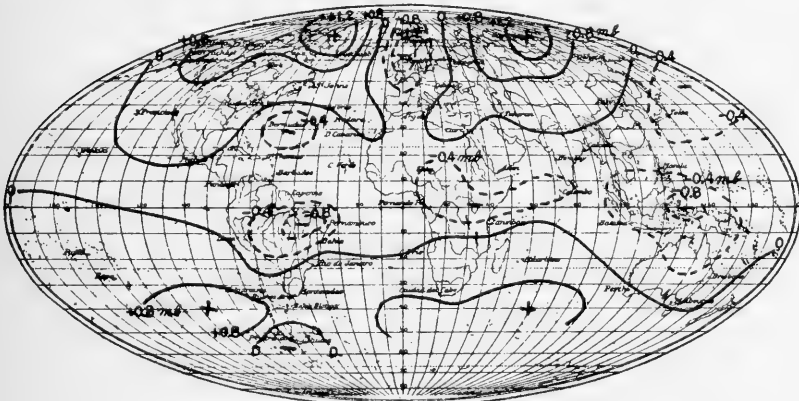

FIG. 27.—2.82-year period in pressure = $\frac{1}{8}$ of 22.6 years. Departures at time of maxima of solar period of same length.

strengthen each other when they are in the same phase and then weaken each other when they are opposed in phase. This change will be familiar to most readers from diagrams to illustrate beats in sound

waves. The beats are even more complicated when there are three or more periods of nearly the same length. In such a case there may be an apparent change of phase in one of the periods.

Real changes in amplitude are brought about by the influence of longer periods on shorter periods. An example of this is the influence of the annual period on shorter weather cycles. All weather changes are most intense in winter, because then the contrasts in temperature between Equator and pole, between ocean and continent, and between adjacent bodies of land and water are at a maximum intensity and the general atmospheric circulation is increased.

Also all periodic changes in the atmosphere are more intense when solar activity increases. The reason for this increased intensity will be clear, first from the fact shown in the early part of this paper that increased contrasts of temperature and pressure in the atmosphere result from increased solar activity, and second from the fact that the amplitude of the solar cycles increases with increased solar activity.

An example of the increased amplitude of solar periods with increased solar activity is shown in figure 22 where the amplitudes of the 7.5-year sun-spot period is distinctly greater during the interval 1865 to 1875, when the general level of solar activity was higher, than during the interval 1885 to 1895, when it was lower. The increase of amplitude during the first of these intervals and decrease during the second was also evident in the sun-spot cycle and in its harmonics of 5.65, 3.75, 2.82 years, etc.

An example of increased amplitude of meteorological cycles with increased solar activity is shown in figure 28 where a period of $7\frac{1}{2}$ months in pressure at Chicago shows a marked increase in amplitude at the time of maximum of sun spots in 1917 and a diminished amplitude during the intervals of minima of sun spots in 1913 and 1923-1924. The data for this curve are the means of 10 overlapping periods of $7\frac{1}{2}$ months obtained in the manner indicated in table 6. The dotted curves are sine values computed for each individual period.

That meteorological cycles change in phase as well as in intensity is also evident. These changes of phase appear to arise from several different causes. First, the solar periods themselves change phase. In most cases this change occurs suddenly and appears to be about 180°

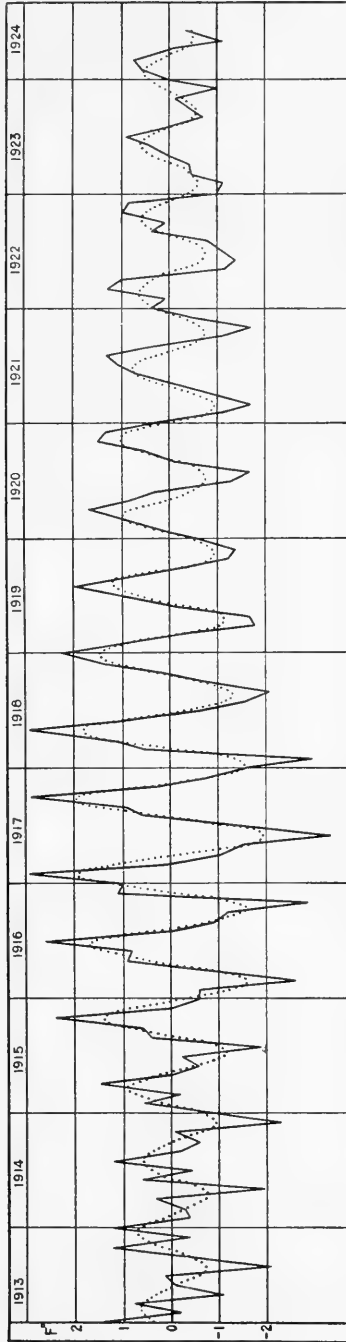

FIG. 28.— $28\frac{1}{2}$ -months period in temperature in Chicago (showing increase of amplitude near sun-spot maximum).

or a complete reversal in phase. Figure 29 shows what appears to be a reversal in phase in the sun-spot cycle. The average length of this cycle is about 11 years, so that two cycles occur in 22.5 years. If the cycles are plotted in 22-year periods as in figure 29 it is seen that in the period 1770 to 1792 the cycle is nearly inverted in phase to the cycles occurring 22 years earlier and 22 years later. It is, however, quite possible that this result is due either to interference of periods of different lengths, or to lack of accuracy in the early observations. No such apparent inversion has occurred since 1800.

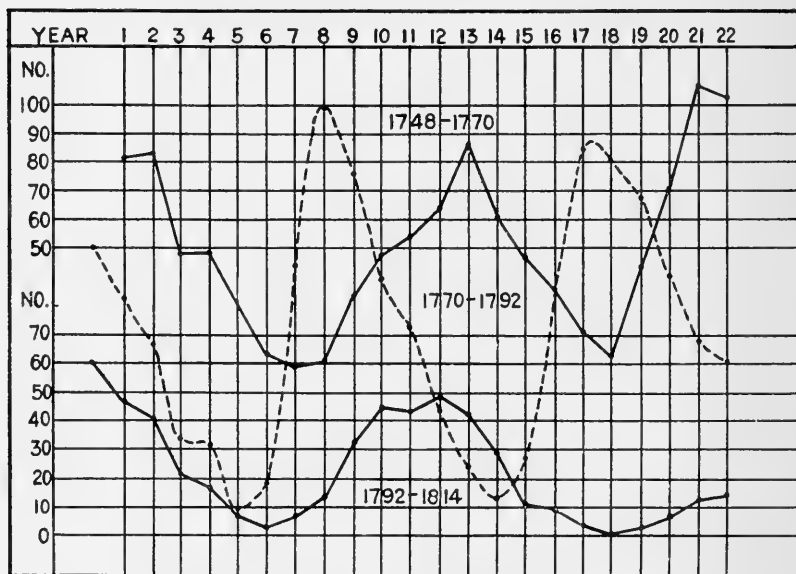

FIG. 29.—11-year sun-spot cycle, showing apparent inversion of phase.

In figure 30 is given what appears to be a reversal of phase in the $7\frac{1}{2}$ -year period. This cycle was in one phase from 1848 to 1870, as shown by the broken curve in figure 30, but appears to have been in an opposite phase from 1825 to 1847, as will be seen by the continuous curve in figure 30. This type of change is found in every solar and meteorological period. Brooks and Clough seem to think that shiftings of phase are gradual; but my own researches lead me to the opinion of Professor H. H. Turner that the changes are sudden and of the nature of discontinuities.

The change of phase in meteorological cycles is not brought about entirely by changes in phase of solar cycles; but is in part, at least, due to shifting of centers of action in the atmosphere. In the case

of pressure, when it rises in one part of the world, there is an equivalent fall in other parts. These centers of rise and fall are not fixed in position, but shift their position to some extent as illustrated in the case of a 25-month period in a preceding paper of this series.¹

The variations in intensity and phase of solar and meteorological cycles makes the investigations of the separate cycles difficult. The use of the Fourier series and of the Schuster periodogram are not well adapted to such work. In order to meet these difficulties I devised the correlation periodogram² which is to a considerable extent independent of variations in intensity of the periods; but does not overcome the difficulty of shifting of phase. The best

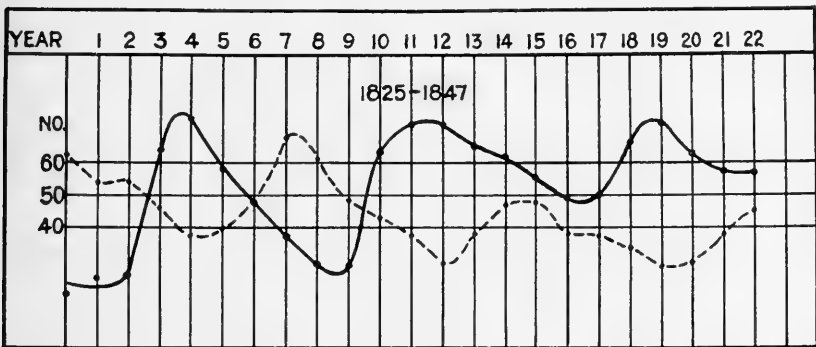

FIG. 30.—7½-year sun-spot cycle. Means of 3 cycles, showing apparent inversion.

method appears to be to use trial periods of successively greater and greater length and harmonic analysis for each individual oscillation³; then to combine the results for each period into groups of 3, 5, 10 or more. By this method the curve in figure 28 was obtained. This method of research, using groups of 10, has made it possible to analyze and to follow the changes of a great number of meteorological periods and to recombine them by synthesis for a trial in practical forecasting. Such analyses of more than 100 cycles have convinced me that these cycles follow solar cycles of the same length and that they are, mostly at least, harmonics of long solar cycles.

¹ Smithsonian Misc. Coll., Vol. 78, No. 4, p. 48, 1926.

² Smithsonian Misc. Coll., Vol. 71, No. 3, p. 15, 1920.

³ Clayton, H. H., World Weather, p. 376, New York, Macmillan & Co., 1923.

VII. THE USE OF WEATHER CYCLES IN FORECASTING

Having developed methods of separating and studying various conditions which make up the weather, it seemed important that a test be made of the possibility of using them in practical forecasting. Forecasting future weather conditions in the present state of knowledge may be undertaken in at least three different ways: (1) By tracing out the results which follow the increase or decrease in the general circulation of the air with changes in solar activity. (2) By analyzing and following weather waves of different classes. (3) By computing the amplitudes and phases of different cycles found in solar and weather changes and projecting these forward into the future.

In regard to the use of the first method, since increased solar activity is attended by a fall of pressure in equatorial regions and by increased contrasts of pressure in higher latitudes, there is brought about an increased atmospheric circulation and certain general conditions follow:

(1) The cloudy and clear belts of the world are intensified and thus alter the incoming and outgoing radiation.

(2) The increased air circulation means an increased flow of ocean waters which brings an increased northward flow of warm water along the east coast of the United States and Japan and an accumulation of warmer water in the North Atlantic and North Pacific. The accumulation of warmer waters in these regions especially in autumn brings increased cloudiness and increased rainfall. The increased cloudiness reacts by diminishing radiation losses from the earth and thus further modifying weather conditions. On the other hand the increased oceanic circulation brings increased cold water to the shores of North Africa and southern California, and produces a chain of atmospheric conditions which affect the northern shores of South America and the West Indies and extend well out into the Pacific. A parallel set of changes is produced in the Southern Hemisphere in an opposite way on the east and west sides of the continents. When solar activity diminishes the reverse conditions prevail.

(3) Increased solar activity brings also an increased flow of air over the continents and with it an increased rainfall in certain regions and a decreased rainfall in other regions. The distribution of pressure and attendant conditions is to a large degree influenced by the seasons.

Hence, to follow the sequences of weather resulting from increased solar activity it is necessary to consider the month or seasons separately and to work out expected conditions for different intensities of solar activity.

In regard to the use of the second method, forecasting weather as ordinarily practiced at the present time depends on anticipating for a day or two at a time the drift of weather conditions. Such forecasts can be improved and extended in time by analyzing weather into waves of different lengths and forecasting the progress of the stronger waves. Even long range forecasts can be made on this basis, as I have demonstrated by actual tests.

The third method of forecasting is by means of the periodic vibrations in the sun and atmosphere. Any pulsation in solar condition will be attended by similar pulsations in the earth's atmosphere. The shorter pulsations will be felt relatively more in high latitudes of the earth and the longer pulsations relatively more at low latitudes, but all will be repeated to some extent in every part of the atmosphere. An analysis of the periodic terms in the weather at any point on the earth would make it possible to project the periodic terms ahead to any length of time desired, were there no variations in the amplitude and phase of the periods. But there are variations and for this reason it is necessary to redetermine the periodic terms at short intervals and to limit the time in advance which they are made to cover. When these variations in the periodic terms become calculable, this method of forecasting will probably replace all others. Already considerable progress has been made along this line.

In practical forecasting at present it is desirable to consider all of the three methods mentioned and to use them as checks on each other. Forecasting in words has but little meaning to the average expert, because the meanings of words can be interpreted in various senses and there are no accepted rules for verifying such cases. Quantitative forecasts can, however, be verified by accepted standards; so that from the beginning of my experiments in forecasting, both verbal and quantitative forecasts were made. These quantitative forecasts were made first for about a week in advance, then for longer intervals up to a month. Figure 31 gives one of the more recent of these forecasts of pressure made on November 24, 1929, for 27 days in advance beginning on November 26 and ending on December 21. The forecast was made up from a combination of cycles varying in length from 3 days to 13 days. The correlation of the forecasted with the observed pressure is 0.64 ± 0.06 .

By computing pressure in this way for a network of stations, weather maps bearing unmistakable resemblance to observed weather maps may be computed in advance. In March, 1929, values of pressure were computed for one week in advance for 23 selected stations forming a net over the United States and from these computed values lines of equal pressure departures were drawn. The maps

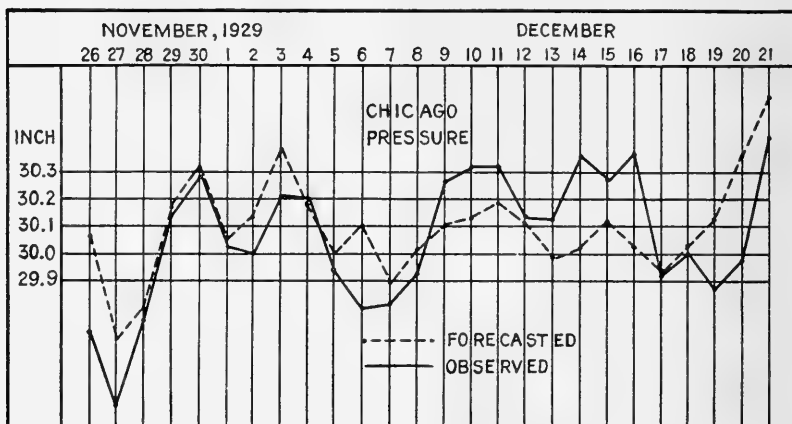

FIG. 31.—8 a. m. pressure.

thus forecasted are compared with the observed pressure distribution in figure 32. The close resemblance of the two sets of maps is apparent. This degree of accuracy can be obtained, however, only when the meteorological cycles are comparatively steady. It is nevertheless the goal toward which research is leading and to which it will undoubtedly attain.

In April, 1929, a diagram was sent to a number of persons, including the Secretary of the Smithsonian Institution, giving a forecast of departures from normal temperature by weeks from April 2 to September 3 for New York City and for two other stations. Figure 33 gives a copy of this plot for New York City. The broken curve shows the forecast and the continuous curve shows the observed departures from normal. The correlation coefficient for the 23 weeks is 0.37 ± 0.12 . This correlation taken alone is inconclusive as to the possibility of such forecasts, except in the light of other data indicating its possibility. It is believed that forecasts by months and years are feasible on the same basis and by the same methods, but no prolonged test is yet available.

If the conclusions presented in this paper are verified and accepted by other research workers, as I feel they must be in time, it will

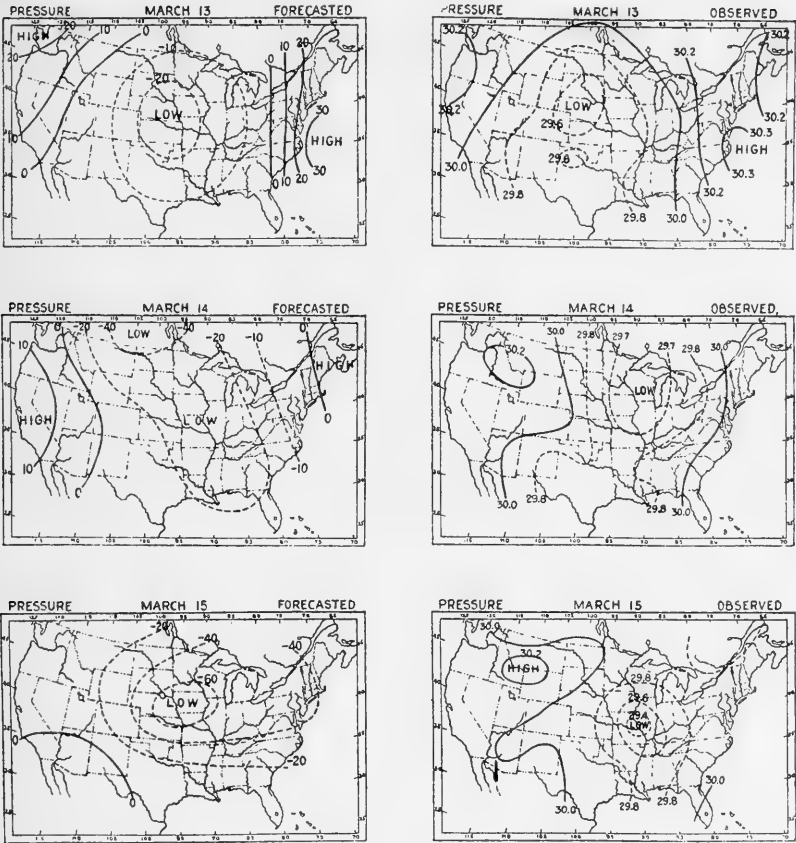

FIG. 32.—Pressure forecasted from a combination of meteorological cycles.

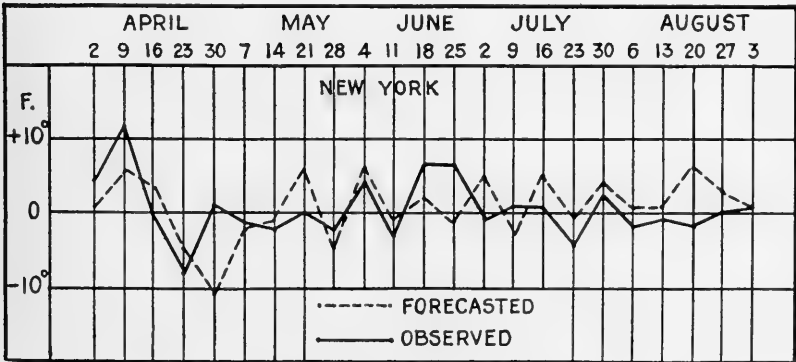

FIG. 33.—Weekly temperatures 1920.

mean a revolution in present methods of weather forecasting. The forecasting of pressure and temperature will be made in much the same way that ocean tides are now predicted, except that the periods used will be solar periods rather than lunar periods and will need to be treated in a special way owing to changes in phase and amplitude.

Such a successful forecast as that shown in figure 31 seems conclusive evidence that day to day weather is not a haphazard occurrence as many persons believe, but is subject to calculation. It is evident that changes of pressure are calculable to some extent now, and the calculations will, no doubt, in the future be made with increasing accuracy for weeks and perhaps months in advance. Processes will be simplified and machinery like the tidal machines will be introduced in order to handle the immense amount of data which will be needed for world-wide forecasts, or even for forecasts over a large area like the United States.

SUMMARY

This paper contains evidence pointing to the following conclusions: Solar activity varies in complicated pulses. These pulses or variations in intensity are attended by variations of pressure in the earth's atmosphere. When solar activity, as indicated by spots and radiation values, increases, the latitude contrasts of pressure in the earth's atmosphere are increased and atmospheric circulation speeded up. The pressure falls in the equatorial belt, rises in middle latitudes and falls in the polar regions. When solar activity decreases the reverse conditions occur. The zonal regularity of these changes is interfered with by the distribution of land and water and by seasonal changes.

Immediately following the decrease of pressure in the polar region with increased solar activity, a wave of decreased pressure moves toward the Equator. With decreased solar activity the pressure in polar latitudes increases and a wave of increased pressure travels towards the Equator. These waves move with a speed proportional to the length of the solar pulse or period causing them. If the period of oscillation is seven days the wave moves from pole to Equator, when measured along a meridian, in seven days. If the length of the oscillation is 27 months, or $2\frac{1}{4}$ years, the time of the wave movement from pole to Equator is 27 months and if the length of the period is $7\frac{1}{2}$ years the time of movement from pole to Equator is $7\frac{1}{2}$ years, or one period of oscillation in each case.

There are also east to west movements of the waves, and there are probably returning waves toward the poles of less intensity; so that the observed phenomena are extremely complex. The analyzed wave movements are subject however to apparently simple laws, and can, therefore, probably be computed and combined to produce observed conditions.

The observed data of sun-spot numbers and solar radiation values when subjected to harmonic analysis for the 11-year period 1917 to 1928 show that the dominating period of about 11 years in sun spots is no more marked in solar radiation values than the subharmonics of $\frac{1}{2}$, $\frac{1}{3}$, $\frac{1}{4}$, etc., of the 11-year period which have amplitudes nearly as large as the 11-year period itself.

When the pressure observations in the Tropics are subjected to harmonic analysis they show periods resembling in amplitude those of solar radiation values and not those of sun spots. The analyses of the data in higher latitudes show that the amplitudes of the subharmonics increase with latitude, so that in high latitudes in the neighborhood of the pole the subharmonics become vastly more important than the primary period.

A study of the possibility of analyzing the data at each particular part of the earth with the view to discovering fixed periodic cycles indicates that if such cycles exist, the amplitudes are subject to wide variations and even to inversion of phase from time to time. However, when the complex cycles are analyzed individually and averages taken for a small number of successive cycles, it is possible to project them into the future and combine and plot them in a curve which at times has a striking resemblance to observed data. As knowledge of methods and laws of change progress, this kind of forecasting will undoubtedly be done with increasing accuracy.



SMITHSONIAN MISCELLANEOUS COLLECTIONS

VOLUME 82, NUMBER 8

FOUR NEW RACCOONS FROM THE KEYS
OF SOUTHERN FLORIDA

(WITH FIVE PLATES)

BY

E. W. NELSON



(PUBLICATION 3066)

CITY OF WASHINGTON

PUBLISHED BY THE SMITHSONIAN INSTITUTION

JULY 10, 1930



SMITHSONIAN MISCELLANEOUS COLLECTIONS

VOLUME 82, NUMBER 8

FOUR NEW RACCOONS FROM THE KEYS OF SOUTHERN FLORIDA

(WITH FIVE PLATES)

BY

E. W. NELSON



(PUBLICATION 3066)

CITY OF WASHINGTON
PUBLISHED BY THE SMITHSONIAN INSTITUTION
JULY 10, 1930

The Lord Baltimore Press
BALTIMORE, MD., U. S. A.

FOUR NEW RACCOONS FROM THE KEYS OF SOUTHERN FLORIDA

By E. W. NELSON

(WITH FIVE PLATES)

Between the last of February and late in March, 1930, the author visited the keys lying about the southern end of Florida and collected on them a series of 61 specimens of raccoons. The keys, or islands, visited proved to be segregated into four rather well-defined groups and the specimens collected show very definitely that each group is occupied by a subspecies of *Procyon lotor* peculiar to it, and all differing from *Procyon lotor elucus* of the neighboring mainland.

The main islands of each group are named below but, in addition, each group includes many smaller islets practically all of which are covered with mangroves.

1st. Ten Thousand Islands Group forms a broad compact belt of mangrove keys lying for about 100 miles along the southwestern coast of the peninsula, from a little south of Naples down to Shark River. The width of this belt varies from one to several miles, its exact width and some other details not being as accurate as desirable in published maps I have seen.

2d. Key Largo Group, as here considered, lies along the southeastern border of the peninsula and includes Virginia and Biscayne Keys just north of the entrance to Biscayne Bay, and Elliott Key, Key Largo, Plantation Key with Upper and Lower Matecumbe Keys to the south of the entrance.

3d. Key Vaca Group lies southwesterly from the preceding group and begins with Long Key on the north and extends south to include Duck, Grassy, and Fat Deer Keys, Key Vaca, and Knights Key.

4th. Big Pine Key Group still farther to the southwest includes No Name, Big and Little Pine Keys, Torch Keys, Ramrod, Cudjoe, Summerland, Saddlebunch, and Boca Chica Keys, and Key West.

The isolation of raccoons of the *Procyon lotor* type in islands on the Atlantic coast side of the continent from Cozumel Island, off the peninsula of Yucatan, to the Bahamas and the coast of southern Florida, has tended toward the production of depauperate forms as all of them are smaller than the animals of the adjacent mainland. On the Pacific side of the continent the raccoons of the Tres Marias

Islands are about the same size as the animals of the neighboring Mexican mainland. These islands are high and wooded and fresh water occurs on them.

Conditions are such, on practically all of the keys off the coast of southern Florida, that the raccoons living on them have no access to fresh water beyond the fortuitous opportunities that may occur during a heavy rain. To this circumstance, many of the local trappers believe, is due the smaller size of the animals of the islands, for they say the larger, better furred animal of the mainland occurs where permanent fresh water exists back from the shore. Along the southwestern shore of the peninsula these large fresh water "coons" are said usually to keep about the fresh water but to come down to the mangrove swamps along shore at certain seasons. The trappers agreed, however, that they never cross to the adjacent keys, even in the Ten Thousand Islands, some of which have only narrow, shallow channels cutting them off from shore.

In addition to their tendency to reduction in size the Key raccoons have a distinct tendency toward duller and paler colors than the animals of the mainland. The paleness is especially marked in the forms from the Key Vaca and Big Pine Key Groups.

The abundance of crabs, shellfish and other food provided by the sea for the raccoons, would appear to remove the possible factor of food shortage from the list of possible causes for the smaller size among these animals. At the same time the absence of natural enemies evidently gives favorable conditions for their increase and the accounts given me of the amazing number of them trapped on the keys, when the high prices of furs gave the incentive, make it apparent that they must have been excessively numerous for an animal of their size. Under natural conditions in the past, therefore, competition for food may have been very strenuous for long periods.

On the Ten Thousand Islands some of the trappers told me that when the high prices for fur began single trappers sometimes took the skins of more than 800 raccoons on the keys in a season but that, owing to this severe trapping, it is difficult now for a man to get even one-third of that number. Similar accounts of the former abundance of raccoons on other keys off the coast were given me by trappers elsewhere. Some of the trappers put out more than 100 traps and settings of from 40 to 60 are common. The total catch of raccoons for southern Florida and the keys must be very large.

The measurements and weights in the flesh of the series collected by me gave direct evidence that the female raccoons of that region, in the flesh, weigh more than 20 per cent less than the males, and

the more smoothly rounded, smaller skulls of the females give the same evidence. Measurements, weights, and skulls of the series collected by Dr. E. A. Mearns in Polk County, the type region of *P. l. elucus*, show similar size differences between the sexes of that form.

The study of my series of specimens and comparisons with a large number of specimens of *Procyon lotor elucus* from the Florida mainland and of representatives of *P. maynardi* and *P. minor* from the Bahamas makes it appear that a natural laboratory of evolution is obviously at work on the Florida Keys with the generally distributed and abundant raccoons as, at least, one of the principal subjects.

It is a pleasure to acknowledge my indebtedness to Dr. Thomas Barbour and to Mr. H. E. Anthony for the use of material under their charge in the Museum of Comparative Zoology and the American Museum of Natural History, respectively.

THE RACCOON OF THE TEN THOUSAND ISLANDS

More than two years ago a friend told me that a raccoon smaller than that of the mainland was reported to exist on the chain of keys bordering the southwest coast of Florida, known as the "Ten Thousand Islands." This suggestive information was kept in mind and the last of February, 1930, I arrived at Fort Myers, on my way to investigate the rumor. Being delayed there for a day I located a fur buyer and in reply to my inquiries he promptly confirmed the truth of the statement which had caused my quest. He said that a very small, rather pale colored, raccoon is well known to the trappers and fur buyers of this region, where it occupies the islands, or "keys" along the coast. He added that owing to its small size and the inferior quality of its fur "key coon" skins bring only about one-half to two-thirds the price paid for the larger, better furred skins from the mainland. The trader then produced about 30 "key coon" skins from Marco Island, which he had recently purchased, and I was delighted to note their distinctive peculiarities.

The next morning I proceeded by rail to Marco Island, one of the larger of the Ten Thousand Islands, near the northern end of the group. It is several miles in both length and breadth and is bordered by a belt of mangrove swamp where the raccoons live. The interior is sandy, several feet above high tide mark, and covered with a thin forest of scrubby, slender pines with scattered undergrowth.

Soon after my arrival I found resident trappers who agreed that "key coons" were common on the island, but that those found on the keys near Chokoloskee Bay farther south were the smallest of all.

Desiring to secure the most marked expression of this scientifically unknown form, I left Marco Island at once and proceeded by auto-stage to the town of Everglades, located about the middle of the east side of Chokoloskee Bay.

The next morning I went to the fishing village of Chokoloskee, near the southern end of the bay, where a trapper with a small motor boat was employed and at the expiration of about ten days we had a series of 16 specimens, all taken on the small mangrove keys lying between Chokoloskee Bay and the open waters of the Gulf of Mexico. The delay in getting these animals was due to the fact that I had arrived at the end of the trapping season and the number left was comparatively small.

Previously I had always thought of raccoons as animals dependent on available fresh water and it surprised me to find them living in great numbers among the mangrove islands, both in the Ten Thousand Islands and on other Florida keys, without any possible source of such water. Their food consisted of an abundant supply of fish, crustaceans, and shellfish left exposed on the mud at each low tide.

The haunts of the raccoons among the mangrove roots of the Ten Thousand Islands were shared by great numbers of roof rats (*Rattus rattus alexandrinus*). These were so numerous that they interfered with our success in trapping the raccoons, dozens of them being caught. Another interference was the frequency with which fish and crabs ate the bait above the traps while they were submerged during high tide. As a result of these marine visitants the traps sometimes capture curious prey. Several kinds of fish and crabs, in wallowing about when tugging at the bait, now and then spring the trap and are caught. My trapper said that on one occasion he caught a small shark about 18 inches long. His method of trapping, which he informed me was the regular practice among these keys, was to make a little U-shaped enclosure by sticking pieces of dead mangrove roots into the mud in a small opening among the mangrove roots at the head of small bay-like indentations of the shore line, where the animals patrolling the bare mud at low tide would find it on their way from point to point. A piece of fish for bait was impaled on a small stick, the other end being stuck in the mud at the inner part of the enclosure. The steel trap was then set on the bare mud at the entrance of the enclosure guarding the bait, without the slightest effort to conceal it—a stick thrust through the ring at the end of the chain and deep in the mud serving to hold any animal caught (see pl. 1, fig. 2).

At high tide this trap would be more than two feet under water. Trapping among these keys is practically all done by using small boats with outboard motors, or small gasoline engines.

The common name for this group well indicates the great number of little keys of which it is formed. They are closely grouped and of most irregular outlines, being separated from one another, and from the mainland, by a network of tortuous, shallow tide channels varying in width from a few yards to several hundred yards. Enclosed within this mass lie Chokoloskee and other narrow land locked bays. Chokoloskee Bay is the largest, having a length of about eight miles and a width of from a half mile to a mile and a half. Nearly all the keys of the group, like those where we trapped the raccoons, are overgrown with tangled masses of the aerial roots of the red mangrove above which rises the low wall of their dense, green tops.

These keys, in general, are covered with from one to about three feet of salt water at the daily high tide and are devoid of fresh water. The Ten Thousand Islands form, in fact, a great mangrove swamp based mainly on the flat tops of old oyster beds. The red mangrove thickets rise about 25 feet and are interspersed with larger black mangroves and a few other salt loving small trees or bushes. In the Shark River section, to the south, the mangroves are the largest I have ever seen, forming closely set forests of trees 40 to more than 60 feet high. The mainland adjacent to these keys is bordered by a fringe of mangrove swamps limited by the end of salt water. The accompanying photograph gives an idea of the typical water front of the mangrove islets near Chokoloskee (see pl. 1, fig. 1).

I have included the mangrove keys of the Shark River area within the range of the small Chokoloskee raccoon wholly on statements of several trappers that the raccoons there are the same as those about Chokoloskee Bay. No specimens have been seen from there but several from the mainland a few miles away at Cape Sable and Flamingo are unmistakably *P. l. elucus*.

RACCOONS AND THE FLORIDA KEYS

After observing the effect of environment on the raccoons of the "Ten Thousand Islands" it appeared probable that similar influences may have produced modifications of the animals living on the great series of islands or "keys" extending from Biscayne Bay to Key West, commonly known as the Florida Keys. To determine the facts concerning this I crossed the Everglades, over the motor highway, from the town of Everglades to Miami. There, through the friendly assistance of Mr. E. J. Brown, some trappers were promptly located who were well acquainted with all the keys. The information they gave confirmed my belief that the raccoons there would differ from those of the mainland. Two trappers were employed as field assistants

and by the use of motor boats and an automobile we made a rapid reconnaissance of the entire chain of keys to Key West. Raccoons occur abundantly on all the keys and we obtained a sufficient series to indicate their characteristics. As at the Ten Thousand Islands this work was done soon after the close of the regular trapping season, during which thousands of raccoons had been caught, so that much more time was required to capture the animals needed than would have been necessary earlier in the year.

These keys are connected by the Over-Seas Railway from Miami uniting them by fills where the channels are narrow and shallow and by cement viaducts and bridges where they are more broadly and deeply separated. In recent years the Over-Seas motor highway has been constructed parallel to the railway from Miami, striking the middle of Key Largo and extending thence down the keys to the southern point of Lower Matecumbe, whence a ferry carries passengers and motor cars across about 40 miles of water to the northern end of No Name Key. There the motor road begins again and continues southward crossing various keys to Key West. In addition to the railway fills which unite some of the keys in this chain, other fills made for the highway broaden the land bridge made by the railway embankments uniting a number of keys, thus destroying their individuality.

About midway in the 40-mile gap between the northern and southern groups of keys lies a smaller group, the main one of which is Key Vaca. A practically disused motor highway, extending north and south about 12 miles, joins the main keys of this group except Long Key which lies isolated by sea channels nearly midway between Key Vaca and Lower Matecumbe. As shown below, the raccoons living on each of these natural groups of keys, the northern, the middle, and the southern, has its local subspecies.

The Florida Keys differ very much in formation and vegetation from the Ten Thousand Islands. Most of these keys, except the more recent small ones, are of limestone with nearly level surfaces, elevated well above tide water, with borders of varying width of mangrove swamp which are covered at high tide. Back of the tidal area on the Key Largo and Key Vaca Groups is a strong growth of deciduous tropical shrubs and trees often forming a dense and almost impenetrable jungle, from 15 to 30 feet high, where it has not been destroyed by man. The northern half of Key Largo has the heaviest forest growth I saw on the keys, rising to 50 or 75 feet high, or perhaps more, in places. The trees appear to be the same species as those elsewhere but grow on a better soil.

The western, or Gulf, shores of all the large keys are bordered by a practically continuous fringe of mangrove swamp but on the Atlantic side occur sandy beaches often bordered by irregular series of coconut palms, while scattered fan palms, often with trunks ten to more than 25 feet long, are generally distributed in the interior.

A large part of Big Pine Key is covered with a thin growth of slender dwarfed pines and palmettos with scattered areas of deciduous trees and bushes. The neighboring Little Pine, No Name, Torch, and Ramrod Keys have smaller areas of pine forest. The interior of the other keys to Key West have the deciduous species common to the entire chain of keys, with the usual marginal mangrove swamps and occasional sand beaches.

The trappers informed me that the raccoons of the Florida Keys go back inland from the mangrove swamps, where they generally live, to feed on any ripening fruit that occurs. At the time of my visit to Key Largo, a shrub about three feet high was laden with clusters of dark fruit appearing, in color and shape, like huckleberries. Raccoons were feeding extensively on it.

PROCYON LOTOR MARINUS subsp. nov.

Chokoloskee Raccoon

Type.—From near Chokoloskee, Florida. No. 254989, ♂ adult, U. S. National Museum, collected by E. W. Nelson, February 28, 1930.

General characters.—A very small subspecies, the largest old male in the series taken weighing 8 pounds. Duller grayish than *P. l. elucus*, of adjacent mainland, with skull much smaller, more depressed on frontal area and molariform teeth proportionately much heavier.

Color.—Not very different from typical *elucus* but averaging duller, more grayish on upperparts owing to smaller amount of black tips to overlying hairs; rusty buffy nape patch averaging less strongly marked, often obsolescent; light rings on tail paler, less buffy yellowish; black mask more restricted with remainder of top and sides of head paler. No indication of the generally rusty or dark buffy suffusion covering entire upperparts frequently present, and sometimes strongly marked, in specimens of *elucus* from the type region.

Skull.—Much smaller and more delicately proportioned than in *elucus*; frontal area much more depressed, braincase more rounded; last upper premolar and carnassial relatively, and sometimes actually, larger; palatal shelf about the same.

Measurements.—*Type*: Total length, 665 mm.; tail vertebrae, 222; hind foot, 105. *Skull* (type): Greatest length, 105.9; condylo-basal length, 101.8; zygomatic breadth, 64.8; interorbital breadth, 22.3; least width of palatal shelf (between last molar and interpterygoid fossa), 13.9; upper canine-molariform tooth row (alveolar length), 40; weight of type in flesh, 7 pounds. See page 12 for tables of measurements and weights.

Remarks.—This is one of the smaller subspecies of raccoons that have developed on the keys about the southern end of the peninsula of Florida, not differing much in size from the form on the Key Vaca Group. It appears to be limited to the great mass of mangrove covered or bordered islands, or keys, known as the "Ten Thousand Islands" where they exist in great numbers. Most of these islets are completely covered by the sea to a depth of from about one to three feet at each high tide, and are totally devoid of fresh water. As most of these keys have no large trees to afford hollows and no dry land the raccoons must make their homes on top of the mangrove roots where they are forced to retreat by the incoming tide.

Specimens examined.—17: from type locality, 16; from Ten Thousand Islands (exact locality unknown), 1.

PROCYON LOTOR INESPERATUS subsp. nov.

Matecumbe Raccoon

Type.—From Upper Matecumbe Key, Florida. No. 255037, ♂ adult, U. S. National Museum, collected by E. W. Nelson, March 19, 1930.

General characters.—In weight and color resembling typical *P. l. elucus* of adjacent mainland but both body and skull measurements smaller, especially length of hind foot; frontal area of skull much more depressed.

Color.—Much as in typical *elucus*, strongly washed with black on upperparts and well marked nuchal patch of dark rusty or buffy, dark rings on tail well marked and light rings often strongly buffy.

Skull.—Differs from that of *elucus* in smaller size and marked depression of frontal area. From *P. l. marinus* skull may be distinguished by its much larger size, more massive proportions and smaller molariform teeth.

Measurements.—*Type*: Total length, 730 mm.; tail vertebrae, 250; hind foot, 115. *Skull* (type): Greatest length, 110.4; condylo-basal length, 108.1; zygomatic breadth, 68.2; interorbital breadth, 23.1; least width palatal shelf, 15.2; upper canine-molariform tooth row, 41. Weight of type in the flesh, 8.5 pounds. See page 12 for tables of measurements.

Remarks.—The present subspecies occupies the group of keys beginning with Virginia and Biscayne Keys on the north side of the entrance to Biscayne Bay and ranges south to the southern point of Lower Matecumbe Key. Key Largo, the median island, is by far the largest of this group and broad mangrove swamps bordering its western side extend out, about the middle of its length, until only a comparatively narrow channel separates them from the similar swamps which extend eastward from the mainland, at the south end of Biscayne Bay. The railroad and motor highway fills, and viaducts extend across these swamps, from Miami to the middle of Key Largo on their way down the keys to Key West.

The comparatively short distance separating the raccoons living on these keys from those of the adjacent mainland, with the size and color of the island animals, made me doubt any strong differentiation when I was collecting them. Fortunately I was able to secure two good males and a female on the adjacent shore of the mainland to determine the question. The skulls of these specimens are typical *P. l. elucus*, with characteristic high arched frontal areas from which all the skulls of the series from the various keys of this group may at once be distinguished by their appreciable smaller size and more flattened frontals.

The largest male taken on Key Largo weighed 12 pounds in the flesh, the same as old males collected and weighed by Dr. E. A. Mearns in Polk County, the home of typical *elucus*, but the skull of the present form is smaller and flatter. It may be added also that specimens taken on Upper Matecumbe and especially those from Lower Matecumbe Key, the farthest point in the group from the mainland, show gradation toward a smaller animal than those of Virginia Key and Key Largo.

Specimens examined.—15, all from the Key Largo Group, as follows: Virginia Key, 2; Key Largo, 3; Plantation Key, 2; Upper Matecumbe Key, 1; Lower Matecumbe Key, 7.

PROCYON LOTOR AUSPICATUS subsp. nov.

Key Vaca Raccoon

Type.—From Marathon, Key Vaca, Florida. No. 255080, ♂ adult, U. S. National Museum, collected by E. W. Nelson, March 28, 1930.

General characters.—Very small, about the same size as *marinus* from which it may be distinguished by its grayer upperparts, more brownish yellow pale rings on tail, more depressed frontal area on skull and shorter palatal shelf. Its small size distinguishes it at once from the other forms described here from the Florida Keys.

Color.—General coloration rather paler grayish than in *marinus* with tendency to a smaller black mask and more whitish head, rusty nape patch brighter, light rings on tail broader, more brownish buffy, black rings relatively narrower.

Skull.—Similar in its delicate proportions to that of *marinus* but more flattened over frontal area, braincase more rounded, and palatal shelf shorter.

Measurements.—*Type:* Total length, 644 mm.; tail vertebrae, 214; hind foot, 99. *Skull (type):* Greatest length, 99.8; condylobasal length, 95.5; zygomatic breadth, 65.5; interorbital breadth, 19.4; least width palatal shelf, 13.9; upper canine-molariform tooth row, 37.4; weight of type in the flesh, 5.5 pounds. See page 12 for tables of measurements and weights.

Remarks.—The small raccoon from the Key Vaca group in connection with other raccoons of Florida requires comparison only with *P. l. marinus*. It is abundant in the mangrove swamps of Key Vaca and the immediately adjacent keys. The range occupied by the Key Vaca raccoon is the smallest and most compact of that of any of the forms I found among the keys.

Specimens examined.—13, all from type locality.

PROCYON LOTOR INCAUTUS subsp. nov.

Torch Key Raccoon

Type.—From Torch Key, Big Pine Key Group, Florida. No. 255060, ♂ adult, U. S. National Museum, collected by E. W. Nelson, March 24, 1930.

General characters.—Slightly smaller than *inesperatus*, upperparts palest, most dingy gray of any of the forms described here; skull comparatively narrow interorbitally with elevated frontal area more like *elucus* than in the other key forms described here.

Color.—The palest gray of the key raccoons, black mask more restricted, sometimes obsolescent, and elsewhere top and sides of head whiter; pale rings on tail broader, dark ones narrower and usually dusky brown; rusty rufous nape patch usually present and sometimes strongly marked. As the season advances the colors commonly bleach until many are wholly dirty yellowish or dingy whitish.

Skull.—Differs from other key forms described here by greater interorbital compression and distinctly more highly arched frontal area, resembling that of *elucus* but less strongly arched; zygomatic breadth widest of the key forms; molariform teeth smaller proportionately.

Measurements.—*Type*: Total length, 694 mm.; tail vertebrae, 263; hind foot, 118. *Skull* (type): Greatest length, 110; condylobasal length, 105.3; zygomatic breadth, 67.3; interorbital breadth, 19.8; least width palatal shelf, 15.1; upper canine-molariform tooth row, 38.8; weight of type, 8.5 pounds. See page 12 for tables of measurements and weights.

Remarks.—The home of this form of raccoon is on the group of Florida keys farthest from the mainland. As in the case of the other forms described here they live mainly, and sometimes entirely, in mangrove swamps without access to fresh water except during rains. The brilliant light of their environment has affected their general color more than in the others, as shown by their pale, faded tints.

Specimens examined.—20, all from the keys of the Big Pine Group, as follows: No Name Key, 5; Big Pine Key, 6; Torch Key, 2 (type locality); Ramrod Key, 1; Boca Chica Key, 2; Stock Island 2; Key West, 1.

ADULT ♂ RACCOONS FROM THE PENINSULA AND KEYS OF SOUTHERN FLORIDA

COMPARATIVE TABLE OF AVERAGE MEASUREMENTS AND WEIGHTS IN THE FLESH

Names of subspecies and localities	No. of specimens	Total length— extremes	Length of tail vertebrae— extremes	Length of hind foot—extremes	Weight in pounds— extremes
<i>Procyon lotor elucius</i> , Polk County (typical).....	4	812 (790-850)	261 (210-286)	127 (125-129)	11 (10-12)
<i>Procyon lotor marinus</i> , Chokoloskee (type locality).....	7	651 (625-605)	200 (186-222)	101 (95-105)	6.68 (6-8)
<i>Procyon lotor hesperatus</i> , Key Largo Group of Keys (including type locality).....	4	750 (730-795)	236 (220-252)	117 (113-124)	9.68 (7.75-12)
<i>Procyon lotor aspicatus</i> , Marathon, Key Vaca (type locality).....	4	603 (644-700)	235 (214-275)	101 (97-107)	5.6 (5-6)
<i>Procyon lotor incantus</i> , Big Pine Key Group of Keys (including type locality).....	7	713 (656-752)	254 (216-278)	113 (108-118)	8.1 (7-8.5)

ADULT ♂ RACCOONS FROM THE PENINSULA AND KEYS OF SOUTHERN FLORIDA

COMPARATIVE TABLE OF AVERAGE SKULL MEASUREMENTS

Names of subspecies and localities	No. of specimens	Greatest length— extremes	Condylobasal length—extremes	Zygomatic breadth— extremes	Interorbital breadth— extremes	Least width palatal shelf— extremes	Upper canine- molariform tooth row—extremes
<i>Procyon lotor elucius</i> , Polk County (typical), <i>Procyon lotor marinus</i> , Chokoloskee (type lo- cality).....	4	120.3 (117.9-122.8)	115.7 (113.3-117.5)	74.5 (72-76.8)	23.9 (23.2-25)	16.2 (15-17.3)	43.7 (42.8-44.7)
<i>Procyon lotor hespera- tus</i> , Key Largo Group of Keys (including type locality).....	8	102.8 (97.6-105.9)	98.9 (93-101.8)	64.3 (59.1-69.6)	21.1 (19.6-23.9)	14.3 (13.9-15.1)	39.7 (38-40.3)
<i>Procyon lotor aspicatus</i> , Marathon, Key Vaca (type locality).....	4	108.5 (105.2-110.4)	105.1 (100-108.1)	67.5 (63-72.9)	23 (21.5-24.8)	15.5 (15.2-16.1)	41 (39-42.4)
<i>Procyon lotor incantus</i> , Big Pine Group of Keys (including type locality).....	6	101.7 (99.4-106)	96.8 (93.8-101.1)	63.7 (60-66.1)	20 (18.8-20.4)	14 (13.4-15)	37.9 (37.1-39)
.....	8	109.7 (104.6-114)	103 (97.8-106.1)	69.1 (62.4-78)	21.5 (19.6-23.6)	14.9 (13.9-16.1)	39.3 (38.1-40.2)



1.

FIG. 1.—Mangrove cover of aerial roots on islet west of Chokoloskee Bay, Southwestern Florida, at half tide. At low tide the mud is bared and at high tide about half of the roots exposed here are covered. This is the typical haunt of *Procyon lotor marinus*.



2.

FIG. 2.—The U-shaped pen made of mangrove roots stuck in mud with trap in position as set at opening for raccoons; the white piece of fish on stick at back is the bait. A setting on islet west of Chokoloskee Bay in March, 1930.



1.

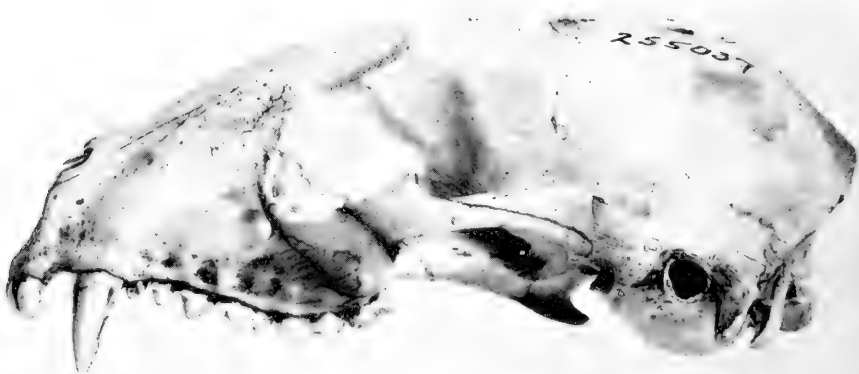

2.

FIG. 1.—*Procyon lotor elucus*, ♂, typical skull, Polk County, Florida.

FIG. 2.—*Procyon lotor insperatus*, ♂, type skull, Upper Matecumbe Key, Florida.

Skulls natural size.



1.

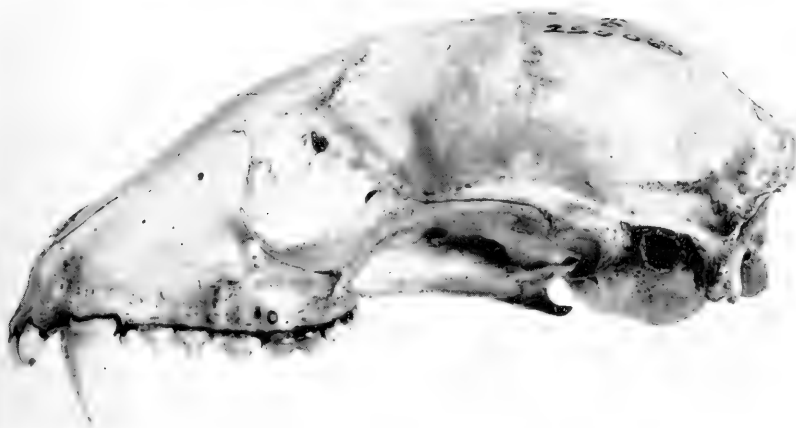

2.

FIG. 1.—*Procyon lotor auspicatus*, ♂, type skull, Marathon, Key Vaca, Florida.
FIG. 2.—*Procyon lotor incantus*, ♂, type skull, Torch Key, Florida.

Skulls natural size. The subspecies reproduced in plates 2 and 3 follow in the geographic sequence of their occurrence from *P. l. clucus* of the mainland down the three groups of the Florida Keys.



1.

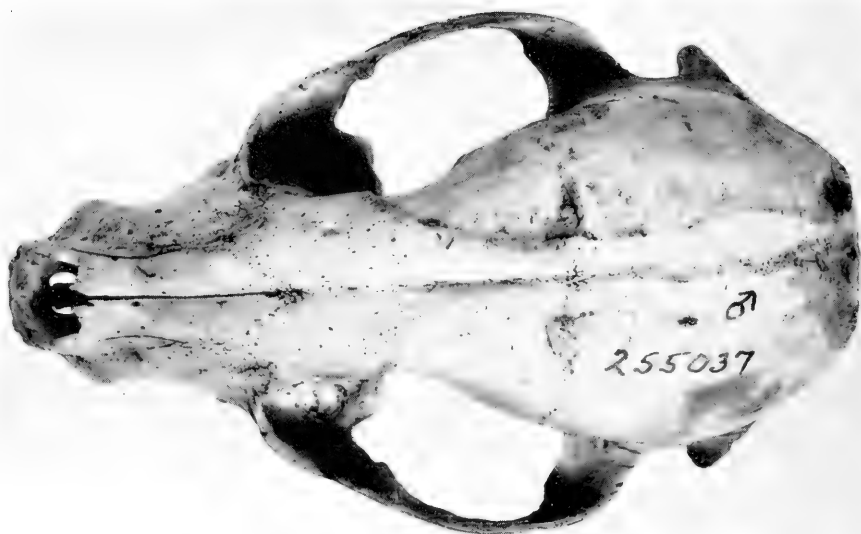

2.

FIG. 1.—*Procyon lotor elucus*, ♂, typical skull, Polk County, Florida.
FIG. 2.—*Procyon lotor inesperatus*, ♂, type skull, Upper Matecumbe Key, Florida.
Skulls natural size.



1.



2.

FIG. 1.—*Procyon lotor auspicatus*, ♂, type skull, Marathon, Key Vaca, Florida.
FIG. 2.—*Procyon lotor incautus*, ♂, type skull, Torch Key, Florida.

Skulls natural size. Subspecies reproduced in plates 4 and 5 follow in their geographic sequence as in plates 2 and 3.





SMITHSONIAN MISCELLANEOUS COLLECTIONS

VOLUME 82, NUMBER 9

THE FURTHER AND FINAL RESEARCHES OF
JOSEPH JACKSON LISTER UPON THE REPRO-
DUCTIVE PROCESSES OF POLYSTOMELLA
CRISPA (LINNÉ)

(An Unpublished Paper Completed and Edited from
His Note-Books)

(WITH SEVEN PLATES)

BY

EDWARD HERON-ALLEN, F. R. S.



(PUBLICATION 3067)

CITY OF WASHINGTON
PUBLISHED BY THE SMITHSONIAN INSTITUTION
NOVEMBER 26, 1930



SMITHSONIAN MISCELLANEOUS COLLECTIONS
VOLUME 82, NUMBER 9

THE FURTHER AND FINAL RESEARCHES OF
JOSEPH JACKSON LISTER UPON THE REPRO-
DUCTIVE PROCESSES OF POLYSTOMELLA
CRISPA (LINNÉ)

(An Unpublished Paper Completed and Edited from
His Note-Books)

(WITH SEVEN PLATES)

BY
EDWARD HERON-ALLEN, F. R. S.



(PUBLICATION 3067)

CITY OF WASHINGTON
PUBLISHED BY THE SMITHSONIAN INSTITUTION
NOVEMBER 26, 1930

The Lord Baltimore Press
BALTIMORE, MD., U. S. A.

THE FURTHER AND FINAL RESEARCHES OF JOSEPH
JACKSON LISTER UPON THE REPRODUCTIVE
PROCESSES OF POLYSTOMELLA CRISPA
(LINNÉ)

(An Unpublished Paper Completed and Edited from His Note-Books)

BY EDWARD HERON-ALLEN, F. R. S.

(WITH SEVEN PLATES)

INTRODUCTORY NOTE

For over 30 years Lister's work upon the reproductive processes of the megalospheric form of *Polystomella crispa* (Linn.) by means of flagellispores has been familiar to protozoologists, and especially to students, both in text-books and in the lectures of university professors, and it recurs incessantly in examination papers. For over 30 years it has been well known that his equally, if not more, important work on the reproductive processes of the microspheric form by what may not improperly be called viviparity had been completed, but with the exception of the short postscript to his paper published in 1895 it has not been available to protozoologists. The reason for this is difficult to fathom for anyone who did not know him intimately. We know that his nervous sensibility was such as to reach at times a pathological condition, and he could never be persuaded to publish anything that he took it into his head to keep to himself. I suppose that, so far as the Foraminifera were concerned, I was his most intimate friend and fellow-worker, but, though we frequently visited each other and continually corresponded, he never showed me any of these preparations, photographs, or lantern slides.

I esteemed it therefore as a great privilege that I was allowed, after his death, to sort and arrange the whole of his microscopical materials and preparations, and the papers and note-books relating to them, and having found the whole of his material, his slides and his own unpublished paper upon it, I was permitted by the late Mrs. Lister, herself a noteworthy zoologist, to give to the world of science the information that it had been awaiting for 30 years.

When the last and the youngest of the men that he taught have died; when the problems attaching to *Astroclera* have been solved;

when his teaching in the Zoological Schools of Cambridge have become a mere tradition; when his patient, laborious work upon the geology, ethnology, and ornithology of the South Seas has become but a brick in the vast edifice of human knowledge; indeed so long as men shall devote labor and research to the science of protozoology, the name of Joseph Jackson Lister, like that of his illustrious uncle, Lord Lister, and of Harvey, Jenner, Leeuwenhoek, Redi, and Schwann, will live in the hearts and on the lips of men, and the discovery which will spring to the mind when his name is mentioned will be that of the reproductive processes of the reticularian Rhizopods, especially those of *Polystomella*, and the meaning and significance of dimorphism.

Those of us who were privileged to know him, and especially those of us who in our researches have followed in his footsteps, know how delicate and polite was his use of the results of his amazing industry, patience, and almost universal interests—industry and interests pursued and recorded indefatigably in the face of physical difficulties beneath which a lesser man would have early succumbed. How much more profound must be the appreciation of one who, like myself, has been privileged to examine his laboratory note-books and the mass of valuable papers that he left behind him at his early death—left in a condition of such exquisite perfection that the examiner is never once checked by the reflection: “If only he were here to explain exactly what he meant by *that*.”

I should hesitate, for fear of being accused of extravagance of speech, to describe the note-books of Lister, were it not that they lie before me as I write and that Mrs. Lister has presented them to form part of the Heron-Allen and Earland library and collections at the Natural History Museum (London), where they will be always available, for the instruction and emulation of future generations of protozoologists. He made notes, not merely for his own use in the kind of personal cryptogram which we are all apt to adopt in recording our own observations, but for the guidance of any research-workers that should come after him. Every sketch or drawing that he made was as highly finished as though it had been prepared for publication, and the systematic dating of his notes enables us to follow his work step by step, and, for practically the whole of his working life, day by day.

It was in the course of the examination that I have been privileged to make, that I came across his own manuscript record of his work at Plymouth, extending from June 1 to August 9, 1894, a

record of such vital interest and importance that no apology is needed for publishing it *in extenso*. It is the record of his observations upon the reproductive processes of the microspheric form of *Polystomella crispa* (Linn.), and I have been able to compare this manuscript with his original laboratory note-books, and with the records of his later work in 1895, and in 1904-5.

Lister's researches upon this organism appear to have commenced in March-May, 1893, and it was during this period that he observed the reproductive processes of the megalospheric form by means of flagellisporae, which observations he recorded, with a masterly study of the dimorphism and nuclear conditions of the species, in his world-famous paper read in June, 1894, and published in the Philosophical Transactions of the Royal Society of Great Britain in 1895.¹ By one of those coincidences that are curiously far from uncommon in science, Fritz Schaudinn was pursuing an identical line of inquiry at the same time, and the same results were arrived at and published almost simultaneously by both of these great men though working quite independently and unknown to each other.²

But when Lister's Philosophical Transactions paper was virtually on the press, or at least awaiting publication, he was again at Plymouth, checking his former observations, and making further discoveries which may well be described as epoch-making. Let him tell us the story in his own words, but first let us consider for a moment the organisms in question: they are:

(a). *Polystomella crispa* (Linn.): one of the commonest known species, and one of practically world-wide distribution.

(b). *Polystomella macella* (Fichtel & Moll): a depressed and closely allied species, found associated with *P. crispa* but somewhat rarer north and south of the sub-tropical areas. I have recorded it myself from Selsey, Torbay, Clare Island, Galway, St. Mawes, and St. Andrews and the North Sea, so it may well have been among Lister's material: he had no time to be an accurate systematist.

Lister does not seem to have recorded observations upon

(c). *Polystomella striato-punctata* (Fichtel & Moll) until 1904. He was again at Plymouth in June-July, 1904, as he says in his note-book, "hoping to make some progress in the life-history of the Foraminifera." He records his observations upon the reproduction of the

¹ Lister, J. J., Contributions to the life-history of the Foraminifera. Phil. Trans., Vol. 186 B., p. 401, 1895.

² Schaudinn, F., Die Fortpflanzung der Foraminiferen und eine neue Art der Kernvermehrung. Biol. Centralbl., Bd. 14, No. 4, February, 1894.

megalospheric form of *P. striato-punctata* by flagellisporos on June 29 and July 1. There is no mention of the reproduction of the microspheric form by the processes we are now describing, though it is of world-wide distribution, and nearly always found with *P. crispa*, and it was the first Foraminifer ever figured—by Hooke in 1665¹ and by Leeuwenhoek in 1702.²

He was there again in the same months in 1905, but added nothing of moment to his previous records, but records the fact that in several of his dishes left behind in 1904, Foraminifera and other organisms were still alive.

He printed a highly condensed abstract of these later observations as a postscript, dated August 3, 1894, to his Philosophical Transactions paper, and this postscript, slightly elaborated, appears in this still contracted form in his later works, viz: in Lankester's Treatise on Zoology in 1903,³ his address as president of Section D at the York Meeting of the British Association in 1906,⁴ and in his Evening Discourse at the Royal Institution in 1907.⁵ But, for some reason which we shall never know, but which was doubtless connected with his state of health, he never published his paper. No apology is needed therefore for giving to the scientific world his own description of his researches, and their results. It is as follows:⁶

LISTER'S NOTES

July 7, 1894. *Plymouth*.—For the last three weeks or so, I have kept *Polystomella* in tall glass jars,⁷ the water in which has been renewed frequently by a jet playing through a muslin cover over the mouth of the jar.⁸ The *Polystomellas* crawl up the sides from the

¹ Hooke, R., *Micrographia*, p. 80, pl. v, fig. x, London, 1665.

² Van Leeuwenhoek, A., *Sevende Verfolg der Brieven*, etc., p. 195, pl. (opp. p. 191), fig. 7, a, b, c, Delft, 1702.

³ Lister, J. J., *The Protozoa*, Sect. 1. *The Foraminifera*, in E. Ray Lankester "A treatise on zoology," Pt. 1, 2nd Fasc., pp. 47-149, 1903.

⁴ Lister, J. J., *The life history of the Foraminifera*. Brit. Assoc., York, 1906, Section D, Presidential Address.

⁵ Lister, J. J., *The Foraminifera*. Proc. Roy. Inst. Great Britain, Evening Meeting, February 15, 1907, p. 489, London, 1909.

⁶ I have carefully compared this manuscript statement with Lister's laboratory note-books, and the further details to be derived from these are of such value that I have transcribed such parts of his notes as bear upon his statement, in the foot-notes.

⁷ The *Polystomella* were dredged in 5 fms. on *Zostera* grass, inside Drake Island in Plymouth Sound, and the experiments commenced on June 17.

⁸ When this spraying was not in progress the jars stood on the sill of a window in the sun. J. J. L.

bottom and may be clearly seen when in bright light, with a black background. Usually one or two of the terminal chambers contain little protoplasm and appear empty. In the ordinary condition their pseudopodia are inconspicuous, but they may generally be detected with a pocket lens, extending in sheaves from the shell,¹ and with a microscope they have the usual appearance of delicate straight threads with granules.

In some 50 cases I have seen examples in the *reproductive phase*. The first sign of this phase is seen in the character of the pseudopodia.² Instead of being disposed as above described, the pseudopodia are limited to a circular or oval area immediately about the shell, the center of the area being the mouth of the shell, which is nearly always flat against the glass. This area is covered completely by a close web of radiating and interlacing pseudopodia, and its limits are fairly sharply defined. The pseudopodia are so thick as to intercept the light, giving rise to the appearance of a semi-transparent milky halo about the shell. This may be called the "premonitory halo." It is readily seen by the naked eye.

The animals are generally found in this condition in the early morning.

In nearly all the cases that I have observed the halo has been established by 6:30 a. m.³

After the animal has remained in this condition for some hours, the protoplasm begins to leave the shell, the strands of the pseudopodia, especially the radiating ones, become thicker, and the protoplasm withdraws itself, first from the peripheral ends of the outer whorl of chambers, being massed in the terminal chambers. Gradually the protoplasm leaves the shell, passing through the direct communications between the chambers, and also, as is seen in specimens preserved at this stage, through the canals which exist in the walls separating the chambers from one another. The protoplasm is generally brown, owing to the presence of brown granules.⁴ As the protoplasm emerges into the area of the halo, this becomes streaked with brown, at first in

¹ When they are observed immediately after the jet of water has been playing into the jar, a long sheaf of the pseudopodia is seen pointing towards the current set up in the water. After the water has become still, they are shorter and point in various directions. J. J. L.

² This was first observed on June 21, 10:30 a. m.

³ While these observations were in progress, Lister frequently remained all night in the Laboratory of the Marine Biological Association.

⁴ 1:30 p. m.

thin radiating streaks, which become thicker and fuse with one another until the area is, to a greater or less extent, filled with the dark brown mass.¹

Specimens which are removed from the wall of the jar while surrounded by the premonitory halo, and placed on cover-slips with a small drop of water, will generally send out fresh pseudopodia and attach themselves to the cover-slip. They may then be placed over holes in filter paper through which a current of water flows, and the hole be completely filled with water. In this way the animal is immersed in circulating water. In some cases the pseudopodia thrown out are of the short reticulated character of those forming the halo, and these indicate that the process is going on uninterruptedly; but it frequently happens that though the animal attaches itself to the glass, the pseudopodia are of the long, little anastomosing character of the ordinary condition. In this case the protoplasm remains in the shell—the animal having, owing to the disturbance, returned to the ordinary state. If however the reproductive phase is continued, the process may be observed under the microscope.

When the protoplasm has emerged from the shell, the whole mass undergoes amoeboid changes of shape,² and under the microscope may be seen to be in a turmoil of movement,³ the protoplasm coursing along in broad interlacing streams. The streams may be seen to pursue a definite course, the protoplasm in any one part of the mass moving in the same direction for many minutes without interruption.

When newly emerged, the brown granules are uniformly scattered through the protoplasm. Gradually a mottled arrangement is produced owing to the appearance of clear spaces (regions) free from brown granules. As the process continues these clear spaces (regions) become larger and more defined, and they are then seen to be more stationary than the remainder of the protoplasm, the streams of granules flowing past them. They are not however entirely stationary.

In one instance the area free from brown granules first became evident one and a half hours after the protoplasm had emerged from the shell.

Gradually the streaming movements of the protoplasm become less, as the clear regions attain greater prominence, and in about half an hour after their appearance the whole mass becomes broken up into

¹ 1: 55 p. m.

² The mass which is at first diffuse, gradually draws together into a more compact mass, the pseudopodia being almost entirely withdrawn leaving branching lines of fine granules marking the positions they had occupied. J. J. L.

³ 2: 30 p. m.

rounded spheres, some 50μ in diameter, whose center consists of clear granular protoplasm (in which I thought I detected a radiate arrangement) the peripheral part being dark with the coarse brown granules.¹

In some cases part of the protoplasm remains in the terminal chambers of the shell and divides into spheres in this position. This, however, is not usual.

The spheres form at first a compact mass. Shortly, each becomes surrounded by a close felt of very delicate anastomosing pseudopodia, which when seen with a simple lens has the appearance of a mass of white granules² and I supposed at first that a deposit of lime granules had taken place about the group of spheres. They gradually draw apart from one another, so that each can be seen as a distinctly isolated mass.

I have killed and stained a number of specimens at different stages of this process. Those in the stage before the protoplasm has left the shell, as well as those at the beginning of the later stage, have the central chambers still filled with protoplasm. In all these specimens it is obvious that it is a *microspheric* individual that is undergoing the process. Again, the specimens mentioned above which, having shown a "premonitory halo," returned to the vegetative condition, on being removed to a cover-slip, are found on being decalcified and stained, to belong also to the *microspheric* form. Altogether I suppose I have some 15 specimens whose central chambers are still filled with protoplasm and hence furnished evidence as to the form to which they belong.

In a batch of specimens of *Polystomella* (some 200-odd) megalospheric and microspheric specimens were nine to one. This is good evidence that the reproductive phase I am dealing with is that of the microspheric form.

The specimens killed in the first stage present, when stained, the appearance I have often seen, the many nuclei being of irregular shapes, and surrounded by numbers of "stained strands." In some cases no definite nuclei can be detected, and only few of the strands. When nuclei are present they do not extend into the terminal chambers of the shells.

In specimens whose protoplasm has begun to emerge, faintly stained round nuclei 10μ in diameter are found in the clear protoplasm of the terminal chambers, while the innermost protoplasm still has the diffused flush and contains strands of stained matter.

¹ 2: 40 p. m.

² 4: 30 p. m.

In some cases the protoplasm immediately surrounding these nuclei has a yellowish red color, as though, perhaps, it contained material which was passing in towards the nucleus. The nuclei 10 μ in diameter are found in the later stages now described. They acquire stronger staining powers as the sphere stage is approached.

Continued July 21.—The duration of the stage in which the protoplasm remains in the condition of closely aggregated spheres, and which I call stage iii, varies from two to eight hours. The average duration in a number of cases is about four hours. The most marked change which can be seen in the living condition during this period is in the disposition of the brown granules in the spheres. At first the center of the spheres is clear, the granules lying at their periphery, while in the later part of the stage the granules occupy the sphere leaving only a clear layer at the periphery.

After stage iii the development may pursue one of two courses:

1. In by far the greater number of cases that I have watched the spheres lose their sharply defined outline and gradually fuse with one another into one or a few lumps.¹ Sometimes long pseudopodia are thrown out during the process of fusion but this does not always occur. The lumps so found generally divide, forming smaller lumps of varying size which move apart by means of pseudopodia, and also exhibit amoeboid changes of form. It frequently occurs that one of these lumps attaches itself to the empty shell, spreading over part of the exterior and interior.²

The protoplasm remains in this condition for weeks. The smaller lumps appear gradually to break up into granules, losing their definite outline and apparently dying. The large lumps may retain their sharply defined outline for weeks, the movement of the protoplasm becoming gradually more sluggish, and the volume of the mass apparently decreasing. What their ultimate fate may be I have not seen—but it appears probable that it is the same as that of the smaller divisions (lumps) into which the protoplasm divided—gradually disintegrating.³

¹ 7: 30-9: 30 p. m.

² 11: 30 p. m.

³ These conditions lasted until July 1, many other specimens being kept under observation. On this date Lister tabulates the stages of the process as follows: Stage 1. Premonitory halo formed but protoplasm still in shell. Stage 2. Protoplasm emerged from shell but still in one mass. Stage 3. Protoplasm divided up into isolated spheres. Stage 4. Spheres fused to form a common mass sending out pseudopodia. Stage 5. The mass divided up into amoeboid lumps with pseudopodia. Lister's preparations of shells in all of these stages are in our collection at South Kensington.

2. In some ten cases (out of say 150 which I have now seen) the spheres have separated after some hours, sending out long and abundant pseudopodia, and moving rapidly away from one another.

Within 24 hours a second chamber is added to the sphere,¹ and a calcareous shell is developed.² In this condition they are readily recognized as young megalospheric individuals.³

July 22.—After writing the above yesterday it occurred to me that the first of the two processes described above was an abnormal one—the result of the impurity of the water. I therefore changed the water

¹ This was first observed at 7: 10 p. m. on July 2. Lister's note (note-book, vol. ii, p. 91) reads "The empty shell is now surrounded by a host of small bodies. These all possess a globular mass containing yellow protoplasm. In many cases a second mass shaped like the second chamber of a megalospheric form, and more transparent than the globular mass is present. In other cases two transparent $\frac{1}{2}$ -oval masses are present. Some of them have extended pseudopodia." On July 3, at 9 a. m. these second chambers had highly accentuated themselves. (See drawing note-book iii, p. 27.) All the stages were observed on this day in another specimen between 9 a. m. and 9: 40 p. m. (drawing in note-book, vol. ii, p. 92). This had acquired its second chamber at 8: 30 a. m. on July 4.

² This was first observed at 12: 20 a. m. on July 5. At 9: 10 a. m. the former specimen had its young "with a rough shell-hyaline material outside this." (Note-book, vol. ii, p. 99.)

³ On July 7 (the day Lister began the account we are studying) at 10: 15 a. m. he writes (note-book, vol. ii, p. 101) "The specimen which yesterday morning at 10: 30 a. m. was in stage 3, and whose spheres then separated, I have now transferred to picric with several of the spheres attached. They are young megalospheric forms with a second chamber formed." These observations were continued and repeated day after day with the same patient observations and accurate records. On July 11 Lister was able to construct a table, founded upon 23 specimens which had been observed, at the times passed in the stages, the average being: Stage 1, 3 hours. Stage 2, 2 hours. Stage 3, 7 hours. (On the 12th he observed the same phenomena in *Rotalia beccarii* (Linn.) of which he made a beautiful drawing (note-book, vol. ii, p. 106).) The average for 12 specimens watched on July 13 was: Stage 1, 4 hours. Stage 2, 2 hours. Stage 3, 8 hours. (The young *Rotalia* (66 specimens) gave an average of stage 1, 3 hours, 20 minutes. Stage 2, 1 hour, 30 minutes. Stage 3, 4 hours, 20 minutes. The observations went on as before, thereby confirming the accuracy of his previous records up to the 21st; on the 22nd he made the discovery as to the water which has been recorded in his own words, which now follow. When making dredgings at Plymouth, while this paper was awaiting publication (in April, 1929), we had the good fortune to find, in a dredging from inside Drake Island (the locality from which Lister obtained his material) a very large number of young *Polystomellae*, in exactly the condition here described—*i. e.*, a megalospheric chamber, followed by one or two succeeding chambers. See our paper, "The Foraminifera of the Plymouth District," E. Heron-Allen and A. Earland, Journ. Roy. Micro. Soc., 1930, vol. 50, p. 194.

in two of the jars, putting instead of the aquarium water, water from beyond the Breakwater which I had in a bottle.

Today six individuals have passed through the reproductive phase and all have pursued the second course—giving rise to young megalospheric individuals. Those (4) in which the protoplasm separated in the afternoon have already (9:35 p. m.) added a second chamber to the megalosphere, while those which have separated since 7 o'clock consist only of a spherical body, with abundant ray-like pseudopodia.

These six individuals pursued the course described above up to the end of stage iii—the most noticeable feature about them being the large area covered by the protoplasm in the second and third stages—filling the area of the halo.

This clears up the process in a most satisfactory manner.¹

To the abstract of the above given in his later works he merely adds: "The whole of the protoplasm of the parent is used up in the formation of the brood of young, the shell being left empty. The process from the first appearance of the halo to the dispersal of the young is complete in about 12 hours. . . . Each of the spheres was, in fact, a megalosphere. The microspheric parent has given rise to, indeed it has become, a brood of megalospheric young."

Lister was an expert micro-photographer, and in April, 1895, he obtained fresh material from Plymouth, and repeated his observations in his own laboratory, at Cambridge. He heads his notes: "Polystomella material started in dishes, April 30. Several microspheric individuals have reproduced in the manner seen at Plymouth last summer. In a few cases the fusion has occurred, but many have formed normal young." His observations, like those of 1894, were made by the "hanging drop" method in the use of which he was an expert. His notes at this time relate to the flagellispore method of reproduction by the megalospheric specimens, but from May 22 to 24 he made a wonderful series of micro-photographs, 24 in number from a single microspheric individual of which 15 were made into lantern slides, which slides Mrs. Lister has presented to our collection. A selection of these together with certain of the photographs (which are now being published for the first time) are now available, for all time, for the use of students of Protozoology. In all, 20 photographs are here reproduced. They may be tabulated as follows:

¹ On July 25 he writes "There is reason to believe that the aquarium water is affected by the asphalt lining of the tanks." He tested this with further Polystomellae on the 26th in "outside water" between 8:30 a. m. and 7 p. m. with brilliantly successful results. His notes on Polystomella cease, for this time, here.

Figure	Series	May 22, 1895	Lantern slide, Heron-Allen and Earland Collection	
1	E. 1	1:00 p. m.	12/32	} The "premoni- tary halo."
2	E. 2	2:25 "	
3	E. 3	4:25 "	12/33	Stage ii.
4	E. 4	4:40 "	12/34	"
5	E. 5	5:20 "	12/35	"
6	E. 6	6:00 "	12/36	"
7	E. 7	6:30 "	12/37	"
8	E. 8	7:05 "	Stage iii.
9	E. 9	8:15 "	"
10	E. 10	8:55 "	12/38	"
11	E. 11	9:30 " ^a	12/39	"
12	E. 12	9:30 " ^b	12/40	"
13	E. 13	10:55 "	12/41	"
14	E. 14	11:15 "	12/42	Final stage.
15	E. 15	11:25 "	12/43	"
16	E. 16	11:30 "	12/44	"
17	E. 17	11:55 "	12/45	"
		May 23, 1895		
18	E. 19	0:40 a. m.	"
		May 24, 1895 ^c		
19	E. 19	11:50 " ^c	12/49	"
20	F. 1 & 2			

^a Deep view.

^b Nearer view.

^c There is something wrong here. J. J. L. dated this slide May 23, 1895, 11:50 a. m. but it obviously belongs here as a second chamber is in process of formation. I think it should have been dated May 24. After E. 18 (which is not reproduced) the slides are not numbered, but his register of *photographs* gives the numbers 19 *et seq.*

The last of these, figure 20, is one of the two slides in the collection, showing different magnifications of the same object, which are registered as Ser. F. 1 & 2 but no dates or times are given. They are from another specimen and represent the post-final stage (probably 25-26 May) when a second chamber has been added. They are registered in the Heron-Allen and Earland Lantern-slide Collection as 12/46-47.

In conclusion I may be allowed to pay a tribute of warm gratitude to Mrs. Lister, whose early death occurred shortly afterwards, for the public spirit which led her to present the Lister Collections in general, and these priceless note-books, preparations (there are nearly 450 of *P. crista* alone in our collection at South Kensington), and lantern slides, to the nation for the use of future generations of students. I desire, also, to express my gratitude to Dr. J. A. Cushman for correcting the proofs of this paper.

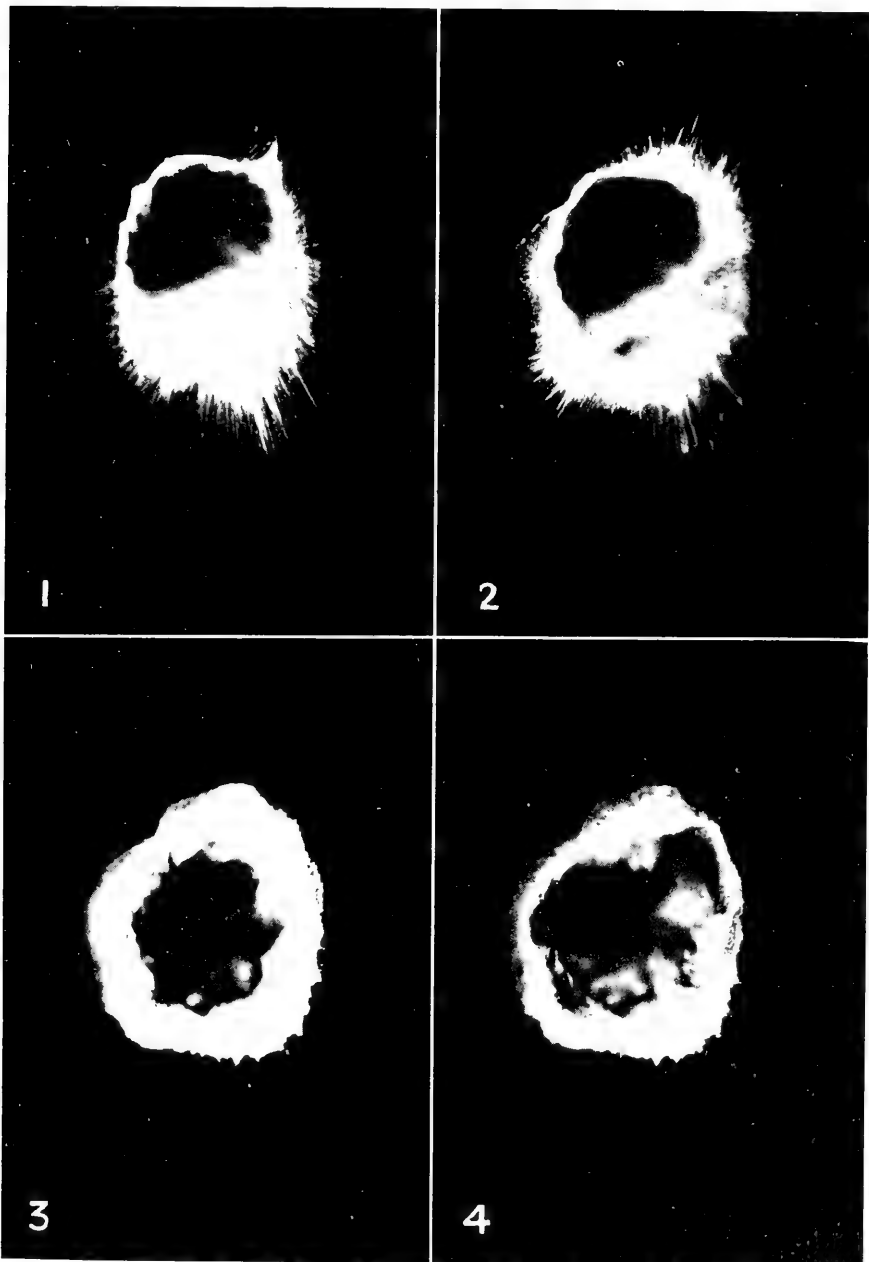

For explanation, see page II.

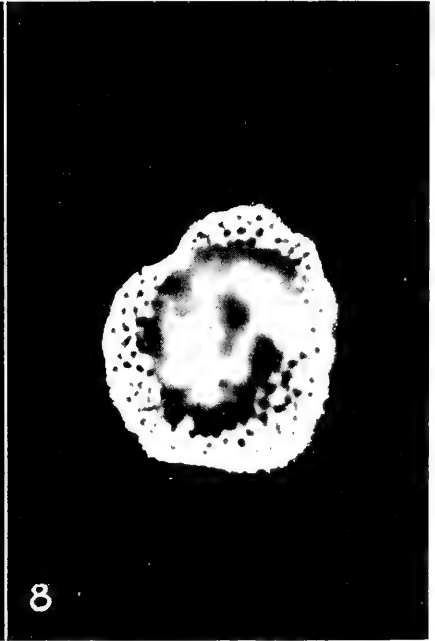
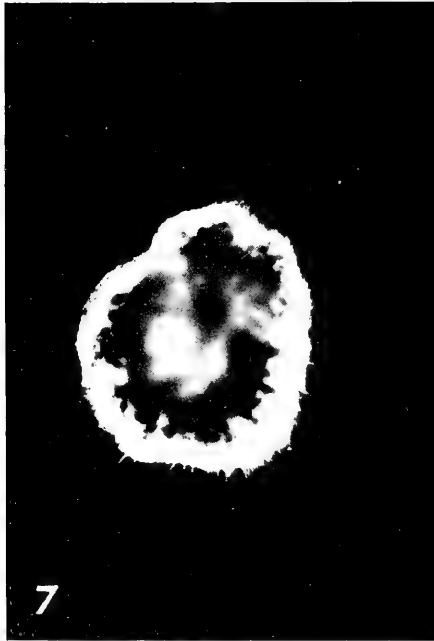
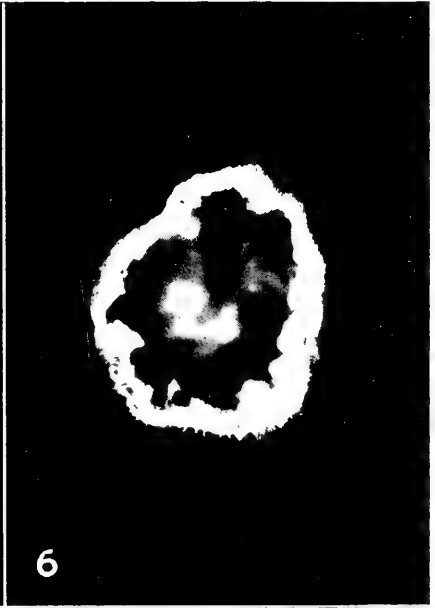

For explanation, see page 11.

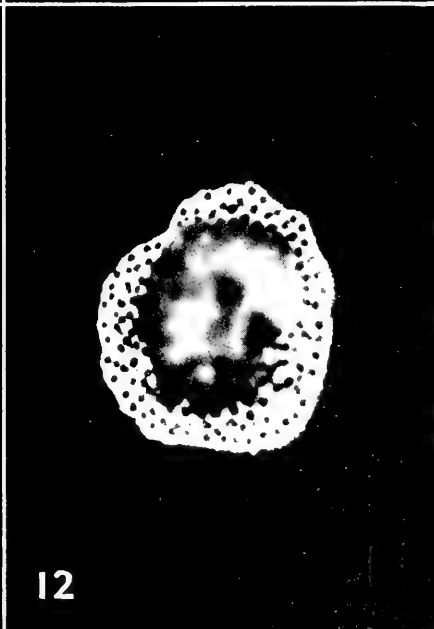
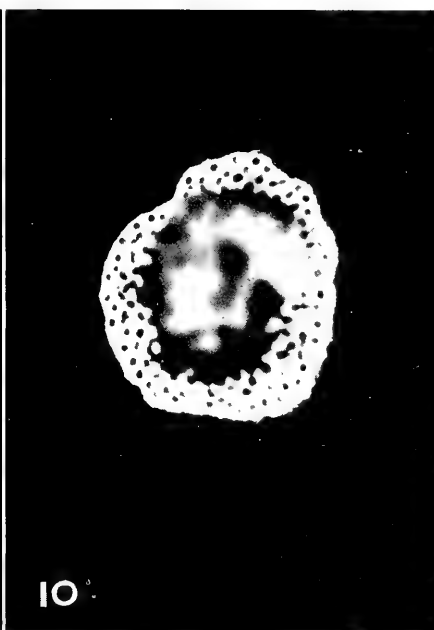
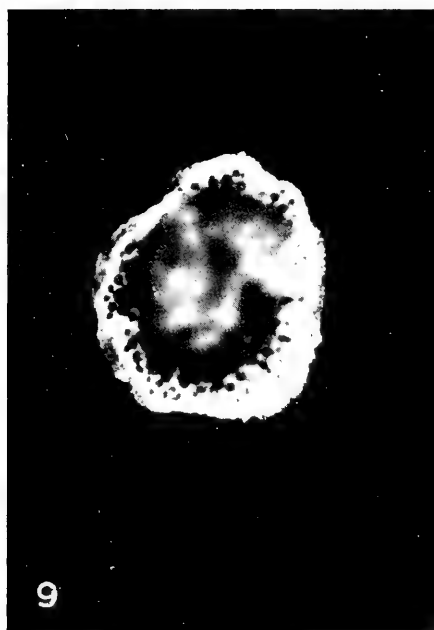

For explanation, see page 11.

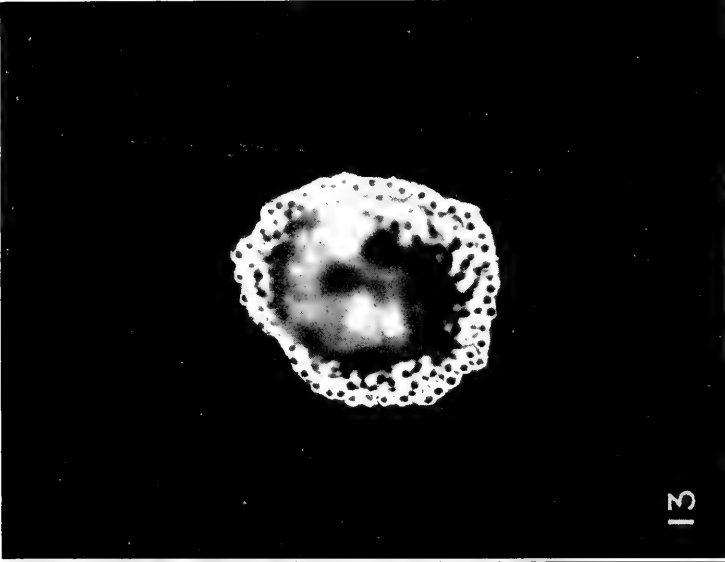
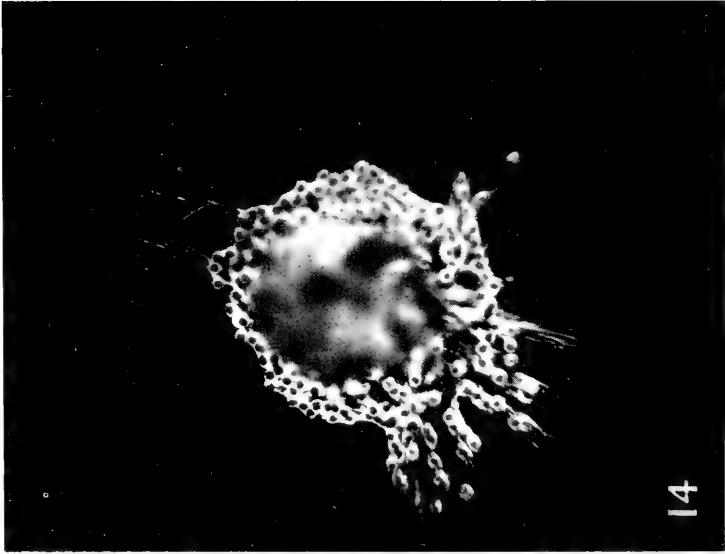

For explanation, see page 11.

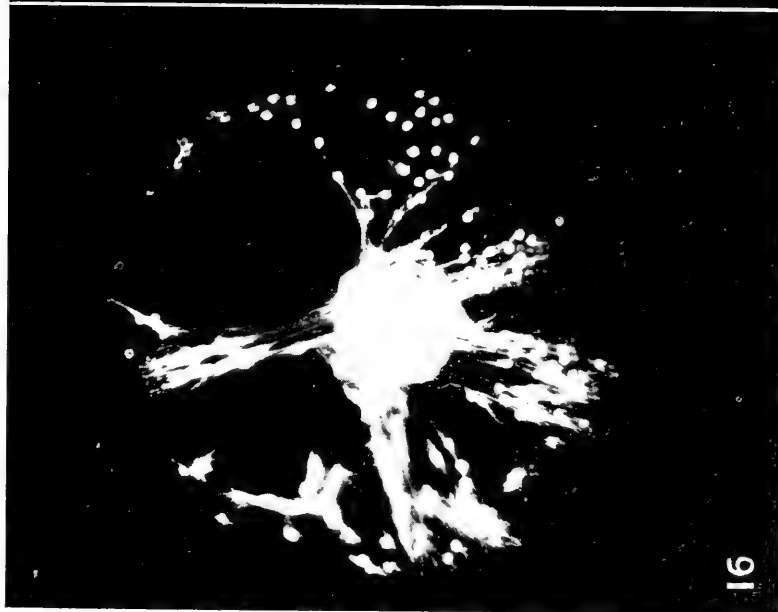

For explanation, see page 11.

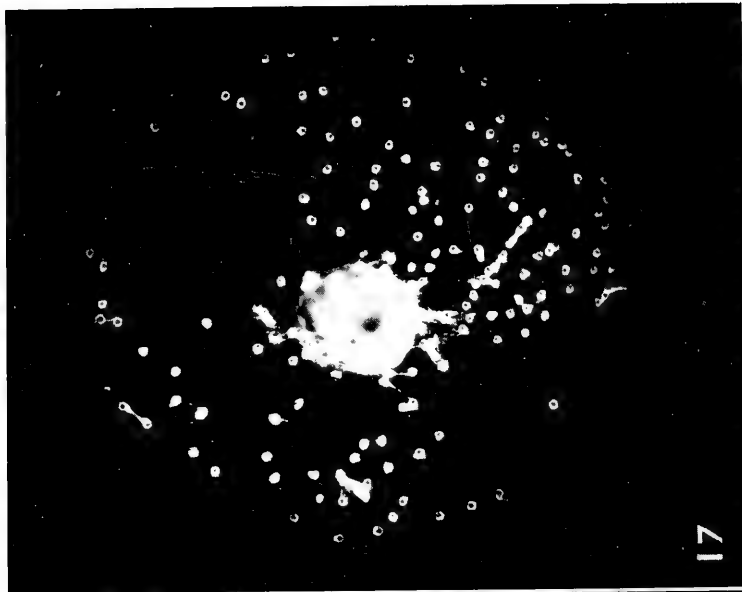
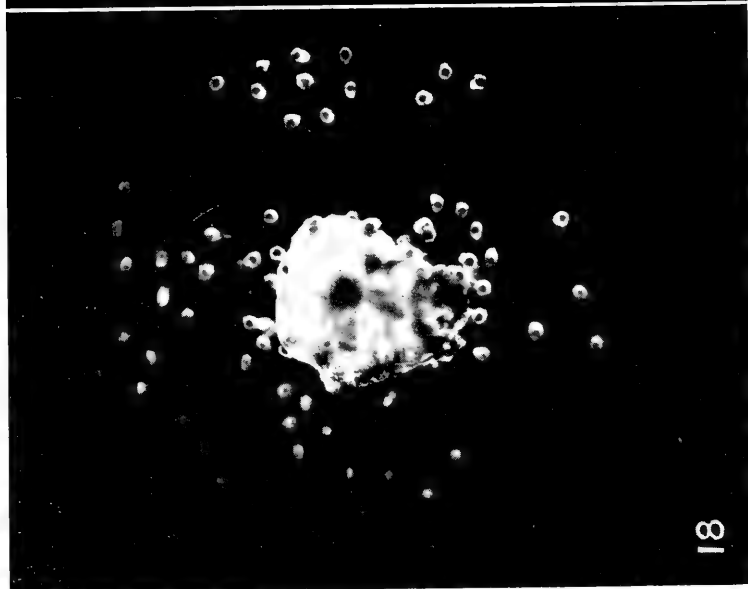

For explanation, see page II.

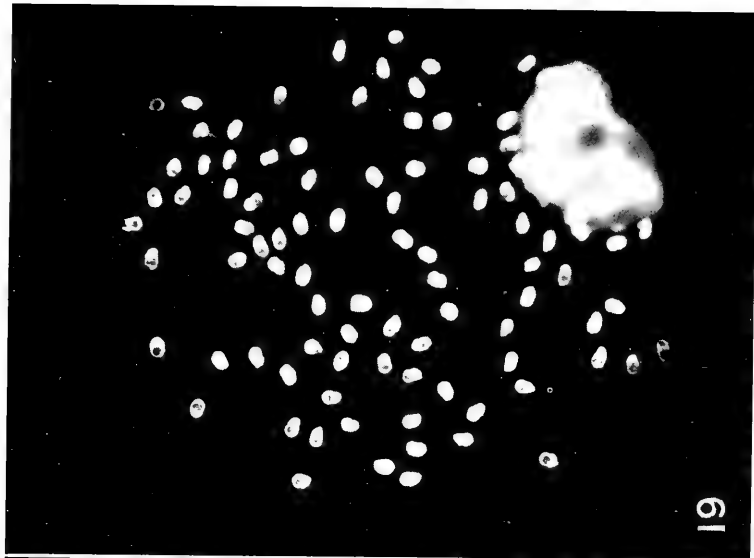
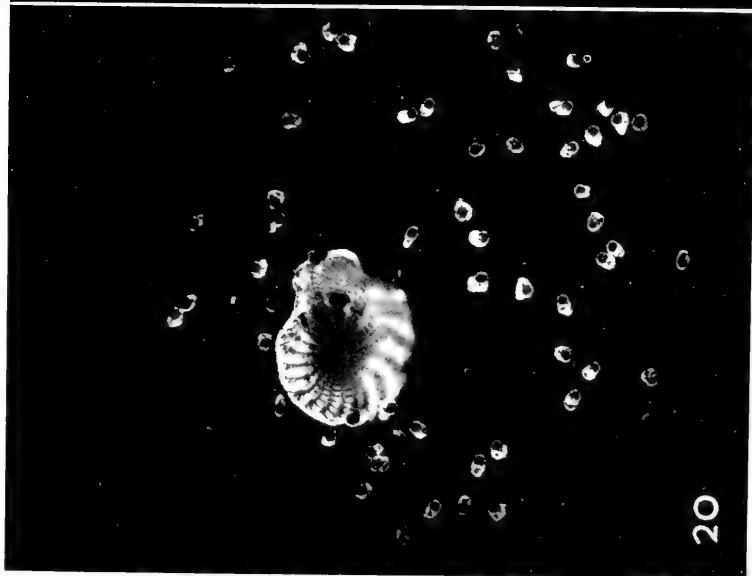

For explanation, see page 11.



SMITHSONIAN MISCELLANEOUS COLLECTIONS

VOLUME 82, NUMBER 10

MORPHOLOGY OF THE BARK-BEETLES OF THE
GENUS GNATHOTRICHUS EICHH.

BY
KARL E. SCHEDL



(PUBLICATION 3068)

CITY OF WASHINGTON
PUBLISHED BY THE SMITHSONIAN INSTITUTION
JANUARY 24, 1931

SMITHSONIAN MISCELLANEOUS COLLECTIONS

VOLUME 82, NUMBER 10

MORPHOLOGY OF THE BARK-BEETLES OF THE
GENUS GNATHOTRICHUS EICHH.

BY
KARL E. SCHEDL



(PUBLICATION 3068)

CITY OF WASHINGTON
PUBLISHED BY THE SMITHSONIAN INSTITUTION
JANUARY 24, 1931

The Lord Baltimore Press
BALTIMORE, MD., U. S. A.

MORPHOLOGY OF THE BARK-BEETLES OF THE GENUS GNATHOTRICHUS EICHH.

BY KARL E. SCHEDL

CONTENTS

	PAGE
Introduction	2
Abstracts of the literature up to date.....	3
A. The genus	3
B. <i>Gnathotrichus materiarius</i> Fitch.....	6
C. <i>Gnathotrichus retusus</i> Lec.....	11
D. <i>Gnathotrichus sulcatus</i> Lec.....	13
Synonyma	14
Common names	15
The chitinous skeleton of the adult.....	15
General appearance, vestiture, color and size.....	15
The head	19
The appendages of the head.....	22
The antennae	22
The mouthparts	24
The thorax	30
The prothorax	31
The mesothorax	34
The metathorax	36
The abdomen	41
The spiracles	45
The legs	45
The wings	49
Mesothoracic wings or elytra.....	49
Metathoracic wings or hind wings.....	53
The male reproductive organs.....	57
The female reproductive organs.....	63
The alimentary canal.....	64
The larvae	65
The chitinous skeleton.....	70
The head	70
The appendages of the head.....	73
The antennae	73
The mouthparts	73
The thorax	77
The abdomen	77
The spiracles	78
The thoracic and abdominal setae.....	78
The alimentary canal.....	80
The pupae	81
The head	83
The thorax	83
The abdomen	84

INTRODUCTION

Since the early days of forest entomology, the superfamily of Scolytoidea has always fascinated the investigators working on forest insects. The destructive work of some of them, in spite of their relatively small size, and also their peculiar habits were undoubtedly the reasons for this extraordinary interest. However, with the cultivation of such crops as coffee, tea, and other subtropical crops these insects have become of greater interest to the economic entomologist in general.

The literature dealing with the nomenclature and the bionomics of species belonging to this superfamily is enormous. Several attempts have been made to construct a classification based on morphological characters. Other investigations were undertaken to homologize certain structures to act as a guide for the proper placing of the genera throughout the group. In this connection it is necessary to mention only a few authors, such as Lindemann, Eichhoff, Verhoeff, Hagedorn, Nuesslin, Fuchs, and Hopkins. However, up to the present there is comparatively little known in regard to the morphological, histological, and physiological details. There has been practically nothing published concerning the muscle structure, the respiratory system (with the exception of the number and position of the spiracles in the adults and in a few cases in the larvae), the circulatory system, the sensory organs, the blood, the nervous system, the metamorphosis, the histology, etc.

Concerning the control of the more important primary forest pests, hundreds of recommendations have been made by different authorities. However, all that have been made up to the present have failed to give satisfactory control under all conditions. The recent ideas of Seitner (53), used and enlarged by the Russian investigators Golovjanko (55) and Iljinsky (60), seem, in conjunction with more careful forest management, to represent the most hopeful direction for future work. Undoubtedly even these modern outlooks will require enormous further work to throw light upon the laws by which bark-beetle outbreaks are governed. After solving these problems the time will probably come when preventive measures will replace the expensive and often useless control methods of our day.

The following investigations are a tentative endeavor leading to a more intensive monograph of the genus *Gnathotrichus* Eichhoff. They have been carried out as a private study.

This first paper covers the chitinous skeleton of the adult, pupa and larva, the structure of the digestive system and the reproductive organs of the adult and larva. It is hoped later to publish two more

papers, one on the sensory and secretory organs, the muscle structure, the respiratory, circulatory, and nervous systems of the larva and imago; the other on the metamorphosis and histological investigations. Whether or not a biological study will complete the work depends upon the time at the author's disposal.

The study comprises only the North-American species *Gnathotrichus materiarius* Fitch, *sulcatus* Lec. and *retusus* Lec. The necessary material, dried and mounted adults of the two western species *Gn. sulcatus* Lec. and *retusus* Lec., was kindly provided the Dominion Entomological Branch from the Canadian National Collection in Ottawa. For the adults, pupae and larvae of *Gnathotrichus materiarius* Fitch, I have to thank Mr. L. J. Simpson, of the Dominion Entomological Laboratory, in Fredericton, N. B. All the necessary slides were prepared by the author. The specimens were dissected under water and the mounts imbedded in euporal. The drawings are all by the author, and were done with the aid of the camera lucida using transmitted light.

Attempts to obtain larvae and pupae of the western species were unsuccessful and therefore the discussion of the larval and pupal characters are based on material of *Gn. materiarius* Fitch only. A supplement on this account will be published in another paper.

ABSTRACTS OF THE LITERATURE UP TO DATE

A. THE GENUS

1868. EICHHOFF, W. (3).

Original description of the genus:

Tarsorum articulis tribus primis simplicibus. Antennarum funicolo 5-articulato, capitulo distincte triannulato. Ligula parte fulcrali angustior. Palpi labiales articulis primo et secundo subaequalibus, simplicibus, tertio minimo. Maxillarum mala apice rotundata, setis falcatis densissimis ciliata, palporum articulo primo majore obconico, secundo minore subquadrato, tertio cylindrico elongato.

With respect to the position of the genus *Gnathotrichus* in the family *Scolytidae*, Eichhoff states:

Die Gattung lehnt sich durch die Form der Arten und dichte Bewimmerung der Maxillarlapfen auf der einen Seite an die Gattung *Xyleborus*, auf der anderen an *Corthylus* und *Pterocyclon* an.

1876. LECONTE, J. L., and HORN, H. G. (9).

Leconte, knowing of the new genus *Gnathotrichus* Eichh., still places the species of this genus under *Pityophthorus* Eichh. However, he subdivided the genus into subgroups, the first of which comprised the species of the present genus *Gnathotrichus* described at his time.

1878. EICHHOFF, W.(11).

In the *Tomcini*, Eichhoff placed the Genus *Gnathotrichus* in his Section II, *Xylophagi*, subfamily *Xyleboridae*. The revised description of the genus as it was given on page 405 is:

Mentum oblongum, versus basin fortiter angustatum, post medium lateribus profunde sinuatum, et iterum versus apicem subdilatatum, apice rotundato; ligula linearis longa post medium menti inserta, versus apicem subdilatata, apice emarginata, angulis utrinque pilis longis munita. Palpi labiales valde elongati, articulis 1 et 2 longis, aequalibus, 3° parvo. Maxillae mala lata rotundata, pilis subtilibus longis intus ciliata, apice toto setis densissimis coactis cincta. Palpi maxillares articulis magnitudine gradatim decrescitibus, ultimo striis longitudinalibus obscuris notata. Antennae funiculo 5-articulato, articulo hujus 1° crassiusculo, bulbiformi, sequentibus multo minoribus, transversis, crassitie crescentibus; capitulo subgloboso, toto corneo, 3-articulato. Prosternum processu vix ullo. Episterna metathoracis a margine sinuato elytorum plane obtecta. Tibia lineares, extus remote denticulatae, apice truncatae. Tarsi haud recepti, articulis 1, 2, 3 aequalibus.

1883. LECONTE, J. L., and HORN, H. G.(13).

The authors placed *Gnathotrichus* Eichhoff in their key to the genera in the subfamily *Scolytinae*, the Tribe *Tomcini* and Group *Corthyli*. In the group it was separated from *Corthylylus* and *Monarthrum* by its five-jointed antennal funicle and from *Pityophthorus* and *Hypothenemus* by the fringed antennal club and the "outer part of the funicle very short" respectively.

1895. BLANDFORD, W. F. H.(24).

Blandford placed *Gnathotrichus* in his subgroup V *Pityophthori* which comprises the genera *Styphlosoma* Blandford, *Dendroterus* Blandford, *Pityophthorus* Eichh. and *Gnathotrichus* Eichh. He regarded *Gnathotrichus* as standing midway between *Pityophthorus* and the *Corthyli*.

The author felt himself that the first two genera of this subgroup have very little in common with the latter two; they were included in this subgroup more on account of the difficulty of placing them elsewhere.

1909. SWAINE, J. M.(40).

Only references to literature.

1910. HAGEDORN, M.(42).

References only.

1910. HAGEDORN, M.(41).

Based on the characters of the mouthparts, Hagedorn placed the genus *Gnathotrichus* in his subfamily *Saetidentatae*. His description is as follows:

Kaukante des Mittelkiefers mit Borsten besetzt.

Unfortunately he has, like other investigators, overlooked the long slender hairs of the lacinia. Therefore he misplaced the genus, which would, according to his interpretation of the characters used, fall in the subfamily *Mixtodentatae*.

1915. HOPKINS, A. D.(48).

The author placed *Gnathotrichus* in his subfamily *Corthyliinae*. No details.

1918. SWAINE, J. M.(49).

The author placed the genus *Gnathotrichus* in his subfamily *Ipinae* in one group with *Conophthorus* Hopk., *Pseudopityophthorus* Sw. and *Pityophthorus* Eichh. The latter is separated from the rest of the *Ipinae* by the following characters:

Eyes not divided, antennal funicle 5-segmented, fore tibia more strongly widened, body nearly glabrous, pronotum with numerous asperities in front, the pronotum margined on the caudal border, and the metaepisternum largely covered by the elytra.

Gnathotrichus was distinguished from the other genera of this group by:

The mouthparts as seen from below rather sparsely clothed with slender hairs, the maxillary lobe pilose, body slender, very smooth, punctures and pubescens nearly obsolete except on the declivity; the pronotum closely but freely asperate in front, with an acute, arcuate, transverse, short carina at the summit, which is before the middle.

No generic description given.

1922. BLACKMAN, M. W.(50).

Characters used by earlier authors were applied in placing the genus.

The arrangement is similar to that of Swaine (49); but the author did not use Swaine's character "mouthparts densely covered with hairs."

1928. BLACKMAN, M. W.(59).

The author uses the same characters as Swaine in separating the genus *Gnathotrichus* Eichh. from the rest of the *Pityophthorinae*. He regards the genera *Conophthorus* Hopkins, *Myeloborus* Blackman, *Pityophthorus* Eichhoff, *Pityoborus* Blackman, *Pityophilus* Blackman, *Pseudopityophthorus* Swaine and *Gnathotrichus* Eichhoff as a compact division of the *Ipinae*.

B. GNATHOTRICHUS MATERIARIUS FITCH

1859. FITCH, ASA (1).

Original description :

Pine Timber-Beetle. *Tomicus materiarius*, new species. In the interior of the sap wood, mining slender straight cylindrical burrows in a transverse direction, parallel with the outer surface, from which very short straight lateral galleries branch off at right angles above and below; a rather slender cylindrical black shining bark-beetle, 0.15 long, with pale dull yellow legs and antennae, the fore part of its thorax and of its wing covers tinged with reddish yellow; the thorax equalling two-thirds the length of the wing covers, with a small elevated tubercle in the middle, forward of which it is rough from minute elevated points; the wing covers with rows of minute punctures, their tips rounded, the upper part of the declivity with a shallow longitudinal depression or groove along the suture, forming a slight notch.

The insects belonging to the genus *Tomicus* and kindred genera of the same family by their habits divide themselves into two distinct groups. The larger portion of them reside in or immediately beneath the bark of different trees and are currently termed bark-beetles. But this designation is inappropriate for another portion of them which dwell in the interior of the wood, and there excavate their galleries. The name timber-beetles appears to be the most appropriate for these. Another point in which, from the observations of M. Perris, these two groups appear to differ in a remarkable manner, is the relative numbers of the two sexes. With the bark-beetles there are commonly several males in company with but one female, and the former appear to perform the chief part of the labor in the excavation of their galleries. With the timber-beetles, on the other hand, the females are the most numerous, and probably mine their galleries without any assistance from the other sex. M. Perris states of one of the species, that upwards of fifty females were met with in the burrows they had excavated, without a single male being found there.

It is the habit of these timber-beetles to penetrate the tree in a straight line, passing inwards through the bark and into the sap wood to a depth of from half an inch to two inches, and then abruptly turning they extend their burrow in another straight line parallel with the outer surface and at right angles with the fibres of the wood, for the length of two to six inches. The only instance in which the burrow of the species now under consideration has come under my notice, was recently, in a billet of stove wood, which unfortunately did not contain the extreme end of the gallery. The annexed cut is an exact representation of this burrow, in which a live and dead beetle were found, both of them females, and the only specimens of this species which have come under my observation. The transverse burrow was excavated in the sap wood at a depth of half an inch from its outer surface. Near its middle it was crossed by another perforation extending from the outside directly towards the heart of the tree, which is indicated by a black dot in the figure; and at this point the burrow curved slightly outwards toward the exterior surface, as represented in the section above the principal figure in the cut; and at its end on the left where it passed out of the billet of wood, it commenced curving inwards towards the heart of the tree. Twelve lateral burrows

of the same diameter as the transverse one extended upwards and two downwards, as shown in the figure, all of the same length, each one having been excavated probably by a single larva. The gallery of our insect thus differs widely from that of the European species (*T. eurygaster* Erichson) which mines in the interior of the pine, which has no lateral burrows branching off from it.

The presence of these timber beetles in the wood can be distinguished from those which mine under the bark, by the little piles of sawdust which they throw out at the mouth of their burrows, this dust being so much more white and clean, and not composed in part of the brown or rust-colored particles of gnawed bark which are intermixed with the dust produced by the bark-beetles.

In addition to the short description of this beetle which is given above, it may be observed that the head is finely punctured, the punctures on the face giving out small pale yellowish hairs, whilst those on the vertex or crown are destitute of hairs, and there is a slight transverse elevation of the surface between the face and the vertex, from which an elevated smooth line extends backwards along the middle of the vertex. Thorax, when viewed from above, with its base transverse and rectilinear, its basal angles rectangular, its opposite sides parallel for a distance equalling the length of the base, and from thence rounded in a semicircle at its anterior end; its surface anteriorly with minute asperities, which, viewed vertically, appear like fine transverse wrinkles; its basal half with very minute punctures, and in its center a small transverse tubercle. Wing covers with fine shallow punctures in rows; the upper part of the apical declivity moderately depressed in the middle, producing a slight concavity in its outline when viewed from above anteriorly, the suture not elevated in this depression, but showing a slightly impressed line along each side; the hind end bearded with hairs similar to those upon the front. Under side black, the legs and antennae pale dull yellow.

1868. ZIMMERMAN, C.(4).

In the "Synopsis of the *Scolytidae* of America North of Mexico" the author placed *materiarius* Fitch in *Crypturgus* Erich. Distribution: North Carolina, and from Maine to Canada.

1868. EICHHOFF, W.(3).

*Gnathotrichus corthyloides*¹: Valde elongatus, cylindricus, subopacus piceus, elytris basi dilutioribus, antennis pedibusque ferrugineis, thorace elongato cylindrico, antice asperato, disco subnodoso, postice omnium subtilissime vage punctulato, elytris subtiliter transversim aciculatis, subtilissime seriatim punctatis, declivitate postica convexiuscula, utrinque nodulo longitudinali a sutura remoto ornata. Long. $1\frac{1}{3}$ Lin. Patria: America borealis, Carolina.

¹"Ich vermuthe, dass *Gn. corthyloides* m. identisch ist mit *Crypturgus materiarius* = *Tomicus materiarius* Fitch (Noxious Ins. New York II. No. 24, 246), in der soeben von Mr. Leconte zum Geschenk erhaltenen 'Synopsis of the *Scolytidae* of America North of Mexico.'"

1869. PACKARD, A. S.(5).

P. 493:

A species, probably the *Cryphalus materiarius* of Fitch, has been found by Mr. Huntington, of Kelly's Island, to bore into empty wine casks and spoil them for use.

1876. LECONTE, J. L., and HORN, H. G.(9).

Pityophthorus materiarius Fitch: Canada to Texas. Synonyms: *Tomicus materiarius* Fitch, *Crypturgus materiarius* Fitch (Zimmerman), *Gnathotrichus corthyloides* Eichh.

1877. PROVANCHER, L'ABBE L.(10).

The author placed *Gn. materiarius* in *Gryphalus* Er. Found in red pine (le pin rouge). Rare.

1878. EICHHOFF, W.(11).

The description of *materiaris* Fitch given by Eichhoff in his *Ratio Tomicinorum* is by far the most correct although it was published 50 years ago. Therefore it seems to be necessary to quote it here:

Linearis, cylindricus, nigro-piceus, subopacus, parce pilosellus, thorace elongato, anterieus subtiliter rugoso-exasperato, posterius laevi, elytris basi dilutioribus, vix conspicue seriatim aciculato-punctulatis, apice rotundato, integro. Long. 3-3.2 mm.

Staturem fere et habitum coleopterorum ex genere *Pterocyclon* (*Corthylus fasciatus* Er.) exhibens, sed antennis aliter constructis. Caput deflexum, nigrum, subnitidum, fronte depressa, parce subtiliter punctata, linea media subelevata, laevi; pilis parvis, longioribus, adpersa, in margine antico non ciliato, ore inde denudato. Oculi oblongi, antice sinuati. Antennae ferrugineo-testaceae, capitulo suborbiculari, compresso, subinfusato, nitido, utraque pagina suturis duabus arcuatis notato, articulis subaequalibus. Prothorax latitudine amplius, dimidio longior, cylindricus, basi truncatus, lateribus rectis, parallelis, apice obtuse rotundatus, angulis posticis (desuper intuenti) acute rectis; supra valde cylindrice convexus, piceus, dorso ante medium lineola transversa, elevata, notatus, anterieus dilutior, subrufescens, rugis imbricatis subtiliter exasperatus, tenuissime pubescens, posterior glaber, subnitidus, laevis, imo vero oculo arcute armato, omnium subtilissime parce punctulatus. Scutellum piceum, sat magnum, triangulare, nitidum laeve. Elytra cylindrica, latitudine thoraxis et illo fere tertia parte longiora, basi truncata, humeris vix elevatis subrotundatis, lateribus rectis, a basi ad medium et ultra, post medium ad apicem fortiter rotundata; supra cylindrice convexa, nigro-picea vel brunneo-testacea, basi dilutiora, subnitida, versus apicem pilis paucis, seriatim adpersa, laevia, imo vero subtilissime lineato-punctato, interstitiis latissimis, transversim subtilissime aciculata strigulata, absque stria suturali; declivitas apicalis convexe rotundata, declivis, in singulo elythro tuberculo obsoleto, parum elevato, a sutura remoto, notata; margo apicalis communiter obtuse rotundatus. Corpus subtus nigropiceum, cerebre subtiliter punctulatum, glabrum. Pedes ferrugineo-testacei, tibiis angustis, parum compressis, antrorsum vix dilatatis, tarsis testaceis. Patria: America borealis (Carolina, Canada).

1881. PACKARD, A. S. (12).

The author does not bring out new facts but repeats the statements made by Fitch (1) and Ferris. Also he mentions again the fact given in his "Guide to the Study of Insects." Nomenclature: *Pityophthorus materiarius* Fitch.

1886. SCHWARZ, E. A. (14).

Remarks on North American *Scolytids*:

Dr. Packard in his guide, p. 493 (see also Bull. 7, U. S. Ent. Comm., p. 174) states that "a species, probably the *Cryphalus materiarius* of Fitch, has been found . . . to bore into empty wine casks and spoil them for use." This is undoubtedly a confusion of species, as *C. materiarius* lives in pine trees. The species in question was probably *Xyleborus fuscatus*, which, in my experience, bores in several kinds of deciduous trees.

1890. SCHWARZ, E. A. (16).

Mr. Schwarz also stated that upon examination of about one hundred and fifty specimens of the common *Tomicus materiarius* Fitch (now *Gnathotrichus materiarius*) he had failed to find any males among them. In fact, the male sex appears to be never described. He alluded to the rarity of, and difficulty in finding, the males of most species of those *Scolytid* beetles which bore into the solid wood, because the males never leave the burrows.

Mr. Schwarz found *Pinus inops* as a host tree of *Gnathotrichus materiarius* Fitch.

1890. PACKARD, A. S. (15).

The author repeats nearly literally the statements of Fitch (1). No new facts.

1893. HOPKINS, A. D. (17).

Gnathotrichus materiarius Fitch. Timber-beetle. Enters green sap-wood at base stumps of dying trees. Causes "pin holes," "bluing," hastens decay. Infests pine.

Adults, May 8, July 13, October 15, May 3, November 7. Wood, Hampshire, Marion, Monongalia counties, West Virginia.

Enemies: *Hister parallelus* Say.

1894. HOPKINS, A. D. (20).

Gnathotrichus materiarius Fitch. Male = description of female. Female new. Antennae with long hairs and bristles as in *retusus*. Head smooth and sparsely punctured. Additional. Male head with elongated longitudinal elevation in front, ending in an acute point just above base of mandibles.

1895. BLANDFORD, W. F. H. (24).

Only references to literature.

1895. HAMILTON, J. (23).

Gnathotrichus materiarius, not rare, pine.

1897. HUBBARD, H. G.(26).

Hubbard, like the first author, states that *Gnathotrichus materiarius* is an ambrosia beetle; that means that its main food consists of fungus mycelium. The latter is always abundant in the tunnels.

1899. HOPKINS, A. D.(27).

Gnathotrichus materiarius Fitch. Very common in sap-wood of dead and dying pine and spruce trees, logs, and stumps; widely distributed.

Hister parallelus Say was found with *Gn. materiarius* in scrub pine wood. Kanawka Station.

1901. FELT, E. P.(28).

Taken from white and pitch pine, common.

1904. HOPKINS, A. D.(31).

The eastern pine wood stainer. *Gnathotrichus materiarius* Fitch. Excavates several branching galleries from a single entrance burrow, the broods living in short side chambers in sap-wood and heart-wood of injured, dying, and recently felled pine and spruce. Eastern United States and Canada. Very common and injurious.

1905. HOPKINS, A. D.(34).

The author describes a new species of *Gnathotrichus*, namely *mitidifrons* from Mexico. In a remark he mentions the near relationship to *materiaris* Fitch. and gives the range of the latter in pines as from Maine to Florida and Texas and in *Picea* from Maine to the higher mountains of North Carolina.

1905. GARMAN, H.(33).

Garman, in describing damages caused by *Monarthrum fasciatum* and *mali*, comes to the conclusion that those injuries mentioned by Packard (5) to wine casks are most probably the same.

1905. CURRIE, R. P.(32).

Copy of Hopkins, A. D.(17).

1906. FELT, E. P.(35).

No new data. Eastern pine wood stainer.

1907. FALL, H. C., and COCKERELL, T. D. A.(36).

Gnathotrichus materiarius Fitch. Cloudcroft (Viereck).

1909. SWAINE, J. M.(40).

References to literature only.

1910. HAGEDORN, M.(41).

References only.

1918. SWAINE, J. M.(49).

Host trees: Eastern pines, spruces, and eastern larch.

1922. BLACKMAN, M. W.(50).

Author found it in only one locality in the Mississippi region (Agricultural College, loblolly pine). Otherwise it was found associated with *Platypus flavicornis* Fabr., *Ips calligraphus* Germ., and the clerid *Thaninisimus dubius* Fabr. Distribution: Eastern Canada, eastern United States, as far south as Texas and Florida. Host trees: Pines, spruce and larch. In Mississippi, in loblolly pine.

C. GNATHOTRICHUS RETUSUS LEC.

1868. LECONTE, J. L.(2).

Original description:

Cryphalus retusus. Cylindrical, slender, blackish-brown; base of elytra paler; antennae and feet yellowish; head prominent, convex, subcarinated, shining, sparsely punctured; prothorax nearly one-half longer than wide, sides slightly converging from the base and feebly rounded, tip strongly rounded, surface rough and sparsely hairy before the middle, granules tolerably coarse near the tip, behind the middle sparsely punctulate; elytra very finely rugose and distantly punctulate in rows, and with a few long hairs behind the middle, posterior declivity with a deep depression along the suture, limited each side by a longitudinal obtuse elevation, bearing on its highest portion a few very fine denticulations; suture not elevated. Long. 3.5 mm.

Collected in the coast region of California and Oregon by Doctor Horn. This species has the same form and sculpture as *C. materiarius*, but is larger and readily distinguished by the different sculpture of the posterior declivity of the elytra.

1876. LECONTE, J. L., and HORN, H. G.(9).

Pityophthorus retusus Lec.: California, Oregon, Vancouver Island. Leconte doubted his formerly described *sulcatus* Lec. and is of the opinion that this is really the male of *retusus*.

1878. EICHHOFF, W.(11).

Quotes Leconte's description.

1893. HOPKINS, A. D.(17).

Gnathotrichus retusus Lec. Timber-beetles. Enters sap-wood. Causes pin holes and bluing. Infests white pine, also other pines. Adults from Virginia near West Virginia line, October 21. Adults dead in white pine wood, August 29. Monongalia county and Virginia. The only record of *retusus* in the eastern United States.

1894. HOPKINS, A. D.(20).

In Leconte and Horn "*Rynchophora* of North America," the description of male is that of female; female description is of male. Additional: Male club of antennae with a few short, stiff hairs. No long bristles. Head with a longitudinal elevation

in front. Female antennae with a long bristle rising from the anterior edge of each joint of the funiculus, and the first and second joint of the club; also with a few long hairs, all curving upwards.

1906. FELT, E. P.(35).

Only reference to Hopkins (17).

1907. FALL, H. C., and COCKERELL, T. D. A.(36).

Gnathotrichus retusus Lec. Gallinas Cañon (Doctor Snow).

1909. SWAINE, J. M.(40).

References to literature only.

1910. HAGEDORN, M.(42).

References only.

1914. SWAINE, J. M.(47).

Swaine brings a short discussion of the habits of *Gn. retusus* Lec. and *sulcatus* Lec. In general it can be concluded that these habits are very similar to those of *Gn. materiarius* Fitch described by earlier authors. The author says:

The adult beetles excavate cylindric tunnels, about the diameter of a small pencil lead, from four to about six inches into the wood. The entrance tunnel, entering usually in the depth of a bark-fissure, passes directly through the bark and into the wood for from one to two inches; there branching takes place in a somewhat irregular fashion, though all parts of the set of tunnels extend in the same horizontal plane. Usually one long side-tunnel is cut shortly within the bark, parallel to the wood surface. The meal-like boring-dust and excrement are extruded through the entrance hole. Along the inner tunnels above and below, the females cut cup-like niches and deposit an elongate egg in each. The larva which hatches from the egg lengthens the niche in which it finds itself into a short tunnel or larval-cradle, slightly more than its own length when full grown, and transforms therein to the pupal stage, with its head toward the egg-tunnel. The pupa transforms to the adult in the cradle. The chief food of the larva, and an important food of the adult, is a peculiar fungus called Ambrosia, which grows in a dense glistening layer upon the walls of the tunnels and cradles. It penetrates the cut wood-cells and grows for a considerable distance along the vessels, but is entirely saprophytic in its relation to the wood. The walls of the tunnels are stained black for a millimeter or more in thickness. These, small, black, round, branching tunnels in the wood are characteristic of the Timber-beetles or Ambrosia-beetles.

The winter is passed by parent adults in the tunnels and cradles, and pupae and larvae of various sizes in the cradles. Apparently work is continued in these tunnels in the spring; and new tunnels are started by the young adults. A second brood appears and starts fresh tunnels early in August.

A considerable amount of injury is caused by these pine hole borers, and they are likely to become more numerous in the future, as cutting becomes more extensive. They breed in all dying trunks, and recently cut logs and stumps; never in dead and dry wood, and seldom, perhaps never, in perfectly healthy trees. The timber-beetles are particularly injurious in the west to fire injured timber. As a control measure it is suggested to pile the logs in a way that they may dry out quickly or when possible to place them in water.

1918. SWAINE, J. M. (49).

No new data concerning the description and biology. Host trees: Western hemlock, Douglas fir, western yellow pine. Distribution: Generally distributed through southern British Columbia and southward.

1922. HOPPING, R. (51).

Hopping gives for *Gn. retusus* Lec. the following Host trees: *Pinus ponderosa* Laws, *Pinus lambertiana* Dougl., *Pinus jeffreyi* Oreg. Com., *Pinus contorta* London, *Pseudotsuga taxifolia* Britt., and *Tsuga mertensiana* Bong.

D. GNATHOTRICHUS SULCATUS LEC.

1868. LECONTE, L. J. (2).

Original description:

Cryphalus sulcatus. Form, size and sculpture precisely the same as in *C. retusus*, except that the front is divergently aciculate, and the occiput is sparsely punctured; the elytra are similarly punctulate in rows, but the general surface is more distinctly and densely rugose; the retuse elevation of the posterior declivity of the elytra is but slightly prominent, and not denticulate; the hairs behind the middle of the elytra are less numerous. Long. 3.5 mm.

One specimen from the coast region of middle California was given me by Doctor Horn. The color is paler than that of the three specimens of *C. retusus* now before me, being yellowish-brown, with the base of the thorax and the sides and tip of the elytra darker. Probably more mature specimens would be darker; it is perhaps the female of the preceding, but having failed to find any sexual characters in *C. materiarius*, I am not warranted at present in so regarding it.

1876. LECONTE, J. L., and HORN, H. G. (9).

Pityophthorus sulcatus Lec. See under *retusus* Lec.

1878. EICHHOFF, W. (11).

Quotes Leconte's description.

1904. HOPKINS, A. D. (31).

Western hemlock wood stainer. *Gnathotrichus sulcatus* Lec. Excavates numerous branching galleries from a central burrow, the broods living in closely joined side chambers; in the sap-wood and heart-wood of western hemlock, Douglas spruce, giant arbor vitae, and fir. California to northern Washington; common in hemlock.

1905. HOPKINS, A. D.(34).

The author examined one specimen from Chaleo and another from Michocan, Mexico, and suggested that Blandford's *Gnathotrichus consentaneus* is identical with *sulcatus* Lec.

1905. CURRIE, R. P.(32).

Copy of Hopkins, A. D. Fir is replaced by lowland fir.

1907. FALL, H. C., and COCKERELL, T. D. A.(36).

Gnathotrichus sulcatus (Hopkins MS.). — Beulah (Skinner).

1909. SWAINE, T. M.(40).

References to literature only.

1910. HAGEDORN, M.(42).

References only.

1914. SWAINE, J. M.(47).

See *retusus* Lec.

1918. SWAINE, J. M.(49).

No new data concerning the description and the biology. Host trees: Grand fir, western hemlock, Douglas fir, western white pine. Distribution: Generally distributed throughout southern British Columbia, extending southwards. In sap-wood and heart-wood of dying and recently killed trees, and more rarely in those apparently sound.

1922. HOPPING, R.(51).

According to the author *Gn. sulcatus* breeds in the following host trees: *Pinus monticola* Dougl., *Abies concolor* Parry, *Abies magnifica* Murr., *Abies grandis* Lindl., *Pseudotsuga taxifolia* Britt., and *Tsuga heterophylla* Raf.

SYNONYMA

A. Gnathotrichus materiarius Fitch

Tomicus materiarius Fitch (Fitch, Schwartz, 1890, Packard, 1890).

Crypturgus materiarius Fitch (Zimmerman, Packard, 1869).

Gnathotrichus corthyloides Eichh.

Pityophthorus materiarius Fitch (Leconte, Packard, 1881).

Cryphalus materiarius Fitch (Provancher).

B. Gnathotrichus retusus Lec.

Cryphalus retusus Leconte, 1868.

Pityophthorus retusus Lec. (Leconte, 1876).

C. Gnathotrichus sulcatus Lec.*Cryphalus sulcatus* Leconte, 1868.*Pityophthorus sulcatus* Leconte, 1876.

COMMON NAMES

A. *Gn. materiarius* Fitch.

Pine timber-beetle (Fitch).

Timber-beetle (Hopkins, 1893).

Eastern pine wood stainer (Hopkins, 1904, Felt, 1906).

B. *Gn. retusus* Lec.

Timber-beetle (Hopkins, 1893, Swaine, 1914).

Pine hole borer (Swaine, 1914).

C. *Gn. sulcatus* Lec.

Western hemlock wood stainer (Hopkins, 1904).

THE CHITINOUS SKELETON OF THE ADULT

GENERAL APPEARANCE, VESTITURE, COLOR, AND SIZE

The general form of all three species is slender in both sexes, cylindrical, with the head concealed from above by the pronotum. The pronotum is longer than wide with the sides parallel on more than the caudal half and broadly rounded in front. The elytra are slightly narrower or as wide as the pronotum, subparallel as far as the origin of the declivity, sometimes slightly tapering posteriorly; moderately broadly rounded behind.

Length and relative proportions. (Dorsal aspect).—

Gnathotrichus materiarius Fitch.

Length of the body (elytra and pronotum; head concealed from above), 3.06 mm.

The body is 3.11 times as long as the width of the pronotum.

Width of pronotum, 0.98 mm.

The elytra are 1.46 times as long as the pronotum.

Examined specimens, 12.

Gnathotrichus retusus Lec.

Length, 3.72 mm.

The body is 3.23 times as long as the width of the pronotum.

Width of the pronotum, 1.15 mm.

The elytra are 1.54 times as long as the pronotum.

Examined specimens, 10.

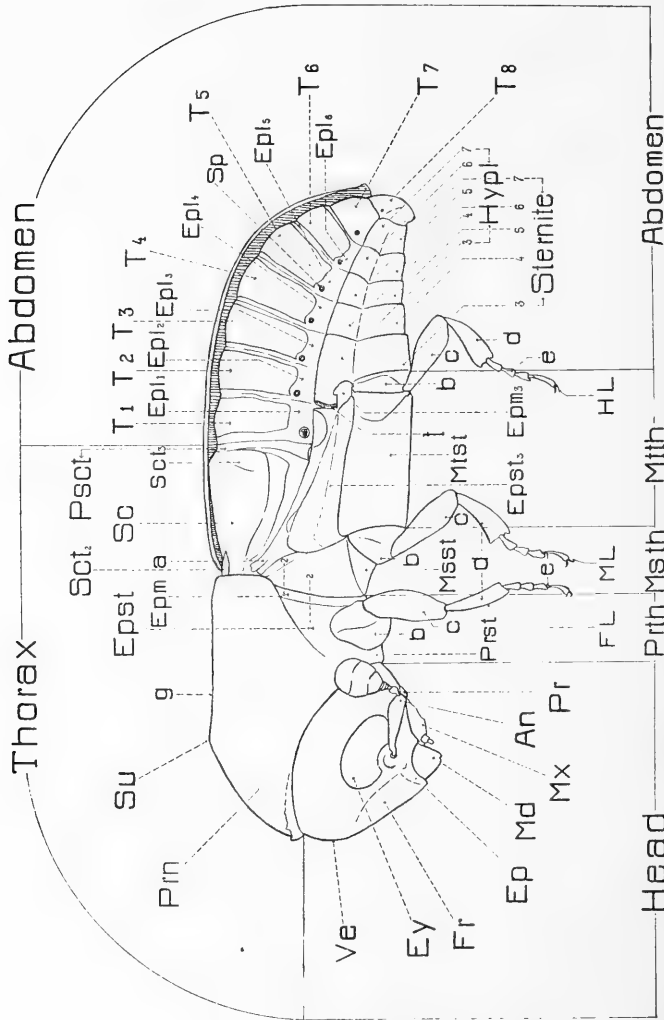

FIG. 1.—*Gnathotrichus materianus* Fitch, adult male, lateral aspect.

An, antenna; *Ep*, epistoma; *Epl*, epipleurite; *Epm*, epimeron; *Epst*, episternum; *Ey*, compound eye; *HL*, hind legs; *Hyp*, hypopleurite; *Fl*, forelegs; *Fr*, front; *Mcp*, manubrium; *Mth*, mesothorax; *Mst*, mesosternum; *Mth*, mesothorax; *Mx*, maxilla; *Pr*, pronotum; *Prc*, prescutum; *Pst*, prosternum; *Pr*, pronotum; *Sp*, spiracle; *Su*, scutum; *Stn*, sternite; *T*, tergite; *Ve*, vertex; *g*, coracoid and clavicle process; *b*, coxa; *c*, femur; *d*, tibia; *e*, tarsus; *f*, lateral wing lock; *g*, transverse impression of pronotum.

Gnathotrichus sulcatus Lec.

Length, 3.59 mm.

The body is 3.38 times as long as the width of the pronotum.

Width of the pronotum, 1.07 mm.

The elytra are 1.60 times as long as the pronotum.

Examined specimens, 10.

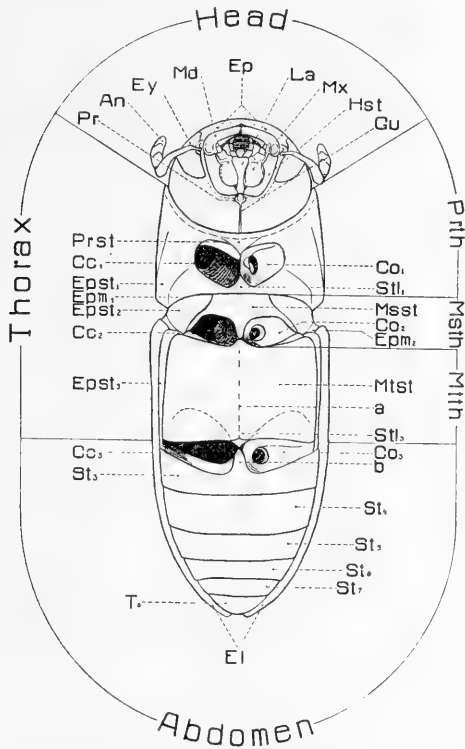

FIG. 2.—*Gnathotrichus materiarius* Fitch, adult male, ventral aspect.

An, antenna; *Cc*, coxal cavity; *Co*, coxa; *Ep*, epistoma; *Epm*, epimeron; *Epst*, episternum; *Ey*, compound eye; *Gu*, gular area; *Hst*, hypostoma; *La*, labium; *Msst*, mesosternum; *Msth*, mesothorax; *Md*, mandible; *Mtst*, metasternum; *Mth*, metathorax; *Mx*, maxilla; *Pr*, pre-gula; *Prst*, prosternum; *Prth*, prothorax; *st*, sternite; *Stl*, sternellar area; *a*, median line.

Color.—The color ranges from a reddish-brown to nearly black in mature specimens; it is of no importance in this genus.

Vestiture.—In general it can be said that all three species are without extraordinary hair characters; few large bristles occur on the declivity. However, by careful examination under the microscope it was found that all external parts are more or less covered with fine hairs.

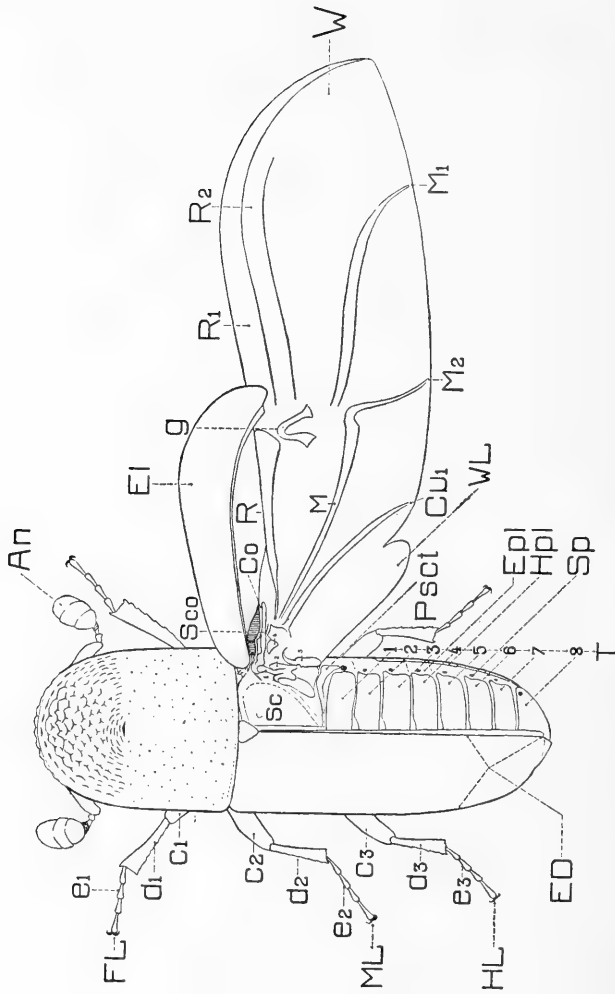

FIG. 3.—*Gnathotrichus materianus* Fitch, adult male, dorsal aspect.

An, antenna; *Co*, coxa; *Cu*, cubitus; *ED*, elytra declivity; *Epl*, epipleurite; *FL*, fore legs; *HL*, hind legs; *Hpl*, hypopleurite; *M*, median veins; *ML*, middle legs; *Pscf*, postnotum or postscutellum; *R*, radius; *Sc*, scutum of metathorax; *Scv*, subcostal vein; *Sp*, spiracle; *T*, tergite; *W*, metathoracic wing; *WL*, wing lobe; *e*, femur; *d*, tibia; *t*, tarsus; *g*, median folding hinge of wing; 1, 2, 3, 4, the four axillaries.

Sculpture.—The front and the elytral declivity are the only bearers of specific modifications. The sculpture of the pronotum and the elytra, which is very useful in distinguishing the species in many other genera of the *Scolytidae*, does not vary to any extent in this genus.

Secondary sexual characters.—Secondary sexual characters were found in the development of the hairs on the antennae, the number of fully developed tergites and in the number of spiracles mainly.

THE HEAD

The head capsula or cranium (figs. 4-7) is dorsally divided by the epicranial suture. The sutura fronto verticale Berlese or coronal suture (figs. 5, 6, Cos) is distinct in all three species examined. In *Gnathotrichus retusus* Lec., and less pronounced in *Gn. materiarius* Fitch, this suture and a short piece of the sutura metopica da Miall and Denny or frontal suture become elevated near the junction, forming a Y-like ridge. The slightly raised line (figs. 4, 5, a) which originates at the upper margin of the antennal groove (figs. 4, 6, b, 7, c) and which is directed toward this junction may be considered a remnant of the frontal suture. These anterior remnants of the frontal suture are never connected with the posterior portion.

Front.—The area between the frontal sutures is largely occupied by the frons (figs. 4, 5, 7, Fr). The shape of the front is planoconvex; the median line is slightly raised, and there is a shallow depression on each side of the latter. The front is sculptured by scratches which radiate from the center of the anterior margin, and which extend over the entire sclerite, becoming less distinct and less dense towards the outer margin. These scratches look as though they had been made with a needle point, and therefore have been called acciculation by several authors. Scattered over the acciculate area are small but deep, sparse punctures. Bristles varying from short to moderately long occur over the entire front; most of these originate in punctures. They are more numerous in the antero-lateral corners.

Specific modifications:—

A—Acciculation strongly developed, close; front with punctures near the outer margin and antero-lateral region only, with bristles very sparse in the acciculate area (fig. 5, Ac).

Gn. sulcatus Lec.

AA—Acciculation weakly developed or obsolescent, more or less restricted to the median anterior area; front elsewhere punctulate, bristles more numerous.

Gn. retusus Lec. and *materiarius* Fitch.

Labrum, clypeus and epistoma.—The labrum and clypeus are not evident as separate sclerites. The epistoma (figs. 4, 5, 7, ep), probably also containing elements of the labrum and clypeus, is not separated from the front by a distinct suture or line. It is present as a ridge and forms the anterior margin of the front. This region is widened laterally, and is connected with an elevation which surrounds the antennal

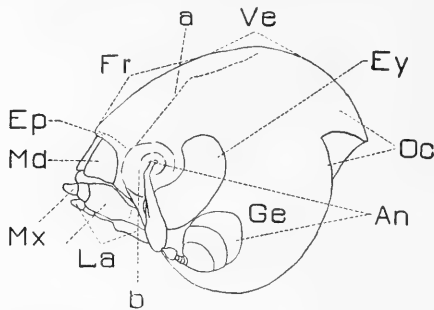

FIG. 4.—*Gnathotrichus sulcatus* Lec.: Head, lateral aspect.

An, antenna; *Ep*, epistoma; *Ey*, compound eye; *Fr*, frons; *Ge*, gena; *La*, labium; *Md*, mandible; *Mx*, maxilla; *Oc*, occipital area; *Ve*, vertex; *a*, frontal suture; *b*, antennal groove.

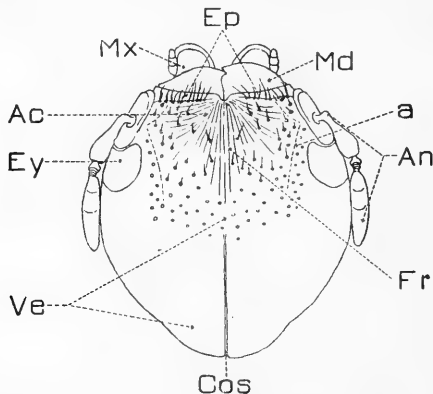

FIG. 5.—*Gnathotrichus sulcatus* Lec.: Head, dorsal aspect.

Ac, accuculation; *An*, antenna; *Ep*, epistoma; *Ey*, compound eye; *Fr*, frons; *Md*, mandible; *Mx*, maxilla; *Cos*, coronal suture; *Ve*, vertex; *a*, frontal suture.

scrobe. In the middle of the anterior margin, an evenly rounded emargination is visible which may be called serratus epistomalis (fig. 7, SE) and which corresponds to Hopkin's median impression. From the serratus epistomalis the accuculation of the front radiates. The epistoma is without sculpture and bears a row of bristles on its posterior margin. The mandibles articulate with the underside of the epistoma.

Gula.—The gula is bounded by the two very closely placed gular sutures (figs. 6, 7, Gus) and widens anteriorly to form the pregula.

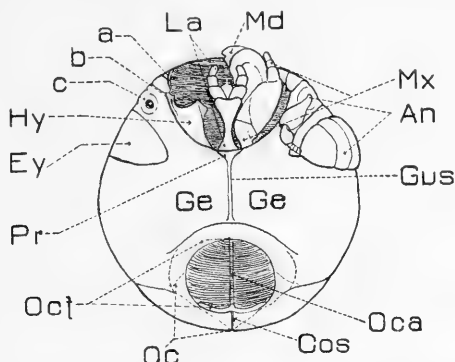

FIG. 6.—*Gnathotrichus sulcatus* Lec.: Head, ventral aspect.

An, antenna; *Cos*, coronal suture; *Ey*, compound eye; *Ge*, gena; *Gus*, gular sutures; *Hy*, hypostoma; *La*, labium; *Md*, mandible; *Mx*, maxilla; *Oc*, occipital area; *Oca*, occipital apodeme; *Ocf*, occipital foramen; *Pr*, pregula; *a*, dorsal articulation of the mandible; *b*, ventral articulation of the mandible; *c*, antennal groove.

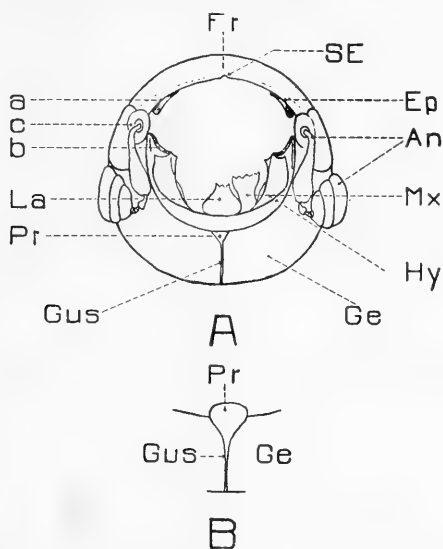

FIG. 7.—A, *Gnathotrichus sulcatus* Lec.: Head, oral aspect. B, *Gnathotrichus retusus* Lec.: Pregula.

An, antenna; *Ep*, epistoma; *Ge*, gena; *Gus*, gular sutures; *Fr*, frons; *Hy*, hypostoma; *La*, labium; *Mx*, maxilla; *Pr*, pregula; *SE*, serratus epistomalis; *a*, dorsal articulation of mandibles; *b*, ventral articulation of mandibles; *c*, antennal groove.

These two distinct sutures appear to be exceptional in this family. Hopkins apparently did not find any double sutures in his investigations.

In *Gnathotrichus*, the pregula (figs. 6, 7, Pr) is always without sculpture or hairs. The very distinct specific modifications are described in the following key:

A—Pregula flat, triangular, not produced anteriorly, its anterior margin continuous with those of the gena.

Gn. sulcatus Lec.

AA—Pregula convex, produced anteriorly, its anterior not continuous with those of the gena.

B—Pregula very convex, extending far beyond the genal margin.

Gn. retusus Lec.

BB—Pregula feebly convex, extending slightly beyond the genal margin.

Gn. materiarius Fitch.

Epicranium.—The remaining lobes of the cranium situated between the epicranial suture, the gula, and the foramen bear the compound eyes (figs. 4-6, Ey), the antennae and the articulations of the mouthparts. For merely descriptive purposes these lateral areas of the cranium have been divided into several regions. The occipital area (figs. 4, 6, Oc) surrounding the occipital foramen is not limited anteriorly in *Gnathotrichus*. However, there occur obscure lines which may be regarded as homologous with the occipital suture. The epicranium or parietals (Crampton), the gena, and the vertex do not show any sculpture which exhibits specific differences. The hypostoma (Hopkins) (figs. 6, 7, Hy), an area corresponding to the epistoma, which like the former belongs morphologically to the epicranium, is well developed.¹ It is in the form of a semicircular band and bears at its extremities the ventral articulations (figs. 6, 7 b) of the mandibles. From the oral aspect it is visible; from the ventral, it is hidden by the pregula and the gena.

Other regions, such as the pregena (Hopkins), etc., are not at all distinct or limited and are therefore of no interest in this discussion.

THE APPENDAGES OF THE HEAD

THE ANTENNAE

The antennae present good generic characters; the species modifications are less important. The sexual differences are distinct also. All the longer setae of the antennae are feathered.

¹ The hypostoma, as the term is used here, or the ventral angles of the postgena, is the bearer of the maxillare and not the labium. A submentum, as this term was used by Hopkins in *Dendroctonus*, is not defined by sutures.

The scape (fig. 8, A, S) is slender and clavate toward the apex. Hairs and punctures are rather sparse. The scape is about as long as the funicle and the club together. The funicle (fig. 8, A, F) is

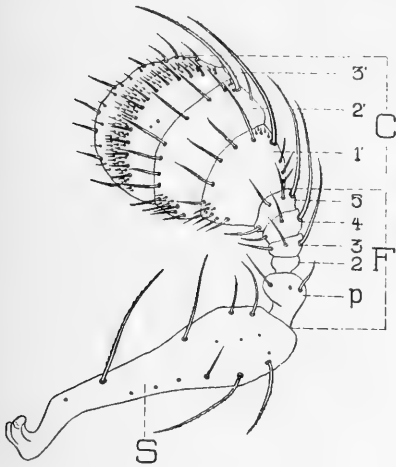

FIG. 8, A.—*Gnathotrichus retusus* Lec., adult female: Antenna, internolateral aspect.

C, antennal club; F, funicle; S, scape; p, pedicle; 2, 3, 4, 5, joint of the funicle; 1', 2', 3', joints of the club.

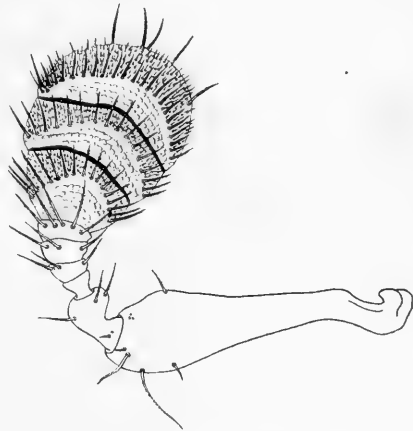

FIG. 8, B.—*Gnathotrichus retusus* Lec., adult female: Antenna, externolateral aspect.



FIG. 8, C.—*Gnathotrichus sulcatus* Lec., adult male: Antenna, externolateral aspect.

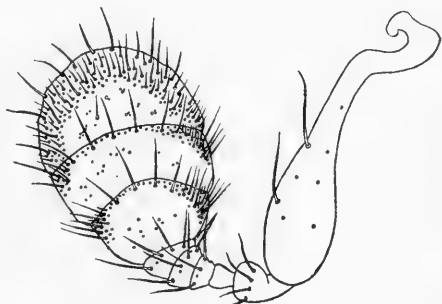

FIG. 8, D.—*Gnathotrichus sulcatus* Lec., adult male: Antenna, internolateral aspect.

five-jointed and distinctly shorter than the club. The pedicle (fig. 8, A, p) the first and longest of all joints, is as long as joint two and three together. The setae and punctures are more concentrated on the apical half of the pedicle, only two small bristles occurring near the basal articulation (fig. 8, B). The other joints decrease in

length but increase in width towards the club. All the joints bear numerous punctures and hairs except the second which has neither. The club (fig. 8, A, C) is from 1.21 to 1.35 times as long as wide, egg-shaped in outline, widest near the apex and strongly compressed. Two nearly continuous septate sutures divide the club into three joints. The first and third joints are nearly equal in length; the second is distinctly shorter. The septae are arcuate and distinctly visible from the externo-lateral aspect (fig. 8, B, C). On the interno-lateral side (fig. 8, A, D) they are indicated by single sutures. Each of the joints is covered by numerous hairs and punctures. Externolaterally these are closely placed and arranged in arcuate rows; internolaterally, they are sparse, and the punctures are more numerous.

The females (fig. 8, A) bear, moreover, on the interno-anterior margin of the club a few very long hairs. The anterior setae of the third, fourth, and fifth joints of the funicle are longer in this sex. These are the only external characters by which the sexes may be distinguished when the elytra are kept in the closed position.

Specific modifications:—

A—Septae in the form of continuous bands of equal width throughout, slightly less pronounced medially; externo-lateral side of the club with minute, transverse wrinkles and small punctures producing a slightly roughened surface (fig. 8, A, B).

Gn. retusus Lec.

AA—Septae wider laterally, indistinct and narrow medially; externo-lateral side of the club smooth or with very minute, sparse wrinkles; club stouter.

B—Externo-lateral side of the club smooth, interno-lateral side with numerous hairs and punctures (fig. 8, C).

Gn. sulcatus Lec.

BB—Externo-lateral side of the club with minute wrinkles, interno-lateral side with very few hairs and few punctures; club very stout.

Gn. materiarius Fitch.

THE MOUTHPARTS

The mouthparts present generic as well as specific characters. They include the mandibles, the first maxilla and the second maxillae or labium.

Mandibles.—The mandibles (fig. 9) are very much alike in all three species, so much so that it is not possible to distinguish them by mandibular characters. The shape is stout and triangular as in most Scolytidae. The apical tooth (fig. 9, a) and the subapical tooth (fig. 9, b) are well developed and separated by a deep emargination. In contrast to other genera, two median teeth (fig. 9, c) occur. The latter are rather feebly developed and the separating emargination is shallow. The molar tooth (fig. 9, d) is evenly rounded. There are one lateral and two dorsal setae (fig. 9, f, g). Other details are illustrated in figure 9. No specific differences have been found in these.

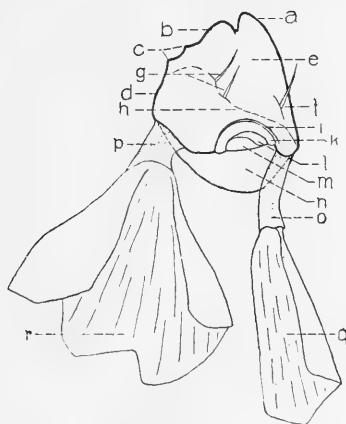

FIG. 9.—*Gnathotrichus materiarius* Fitch: Mandible, dorsal aspect.

a, apical tooth; b, subapical tooth; c, median teeth; d, molar tooth; e, dorsal area; f, lateral bristle; g, dorsal bristles; h, transverse ridge; i, anterior fossa; k, condyle; l, posterior fossa; m, posterior impression; n, condyle of ventral articulation; o, extensor tendon; p, retractor tendon; q, extensor disk; r, retractor disk.

The Maxilla.—The maxillae (figs. 2, 6) are exposed on each side of the labium. Each is held in such a way that the cardo is parallel with the long axis of the head; the stipes, lacinia, and galea are at right angles to the cardo; the second and third palpal joints are slightly curved outwards. The galea and lacinia are represented by two lobes which are fused except at the apex where they are separated by a moderately deep notch. The stipes is separated from these fused lobes by a very fine, feeble suture on the outer side; on the inner side, no suture is evident. Another paper will deal with the generic differences in the maxilla of *Gnathotrichus* Eichh. and related genera. Nevertheless, it should be noted that, as far as known at present, the labium and the maxillae in the genus *Pityophthorus* Eichh. always bear at least a few feathered bristles; in *Gnathotrichus*

Eichh. these bristles are simple. This is important, as it has been seen that the character "maxilla spinose" in *Pityophthorus* Eichh. and "maxilla pilose" in *Gnathotrichus* Eichh., as used by several

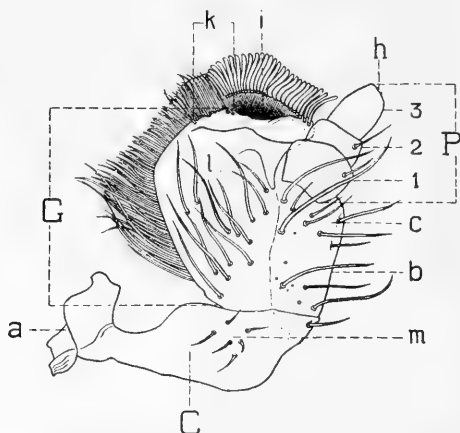

FIG. 10.—*Gnathotrichus sulcatus* Lec.: Maxilla, outer aspect.

C, cardo; G, galea; P, palpus; 1, 2, 3, first, second and third joint of the palpus; a, articulation of the maxilla; b, stipes; c, palpiferal area; i, anterior emargination separating galea and lacinia; k, dorsal setae of the galea; l, median setae of the galea; m, cardol setae.

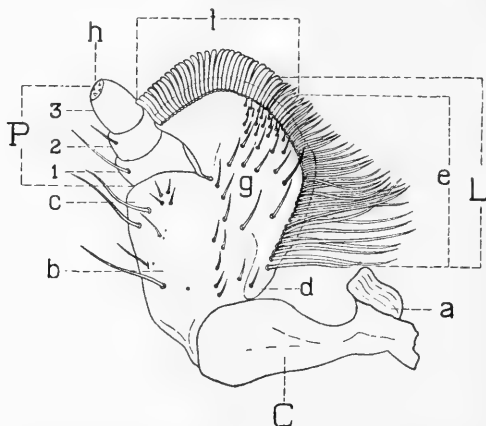

FIG. 11.—*Gnathotrichus sulcatus* Lec.: Maxilla, inner aspect.

C, cardo; L, lacinia; P, palpus; 1, 2, 3, first, second and third joint of the palpus; a, articulation of the maxilla; b, stipes; c, palpiferal area; d, subgaleal area; e, posterior setae of the lacinia; f, dorsal setae of the lacinia; g, median setae of the lacinia; h, papilla.

authors to separate *Gnathotrichus* Eichh. from the rest of the *Pityophthorinae* does not hold, as will be shown in the discussion of the lacinia and galea. The maxillae exhibit no specific differences of importance in *Gnathotrichus*. The maxillae are illustrated in figures 10 and 11.

Cardo.—The cardo (C) is similar in shape in all three species and is articulated with the ventral angles of the postgena in such a way that the maxilla can be moved laterally as well as in a dorsal-ventral plane. The longitudinal axis of the cardo and that of the stipes (b) enclose an angle of about ninety degrees or even a little less. The articulation of the stipes and the cardo is similar to that of other genera of the family. There is also an articulation between the subgalea and the cardo. In figure 12, which illustrates this fact, the cardo and the rest of the maxilla are stretched to show the connection. The inner side of the cardo is smooth; the outer side shows from five to seven hairs which may be called the cardol setae (m).

Stipes.—On the outer side the stipes is defined as an elongate, sub-parallel sclerite; on the inner side it is fused with the lacinia. The



FIG. 12.—*Gnathotrichus materiarius* Fitch.: Maxilla, stretched, the subgalea showing.

setae are not very numerous, about six to eight being present. These are more concentrated anteriorly near the base and near the apex. The latter, situated on the apical area of the stipes, may correspond to the palpiferal setae of some authors. The palpifer (c) being a topographical area of the stipes only, is not limited by lines or sutures.

Lacinia and galea.—The lobus internus or the lacinia and the lobus externus or the galea are largely fused to form a single large lobe. Apically they are distinctly separated by a moderately deep emargination (i) or notch. The inner free lobe is distinctly larger than the outer one. Posteriorly they are fused. It will need much further investigation to decide the exact areas of these two lobes. In the meantime it is proposed to call the inner lobe and the inner surface of the combined lobes the lacinia and the outer free lobe and the outer surface of the fused part the galea.

The lacinia bears on the anterior portion of the free dorsal margin short, stout, blunt setae (f) which are slightly incurved at their tips.

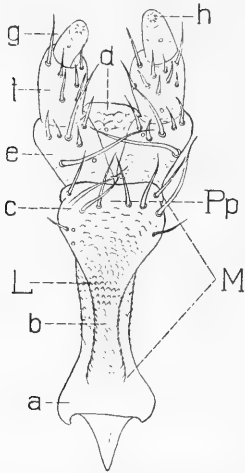

FIG. 13, A.—*Gnathotrichus retusus*
Lec.: Labium, ventral aspect.

L, ligula; *M*, mentum; *Pp*, palpifer; *a*, base of ligula; *b*, neck of mentum; *c*, ventral setae of the palpifer; *d*, anterior part of ligula; *e*, first joint of palpus; *f*, second joint of palpus; *g*, third joint of palpus.

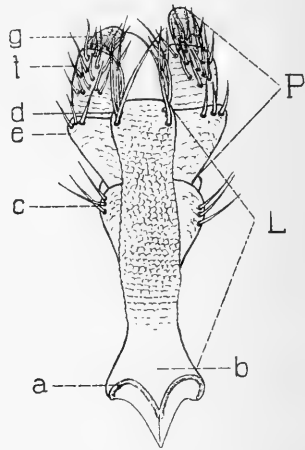

FIG. 13, B.—*Gnathotrichus retusus*
Lec.: Labium, dorsal aspect.

P, palpus; *L*, ligula; *a*, articulation of the labium; *b*, base of ligula; *c*, dorso-lateral setae of the palpifer; *d*, dorso-anterior setae of the ligula; *e*, *f*, *g*, first, second, and third joint of the palpus.

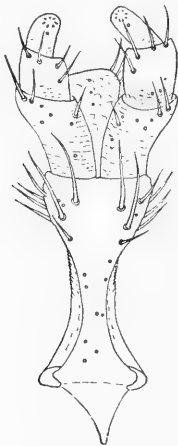

FIG. 13, C.—*Gnathotrichus sulcatus*
Lec.: Labium, ventral aspect.

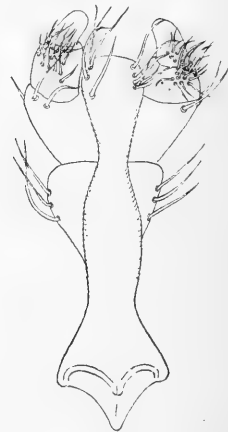

FIG. 13, D.—*Gnathotrichus sulcatus*
Lec.: Labium, dorsal aspect.

These setae gradually become longer, more slender, and pointed posteriorly (e). Near the subgaleal area (fig. 11, d) they are about three times as long as on the dorsal margin. Besides these setae on the outer

margin of the lacinia numerous bristles (g) are scattered over the entire lobe; the surface is slightly reticulate. Basally, the united lacinia and galea end in a lobe, the subgaleal area (d), which is distinctly defined on the inner side by an impressed line. The galea bears a short row of slender setae (k) on its free dorsal margin; the surface is armed with rather sparse, long hairs (e).

Adopting the terms of other authors, it may be said the lacinia is pilose on its dorsal margin and spinose on its posterior and that the galea is spinose.

Palpi.—The palpi (P) are three-jointed. The first joint is the longest, the second and the third are subequal in length. Anteriorly joints one and two bear setae, joint three punctures only. There occur slight differences in the size and the shape of the joints in the species, but they are not distinct enough to be of importance.

Labium.—The labium (fig. 13), consisting of the mentum, the ligula, and the palpi mainly, presents the most important generic and specific characters of the mouthparts.

The shape of the mentum (fig. 13, M) is similar in all three species. It is flask shaped, the palpifera always being wider than the neck (fig. 13, b) and the base of the mentum and the latter always narrower than the ligula (fig. 13, L). The basal portion of the mentum is feebly widened in *Gn. retusus* Lec. (fig. 13, A) and strongly widened in *Gn. materiarius* and *sulcatus* (fig. 13, C). In *Gn. sulcatus* and *materiarius*, the mentum and the ligula are separated by deep sutures throughout, even at the extreme base of the ligula; in *retusus* they are similarly distinct except at the extreme base before which they completely disappear. The sculpture of the mentum on the ventral side (fig. 13, C), except for a few distinct punctures, is smooth in *Gn. sulcatus*. *Gn. materiarius* is very similar but it shows slight evidences of transverse wrinkles also. In *Gn. retusus* the punctures are obsolete; the wrinkles are strongly developed and become on the neck of the mentum and the basal half of the palpifer more or less toothlike (fig. 13, A). All the setae are simple bristles (c), and there are eight to ten of these bristles on each half of the ventro-lateral side of the apical third of the palpifer. In *Gn. retusus* and *materiarius* there are ten of these bristles; in *sulcatus* eight is the usual number.

Ligula.—In this genus, the ligula (L) is much larger and more prominent than is usual; it is wider than the mentum in its basal half and is distinctly limited by sutures at the extreme base of the labium except in *retusus*. The ligula (fig. 13, L) extends in all three species a little farther anteriorly than the first joint of the palpus. Its

shape is elongate; it is subparallel with two more or less distinct contractions when viewed from the dorsal aspect. The basal portion is semicircular in cross-section, while the anterior, unfused part is strongly compressed. In *Gn. retusus* Lec., the ligula is more parallel and the contractions less distinct than in the other species.

The anterior margin is very feebly, shallowly emarginate or evenly rounded; however, this does not seem to be constant in individuals of the same species. On the ventral aspect, there is on each side near the anterior margin a row of setae (d). No specific differences have been found either in the shape or in the number of these setae which vary in number from three to seven in each row. The sculpture of the ligula on the ventral aspect in all three species is very much alike, being nearly smooth or feebly transversely wrinkled. Dorsally *Gn. retusus* shows similar transverse, toothlike wrinkles on the mentum; the basal portion only is smooth. *Gn. materiarius* and *sulcatus* have the corresponding area smooth with slight indications of transverse wrinkles on the sides.

Palpi.—The palpi are directed ventrad. Each is composed of three segments, decreasing in size toward the apex. Segments two and three bear dorsally a plush-like arrangement of hairs, while the first joint has a few scattered hairs only. Ventrally, the setae are more sparse and are intermixed with punctures on segments one and two; segment three has no setae but a few punctures.

Summary of the specific characters.—

A—Base of the mentum scarcely widened basally, fused with the ligula before the basal margin of the latter; mentum and ligula when seen from above with strongly developed, toothlike, transverse wrinkles; ligula subparallel. *Gn. retusus* Lec.

AA—Base of the mentum distinctly widened basally, extending to the basal margin of the labium; mentum and ligula when seen from below smooth or with slight indications of transverse wrinkles; contractions of the ligula well developed.

B—Ventral side of the mentum smooth, with few punctures.

Gn. sulcatus Lec.

BB—Ventral side of the mentum with transverse wrinkles.

Gn. materiarius Fitch.

THE THORAX

The three segments of the thorax, pro-, meso-, and metathorax (figs. 1, 2 and 3) are clearly defined in this genus as is usual in this family. Each of these segments has as a basis three primitive ele-

ments, the dorsal plate, or tergum, the ventral plate, or sternum, and the lateral area, or pleuron. The thoracic segments and their elements vary considerably in shape and size. The protergum, or pronotum, is nearly twice as long as the tergum of the metathorax. The mesotergum, still shorter than the latter, is represented by a short triangular area only. The prosternum is about half as long as the metasternum and about one-third the length of the pronotum, giving the pleural area of the prothorax the shape of a trapezium. The mesosternum is present as a plate nearly equal in size to the mesotergum; the mesopleura are also developed in proportion, giving the mesothorax the shape of a short tube. The metathorax, more complicated in structure, represents the segment in which all three primitive elements are well developed and defined.

THE PROTHORAX

In the prothorax the tergal, pleural and sternal areas (fig. 14) are fused, forming a continuous chitinous tube. However, corresponding elements to other thoracic segments are visible due to the different kinds of sculpture. Taxonomically the prothorax bears generic characters but none of specific importance. The two openings of the tube-like prothorax, the anterior and posterior foramina, are bordered by a fringe of closely placed hairs which arise from the inner margin.

Pronotum.—The pronotum (figs. 1, 2, 3 and 14) is one solid plate by which the head is concealed. The dimensions are as follows:

Gn. materiarius Fitch., length, 1.23 mm., width, 0.98 mm.

Gn. retusus Lec., length, 1.44 mm., width, 1.15 mm.

Gn. sulcatus Lec., length, 1.35 mm., width, 1.07 mm.

The measurements are the average of 10 specimens from each species.

Seen from above, the sides of the pronotum are subparallel on the posterior margin, while the anterior margin is broadly rounded. The anterior margin bears 10 to 16 low serrations which are only slightly longer toward the median line and sometimes fused at their base. On the anterior area, that is, the area in front of the summit which consists of a short slightly curved ridge and is placed a short distance before the middle of the pronotum, occur many comparatively small and low serrations arranged in concentric rows and decreasing in size towards the summit. Behind the summit the surface of the pronotum is covered with punctures. There are two kinds of punctures; the one comparatively coarse in contrast to the other but fine compared to those in other nearly related genera; the other, minute and only

visible under higher magnification. The coarser punctures are sparse, deep and distinct, the minute ones closely placed giving this part of the pronotum a more opaque appearance. The posterior margin is slightly arcuate. Immediately anterior to the posterior margin there is an impressed line giving the intermediate space the appearance of a low ridge. This raised margin served as one of the main characters in placing this genus near *Pityophthorus* and allied genera. The pronotum is covered with inconspicuous hairs which are longer and

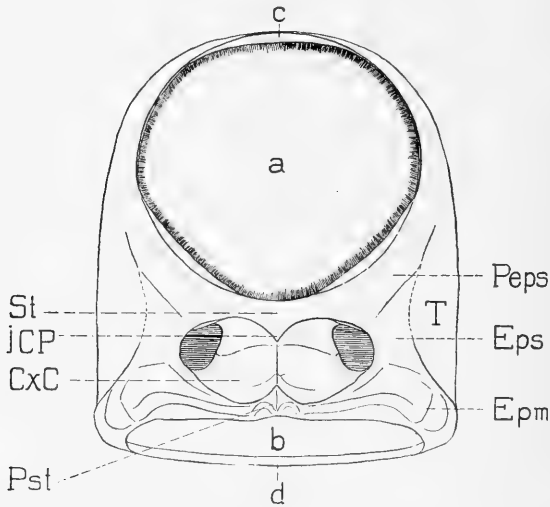

FIG. 14.—*Gnathotrichus sulcatus* Lec.: Prothorax, ventral aspect.

a, anterior foramen; *b*, posterior foramen; *c*, anterior margin of pronotum; *d*, posterior margin of pronotum; *Cx C*, coxal cavities; *Epm*, epimeral area; *Eps*, episternal area; *ICP*, intercoxal process; *Peps*, preepisternal area; *Pst*, poststernal area; *St*, sternal area; *T*, tergum or pronotum.

coarser anteriorly. Posterior to the summit occurs a shallow transverse impression. The lateral limitations of the pronotum are not clearly defined but near the postero-lateral angle is a longitudinal ridge which may be considered as a remainder of the pleuro-notal suture.

Pleural area.—The propleural area (fig. 14) is represented as one continuous plate in the shape of a trapezium of which the base is formed by the remainders of the pleuro-notal suture. Ventrally the pleural area is completely fused with the prosternum (*St*). Externally no sufficiently distinct lines are present to justify the distinction of subdivisional plates as episternum, epimeron, etc. Nevertheless there can be distinguished three parts of different structure which one may call the preepisternal (*Peps*), the episternal (*Eps*) and the epimeral

area (Epm). The preepisternal area is flattened, slightly depressed with a surface smooth except for a few minute wrinkles parallel to the longer axis. The episternal area is entirely covered by continuations of the serrations which occur on the anterior half of the pronotum. A narrow strip along the posterior margin of the propleuron, quite distinctly limited to the surrounding plates by its transverse wrinkles, may be called the epimeral area.

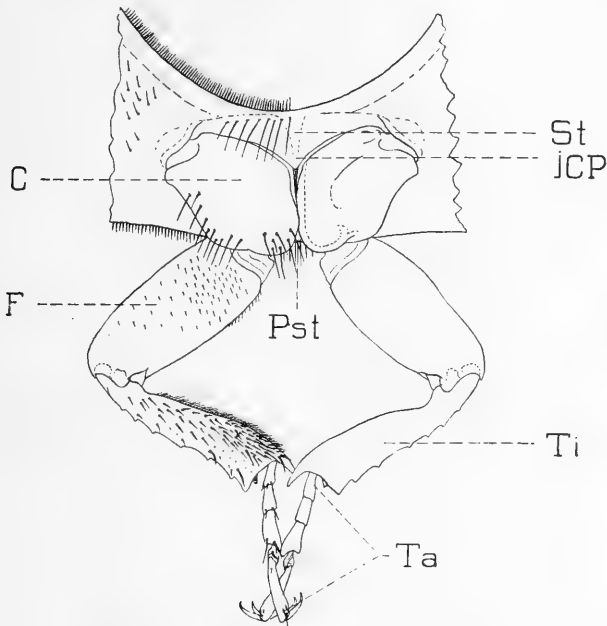

FIG. 15.—*Gnathotrichus retusus* Lec.: Prosternum and fore legs.

C, coxa; *F*, femur; *ICP*, intercostal process; *Pst*, poststernal area; *St*, sternal area; *Ta*, tarsus; *Ti*, tibia.

Sternal area.—The lateral ill-defined sternal area is largely occupied by the coxal cavities (Cx \times C). The intercoxal process (ICP) belonging to the intercoxal or sternellar plate is clearly defined and very short so that the coxae touch each other. The sternum proper and the presternal area are again not limited by sutures but by differences in sculpture.

Prothorax.—The distinguishing characters of the prothorax are:

1. The pronotum of *Gn. materiarius* Fitch is a little more slender than that of *Gn. retusus* Lec. and *sulcatus* Lec.
2. The punctures of the posterior half of the pronotum of *Gn. retusus* Lec. are somewhat coarser than in the case of the others.

THE MESOTHORAX

The mesothorax is the shortest of the three thoracic segments. The form is that of a ring with the anterior diameter smaller than the posterior one. The meso- and metathorax are very closely connected, giving the appearance of one single unit. Seen from above (dorsal) the scutellum only is visible, while in the lateral and ventral aspect the mesopleura and the mesosterna can be distinguished. The two

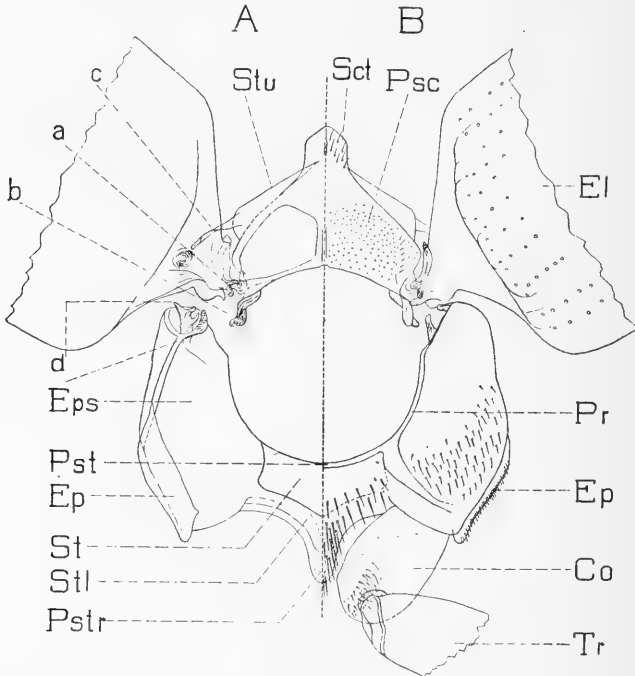

FIG. 16.—*Gnathotrichus retusus* Lec.: Mesothorax, view from anterior foramen. The parts are disconnected by stretching under the coverglass.

A, external aspect; *B*, internal aspect; *Co*, coxa; *El*, elytra; *Ep*, epimeron; *Pr*, preepisternum; *Psc*, prescutum; *Eps*, episternum; *Pst*, presternum; *Pstr*, poststernellum; *Sct*, scutellum; *St*, sternum; *Stl*, sternellum; *Stu*, scutum; *Tr*, trochanter; *a*, articulation of elytra; *b*, clavicola; *c*, pleural hook of scutum; *d*, pleural clavicola.

pairs of appendages are implanted between the pleura and tergum and the pleura and sternum respectively.

Mesonotum.—From the mesonotum or tergum only the scutellum is exposed dorsally. The rest of the notum is covered by the elytra laterally and is hidden by the pronotum anteriorly.

The scutellum.—The scutellum (fig. 16, *Sct*) is a triangular plate, heavily chitinized, covered with short bristles, and externo-anteriorly fused with the prescutum. There occur slight differences in shape in the different species but they are of no importance.

Scutum.—The scutum (fig. 16, Stu) is represented as two slightly chitinized lobes which are anteriorly fused with the prescutum. The posterior ends are free and lie under the scutellum. A long slender pleural hook (c) originates near the extreme lateral angle.

Prescutum.—The largest area of the mesonotum is occupied by the triangular prescutum (fig. 16, Psc). Externally it forms with the scutellum a smooth continuous plate. The inner side consists of two large and shallow excavations which are surrounded by heavily chitinized ridges. The median ridge is anteriorly divided by two closely placed sutures. Obscure remainders of these sutures are also visible externally and on the scutellum. The extreme anterior corners of the prescutum are produced into two prominent hooks which may correspond to Hopkins' "Lateral arm of prephragma and prescutum" or Korschelt's "Zapenfortsatz des Mesonotums," or Berlese's "clavicola." The clavicola (b) is hinged in parts of the pleural claviculas. At a short distance behind the clavicola is a well developed prealar process which embraces the third axillary of the elytra. On the anterior two-thirds of the prescutum, numerous small punctures are visible externally and near the lateral margin occurs a single row of minute hairs.

The prephragma and the postscutellum are not represented by separate plates. Remainders of the former are probably the wide anterior ridge of the prescutum.

Mesopleura.—The mesopleura are distinctly defined from the tergum and sternum. The largest area of each is occupied by the episternum (Eps) which is a strongly chitinized plate, elongate, with the lateral dorsal area smooth and with a fine pubescence on the lateral ventral area. A narrow strip in front of the episternum, which is defined externally by a suture, and a continuation of it towards the ventral posterior angle of the episternum, may represent the preepisternum. Dorsally the preepisternum is produced into the clavicular-disk. Under the ventral half of the episternum projects a narrow plate, the epimeron (Ep). Preepisternum and epimeron are structureless but the latter bears on its posterior margin a row of fine hairs.

Mesosternum: Presternum.—A narrow ridgelike plate which is fused with the preepisternum (fig. 16, Pr) of the pleura represents the presternum (Pst). The rest of the sternum is externally defined from this by a suture. Internally the suture is obsolete.

Sternum.—The sternum (St) is a rectangular plate with its posterior side produced into an angle, externally fused with the sternellar area or intercoxal process (Stl) but internally defined by a suture. The outer surface is smooth and bears a row of bristles and also a few punctures.

Sternellar area.—The sternellar area is strongly produced posteriorly and internally defined by a suture from the postero-sternellar piece.

Poststernellar area.—This piece (Pstr) is a narrow continuation from the sternellar area. Externally both are covered with long bristles.

THE METATHORAX

Metatergum.—The general appearance and structure is illustrated in figures 1, 2 and 3, which also show the two main parts, namely the notum and the postnotum, or pseudonotum, as the postnotum is often called. The latter is well developed and connected with the notum by a transparent membrane (a). The dorsal aspect of the metatergum is shown in figure 17; the inner in figure 19.

Metanotum.—The metanotum (figs. 17, 19) is typical in *Gnathotrichus* in so far as the prescutum (Psc) is only loosely connected with the scutum (Sct). The connection consists medially of a transparent membrane (b); laterally the extreme ends of the posterior prealar process (d) are fused with the lateral margin of the scutular lobes. In this connection it should be mentioned that Hopkins' pre-scutal lobe seems more likely to be a part of the scutum than of the prescutum. Other modifications are the overlapping of the scutum beyond the posterior prealar process and the development of the scutellum.

The metanotum is clearly defined into three transverse divisions which are the prescutum, the scutum and the scutellum.

Prescutum.—The prescutum (Psc) forms a well developed transverse band extending from pleuron to pleuron. Medially it is bent downwards, forming a ventral reflected lobe which may correspond to the prephragma in other insects. A precosta is not present as a plate defined by lines or sculpture. On the level of the interior origin of the anterior apodeme a suture extends interiorly separating the posterior prealar process from the prescutum proper. This process extends laterally, is covered by the scutular lobe and is fused with it at the extreme end. From the antero-lateral corners of the prescutum proper originate two prominent hooks, the anterior prealar processes (f). Laterally to the anterior prealar process are two disklike formations on each side (g, h) connected with the posterior prealar process. According to Hopkins, the posterior disk (prescutal disk) serves for the small muscles connecting it with the pleural clavicle. A rather intensive investigation would be necessary to determine the purpose of all these formations and homologize them with similar equivalent parts in other groups.

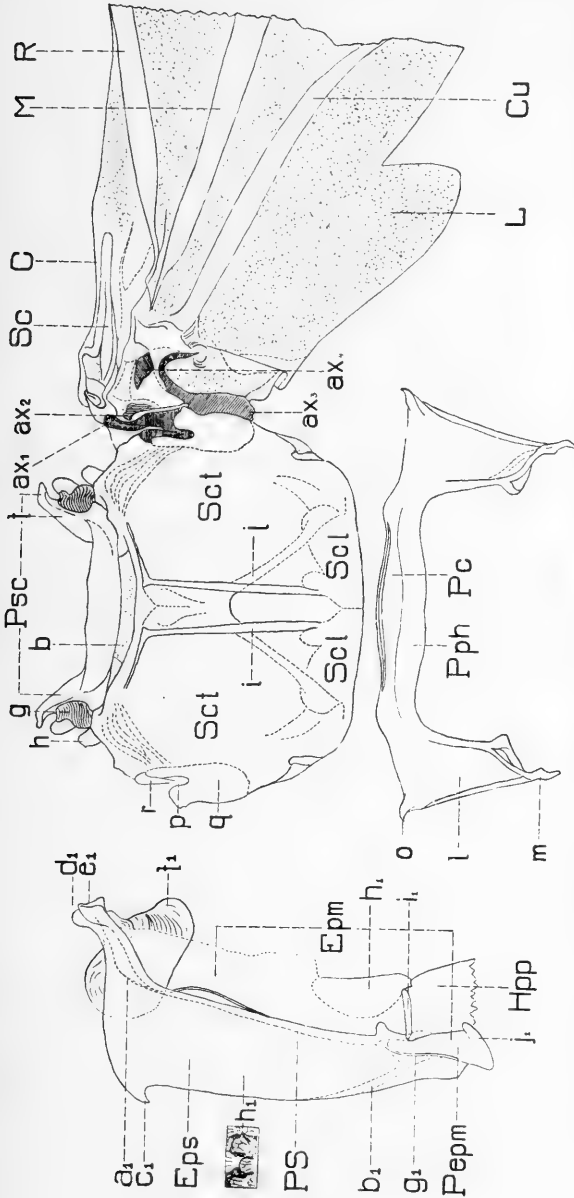

Fig. 17.—*Gnathotrichus retusus* Lec.: Metatergum and metapleuron, dorsal aspect and lateral aspect respectively. C, costal vein; Cu, cubital vein; Epm, epimeron of metapleuron; Eps, episternum of metapleuron; M, median vein; Pc, precosta of postnotum; Peph, postepimeron of metapleuron; Pph, postpimeron of postnotum; PS, pleural suture; Psc, prescutum; R, radial vein; Sc, subcostal vein; Sct, scutellum; Hpp, hypopleurite; L, lateral wing lobe; ax1, axillary of the wing base; b, anterior membrane; a, anterior prescutellar disk; h, posterior prescutellar disk; t, scuto-scutellar suture; j, median apodeme or endodorsum; f, anterior prealar process; l, prealar bridge of postnotum, or postscutellar suture; m, median apodeme of pleural suture; P, lateral emargination; q, lateral impression; s, scapular hook; a1, anterior branch of pleural suture; o, posterior branch of pleural suture; c1, anterior ventral angle of episternum; d1, clavicle process; e1, caracoid process; f1, promotor disk; g1, epimeral suture; h, structure of episternum; i1, lateral wing lobe; j1, postepimeral hook.

Scutum.—The largest plate of the metanotum is the scutum extending backward from the anterior membrane (b). The limitation between the scutum and the scutellum, the scuto-scutellar suture, is visible as a ventrally elevated ridge which becomes indistinct laterally. The anterior apodeme divides the scutum in two subdivisions, the scutum proper and the scutular lobes. The latter extend beyond the posterior prealar process of the prescutum as was stated above and cover the process dorsally. Externally the scutum is one continuous half spherical plate medially divided by the scutular groove. Internally projections of the scutellum extend far into the scutum. From the inner externo-lateral corners of the scutum proper arise two pairs of parapsidal ridges (k) which converge in a slightly curved line medially.

Scutellum.—The scutellum, which is posteriorly limited by a membrane (a), encloses the scutum in a half circle. The scuto-scutellar suture is produced anteriorly forming the lateral limitations of the scutellar groove. It extends to the anterior margin of the scutum. The space between the produced suture is strongly depressed externally forming a wide scutellar groove. The posterior end of the mesoscutellum rests in this groove. From the posterior lateral corners of the scutellum arise two armlike formations which converge anteriorly meeting at about the middle of the scutum. These formations correspond to the endodorsum (Amans), V-shaped ridge (Snodgrass), or median apodeme (Hopkins). Where they join they are connected with the scutellar groove. It is likely that the intensive study of the endodorsum of the Scolytidae will bring out many new features for the systematic arrangement of this group.

Postnotum.—The postnotum or pseudonotum is subdivided into three transverse divisions, the precosta (Pc), with the prominent prealar bridges (l) and the postphragma (Pph). The precosta is a simple band separated from the postphragma by the postnotal apodeme. Laterally it is produced into prominent prealar bridges. The inner margin is developed as a heavily chitinized ridge which is posteriorly divided, forming a ring and externally produced into a slender hook, the prealar hook (m).

The postphragma is a slightly ventrally bended band. The postnotum is visible externally, giving the appearance of a reduced tergum at the first abdominal segment.

Metapleura.—The pleuron of the metathorax (fig. 17) consists chiefly of two plates, the episternum (fig. 17, Eps) and the epimeron (Epm). The pleural suture (Ps) is externally represented as a distinct line, internally as a ridgelike structure. From the pleural suture

branch three other sutures or ridges. Anteriorly there is a short suture dividing the parapterum from the wing process; posteriorly another ridge separates the postepimeron (Pe_{pm}) from the rest of the epimeron. Ventrally another ridge indicates that part of the episternum which is covered by the sternum and the metacoxa.

Episternum.—The episternum is an externally continuous plate having the shape of a narrow triangle with the base facing forward. Ventro-anteriorly it is produced into a hooklike angle, the sternal hook (c₁) or anterior sternal hook of Hopkins. The sternal hook fits into an emargination of the sternum, the clavícula (fig. 18, d). Dorsally the extreme angle of the episternum with the pleural suture (probably also containing elements of the epimeron) is produced into the parapterum (e), or coracoid process, and the wing process, or clavicular process (d). From the underside of the parapterum originates a well-developed pronator, or muscle disk (fig. 17, t₁). The episternum is heavily chitinized and covered by numerous large punctures which are interlaced by a network of fine ridges. See also figure 17, h₁. When the elytra are kept in the closed position the metapleura are nearly completely hidden by them.

Epimeron.—Between the pleural suture and the lateral margin of the metanotum a more flexible, partly membranous sclerite is inserted. Posteriorly it is subdivided by a branch of the pleural suture separating the postepimeron from the epimeron proper. While the epimeron proper is more membranous and flexible, the postepimeron is more heavily chitinized. The postepimeron bears dorso-posteriorly a recurved hook, the postepimeral hook (j₁), which articulates with the clavícula of the sternum of the first abdominal segments. The hypopleurite (Hpp) extends forward up to a shallow emargination on the dorsal margin of the postepimeron. The anterior margin of the hypopleurite is double reflexed, fitting in a reflexed ridge of the inner layer of the elytra. The area between the anterior margin of the hypopleurite and the dorsal nob of the pleural suture is deeply impressed. Epipleurite 1 of the abdomen is situated in front of the hypopleurite closely attached to the scutellum of the postnotum.

Metasternum.—The metasternum is represented as a rectangular continuous plate divided by remainders of a median line. It is illustrated in figure 18. The anterior margin is medially produced into an angle which extends far between the mesocoxae. This angle and the thickened anterior margin may correspond to the presternum of other segments. The anterior lateral angles (a) are modified to receive the sternal hooks of the metaepisternae. Therefore these emarginations should be called the anterior clavicae of the metasternum. Posteriorly the sternum is infolded producing a narrow plate, the

sternellar area. Normally the sternellar area is hidden by the coxae except for the two prolongations between the coxae. These are bent dorsally, giving the support for and articulation of the furca. The

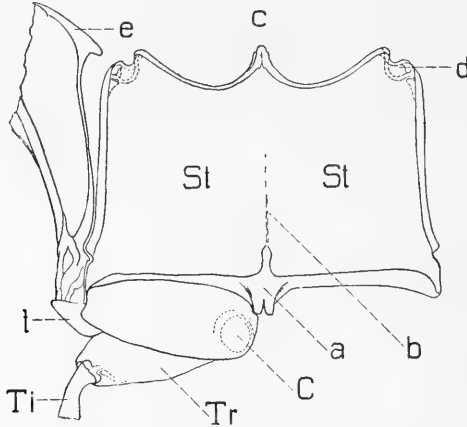

FIG. 18.—*Gnathotrichus materiarius* Fitch: Metasternum, inner aspect.

C, coxa; St, sternum; Ti, tibia; Tr, trochanter; a, sternellar area; b, median line; c, pre-sternellar area; d, clavicle; e, sternal hook of metapleuron; t, head of postpimeron.

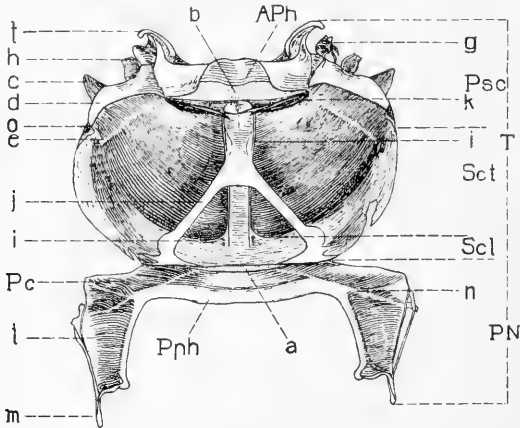

FIG. 19.—*Gnathotrichus materiarius* Fitch: Metatergum, inner aspect.

Aph, prephragma; Pc, precosta of postnotum; PN, postnotum; Pph, postphragma; Psc, prescutum; Sct, scutum; Scl, scutellum; a, posterior membrane; b, anterior membrane; c, scutellar lobe; d, posterior prealar process; e, anterior apodeme; f, anterior prealar process; g, anterior prescutellar disk; h, posterior prescutellar disk; i, scuto-scutellar suture; j, median apodeme or endodorsum; k, parapsides; l, prealar bridge of postnotum, or postscutellum; m, prealar hook of postnotum; n, postnotal apodeme; o, scapular hook.

sculpture of the metasternum is minutely rectangulate. The punctures which occur are sparse, the hairs of medium length and more numerous laterally.

The metathorax shows little specific and no sexual modifications.

THE ABDOMEN

The chitinous skeleton of the abdomen shows little specific modification but it bears characters which are of importance in separating the higher groups. The differentiation is mainly in the number of dorsal plates or tergites and the development of the spiculum ventrale in the females. The structure and the relative proportions of the different sclerites are illustrated in figures 1, 2, 3, 20, 21, 22, 23, and 24.

Dorsal plates or tergites.—All the tergites are normally covered by the elytra. In the females seven and in the males eight tergites are well developed. The first six tergites are more or less membranous

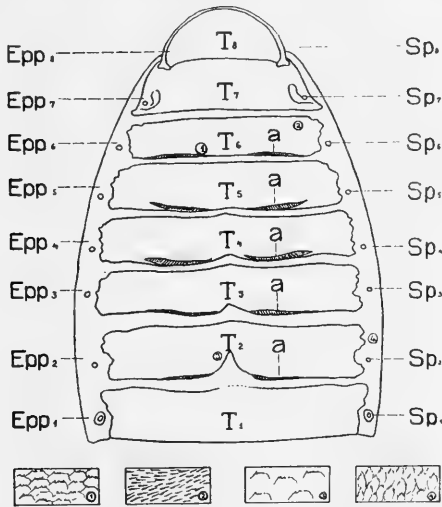

FIG. 20.—*Gnathotrichus materiarius* Fitch, male: Abdominal tergites, ventral aspect.

1, 2, 3, 4, enlarged sections showing details of structure on the dorsal side; *Epp*, epipleurites; *Epp* 7 and 8 fused with tergites; *Sp*, spiracles; *T*, tergites.

and flexible in both sexes, yellowish in color, and covered with spinous to toothlike armature on the external surface. The spinelike armature is more medial and posterior on the plates. Near the anterior margin the armature becomes more toothlike, forming broad plates armed with minute spines posteriorly (figs. 20, $T_{1, 2, 3, 4}$). These plates near the median line on the second, third and fourth tergites are stouter and not so densely placed. In the same tergites there is a reduction of the chitinization, forming a membranous emargination. Still another type of armature is found on the pleurites as illustrated in figures 20, 4. The purpose of these armatures is doubtful. The intersegmental membranes are colorless without any markings. Heavily chitinized bands are situated near the posterior margin of plates two

to six. These bands or ridges resemble the parapsides of the metathorax both in structure and in position. Punctures are numerous in all the plates and the lateral limitations are always irregular. The seventh and eighth tergites in the males and the seventh in the females are heavily chitinized and lack the above mentioned armature but have numerous hairs and punctures.

Lateral plates or pleurites.—The pleural suture seems to be the line which divides the heavily chitinized hypopleurites from the membranous epipleurites. The pleural suture is not visible in the seventh and eighth pleurites because the epipleurite is heavily chitinized here and completely fused with the tergite. The second hypopleurite which

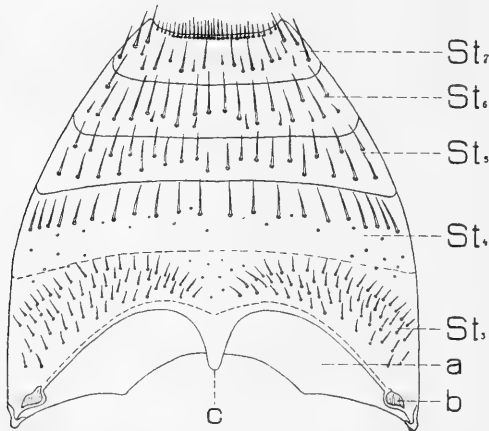

FIG. 21.—*Gnathotrichus materiarius* Fitch: Abdominal sternites, ventral aspect. *St.*, sternites; *a*, coxal cavity; *b*, clavicle; *c*, intercoxal process.

extends beyond the postepimerum of the metathorax is ventrally defined by a suture while the others are fused ventrally with the sternites. The former corresponds to the second tergite. The hypopleurite belonging to the first tergite is not represented as a plate but fused with the epipleurite. The hypopleuritic areas are covered by the elytra when they are kept in the closed position, and form a vertical plane, while the sternites make an angle of about 120 degrees with them. As was mentioned before, the epipleurites are membranous except those which correspond to the last tergites. The hypopleurites corresponding to the last seventh and eighth tergites are present only as narrow membranes.

Ventral plates or sternites.—In both sexes only five ventral plates or sternites are distinctly defined by sutures as is illustrated in figure 21 and they represent the sternites three to seven. The sternites are

widest at the base, decreasing in width towards the apex. The first visible sternite is the longest and is separated from the second by a suture which is only visible under high magnification. It is very likely that the first visible sternite contains elements of more than one abdominal segment but they are not indicated by sutures or lines. Medially the first sternite is produced into a long process called the intercoxal process, which extends far between the metacoxae. From

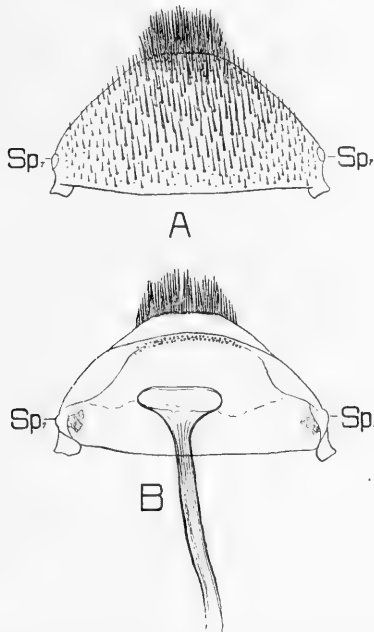

FIG. 22.—*Gnathotrichus retusus* Lec.: Seventh tergite of female.

A, dorsal aspect; B, ventral aspect; *Sp.*, seventh spiracle.

the base of this process a ridge arises which extends laterally, separating the part of the sternite covered by the metacoxae from the remainder. At the antero-lateral corners this ridge is developed into a clavicle. In this clavicle (b) articulates the ventral part of the postepimeral hook. The surface of the uncovered part of the first sternite bears numerous hairs which are arranged in concentric rows encircling the metacoxae. Punctures are sparse. All the other sternites are separated from each other by deep septae and they have the shape of short rectangular plates of nearly equal length. They are all heavily chitinized and armed with long hairs arranged in a trans-

verse row. The last sternite is infolded on the apex. There occur no striking differences in either different species or in the two sexes.

Spiculum ventrale.—In the females of all three species the spiculum ventrale is well developed. By careful dissection it can be seen fastened to the Fortsatzlappen Verhoeff. Without any doubt we are dealing here with a true spiculum laterale clausum (Fuchs). The median line commissura, which gives by certain modifications the spiculum ventrale opportum, is especially well defined in *Gn. materi-*

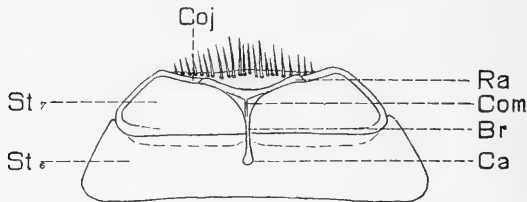

FIG. 23, A.—*Gnathotrichus retusus* Lec.: Sixth and seventh sternites of a female with the spiculum ventrale.

Ca, caput; Coj, conjunctus lateralis; Com, commissura; Br, brachium; Ra, radix; st, sternites.

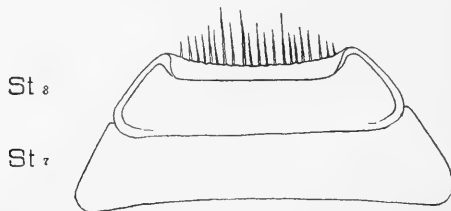

FIG. 23, B.—*Gnathotrichus retusus* Lec.: Seventh and eighth sternites of a male.

arius Fitch and *retusus* Lec. For further studies on this subject it is proposed to name the different parts of the spiculum. The part where the spiculum joins the seitlichen Ansatzlappen (Verhoeff), seitlichen Lappen (Fuchs), may be called radix spiculorum; the more or less chitinized, sometimes membranous bands extending anteriorly, brachium; and the apically thickened part, caput. The seitlichen Lappen (Fuchs), Fortsatzlappen (Verhoeff) should be called the conjunctus lateralis. The spiculum ventralis of *Gn. sulcatus* Lec. may be easily distinguished from the others by its slimmer brachiae. *Gn. retusus* Lec. and *Gn. materiarius* Fitch show no striking differences in this regard.

THE SPIRACLES

Corresponding to the number of the epipleurites, there are eight spiracles in the male and seven in the female. These are implanted in the membranous epipleurites and the apical epipleuro-tergite respectively. The eighth pair of spiracles in the male are always rudimentary. *Gn. materiarius* Fitch shows comparatively the best development in this regard. The seventh epipleurotergite of the female bears a pair of spiracles which are well developed and only very slightly smaller than the others. There also occurs one pair of spiracles on the prothorax. They lie under the produced caudad-lateral angles of the pronotum.

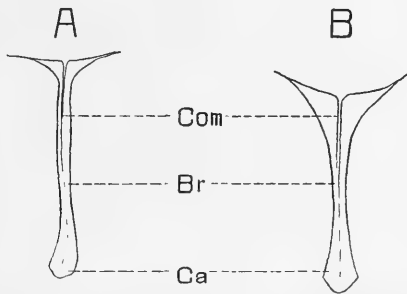

FIG. 24.—Spiculum ventrale in female: A, *Gnathotrichus sulcatus* Lec., B, *Gnathotrichus materiarius* Fitch.

Br, brachium; *Ca*, caput; *Com*, commisura.

THE LEGS

The three pairs of legs are illustrated in figures 25 and 26. They do not vary strikingly from species to species neither in form nor in sculpture. Therefore the drawings were made from *Gnathotrichus materiarius* only. The legs present all the typical segments common in Coleoptera, which are the coxa, the trochantin, the femur, the tibia, the tarsus and the pretarsus.

Coxa.—The coxa (fig. 25) differs considerably in shape in the three pairs of legs. The coxa of the prothorax (A) is very stout, ball-like, the mesocoxa (B) is slightly longer and the metacoxa (C) is nearly twice as long as the forecoxa. The proximal end of the fore- and mesocoxa show distinct indications of a basicostal suture (a). In the fore-coxa the basicostal suture is formed into an external ridge ventrally, which becomes lower and indistinct laterally. In the mesocoxa a simple suture (a) indicates the limitation of the basicosta. The basicostal area of the forecoxa (Bc) is about twice as long as the same structure in the mesocoxa. The basicoxite (Bcx) is present as

a marginal flange and is visible in both the fore- and the mesocoxa. The metacoxa does not show the separation of a basicosta by external lines or internal ridges. The extreme proximal end bears a rather indistinct, internal marginal ridge only.

The three articular surfaces (Snodgrass) are largely modified in the different legs. The pleural articular surface of the fore-coxa is present as the medial, proximal margin of the basicosta only. This part is slightly more heavily chitinized. In the mesocoxa the pleural articular surface (b) is more strongly developed. It consists of a

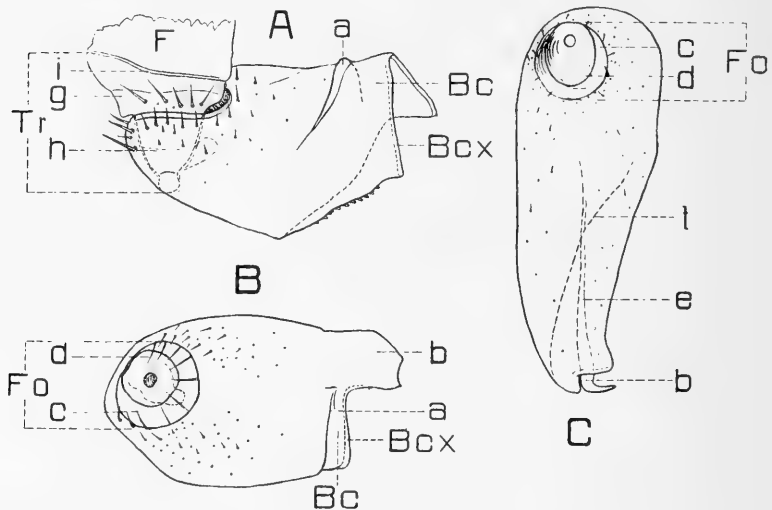

FIG. 25.—*Gnathotrichus materiarius* Fitch: A, forecoxa, lateral aspect; B, mesocoxa, C, metacoxa, both ventral aspect.

Bc, basicosta; *Bcx*, basicoxite; *F*, femur; *Fo*, fossa; *Tr*, trochanter; *a*, basicostal suture; *b*, pleural articular surface; *c*, outer ring of fossa; *d*, inner ring of fossa; *e*, anterior coxal suture; *f*, internal ridge; *g*, basicostal ridge of trochanter; *h*, condyle of trochanter; *i*, trochantero-femoral suture.

projection of the basicosta. In the metacoxa a hooklike structure (b), which is basally fused with the anterior coxal suture, may be considered as the pleural articular surface.

The articulation of the trochantin is monocondylic with the fossa in the coxa. The fossa (Fo) is a circular, conelike, impression on which two main parts are clearly defined; the outer ring (c) with a ridgelike elevation on the external surface of the coxa and the inner ring (d) or bottom which bears a heavily chitinized knob on the inner surface. It is most probable that the outer ring corresponds to the anterior, the inner ring to the posterior or distal articular surface of Snodgrass. Each coxa has opposite to the fossa a circular opening in

the heavily chitinized wall of the coxa which is covered by a thin membrane only. The extreme tip of the trochantinal condyle touches this. Ridges to strengthen the coxal walls do not occur in the fore- and mesocoxa. The metacoxa bears such a ridge on the ventral side

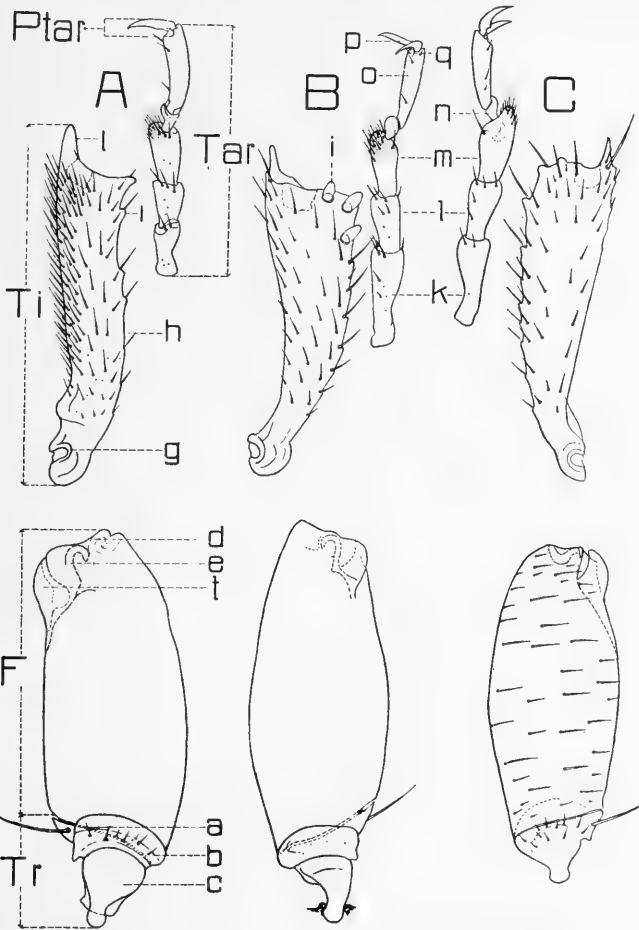

FIG. 26.—*Gnathotrichus materiarius* Fitch: A, fore leg, B, mesothoracic leg, C, metathoracic leg.

F, femur; *Ptar*, pretarsus; *Tar*, tarsus; *Ti*, tibia; *Tr*, trochanter; *a*, trochantero-femoral joint; *b*, basicostal ridge; *c*, condyle of trochanter; *d*, dorsal femoral fossa; *e*, ventral femoral fossa; *f*, anterior groove; *g*, tibial condyle; *h*, outer margin of tibia; *i*, marginal tooth; *j*, apical tooth; *k*, *l*, *m*, *n*, tarsal segments; *o*, apical segment; *q*, arolium; *p*, claw.

which forms a well developed internal ridge (*e*); this ridge may correspond to the anterior coxal suture (Snodgrass). Another more feebly developed ridge (*f*) occurs on the dorsal coxal wall.

The hair armature is best explained by the figures. No differences have been found from species to species.

Trochantin.—The trochantin (fig. 26, Tr) is a small structure and is closely attached to the femur. On the ventral or outer side, when the femur is kept close to the body, a deep groove, the trochanterofemoral groove (a) separates the femur from the trochantin. On the dorsal, or inner side, the separation is indicated by a suture only. Structurally, three parts may be distinguished on the trochantin. These are the basicostal ridge (b), the articular condyle (c) and the small apical piece (r). The basicostal ridge is a broad, stuffed, ringlike structure which gives the articulation with the coxa an external rest. For the same purpose a hooklike process on the postero-medial angle of the basicosta is used. The prominent, cone-shaped articular condyle originates basally. The shape of the condyle is alike in all three pairs of legs; the slight differences showing in the plate are due to the different angles from which the drawings were made. The apical piece projects over the basicosta when viewed from above, dorsally, and is fused with the basicosta when seen from below. It bears a long slender spine in all three pairs of legs. The basicosta is externally armed with a few small hairs. From the kind of connection between the femur and the trochantin it can be concluded that but little movement is possible between them.

Femur.—The femur (fig. 26, F) is the strongest segment of the leg and is about equal in length with the tibia (Ti). Basally it is connected with the trochantin; apically, the tibia articulates. The femur is long, oval to rectangular in outline and strongly compressed. The articulation of the tibia is bicondyle (d, e), the femur containing two half circular fossa. There occur no striking differences in the three examined species or in the three pairs of legs in one species. The inner or dorsal surface of the femur is smooth without hairs or bristles; the exposed surface bears numerous rather fine, long hairs which are directed transversely. A deep groove (f) with two lateral winglike extensions occurs latero-apically. This groove allows the tibia to be flexed closely against the femur.

Tibia.—The tibia (fig. 26, Ti) is about as long as the femur, triangular in outline and strongly compressed anteriorly. The proximal end is widened, half circular in outline, and bears the two articular condyles. The proximal quarter of the tibia is slightly bent laterally. The dextral margin is without teeth or armations; the sinistral margin bears four to six low serrations and three marginal teeth (i) which are imbedded in sockets. The apical tooth (j) is straight, rather stout and not imbedded in a socket; the subapical tooth is present as a low elevation only. The articulation of the tarsus is membranous.

Tarsus.—The tarsus (fig. 26, Tar) is composed of five joints or segments. They are not articulated by hinges with each other but they are movable by means of inflected connecting membranes. The first three segments (k, l, m) are subequal in length and shape. The basal segment or basitarsus does not show any special armations such as occur in other genera. The fourth segment (n), the smallest of the tarsus, resembles somewhat in shape the trochantin. This segment which is often highly modified in the *Scolytidae*, is short and knob-like in *Gnathotrichus*. The apical segment (o) is longer than segments one to three, more slender and slightly curved. Except the fourth, all tarsal segments bear at least a few hairs scattered over the entire length. The third segment also bears a plushlike arrangement of hairs apically.

Pretarsus: the terminal segment.—The terminal foot structure (fig. 26, Ptar), which has been called praetarsus, Krallenglied, unguis, ungula and pretarsus by different authors, bears two simple claws (p). The areolium (q) is membranous and heartshaped.

THE WINGS

As in all the *Scolytidae*, *Gnathotrichus* Eichh. has well developed elytra or mesothoracic wings and hind or metathoracic wings. The development of the metathoracic wings would indicate, as has been found to be the case, that the species of this genus are good fliers. No attempt will be made in what follows to speculate on the functions of the different sclerites of the articulation of the wings since the author has had no opportunity to make observations on them. Merely a description of the different parts will be given which it is hoped may be of value for future taxonomic and physiological studies.

MESOTHORACIC WINGS OR ELYTRA

The mesothoracic wings consist as usual of two layers of integument, both of which are chitinized, the outer layer however being much thicker than the inner layer. The space between these two layers contains the tracheal and circulatory systems. The punctures which mark these wings externally indicate, according to Hopkins, the points of union between the two layers. The form and general structure are shown in figures 1, 3, 16 and 27. The elytra when closed and viewed from above are as wide as or slightly narrower than the pronotum, with the sides subparallel, slightly tapering toward the apex and broadly rounded behind, the extreme external margin subacute.

Basal area.—The basal area (fig. 29), as here interpreted, is the basal part of the elytra itself and the sclerites which form the connection with mesonotum and the mesopleura respectively. The articulatory elements of the elytra itself are made up chiefly of the projected costa (Co) and subcostal veins (Sco) and the costal (a) and the subcostal heads (b). These heads articulate with the mesopleural clavicola (fig. 16, d). There are also four distinct axillaries (fig. 29, ax_1 to ax_4) or pteraliae. The first axillary (ax_1) partly encloses

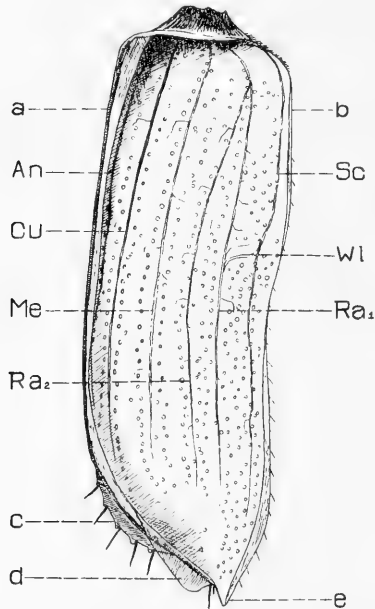

FIG. 27.—*Gnathotrichus retusus* Lec.: Left elytron, ventral aspect.

An, anal; Cu, cubitus; Me, media; Ra, radius; Sc, subcosta; Wl, lateral wing lock; a, dorsal or sutural margin; b, costal margin; c, lateral convexity; d, stridulating scraper; e, apex.

the tegula and fuses at its apex with the second axillary. The second axillary (ax_2) articulates at its base with the prealar process (a) of the prescutum. The apex of the second axillary forms a heavily chitinized clamp in which the elytra fits as a tongue. The third axillary (ax_3) corresponds to Hopkins' flexor plate. It commences on the internal surface of the second axillary and ends on the external surface of the elytra. It is believed that a sclerite (ax_4) projecting from the posterior margin of the tegula is the fourth axillary. The tegula (Te) is well developed, having the form of a hairy pad.

Tracheation.—All six primary veins (fig. 27) are present and these run roughly parallel and equidistant from each other the whole length of the wing. The costal vein is fused with the corrugated and thickened anterior margin (b) forming an anterior ligature of the wing. The subcostal (Sc), medial (Me), cubital (Cu) and anal veins (An) are simple; the radius is split into two branches (Ra_1 , Ra_2). The finer divisions of the tracheae permeate the spaces between the veins producing a fine network. Between the adjacent veins there are situated two fairly well defined rows of punctures.

Sculpture and vestiture.—The occurring punctures are as previously mentioned arranged in approximate rows, being more confused

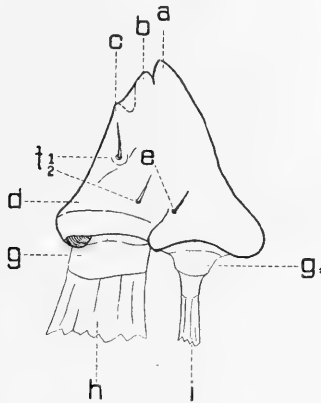

FIG. 28.—*Gnathotrichus materiarius* Fitch: Mandibles of the larva.

a, apical tooth; *b*, subapical tooth; *c*, median tooth; *d*, molar tooth; *e*, lateral bristle, or seta (seta mandibulae lateralis); f_{1-2} , dorsal setae, or bristles (seta mandibulae lateralis); *g*, retractor tendon; g_1 , extensor tendon; *h*, retractor disk; *i*, extensor disk.

laterally and on the declivity. The interspaces are minutely reticulate and punctulate and in all three species about alike. From the punctures originate minute hairs which are slightly longer on the declivity. There also occur longer bristles but they are scarce and scattered over the entire surface, being more numerous on the declivity.

Lateral wing lock.—On the inner lateral side of the elytra at the level of the anterior margin of the hypopleura a short transverse ridge (fig. 27, W1) is situated. That ridge is recurved, fitting into a similar formation which is formed by the anterior margin of the hypopleura (fig. 1, f, fig. 17, i_1). These two parts interlock and are apparently intended to keep the elytra closed.

Declivity.—The extreme lateral margin of the elytra is subacute. The declivity itself is sloping with a more or less distinct sulcus on

each side of the median suture. The lateral convexities (fig. 27, c) bear at least faint traces of granules from which bristles arise. There also occur a few bristles near the apex of the declivity.

Stridulating accessories.—In both sexes the left elytron bears on the declivity a well developed lobe which lies under the right elytron

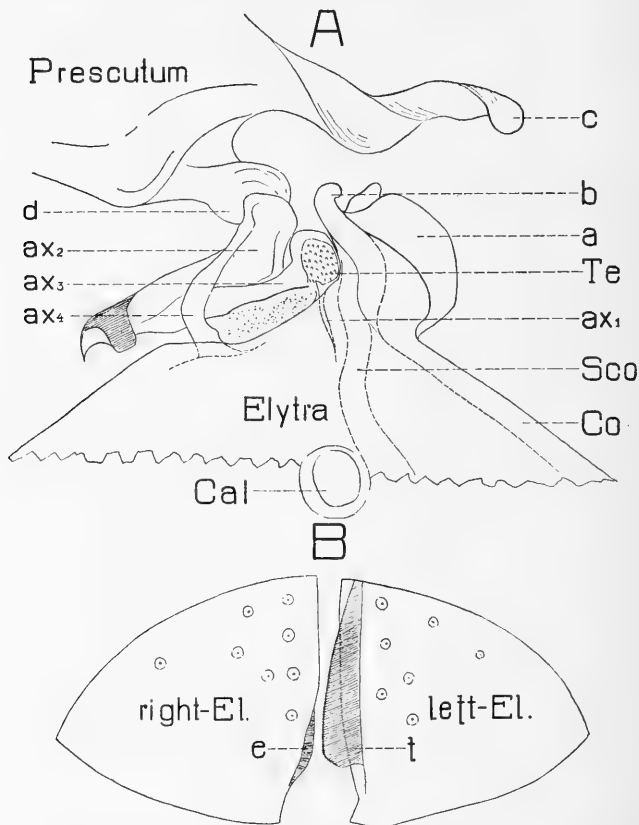

FIG. 29.—*Gnathotrichus retusus* Lec.: A, articulation of the elytra, ventral aspect; B, stridulating apparatus on the apex of the elytra, ventral aspect.

Cal, callus; *Co*, costal ridge; *Sco*, subcostal vein; *Te*, tegula; *a*, costal head; *b*, subcostal head, *ax₁*, *ax₂*, *ax₃*, *ax₄*, the axillaries; *c*, lateral arm of prephragma Hopk., or pleural hook of scutum; *d*, prealar process; *e*, stridulating rasp; *f*, stridulating scraper.

when the elytra are kept in the closed position. This lobe, the stridulatory scraper (fig. 27 d, fig. 29 f) is finely transversely sulcate on the dorsal side. The corresponding area on the right elytron (fig. 29, c) is also rasplike but only on a narrow strip. If these two parts are grated against each other, it is most probable that they will produce a chirping sound. Up to date this sound has not been heard by the

author and therefore this statement is merely an attempt to explain these two parts of the elytra.

Specific modifications of the elytra.—While *Gnathotrichus* shows the strongest development of the declival sulci, with lateral convexities and granules on the latter, these characters decrease in development in *Gn. sulcatus* Lec. and are faint in *Gn. materiarius* Fitch. There also occur many variations from specimen to specimen so a determination cannot be based on these characters only.

METATHORACIC WINGS OR HIND WINGS

The metathoracic wings (figs. 3, 17) are homologous with the mesothoracic wings but differ considerably in structure and development due to their use as flying apparatus. In the genus *Gnathotrichus* Eichh. no specific modifications of importance have been observed.

As in all genera of this family the wings are folded together and covered by the elytra when the beetles are at rest. The hind wings are twice as long as the elytra and three times as long as wide. Near the base on the inner side occurs a deep emargination separating a distinct lobe from the wing—the posterior wing lobe (fig. 3, WL, 17, L). The shape of the wings is very much alike in all three species, long oval with the anterior and posterior margins nearly parallel.

The wings consist of two layers of integument enclosing the tracheal system. In the hind wings both of these layers are membranous except on the veins and the basal sclerites. Externally they are covered with microscopic hairs, except on the basal heavy parts of the veins and the axillaries (fig. 17).

Veins.—The venation of the wings shows considerable reduction. The only visible veins are the costa (fig. 3, Co), subcosta (Sco), radius ($R_1 + R_2$), media (M_1, M_2) and cubitus (Cu_1). The radial and the medial veins are split into two branches.

Costa.—As Hopkins has shown for the genus *Dendroctonus*, the costal vein (fig. 3, Co, 17, C) is also in *Gnathotrichus* Eichh. confined to a short basal piece. Apically it does not join another vein but is reduced so that the costal margin is occupied by a membrane only up to the point where the radial vein is bent forward and structurally replaces the costa. The base of the costa is produced into the so-called costal head (fig. 30, CoH). It consists of two parts, the costal condyle (fig. 30, a), and the costal pocket (b). The former articulates with the clavicle process of the metaepisternum (fig. 17, d_1). From the base of the costal condyle a pocket stretches to the subcosta. At about the center of the pocket a projection of the subcostal head, the sub-

costal hinge (fig. 30, c), is attached by tendons giving the motion of a hinge joint. This attachment enables the subcostal head to move in the pocket.

Subcosta.—The subcosta (figs. 3, Sco, 17, Sc, 30, Sco) consists of a chitinous band extending apically as far as the costa and strengthened by two ridges of dense chitin. The basal part, or subcostal head (fig. 30, ScoH), as it was called by Hopkins, is anteriorly formed into a

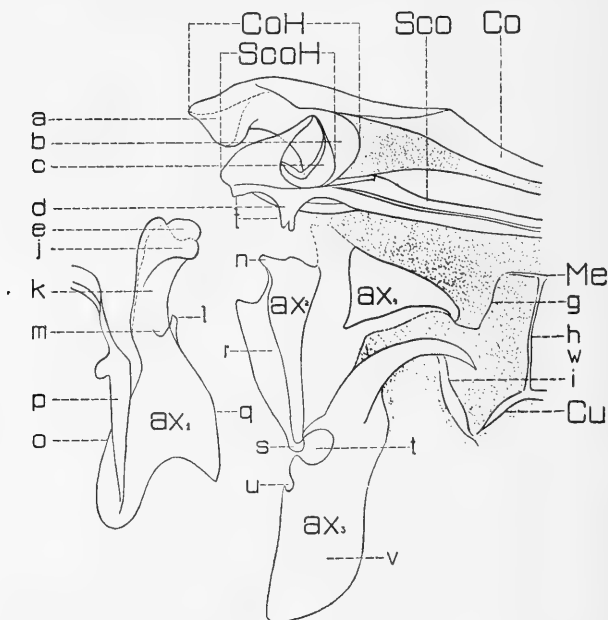

FIG. 30.—*Gnathotrichus retusus* Lec.: Basal area of the wing, wing articulation.

Co, costal vein; *CoH*, costal head; *Cu*, cubital vein; *Me*, medial vein; *Sco*, subcostal vein; *ScoH*, subcostal head; *ax*, axillary plates; *a*, costal condyle; *b*, costal pocket; *c*, subcostal hinge; *d*, subcostal labrum; *e*, condyle of first axillary; *f*, subcostal fossa; *g*, membranous fold connecting *Me* and *ax*₁; *h*, membranous fold connecting *Me* and *Cu*; *i*, membranous fold connecting *Cu* and *ax*₃; *j*, epicondyle of *ax*₁; *k*, scapula arm; *l*, axillary horn; *m*, axilla; *n*, anterior process of *ax*₂; *o*, articular margin; *p*, scapular hook of prescutum; *q*, apical margin; *r*, lateral groove; *s*, axillary tendon; *t*, *u*, lateral emarginations; *v*, posterior part, or handle; *w*, anterior part, or blade.

projection which is composed of a circular band of chitin (fig. 30, c), articulating with the costal pocket. The posterior part forms a fossa, the subcostal fossa (f), which articulates with the condyle (e) of the first axillary. The labrum (d) of the fossa is deeper on the outer side than on the inner. The outer side of the labrum is divided at its free edge by a V shaped groove.

Radius.—The radius (figs. 3, R, R₁, R₂, 17 R) is not directly fused with any of the axillary plates but is basally closely connected with the subcosta. From the point of fusion with the subcosta the radius

extends to the folding hinge on the wing gradually increasing in width. The anterior border of the radius becomes the anterior border of the wing just after the reduction of the costa and subcosta. The folding hinge occurs as a V-shaped plate, the point of the V being anterior. From the folding hinge the radius is divided into two branches (R_1 and R_2). Radius 1 extends as a broad chitinous band along the anterior border of the wing to its apex gradually diminishing in width. Radius 2 is slightly narrower than R_1 , running two-thirds with, and parallel to it.

Media.—The media (figs. 3, M, 17, M and 30, Me) is connected to axillary four (fig. 30, ax_4) by a membranous fold (g) of L shape. Another fold (h) runs posteriorly to the cubitus (Cu). From the base to the level of the folding hinge it is continued as a single vein. At the latter point it is divided into two branches (fig. 3, M_1 and M_2), both of which extend to the anal margin. The connection between the single basal part of the media and M_1 is membranous, while M_2 is a direct continuation of the former.

Cubitus.—The cubitus (figs. 3, Cu, 17, Cu and 30, Cu) is connected with axillary three (fig. 30, ax_3) by a membranous fold (i) which runs from the base of the cubitus anteriorly. From its base the cubitus proceeds toward the anal margin which it does not reach. No other branches of the cubitus nor an anal vein are present.

Wing articulation.—The articulation of the wings (figs. 3, 17 and 30) is brought about by means of the costal and subcostal heads, the axillaries of the wings, the clavicle and coracoid process of the metapleuron, the scapular hook of the posterior prealar process of the prescutum and a series of muscles and tendons connecting and moving these parts. The connection of the costa and subcosta to each other and the costa with the metapleuron was discussed before. In the following lines the axillaries and their connection with the metapleuron and metapleuron will be explained.

The axillaries are chitinous plates, differing in number in the different orders and also it seems in the genera of the Scolytoidea, which function as articulatory accessories. In the genus *Gnathotrichus* Eichh. four of such plates are distinctly developed. The heads of the costal and subcostal veins are here not counted as axillaries because they are fused with the veins in such a way that separations seem unnecessary.

First axillary.—The first axillary (fig. 30, ax_1) or scapular plate, as it was called by Hopkins, is very similar in shape to that of *Dendroctonus valens* Lec. as it was illustrated by Hopkins. Anteriorly it is produced to a condyle (e) with a distinct epicondyle (j), articulat-

ing with the fossae (d) of the subcosta. The slender part posterior to the condyle, which was called the scapular arm by Hopkins (k), bears a hornlike process (l), the axillary horn. The horn forms with the scapular arm an axilla (m) in which the anterior process (n) of the second axillary rests. The margin towards the notum or articulatory margin (Hopkins) (o) is connected with the posterior prealar process of the prescutum by the scapular hook (p) and tendons. The scapular hook is a heavily chitinized hooklike plate on the lateral margin of the prealar process. The margin towards the apex (q) of the wing fits into the lateral groove (r) of the second axillary. The base of the scapular plate is deeply emarginated.

Second axillary.—The second axillary (fig. 30, ax₂) or subscapular plate has the shape of an equilateral triangle with its base anteriorly. The side towards the first axillary bears a deep groove, the lateral groove (r), which encloses the apical margin of the first axillary (q). With axillary four it is connected by a membrane only while a well developed tendon (s) connects axillaries two and three on its posterior end. By means of this tendon a strong connection is brought about from the posterior prealar process to the first, second and third axillaries.

Third axillary.—The third axillary (fig. 30, ax₃) or flexor plate (Hopkins) has the shape of a sickle with two emarginations (t, u) on its inner side. The anterior one (t) ends in the tendon connecting axillaries two and three. The handle of the sicklelike plate (v) is without special characters. The blade (w) shows on its posterior margin near the apex a membranous fold (i) connecting this plate with the cubital vein.

Fourth axillary.—The median plate (Hopkins) corresponds to the fourth axillary (fig. 30, ax₄). It is triangular in shape, connected to the median vein by a membranous fold (g) and to the other axillaries by membranes only.

When the radial plate (Hopkins) is not considered as a distinct plate but as a connecting tendon between the second axillary and the radial vein only, the shape and structure of the other axillaries are very much alike in the widely separated genera *Dendroctonus* Er. and *Gnathotrichus* Eichh. Further studies will show if this means a parallel modification or if we have to deal with a character common to the superfamily of the *Scolytoidea*.

Lateral impression.—An area distinctly impressed on the meta-scutum (fig. 17, q), according to Hopkins, accommodates the flexor plate at rest when the wings are closed.

Lateral emargination.—The lateral emargination (Hopkins) (fig. 17, p) is an emargination on the scutum on the lateral margin of the scutellar lobe in which is implanted the inner posterior lobe of the scapular plate and the scapular hook. The latter connects the posterior prealar process with the scapular plate and the scutellar lobe, respectively.

THE MALE REPRODUCTIVE ORGANS

The male reproductive organs consist, as shown by Nuesslin for this family, of elements of endodermal and of ectodermal origin. These two groups of elements are separated in the larvae and become connected during the pupal stage. Of endodermal origin are the testi (fig. 31, Te), the vasa deferentia (fig. 31, Vd) and the

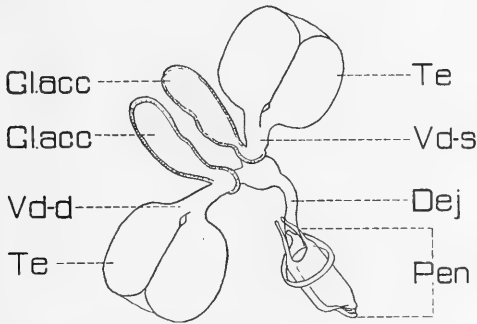

FIG. 31.—*Gnathotrichus materiarius* Fitch: Male reproductive organs.

Dej, ductus ejaculatorius; *Gl. acc.*, accessory glands; *Pen*, penis; *Te*, testi; *Vd-d*, vasa deferentia, duplex; *Vd-s*, vasa deferentia, simplex.

mesadenic, or mucous glands (fig. 31, *Gl. acc.*). On the other hand, the seminal vesicle (in part, fig. 33, *Rec.*), the ductus ejaculatorius (fig. 31, *Dej*) and the penis (fig. 3, *Pen*) are of ectodermal origin. The point of connection of these elements is plainly visible in the adults. The distal part of the vasa deferentia and the mucous glands join a short, usually narrow tube, "Zunge" (Nuesslin); the latter connects with the ductus ejaculatorius. Externally the Zunge, an endodermal structure, is encircled by a wider tubelike or sphericle envelope, which consists of two parts, the distal end or "Mantel" (Nuesslin) of endodermal, and the basal part or "Becher" (Nuesslin) of ectodermal origin. These last mentioned structures are seen commonly as a ball-like widening of the ductus ejaculatorius and are usually called the seminal vesicle.

The following description is based on *Gnathotrichus materiarius* Fitch only.

The testes consist of two oval structures which are closely connected medially. The vasa deferentia is Y shaped. The mucous glands are wide and stout and about as long as the testi. The seminal vesicle is represented by a subsphericle structure to the upper side of which the glands are joined. The ductus ejaculatorius is comparatively short, stout, and as long as the testi. In Nuesslin's key to the larger groups of Scolytidae, based on the male reproductive organs except the penis, *Gnathotrichus* falls near to the *Ernoporinae*.

Penis.—In order to consider the penis of *Gnathotrichus*, it is first necessary to discuss in a general way the *Scolytid* penis.

Lindeman, who was the first investigator of the *Scolytid* penis, distinguished two main groups of elements, the primary and the accessory. He states that the primary elements, which comprise the body (Körper), the fork (Gabel) and the stalk (Stengel), are constant throughout the family *Scolytidae*, while the accessory elements, which form together the so-called Aufsatz, vary considerably in the different genera as well as from species to species in one genus. Verhoeff, the second to deal with the subject, did not agree with this classification, while Nuesslin supported Lindeman's opinion. The last of the more important investigators of the *Scolytid* penis, Dr. Fuchs, constructed a new system for such a classification, without consideration of the phylogeny, and distinguished covers (Hüllen), inclosed parts and parts external to the covers. The author cannot agree with Lindeman and Nuesslin that the primary elements always included in the *Scolytid* penis consist of the fork (parameren Verhoeff) and the stalk (spiculum ventrale (Fuchs)). Already Fuchs has shown how far the reduction of the parameren and the spiculum ventrale in the European *Hylesinidae* has gone and the author is convinced that more intensive investigations of this subject will bring up many new facts. Without doubt more than three-quarters of the genera and ninety per cent of the species of the *Scolytidae* have not been studied at all or not thoroughly enough. For example, it was found in the present study that the spiculum ventrale is absent in *Gnathotrichus*, and it will not be long until genera are found in which the complete loss of the parameren occurs. If it is desirable to distinguish between primary and accessory elements, the author would prefer that the primary elements be considered the body only, the accessory elements all the parts outside of it. For further studies of this subject, the author will adopt Dr. Fuchs' classification and nomenclature until a time when sufficient new material is available to furnish new conclusions.

The penis presents, in the genus *Gnathotrichus*, excellent generic as well as specific characters. The following discussion is based on slides which were made from dried material treated with 10% sodium-hydroxide solution. Dr. Fuchs distinguished two layers of covers, the outer and the inner. These two layers were also found to be present in *Gnathotrichus*. The outer layer consists of a membranous tube

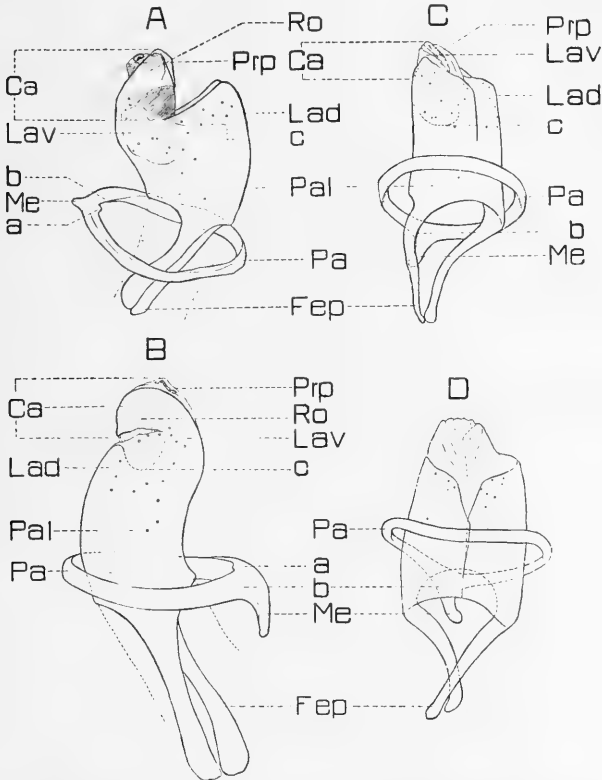

FIG. 32.—A, *Gnathotrichus sulcatus* Lec.; B, *Gnathotrichus retusus* Lec.; C, D, *Gnathotrichus materiarius* Fitch.: A, B, C, lateral aspect; D, dorsal aspect.

Ca, caput; Fep, femora penis; Lad, laminae dorsales; Lav, laminae ventrales; Me, metula; Pal, pallidium; Pa, parameren; Prp, preputial sac; Ro, rostrum; a, ventral nob of the parameren; b, tegmen furcae; c, internal ridge on Lad.

in which the inner cover slides forward and backward. A ringlike part of this tube is heavily chitinized, and when dried specimens are used only this structure is obtained. It was called by Lindeman the gabel, the parameren by Verhoeff and the tegmen by Hopkins. The inner cover consists of a second tube which is heavily chitinized throughout and which shows remarkable variations from species to species. Figure 32 illustrates the peni of the genus under examination.

Parameren.—In *Gnathotrichus* the parameren (Pa) is a heavily chitinized ringlike structure. It is entire, without a dorsal transverse suture or knoblike projection cephalad, as in *Pityogenes* Bedel, and was called umbellicus by Fuchs. Ventrally, a faint suture is visible in *Gn. sulcatus* Lec. and *retusus* Lec. only. A prominent, heavily chitinized hook extends cephalad from the ventral suture. This structure was called the metula (Me) by Fuchs and the apodemal process by Hopkins. In *Gn. retusus* Lec. and *sulcatus* Lec. a second, caudad, but much smaller knob (a) is present. The tegmen furcae (Fuchs) (b), which are a lateral continuation of the metula, are weakly developed. Lateral widenings of the parameren, Seitenfluegel (Fuchs), are absent.

Specific modifications:—

A—Parameren without small knob ventro-caudad; metula long but slender. *Gn. materiarius* Fitch.

AA—Parameren with small knob ventro-caudad; metula variously modified.

B—Metula short, weakly developed. *Gn. retusus* Lec.

BB—Metula long, strongly developed. *Gn. sulcatus* Lec.

Inner covers.—The inner cover (Fuchs), the body (Hopkins), the penis tube (Nuesslin) is a tubelike structure, bilateral-symmetric. On the inner covers three main parts may be distinguished which are the lamina dorsales (Lad), the laminae ventrales (Lav) and the peduculi penis (Fep). The dorso-caudad portion of the inner covers was called the Endplatten by Lindeman, the laminae dorsales by Fuchs and the dorsal plates by Hopkins. The laminae ventrales (Fuchs) or ventral plates (Hopkins) are the corresponding ventral portion of the laminae dorsales. In the genera *Pityogenes* Bedel, *Ips* de Geer, *Pityokteines* Fuchs, *Neothomicus* Fuchs, and others, the laminae dorsales and ventrales are largely separated by deep emarginations caudad giving the laminae the shape of four free projections which are connected basally only. The basal, fused, entire part of the laminae ventrales is the pallidium (Fuchs (Pal)). The sometimes narrow band connecting the two dorsal plates is the jugum or Steg (Fuchs). In *Gnathotrichus* the laminae dorsales and ventrales are fused laterally. Dorsally, the two laminae dorsales are separated by an obscure suture only. The laminae ventrales are fused ventrally, open on the extreme caudad portion. The laminae dorsales as well as the laminae ventrales bear numerous sensory pores on the caudad half. The latter is strengthened by a stronger chitinized band, the caudad limitation of which (c) is strongly emarginate. This chitinous strengthening was called the

radius by Fuchs and this is well developed in all three species of *Gnathotrichus*. A corresponding strengthening on the laminae dorsales, which as the manubrium (Fuchs) is well developed in the genus *Pityogenes* is obscure in *Gnathotrichus*. The caudad portion of the laminae ventrales, the caput (Fuchs), is variously modified, sometimes bearing a beaklike projection dorsally which was called the rostrum by Fuchs. The caput and rostrum vary considerably in shape and development in the genus *Gnathotrichus*. The area of the pallidium, from which the peduculi penis originate, the radix (Fuchs), is not characterized by a heavier chitinization. The peduculi penis were also called Fuesschen by Lindeman, femora penis by Verhoeff and body apodemes by Hopkins. In the normal position the peduculi penis are parallel; when mounted on slides they usually cross each other. Cephalad the peduculi are slightly widened, their connection with the pallidium is solid, not hingelike.

Enclosed parts.—The enclosed parts are a short part of the ductus ejaculatorius, the preputial sac and chitinous strengthenings of the latter. The ductus ejaculatorius is easily recognized by its enclosing muscle structure. The author was able to trace this structure as far caudad as the radius (c) extends. The preputial sac (Prp) consists of a colorless membrane without any chitinous strengthenings. It seems to be connected with the ductus ejaculatorius at the anterior emargination of the radius. Chitinous structures such as the Rinne (Fuchs) do not occur in the genus *Gnathotrichus*.

Parts outside of the covers.—It was stated in the introduction to the discussion of the penis that no indications of the spiculum ventrale are present in the genus *Gnathotrichus*. While in *Xyloterus* Er. and in some genera of the European *Hylcsinidae*, the reduction of the Rinne (Fuchs) mostly is followed by a stronger development of the spiculum ventrale, *Gnathotrichus* presents a complete reduction of both.

Generic characters of the penis.—Spiculum ventrale absent; parameren an entire ring, metula well developed; laminae dorsales and ventrales fused laterally, the laminae dorsales dorsally separated by an obscure suture, the laminae ventrales fused except on the extreme caudad portion, the laminae forming a tube, radius distinct, manubrium obscure, jugum and pallidium not clearly defined; sensory pores on the caudad half of the laminae dorsally as well as on the laminae ventrales; the latter always extending farther caudad than the former; the peduculi penis slender, slightly widened cephalad, about as long as the laminae dorsales, connection with the pallidium solid not hingelike; Rinne absent, preputial sac about as long as half of the laminae ventrales.

In the classification of the *Scolytidae*, based on the chitinous skeleton of the penis by Nuesslin, *Gnathotrichus* would have been in contrast to all the other genera. This is easily explained by the fact that only this one character was used in placing the genera. The author has no reason to believe that *Gnathotrichus* is not a highly specialized genus of the *Pityophthorinae*.

Specific modifications:—

A—Parameren without ventro-caudad knob, metula long but slender; laminae dorsales with their dorsal margin straight, the dorso-caudad angle obtuse and broadly rounded, the posterior margin is directed ventro-caudad from this angle; the laminae ventrales with their ventral margin straight, only slightly projecting caudad farther than the laminae dorsales, caput weakly developed, nearly in line with the dorso-caudad margin of the laminae dorsales, rostrum obsolete; peduculi penis about as long as the laminae ventrales, very slender, only very slightly widened at the cephalad end, basal part narrow. *Gn. materiarius* Fitch.

AA—Parameren with ventro-caudad knob opposite the metula, the latter variously modified; laminae dorsales with the dorsal margin broadly arcuate, the dorso-caudad angle variously modified either slightly acute but rather broadly rounded or almost evenly arcuate with the dorsal margin of the laminae dorsales; the laminae ventrales with their ventral margin distinctly incurved, much farther projecting caudad than the laminae dorsales, caput strongly developed, rostrum distinct; peduculi penes vary in length, stouter, more strongly widened at the cephalad end, basal part distinctly widened.

B—Metula short, weakly developed; the dorso-caudad angle slightly acute but rather broadly rounded, the posterior margin is directed ventro-cephalad from this angle, caput not evenly rounded caudad, more tube-like, ventro-caudad margin oblique, the dorsal angle of the rostrum extending to about half of the width of the combined laminae dorsales and ventrales, between the cephalad margin of the rostrum and the caudad margin of the laminae dorsales, a wide, rectangular space membranous; peduculi penis as long as the laminae dorsales on the dorsal margin. *Gn. retusus* Lec.

BB—Metula long, strongly developed; the lamina dorsales with their posterior and caudad margin almost evenly rounded throughout; caput evenly rounded caudad, half sphericle, the membranous space between the cephalad margin of the rostrum and the caudad margin of the laminae dorsales narrow, slitlike, the dorso-cephalad angle of the rostrum and the dorso-caudad angle of the laminae dorsales in one level; peduculi penis distinctly longer than the laminae dorsales. *Gn. sulcatus* Lec.

THE FEMALE REPRODUCTIVE ORGANS

The female reproductive organs (fig. 33) were examined from *Gn. materiarius* Fitch only. As in all Rhychoptera, two pairs of

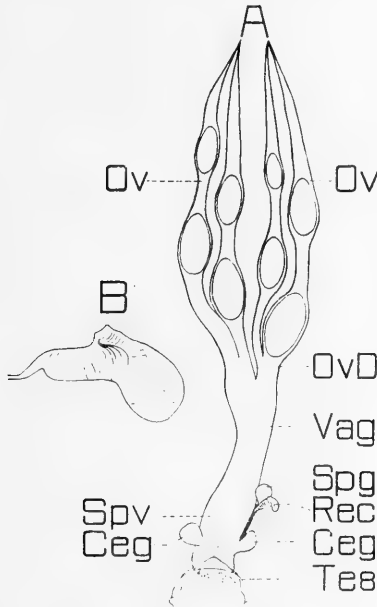

FIG. 33.—*Gnathotrichus materiarius* Fitch.: Female reproductive organs.

A, the complete organs; B, receptaculum seminis; Ceg, cement glands; Ov, ovaries; OvD, paired oviducts; Rec, receptaculum seminis; Tes, eight tergites, reduced; Spg, spermathecal gland; Spv, spiculum ventrale; Vag, vagina.

ovaries (Ov) are present which are connected distally. The paired oviducts (OvD) are short and stout. The vagina (Vag) is distinctly shorter than the ovaries. Near the basal end of the latter two cement glands (Ceg) originate. They are rather weakly developed, short and ball-like in outline. A bursa copulatrix is not present. The receptaculum seminis (Rec) originates from the vagina at about the

same level as the cement glands; it has the shape of a pipe and bears on its distal end the spermathecal gland (Spg). The receptaculum was examined in all three species but no differences have been found.

In the classification of the *Scolytidae*, based on the female reproductive organs by Nuesslin, *Gnathotrichus* would fall in a group together with the genus *Thamnurgus* Eichhoff.

THE ALIMENTARY CANAL

The alimentary canal was fully investigated in *Gn. materiarius* Fitch, the proventriculus in *Gn. retusus* Lec. and *sulcatus* Lec., also. The whole alimentary canal of *Gnathotrichus* is illustrated in figure 34, the proventriculus in figure 35.

The alimentary canal is a tube extending from one end of the body to the other. As in most of the mandibular insects, three main divisions are clearly defined. These are termed the fore, mid, and hind intestine (fig. 34, A, B, C). The ectodermal origin of the fore- and hind intestine are well illustrated by the occurring chitinizations.

Fore-intestine.—On the fore-intestine the following consecutive divisions are well defined: The Pharynx (?), Oesophagus (Oes), Crop (Cr), and the proventriculus (Pve). The well developed proventricula are the characteristic of the adults.

The pharynx is not distinctly defined from the mouth cavity.

The oesophagus is about as long as the crop and the proventriculus united. It consists of a simple tube, widened distally where it gradually passes over to the crop.

The strongly widened tube situated apically of the proventriculus may be designated as the crop.

Proventriculus.—The proventriculus is a highly specialized organ in which the food is prepared before it enters the more delicate ventriculus. The characteristic features of the proventriculus are a remarkable development of the chitinous intima into folds and teeth and a considerable increase of the size and development of the muscles of this region. On account of the importance of the proventriculus as a taxonomical characteristic and of the general morphological interest of this structure, a more detailed discussion seems to be necessary.

Lindeman, who was the first investigator of the *Scolytid* proventriculus, distinguished two main parts or longitudinal divisions. The anterior part he called the Sack, the posterior, or caudad part, the Kaumagen. Nuesslin and Fuchs followed Lindeman's nomenclature. The Sack (Lindeman) corresponds to the crop (Hopkins) and forms the intermediate part between the oesophagus and the Kaumagen (Lindeman). Hopkins used the term proventriculus for the Kau-

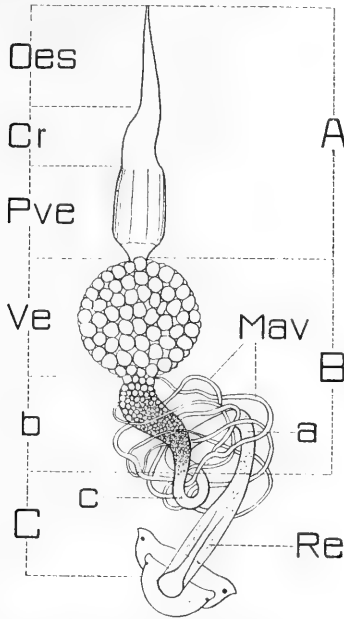

FIG. 34.—*Gnathotrichus materiarius* Fitch: Adult, alimentary canal and its appendages.

A, fore intestine; *B*, mid-intestine; *C*, hind-intestine; *Cr*, crop; *Mav*, malpighian vessels; *Oes*, oesophagus; *Pve*, proventriculus; *Re*, rectum; *Ve*, ventriculus; *a*, large intestine; *b*, posterior tube of the mid-intestine; *c*, small intestine.

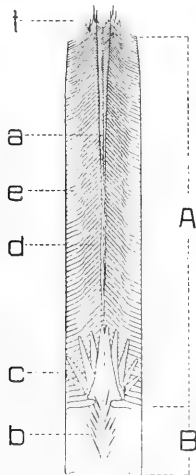

FIG. 35.—*Gnathotrichus materiarius* Fitch: Proventriculus.

a, median line; *b*, sutural teeth; *c*, anterior closing teeth; *d*, dentation of masticatory teeth, all together, masticatory brush; *e*, femora of the masticatory teeth, Abdachungszahne (Nuesslin); *f*, posterior closing teeth; *A*, masticatory plate; *B*, anterior plate.

magen (Lindeman) only. In the following discussion the interpretations of Hopkins of the terms crop and proventriculus are used.

The proventriculus consists of eight plates arranged to form a tube, as illustrated in figure 35. On each plate two longitudinal divisions are clearly defined. Lindeman called the cephalad part the Platenteil (A), the caudad part the Ladenteil (B); the corresponding terms of Hopkins are anterior plate and posterior or masticatory plate. The latter terms are adopted in this paper. In *Gnathotrichus*, both of these plates are divided by a median suture (a) which is distinctly visible on the masticatory plate and indicated by a row of bristles (b) on the anterior plate. These bristles, which are of taxonomic importance, have been called Zähne am medianen Kauplattenrand by Nuesslin and sutural teeth by Hopkins. In *Gnathotrichus* they are present as slender, sharply pointed, and simple bristles. The anterior plate is not quite one-sixth as long as the whole proventriculus. The masticatory plate (A) bears a symmetrical arrangement of teeth which presents the true chewing apparatus of the proventriculus. On each tooth two elements are clearly defined, the instep and the dentation. The totality of the insteps corresponds to the Abdachung (c); that of all dentations to the Buerste (a) of the German authors. Hopkins called the first mentioned the femora of the masticatory teeth, the latter the masticatory brush. The masticatory teeth are all similar in shape and very numerous in the genus *Gnathotrichus*. Cephalad, they are bordered by a few (8-12) longer teeth (c) which differ greatly in shape and which are directed toward the center of the proventriculus. These teeth are apparently intended to regulate the entering of the food. They have been called Sperrborsten by Nuesslin and closing teeth by Hopkins. To distinguish them from a similar arrangement of teeth which occur in *Gnathotrichus* and other genera on the caudad end of the masticatory plate (f) it is proposed to call the former cephalad closing teeth, the latter caudad closing teeth. In *Gnathotrichus*, the following armatures are not present:

- (a) Hackenzaehne (Nuesslin), or apical teeth of the anterior plate; the designation of a row of short, often curved teeth on the apical margin of the anterior plate.
- (b) Ersatzperrborsten (Nuesslin), marginal bristles or marginal fringe (Hopkins); a longitudinal row of bristles along the lateral margin of the anterior plate.
- (c) Kreuzlinie (Nuesslin), a row of short, stout teeth arising from the lateral margin of the anterior plate and converging posteriorly.

- (d) Abdachungszahne (Nuesslin), masticatory teeth which have two dentations, one, the totality of all composing the masticatory brush, and a second smaller tooth on the instep, the totality of which forms a second brush consisting of a single row of teeth only.

In the classification of the *Scolytidae* based on the proventriculus, *Gnathotrichus* should be placed with *Xyloterus* Er., *Xyleborus* Eichh., *Anisandrus* Ferr. and other ambrosia beetles together in one group. There is little doubt that the similarity of the digestive systems in ambrosia beetles of the Superfamily *Scolytoidea* is of no importance in the classification. These are merely parallel modifications of groups deriving from very different ancestors.

The proventriculus is very similar in all three species of *Gnathotrichus* and it is not possible to distinguish them by characters of this part.

Mid-intestine.—The mid-intestine is about one-third of the whole length of the alimentary canal. According to Nuesslin the proportions are the same as in *Anisandrus dispar* Fabr. and *Xyloterus lineatus* Oliv.

In *Gnathotrichus* two subdivisions of the mid-intestines are well defined. The anterior part, which presents the widest part of the whole alimentary canal, has the form of a ball and is covered with short, half spherical gastric coeca. This part is here designated as the ventriculus proper. The posterior, much narrower tubelike part, is here called the posterior tube of the mid-intestine. It bears much smaller gastric coeca which distinctly decrease in size toward the origin of the Malpighian vessels and which are always more filiform in shape. The origin of the Malpighian vessels marks the posterior limit of the mid-intestine. These are rather narrow, long tubelike vessels, strongly entangled around the posterior part of the mid-intestine and do not vary noticeably in size.

Hind-intestine.—While the fore- and mid-intestine are situated as a straight tube in the body, the hind intestine forms a distinct loop. The latter does not bear any gastric coeca but is characterized by the muscles which enclose it. The subdivisions, the small and large intestine and the rectum, are not so clearly separated. The ovaries of the female reproductive organs are always situated above the hind intestine; the testi of the male lie under and ventral to it.

THE LARVAE

On account of the difficulty in getting material of the western species, the following discussion is based on *Gnathotrichus materiarius* Fitch only.

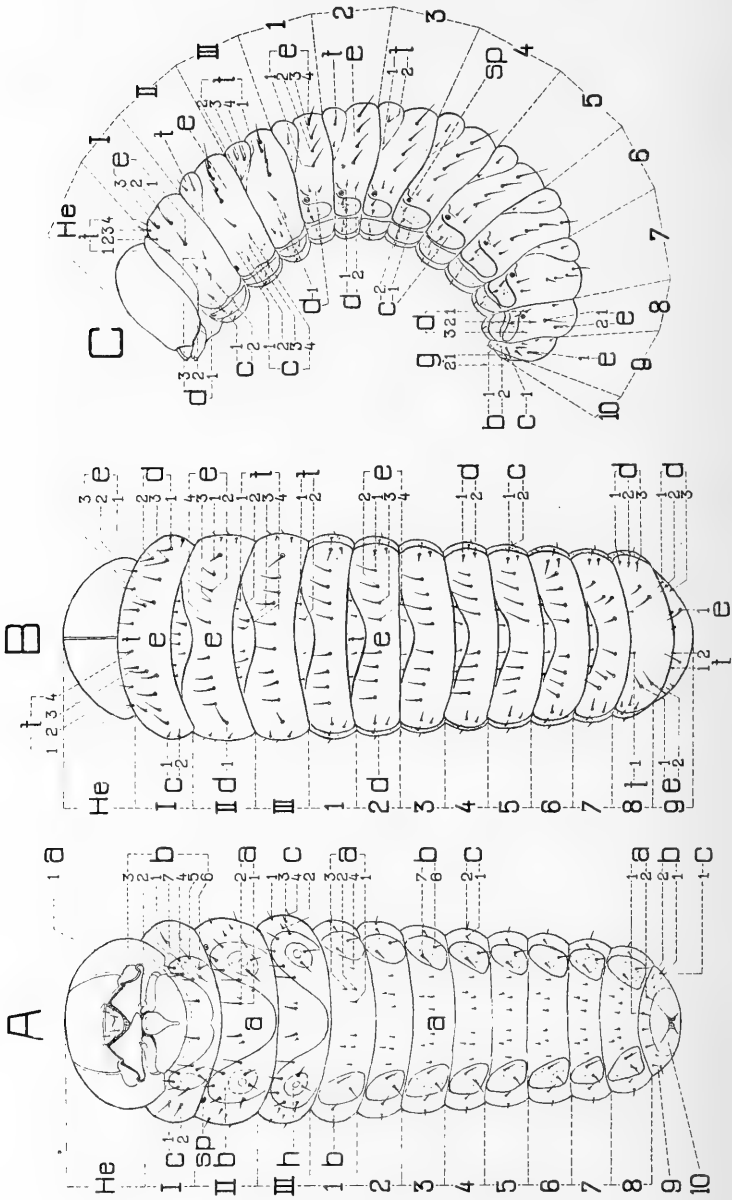

FIG. 36.—*Gnathotrichus materianus* Fitch: Fully-grown larva, showing structure and arrangement of setae; A, ventral, B, dorsal, C, lateral aspect.

EXPLANATION OF FIG. 36.

H, head; *I*, *II*, *III*, the three thoracic segments; 1-10, the ten abdominal segments; *a*, sternal plate, seta sternalis; *a*₁, single seta on prothoracic sternum; *a*₁₋₂, two single setae on meso- and metathoracic sternum, and also on 6th abdominal segment; *a*₃, *a*₄, *a*₅, four setae on abdominal segments 1-8; *b*, sternular plate, seta sternularis; *b*₁₋₇, seven setae on the thoracic segments; *b*₈, two setae on the abdominal segment 1-7; *c*, hypopleural plate, seta hypopleuricum; *c*₁₋₂, two setae on hypopleurite of first thoracic segment and abdominal segments 1-7; *c*₁₋₄, four setae on hypopleurite of second and third thoracic segments; *c*₁₋₈, three setae on hypopleurite of eighth and ninth abdominal segments; *c*₁, one seta on hypopleurite of ninth abdominal segment; *d*, epipleural plate, seta epipleuricum; *d*₁, three setae on abdominal segments 8 and 9, and first thoracic segment; *d*₂, one seta on thoracic segments 2 and 3; *d*₁₋₂, two setae on abdominal segments 1-7; *e*, scutellar scutal plate, seta scutuli; *e*₁₋₃, three setae on thoracic segment 1; *e*₁₋₄, four setae on thoracic segments 1 and 2, and abdominal segments 1-7; *e*₁₋₅, two setae on abdominal segment 8; *e*₁, one seta on abdominal segment 9; *f*₁, prescutal plate, seta praescuti; *f*₁₋₄, four setae on thoracic segments 1-3; *f*₁₋₅, two setae on abdominal segments 1-7; *f*₁₋₈, three setae on abdominal segment 9; *f*₁, one seta on abdominal segment 8; *g*, anal lobes, anal segment; *g*₁₋₂, two setae on anal segment; seta analis; *h*, foot calli; *sp*, spiracles.

The structure and general appearance of the larva are shown in figure 36. The larva is legless, subcylindrical, white in color except the heavily chitinized and therefore reddish-brown headcapsula. The full grown larva is about 3.7 mm. long. Three thoracic and nine abdominal segments are well developed. The anal lobes may be regarded as a tenth abdominal segment. The three thoracic segments are nearly equal in size and only little larger than the first abdominal segment. The abdominal segments decrease slightly in width and length toward the apex. All segments and the head are armed with constant setae. The statement of Hopkins (38) that "with the exception of scattering hairs on the head and on the scutellar lobes of the thoracic and abdominal segments the body is without distinguishing vestiture" in *Dendroctonus* has been found to be not true. There occur at least in *Dendroctonus valens* distinct setae. That this is not exceptional in the *Scolytidae* has been proved by Russo (57) and the author. The latter has studied many species and has found that every examined species shows distinct setae. The following discussion is based on the full grown larvae only. The fact that the present study was made in a private home did not allow of rearing work and therefore the question of molds, etc., cannot be discussed at present.

THE CHITINOUS SKELETON

THE HEAD

The head of the larva is more simple in structural details than that of the adult. It is distinctly narrower than the first thoracic segment when seen from above, but nearly equal in length and in width to the latter when viewed from the side. The general structure is shown in figure 36, the anatomical details in figure 37. The more striking differences in the larval head are found in the presence of a clearly defined front, clypeus, labrum, and a well developed submentum.

Epicranial suture.—The sutura metopica as well as the sutura fronto-verticale are well developed and double lined (a, b). They are not raised or padded as in the adults.

Front.—The front (fig. 37, Fr) is triangular in outline, plano-convex and clearly defined by the epicranial suture. The lateral sides are bordered with six strong bristles each (d). These setae are here called setae fronto-lateralis. The base of the front is smooth without any armation.

In the discussion of the larval setae it seems to be very useful to compare the results obtained with those of other authors. From the

literature available, only two species have been found to be studied at the present. These are *Dendroctonus valens* Lec., investigated by Hopkins, and *Chaetoptelius vestitus* Fuchs studied by Russo. The

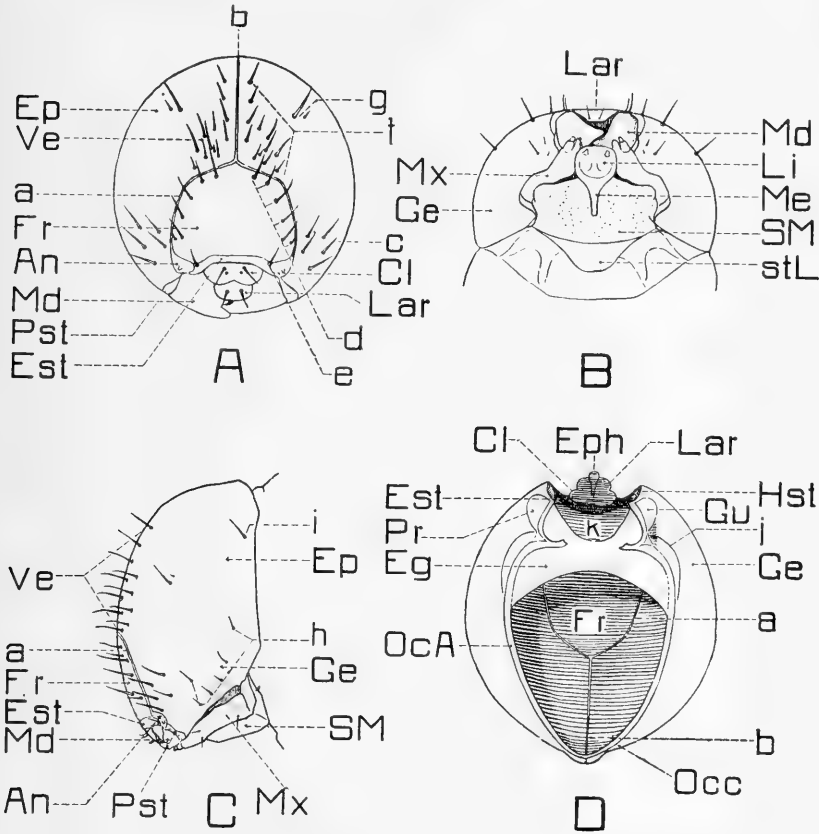

FIG. 37.—*Gnathotrichus materiarius* Fitch: Head of fully-grown larva; A, frontal aspect, B, ventral aspect, C, lateral aspect, D, occipital aspect.

An, antenna; Cl, clypeus, seta clypei; Eg, entogular plate; Ep, epicranium; Eph, epipharynx; Est, epistoma; Fr, front; Ge, gena; Gu, gula; Hst, hypostoma; Lar, labrum, setae labralis; Li, ligula; Md, mandible; Me, mentum; Mx, maxilla; Occ, occiput; OcA, occipital apodeme; Pr, pregena; Pst, pleurostoma; SM, submentum; Ve, vertex; a, sutura metopica; b, sutura fronto verticale; c, seta geno mediana; d, seta fronto lateralis; e, seta epistomalis; f, seta verto mediana; g, seta verto lateralis; h, seta geno lateralis; i, seta epicrano-lateralis; j, gular suture; k, maxillare foramen; stL, sternal lobe.

comparison of the setal arrangement with the latter species will be given at the end of each chapter.

Clypeus.—As mentioned before, the clypeus (fig. 37, Cl) is well developed in the larvae. It consists of a nearly rectangular plate which is heavily chitinized, distinctly emarginate anteriorly and broadly rounded antero-laterally. Basally it is separated from the

epistoma by a faint suture. A pair of bristles and two punctures occur near the basal margin. The setae are called setae clypei.

Labrum.—The labrum (fig. 37, Lar) is basally separated from the clypeus by a distinct suture. It consists of a heavily chitinized half circular plate. It is as long as, and about one-third narrower, than the clypeus and bears several papilla apically. Half way of its length occur two long bristles, the setae labralis.

Epistoma.—Between the front and the clypeus, a narrow thickened transverse band occurs which may be designated as the epistoma (Est). Laterally this structure is slightly bent forward and this part bears the dorsal articulation of the mandibles. On the latero-basal angles, near the suture, a long bristle is situated. The proposed name is seta epistomalis.

Pleurostoma.—A faint suture hems the lateral portion of the oral foramen, parallel to the lateral exposed part of the mandibles, which cuts off a narrow area of the cranium. This area, the pleurostoma, is slightly raised externally; internally it is ridgelike, and connects the epistoma with the hypostoma.

Hypostoma.—The hypostoma (fig. 37, Hst), which bears the ventral articulation of the mandibles, is rather ill-defined externally. Internally it is ridgelike and the articulatory condyles and fossa are submerged. Towards the occipital foramen it is extended in another ridge from which the connecting membranes of the maxilla and the submentum arise.

Occipital foramen.—The occipital foramen (fig. 6, Oct) is situated on the caudad face of the head capsula. It is heart-shaped and is bordered by a ridgelike rim, the occipital apodeme (fig. 37, OcA). The latter is interrupted ventrally. The entogular plate extends into the foramen under the occipital apodeme giving the open space of the foramen the shape of a triangle, the sides of which are broadly rounded.

Gula.—The gula (Gu) is present as two small lobes, each situated along the ventro-lateral angles of the occipital apodeme. The lateral limitation is indicated by an obscure suture.

Entogular plate.—A subchitinous plate (Eg) connects the genal areas and extends ventrally up to the hypostoma. It was called the entogular plate by Hopkins. The open space of the oral foramen is also reduced by the lammella-like extension of this plate. The entogular plate is not visible externally but hidden from the submentum.

Pregena.—A narrow area along the ventral extensions of the hypostoma, and laterally limited by obscure lines, may be considered as the pregena (Pr).

Other topographical regions of the cranium are not defined by sutures but they are somewhat limited by the occurring setae.

Vertex.—The area on both sides of the sutura fronto-verticale, the vertex (Ve), bears two groups of setae. Eleven bristles (f) are situated along each side of the sutura fronto-verticale. Four of them are arranged in a single row along the suture; the rest occur in the angle formed by the sutura fronto-verticale and the sutura metopica. They are called setae verto-mediana. A single bristle widely separated from the setae verto-mediana, the seta verto-lateralis (g) presents the second group. Sometimes a minute hair is also visible near the latter mentioned bristle.

Gena.—The area between the sutura metopica and the occipital apodeme ventro-laterally to the vertex is here designated as the gena (Ge). It bears two groups of setae, one on the level of, and close to, the antennae (c) and one laterally (h) to them but widely separated from them. The former consists of five, the latter of six long bristles. The corresponding names are the setae geno-mediana and the setae geno-lateralis.

Epicranium.—The area dorsally to the genae and laterally to the vertex is called the epicranium. A single bristle (i) sometimes associated with a minute hair, is situated near the occipital apodeme. It is called the seta epicrano-lateralis.

THE APPENDAGES OF THE HEAD

THE ANTENNAE

The antennae (fig. 37, An) are present as small membranous lobes next to the ventral end of the sutura metopica. Each bears one papilla and numerous minute hairs.

THE MOUTHPARTS

Mandibles.—The mandibles (fig. 28) differ somewhat from those of the adults, in contrast to which only one median tooth is present and the shape of the mandible is more slender and triangular. The setae are present in the same number as in the adults but their position in relation to each other is different. Proposed names: setae mandibulae dorsalis and setae mandibulae lateralis.

Maxillae.—The maxilla of the larva (fig. 38, A) is much simpler in structure than that of the adult. However, all parts present in the adult maxilla are also distinguishable in the larva.

The cardo (Ca) is present as a distinct sclerite, triangular in outline and connected with the extended hypostomal ridge, the mentum and the stipes respectively. This is, as in the adult, not the only con-

nection of the maxillae with the mentum. The subgaleal area is also connected with the mentum along its interno-lateral margin. The stipites (St) are distally not subdivided into a palpifer, and are fused internolaterally with the subgalea.

A single bristle (b) occurs near the externo-lateral margin. It was called the setole laterale dello stipite by Russo. In the present paper the name is modified into seta stipitis maxillaris. The palpiferal area

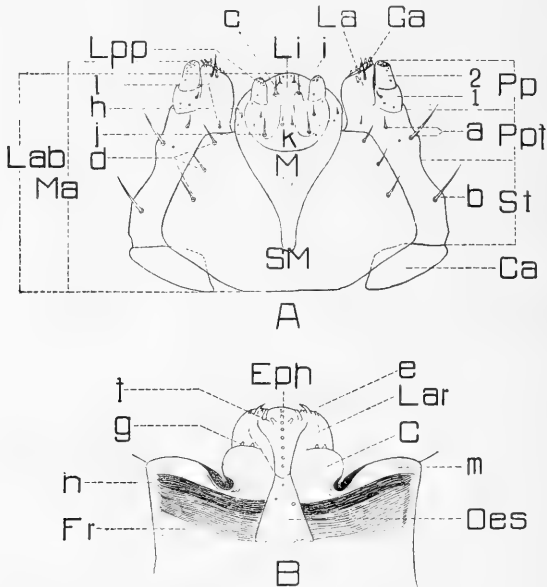

FIG. 38.—*Gnathotrichus materiaris* Fitch: A, labium and maxilla, ventral aspect; B, clypeus and labrum, ventral aspect.

Ca, cardo; *Fr*, front; *Eph*, epipharynx; *Ga*, galea; *La*, lacinia; *Lab*, labium; *Lar*, labrum; *Lpp*, labial palpi; *Li*, ligula; *M*, mentum; *Ma*, maxilla; *Oes*, oesophagus; *Pp*, maxillar palpi; *Ppf*, maxillar palpifer; *SM*, submentum; *St*, stipes; *C*, clypeus; *a*, seta palpifera maxillaris; *b*, seta stipitae maxillaris; *c*, seta ligulae distalis; *d*, seta submento-lateralis; *e*, papilla labro-apicalis; *f*, papilla epipharno-distale; *g*, papilla clypei; *h*, seta menti; *i*, seta ligulae mediana; *j*, seta labio-palpiferis, and palpiferal area; *k*, seta ligulae basalis, and basal area; *l*, seta lacinio-maxillaris; *m*, epistomal apodeme; *n*, apodeme between lateral angle of epistoma and dorsal angle of pleurostoma.

bears two bristles (a) and one puncture; the outer corresponds to the setola laterale dello palpifera, and the inner to setola mediana dello palpifera (Russo), here called seta palpiferae (maxillaris). The palpus is two-segmented, telescopic, the first segment armed with a short fine hair and two punctures, the second with punctures only. The bristle on the first segment is the setola palpiale (Russo) but to distinguish it from possible setae on other joints, it should be called seta palpo-maxillaris 1°. The lacinia is present as a well developed lobe distally armed with two long bristles (setae lacinio-maxillaris)

and a few papillae. The galea is largely fused with the lacinia. Distally a rather shallow fold indicates the separation of these two sclerites.

The setae of the maxillae have not been studied thoroughly enough to decide if they are of taxonomic importance or not. In *Dendroctonus valons*, no setae or punctures occur on the palpus and none of them on the lacinia, according to the drawings published by Hopkins. On the other hand it was found that the setal arrangement of

TABLE I.—*Setae of the head, nomenclature.*

Nomenclature of Dr. Russo	Used on	New nomenclature	Used on
Setole mediane-distale	Frons	Seta fronto-lateralis	Frons.
Setole submediane			
Setole laterali			
Setole basali	Frons-epistoma	Seta epistomalis	Epistoma.
Setole basali clypeali			
Setole mediane distali	Labrum	Seta labralis	Labrum.
Setole premediane			
Setole sublaterali			
Setole basali-laterali			
		Seta verto-mediana	Vertex.
		Seta verto-lateralis	
Setole laterale del vertice	Genae	Seta geno-lateralis	Genae.
Setole mediane			
Setole basale			
Setole interna del vertice	Genae	Seta geno-mediana	Genae.
Setole della gena			
Setole mediane			
Setole esterna			
Setole basale		Seta epicrano-lateralis	Epicranium.
Setole dorsali	Mandible	Seta mandibulae dorsalis	Mandible.
Setola sublaterale-basale	Mandible	Seta mandibulae lateralis	
Setola laterale dello stipite	Stipes	Seta stipitae maxillaris	Stipes.
Setole mediane del palpifero	Palpifer	Seta palpiferae maxillaris	Palpifer.
Setole laterale del palpifero	First joint of palpus.	Seta palpo-maxillaris 1°	First joint of palpus.
Setole palpiale			
		Seta lacinio-maxillaris	Laciniae.
Setole distale	Submentum	Seta submento-lateralis	Submentum.
Setole mediane			
Setole subbasali			
		Seta menti	Mentum.
Setole subbasali	Mentum	Seta labio palpiferis	Palpifer of labium.
Setole distale	Ligula	Seta ligulae distalis.	
Setole mediane			
		Seta ligulae mediana.	
		Seta ligulae basalis.	

Gn. materiarius Fitch is exactly the same as that of *Chaetoptelius vestitus* Fuchs, illustrated and described by Russo.

Labium.—The labium (Lab) of the larva is very different in structure from that of the adult. Indications are that the labium of the larva as well as that of the adult will become more and more important as the bearer of taxonomic characters in the *Scolytidae*.

The submentum (SM) is present as a large sclerite and is trapezoid in outline. The shape is more like that of *Chaetoptelius vestitus* Fuchs. It is slightly chitinized, laterally connected with the maxillae and bears three pairs of setae (d), the same number and in a similar arrangement as in *Chaetoptelius vestitus* and *Dendroctonus valens*. Russo called these setae setole subbasale, setole mediane and setole distale in order proceeding distad. The anterior margin of the sub-

mentum does not extend as far as the origin of the palpi as in the two other species mentioned above.

The mentum (M) is a submembranous triangular plate the base of which is anterior. The posterior angle is narrow and strongly produced. Anteriorly it is fused with the palpiferal area of the labium. A single bristle and a puncture (h) are situated on the antero-lateral angles. The name proposed is seta menti.

TABLE II.—*Comparison of head setal arrangement.*

Seta	<i>Chactoptelius vestitus</i> Fuchs.	<i>Dendroctonus valens</i> Lec.	<i>Gnathotrichus materiarius</i> Fitch.
Fronto-lateralis	4	4	6
Epistomalis	1	1	1
Clypei	2	1	1
Labralis	5	2	1
Verto-mediana	0	?	12
Verto-lateralis	0	?	2
Geno-lateralis	8	?	6
Geno-mediana	4	?	5
Epicrano-lateralis	0	?	1
Mandibulae-dorsalis	2	2	2
Mandibulae-lateralis	1	1	1
Stipitis maxillaris	1	?	1
Palpiferae maxillaris	2	?	2
Palpo-maxillaris	1	0	1
Lacinio-maxillaris	1	0	3
Submento-lateralis.....	3	3	3
Menti	0	0	1
Labio-palpiferis	1	1	2
Ligulae-distalis	1	1	1
Ligulae-mediana	0	0	1
Ligulae-basalis	1	1	1

The ligula (Li) consists of a circular plate largely surrounded by the mentum. From subdivisional parts the base of the ligula is visible from which it is well defined by faint sutures and the palpi (Pp). The base bears a single pair of setae. They are present as two short bristles and are called the setae ligulae basalis. The palpiferal area is situated on both sides of the base. The part anterior to the base of the ligula and between the palpi may be designated as the distad end of the ligula. The palpi are two-jointed. The palpiferal area bears two setae (j) which are called setae labio-palpiferis. The distal area of the ligula is armed with two pairs of setae. Proposed names: setae ligulae mediana and distalis.

THE THORAX

The thoracic segments are somewhat larger in size than those of the abdomen. They do not differ from each other in shape but are distinguished by the structure and the development of the setae. The thoracic segments are legless as in the whole superfamily but the foot calli are distinct.

Dorsally, the prothorax is distinguished from the other two thoracic segments by the lack of the suture which divides the prescutum (fig. 36) from the fused scutal-scutellar area. However, the prescutum is indicated by the corresponding setae. On the meso- and metathorax, the prescutum is present as a narrow transverse sclerite (f), near the anterior margin of which the prescutal setae (f_{1-4}) are situated. The scutum (e) and the scutellum are in all three segments fused. The pleural area is fairly well defined by a longitudinal fold ventrally. Latero-dorsally it is fused with the scutal-scutellar area. Another longitudinal fold divides the pleural area into two distinct parts. The part next to the scutal-scutellar area represents evidently the epipleurite (d), the ventral part the hypopleurite (c). The former has a smooth surface bearing setae only; the latter has the surface covered with minute spines beside the setae. On the sternum two subdivisions are plainly visible, the sternal (a) and the sternellar area (b). The sternellar area or sternellum consists of two large lateral lobes which are connected by a very narrow band medially. The lateral lobes which bear the foot calli are covered with minute spines similar to those in the hypopleurites. There is not enough evidence to speak about a poststernellar area in *Gnathotrichus* as it should be present in *Dendroctonus* according to Hopkins. The setal arrangement will be discussed with that of the abdomen.

THE ABDOMEN

The abdomen (fig. 36) consists of ten segments, the tenth of which is strongly reduced and present as the anal lobes. The segments decrease in size slightly towards the apex. Segments one to seven inclusively are alike in structure and setal arrangement. They differ in structure from the meso- and metathorax in having longitudinal folds which separate the epipleural area from the sternum and the scutal-scutellar area. Also the sternal-sternellar suture is restricted to a membranous fold. The two lateral lobes of the sternellum are apparently not connected medially. The eighth segment does not show signs of the prescutal-scutal suture. Still more reduced is the ninth segment; it has no sutures or folds but the different sclerites can be

determined very plainly from the position of the setae. The anal or tenth segment is separated from the ninth by an obscure suture. It consists chiefly of the four anal lobes. There is no difference in the structure of these lobes and also armations do not occur as in other genera.

THE SPIRACLES

Nine pairs of spiracles are present, eight of which are situated on the epipleurites of the first eight abdominal segments. The ninth spiracle is on the same sclerite of the prothorax very close to the mesothorax.

THE THORACIC AND ABDOMINAL SETAE

It was found that the setal arrangement is very constant from specimen to specimen. The number of setae varies in the different segments. The smallest number of setae was found to be present in the anal segment (2 x 2) and the eighth abdominal segment (2 x 11); the greatest number was borne by the meso- and metathorax (2 x 22). The number of setae in the different segments is best explained by

TABLE III.—*Setae of thorax and abdomen, nomenclature.*

Nomenclature of Dr. Russo	Used on the segments	New nomenclature	Used on the segments	Fig. 36
Setole tergalis mediana.....	I, II, III, 1	} Seta praescuti	} I, II, III, 1-9	} t
Setole protergali	1-8			
Setole posttergali	I, II, III, 1-8	} Seta scutuli	} I, II, III, 1-9	} e
Setole tergalis laterali	1			
Setole tergalis	9	} Seta epipleuricum ...	} I, II, III, 1-9	} d
Setole epipleuri	I, 1-8			
Setole pleuri-sternali	9 ¹	} Seta hypopleuricum ...	} I, II, III, 1-9	} c
Setole tergalis-pleurali	II, III, 1			
Setole ipopleurali	I, 1-8	} Seta sternellaris ...	} I, II, III, 1-9	} b
Setole pleurali-sternali	9 ²			
Setole epipleuri	II, III	} Seta sternalis	} I, II, III, 1-9	} a
Setole sternali-anteriori-externe..	I			
Setole sternali-posteriori-externe..	I	} Seta analis	} 10	} g
Setole sternali-mediane	I			
Setole ipopleurale	II, III			
Setole sternali-laterali	II, III			
Setole sternali mediane.....	II, III			
Setole sternali	1-8			
Not investigated				
Setole anali	10			

¹ The two dorsal setae.
² The two ventral setae.

table No. III and figure 36. It should only be mentioned that the meso- and metathorax and also the abdominal segments one to seven are alike. The prothorax, the eighth, ninth and tenth abdominal segments differ considerably. It also should be noted that the first abdominal segment does not show any difference from the following one, as shown in *Chaetoptelius vestitus* Fuchs, according to Russo.

The nomenclature of Russo has been adopted to a great extent but several changes have become necessary as illustrated in table III.

THE ALIMENTARY CANAL

The alimentary canal (fig. 39) of the larva shows some of the more primitive conditions of the highly specialized digestive system of the adult. It is about $1\frac{1}{2}$ times as long as the body. The same chief divisions as in the adult stage are clearly defined, but the proportions of the length of these are quite different. The fore-intestine occupies only one-ninth of the whole alimentary canal while the mid-intestine is

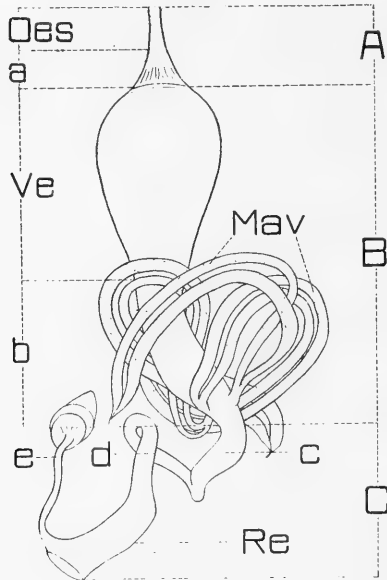

FIG. 39.—*Gnathotrichus materiarius* Fitch: Alimentary canal and its appendages of a full-grown larva.

A, fore intestine; B, mid-intestine; C, hind intestine; Mav, malpighian vessels; Oes, oesophagus; Re, rectum; Ve, ventriculus; a, region corresponding to crop and proventriculus; b, posterior tube of mid-intestine; c, large intestine; d, small intestine; e, reproductive canal.

enlarged to spread over five-ninths of the same length. The gastric coeca are small, the proventriculus absent and the Malpighian vessels are very strongly developed.

Fore-intestine.—The epipharynx (fig. 38, Eph) is well developed and projects distally slightly over the anterior margin of the labrum. It is distinctly defined from the labrum and clypeus; four papillae occur anteriorly and a row of sensory pores medially. The latter punctures are reduced to a single puncture in *Ch. vestitus* and are absent in *Dendroctonus valens*, according to the respective authors. The hypopharynx does not show any armature or sensory organs.

The oesophagus is a short tube of about equal diameter throughout. The caudad widened part, which is also encircled by strong muscles, may correspond to the united crop and proventriculus.

Mid-intestine.—The mid-intestine occupies the greatest area of the whole digestive system of the larva. The ventriculus is pearlike in shape, having the blunt end anteriorly. The gastric coeca are not so densely placed and are smaller than in the adult. The posterior tube is distinctly separated from the ventriculus. It gradually decreases in diameter towards the apex and bears on its caudad end the Malpighian vessels. These originate as a single tube and become divided shortly after their origin. Three pairs of vessels are present.

Hind-intestine.—As in the adults the hind-intestine forms a loop. The hind-intestine is encircled by ring muscles. The small and large intestines are not very distinctly separated from each other. More clearly defined is the rectum. The latter is distinctly wider than the rest of the hind-intestine, and the muscles encircling it are much more strongly developed.

From the anus originates a glandlike structure which is strongly widened distally. This evidently represents the ectodermal part of the reproductive organs of the adult. See also the discussion of the reproductive organs of the adult.

THE PUPAE

In the study of the pupa of *Gnathotrichus*, special attention was given to the changes of the setal arrangement from larva to pupa. The only illustration of a pupa of the *Scolytidae* showing the setal arrangement was found in the monograph of the genus *Dendroctonus* by Hopkins (38). It seems that Hopkins, who has usually overlooked the setae of the larva, did not realize the origin of the setae of the pupa, which he called spines. Russo, on the other hand, shows plainly the setae of the larva but has ignored those of the pupa. In fact, it is a difficult undertaking to study the setae of such small larvae or pupae. In *Gnathotrichus*, it is not possible to find the setae by working with a binocular but slides had to be made and those carefully examined under the microscope. The following discussion is illustrated by figure 40. The setae are only barely visible soon after the last molting of the larva. In the young pupa they are most distinct before the pupa starts to become the mature color, and they disappear gradually with the ripening of the adult.

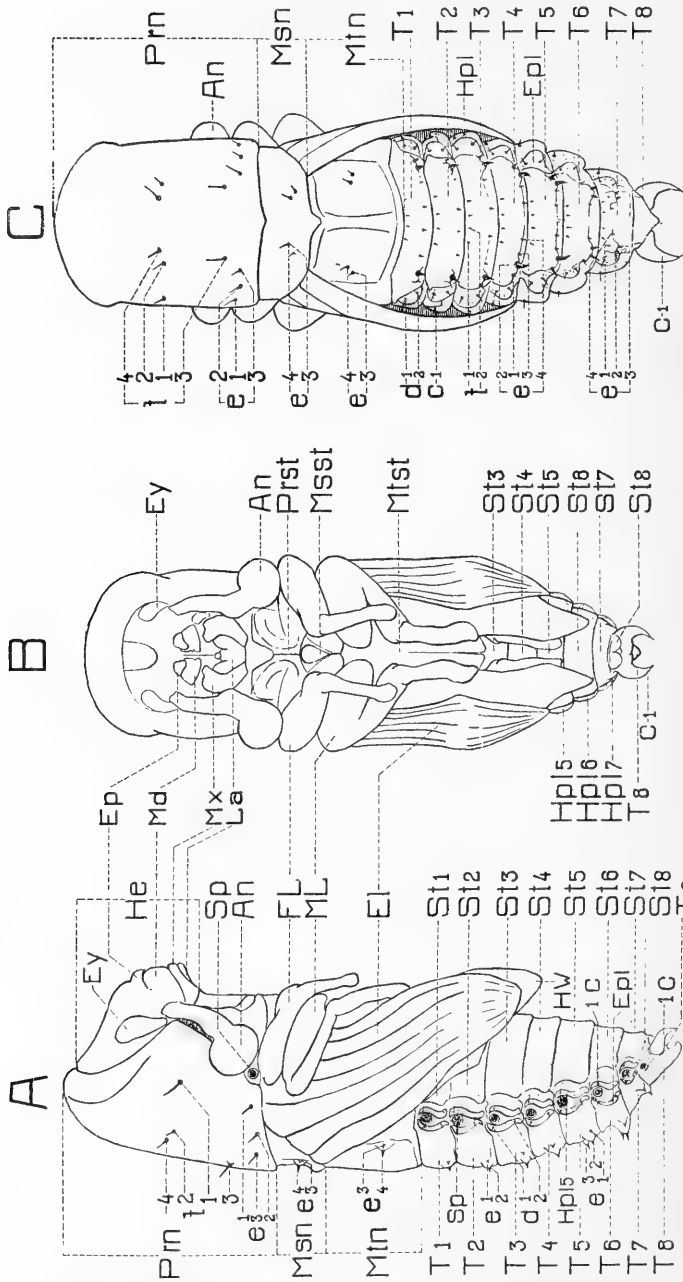

FIG. 40.—*Gnathotrichus materianus* Fitch: Pupa; A, lateral aspect, B, ventral aspect, C, dorsal aspect.

An, antenna; *El*, elytra; *Ep*, epistoma; *EpI*, epipleurite; *FL*, fore legs; *He*, head; *Hpl*, Hypopleurite; *HW*, hind wings, or metathoracic wings; *La*, labium; *Md*, mandible; *ML*, middle legs, or mesothoracic legs; *Msn*, mesonotum; *Mst*, mesosternum; *Mtn*, mesonotum; *Mst*, metanotum; *Mx*, maxilla; *Pm*, pronotum; *Pst*, prosternum; *Sp*, spiracle; *St*, sternum, 1-8, sterna of abdomen; *T*, tergum, 1-8, terga of abdomen; *e*₁₋₄, setae hypopleuricum; *d*₁₋₃, setae scutali; *f*₁₋₄, setae prescuti.

THE HEAD

The elements of the adult and larval head are also recognizable in the pupa. The antennae are among the first parts to be fully developed. The mandibles, the maxilla and the labium are first indicated by low elevations which become gradually the shape of the corresponding elements in the adult stage. A lobe, situated dorsally of each mandible (Ep) is more distinct in the younger pupa and gradually disappears. It is apparently the reduced labrum and clypeus. A similar development takes place with the frontal groove which is a distinct wide groove at first and later on becomes reduced to the narrow simple sutura fronto-verticale. The larval setae of the head are all completely lost in the pupa.

THE THORAX

Prothorax.—The shape and the relative proportions of the prothorax resemble very much that of the adult. The sternum and the extreme anterior margin of the pronotum are more strongly developed at first. The latter is padded at first and densely covered with minute spines. The setae are all lost with the exception of those of the prescutum and the scutum. The setae f_{1-4} of the prescutum are arranged similarly as in the larva while f_3 is widely separated from the rest in the direction toward the caudal margin of the sclerite. The setae scutali e_{1-4} are, as in the larva, situated in a nearly straight transverse line near the caudad border of the pronotum. The arrangement of the setae shows that the pronotum of the adult belongs with its anterior three-quarters to the prescutum and that only the caudad narrow portion originates from the scutum. The spiracle is plainly visible in the young pupa and becomes covered by the caudad lateral angles of the pronotum.

Mesothorax.—The mesothorax is somewhat more strongly developed in the pupa than in the adult. The mesonotum is not overlapped by the pronotum and is present as a nearly rectangular plate extending the full width of the mesothorax. The only setae found were the e_{3-4} of the larval stage; they are in a position similar to that in the larva. The elytra are thicker than in the adult, the tracheal vein is well developed, and the articulation occurs along their whole bases occupying the greatest part of the pleural area.

Metathorax.—In the metathorax the scutum with the scutellar groove is first recognizable. The prescutum and the postscutellum or postnotum are indicated by two narrow transverse bands only. The scutum bears the setae e_{3-4} corresponding to the larva. The meta-

thoracic wings at first extend over the elytra. The pro- and mesothoracic legs are exposed, the metathoracic or hind legs are largely hidden by the elytra and the hind wings. None of the legs show remainders of the sternal setae of the larva as was found by Hopkins to be the case in *Dendroctonus*.

All the setae of the thorax consist of rather fine hairs, the longest of which are F_{2-4} of the pronotum.

THE ABDOMEN

The abdomen is that part of the body where the external changes from larva to pupa are less pronounced. The united scutum and prescutum, the pleuron and the sternum are defined by sutures or folds. The pleuron is also subdivided into an epi- and hypopleurite.

There are eight tergites well developed. Tergites one to seven are similar in form. The outline is nearly regular rectangular. The first five of them have the same number of setae as well as setae developed in a similar manner. The setae e_{1-4} are arranged in a transverse line near the caudal border of the tergites. The seta e_2 is always hornlike and enlarged with secondary hairs arising from it; e_1 is always small and simple.

The area around e_2 is strongly padded, raised, more steeply sloping externo-laterally and gradually decreasing towards the setae e_3 and e_4 . In tergite six the setae e_3 and e_4 are of the same shape and appearance as e_2 in the foregoing tergites. The corresponding setae of the seventh tergite are also more strongly developed than the others but never reach the size and development of seta e_2 in other segments. The eighth tergite does not bear any setae.

The prescutal area is not defined by sutures or lines but the setae f_{1-2} are visible near the anterior border of tergites one to seven as minute hairs. They change neither in development nor in position during the transformation from larva to pupa, but are completely reduced on the eighth tergite.

Pleurites.—The pleural area is, as in the larval stage, subdivided into two subdivisions, the epipleurites and the hypopleurites. Between them are situated the spiracles. The epi- and hypopleurites are narrow transverse bands, strongly padded and densely covered with minute spines. The epipleurites one to seven inclusive are similar in shape and bear, as in the larva, two small hairs each. The only differences are in regard to their position. In the larva these setae are diagonal to each other; in the pupa, in a horizontal plane. The hypopleurites are similar in shape and sculpture but bear only one hair

each. These setae are situated near the cephalad margin of the hypopleurites.

The eighth pleurite resembles even in the young pupa more that of the adult than of the larva. No subdivisional plates are visible and no setae occur. The spiracle is situated on the laterocephalad angle of the united tergo-pleural plate.

The caudal spine (Hopkins), most probably represents the only external remainder of the ninth abdominal segment of the larva and it is in the opinion of the author a greatly enlarged seta of the pleural area.

Sternites.—In the young pupa the same number of sternites occur as visible tergites, namely eight. The first two sternites are present as two short plates dorsal to the metasternum. They disappear when the pupa becomes older. The sternites three to seven are fully exposed and have the shape of small sclerites in the adults. The eighth sternite is visible as two half circular lobes which indicate the future development of the spiculum ventrale. None of the sternites bear setae and also no subdivisional plates are recognizable.

BIBLIOGRAPHY

- (1) 1859. FITCH, ASA, Fourth report on the noxious and other insects of the State of New York, pp. 40-42.
- (2) 1868. LECONTE, J. L., Trans. Amer. Ent. Soc., vol. 2, pp. 154, 155.
- (3) 1868. EICHHOFF, W., Neue Borkenkäfer. Berl. Ent. Zeitschr., p. 275.
- (4) 1868. ZIMMERMAN, C., Synopsis of the *Scolytidae* of America north of Mexico. Trans. Am. Ent. Soc., vol. 15, p. 143.
- (5) 1869. PACKARD, A. S., Guide to the study of insects, p. 493.
- (6) 1875. LINDEMAN, C., Vergleichende anatomische Untersuchungen über das männliche Begattungsglied der Borkenkäfer. Bull. Soc. Imp. Nat. Moscow, vol. 49, pp. 196-252.
- (7) 1875. LINDEMAN, C., Kauapparat bei Scolytiden. V. Tageblatt der 48. Versammlung Deutscher Naturforscher und Ärzte in Graz., p. 102.
- (8) 1876. LINDEMAN, C., Monographie der Borkenhäfer Russlands. Die cryphaloiden Tomiciden. Bull. Soc. Imp. Nat. Moscow, vol. 54, No. 4.
- (9) 1876. LECONTE, J. L., AND HORN, H. G., The Rynchophora of America north of Mexico. Proc. Amer. Phil. Soc., vol. 15, pp. 349, 350.
- (10) 1877. PROVANCHER, L'ABBÉ L., Petite Faune Entomologique du Canada, vol. 1, pp. 563-566.
- (11) 1878. EICHHOFF, W., Ratio, descriptio emendatio eorum Tomicinorum. Extrait Mém. Soc. Roy. Sci. Liège, 2^e série, vol. 8.
- (12) 1881. PACKARD, A. S., Insects injurious to forest and shade trees. U. S. Ent. Com., Bull. 7, pp. 173-175.
- (13) 1883. LECONTE, J. L., AND HORN, H. G., Coleoptera of North America, pp. 512-517.

- (14) 1886. SCHWARZ, E. A., Remarks on North American Scolytids. Ent. Amer., vol. 2, p. 40.
- (15) 1890. PACKARD, A. S., U. S. Ent. Com., 5th Rep., pp. 718-20 and 816.
- (16) 1890. SCHWARZ, E. A., Proc. Ent. Soc. Wash., vol. 1, pp. 44 and 80.
- (17) 1893. HOPKINS, A. D., Catalogue of West Virginia Scolytidae and their enemies. W. Va. Agric. Expt. Sta., vol. 3, Bull. 31.
- (18) 1893. VERHOEFF, C., Vergleichende Untersuchungen über die Abdominal-segmente und die Kopulationsorgane der männlichen Coleoptera, ein Beitrag zur Kenntnis der natürlichen Verwandtschaft derselben. Deutsch. Ent. Zeitschr., 1893.
- (19) 1893. VERHOEFF, C., Vergleichende Untersuchungen über die Abdominal-segmente, insbesondere die Legeapparate der weiblichen Coleoptera, ein Beitrag zur Phylogenie derselben. Deutsch. Ent. Zeitschr.
- (20) 1894. HOPKINS, A. D., Sexual characters in Scolytidae. Can. Ent., vol. 26, p. 277.
- (21) 1894. VERHOEFF, C., Zur Kenntnis der vergleichenden Morphologie des Abdomens der weiblichen Coleoptera. Deutsch. Ent. Zeitschr.
- (22) 1894. VERHOEFF, C., Vergleichende Morphologie des Abdomens der männlichen und weiblichen Lampyriden, Canthariden und Malachiden, untersucht auf Grund der Abdominalsegmente, Copulationsorgane, Legeapparate und Dorsaldrüsen. Ein Beitrag zur Kenntnis der Phylogenie der Coleopteren. Archiv f. Naturgesch.
- (23) 1895. HAMILTON, J., Catalogue of the Coleoptera of southwestern Pennsylvania, with notes and descriptions. Trans. Am. Ent. Soc., vol. 22, pp. 346, 378.
- (24) 1895. BLANDFORD, W. F. H., Biol. Centr. Amer., vol. 4, pt. 6.
- (25) 1896. VERHOEFF, C., Ueber das Abdomen der Scolytiden, ein Beitrag zur vergleichenden Morphologie der Coleopteren. Archiv f. Naturgesch.
- (26) 1897. HUBBARD, H. G., The ambrosia beetles of the United States. U. S. Dept. Agr., Bull. 7, n. s., pp. 9-30.
- (27) 1899. HOPKINS, A. D., Report on investigations to determine the cause of unhealthy conditions of the spruce and pine from 1880-1893. W. Va. Agr. Expt. Sta., Bul. 56.
- (28) 1901. FELT, E. P., Forest, Fish and Game Comm., Report 7, pp. 495-96.
- (29) 1901. KOLBE, Vergleichend-morphologische Untersuchungen an Coleoptera nebst Grundlagen zu einem System und zur Systematik derselben. Archiv f. Naturgesch.
- (30) 1902. SEDLACZEK, Ueber den Darmkanal der Scolytiden. Centralblatt f. d. ges. Forstwesen.
- (31) 1904. HOPKINS, A. D., Exhibits of insect enemies of forests and forest products at the Louisiana Purchase Exposition, St. Louis, Mo., 1904. U. S. Div. Ent., Bull. 48, p. 15.
- (32) 1905. CURRIE, R. P., Catalogue of the exhibit of economic entomology at the Lewis and Clark Centennial Exposition, Portland, Ore. U. S. Div. Ent., Bull. 53, p. 70.
- (33) 1905. GARMAN, H., Kentucky Agr. Exp. Sta., Bull. 120, p. 69.
- (34) 1905. HOPKINS, A. D., Proc. Ent. Soc. Wash., vol. 7, p. 73.

- (35) 1906. FELT, E. P., Insects affecting park and woodland trees. N. Y. State Mus., Mem. 8, pp. 339, 371, 372.
- (36) 1907. FALL, H. C., AND COCKERELL, T. D. A., The Coleoptera of New Mexico, p. 217.
- (37) 1909. BERLESE, A., Gli Insetti, vol. 1, Milano.
- (38) 1909. HOPKINS, A. D., The genus *Dendroctonus*. U. S. Dept. Agr., Bur. of Ent., Tech. ser., Bull. 17, pt. 1.
- (39) 1909. SNODGRASS, R. E., The thorax of insects and the articulation of the wings. Proc. U. S. Nat. Mus., vol. 36, pp. 511-595.
- (40) 1909. SWAINE, J. M., Catalogue of the described Scolytidae of America, north of Mexico. N. Y. St. Mus., Bull. 134, 24th Rep. State Entomologist, 1909.
- (41) 1910. HAGEDORN, M., Genera Insectorum par P. Wytzman, Coleoptera, Fam. Ipidae, 111me Fasc.
- (42) 1910. HAGEDORN, M., Coleopterum Catalogus, von W. Junk und Schenkling. Pars 4, Ipidae.
- (43) 1911. FUCHS, G., Morphologische Studien über Borkenkäfer. I. Die Gattungen *Ips* De Geer und *Pityogenes* Bedel.
- (44) 1911/12. NEUSSLIN, O., Phylogenie und System der Borkenkäfer. Zeitschr. Wiss. Insektenbiologie, Bd. 7, Nos. 1-12, Bd. 8, Nos. 1-7.
- (45) 1912. FUCHS, O., Morphologische Studien über Borkenkäfer. II. Die europäischen Hylesinen.
- (46) 1912. SHARP, D., AND MUIR, F., The comparative anatomy of the male genital tube in Coleoptera. Proc. Ent. Soc. London, Pt. 3, pp. 477-642.
- (47) 1914. SWAINE, J. M., Forest insect conditions in British Columbia, Dom. of Canada, Dept. Agr., Div. Ent., Bull. 7.
- (48) 1915. HOPKINS, A. D., Preliminary classification of the superfamily Scolytoidea. U. S. Dept. Agr., Bur. Ent., Tech. Ser. No. 17, pt. 2.
- (49) 1918. SWAINE, J. M., Canadian barkbeetles, II. Dom. of Canada, Dept. Agr., Ent. Branch, Tech. Bull. 14.
- (50) 1922. BLACKMAN, M. W., Mississippi barkbeetles. Miss. Agr. Exp. Sta., Tech. Bull. No. 11.
- (51) 1922. HOPPING, R., Coniferous hosts of Ipidae of Pacific Coast and Rocky Mountain region. Can. Ent., vol. 44, p. 128.
- (52) 1923. MACGILLIVRAY, A. D., External insect-anatomy. Urbana, Ill.
- (53) 1923. SEITNER, M., Beobachtungen und Erfahrungen aus dem Auftreten des achtzähligen Fichtenborkenkäfers, *Ips typographus* L. in Oberösterreich und Steiermark in den Jahren 1921 und 1922. Centralblatt für das gesamte Forstwesen.
- (54) 1924. KORSCHULT, E., Bearbeitung einheimischer Tiere. Erste Monographie: Der Gelbrand, *Dyliscus marginalis* L.
- (55) 1926. GOLOVJANKO, Z. S., Zur Methodik der Bestimmung des Borkenkäferbefalls der Kiefern. Arbeiten über Forstvesuchswesen in der Ukraine, vol. 4, Kiew.
- (56) 1926. GOLOVJANKO, Z. S., Instruktion für die Förster zum Kampf mit den Borkenkäfern des Kiefernwaldes. Charkow.
- (57) 1926. RUSSO, G., Contributo alla conoscenza degli Scolytidi. Studio Morfo-Biologico del *Chaetoptelius vestitus* (Muls. e Rey) Fuchs—e dei suoi simbrionti. Laboratorio di Zoologia generale ed agraria—Portici.

- (58) 1927. SNODGRASS, R. E., Morphology and mechanism of the insect thorax. Smithsonian Misc. Coll., vol. 80, No. 1.
- (59) 1928. BLACKMAN, M. W., The genus *Pityophthorus* Eichh. in North America. N. Y. State Coll. For., Syracuse Univ., Tech. Publ. No. 25.
- (60) 1928. ILJINSKY, A., Gesetzmässigkeiten in der Vermehrung des kleinen Waldgärtners (*Blastophagus minor* Hartig.) und theoretische Begründungen der Massnahmen zu seiner Bekämpfung im Walde. (Vorläufige Mitteilungen). Mitteilungen aus dem forstlichen Versuchswesen in der Ukraine, vol. 9, p. 54-110.
- (61) 1928. SNODGRASS, R. E., Morphology and evolution of the insect head and its appendages. Smithsonian Misc. Coll., vol. 81, No. 3.

SMITHSONIAN MISCELLANEOUS COLLECTIONS

VOLUME 82, NUMBER 11

RECENTLY DATED PUEBLO RUINS IN ARIZONA

(WITH 27 PLATES)

BY

EMIL W. HAURY and LYNDON L. HARGRAVE



(PUBLICATION 3069)

CITY OF WASHINGTON
PUBLISHED BY THE SMITHSONIAN INSTITUTION
AUGUST 18, 1931

SMITHSONIAN MISCELLANEOUS COLLECTIONS

VOLUME 82, NUMBER 11

RECENTLY DATED PUEBLO RUINS IN ARIZONA

(WITH 27 PLATES)

BY

EMIL W. HAURY and LYNDON L. HARGRAVE



(PUBLICATION 3069)

CITY OF WASHINGTON
PUBLISHED BY THE SMITHSONIAN INSTITUTION

AUGUST 18, 1931

The Lord Baltimore Press
BALTIMORE, MD., U. S. A.

RECENTLY DATED PUEBLO RUINS IN ARIZONA

BY EMIL W. HAURY AND LYNDON L. HARGRAVE

(WITH 27 PLATES)

FOREWORD

In 1921 the National Geographic Society began excavation and study of Pueblo Bonito, a prehistoric ruin in Chaco Canyon, north-western New Mexico. It was the privilege of the undersigned to direct these archeological investigations from their inception to the conclusion of actual field-work in the autumn of 1927.

Pueblo Bonito is unquestionably the finest extant example of that phase of southwestern history known to archeologists as Pueblo III—the period during which small, isolated villages were drawn together into large, complex communities. After a time these communities began to disintegrate; to separate into lesser groups that spread far and wide in search of more fertile fields and freedom from the attacks of nomadic enemies. Then came, in 1540, Coronado and his fellow adventurers to initiate the Spanish conquest of the Southwest; to bring about still further disintegration of the peaceful Pueblo tribes and their unique social organization. This Spanish-dominated phase of Pueblo history, from 1540 to the present, is commonly designated Pueblo V.

In undertaking exploration of Pueblo Bonito, one of our prime desiderata was the determination of a method whereby this famous ruin could be correlated accurately with the recorded history of the Southwest. To be sure, the relative age of the ruin had previously been ascertained through stratigraphic methods and the study of pottery types. It was known to be older than certain ruins; younger than others. Our hope, notwithstanding, was to discover an absolute date—the very year, if possible, during which its prehistoric walls were building.

This desire was finally realized by a novel but altogether convincing method. As I have explained in a short paper published in "Explorations and Field-Work of the Smithsonian Institution in 1929" (*Dating our prehistoric Pueblo ruins*, pp. 167-176, Washington, 1930), Dr. A. E. Douglass, Director of Steward Observatory,

University of Arizona, accepted an invitation from the National Geographic Society to extend his researches in dendro-chronology to include such beam material as might be provided by the Society's expeditions. While the age of Pueblo Bonito was the Society's sole objective Dr. Douglass' chief interest lay in the evidence of sun-spot influences and climatic variations as revealed by the annual growth rings of the timbers.

Three separate collecting parties, under the general supervision of Dr. Douglass and myself, were sent out by the Society in the summers of 1923, 1928 and 1929. Mr. Haury has briefly reviewed the purpose and results of these successive expeditions in his introduction. It should be emphasized, however, that we had a definite plan constantly in mind; that we worked as directly as possible toward our objective. When Dr. Douglass had brought his ring-record into two separate sequences we sought to join them into a single series. It was the Third Beam Expedition, that of 1929, which finally crowned this unique adventure with success.

As Mr. Haury states, a certain transient phase of Pueblo pottery provided the clue to ruins which immediately antedated Oraibi, the inhabited Hopi village from which Dr. Douglass had secured his oldest historic timbers. From collections in the United States National Museum and elsewhere a list was prepared of 20 prehistoric villages from which that particular type of pottery had previously been gathered. Our 1929 reconnaissance was undertaken for the purpose of eliminating from that list those ruins in which there seemed little likelihood of finding charred fragments of pine ceiling beams, for only thoroughly charred timbers could have resisted seven centuries of decay in an exposed site. Of the ruins visited on that preliminary survey four only were selected for partial examination: Kin Tiel and Kokopnyama, north of the Little Colorado River, and Pinedale and Showlow, in the forested area to the south. Mr. Hargrave, from his more intimate knowledge of early Hopi cultures, was placed in charge of excavations at the two former sites; Mr. Haury, at the latter two.

In the pages which follow, Messrs. Haury and Hargrave describe their individual efforts in the four ruins above named. Since these are more or less well known to all students of Pueblo archeology, it is felt that the authors' observations will form a welcome addition to the rapidly growing literature on the Southwest, especially in view of the fact that each of the ruined villages has now been correlated definitely with our own calendar.

In behalf of the National Geographic Society, Dr. Douglass and myself, I wish to take this opportunity publicly to acknowledge our joint appreciation of the zeal and industry exhibited by Messrs. Haury and Hargrave in pursuing the tasks individually assigned them; to further acknowledge our obligations to those citizens of Arizona who, by granting us permission to excavate on their lands and in other ways, contributed so directly to the success of this important undertaking. Especially are we grateful to the Directors and to Dr. Harold S. Colton, President of the Museum of Northern Arizona, at Flagstaff, for so generously placing at our disposal the valued services of Mr. Hargrave. Dr. Colton aided us still further by personally leading our 1929 reconnaissance party; by providing Dr. Douglass with temporary laboratory space in his museum; by expediting in every way possible the purpose of our concluding expedition.

NEIL M. JUDD.

*U. S. National Museum,
November 17, 1930.*

SHOWLOW AND PINEDALE RUINS

By EMIL W. HAURY

INTRODUCTION

The year 1923 marks the inception of a new method for ascertaining the actual ages and determining the chronological sequence of Southwestern ruins—a method devised by Dr. A. E. Douglass and based upon the annual ring-growth of certain coniferous trees. A brief summary of the results of this seven-year investigation has recently been published by him in the *National Geographic Magazine*.¹

Doctor Douglass has conclusively shown that the width of annual rings of pine in the Pueblo area is conditioned by the amount of precipitation; thus, in wet or favorable years, ring-growth will be normal, while in drought years the growth will be sub-normal, the width of the rings decreasing with the severity of the drought. He has shown also that practically all trees over a large area record the periodical fluctuations in moisture in identically the same way. Commenting further on this point, Doctor Douglass says in his recent article:

The same succession of drought and plenty appears throughout the forest. . . . Certain sequences of years become easily recognized from tree to tree, county to county, even from State to State.

Furthermore, it has been shown to be highly improbable that a given ring-sequence with its characteristic narrow rings will ever be exactly duplicated. In the present continuous calendar which extends over a period of 1,200 years, duplications in even short ring-records have not been discovered.

With the above facts in mind, it should be possible by a method of cross-dating or over-lapping the inner rings of one beam with the outer rings of another, first in living trees and then in old timbers cut by man before the living trees started their record, to build up a chronology which would extend far into the past.

In June, 1923, the First Beam Expedition of the National Geographic Society entered the field for the express purpose of recovering

¹ The secret of the Southwest solved by talkative tree rings. *Nat. Geogr. Mag.*, Vol. 56, No. 6, pp. 737-770, December, 1929. Doctor Douglass will elaborate his methods and results in a paper to accompany the report on the Pueblo Bonito explorations, by Neil M. Judd, now in preparation.

beams which would contribute to the historical sequence established shortly before from living trees in the forest about Flagstaff, Arizona. This chronology had been extended back to about A. D. 1260. Prehistoric beams which were brought in by the first field party and additional timbers sent in from Pueblo Bonito, Aztec, Mesa Verde, and other ruins, provided enough material for an extended examination. By 1927 two prehistoric chronologies independent of the historical ring-record had been evolved, the one from Pueblo Bonito and Aztec beams, and the second from timbers obtained in Citadel ruins, Mesa Verde, and others. In 1928 the Pueblo Bonito and Citadel chronologies were united by specimens from Betatakin and Keet Seel, two northern Arizona cliff dwellings. Thus a prehistoric but independent sequence of more than 580 years was established.

During early spring of 1928, the Second Beam Expedition started its search for timbers to link the two existing chronologies. A careful survey of the Hopi villages indicated that available beams there were not sufficiently old. Then, in order to discover such ruins as were neither too old nor too recent, recourse was taken to pottery to serve as a guide in the further selection of sites for examination. Preliminary studies by Doctor Douglass and Mr. Lyndon L. Hargrave of pottery types, in which a sequence of development was evident, and of associated dated timbers soon revealed the fact that for a certain form of decorated orange-red pottery no dates were available, whereas older and more recent pottery types could be assigned either relative or absolute dates. Supposedly, then, the undated orange-red pottery fell in the gap which separated the two chronologies. Hence, ruins where such pottery was plentiful might possibly supply the needed timbers.

A reconnaissance of sites in the Little Colorado River drainage in the spring of 1929 resulted in the selection of the following four ruins for investigation: Kin Tiel to the northeast of Holbrook, Arizona; Kokopnyama in the Jadito Valley; Showlow and Pinedale ruins in the pine forest of the Mogollon Plateau 50 miles south of Holbrook. On these sites the Third Beam Expedition centered its activities, Mr. Lyndon L. Hargrave working first at Showlow ruin with the writer and later in Kin Tiel and Kokopnyama, while the writer continued excavations in Showlow and Pinedale ruins. The findings of the two units of the expedition, collateral to the search for beams, are given in this joint paper.

The Third Expedition was successful in recovering timbers which tied together the historic and prehistoric chronologies, thus carrying

the tree-ring calendar back to A. D. 700. Beam HH-39, found at Showlow, proved to be the key beam that converted the relative dating series of more than 580 years into the absolute chronology by confirming what was found to be a short over-lap instead of a gap. The outer rings of the specimen in question could be read to about A. D. 1380, while its central ring dated A. D. 1237. The innermost rings coincided with the last rings of the prehistoric chronology and the outer rings were readily identifiable with the 13th and 14th century records of the historic sequence. Subsequent excavations yielded additional timbers which covered practically the same period, thus substantiating the record of the key log and relieving all feeling of uncertainty that might accompany the placing of so much reliance on a single beam.

The relation of tree-ring studies to archeology is obvious with the realization that beams showing true outsides found in ancient dwellings will not only give the cutting date of the timber, but will also strike near the time of the construction of the dwelling. Eventually we may be able to interpret the entire development of Pueblo architecture in terms of actual dates and even trace minor changes of architecture within a single pueblo. Needless to say, the artifacts associated with dated ruins become more instructive in view of the added data concerning their antiquity.

The future of tree-ring research as applied to archeology is extremely promising. The present status of the study, which has enabled the dating of approximately 40 pre-Spanish ruins, is the bare beginning of what will eventually be accomplished. There remains yet the dating of many ruins which have escaped thorough investigation; the backward extension of the tree-ring calendar beyond the present terminal date of A. D. 700, so that structures older than Pueblo Bonito may be assigned to their respective places in the scale of development; and the dating of the many impressive ruins in the Rio Grande drainage, New Mexico, which, as yet, have gone undated. Other phases of the problem, now unthought of, are certain to follow.

In the following report, an attempt is made to correlate the archeological observations derived incidental to the search for charcoal with the data obtained from the charcoal specimens themselves. For the use of the latter information I am deeply obligated to Doctor Douglass. In view of the rather limited excavations, it is desirable to point out the trend of cultural development in the region under consideration rather than to venture many positive conclusions. Furthermore, it is too early yet to speak with finality concerning the complete relations of the datable charcoal to the ruins, for that depends upon continued research.

The two ruins, the first located at Showlow and the second at Pinedale, Arizona, and the artifacts recovered from each, are considered in the order named. Since both ruins are situated on privately owned land, we are indebted to the liberality of the owners in permitting us to work. At Showlow we wish to thank Mr. Edson Whipple who owns the major part of the Showlow ruin, Mr. W. Whipple and Mrs. L. Stratton, owners of the extreme south and north ends of the pueblo, respectively, for their cooperation. To Mr. Owen Cheney we wish also to express our appreciation for permission to conduct work in the Pinedale ruin. A single day was spent in investigating a large ruin on the ranch of Mr. Geo. W. Bailey, located about 15 miles northwest of Pinedale. Although no charcoal was obtained, the ruin is a most promising one for future archeological work. The very commendable attitude of the owner to prevent its despoliation by pot-hunters is largely responsible for its good condition.

The Showlow and Pinedale ruins are situated in the area drained by Silver Creek, one of the important southern tributaries of the Little Colorado River. The sources of this stream are in the northern slopes of the White Mountains almost due south of Holbrook. It flows northward past Taylor and Snowflake, Arizona, and then becomes confluent with the Little Colorado about two miles south of Woodruff. Its principal tributary from the west is Showlow Creek, about three miles south of Taylor. Cottonwood and Morterson Washes are also contributory from the west. Eastern affluents are all of a minor character. The area drained by the Silver Creek system embraces approximately 800 square miles. The land ranges from about 8,000 feet elevation on the south to 5,000 feet at the Little Colorado on the north. Vegetation varies from heavy pine timber in the high altitudes to treeless expanses in the lower regions. Both ruins investigated lie in the southern timbered part of the drainage area. (See map, fig. 1.)

SHOWLOW RUIN

Showlow ruin is located about 55 miles south of Holbrook in Showlow, Navajo County, Arizona (fig. 1). It is situated on a low elevation marginal to a narrow valley formed by Showlow Creek which lies less than a quarter of a mile to the east. The surrounding country is thickly wooded with western yellow pine, several species of juniper, and oak. The proximity of the ruin to pine was one of the determining factors in its selection for this investigation, for the precision and sensitiveness with which pine registers the passage of years by annual rings makes it the ideal timber with which to work in build-

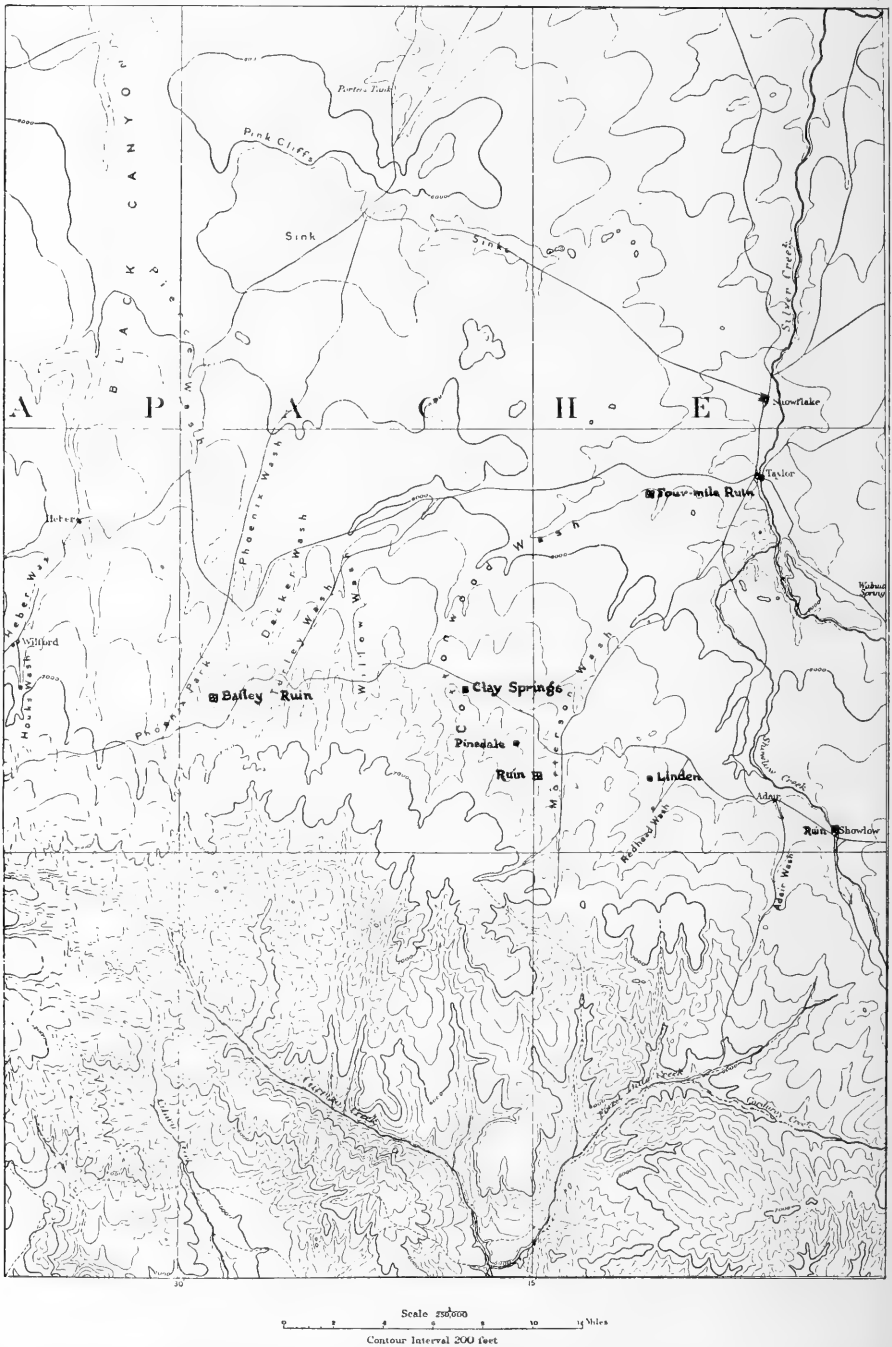

FIG. 1.—Showing location of Showlow and Pinedale ruins. From United States Geological Survey map, Holbrook sheet, Arizona.

ing up a tree-ring chronology. The accessibility of pine caused much of it to be incorporated into the roof structures of the pueblo. Hence rich returns of wood either in the normal state or charred could be expected.

The ruin is first mentioned in literature by Mr. A. F. Bandelier¹ who examined it briefly in April, 1883, during his extensive survey of ruins in the Southwest. His description of the site is as follows:

. . . . The ruin is that of a communal pueblo consisting of two houses with one circular estufa. The walls are 0.20 m. (about 8 inches) thick, built of sandstone, and only the foundations remain. Situated on a rise above a fertile bottom, this pueblo occupied a good position both for agriculture and defence.

In July, 1901, Dr. Walter Hough,² Director of the Museum-Gates Expedition, spent several days in excavation at Showlow ruin. He refers to it, however, as the Huning ruin, as at that time and when Bandelier was there as well, it was on the ranch of Mr. Henry Huning. Hough, in a brief description of his work at Showlow, says:

The Huning ruin is a good example of the rectangular pueblo, showing considerable skill in laying out a village. The masonry exposed during the excavations is good; the material is of blocks of Carboniferous sandstone. . . . It seems probable that the pueblo was inhabited only for a short time.

The change in name from Huning to Showlow ruin, as it is here called, seems legitimate in view of the fact that Bandelier referred to it as *the* ruin at Showlow, rather than naming it after the man on whose ranch it was located. Furthermore, its identity will be longer retained when connected with Showlow instead of a ranch name which has almost been forgotten.

Prior to 1901, a residence had been built on the extreme south end of the ruin. In 1903, the land on which it is located was acquired by Mr. Edson Whipple, who owns the major part of the pueblo at the present time. In the same year Mr. Whipple erected his house on the northern extremity of the ruin, and subsequently put up a barn, workshop, blacksmith shop and other sheds. A few years ago, the third house was erected on a razed space near the center of the pueblo. In still other sections, crumbled walls have been leveled for garden spaces and for a roadway. Many wagon-loads of rock have been removed for building purposes since the Showlow settlement was started. Hough notes that "during this process (of removing stone) a room at the south end of the pueblo was found to contain a large amount of charred corn, beans, etc." This room was later roofed

¹ Bandelier, A. F., 1892, pp. 392-393.

² Hough, Walter, 1903, p. 301.

and made into a vegetable cellar. Another room in the south end was excavated and converted into a cistern from which the seepage has completely saturated the rooms to the north for 50 or more feet. (See fig. 2.) In addition to all this, the owner of Showlow ruin has been more or less actively engaged the last 25 years in recovering artifacts through diggings of his own. A remarkable collection of pottery and other objects was thus accumulated which has recently been acquired by Gila Pueblo,¹ Globe, Arizona. Needless to say, the ruin has suffered tremendously under the march of our 20th century civilization, but nevertheless, from the few intact rooms opened by us were obtained the charred timbers that definitely joined the two sections of the tree-ring calendar and extended it back to A. D. 700.

The ruin is roughly rectangular in shape, the longest axis running north and south. Our excavations did not verify Bandelier's description of a two-unit pueblo, but instead, as Hough indicated, the structure is continuous. Several tiers of rooms occupy the western side, from which three short salients extend eastward to form an **E**. The intervening spaces thus created were used as plazas, the southernmost one having a large depression. Apparently Bandelier had this in mind when he said there was "one circular estufa." As to the probability of a circular ceremonial chamber in Showlow ruin comments are made later.

Hough mentions the fact that the débris covering the ruin was so thin that a plan was not difficult to make out. A further advantage to him was the fact that only a single modern house existed on the site and very little excavation and leveling had been done. While the general plan of a ruin may be observed from surface indications of walls and contour levels, some doubt must always remain as to precise room arrangement and dimensions until actual excavation has been accomplished. To identify rooms uncovered by us from previously drawn plans,² which were based on superficial examination only, was an impossibility. Hence, it seemed advisable to replot the ruin in rough outline and place thereon all tests and rooms uncovered by us and to show their relation to the present superimposed dwellings. (See fig. 2.)

In pursuing the search for charcoal it seemed most advantageous to put down test-pits which could be abandoned if old diggings or rooms unproductive of charcoal were encountered. Frequently the shovel

¹ Mr. Gladwin, Director, has kindly permitted us to examine the collection and to utilize any data obtained therefrom in the preparation of this report.

² Bandelier, A. F., 1892, pl. 1, fig. 38; Hough, Walter, 1903, pl. 21.



FIG. 2.—Plot of Showlow ruin showing extent of Beam Expedition operations.

would bring up from depths of 3 to 6 feet an old rusty horse-shoe, baling wire, a tobacco can or a fragment of a modern glazed dish, all evidences of a former disturbance. During the course of our operations, 16 major tests were made. Some of these extended over a part of a room only, whereas others included as many as three or four adjacent dwellings.¹

We explored, in whole or in part, 29 rooms; of these 22 had been destroyed by fire and consequently contained greater or lesser quantities of the desired charred timbers. All unburned rooms were located in the northeast section of the pueblo which had apparently been abandoned and covered with débris while the dwellings to the west were yet occupied. At a time subsequent to the abandonment of the old northeast section it seems that the entire remaining inhabited part of the pueblo was destroyed by fire, for apparently the same fate befell room after room from the extreme north to the extreme south ends. This wholesale burning is very probably an indication of the work of marauders, the domestic utensils and stores of corn found in nearly every room forming additional evidence of the fact that the occupants of the pueblo were forced to a hasty evacuation.

Approximately 1,200 specimens of charcoal were collected at Showlow. A large proportion of these are small fragments of roof timbers, sections of branches, or pieces of split pine from roof members. Large sections of timbers, less frequently found, are the more desirable, since from them the actual cutting dates of the trees may usually be derived. Cutting dates, furthermore, under normal circumstances signify construction dates. This is especially true when several timbers in the same room terminate with the same year. The value of cutting dates will be recognized at once, for they not only provide the actual construction time of given rooms or parts of pueblos, but they also furnish fairly reliable dates concerning the associated artifacts.

To intimate, as we already have, that the true outside of a tree or the first ring beneath the bark indicates the cutting date, may be assuming too much without further explanation. Is it probable that the Pueblo builders used the dead wood in forests in preference to felling living trees?

The present Pueblo Indians, if unable to salvage beams from deserted habitations, go to the forest for fresh timber when this is not furnished by the government. Several years ago in northeastern

¹ On the plot of the Showlow ruin, fig. 2, the tests are designated by the letter T and the rooms by the letter R.

Arizona, I observed an Indian bringing in a wagon-load of poles for a new dwelling and all were freshly cut. In ancient times when trees had to be felled with stone axes, the choice of green over dead wood can easily be understood; the seasoning that a dead tree gets considerably increases its resistance against blows of a stone axe.

Doctor Douglass has found that large areas of dead timber, killed by some natural cause, are rare in the Southwest. It is improbable that the ancient Pueblo Indian was accustomed to search for such regions which might be far from his pueblo, or to hunt isolated dead trees in the forest when the more easily cut living trees were available on all sides. That an occasional dead tree was utilized cannot be questioned, but facts derived in the study of timbers from many ruins indicate the common use of trees cut while growing.

Several pieces of charcoal with bark intact were found in Showlow and Pinedale ruins during our excavations. This is a good indication of green wood, as bark on dead trees in the forest soon falls off. On the other hand, it was customary at Pueblo Bonito¹ and undoubtedly in many other pueblos to remove the bark from roofing beams before they were used. Such a custom would readily account for the lack of more bark-covered wood from Showlow and Pinedale.

Where a number of beams in the same room yield the same year of cutting, it is far more plausible to suppose that the trees were cut simultaneously while growing than that they were collected when dead. In the latter event their ring-records would not terminate with the same year, unless gathered in a large area where trees were killed simultaneously. Such regions Doctor Douglass has found to occur but rarely.

On these grounds, we are safe in saying that the final rings in an overwhelming majority of beams from ruins indicate the actual year of cutting.

It would be useless to go into the detail of circumstances under which the numerous fragments of charcoal were found, but of the larger specimens brief record seems desirable.

Five rooms opened in test II, in the extreme north end of the pueblo (pl. I, fig. I), yielded a number of precious beam fragments. Fortunately, this section was undisturbed except for the removal some years previously of the shallow surface soil. Among the wood specimens from room 4 of this test is one bearing the field catalogue number HH-39. It is a beam section 7 inches in diameter and approximately 10 inches long, charred to a point at one end and internally decayed at

¹ Judd, N. M., September, 1925, p. 237.

the other, owing to incomplete burning. It rested near the northwest corner of the room, about a foot below the surface and approximately the same distance above the floor. By slowly working around it in a vertical cut and wrapping the end with string as it was exposed, the specimen was removed and turned over to Doctor Douglass who was present to witness its removal. The initial study which the specimen immediately received brought out its importance and historic value. Its central ring dated A. D. 1237; its outer gave a cutting date at about 1380. The inner rings cross-dated with the last rings of Doctor Douglass' relative chronology; the outer agreed with his modern ring series, extending from 1929 to A. D. 1260.¹ The archeological importance of this particular specimen, therefore, lay in the fact that it definitely and convincingly joined the Douglass modern and pre-historic ring chronologies and thus made possible the absolute dating of this and other pre-Spanish ruins.

From room 4 there were recovered 30 other specimens, mostly small fragments of charred pine, of which 15 have been dated. A majority of these do not give actual cutting dates, but their broken, outer rings end somewhere in the early 14th century. The most recent identifiable year of the pieces giving terminal dates from this room is 1378 which apparently marks the beginning of a short building period in the north end of the pueblo. One specimen, giving a true cutting date of 1279, or approximately 100 years earlier than the other pieces from the room, is probably a fragment of timber salvaged from an abandoned dwelling and re-used. Doctor Douglass has found that such a custom still exists in the Hopi town Oraibi where beams cut as early as the 14th and 15th centuries are in use in present-day dwellings and kivas.

From room 2 of test 11 (pl. 1, fig. 2), a total of 243 pieces of charcoal were obtained. Of these, 110 have been matched into the established calendar; 44 pieces registering cutting dates and 66 near cuttings.² Among the pieces are two beam sections shown *in situ* in plate 2, figures 1 and 2, both giving 1378 as the cutting date. The inverted bowl over the charred timber in plate 2, figure 1, was on the roof of the dwelling when the fire took place. Thirty-one fragments, some possibly parts of the logs pictured, also gave 1378 as the true outside. Eight other pieces dated 1382, and the years 1356, 1369, 1375, and 1381 are represented by one specimen each.

¹ Douglass, A. E., December, 1929, Nat. Geogr. Mag., pp. 766-767.

² On specimens giving near cutting dates the immediate outside has either been worn or broken away.

Rooms 1 and 3 of test 11, yielded 75 fragments of charred pine; those which have been dated give either 1378 or 1380 as the year of cutting.

The number of wood specimens recovered from rooms 1, 2, 3, and 4, test 11, totals 348; of these 106 have been matched into the tree-ring calendar but do not show the true outsides of the logs, while 62 other beam sections record the actual year of cutting. This latter group represents possibly 20 to 25 individual trees, the majority of which were felled either in 1378, 1380, or 1382. It seems permissible, therefore, to assume that the block of rooms in which these dated specimens were found, was erected during the five-year period beginning in 1378. Apparently construction ceased in this section with the year 1382. A few earlier dates, namely, 1175, 1179, 1279, 1282, and 1356 are undoubtedly re-used timbers.

Charcoal fragments from the various rooms of tests 1, 2, 3, and 12 (fig. 2) collectively, show a building period that extended, roughly, from 1360 to 1375. Numerous other pieces fall generally into two previous periods, ending respectively about 1204 and 1272. Unfortunately few of these show terminal dates so that the above years are of relative value only. As is set forth later, this part of the pueblo showed an unmistakable double occupation. While some disturbance of the débris between the two floors was apparent, much of the charcoal coming therefrom dated in the neighborhood of the earlier period suggested. Positive association, however, cannot be claimed, hence 1204 remains only a tentative date for the lower level of occupancy.

Tests 15 and 16, in the southeast quarter of the ruin, disclosed no evidence of superposed dwellings. With but few exceptions, all beams dated from this section were felled in the late 14th century. In a number of pieces from test 15 the final ring is 1383, indicating that the tree was cut sometime during the winter of 1383-4. This is the most recent cutting date found by us at Showlow and probably marks the end of construction in the pueblo.

A comparative study of all dated charcoal specimens verifies an anticipated condition in Showlow ruin, viz., that the last structural additions were made at both extremities of the pueblo, the most recent at the south end. This longitudinal expansion was apparently controlled by the contour of the elevation on which the ruin rests. It seems that maximum lateral expansion was reached first; then a few rooms were added at the north end filling out all available space at the point of the elevation, and the last rooms were appended at the south end, the only direction in which the pueblo could be easily enlarged. If the

same factor entered into the construction of other pueblos, as it unquestionably did, it might be possible to locate the most recently built rooms of a given pueblo by an examination of its periphery with respect to topographical surroundings.

ARCHITECTURAL FEATURES

Inasmuch as building stones have been removed from Showlow ruin for many years and excessive alteration has taken place, it was difficult to tell how much, if any, of the pueblo was originally more than one story in height. The former existence of a two-story structure was noted in but one of several tests; from conversation with Mr. Whipple it was gathered that he rarely encountered two-story remains during the 20-odd years in which he was actively engaged in local excavations. With a few exceptions, therefore, the rooms of Showlow ruin appear to have been only one story in height.

Showlow masonry is not all of the same type, due to the fact that it is not all contemporaneous. It has already been intimated that rooms opened in tests 1, 2, 3, and 12 (pl. 4, fig. 1) evidenced two levels of occupation. A tentative dating of A. D. 1204 has been assigned to the lower horizon; the upper level of occupancy dating about 1375. Walls related to both levels were uncovered. Lower-level masonry, composed of comparatively large, well-selected stones, and usually chinked, is superior in workmanship to upper-level walls which are poorly constructed of ill-chosen building stones.

A study of potsherds from Showlow ruin indicates the possibility of an even older horizon in the northeast part of the pueblo. Walls exposed here were formed by a basal row of large vertical slabs above which small blocks were placed in rude, horizontal courses (pl. 3, fig. 1). Although inferior in composition, this masonry is similar to the lower level type exposed in tests 1, 2, 3, and 12. This relationship, and the greater antiquity suggested by potsherds for the northeast quarter, leaves little doubt as to the early sequence of wall types.

In test 12 was uncovered an exceptionally good section of lower-level wall, 13 feet in length by 5 feet in height. Here large blocks were substituted for the vertical slabs of the lowest course displayed in the northeast section of the ruin. It was then continued upward by alternating layers of large blocks and small spalls (pl. 3, fig. 2). In some cases the spalls were employed primarily in chinking; in others, it is obvious they served to provide a base for the succeeding layer of large stones. The exposed faces of these larger units were dressed by pecking with hammer stones. This type of masonry,

although much inferior in workmanship, is reminiscent of the second type of Pueblo Bonito stonework, described by Judd.¹ That this section of Showlow ruin was abandoned and subsequently reoccupied is shown by the fact that walls of different masonry abut the wall just described on a higher level.

The most noteworthy instance of superposition was found in test 2, room 1. This dwelling measured $9\frac{1}{2}$ by $10\frac{1}{2}$ feet; near its center was the usual slab-lined firebox (pl. 4, fig. 2). In the northern part of the room, a foot below its floor, a second level, with related fireplace, was encountered (pl. 5, fig. 1). Further excavation revealed the fact that the upper firebox was built upon and almost directly above a partly razed, earlier wall (pl. 5, fig. 2; also consult text fig. 3 for ground plan and cross-section of this room). The north and south walls of the upper room did not go below their related floor, but the east and west walls extended to and rested on the lower level.

Since similar evidence of remodeling and re-use of old walls was noted also in neighboring dwellings it may be supposed that this section of the pueblo experienced general desertion between the two occupations. Whether or not the entire village was abandoned could not be learned from our rather limited work. The difference in pottery from the two levels suggests the lapse of a considerable period of time between occupations. For information concerning the actual length of this period, we resort to charcoal. Accepting for the moment the tentative dating of A. D. 1204 for the lower horizon, the difference between this date and 1375, which has been assigned to the upper level, is 171 years. This is only an approximation because of the readily foreseen difficulty of ascribing definite dates to culture horizons. The abandonment, however, provides a convenient break in the continuity of development, thus emphasizing the time element. That the estimated 170-year period is correct, or nearly so, is indicated by the discovery of pottery types at Pinedale which were developed during this time from types present in the lower Showlow level. Timber associations with Pinedale types place them as post-1290. They in turn developed into the dominant forms of the Showlow upper level. In this way, pottery sequence and tree-ring records were found to support each other in their peculiar ways of recording elapsed time.

The masonry of all the upper-level dwellings, which were occupied to the final abandonment of the pueblo, is of nondescript form. Unworked rocks of all sizes were laid down with no attempt whatever

¹ Judd, N. M., March, 1922, p. 326.

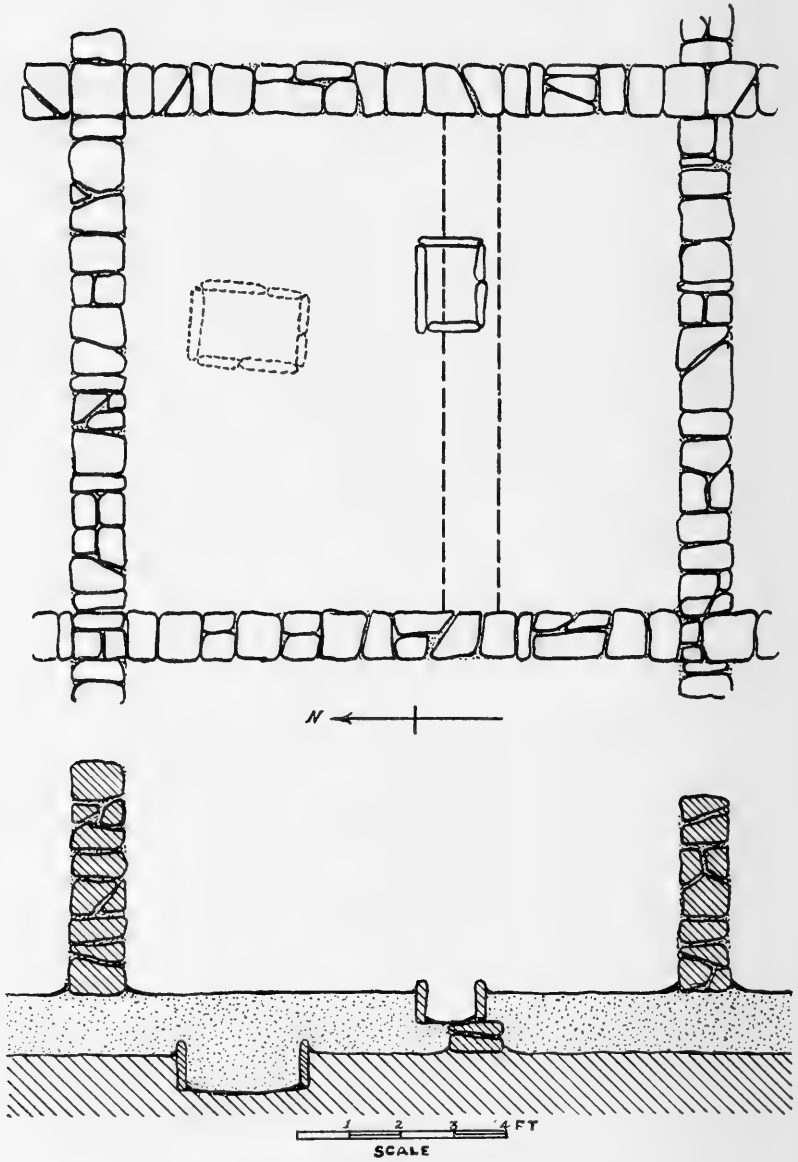

FIG. 3.—Plan and section of room 1, test 2.

at coursing. The walls frequently show flat curves or slight offsets, but, whatever their appearance, they were invariably plastered with clay.

The building stone in Showlow ruin is exclusively of buff-colored sandstone of Carboniferous age, broken from out-cropping ledges nearby. In all types of masonry, the walls averaged a foot in thickness¹ and were laid up with an abundance of clay mortar.

The living rooms are approximately square; 11 by 12 feet are measurements frequently recorded. The largest room opened by us was rectangular, measuring 11 by 17 feet. Floors are uniformly of hard packed clay and unbroken except for a slab-lined firebox, about a foot square and 8 or 10 inches deep, located near the center of each room. The rooms apparently were entered through hatchways as no side entrances were found. In several rooms we encountered fragments of large sandstone slabs perforated with a hole large enough to admit the passage of a man. Their position in the fallen roof material suggests that they were used as door frames. In one instance a rounded slab, large enough to close the hatchway, was found in association with the fragments of such a door frame.

Details of roof construction could not be learned with any degree of accuracy since in most cases the charred fragments of ceiling beams were too limited and in an extremely disorderly condition. If we may judge, however, from the impressions in burned roof clay, two methods of covering the principal supporting beams were pursued. In one case, reeds laid at right angles over the main beams formed the filling material, on top of which a final layer of clay was put down. In the second method, pine planks were substituted for the reeds. These planks, roughly split from logs, measure from 4 to 8 inches in width and 1 to 2 inches in thickness.

Kivas were not encountered by us, nor does Mr. Whipple, from our description to him, recall that he uncovered any in the course of his excavations. The depression in the south plaza was apparently judged to be a circular *estufa* by Bandelier.² An exploratory test in this depression failed to show the flagstone floor which is almost invariably associated with kivas. If, however, this low place actually marks the site of a kiva, in all probability it is rectangular instead of round. All kivas uncovered thus far in late pre-Spanish ruins in this

¹ Bandelier's statement that the walls were 0.20 m. (about 8 inches) thick was probably based on few measurements, as he did not excavate in Showlow ruin.

² Bandelier, A. F., 1892, p. 392.

region¹ and also in the Jeddito Valley² have been found to be of rectangular form. The apparent lack of kivas in Showlow ruin need not necessarily imply their entire absence as they may yet be found in several parts of the pueblo which have not been thoroughly examined.

MATERIAL CULTURE

Although the ensuing consideration of cultural material may appear to be a repetition of notes presented some years ago by other investigators, I feel that repetition is justified by the pre-Spanish dates recently fixed for Showlow ruin. By dating the building itself, the artifacts found within it may also be dated.

Foods.—All vegetal products recovered were found in a charred state, obviously preventing accurate and complete description. Practically every room yielded some corn, either shelled or on the cob. Shelled corn was ordinarily stored in large ollas, while ear corn was piled up row upon row, as is the custom of the modern Pueblo Indians. Such piles, when burned, generated a heat so intense as to fuse together large masses of the corn and even vitrify the adobe wall plaster.

Although beans likewise were stored in ollas we encountered them much less frequently than corn. A single small variety, *Phaseolus* sp.³ is represented.

Berry-yielding bushes are found abundantly in this timbered region, especially along the water courses. It was not surprising, therefore, to find among the stores of food stuffs, small quantities of berries. These have been identified as the fruit of the manzanita, *Arctostaphylos pungens*. This berry is about the size of a pea and has a large cretulated seed. The meaty parts are edible either raw or cooked.

Black walnuts (*Juglans major*) were also uncovered. The nuts are small but palatable, and probably were extensively used by the Indians. Walnut thickets still fringe the banks of Showlow Creek and the annual crop of nuts is relished by the children of the neighborhood.

Mammals.—Showlow ruin is located in what was formerly a well stocked game area. Deer and turkeys still range the nearby forests and

¹A rectangular room with flagstone floor and platform in Four-mile ruin described by Fewkes (1904, pp. 137-138) is apparently a kiva; the Hawikuh kiva (Hodge, F. W., 1922, pp. 9-10), and the kiva uncovered in Pinedale ruin described in this report were rectangular.

²See the chapters on Kokopnyama and Kin Tiel, herein, by Hargrave.

³For the identification of vegetal products we are indebted to Prof. J. J. Thornber, botanist, Agricultural Experiment Station, University of Arizona, Tucson.

it is only natural that their ancestors should have contributed most generously to the quantity of mammal bones recovered during our excavations. Lower jaw bones of dog, *Canis familiaris*,¹ and Arizona badger, *Taxidia laxis*, were found in room 1 of test 2 and test 13, respectively. Hough reports that he collected "bones of dog, two species of rabbits, turkey, and deer" in Showlow ruin.

OBJECTS OF STONE

Metates.—The milling stones used for grinding maize and other food stuffs are relatively numerous at Showlow. Most of these were manufactured of a porous basaltic lava, but a few were shaped from indurated sandstone. Two types of metates are represented in the collection:

(a) Trough-shaped specimens with both ends open and sometimes worn to a depth of from 4 to 6 inches. These are seldom more than 10 inches wide; their sides are usually carefully shaped by pecking. Without exception these metates were found free in the rooms, *i. e.*, independent of bins. From the position of some in the débris, it was judged they were originally on the house tops.

(b) Flat or slightly concave metates, with grinding surface measuring from 14 to 18 inches long and 10 to 12 inches wide. Mills of this kind are usually found in mealing bins either singly or in series. In room 1, test 3, a set of three contiguous mealing bins was encountered, and Mr. Whipple informed us that he had found during the course of his work as many as five adjacent bins. In a few cases the lower, embedded end of the positioned metate was narrower than the other by several inches.

Manos.—The movable hand stones with which grinding is actually done, are readily classifiable into two broad types, according to the shape of the metate on which they were employed:

(a) Manos accompanying the first type of metate described are rectangular in form with rounded corners. They measure from 7 to 10 inches long by 3 to 5 inches wide and are made of igneous rock, rarely of granite or sandstone. Only one surface was used for grinding and this is slightly convex lengthwise of the implement.

(b) Manos associated with the second type of metate are characteristic of those usually found in Pueblo IV ruins of northern Arizona. In cross-section they are triangular or nearly so, owing to the double-faceted grinding surface. This distinctive feature is shown by the

¹ Identified in the Department of Biology, U. S. National Museum.

fragmentary specimen in plate 6, figure 1, *a*, which is 8 inches long and 3 inches wide. The mano shown in plate 6, figure 1, *b*, is of the same class but the grinding face is not so pronouncedly angular. Its dimensions are $12\frac{1}{2}$ by 5 inches. The obverse sides of both manos here pictured are rough and unfinished. Their length corresponds to the width of the metates on which they were used. Instead of being made of volcanic rock as are the manos of the first type, these are invariably composed of hard sandstone.

As to the relative time of the above two forms of grinders, we can say that in the northeast quarter and in the lower level of occupation the trough variety only were found, while in rooms dating after about A. D. 1375 both types were coexistent, a greater proportion of the second type being present.

Paint metates.—Still in the category of metates are several specimens of rough volcanic blocks which are unmodified except for a shallow depression in one side. In these hollows the traces of paint materials which were ground in them are still visible. Oval handstones, some also showing color, were no doubt used in these. The basinlike depression suggests a rotary motion instead of one away from and towards the body.

Hammerstones.—These were used for pecking, chipping, and in countless other ways about the home, and are plentiful in Showlow ruin. They vary from small discoidal stones weighing a few ounces to large ones weighing a pound or more, and are usually formed of lava, diorite, or quartzite.

Stone axes.—The stone axes recovered by us were all short-bitted (pl. 6, fig. 1, *c*), none being over 6 inches in length. All, however, were carefully finished and possessed the three-quarter groove or the straight back which is typical of Middle Gila axes. Long-bladed axes of the true Gila type were found by Mr. Whipple.

Polisher.—While this fragmentary specimen (pl. 6, fig. 1, *d*) seems to have been used primarily in polishing arrowshafts, it also suggests other uses. It comes from the northeast quarter of the ruin and is made of a fine-textured basaltic lava, carefully worked even to the smoothing of the sides and ends. Its dimensions are $2\frac{1}{2}$ inches in height from the bottom to the crest of the medial shoulder and $2\frac{3}{8}$ inches in width. The groove to the right of the shoulder was apparently used in finishing arrow shafts but the opposite side does not show this, although it is well worn. A short lateral groove cuts the shoulder 1 inch from the unbroken end. The bottom of the implement also indicates wear.

Polishing pebbles.—Figures *e* and *f*, plate 6, figure 1, show two typical polishing pebbles used in the surfacing of pottery. Both have the very smooth facets which result from long use.

Perforated sandstone plates.—For the two objects represented in plate 6, figure 1, *g* and *h*, we can suggest no definite use. Both are made of sandstone not exceeding $\frac{3}{8}$ inch in thickness; both are carefully smoothed. Figure *g* is $6\frac{1}{8}$ by $5\frac{3}{4}$ inches and has rounded corners as well as trimmed edges. Along one edge there are three perforations, drilled from both sides of the plate. Specimen *h* is rounded, $6\frac{3}{8}$ inches in longest dimension. It has but a single perforation placed $\frac{1}{2}$ inch in from the short straight edge.

These objects are not greatly dissimilar to perforated boiling stones which resemble large pendants frequently found in ancient sites in southern California.¹ Boiling stones of this type are heated in the fire and suspended in vessels containing liquids for cooking purposes. Both of the specimens represented here show the effects of contact with fire, but whether the result from their use or from the burning of the rooms in which they were found, cannot be determined. The custom of using boiling stones, however, is a trait quite foreign to Pueblo culture; hence, their use as such must be questioned.

Loom block.—A single loom block was encountered in one of the living rooms. It is made of a soft friable sandstone and measures about 10 inches in height by 7 inches in width. The base and one side are entirely flat, while the rest of the block is more or less of rounded form. In the flat side near the top is a small depression less than an inch in depth which engaged one end of a stick or rod which formed a part of a loom. Similar objects found in old Hopi² and present-day Hopi kivas are usually shaped into the forms of rectangular blocks with the depressions in one end.

Potter's kneading slab.—A sandstone slab, not unlike those used at Zuñi³ at the present time by potters for kneading clay after the ingredients have been ground and mixed, is shown in plate 6, figure 2. It was found with a quantity of raw clay, yellow ochre, and a collection of sherds which had been gathered for pulverization to form tempering material. The slab is rectangular in outline, 33 by 17 inches. Its edges are chipped and pecked to a rough finish and the working surface bears two shallow worn depressions which still show traces of clay.

¹ Handbook of the American Indian, Bull. 30, Bur. Amer. Ethnol., Pt. I, pp. 126-127.

² Hargrave, Lyndon L., p. 108 herein.

³ Guthe, C. E., 1925, footnote p. 20.

Chipped implements.—Relatively few chipped stone objects were recovered. Projectile points are both plain and tanged (see fig. 13 for representative specimens from Pinedale), and a few have serrated edges. Knives and scrapers of chert and obsidian flakes show comparatively little secondary chipping. Figure *i*, plate 6, figure 1, is a chert knife on which the cutting edge has been slightly retouched.

The large implement shown in plate 6, figure 1, *j*, is lanceolate in shape, $7\frac{1}{4}$ inches long and $3\frac{1}{4}$ inches wide. It is crudely chipped from a spall struck from a lava block. Near the center of the object on each edge, are shallow notches which probably aided in hafting it to a handle.

Obsidian cache.—From the northwest corner of room 1, test 15, was taken a cache of 17 obsidian nodules which were probably intended to supply the material for projectile points. The nodules vary from $\frac{3}{4}$ to $1\frac{1}{2}$ inches in diameter. They are somewhat angular and covered with a thin veneer of opalitic substance.

OBJECTS OF BONE AND HORN

Awls.—Specimens *a*, *b*, *c*, and *d*, figure 4, are representative of the bone awls from Showlow ruin. Awls *a* and *d* were split from large bones after longitudinal groovings had been made and then trimmed down, while *b* and *c* were formed of natural bones with little modification. Incising was noted on several awls, probably representing crude attempts at decoration.

Dagger (?).—A large broken implement (fig. 4, *e*) is tentatively identified as a dagger. The fragment shown is 6 inches long with an inch or more broken from each end. A comparison of its size with normal awls makes it quite evident that it was intended to be used in some other way, the most logical use being that of a dagger. In his excavations at Turkey Hill Pueblo, near Flagstaff, Dr. Byron Cummings recovered excellent examples of these. In one instance several were found at the waist of a burial as though they had been suspended from or tucked beneath a girdle. Hodge¹ also pictures quite similar implements from Hawikuh, although he lists them as awls.

Incised bone.—Figure 4, *f* is a section of a mammal leg bone 7 inches long and 1 inch in diameter from which a portion has been severed by a circumambient incision. Below the cut end is another scoring made in preparation for the removal of a short section.

¹ Hodge, F. W., 1920, pls. 10, 11, 12.

Horn implement.—This specimen (fig. 4, *g*) consists of a prong of a deer antler 6 inches in length. It is unaltered except for slight wear at the blunt point and several hackings at the base apparently made with a flint tool in the process of its removal from the major antler.

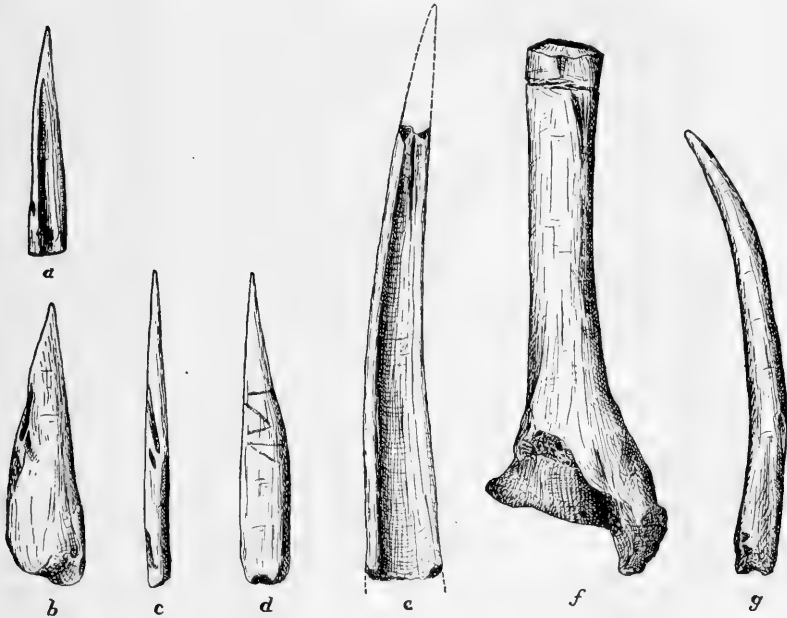

FIG. 4.—Bone tools from Showlow ruin. ($\frac{1}{8}$ actual size.)

POTTERY

The Silver Creek drainage (see map, fig. 1) is a region which in past ages was on the periphery of several important southwestern sub-culture areas. To the north lies the center of Hopi development with its very distinctive yellow decorated pottery; to the east, the old Zuñi pueblos with their variable types of glaze-painted vessels; to the southeast, the Upper Gila; and to the south, the Middle Gila culture areas, each with characteristic pottery. Ceramic types from all of these areas are represented in Showlow ruin. Thus, a treatment of the pottery of a region, especially with reference to its sequential occurrence, where a considerable mixing of local and foreign types has taken place, is a problem of some complexity and one that can be solved only by prolonged and careful research.

Although the limited nature of our excavations does not warrant the drawing of fine distinctions between the several recognized culture

horizons at the present time, the data procured from stratigraphic evidence at Showlow should prove of interest to archeologists. It is also possible here to include some of the invaluable results which have been obtained from the study of tree rings displayed in charcoal. The reliable stratigraphical method of studying prehistory bids fair to be surpassed by this newer means of establishing succession, which embraces the association of artifacts with datable timber. Results obtained from stratigraphy will not only be checked but will be supplemented with the precision that only accurate dates can give. However, precaution must be exercised in its use, for the associated circumstances are of utmost importance. For instance, the finding of newly developed ceramic types in very old rooms, or in rooms where structural timbers were re-used, would be certain to give misleading results unless corroborated by other finds.

At Showlow ruin, the association of pottery with datable charcoal was relied upon to a certain extent in an attempt to establish a sequence. This is true especially of the pottery from the more recently occupied section of the pueblo. In arriving at ceramic correlations between Showlow and Pinedale ruins, charcoal proved to be of invaluable assistance.

Hough¹ observed that potsherds on the surface at Showlow ruin were exceedingly scarce. This reminded him of the practice of modern Zuñi potters, who gather from the rubbish heaps of old ruins sherds for pulverization to be used as tempering material in clays for new vessels. That this practice obtained in more remote times is well known to all students of southwestern prehistory. We found it also at Showlow.

In the corner of room 1, test 12, was encountered a polychrome-on-red bowl filled to the brim with sherds which had apparently been picked up on the trash pile. There is little question but that these had been set aside for future grinding. Almost all types of pottery known at the pueblo up to the time of collection were represented. This has a slight bearing on the technology to which we refer later. Not far from the sherd collection and leaning against the wall was the kneading slab pictured in plate 6, figure 2. The several slight depressions in the working surface were caused by much mixing of ground sherds with clay and the kneading of the paste to obtain the proper consistency. Behind the slab was stored a quantity of raw clay of gray color just as it had been mined, and yellow ochre for use as coloring matter. Worthy of mention too, are several fragments of unfired vessels which were recovered. These clearly show the gray

¹ Hough, Walter, 1903, p. 301.

paste with the admixture of pulverized sherd tempering (see pl. 10, fig. 2). Exterior and interior surfaces of the sherds bore the yellow slip applied in wash form, which, upon firing turns to a rich red. Other tools such as scrapers, formed of broken fragments of pottery, and pebble polishers also show the similarity of ancient and modern methods of making pottery. While styles of decoration and vessel forms are continually undergoing changes, there seems to have been no great departure in method since the close of the 14th century, the approximate age of the objects found.

Two sharply defined levels of occupation were found to exist in the Showlow ruin. All of the rooms opened in tests 1, 2, 3, and 12 had two floor levels (see fig. 3 for plan of room 1, test 2). Pottery types from all lower level rooms were in entire agreement and a correspondence of sherds gathered in upper level rooms was also noted. Comparisons of the sherds from the two levels, however, introduced the fact that there was a considerable difference of time between the two occupations. This difference we have provisionally placed at about 170 years, based upon data derived from datable charcoal.

Lower level types.—Potsherds from the lower level include the following types: Black-on-white, black-on-red, an orange-red ware decorated in both black and white paint, corrugated, and a small amount of intrusive material.

The black-on-white sherds roughly fall into two groups: (a) those showing definite Chaco Canyon affinity, and (b) those obviously related to the black-on-white of the now known Upper Gila culture area. Chaco-like sherds (pl. 7, fig. 1, nos. 1, 2, 3, 4, 5) are fragments of bowls with direct rims having a chalky white slip and rough exteriors. The decoration is in dull black paint and the designs, while they bear certain similarities to Chaco black-on-white, are nevertheless somewhat different. In the hatched elements, for instance, the framing lines are of the same width as the filling lines. The rims, however, are usually painted black and tapered, both typical Chaco features.

Sherds bearing similarities to vessels better known from the south and southeast are preponderantly of ollas and smaller, full-bodied vessels. The paint is dull black, but in rare cases it has a lustrous silvery appearance. The designs (pl. 7, fig. 1, nos. 6, 7, 8, 9, 10, 11, 12) consist of alternating solid and hatched elements, opposed stepped figures and interlocking elements. The canteen and fragmentary bowl, figured in plate 7, figure 2, were found in a firebox in the lower level over which the later occupants had erected a wall. The canteen is

6 inches in horizontal diameter and the orifice formed by a small vertical neck is but $\frac{3}{4}$ inch in diameter. The lugs are squared and the sides of the vessel are depressed immediately below the lugs to allow more space for the passage of a cord. The black paint is dull, applied in an all-over design except for a small circular area at the bottom. The rim is edged with black dots. Canteens of a similar type have also been found on the Gila River in the region of San Carlos and in the Tonto Basin.¹

The bowl is not round but elongated; apparently it was compressed before or during the firing process. Its greatest diameter is 10 inches. The heavy walls terminate in a flattened rim and a slightly over-turned lip. The background is gray rather than a dead white as in the canteen, and the design is in a flat black paint.

The Chaco-like black-on-white ware is most certainly the older of the two black-on-white types from the lower level. The terminal date for Pueblo Bonito given by Doctor Douglass² is A. D. 1127, but it reached its heyday in 1067. Hence, possibly by 1067, certainly before 1127, the Chaco influence was extended southwestward as far as the Silver Creek drainage. Its presence should therefore be expected in sites which antedate the lower Showlow level. That this condition actually exists was clearly demonstrated by Roberts during the summer of 1929 in his work on a pit house and early pueblo site on the old Long H ranch, 20 miles north of St. Johns. He reports³ that the pottery from both the pit houses and the surface pueblo is distinctly related to the Chaco Canyon cultures. In the Showlow lower level, the pottery of Chaco affinity was decidedly on the wane and pottery suggesting Upper Gila influence was springing into prominence. By about 1290, as we found at Pinedale, the former had entirely lapsed and the latter, whose exact relation needs yet to be established, was strongly reflected in the dominant black-on-white ware. In all probability the culture represented by it, first in the lower Showlow level and later more strongly at Pinedale, is subordinate in this region and an extension from the parent stock to the southeast.

Fragments of black-on-red pottery are extremely rare in lower level débris. Rim sherds of a number of individual bowls (fig. 5), however, illustrate the existence of a fairly uniform type. Several of the sherds were found built into the walls of the dwellings of the first occupation. This may signify that a still older horizon to which

¹ These specimens are to be found in the Arizona State Museum, Tucson.

² Douglass, A. E., December, 1929, p. 767.

³ By personal letter of January 27, 1930.

these sherds belong is to be found elsewhere in the ruin. Features which correspond in all sherds are: A rather coarse-textured paste is used which burned red with a dark core; tempering consists of crushed rock of light color and possibly a small amount of pulverized potsherds; the slip is of a deep red color applied both inside and outside of bowls; vessel forms consist of bowls only, and these are unusually deep¹ with slightly incurved rims and rounded or squarish lips; the

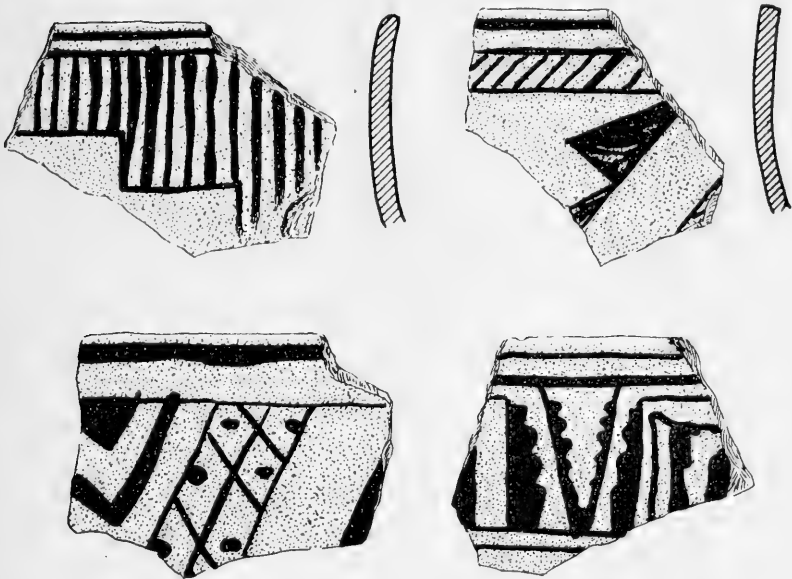

FIG. 5.—Black-on-red sherds from Showlow ruin which probably antedate the lower horizon. ($\frac{1}{2}$ actual size.)

decoration is in a thin black paint which has a slaty appearance and in some places is obliterated. Brush-work is very crude; lines were over-carried and variable in width. A narrow black line below the rim on the inner surface is characteristic of all the fragments in the collection. The designs consist of rudimentary hatching, dentate elements, terraces, and triangular figures. These are separated from the rim-line by a narrow unpainted zone. There is no exterior decoration. If the inference is correct that this type is aberrant to the lower horizon, belonging to an older culture stratum, its age is unquestionably pre-1200. While the provenance of this ware is not clear, I am of

¹ The Showlow collection in the possession of Gila Pueblo, Globe, has several complete examples.

the opinion that it is parental to the later orange-red decorated ware which bears the white exterior and black interior decorations.

This latter form is nearly as abundant as the black-on-white in the refuse of the first occupation. It has commonly been referred to as Little Colorado polychrome and was undoubtedly the most ubiquitous pottery known to the Southwest. In this instance it is an orange-red phase instead of the deeper red which it usually takes. Its presence was one of the guides used by Doctor Douglass in selecting sites which would provide the gap material for his tree-ring chronology. The paste is of a gray color, which shades to a light gray towards the surfaces of the vessels. Tempering material of coarsely pulverized sherds is abundant. The slip varies from a dark to a light orange-red color and is unusually thick. By actual measurement it was found to be one-twentieth of an inch thick in one case. Vessel shapes are exclusively bowls with pronounced incurving rims. Interior ornamentation is in dull black pigment (pl. 8, no. 1) consisting mostly of repeated interlocking or opposed solid and hatched figures. These are confined in a broad horizontal zone by two narrow framing lines, one below the rim and the second towards the center. The center of the bowl is thus left undecorated. Exterior decoration is made up of broad, rudely drawn, white stepped lines or terraced figures (pl. 8, nos. 2, 3, 4). These are also limited to a horizontal zone below the rim but never as wide as the one on the interior. A very small number of pottery fragments of this type show the use of white as a complementary color to the black on bowl interiors, and, conversely, the use of black on exteriors. These are believed to be local prototypes of an upper level pottery and will therefore be considered later.

Corrugated ware of the first horizon appears to consist almost solely of large ollas. The paste is gray to nearly black, quartz tempered and crumbles easily. The coils are not very fine and the indentations are shallow (pl. 9, fig. 1). Attempts at decoration by leaving a series of coils unindented as in 5 and 7, or other techniques, are seldom met with. Fragments of finely corrugated bowls bearing white exterior designs (pl. 9, fig. 1, nos. 4, 6, 10) and blackened interiors were rare in the lower level but occurred frequently in the northeast section of the ruin which we believe to be older still than the first horizon. This form is possibly best known from the Upper Gila. Its abundance at Showlow and at Pottery Hill¹ suggests local manufacture and thus may indicate a direct link between the southeastern sub-culture.

¹ Hough, Walter, 1903, p. 300.

Trade pieces are represented by a few scattered fragments of Pinto polychrome bowls,¹ *i. e.*, black-on-white interiors and undecorated red or reddish-brown exteriors.

Upper level pottery.—Turning now to the upper level pottery we find that radical changes took place during the interval of time represented by the abandonment.² Lower level forms had ceased to exist; new forms had been invented and the area was being penetrated by trade vessels from several adjacent regions. This second horizon, to which we can give the general dating of A. D. 1375, existed through to the devastation of the village by fire.

In the upper level, black-on-white is practically absent. The few scattered sherds probably represent survivals from the preceding period when that form was in vogue. Black-on-red is entirely lacking as is also the form of Little Colorado polychrome here described.

Four-mile polychrome.—In speaking of the artifacts at Showlow, Bandelier remarks that he found "nothing unusual except the pottery, which resembles that at Tule."³ There are specimens with glossy decorative lines, but the glaze is more carefully applied, the designs more perfectly executed. . . ."

In 1897, Fewkes conducted excavations in Four-mile ruin,⁴ situated 4 miles from Snowflake, and about 2½ miles west of Taylor, Arizona. The predominating pottery type recovered by him was a "redware with black decorations having a margin of white."

The pottery thus briefly characterized by both Bandelier and Fewkes was found in abundance during our work at Showlow. It formed approximately 75 per cent of all the pottery during the time of its dominance. This type is not new to those familiar with the archeological literature of the Little Colorado drainage. Fewkes gives excellent color plates⁵ of it; other later investigators in that field also picture it. As far as we have been able to ascertain, however, little has been done toward a careful description of the ware or an analysis of its derivation and relationship to other types. Likewise it lacks a suitable name to accord it the distinction which it merits.

¹ The Medallion, 1930, pp. 4-5, pl. II.

² By the abandonment we refer only to the rather restricted section where double occupation was found to exist. It is likely that the pueblo was occupied continuously but with small local movements within the structure.

³ Located about 14 miles east of St. Johns.

⁴ Fewkes, J. W., 1904, pp. 136-164.

⁵ *Idem*, pls. XXI, XXII, XXIII, XXIV, XXV, XXVI, XL, XLVII.

Upon the suggestion of Dr. A. V. Kidder, at the 1929 Archeological Conference at Pecos, New Mexico, we here refer to this form as "Four-mile polychrome." Fewkes' Four-mile ruin seems to be the type site for Four-mile polychrome. There it is found in great abundance and in what appears to be its most highly developed stages. Furthermore, Four-mile ruin is the approximate focus of the known distribution of this pottery. Its distribution is roughly conterminous with the area drained by Silver Creek and its affluents. Notable sites not included in this drainage but where Four-mile polychrome is found in some abundance are Forestdale, Chavez Pass, Homolobi, and Chevlon. All of these, however, are peripheral to the drainage area in question. Trade pieces have been found as far south as Bylas, Arizona, on the Gila River; in the Tonto Basin; at Casa Grande, and as far north as the old Hopi ruins in the Jeddito Valley.

Technology.—A study of the technology of Four-mile polychrome reveals the traits on which the creation of this type is based. The constancy with which some of the characteristics occur is worthy of note.

The paste is light gray in color, usually merging into a dark gray core towards the inner part of the vessel walls, and sometimes appearing reddish outwards. The paste fires to a hardness sufficient to give breaks with fairly sharp and smooth edges. Tempering material consists of ground-up potsherds and small rounded grains of sand, these ingredients occurring in about equal proportions. There is also a relatively small amount of dark particles, apparently ground basalt. In plate 10, figure 1, is shown a quantity of tempering, enlarged four times, which was removed from a sherd of an unfired vessel. Small angular bodies of white slipped vessels can be detected. Plate 10, figure 2, shows an unfired sherd (four times normal size) containing a sizable fragment (circled) of a former red-slipped vessel. As may be supposed, the addition of tempering derived from pulverized sherds of various sorts would be apt to introduce a considerable variety of extraneous inorganic substances.¹ The quartz grains as well as particles which appear to be crushed basalt were probably used as tempering material in previous vessels.

The slip is an even red color unless over-fired, when it turns to dark brown or almost black. Before firing, the slip is yellow, being made of the yellow limonite. This is to be seen in the upper half

¹ The sherd collection, which has already been noted as having been made for the purpose of grinding, is ample evidence of this.

of the unfired sherd in plate 10, figure 2. The slip is thin, fairly well pebble-polished and rather soft, so much so in fact, that on the bottoms of vessels and other surfaces exposed to wear, it has been entirely worn away. In a good many cases, the surface is seamed with minute cracks.

Shapes.—Vessel forms of Four-mile polychrome are almost exclusively ollas and bowls, the latter predominating. Several olla shapes are noted:

(a) The largest ollas (fig. 6, *a*) are shaped somewhat like the polychrome ollas from the Middle Gila. The body is compressed vertically and the neck rises at a steep angle to form the mouth

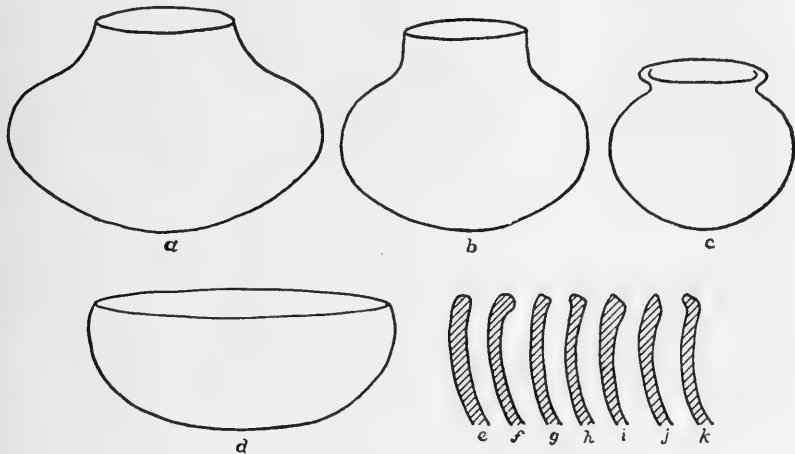

FIG. 6.—Vessel forms of Four-mile polychrome.

which is smallest at the rim. The lip is direct. As far as we know, only fragments of these exist.

(b) The most prevalent form of olla is much like the first excepting that the body is usually more rounded and the neck rises more abruptly (fig. 6, *b* and pl. 11). The neck is from 1 to 2 inches high and the lip always direct. The horizontal diameter seldom exceeds 12 inches.

(c) The third type (fig. 6, *c*) consists of small round-bodied ollas whose diameters vary from 5 to 8 inches. The neck is short or absent and the lip terminates in a decided flare. The mouth is larger in proportion to its size than was noted in the foregoing types.

Bowls (fig. 6, *d*) vary from 7 to 14 inches in diameter and are always less than one-half the diameter in depth. The rims are generally gently incurved and carried to the lip with or without thinning of

the vessel wall. The lips show a variety of treatment (fig. 6, *e* to *k*) in rounded, squarish, and bevelled forms. Bowls with rounded lips appear to be the rule.

Pigments.—The paints employed in carrying out the designs on Four-mile polychrome are black and white. The black paint is basically a lead glaze. Where thin it usually has a metallic luster and where thickly applied it is apt to be dull, sometimes vitreous and showing small granular bodies. It bit deeply into the slip, giving the black patterns permanency. The apparently gritty texture of the paint made it more difficult to manipulate than a free-flowing pigment, hence the brushwork does not show the clear-cut edges that it otherwise might have. Brush dips are clearly visible.

Quantitative analysis¹ of this glaze paint show that the main constituents are lead, copper, and usually some manganese. As one would expect in primitive pottery, where the pigments were not mixed by exact formula, the ingredients vary in proportion in the paint on different vessels. This fact possibly accounts for the slight difference in appearance of the paint. It is also likely that the length of time the pottery was subjected to fire and the intensity of the fire affected the final product. Individual paint determinations showed that lead and copper were almost always present in considerable amounts. A composite test of the paint on 12 sherds of Four-mile polychrome indicated a ratio of 1:2+ of lead to copper and the presence of a negligible amount of manganese. If the lead was in the form of an oxide when used, it would, upon heating, produce a silicate or glaze of light brown to yellow color. This silicate would promote the fusing of the copper and manganese compounds which impart the black color. The common occurrence of blue and green copper carbonates in ruins suggests that the copper element was added to the paint mixture in the form of a powdered carbonate. Heating would convert the carbonates to an oxide of copper of black color, which, being less fusible than the lead component, would tend to remain as the gritty particles already mentioned. The small amount of manganese present could have been combined with either the lead or copper ores when mined. Sodium salts which give a glaze similar to that of lead may also be present in the paint.

The white is a soft chalky paint that can be readily scratched off with a knife. As a result the white parts of the designs are often

¹ The chemical tests of glaze paints on pottery from Showlow and Pinedale pueblos were kindly made by Mr. F. G. Hawley, Chief Chemist, International Smelter, Miama, Arizona.

partly obliterated. While the white pigment may be considered to be of secondary importance in its use as an outliner for the heavier black lines, it was the first to be applied to the vessel surfaces in blocking out the designs and later supplemented with black.

Designs.—In the ornamentation of Four-mile polychrome, a stylistic divergence is noted from the usual trend of Southwestern pottery. The conventional repetition of elements in orderly zones and the involved interlocking elements noted on some of the lower level pottery are devices of the past. Instead, the field of design is broken up into irregular units and treated with a freedom and boldness previously unknown. In the latest forms, pure geometrical figures give way to conventional adaptations of life forms.¹

Olla decorations.—The several types of ollas are decorated much in the same manner. The neck and a small part of the upper-body are covered with a white slip which is carried well down on the inside of the neck. The white is seldom pebble-polished, hence rough and cracked. The remainder of the body is covered with a red slip and fairly well polished. There are two zones of decoration: (a) the white upper part and neck, and (b) from the lower edge of the white to a point not far below the maximum diameter of the vessel. The designs of the two fields are entirely different. On the white field the elements in black are simple and very often used independently. Crosses (fig. 7, *a* and *b*), "turkey tracks" (*c*), dots, stepped and paired lines (*d*, *e*, *f*, and *g*) are favorites. Elements represented in figure 7, *h*, *i*, and *j*, are appended to a continuous band placed just below the rim. The second field of design with patterns in black and white on red is a broad horizontal band bordered above and below with heavy black lines (pl. II, *a*, *b*, *c*, and *d*). It is divided into panels by broad black lines or otherwise divided off into recurrent units. White is used as a complementary color to the black. The design elements are essentially the same as those occurring in bowls, which are described later.

Bowls.—Decoration was applied to both interiors and exteriors of bowls, the principal design being on the inside. A very constant feature of inner decoration is a black band, $\frac{1}{4}$ to $\frac{1}{2}$ inch in width, placed immediately below the rim. It is invariably bordered by a narrow white line on the lower side only. In the majority of cases this band completely encircles the bowl. Where interruptions were made, the white lines are continued around the ends of the black band and extended upwards to the rim. The persistent occurrence of this rim-band, even in bowls where the rest of the interior was left

¹ For color plates see Fewkes, J. W., 1904, pls. XXV and XXVI.

unpainted, and a corresponding pair of lines on the rim exterior, may be considered as helpful marks of identification.

Separated from the black and white border by an undecorated zone from $\frac{1}{2}$ to 2 inches in width is the design area proper. It is normally of circular form. Only in extreme cases are the decorative elements appended directly to the black band at the rim. For an adequate understanding of these interior designs, we must resort to illustrations. In plate 12, *a*, the field of decoration is quadrate. Opposing quarters are paired and treated similarly. The whole is encircled by a heavy black border, outlined in white. In *b*, the field

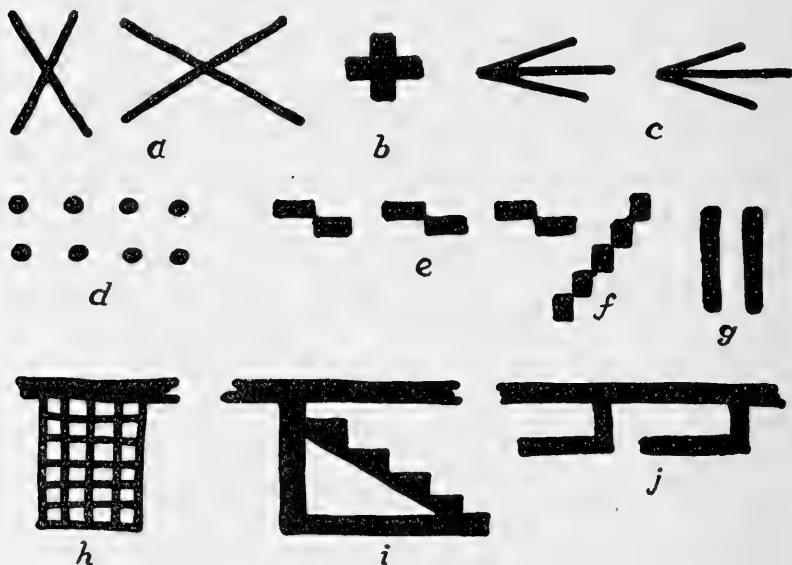

FIG. 7.—Design elements on Four-mile polychrome olla necks.

is divided into two opposing sectors which are connected by a medial line joining extensions of the arcs on opposite sides of the sectors. The designs in each of the latter are identical. The bilateral symmetry exhibited in these two bowls seems to be general in the early phases of Four-mile polychrome. In later forms the central field is treated with spirals, triangles, rectangles, sectors, or life forms, all parts of the design being connected, thus forming a continuous though not balanced arrangement. The design represented in figure 10, *c*, is typical of this feature.¹ The bowl figured in plate 12, *c*, is ornamented with a horizontal band 2 inches in width placed

¹ For additional examples see Fewkes, 1904, pls. XL, XLVIIa.

3 inches below the rim. Four white lines dotted at regular intervals with paired rows of black spots are diametrically drawn across the central bare area. Specimen *d* is an excellent example of the uniqueness of design found in many Four-mile polychrome bowls. From the central black spot, a number of white lines terminating in black dots radiate rimwards. It reminds one of a child's drawing of the sun. It will be noted from the preceding vessels shown that rectilinear and curvilinear styles are used with equal skill, and that transitions from one to the other are made within the same vessel.

Bowl exteriors are treated in a very uniform manner. The ornamentation is confined to a horizontal zone beginning immediately below the rim and extending downwards for from $1\frac{1}{2}$ to 3 inches. This zone is enclosed by two parallel, heavy black lines. The upper one is outlined in white on the lower side only, while the lower one is framed on both sides. The designs introduced into the zone are in white except in the more elaborate instances where black also appears. Figure 8, no. 1, shows a simple continuous line pattern, and in nos. 2 and 3 concentric parallelograms and triangles are represented. Modifications of the fret or "dentiform" figures¹ are characteristic as in nos. 4 and 5. The zone is often panelled by one or more diagonal or vertical lines, or merely by the enclosing lines as in no. 5. Elements are usually repeated in each panel but sometimes with slight variations. In no. 6 we see a more elaborate treatment. Black diagonal, terraced, and plain vertical elements connect the top and bottom borders. To these further embellishment is added in white.

Elements of design.—The units of decoration in the main are not dissimilar to those generally employed in Southwestern pottery. The distinction of Four-mile polychrome designs, however, is based on the very singular treatment of the elements, a freedom from the conventional equating of the field of design. Obviously this paved the way for greater elasticity in the expression of the relatively few elements into innumerable variations.

Of the elements, the following appear to be of primary importance: (a) triangles, (b) terraced or stepped figures, (c) spirals, and (d) frets.

In figure 9, nos. 1 and 2, triangles are shown as they occur in their simplest forms, while in no. 3 a triangle is embellished in white, and in no. 4 may be seen a common modification of the triangle combined with another element. Frequently in the center of this geometric figure a small rectangular area is left unpainted, which is then either

¹ Spier, L., 1919, pp. 367-8.

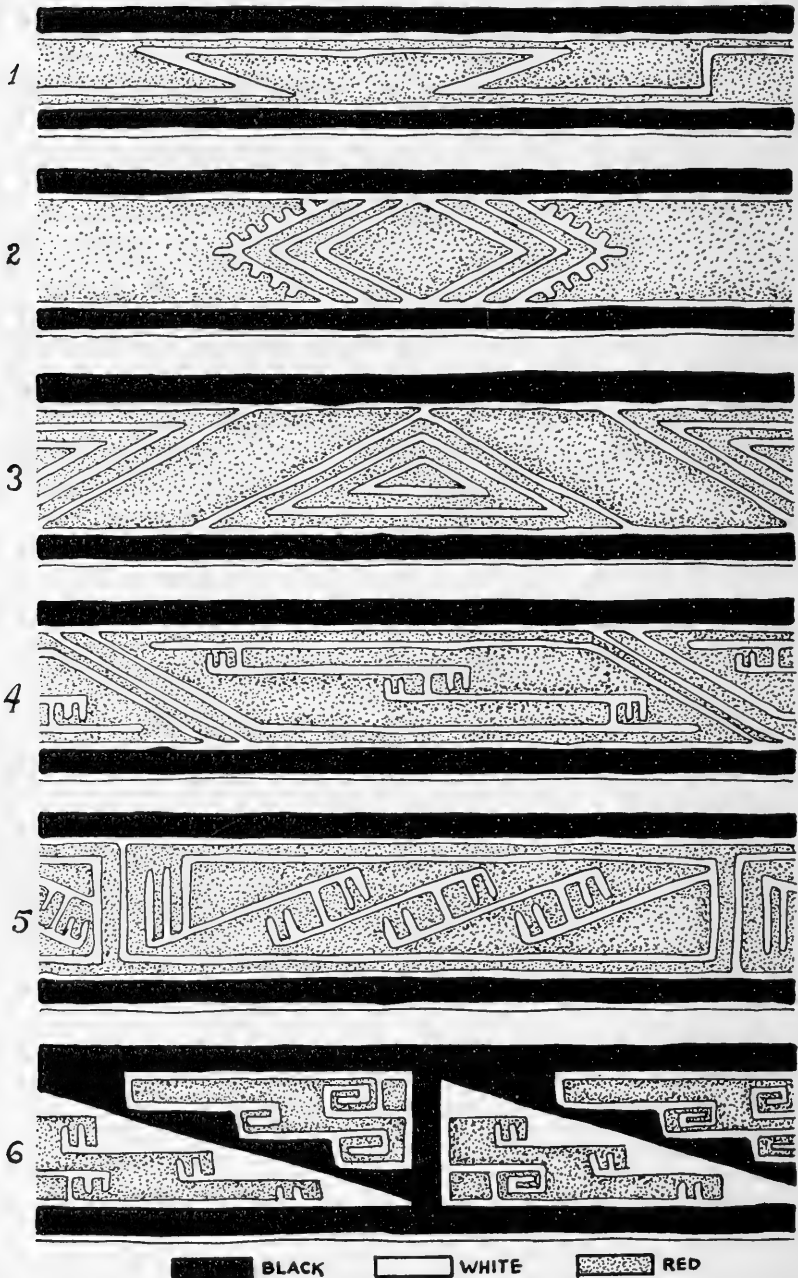

FIG. 8.—Typical bowl exterior decorations of Four-mile polychrome.

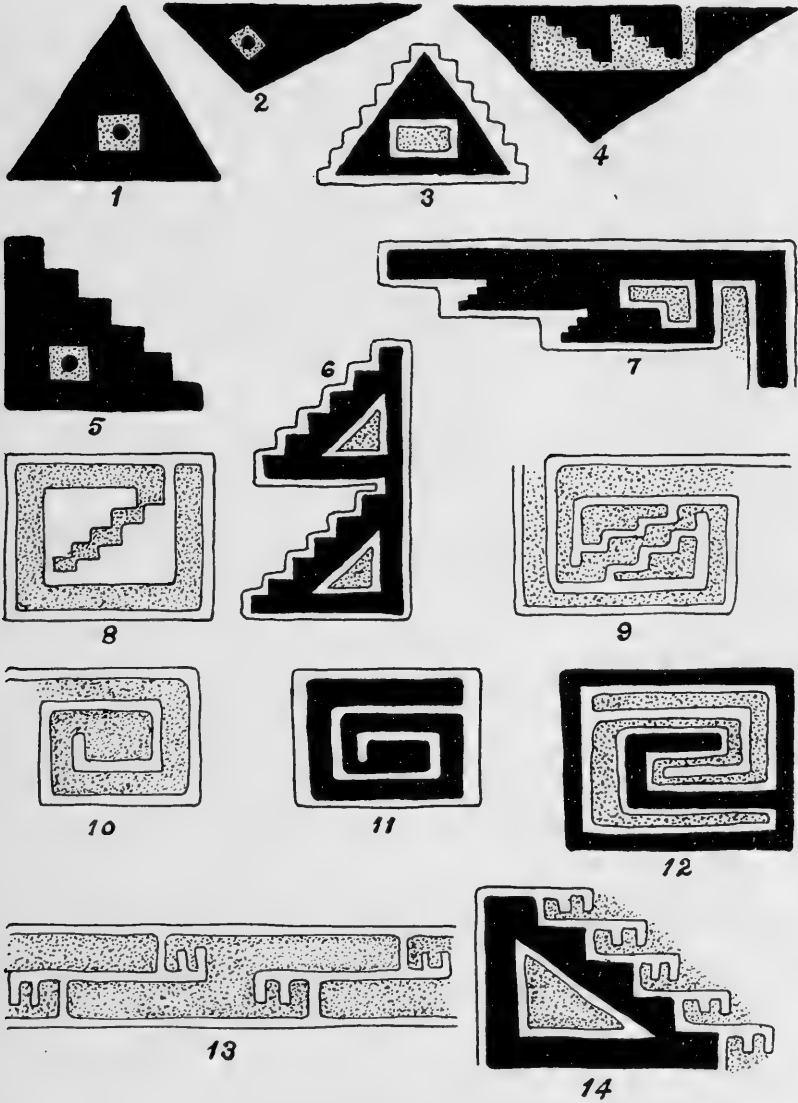

FIG. 9.—Design elements of Four-mile polychrome pottery.

dotted in the center or outlined in white. Terraced elements (nos. 5, 6, and 7) are characteristic. They are used singly, in pairs, or in complex patterns and, less often, in opposed positions as in nos. 8 and 9. Spirals fall into two classes: (a) large curvilinear forms constituting a unit of the entire design (fig. 10, c) which are reminiscent of similar devices occurring commonly in Upper Gila black-on-white and in some Little Colorado polychrome but without the solid interlocking element; (b) small angled spirals used as filling elements (fig. 9, nos. 10, 11, and 12). The latter is an uncommon form of the interlocked spiral. Variant forms of the fret (fig. 9, nos. 13 and 14) also (fig. 8, nos. 4, 5, and 6) predominate on bowl exteriors. Combinations of the fret with the above listed elements are frequently used in bowl-interior and olla patterns.

Structure of designs.—The initial step in applying the decoration was to block out the area to be covered with narrow white framing lines (fig. 10, a). It is evident that the artist had a fair conception of the combination of elements that were to be used before the first pigment was applied. Where panels were to be filled with white only, as in the case represented, that was done before the next color was taken up.

The second step consisted of applying the heavy black lines inside the white borders (fig. 10, b). The width of these varies somewhat. If drawn within areas later to be filled with other elements, they are seldom more than twice as heavy as the white, but where the white framers connected parts or surrounded the design, the black lines are heavier.

In the final stage, all bordered areas are filled with coarse hatching (fig. 10, c) which ordinarily parallels the longest side of the block. A variant of hatching is to be noted in the spiral where sets of parallel lines are offset by appended dots. Heavy stepped lines are also used with hatching as fillers.

The dating of Four-mile polychrome is made possible by a number of cases of its association with timbers that yielded cutting dates. The last big construction period in the Showlow ruin extended over approximately 25 years prior to 1383. The latter date is the most recent cutting date found in over 1200 specimens gathered from various parts of the pueblo. It appears, then, that no major building was going on after 1383. In 15 rooms belonging to the period in question, Four-mile polychrome was invariably present. This means that the pottery found in a room constructed in, say, 1375, would likely



A



B



C

FIG. 10.—Steps in the application of a design in a Four-mile polychrome bowl.

be post-1375, provided the associated pottery was not exotic but representative of local types at that time. The finding of Four-mile polychrome in these 15 rooms places its time unquestionably as shortly after 1383, although it was present in rooms dating 1375 and may even have been in existence 25 or 30 years earlier. That it had not been developed by A. D. 1300 is shown by the results of excavations at Pinedale, where an antecedent form was in existence at that time and Four-mile polychrome was absent. Nor do we know exactly how long it survived after 1383. Showlow ruin was probably abandoned at the close of the 14th or early in the 15th century just before the Hopi Jeddito black-on-yellow penetrated the region in any appreciable amount. In addition to its characteristic polychrome,¹ Four-mile ruin contains an abundance of the Hopi yellow (Jeddito black-on-yellow) which would place the abandonment of that site after Showlow. But how long after, we are not ready to say. The absence of Sikyatki polychrome at Four-mile ruin implies its abandonment prior to 1450 A. D.

Plain redware.—In the later period at Showlow plain red bowls and ollas were made and used. Sherds were not found in the lower deposits.

A nearly complete, plain red olla seems representative as far as our sherd collections show. Its paste is gray and tempered with coarse sand; its outer surface bears a red slip. Firing clouds are common on these plain red ollas. The shape is similar to the Four-mile polychrome ollas except that the upper body is flatter and the neck more cylindrical. Plain red bowls are technologically the same as Four-mile polychrome bowls except that the decorations are omitted. Several nearly complete specimens and numerous sherds indicate that they were seldom over 8 inches in diameter.

Corrugated.—In the upper Showlow level, corrugated pottery occurs only as ollas. The paste is gray, quartz tempered, and crumbly. Corrugations and indentations are much the same as in vessels of the older horizon (pl. 9, fig. 2, nos. 1 and 2), but a new treatment, not found in the lower rooms, has come into general use. In this the coils were so manipulated as to give the surface shallow horizontal flutings or ribs (pl. 9, fig. 2, nos. 3, 4, 5, and 6).

The finely corrugated vessels bearing exterior decoration are absent in this level.

¹Type specimens of Four-mile polychrome vessels are to be seen in the U. S. National Museum; Gila Pueblo, Globe, Arizona; Arizona State Museum, Tucson; and the Museum of Northern Arizona, Flagstaff.

MISCELLANEOUS POTTERY OBJECTS

Parching plates (?).—Utensils formed of fragments of broken clay vessels were occasionally encountered in the diggings. From room 2, test 16, two small plate-like vessels were collected. The larger of the two (pl. 13, fig. 1, *a*) is $7\frac{1}{2}$ inches in diameter and $1\frac{1}{4}$ inches deep. It is made from the bottom part of what appears to have been a large smooth red olla. The edge, although irregular, has been ground down to remove all rough places. The smaller plate (pl. 13, fig. 1, *b*) is $5\frac{1}{2}$ inches in diameter and made from the base of a corrugated olla. Its edge is not finished as in the former specimen. Fragments of a larger but similar vessel came from room 2, test 3. It is approximately 12 inches in diameter and 4 inches deep, and at one time formed the bottom of a thin, plain red olla.

As to their use, it is not unlikely that they served as parching plates for corn. The dark irregular centers and light edges of both plates pictured show that they were used over hot coals since their manufacture from the original vessels. That they were also put to other uses, such as containers for pigments, etc., is suggested by an incrustation of fine clay-like material on the inner surface and on the under side along the edge of specimen *a*. This substance is apparently the same as the material used for red slips on vessels.

Pottery scrapers.—Several objects made of potsherds and used in scraping the surfaces of unfinished clay vessels were recovered in Showlow ruin. The nature of the vessel on which a scraper was to be used apparently governed its size and shape. One specimen is ovate, measuring $4\frac{3}{4}$ by 3 inches; another is of semi-circular form and considerably smaller. The wearing on all, however, indicates that the convex surfaces advanced in the scraping stroke.

Intrusive pottery types.—In rooms from which the latest cutting dates were recovered, there appeared occasional fragments of vessels obviously foreign to the Showlow district. Some of these undoubtedly came from the Zuñi region, not a great distance to the east. And Middle Gila pottery¹ is represented by a very few bowl sherds showing the characteristic red on the outside and the black-on-white internal decoration.

The following Zuñi types, as established by Hodge in his work at Hawikuh² are represented in our collections from the upper Showlow level: Type C, by a sherd of a full-bodied vessel with black glaze on

¹ Gladwin, H. S., September, 1928, p. 20.

² Hodge, F. W., 1923, p. 29.

a white slip and by a bowl fragment with greenish glaze on a cream slip; Type D, by a cream-colored bowl fragment ornamented with green glaze and red, a non-glaze color. Hodge's Period E is probably represented by the fragmentary bowl pictured in plate 13, figure 2, *a*, in which the designs are rudely executed in a dark buff, non-glaze color on a light buff background. A similar bowl, with black glaze decoration, is to be found in the Showlow collection now at Gila Pueblo, Globe, Arizona. All of these Hawikuh types came in well towards the end of the occupation of Showlow ruin.

Jeddito black-on-yellow, the early forms of which appear to have come into use soon after 1300 in the great ruins of Jeddito Valley, was almost unknown at Showlow as late as 1383. A single sherd of this type was found in room 2, test 2, with timber that dated approximately 1375, but that it was better known than this one sherd would indicate is evidenced by what we have interpreted as local imitations of Jeddito ware. The bowl figured in plate 13, figure 2, *b*, has a yellowish surface decorated in black by an uninterrupted line below the rim on the inside and by simple angled figures attached to the rim line on the outside. Olla fragments are also noted. In all specimens the base clay is dark and coarse, surfaces pebbly, and the designs are in black glaze paint. While the designs do not exactly duplicate those found on the Jeddito yellow ware, they show points of similarity.

PINEDALE RUIN

Pinedale ruin is situated in Navajo County, Arizona, about half a mile southeast of Pinedale, and 16 miles west of Showlow ruin. Less than a mile to the east of the pueblo is Morterson Wash, a tributary of Silver Creek.

The ruin consists of two units. The first is a large rectangular area surrounded by single tiers of one-story rooms. The second is a structure of compact form, the rooms of which are grouped about a central rectangular plaza (see fig. 11 and pl. 14, fig. 1). The east, west, and south sides bear proof of having been two stories in height, terraced away from the court, while the north end of the plaza appears to have been open or partly closed by single-storied rooms. Extending eastward for approximately 100 feet from the northeast corner of the main pueblo is an additional wing of rooms several tiers in breadth. It was in the large compact unit that the search for charcoal was continued after work had stopped at Showlow.



1. The extreme north end of the Showlow ruin, looking west. Beam HH-30 was found at the point where the man with the straw hat is at work.



2. Showlow. Room 2 of test 11, built between A. D. 1378 and 1382.



1. Showlow. Charred roof timber (below bowl) in test 11, room 2, which dated A. D. 1378. The bowl was on the roof when the fire occurred.



2. Showlow. A second timber in test 11, room 2, which also gave A. D. 1378 as the terminal date.



1. Showlow. Basal part of an old wall showing the use of large blocks surmounted by small stones in poorly constructed horizontal courses.



2. Showlow. Exceptionally good section of lower-level wall uncovered in test 12, composed of alternating layers of large blocks and small spalls.



1. Showlow. The diggings at the right are tests 1, 2, 3, and 12 where the excavated rooms were found superimposed upon older structures.



2. Showlow. Room 1 of test 2 showing the firebox near the center of the room.



1. Showlow. Room 1 of test 2 showing a second firebox in a lower floor.



2. Showlow. Complete excavation revealed the latest firebox imposed upon a wall foundation of the older structure.

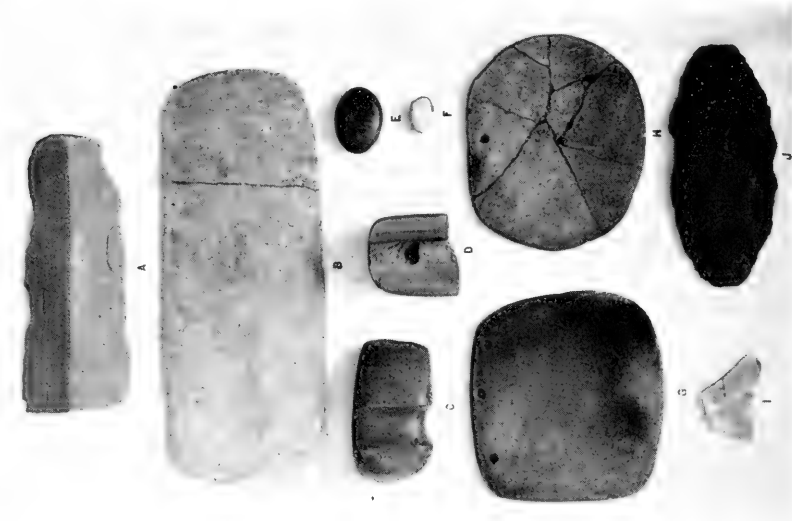

1. Stone implements from Showlow ruin.

a, Mano, 8" long; *b*, mano, 12½" long; *c*, stone axe;
d, stone polisher; *e*, *f*, polishing pebbles; *g*, *h*, sandstone
 objects, use unknown; *i*, chert knife; *j*, lava implement,
 7¾" long.



2. Showlow. A sandstone kneading board found
 among a potter's accessories.

(Length, 33 inches; width, 17 inches.)

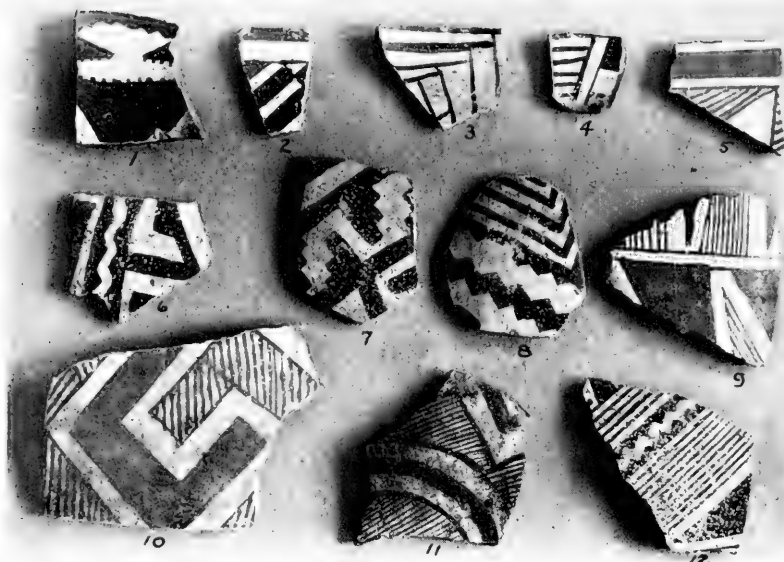

1. Lower level black-on-white sherds, Showlow ruin.



2. Black-on-white canteen and fragmentary bowl recovered from a lower level firebox, Showlow ruin. (Diameter of canteen 6 inches.)

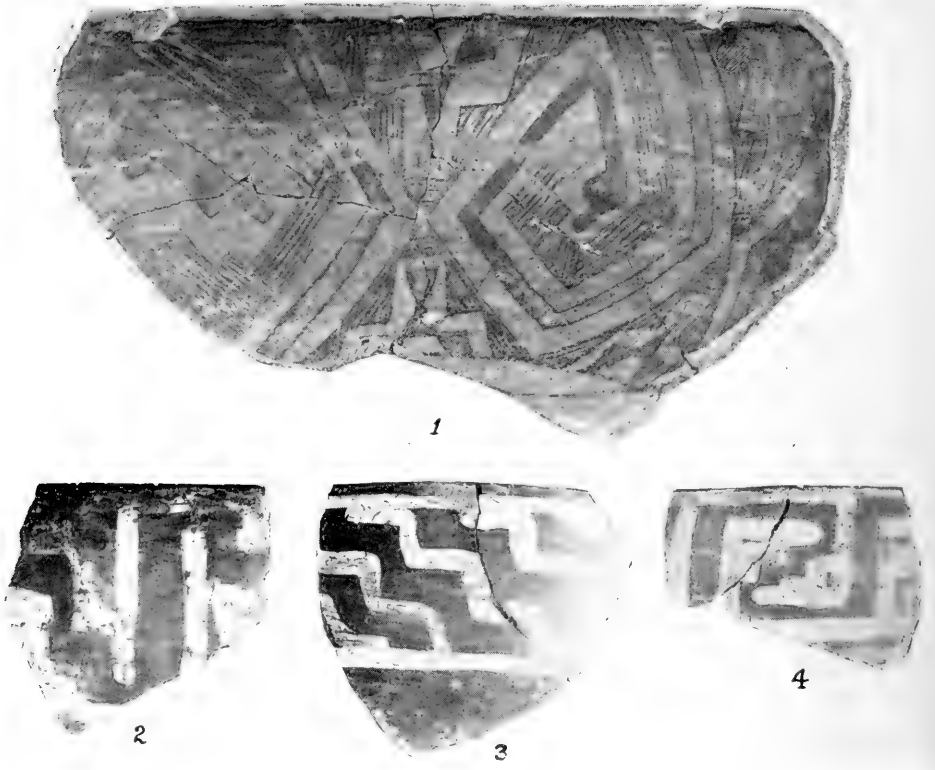

Interior (1) and exterior (2, 3, 4) patterns of decorated orange-red ware, commonly known as Little Colorado polychrome, Showlow ruin.

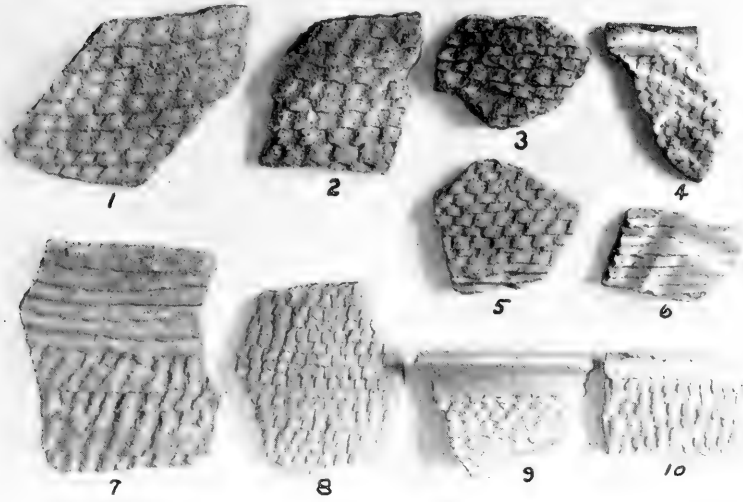

1. Lower-level corrugated ware, Showlow ruin.

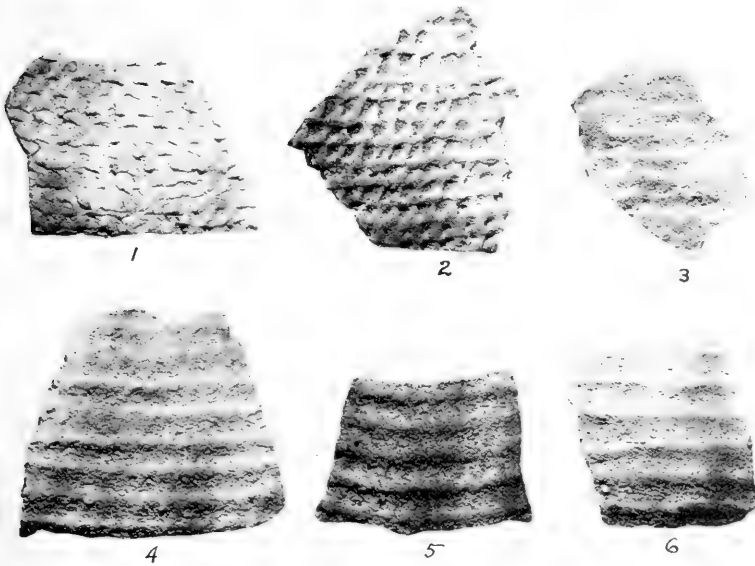

2. Upper-level corrugated ware, Showlow ruin.



1. Showlow. Tempering material consisting of pulverized sherds, quartz grains, and a small proportion of crushed basalt found in the paste of Four-mile polychrome pottery. (Enlarged four times.)



2. Showlow. An unfired sherd of Four-mile polychrome pottery showing an inclusion (circled) of a fragment of a fired vessel. (Enlarged four times.)



a



b



c



d

Four-mile polychrome ollas dating about A. D. 1375 from Showlow ruin.

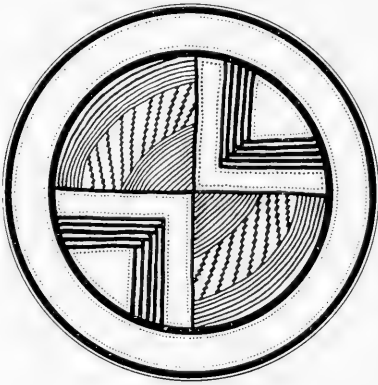

a

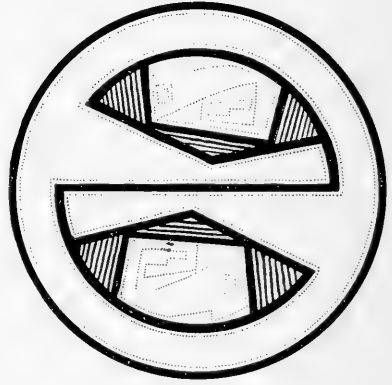

b

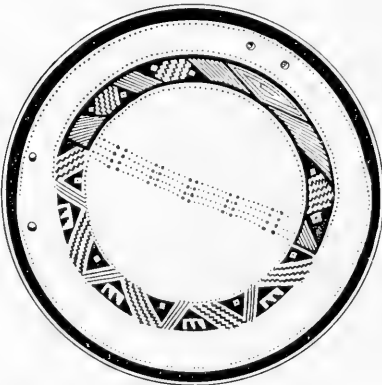

c

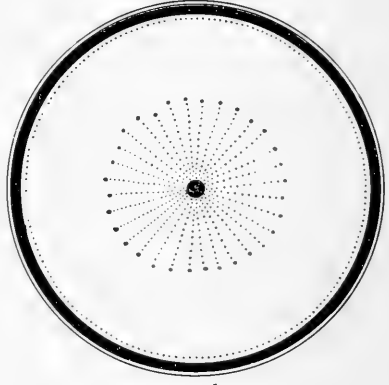

d

Designs on Four-mile polychrome bowls from Showlow ruin.

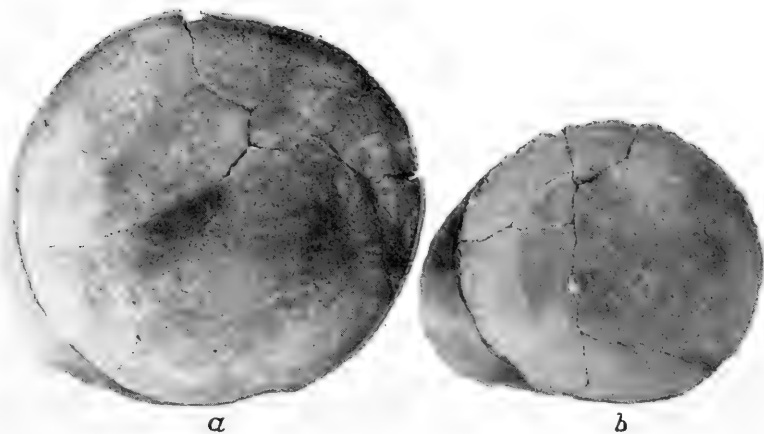

1. Parching plates (?) from Showlow ruin. (Diameter of *a*, 7½ inches.)



2. Fragmentary bowl of Hawikuh type E (*a*) and imitation bowl of old Hopi black-on-yellow (*b*), upper-level, Showlow ruin.

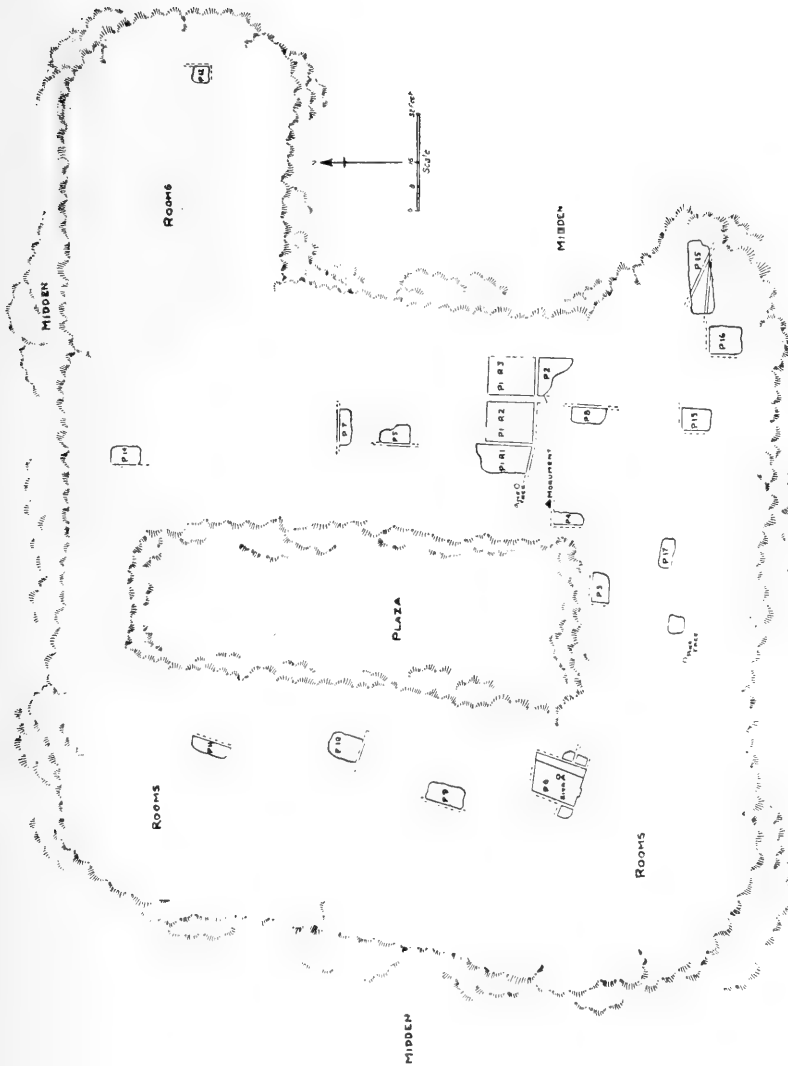

FIG. II.—Plot of Pinedale ruin showing Beam Expedition excavations.

Before the present operations were started the surface was found to be pitted here and there by the work of previous excavators and pot-hunters, and by shallow trenches where rocks had been removed for building purposes. Residents of Pinedale informed us that as late as 1887 sections of walls were still standing to a height of from 3 to 4 feet above ground. These as well as parts of some walls not exposed were subsequently removed by the early settlers for building stones. Rubbish heaps are located on the east and west sides of the main unit, and lesser deposits of débris are to be found along the north side of the east wing. Fewkes¹ worked the east midden extensively for burials in 1901.

Our search for charcoal in the Pinedale ruin showed the existence of a different condition from that noted at Showlow. Out of a total of 21 rooms opened, only four produced charcoal or otherwise indicated that they had been destroyed by fire. From all appearances, the pueblo was evacuated voluntarily some years before the Showlow ruin as we will endeavor presently to show. These burned rooms are no doubt the results of accidents; in only one instance did we observe what appears to be intentional firing.

For the initial test, a place was selected in the southeast section near the plaza. In an older excavation near this spot, charcoal was in evidence. This test, designated in figure 11 as P1 (P is equivalent to the symbol T of the Showlow workings), was eventually extended into three adjoining rooms, two of which were burned. The east half of room 1 was excavated and the remainder was left undisturbed because of the presence of a growing pine tree. Small charred beams showing short ring records were recovered from this room. Room 2 proved to be of interest because of its use as a depository for rubbish both before and after its burning. Several good beam sections, EH-56 (see pl. 15, fig. 1, for photograph of this beam *in situ*) and EH-62 were recovered whose outer rings dated 1286 and 1273 respectively. Room 3 was unproductive of charcoal, hence only partially excavated.

Tests 3, 4, and 5 all showed an unburned condition. Test 6 developed into a kiva which to our good fortune was burned. All charcoal was either directly on the slab floor or on the platform along the east wall, indicating that its destruction probably took place while it was in use. Here two good beam sections were encountered, as well as numerous small fragments. Specimen EH-68 is a section of a pine plank about 18 inches long, 10 inches wide, and 2¼ inches thick. It rested on the platform about midway between the east and west wall (pl. 15, fig. 2) and may originally have been a part of the frame of

¹ Fewkes, J. W., 1904, pp. 164-167.

the hatchway. The specimen does not give a true cutting date, but the last ring, obviously near the outside, reads 1131. The second charred beam, EH-69, was found in the south end of the kiva, partly overlying the platform. It consisted of a short section of a timber about 7 inches in diameter, but unfortunately was charred only externally and was badly decayed on the interior. Its outermost ring gave the year 1207.

Test pits 7 to 19, inclusive, all failed to produce charcoal.

ARCHITECTURAL FEATURES

The walls in Pinedale pueblo were, on the average, far better than those described from Showlow. In spite of the fact that much of the structure had been two stories high, the walls are seldom more than a foot thick. An exceptionally good section of wall exposed in P-16 may be seen in plate 14, figure 2. This wall, uncovered to a depth of 7 feet, was uniform throughout and chinked with small thin spalls. The larger stones average 4 inches in thickness and are carefully dressed both on the exposed surface and on the ends. Unusually large slabs were employed, the second one below the whisk broom (pl. 14, fig. 2) measuring 4 feet in length. Others of 3-foot lengths were not uncommon.

Room 2, in the first test, was the largest excavated. Its dimensions are 15 feet north and south by 13 feet east and west. The floor level was found over 10 feet below the surface, which is ample evidence of the existence of a two-story structure on that spot. That weaknesses of construction occasionally developed is noted in the east wall. Its lowest 5 feet are made up of large blocks of sandstone placed in position without any effort at coursing. Above these, smaller blocks are put down in courses and chinked with small spalls wherever the irregularities demanded. The weight of the superimposed story apparently caused this wall to buckle inwardly (pl. 16, fig. 1). Occupants of the room, in an attempt to strengthen the wall, blocked the doorway which leads into the room beyond. This had little effect and eventually the threatening wall caused abandonment of the room. Subsequently it was used as a dumping place for trash which consisted of broken pottery, ash, discarded implements, etc.

The doorway, unlike the usual pre-Spanish Pueblo door, is at the floor level. Its dimensions are 22 by 28 inches. Near the center of the room was a fire-pit, oval in shape, dug into the clay floor.

KIVA

Unquestionably the most interesting architectural feature uncovered at Pinedale is a rectangular kiva, one of the few known of that form

south of the Santa Fe railroad. The kiva site was marked by a surface depression at the southwest corner of the plaza. A test pit revealed a flagstone floor at a depth of 5 feet; above this, burnt soil and charcoal encouraged our hope that we might find here suitable timbers from which the room could be dated. This hope was subsequently realized; from several fragmentary timbers and numerous small pieces of charcoal, Doctor Douglass has been able to determine the approximate construction date of this ceremonial chamber.

The kiva was not perfectly rectangular nor was it accurately oriented as to the cardinal points. The long axis of the chamber had an approximate bearing 20 degrees east of north. The inner dimensions are as follows: ¹ north wall, 13 feet 3 inches; south wall, 13 feet 3 inches; east wall, 17 feet 3 inches; west wall, 15 feet 5 inches.

Masonry.—The kiva masonry was inferior to that in neighboring dwellings. Its building stones were generally unshaped although a great many carefully dressed blocks, apparently fallen from the adjacent two-storied rooms, were removed from the débris which filled the kiva. Adobe mortar was plentifully used, the walls were never more than a foot thick and horizontal coursing of building stones was practically absent.

The west wall, 6 feet from the northwest corner of the kiva (see fig. 12), curves slightly to the east and then back to the west again. At this same point is a distinct vertical separation in the masonry which we interpret as the place of juncture of two walls of a former room. This suggests, as several other points did also, that the kiva was remodelled from previous living rooms.

The central part of the east wall had collapsed. We rebuilt this portion in 1929 in a manner readily distinguishable from the original masonry.

In the west half of the south wall is a shallow offset (pl. 16, fig. 2; text fig. 12, *a*) 1 foot 10 inches wide and 4 inches deep. Its significance is not known to us.

Plaster.—Originally the inner walls of the kiva and the face of the platform were covered with adobe plaster. Small patches still adhering to the walls showed upwards of 11 coats or separate applications with a total thickness of $\frac{3}{4}$ inch. There was considerable variation in the color of the several plaster layers; some were excessively smoke-blackened while others were less so, probably denoting long or short elapses of time between renewals of plaster.

¹In treating of the descriptive material of the kiva, the sides will be referred to as being either north, south, east or west, although these were not exactly oriented to those points.

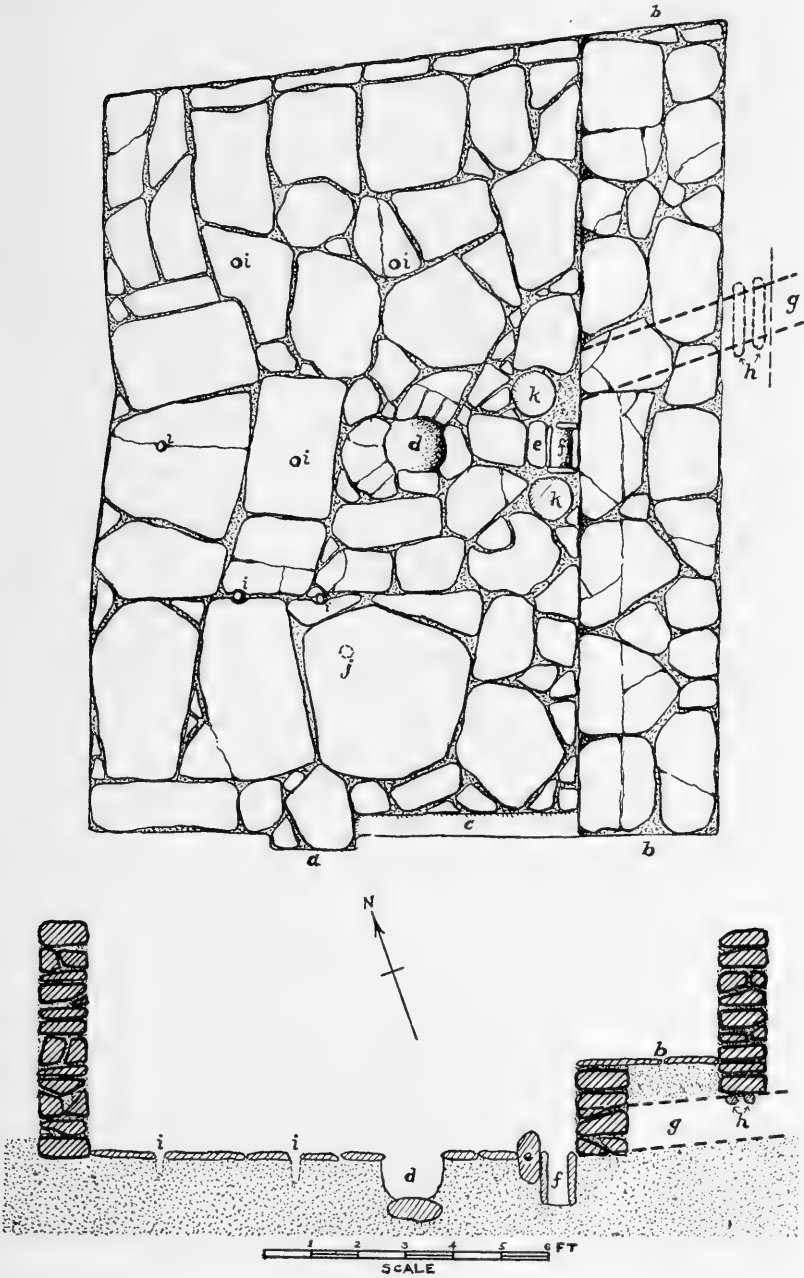

FIG. 12.—Plan and section of Pinedale kiva.

Platform.—This feature, which is typical of the rectangular kivas of the Little Colorado drainage, extends the full length of the east wall (fig. 12, *b*); the normal old Hopi kiva, however, is benched at the south or southeast end across the shortest dimension of the room. Its maximum width is 3 feet; its height at the south end is 2 feet 2 inches, but at the north only 1 foot 10 inches. The front of the platform, made of the same nondescript masonry as that found elsewhere in the chamber, supported a fill of loose earth at the north end and, at the south end, of clean coarse sand. This filled space was then capped with thin sandstone slabs to form the bench floor.

Referring to plate 17, figure 1, it will be noted that the capping slabs at the south end of the platform had collapsed under the weight of the débris forced upon them. This may denote the existence of a hollow space there at the time of destruction and also suggests that the sand may have been contained there for a definite purpose. What that may have been we do not positively know, but judging from modern practices, the sand could well have been used in forming the ground work of sand paintings constructed during ceremonial observances. The platform would make a convenient storage place for that material and could be easily reached by removing the slab covering. Hargrave's¹ finding of two large sand-filled ollas buried under the floor in a kiva at Kokopnyama probably signified a similar custom.

Bench.—The kiva is without a true bench or banquette. The merest suggestion of one exists along the south wall (pl. 16, fig. 2; text fig. 12, *c*) from the east side of the offset to the platform. It measured 7 inches in width and 2 feet 4 inches in height.

Floor.—The floor is completely paved with sandstone slabs from 1 to 2 inches in thickness. These vary in size from slabs 3 and 4 feet in length to small pieces which were fitted into corners and crevices. The larger flagstones were carefully placed, leaving only small cracks which were later filled with clay.

Fire-pit.—Two feet 9 inches from the platform and midway between the north and south walls is the fire-pit (fig. 12, *d*), a circular opening in the floor, 16 inches in diameter and 11 inches in depth. The bottom of the pit was formed by the convex surface of a large water-worn boulder. Wood ashes completely filled the fireplace.

Deflector.—No true deflector or fire screen, such as those usually associated with early Pueblo kivas, was found in the Pinedale chamber. Less than 2 feet east of the fire-pit, however, a stone 10 inches wide by 4 inches thick protruded 6 inches above the flagstones (fig. 12, *e*). Inasmuch as this stone was not directly in line

¹ See page 112, hereinafter.

with the fire-place and the ventilator opening, and also because of its low height, its function as a deflector must be regarded as doubtful.

Ventilator.—The ventilator shaft connects with the room through an opening in the front of the platform. This opening, a foot square at the floor level, is located 7 feet from the northeast corner (fig. 12, *g*; pl. 17, fig. 2). Leaning against the platform immediately north of the vent was a squared slab which fitted the opening. The duct passes under the platform at an angle; it is stone-lined and its floor rises slightly to pass under the east wall of the chamber. While two wooden beams (fig. 12, *h*) supported the wall at this point, there was no indication that the platform slabs above the passage had been similarly supported. As already mentioned, the east wall at about this point had fallen away, making it impossible to determine whether or not the shaft continued vertically to the surface.

Sub-floor depository.—Situated between the problematical deflector and the platform is a rectangular hole (fig. 12, *f*) measuring 10 by 6 inches by 13 inches in depth. The sides are formed of rock slabs which protrude slightly above the floor. This pit was filled with black earth.

Floor perforations.—Six holes pecked through the floor flags (fig. 12, *i*) may next be mentioned. When the first one was discovered, west of the fire-pit and in alignment with the usual kiva features, it was considered to be the sipapu. Later, however, five other similar openings were exposed, leaving some doubt as to the presence of a true sipapu. The first opening west of the fire-pit is 1 foot 10 inches away and the second a foot from the west wall. Both are 1½ inches in diameter. The two pairs to the north and the south are about equidistant from the center of the kiva but not equally spaced. Although not in alignment, as in Hopi kivas, it is not improbable that these holes once served as loom anchors. A seventh opening, plugged with a chipped stone (fig. 12, *j*), was found in the southern part of the room. The depth of these holes could not be determined.

The presence of two rounded stones in the floor (fig. 12, *k*), one on either side of the deflector, must also be recorded. They are somewhat thicker than the average floor flags and of a different material. Their significance, if any, is not known.

Roof.—The positions of a few sizable timbers lying across the kiva platform, indicate that the principal roof supports spanned the chamber across the short dimension, as would be expected. Further details could not be learned although numerous sections of branches a few inches in diameter were presumably fragments of cross pieces.

Relation to living rooms.—Exploratory tests into contiguous rooms, two to the east and one to the west, revealed the fact that the kiva

floor was only 4 inches lower than those of adjoining rooms. Thus the structure was not subterranean as is usually the case. The guiding depression in reality was due to the greater amount of accumulated débris from two-story structures to the north and south of the kiva. A single-storied room separated the kiva from the plaza. The bulge and separation in the west wall which has already been mentioned, the fact that the floors of the adjacent living rooms and that of the kiva were almost on the same level, and the proximity of the latter to the domiciles, lead to the inference that the kiva was incorporated into that part of the village by remodeling existing living rooms. Corroborative evidence of this is derived from the dates of charcoal. A series of pieces which cover a period of time between 1132 and 1231 are probably parts of beams that were originally in the rooms and subsequently re-used in the kiva. The latest dates ranging between 1293 and 1330 probably cover the actual construction time.

Thus, by the aid of datable charcoal, we know that this rectangular kiva was in use soon after 1300. It is too early yet to say when the transition from the round to the rectangular form took place. We gain a comparative idea from the two circular pre-Hawikuh kivas excavated by Hodge. Associated with these he found black-on-white, black-on-red often with white exterior patterns, and finely corrugated pottery.¹ These types correspond with those found in the lower stratum at Showlow, for which we gave a tentative minimum date of 1204. Hence, in ruins which were occupied between about A. D. 1200 and 1300, we might expect to find the transitional forms.

In its general features the Pinedale kiva has points in common with those uncovered by Hargrave² at Kokopnyama. The most outstanding difference is in the position of the platform. In the old Hopi kivas, built before the coming of the Spaniard, this feature usually occurs on the southerly side and across the shortest dimension of the chamber, whereas in the Pinedale kiva the platform is along the longest side to the east. The Pinedale kiva does not show the jogs at the platform end which Hargrave believes to be a characteristic feature of Hopi kivas. The rectangular kiva in Hawikuh which was abandoned and filled after the arrival of the Spaniards and later uncovered by Hodge³ also has the platform and the air duct on the south side.

Artifacts.—Comparatively few artifacts were recovered from the kiva. Two loom blocks (pl. 18, fig. 1) found on the platform at the

¹ Hodge, F. W., 1923, p. 28.

² See pages 103-116, hereinafter.

³ Hodge, F. W., 1922, pp. 9-10.

south end are considered in the description of stone objects. The occurrence of loom blocks in kivas is quite in keeping with modern Hopi practices.

No complete pieces of pottery were recovered. Fragments of several black-on-white ollas and one black-on-red olla are in the sherd collections. The black paint in all cases is a thin glaze. As the sherds from the kiva are wholly typical of those recovered from the other diggings in the ruin, we may omit the consideration of pottery at this point.

OBJECTS OF STONE

The stone implements recovered at Pinedale largely duplicate those found at Showlow. Certain objects, however, are worthy of special notice.

Metates and manos.—Concerning these, the description given of Showlow milling stones will also apply, although the correlation of the two types was less distinct. This is due in part to the limited number of rooms excavated completely and possibly to the fact that Pinedale ruin was abandoned a half century or more earlier than the Showlow pueblo, before the second type of grinders came into general use.

Mortar.—A mortar made of a shaped block of rhyolite was found in the refuse-filled room of test 1. The grinding cavity was approximately 6 inches deep and the same distance in diameter at the top.

Stone axes.—In the same room were found six or eight stone axes on which the cutting edge had been completely battered away or broken off. There were also present in the refuse several sandstone building blocks which bore grooves, transverse to the long sides. On one block the grooves were cut directly opposite each other on the two sides, obviously to facilitate the breaking of the stone at those points. The character of the grooves suggests that they were cut with stone axes, and if so, the presence of so many battered implements can be accounted for. All axes recovered, both broken and complete, are of the short-bitted, three-quarter groove type.

Stone hammer.—Only one stone hammer is contained in the collection. It is made of diorite and is $3\frac{3}{4}$ inches long. Unlike the stone axes, the hafting groove entirely surrounds the implement.

Loom blocks.—On the south end of the kiva platform were found the pair of loom weights pictured in plate 18, figure 1. Both are made of coarse-grained sandstone, the bases are flat, and the holes which engaged the loom stick are near the top of the blocks and less than an inch deep. The one block shows a long groove, evidently where weaving tools were sharpened.

Chipped implements.—A representative collection is shown in figure 13, *a* to *m*. Specimens *a* and *b* are chert knives which have been struck from a core much in the same manner as were the famous Aztec knives of obsidian. The triangular tool *c* is also of chert, $2\frac{1}{2}$ inches long, and was probably used as a knife or scraper. Objects *d*, *f*, and *g* are drills, the first one being of especial interest because of the bevelling on opposite sides of the point (see cross section *e*). The entering edge was thus made sharper than it would have been otherwise. Arrow points are of two types, plain (fig. 13, *h*, *i*, *j*) and tanged (*k*, *l*, *m*). The plain points usually have slight concave bases and are either short or long and slender, the latter being like the points commonly found in the Middle Gila. The bases of the tanged points are flat or nearly so.

Stone pipe.—The pipe represented in figure 13, *n* and *o*, is made of a very even-grained slate-like rock. It is $1\frac{3}{16}$ inches long and 1 inch in maximum diameter. All outer surfaces are highly polished. The bowl is formed by a conical drilling $\frac{3}{4}$ inch in diameter at the top which converges into a $\frac{3}{8}$ -inch boring at about the middle. The boring then extends from the juncture with the bowl proper to the base of the object. Just above the base on the outside a large chip was knocked off sometime during its use, for the broken surface shows much wear. A small hole perforates the side wall at this point which looks as though it had been made intentionally because of the small cup-shaped depression about the hole. As to its significance we cannot be sure. The small depression may have received the end of a stem fastened into place by means of pitch or some other substance. True elbow pipes, however, are the exception from southwestern ruins so that the trait in question may have served another purpose or the object may even have been discarded after the break occurred and put to some secondary use.

Pendant.—Figure 13, *p*, illustrates a plummet-shaped pendant recovered in room 2, test 1. It is $2\frac{3}{4}$ inches long, made of slate, and perforated at one end for suspension. A single notch on each side of the perforation represents the only efforts at incised decoration.

Ring.—The small fragmentary stone ring shown in figure 13, *q*, was probably intended to be worn by a child. The material appears to be the same as that of the pipe figured here. The protuberance suggests a copy of shell rings made of the *Glycymeris*, from which the beak is usually not removed.

Miscellaneous objects.—Crystals of quartz (fig. 13, *r*) are not uncommon in the ruins of central and southern Arizona. One was

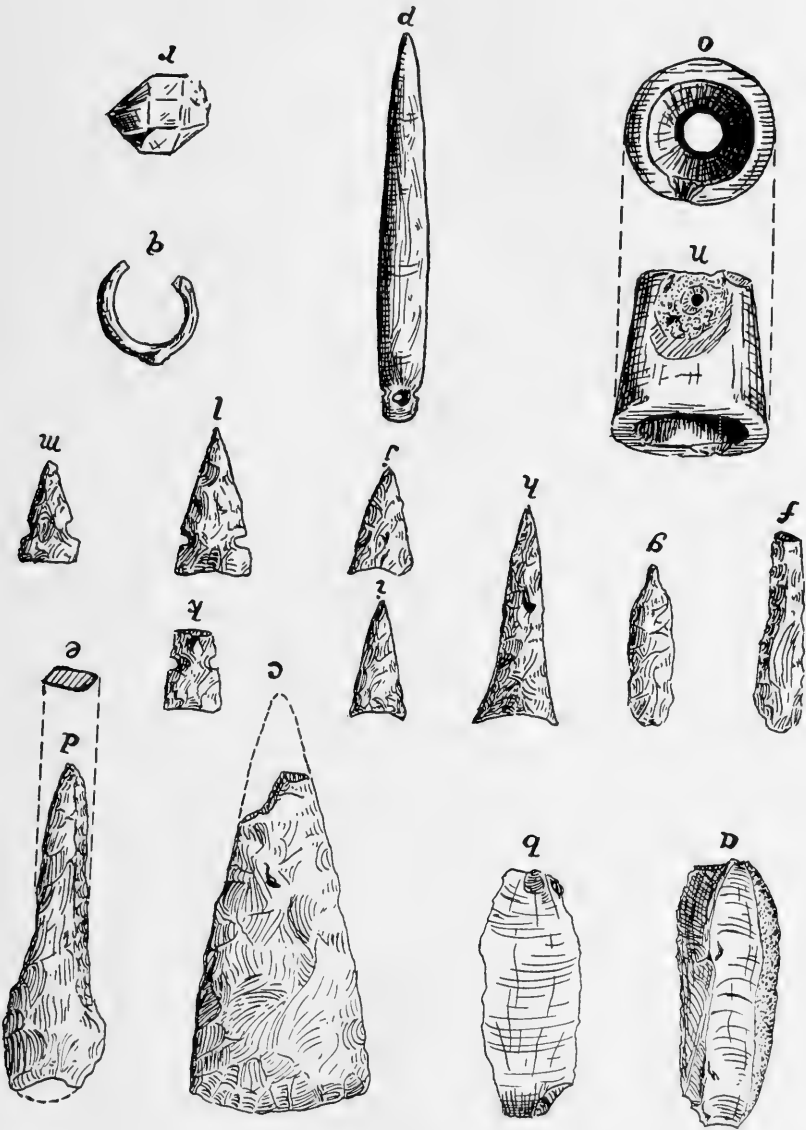

FIG. 13.—Stone objects from Pinedale ruin. (7/10 natural size.)

recovered at Pinedale. It was probably used as a fetish or formed a part of a medicine man's outfit. Crinoid stems and asbestos which were also found belong in the same class of articles.

Pigments.—Hematite is by far the most prevalent of pigment materials. It was found not only in its normal state, but also in micaceous and specular forms. Limonite, used in pottery making, kaolin, and copper carbonate were also found.

Painted stone slab.—Just above the floor of room 2, test 1, in rubbish which had been cast into the abandoned room were found the shattered parts of a painted stone slab. The restored object, pictured in figure 14, is made of a pinkish-colored sandstone. It measures 16 by 19 inches and is $\frac{3}{4}$ inch in thickness. The central portion of the stone has been neatly trimmed out to form a circular opening, 10 inches in diameter. Prior to its painting, one side of the slab was smoothed down to provide a better surface for the designs. A thick white kaolin wash was first applied, not only to the dressed surface but to the reverse side and the edges as well. The black and yellow pigments, both apparently of mineral origin, are evanescent. Nevertheless, in the best preserved parts, the paints are still vivid and full of life. Nowhere is the loss of figures so great as to cause doubt as to the continuity of design.

From the top of the slab extend a series of 11 black triangles, $1\frac{1}{2}$ inches high with apexes pointed downwards. Below these, traversing the full width of the slab, is a heavy black line made by two parallel strokes of the designer's brush. Still lower and just above the aperture is a yellow band 1 inch wide framed at both edges by narrow black lines. Underneath the upper framing line a dark red pigment shows up clearly, apparently a part of a previous design. To the right and left of the opening are free zig-zag patterns in yellow outlined in black except for the ends which are left open. The inner edge of the hole is finished with black pigment, now almost wholly obliterated. A single black line near the base completes the decoration.

As to its use, we believe it safe to say that the slab formed a part of an altar decoration or was otherwise used in religious rites. This inference is not wholly without foundation for painted slabs are still used by the Hopi Indians in the construction of the Antelope altar in the Snake Ceremonial.¹ Matilda Coxe Stevenson, in her treatise of Zuni mythology and ritual, records a ceremony² in which a wooden

¹ Fewkes, J. W., 1894, p. 43.

² Coming of Ko'loowisi (Plumed Serpent) and Involuntary initiation into the Ko'tikill. Twenty-third Ann. Rep., Bur. Amer. Ethnol., pp. 94-102, 1901-02.

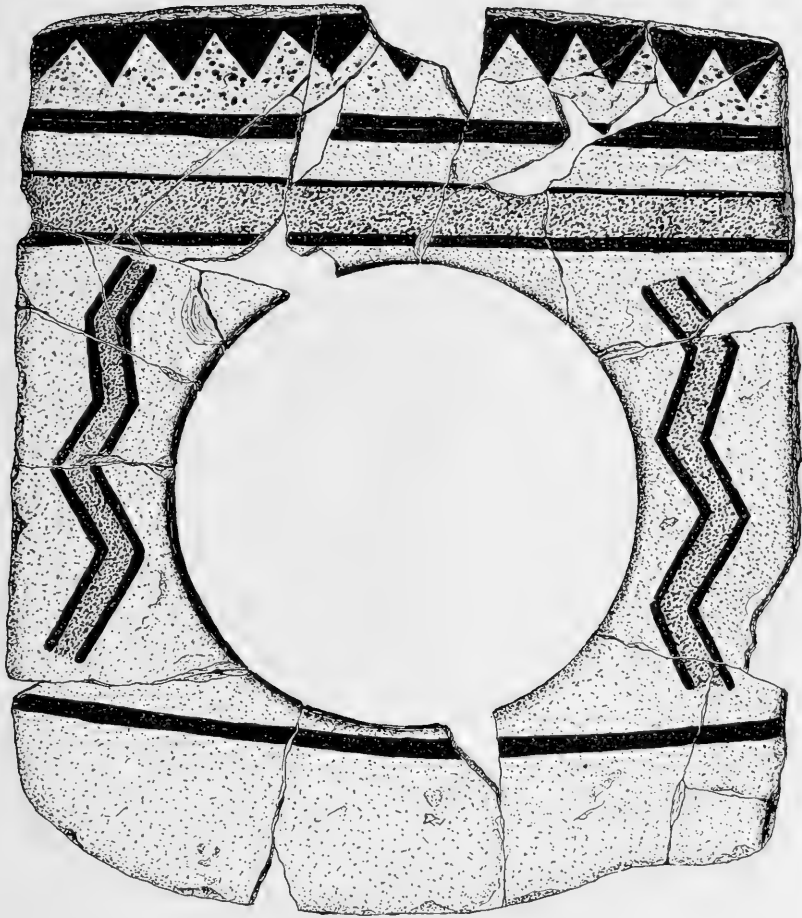

KEY TO COLORS:

	WHITE
	YELLOW
	BLACK

FIG. 14.—Painted altar slab from Pinedale ruin. ($\frac{1}{4}$ actual size.)

tablet bearing a large opening plays an important part (see fig. 15, introduced here for comparison). The tablet is ornamented with cloud terraces cut into the wood and outlined in color. In the center is a circular hole 9 or 10 inches in diameter through which the head of the fetish, Ko'loowisi (plumed serpent), is passed at specified times during the ceremony. The serpent effigy is about 8 inches in diameter. The tablet is either carried or used in a vertical stationary position.

It is not improbable that the stone slab found by us, is precursory to the wooden tablet in use today and that both are a manifestation of

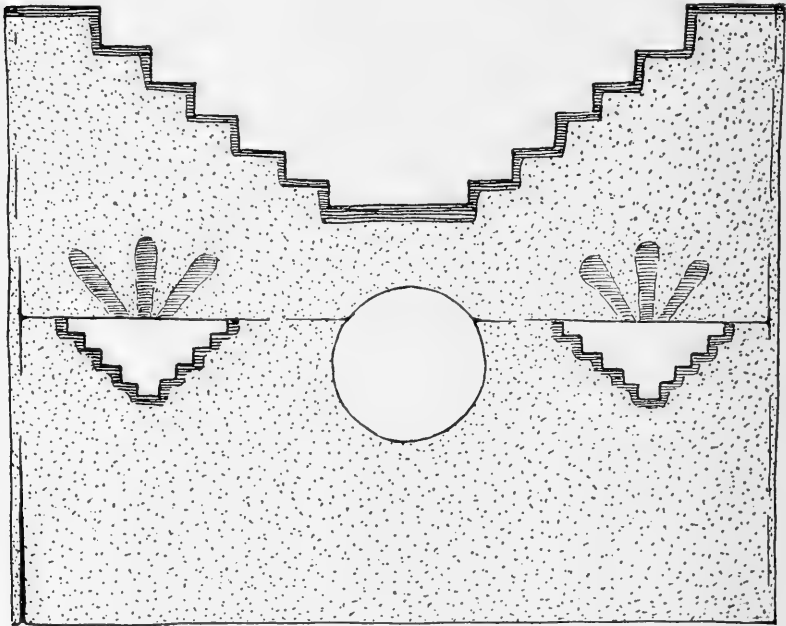

FIG. 15.—Wooden tablet used in a modern Zuñi ceremony. Introduced for comparison with figure 14. After pl. XIV, 23rd Ann. Rep., Bur. Amer. Ethnol., 1901-02.

a ceremony that has survived for 600 or more years. While the wooden tablet is the larger, the opening in both is almost identical in size. Applying the present Hopi interpretation of symbols, the black triangles on the ancient specimen are rain-clouds and the zig-zag patterns are symbolical of lightning. The modern tablet, however, does not have the latter symbols and the rain-cloud symbols are in forms of terraces, which is the common method of representation today. The change from stone to wood in the material of the slab would naturally be accompanied by certain modifying features, such as the increase in size and the cutout terraces of the present-day piece.

It will be noted that the base of the Pinedale slab is irregular and less carefully finished than the other three edges. It has been suggested that this unfinished side was imbedded in the ground to the depth of the black line during its use. This would hold the object in a vertical position so that a fetish such as the plumed serpent could be drawn back and forth through the opening with facility as in the recorded ceremony.

Relatively few painted slabs of this nature have been recovered, and those nearly all from the ruins in the Silver Creek drainage or its environs. Fewkes found an excellent specimen of rectangular form in a grave at the Cheylon ruin,¹ and Mr. Whipple at Showlow uncovered three or four well-made slabs in living rooms in his ruin. These are squared at the base and rounded at the upper end. Fewkes also notes the presence of one in a grave at Sikyatki,² which is, as far as we know, their northernmost occurrence. None other, however, has been recorded with the large opening.

A section of a charred timber found near the Pinedale tablet gave an unmistakable cutting date of A. D. 1286, which, with other specimens of comparable age from the same room, yields the approximate building date of the room. Consequently, the slab was discarded at a somewhat later time.

OBJECTS OF BONE

Awls.—Representative specimens are shown in figure 16, *a*, *b*, *c*. The first one is fashioned from the proximal end of an ulna, probably of the antelope, and *c* is a similar bone from some other animal.

Bodkins (?).—In his work at Chavez Pass ruin, Fewkes³ recovered 13 bone implements which he termed bodkins. One complete and one fragmentary specimen were found by us (fig. 16, *d* and *e*) at Pinedale. These and one figured from Chavez Pass by Fewkes display such similar characteristics that they must represent a type. They seem always to be made of about 6-inch sections of the metatarsal bones of the deer or antelope, including the joint. The maximum diameter of *c* is $\frac{5}{8}$ inch. The hollow of the bone is exposed for 2 inches below the blunt point and from there to the distal end the implement is highly polished. The articular faces of the joint were removed in order to maintain a more uniform diameter. Hodge⁴ pictures one from

¹ Fewkes, J. W., 1904, pp. 104-5, pl. XLVI.

² *Ibid.*, p. 162.

³ *Ibid.*, p. 94.

⁴ Hodge, F. W., 1920, pl. XX, a.

Hawikuh on which this modification was not made, although it is identical in every other respect.

The natural furrow on the reverse side of the complete specimen figured here, terminates in a foramen which passes through to the base of the bifurcation of the condyle. It is apparent that the cleft served a definite function. If used as a bodkin, the thread could either be inserted through the foraminal passage from the base and then knotted, or it could be brought back down and tied to the trailing end of the thread. In the latter case, the knot formed would slip

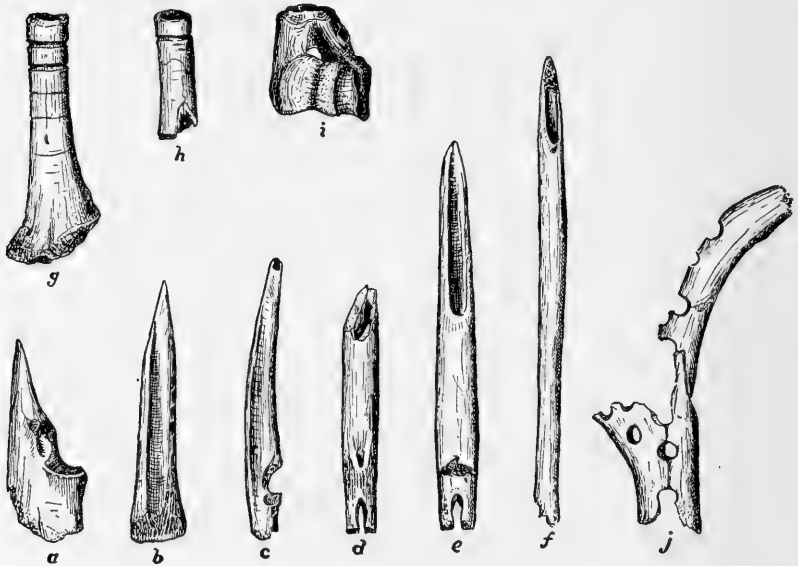

FIG. 16.—Pinedale bone implements. ($\frac{1}{8}$ actual size.)

conveniently into the cleft, thus eliminating the possibilities of its catching in other threads during operation.

Problematical tool.—The bone object in figure 16, *f*, is made of a tubular bone 7 inches long and $\frac{1}{2}$ inch in diameter. The pointed end is too soft and spongy to have been used as an awl or a punch.

Incised bones.—Specimens *g*, *h*, and *i* (fig. 16) are further examples of bones showing the cutting process. The first two were apparently segmented in the manufacture of beads but the last disjointsments were not made. Example *i* is the discarded articular end of a leg bone.

Perforated antler.—A curious fragmentary piece for which we can suggest no utilitarian use is shown in figure 16, *j*. It is made of a forked section of a deer antler $5\frac{1}{2}$ inches long split longitudinally. The

more porous structural material on the inner side was removed, leaving the object a mere shell $\frac{1}{8}$ inch thick. The edges are trimmed down and smoothed well to the inner side of the antler. The shell bears evidence of 11 perforations which vary from $\frac{1}{4}$ to $\frac{3}{8}$ inch in diameter and which are placed at more or less regular intervals lengthwise along the object.

OBJECTS OF SHELL

Ornaments of sea shells were apparently not plentiful in pueblos of the Little Colorado drainage occupied in immediate pre-Spanish times, for the collection from Pinedale is sparse indeed. The genera represented are: *Glycymeris*, *Olivella*, *Comus*, and *Turritella*.

POTTERY

The few complete vessels and the great quantity of sherds recovered from the Pinedale ruin provide much needed data concerning certain aspects of the Silver Creek drainage pottery complex. It will be recalled that at Showlow, two levels of occupation existed and that the pottery types from the levels differed. The great mass of the Pinedale material is not analogous to the pottery of either of the Showlow levels, but nevertheless small proportions show unmistakable affinity with both. Hence, it is inferred that the period of greatest productivity at Pinedale was intermediate in relation to the two stages found in the former ruin. This relation was strongly suggested by a cursory test in the refuse heap where the supposedly later types were found to overlay the decorated orange-red phase of pottery recognized in the lower level at Showlow. Corroborative evidence was subsequently obtained from datable charcoal with which the dominant Pinedale types were associated. This association was provided by the refuse-filled room of test 1 and the kiva, both of which contained an abundance of sherds and ample charcoal. No doubt exists, therefore, as to the exact position of the Pinedale pottery in the sequence of development supplied by the two ruins.

As has already been mentioned, the most recent date from room 2, test 1, is 1286, and from the kiva about 1330, although the largest timbers of the latter gave earlier dates. Generally speaking, the construction period of these two chambers was nearly 100 years earlier than the last building period at Showlow. This would also place a corresponding difference of time on the pottery. To the lower level at Showlow we have tentatively given 1204 as the most recent date,

pending further examination of charcoal specimens. This, then, would signify an interval of fully 75 years between the earliest Showlow level and the major Pinedale occupation, and a difference of more than 75 years between the latter and the final Showlow occupation. Or, applied to pottery, which would be post-datum in all cases, the early Showlow wares would be 1204 (?), Pinedale about 1290, and late Showlow, 1375. Thus pottery types are not only assigned to their respective positions in the chronology but we also obtain a relative idea as to the amount of time elapsed during which wares acquired new traits or even nearly lost their original identity.

The Pinedale pottery which is treated in the following paragraphs was dominant in the late 13th and early 14th centuries. It can be broadly classified into the following types: black-on-white, black-on-red, black-and-white-on-red, plain, corrugated, and intrusive.

Black-on-white.—This type is apparently the result of a blending of the two black-on-white types observed at Showlow which evidenced both northern and southeastern contacts. In the Pinedale black-on-white, features of both older types were retained in modified form and new ones added producing quite a distinct pottery. In properly fired vessels, the paste is nearly white, otherwise it is darker in color. The tempering is almost pure pulverized sherds. In some cases there is a slight admixture of quartz grains and a few dark particles which may be basalt. The slip is thin, light gray in color, and the surfaces as a rule are well pebble-polished. The black paint is thin, either dull or a near glaze; when the latter, it is frequently translucent. Whether two pigments were used is doubtful, as in a number of pieces the dull paint may merge into the shiny, the difference being due apparently to the amount of paint present and the length of firing. Overfiring seems to have eliminated the incipient glaze qualities, as in extreme cases of overfiring the paint is a dull brown.

Ollas.—Judging by the abundance of sherds, black-on-white ollas were very common. The bodies are full and of greatest diameter horizontally; the orifices are small, seldom exceeding 5 inches in diameter. The neck is almost invariably vertical, in some cases rising at right angles from the body to a height of 1 to 2 inches. The lips are direct or slightly flared.

Decoration is applied in two zones, on the neck and on the major portion of the body. There seems to have been no fixed manner of decorating the necks. Sometimes the lip is painted black to which other elements are attached as in plate 19, figure 1, nos. 1, 2, and 3. Again the patterns may be banded horizontally, framed by narrow or

broad lines as nos. 4, 5, 6, 7, and 8, or they may be used as independent units as represented by no. 9. A similarity of vessel form and neck ornamentation will be noted between these ollas and the Four-mile polychrome ollas already described. Although black-on-white pottery was practically non-existent at the time the latter were made, the traits of likeness are probably survivals.

The body decoration consists of a single broad field beginning a few inches from the base of the neck and extending well down towards the bottom of the vessel. The field is emphasized by two heavy black lines which border it above and below. Set apart from these are narrow lines which form the actual framers of the patterns. In plate 19, figure 2, is given a representative collection of olla sherds. The designs are almost universally of contrasted heavy solid and hatched elements. The solid figures are either continuous triangles, terraced, or spiral elements (nos. 1 to 15). The latter, which always interlock with a hatched counterpart, it will be recalled, are typical of the Tularosa or Upper Gila black-on-white. Sometimes small fields are blocked off and treated as in nos. 16, 17, 18, and 19. The hatchwork is well drawn, much better than that of the black-on-white found in the lower stratum at Showlow. The framing and filling lines are of equal width and the latter are always straight. Sherds 20 and 21 show an unusually fine brush technique. The filling lines average 25 to the inch. Not infrequently the ends of the lines are so brought together as to give a herring-bone effect (nos. 22, 23, and 24). Perhaps most characteristic of the hatching is the change in direction of the fillers in almost every small unit (nos. 8, 9, and 25). Cross-hatching was found on one sherd only (no. 12).

Bowls.—Two types of black-on-white bowls are present. The one form is obviously related to the Showlow lower stratum black-on-white bowls and therefore older than the second type, which on stylistic evidence and nature of paint is judged to be contemporary with the ollas just described. They are comparatively rare, for their place was taken by the decorated redware bowls.

The bowls are small, very rarely more than 8 inches in diameter. The bottoms are rounded and the rims gently incurved. Both interiors and exteriors are polished and slipped. Ornamentation consists of all-over patterns on interiors, two of which are shown in figure 17, *a* and *b*, and independent elements on bowl exteriors (fig. 17, *c* to *h*). An unusual feature of the inner design in some vessels is its lack of a framing line at the rim. On several rim sherds, the lip is painted black in the manner of the Chaco bowls. As in the ollas the design

units are largely contrasted solid and hatched figures. The exterior patterns are either zoomorphic or geometric. The animal (fig. 17, *c*) and the combined birds, *d*, appeared on opposite sides of the bowl from which the pattern *a* was obtained. The tail feathers of the left bird of the combination represented in *c* joined the lip-line on one bowl and hung downward in the rakish angle shown. Figures *f*, *g*, and *h* are characteristic of the geometric units. A continuous decoration was noted in a single case only.



FIG. 17.—Black-on-white interior and exterior bowl decorations, Pinedale.

Black-on-red.—A true black-on-red was apparently little used although a polychrome on red was common. The sherds of the few black-on-red vessels at hand are probably the by-products of the early stages of the manufacture of polychrome ware. The paint is usually dull and the designs call to mind those found on the orange-red Little Colorado polychrome.

Black-and-white-on-red.—The polychrome on redware presents a considerable variety of features. Despite the variety, however, the

great amount of it has an unmistakable unity. On the basis of the chronological checks that have been provided by datable charcoal, this dominant form was in vogue before and after 1290. Those specimens that cannot be classed in the above group either approach the decorated redware at the lower end of the scale represented at Showlow, or they fall in the upper end of the sequence, also represented at Showlow. Since the predominating type of decorated redware at Pinedale is clearly a lineal descendent from the orange-red Little Colorado polychrome and adumbrates the development of Four-mile polychrome, we shall refer to it as a distinct sub-type, "Pinedale polychrome."

The base clay does not differ greatly in texture from that used in the black-on-white, although it usually burns darker. The tempering is almost pure ground sherds. In plate 20 a small amount of sherd tempering is shown (enlarged six times) just as it was washed from unfired clay. The largest fragment distinctly shows the scorings found in olla interiors. On other particles, bits of black-on-white designs may be seen, and the dark particles reveal either black paint or the red slip of former vessels. The fragments of the latter are rarely found in the paste of the black-on-white pottery. Quartz grains and other extraneous material occur in such negligible amounts that their presence is probably accidental.

The slip is fairly thin and varies in color from red to an orange-yellow, the former color being the more common.

The black paint on this pottery shows a gradation from a dull to a distinct glaze finish. The lack of a glaze technique in the lower Showlow level, which we have indicated as being older than the Pinedale horizon represented by this pottery, and the gradual shading into glaze decoration are strongly suggestive of the fact that paint compounding was passing through an experimental stage. This, however, does not imply local invention of glaze, as stimuli from a focus not yet determined could readily have affected ceramic decoration in Pinedale pueblo.

While the glaze generally resembles that of Four-mile polychrome, in the better examples it is more lustrous, often displaying greater relief, and usually freer of gritty particles. On firing, the glaze often ran, thus blurring the sharpness of the lines. These differences, however, because of the variability of the paint, can scarcely be used as determinants in distinguishing the types.

Quantitative determinations of the glaze materials by Mr. F. G. Hawley again show lead, copper, and some manganese to be present.

In a composite quantitative test, practically the same ratio of lead to copper obtained as was noted in the glaze of Four-mile polychrome. The greater copper content in both cases makes it quite evident that that element was added to the compound to produce the black color. The latter is usually opaque, the degree of opacity depending upon the thickness of the glaze. On some sherds, the glaze is brownish and translucent; and it may even have a purple cast which is possibly due to the manganese content. The occurrence of green glaze is noted rarely, in fact the few sherds which show it are considered to be indicative of Hawikuh relations where green glaze was prevalent.¹

In this connection we wish also to mention the occurrence of a dull brown paint on a few sherds. It appears to be much like that used on Jeddito yellow ware, although in the specimens under consideration it is present on normal Pinedale types.

The white paint is chalky, and as in Four-mile polychrome, it is much less tenacious than the black.

Ollas.—Ollas are represented by a few scant sherds which do not permit a full description. Their dearth can be explained by the abundance of black-on-white ollas. White is used sparingly, in fact in some cases it appears never to have been used, thus making a black-on-red product, although belonging technically in this group. Olla shapes agree with the standard black-on-white form.

Bowls.—These must have been very abundant for our collection has in it more than 150 rim sherds of individual vessels. The sizes vary from 7 to 10 inches in diameter, seldom larger. The bowls are conspicuously shallower than the preceding Little Colorado polychrome prototype. The rims are gently incurved and the lips are almost invariably rounded.

The variability of the decoration of bowls probably is the best expression of the transition through which this form was passing. To recount all the modifications would take us far afield for little gain, especially with rather limited data. It may be said, however, that the trend in design is distinctly approaching the results gained in the later Four-mile polychrome.

Interior patterns of four bowls are given in figure 18 with their corresponding exterior designs. In all but *d*, only black was used in the interior while white was brought into play on the outsides. Such is the case with approximately 90 per cent of the vessel fragments in the collection, while in the remaining 10 per cent white was employed in the capacity of outliners for the heavy black elements. In pattern *a*

¹ Hodge, F. W., 1923, p. 29.

a circular area in the bottom of the bowl is unpainted; in *b* the field is divided into quadrants, both designs have broad rim bands. In *c* the design area is tripartite and lacking the border at the rim. Two opposing quarters in *d* have a white background on which the black



FIG. 18.—Interior and exterior bowl decorations of Pinedale polychrome.

elements are superimposed. The use and non-use of rim bands is about equally divided.

Additional designs appearing on bowl exteriors are shown in figure 19. Figures of birds (*a*, *b*, and *c*) and dentate elements (*d*, *e*, and *f*) are characteristic. The latter are probably conventional adaptations of bird wings, for this is well illustrated by *g* where one such

figure occurs in combination with what appears to be a bird's beak as it is often drawn. The last three designs *j*, *k*, and *l* (fig. 19) are continuous and placed from $\frac{1}{2}$ to $\frac{3}{4}$ of an inch below the rim. Other continuous patterns as in figure 17, *b*, begin to take on the appearance of the exterior decoration of Four-mile polychrome (see fig. 8).

Plain ware.—The utter lack of plain cooking vessels is one of the surprising features of the Pinedale pottery. Decoration was lavished on practically every vessel made except the corrugated. The only other unpainted vessels in the collection are the shallow platelike objects pictured in plate 18, figure 2, which we believe were used as bases in

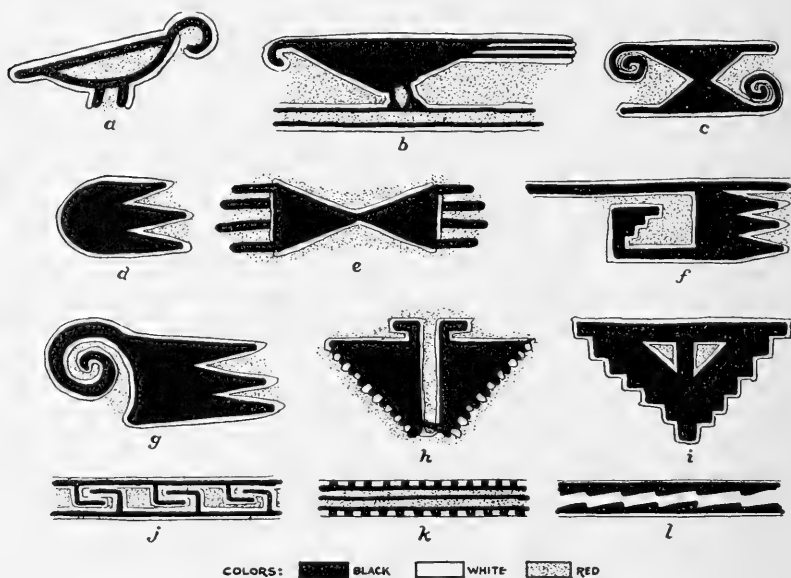

FIG. 19.—Exterior designs of Pinedale polychrome bowls.

the process of manufacturing pottery. To the depressed surface of the smaller plate, a small quantity of tempered clay is still adhering. Both vessels are unslipped but highly polished on the inner surface. The exteriors are rough, but show no corrugations. The larger specimen 1 is $16\frac{1}{2}$ inches in diameter and 4 inches deep while 2 is $11\frac{3}{4}$ inches in diameter and $1\frac{1}{2}$ inches deep. About the periphery of the latter are two rows of perforations $\frac{1}{2}$ inch apart. The holes were made from the inside outward before the surface was polished, for the latter process nearly closed some of the perforations. Similar objects have been recovered in Marsh Pass¹ and in the old Hopi ruins. As to the significance of the marginal perforations, there

¹Kidder, A. V., and Guernsey, S. J., 1919, p. 143; also by Doctor Cummings.



1. The Pinedale ruin from the north. The central depression is the plaza.



2. A typical section of Pinedale masonry. The second slab below the whisk broom is 4 feet long.



1. Pinedale, Dr. A. E. Douglass pointing out beam EH-56 *in situ* which dated A. D. 1286, found in P1-R2.

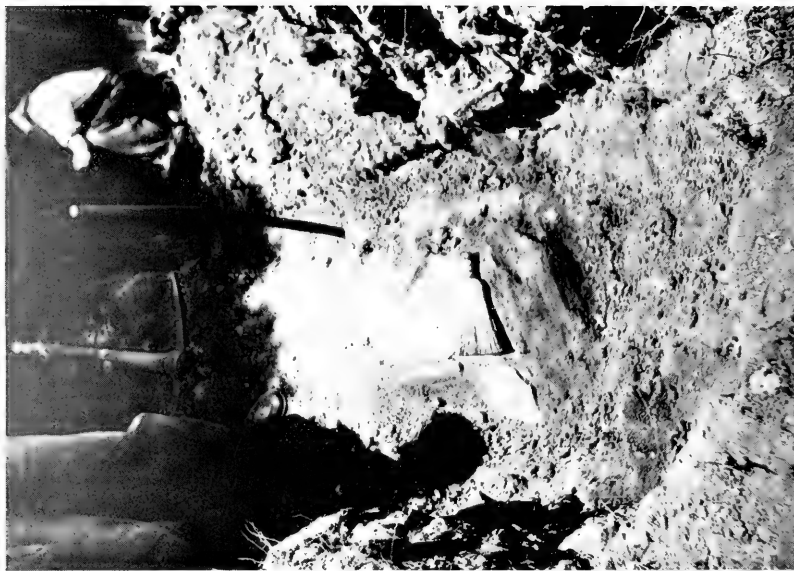

2. Specimen EH-68 (below whisk broom) in position on platform of Pinedale kiva.



1. Pinedale. P1-R2 after excavation. Note bulge in far wall and the doorway on level with the floor.



2. Pinedale. The offset in the south wall of the kiva and the suggestion of a banquette extending from the offset left to the platform.



1. The Pinedale kiva looking south. Note the collapsed platform at the south end.



2. Pinedale. East view of kiva looking into ventilating shaft and firepit.



1. Loom blocks found in the Pinedale kiva.

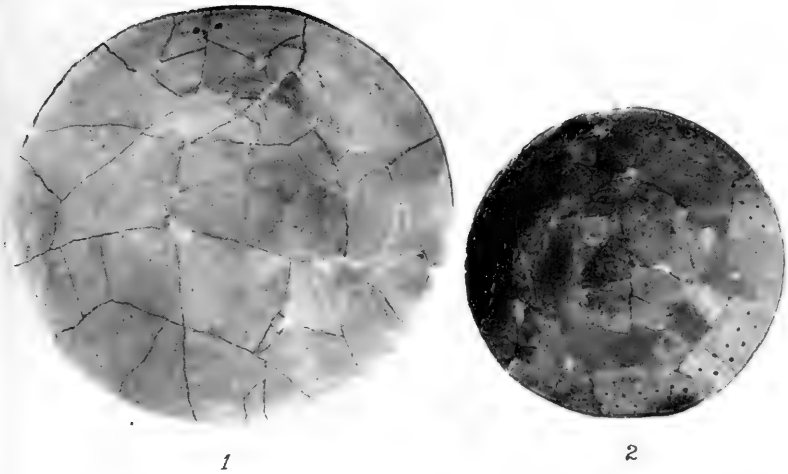

2. Platelike vessels from Pinedale. (Diameter of figure 1, $16\frac{1}{2}$ inches.)

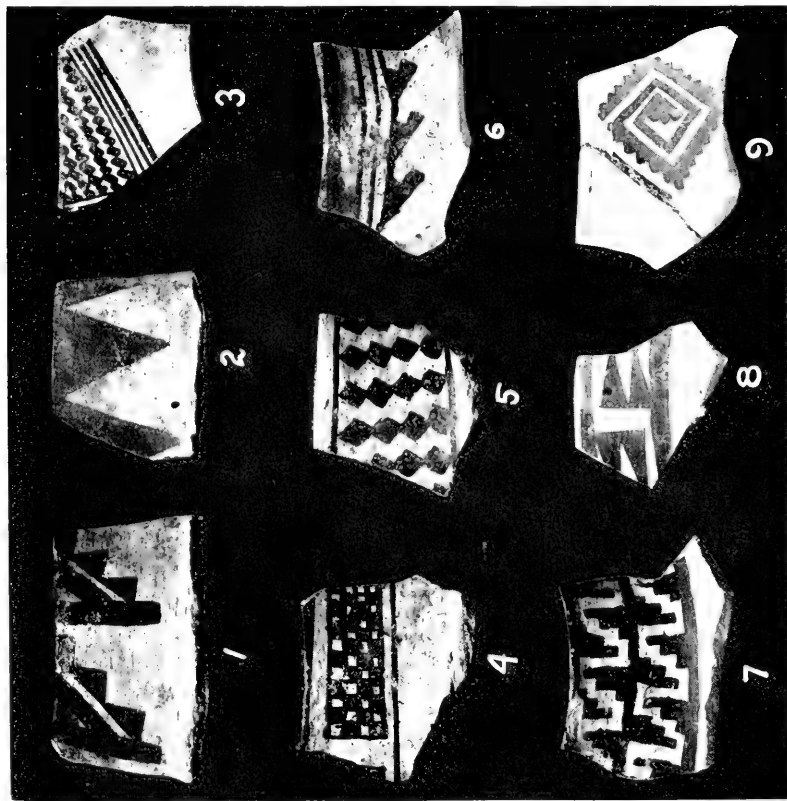

1. Black-on-white olla rim-sherds, from about 1290 horizon, Pinedale ruin.

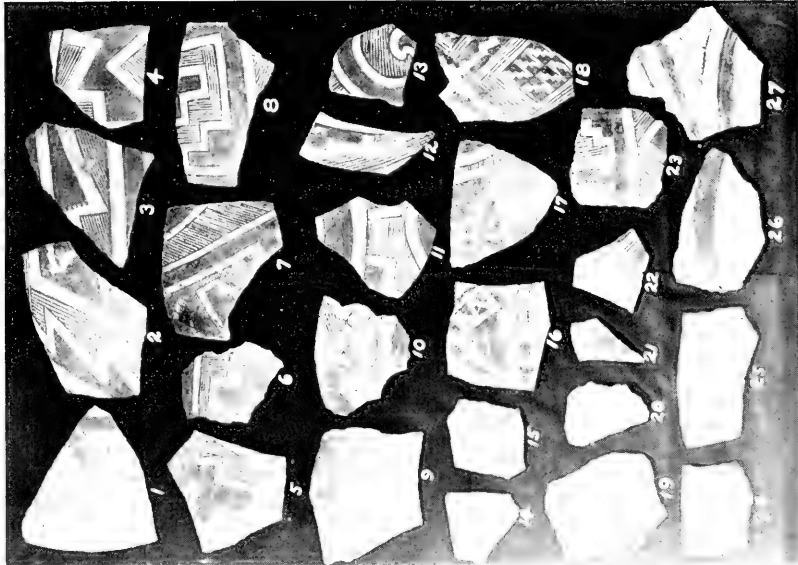

2. Black-on-white olla sherds from about 1290 horizon, Pinedale ruin.



Pinedale. Pulverized potsherds used as tempering material. Note particles showing former designs. (Enlarged six times.)

seems to be no satisfactory explanation, although in the vessel illustrated here they appear to have served no other purpose than ornamentation.

Corrugated.—Corrugated ware does not differ appreciably from that found in the lower horizon at Showlow. Finely corrugated ware is almost entirely lacking at Pinedale.

MISCELLANEOUS POTTERY OBJECTS

Knobbed vessel.—Figure 20 illustrates a fragment of a small globular black-on-white vessel found in test 5, Pinedale ruin. It has, in addition to the paint decoration, two horizontal rows of protuberances



FIG. 20.—Portion of a knobbed and painted vessel. (Actual size.)

spaced at about half-inch intervals. They were made by sticking small pointed pellets of clay to the vessel wall and emphasized further with touches of black paint. Broad black lines border the two rows of knobs.

Vessel fragment showing molded hand.—The object pictured in figure 21 illustrates another attempt at adding plastic features to a vessel exterior. Here a crude four-fingered hand is portrayed, evidently a part of a more elaborate production. The top of the hand and fingers originally were painted black but the paint is now almost obliterated. The thickness of the sherd, excluding the hand, is $\frac{3}{8}$ inch, and, judging by its curvature represents a vessel that was fully a foot in diameter.

Pottery scrapers.—In addition to several pottery scrapers similar to those found at Showlow, one was recovered in Pinedale ruin that

is of unusual interest. It is made of the handle and part of the body of a small black-on-red pitcher (fig. 22). The handle is decorated in imitation of an animal. Two small projections at the rim, each tipped with black, are probably intended to portray the eyes. Fewkes¹ recovered two black-on-white pitchers in Kin Tiel, the handles of both showing similar treatment.

Intrusive pottery types.—Fragments of vessels which are characteristic of the Middle Gila were found in considerable numbers in Pinedale ruin. These occur contemporaneously with the types of pottery described in the preceding pages. The abundance of this non-local ware need not imply, however, that all of the vessels were

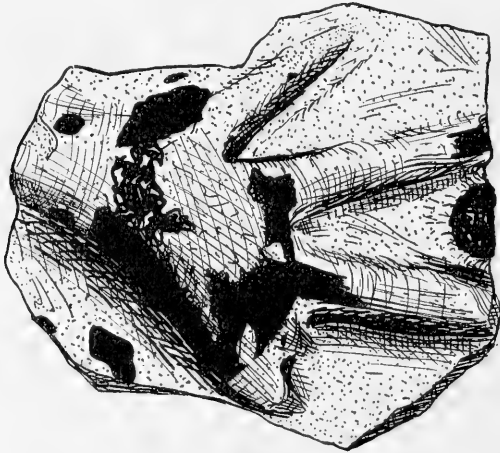

FIG. 21.—Vessel fragment showing molded hand. (Actual size.)

actually acquired in trade relations, but rather that some of it was made locally in imitation of trade pieces or possibly even made by women coming from the southern district. Examination of the sherds leads to a conviction that such was the case for there are some specimens identical in every respect with vessels of similar style found on the Gila, while others show local sherd-tempered paste and local treatment of the designs.

The fragments fall into two groups: (a) those of bowls with black-on-white interior decoration and plain red or brown exteriors, and (b) fragments of bowls with black interior designs on red. The former type is well known and was found to be a comparatively late arrival at Casa Grande by Mr. H. S. Gladwin.²

¹ Fewkes, J. W., 1904, pp. 130-131.

² Gladwin, H. S., September, 1928, p. 20.

The second group is perhaps less known and as far as we can find, has never been described. Vessels of the same character have been recovered by Dr. Bryon Cummings with cremations in ruins on the Gila near San Carlos. Technologically it is identical with the two-color decorated ware except that a light red or salmon-pink slip was substituted for the white. Sometimes the slip was dispensed with, the natural color of the base clay serving as the background.

Hopi relations are shown by two fragmentary vessels of Jeddito black-on-yellow, one found near the surface and the other with a late burial made in the fill in a room. Two bowls of Pinedale polychrome

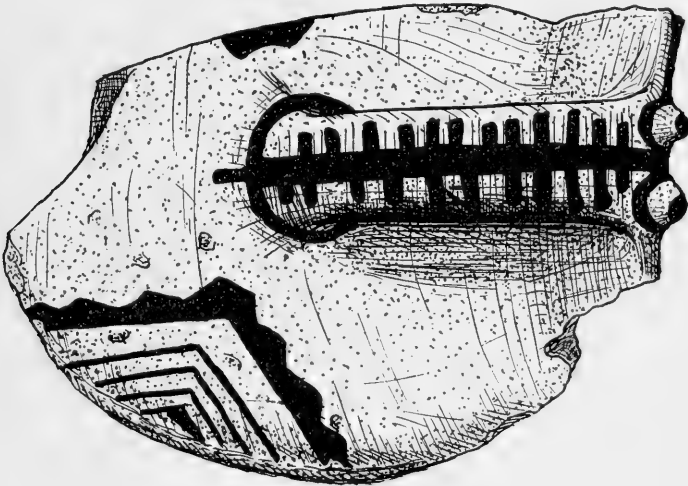

FIG. 22.—Pottery scraper made of a black-on-red pitcher fragment. (Actual size.)

were found with the latter. Sherds of local imitation of Hopi yellow pottery, such as noted from Showlow, were not encountered here.

Contacts with old Zuñi ruins are not clearly indicated. Hodge's early Hawikuh Period C may be represented by a few fragments of a black-glaze-on-white olla.

THE BAILEY RUIN

During the course of excavation at Pinedale, we were informed of a ruin of considerable extent, situated in the Phoenix Park district, approximately 15 miles west and slightly north of Pinedale. The ruin stands on land owned by Mr. Geo. W. Bailey and locally is known as "Bailey's ruin," although some years ago it was known as the "Stott

Ranch ruin.”¹ In the late '80s the ranch was a notorious center from which horse thieves operated.

The ruin is located a few hundred yards southwest of the ranch buildings on the south edge of a long narrow park. The higher part of the ruin is covered with large pine trees.

A sherd collection made on the first visit to the site contained, among other types, a small proportion of the black-on-orange-red phase of pottery which fell in the gap-period of the Douglass chronology. On these grounds a day was spent at the close of the field-work in putting down three tests to ascertain whether or not a prolonged search for charcoal would be justifiable. The three pits, sunk at widely separated points in the northern extension of the ruin were unproductive of charcoal, consequently further search was postponed.

The pottery at this site indicates contemporaneity with Pinedale. Late 14th century types are but meagerly represented, hence its history may be quite analogous to that of Pinedale.

The Bailey ruin is one of the few, if not the only one, of considerable size in this region which has not been pilfered. Less than a half-dozen rooms have been touched, and the trash mound which is extensive and superficially appears to have depth, is undisturbed. From it much valuable stratigraphic data could undoubtedly be obtained which would greatly clarify and contribute to the present meager knowledge of human activity in the Silver Creek drainage.

CONCLUSION

We may now turn our attention away from the purely archeological aspects of the problem and consider it on an historical basis. Dates obtained from charcoal have already been given in the several sections of this paper, but there still remains the formulation of the process of development as shown by the present data. Spier and Hodge² have contributed materially to the establishment of the sequent stages of progress in this southern part of the Little Colorado drainage. The present reconstruction follows the general outlines set by the above investigators, but it applies only to the area drained by Silver Creek and its immediate environs in which some local variations have been noted.

¹ So named by Fewkes, who visited it in the summer of 1897 but did not excavate due to its isolation from supplies. Fewkes, J. W., 1904, p. 167.

² Spier, L., 1919; Hodge, F. W., 1923; note also Kidder's résumé, 1924, p. 94.

The Showlow ruin and possibly the one at Pinedale originated as small, loosely arranged buildings of probably not more than a dozen rooms. The remains of small sites of this description are plentiful in the region, especially along Showlow Creek. Their existence is indicative of a time when the settlements were generally small; the buildings were apparently not more than one story high and not closely knit. Tests in the northeast section of the Showlow ruin brought to light the foundations of one of these early settlements. The associated pottery types are black-on-white of San Juan (Chaco) affiliation, a very small percentage of redware with dull black interior and white exterior designs, and corrugated ware of relatively fine technique. These types are in marked agreement with those found in the small communities not far afield.

Judging by the pottery found in them, the small sites seem to have been evacuated almost simultaneously not long before the decorated redware became plentiful. Such concordant action is almost certainly the result of a disorder, the cause of which might well be attributed to the influx of nomadic and predatory people. Just when this disorder, or whatever it was that motivated the change, took place, we cannot yet say positively as none of the small sites has been explored for wood specimens. However, on the strength of the evidence secured in the lower level at Showlow, we venture the assertion that it was prior to A. D. 1200, for by about that time a greater amount of decorated redware and black-on-white of southern derivation is present. The paucity of these types in the small ruins would place their abandonment at a somewhat earlier time.

The concentration of the population in a few chosen pueblos introduced problems before unknown. As a consequence, the movement was attended by an accelerating force and a stimulus in the development of certain cultural traits. Extensive structural additions to the villages were demanded in order to accommodate all. Rooms were compactly arranged side by side and one above the other. Thus, it seems, the true pueblo came into existence in this region.¹ In ceramics, the few types which showed exterior influences were modified and fused and native types underwent relatively rapid changes to produce highly localized forms.

We find that the Showlow and Pinedale pueblos attained their largest size during the 14th century. The Pinedale pueblo experienced a major building period in the last decades of the 13th century but

¹ The pueblo idea, however, was not original, for structures of that type had been in existence for several hundred years previous in the San Juan.

apparently grew very little after that time. A century later, the Showlow pueblo was still growing, then suddenly stopped and from all indications was involuntarily abandoned. The highest refinement in masonry is shown at Pinedale in the rooms dating towards the close of the 13th century. Several shallow late walls at this site and all of the late 14th century structures at Showlow indicate a marked retrogression in construction. This is in accord with the general trend of Pueblo architecture manifested in the ruins built after the Great Period (Pueblo III). The length of the occupation at Showlow, which Hough believed to be short, is approximately 200 years as indicated by datable charcoal, but, since charcoal is lacking from the old northeast quarter which appears to be still older than the first definite Showlow horizon, we can assume a considerably longer period of occupancy. The greatest exodus at the Pinedale pueblo seems to have taken place early in the 14th century, at least before the development of Four-mile polychrome in its fullest form. The presence of a small percentage of the latter indicates, however, that a few individuals remained or returned subsequent to the abandonment.

Concerning the development of ceramics during the lapse of time represented by the present diggings, we find it necessary to correlate the data from both ruins in order to place the material in its sequential order. Three periods are registered which pass almost imperceptibly into each other. For the oldest horizon represented in tests 1, 2, 3, and 12 at Showlow, we have ascribed the tentative date of 1204; the second period manifested at Pinedale is 1290; the last phase at Showlow again, is 1375. First period forms of decorated ware are black-on-white which evidences foreign influence, and black-on-orange-red with white exterior designs, possibly of local derivation. This phase is probably broadly coincident with Hodge's pre-Hawikuh Period A.¹ It is worthy of note that the pottery of Chaco traits existed in this region possibly a hundred years after the Chaco Canyon culture ceased.² This is a good example of the survival in marginal areas of a trait which has died out in the center of origin.

By about 1290 the black-on-white, which was still abundant, had been more or less standardized into a form typical of the region but with the retention of definite traits exhibited in black-on-white found along the Salt River. It represents probably the last survival of black-on-white pottery south of the Santa Fe railroad. Decorated redware

¹ Hodge, F. W., 1923, p. 29.

² Judd, N. M., (in preparation).

shows a signal increase in quantity and several rather abrupt departures from features of the lowest horizon form. The bowls have become shallower, black plays an important part in exterior designs, and white sometimes in interior patterns. This form, referred to as Pinedale polychrome, has been shown to be antecedent and leading up to the typical Four-mile polychrome as here described. Its time of appearance is certainly not later than the last decades of the 13th century. This period also marks the invention or the introduction of black glaze paint which was used on both white and red wares, without an appreciable change in decorative style. During this second stage practically all of the pottery made, except the corrugated, was decorated. External relations were largely to the south with the people of the Middle Gila, and to a lesser degree to the east with old Zuñi and north with the old Hopi cultures.

By 1375, black-on-white pottery was practically non-existent. Its rather sudden disappearance may be explained by an intense local specialization of the decorated redware or Four-mile polychrome. The basic differences between the latter and its ancestral form are: a deeper red slip covering the paste; a poorer, gritty black paint but still basically a glaze; exterior continuous patterns in black and white; and generally unbalanced geometric units and life patterns on the interior fields of design, also executed in black and edged with white. Guided by Fewkes' finds at Four-mile ruin, we may say that the use of life patterns in bowls became more prevalent in the most recent forms of Four-mile polychrome. Relatively few are noted in bowls from the Showlow ruin and more from Four-mile which was abandoned after Showlow. The last phases of Four-mile polychrome at its type site are contemporary with Jeddito black-on-yellow and the three-color Tonto polychrome,¹ and then, rather suddenly apparently, it passed out of existence. Interrelations at the close of the last period were increasing with the Zuñi and Hopi areas although contacts with the Gila are still represented.

At this point it is well to insert a brief discussion of the age of lead glaze in the Pueblo region in the light of the expedition's discoveries. Some investigators are of the opinion that the glaze technique is acultural and not indigenous; that it was obtained from the Spaniards or even from Mexico later than the Conquest. Other explorers, however, have given glaze decoration a pre-Spanish status on the basis of stratigraphy. To this latter contention our evidence is directly corroborative. Not only does stratigraphy at Showlow and

¹ The Medallion, 1930, pp. 8-9, pl. VI.

Pinedale ruins, both totally abandoned before the advent of the Spaniards, uphold this, but the newest science for age-determination of southwestern ruins, namely, dendro-chronology, confirms the stratigraphic claim. And more, it hints strongly at the length of time that elapsed between the development of a glaze technique and the first Spanish contacts.

As previously suggested, the apparent gradual merging of the dull black paint into one with glaze properties on Pinedale polychrome does not bespeak a sudden appearance of glaze but rather of a slow development in or not far from the center of invention. The beginnings of Zuñi and Pinedale glaze development appear to parallel each other, both seemingly responding to the same stimulus. That this stimulus was pre-Spanish and consequently native, is indicated by the presence of lead glaze on Pinedale polychrome coming from the late 13th century horizon at Pinedale, and the continuance of its use on Four-mile polychrome from the upper Showlow level dating 1375. Thus, glaze paint was known and used fully 200 years before the arrival of the Conquistadores. Indeed, it had already become decadent by the time of their arrival and soon after the Pueblo potters reverted completely to the dull, flat colors.¹

These facts do not agree with Hough's statement, therefore, when he says² “. . . . that the Pueblo potter could take the step to glaze which appears to have arisen in the line of smelting metals is doubtful.” Or, “. . . . a critical examination of the question as to the use in prehistoric times of lead glaze decoration by the Pueblo Indians brings forward a number of points which seem to render the assumption doubtful if not improbable.” He states further that glaze decorated wares are never associated with black-on-white. Numerous tests in Pinedale ruin always showed glazed wares and black-on-white to be synchronous, the latter also frequently, but not always, decorated with glaze. This contemporaneity of glaze and black-on-white wares either signifies that glaze was invented earlier than has been supposed, or, that the Pinedale black-on-white was a late survival.

Additional checks on the age of lead glaze may be had by the presence of intrusive glazed sherds in ruins outside of the glaze area. Thus, Four-mile polychrome sherds and Zuñi glazes found in Kokopnyama which has yielded no trace of Spanish influence and no datable wood more recent than A. D. 1416, and the occurrence of Four-mile

¹ Kidder, A. V., 1924, p. 91.

² Hough, Walter, 1928, pp. 248-249.

polychrome at Casa Grande ruin,¹ show that glazed pottery entered the trade channels and was carried far afield before 1520.

The arguments for a post-Spanish origin for glaze in the Pueblo region can hardly be considered tenable in view of the unerring evidence of stratigraphy and dendro-chronology combined.

It is of especial interest to note that in the Pinedale horizon two types of glaze occurred contemporaneously for a short time. The indications of Mr. Hawley's paint tests are that the redware invariably carried a lead glaze with a relatively high copper content, while the black glaze on white ware contained neither lead nor copper but was apparently of a salt compound. The latter was earlier than the lead glaze, for a small percent of black-on-white pottery from the lower Showlow stratum bore a black shiny paint, foreshadowing its later development. It seems to have passed out of existence, however, with black-on-white ware, being survived by the lead glaze. It may therefore have contributed in some measure to the development of the superior lead glaze paint.

The sequential development of the decorated redware of the first Showlow horizon to Four-mile polychrome of the final stage makes an interesting disclosure concerning the spatial element involved in ceramic progression. If the date ascribed to the oldest culture period is correct, namely, A. D. 1204, then approximately 200 years elapsed to effect the changes. The transitional form, Pinedale polychrome, comes about midway between the two terminal dates. Thus approximately each century, basic changes were made in pottery, so that by the end of a 200-year period, the resultant form had but little resemblance to its earliest forerunner. These figures are not given as generalities, as the rate of development undoubtedly depended upon the nearness to a manufacturing nucleus and upon external influences, but they seem to hold true for the region under consideration.

The accurate date-checks of Four-mile polychrome which have been secured make it invaluable as an indicator of time in those ruins where it is found. Thus, Four-mile ruin, a site near Shumway, Homolobi, Chavez Pass, Cheylon, and a few others were occupied as late possibly as the beginning of the 15th century. The occurrence of Four-mile polychrome in Gila Pueblo, Globe, and at Casa Grande, west of Florence, shows trade relations and, hence, life in those sites as late as about 1400. Mr. H. S. Gladwin's recovery of four or five sherds of this ware in the Late or Classic horizon at Casa Grande is convincing as to the recency of occupation there.

¹ The Medallion, 1929, pl. IV.

The following composite tabulation of the several recognized horizons and the related local ceramic types in Showlow and Pinedale ruins is necessarily incomplete and must be enlarged upon at a subsequent time.

First Horizon: A. D. 1204 (?) Showlow

Black-on-white very abundant; shows both Chaco Canyon and southern affinity.

Black-on-orange-red with white exterior patterns abundant; designs usually balanced solid and hatched elements in dull paint. (Pl. 8.)

Corrugated ware crude to fine, some with exterior white decoration. (Pl. 9, fig. 1.)

Second Horizon: 1290 ± Pinedale

Black-on-white abundant; vessel forms mainly ollas; decorations are distinctly local but retain certain foreign features; thin black glaze paint commonly used. (Pl. 19, figs. 1 and 2, text fig. 17.)

Pinedale polychrome very abundant, appearing almost exclusively as bowls; is directly derived from the first horizon orange-red phase; white seldom used on interiors and almost invariably in association with black on exteriors in independent units or continuous patterns; interior designs geometric and balanced but of great variety; black paint is preponderantly a lead glaze, seldom merging into other colors. (Figs. 18 and 19.)

Corrugated ware crude and not very abundant.

Third Horizon: 1375 ± Showlow

Black-on-white ware rare or absent, apparently no longer in vogue.

Four-mile polychrome predominating decorated ware; slip a darker red and generally softer than antecedent stage; glaze paint is decadent, may lack luster and be vitreous and gritty; exterior patterns are in black and white and almost without exception continuous; interior designs are also in black and white in specialized geometric and zoomorphic elements. (Pls. 11 and 12.)

Corrugated ware more abundant, some shows horizontal flutings or ribs not evident before. (Pl. 9, fig. 2.)

BIBLIOGRAPHY

BANDELER, A. F.

1892. Final report of investigations among the Indians of the Southwestern United States, Part II. Papers Archaeol. Inst. America, American Series, No. IV, Cambridge, 1892.

DOUGLASS, A. E.

1929. The secret of the Southwest solved by talkative tree rings. Nat. Geogr. Mag., December, 1929. Vol. LVI, No. 6, pp. 737-770, Washington, 1929.

FEWKES, J. W.

1894. The Snake ceremonials at Walpi. Journ. Amer. Ethnol. and Archaeol., Vol. IV, Cambridge, 1894.
1904. Two summers' work in pueblo ruins. Twenty-second Ann. Rep., Bur. Amer. Ethnol., Pt. I, pp. 3-195, Washington, 1904.

GLADWIN, H. S.

1928. Excavations at Casa Grande, Arizona. Southwest Museum Papers, No. 2, Los Angeles, 1928.

GUTHE, CARL E.

1925. Pueblo pottery making. Papers of the Southwestern Expedition, No. 2. Published for the Department of Archaeology, Phillips Academy, Andover, Mass., by the Yale University Press, New Haven, 1925.

HODGE, F. W.

1920. Hawikuh bonework. *Mus. Amer. Ind.*, Heye Foundation; *Indian Notes and Monog.*, Vol. III, No. 3, New York, 1920.
1922. Recent excavations at Hawikuh. *El Palacio*, Vol. XII, No. 1, pp. 1-11, Santa Fe, 1922.
1923. Circular kivas near Hawikuh, New Mexico. *Contr. Mus. Amer. Ind.*, Heye Foundation, Vol. VII, No. 1, New York, 1923.

HOUGH, WALTER.

1903. Archeological field-work in northeastern Arizona, the Museum-Gates Expedition of 1901. *Ann. Rep. U. S. Nat. Mus. for 1901*, pp. 279-358, Washington, 1903.
1928. The lead glaze decorated pottery of the Pueblo region. *Amer. Anthrop.*, N. S., Vol. 30, No. 2, April, 1928, pp. 243-249; Menasha, 1928.

JUDD, N. M.

1922. The Pueblo Bonito Expedition of the National Geographic Society. *Nat. Geogr. Mag.*, March, 1922, Vol. XLI, No. 3, pp. 322-331, Washington, 1922.
1925. Every-day life in Pueblo Bonito. *Nat. Geogr. Mag.*, September, 1925, Vol. XLVIII, No. 3, pp. 227-262, Washington, 1925.

KIDDER, A. V., and GUERNSEY, S. J.

1919. Archeological explorations in northeastern Arizona. *Bull.* 65, *Bur. Amer. Ethnol.*, Washington, 1919.

KIDDER, A. V.

1924. An introduction to the study of southwestern archeology. Papers of the Southwestern Expedition, No. 1. Published for the Department of Archaeology, Phillips Academy, Andover, Mass., by the Yale University Press, New Haven, 1924.

MEDALLION, THE

1929. The red-on-buff culture of the Gila Basin, Pasadena, 1929.
1930. Some southwestern pottery types. *Globe*, 1930.

SPIER, L.

1919. Ruins in the White Mountains, Arizona. *Anthrop. Papers Amer. Mus. Nat. Hist.*, Vol. XVIII, Pt. 5, New York, 1919.

STEVENSON, MATILDA COXE.

1904. The Zuñi Indians, their mythology, esoteric fraternities, and ceremonies. *Twenty-third Ann. Rep.*, *Bur. Amer. Ethnol. for 1901-1902*, Washington, 1904.

EXCAVATIONS AT KIN TIEL AND KOKOPNYAMA

By LYNDON L. HARGRAVE

Following a superficial examination of several ruins in the Little Colorado River drainage early in the summer of 1929, the Third Beam Expedition of the National Geographic Society centered its initial search for datable fragments of charred ceiling timbers in the two pre-Spanish Indian villages at Showlow and Pinedale, Navajo County, Arizona. After working a few weeks with Mr. Haury at the former site the present writer proceeded to Kin Tiel ruin; later, to Kokopnyama.¹ Since both these villages lie north of the Little Colorado and show definite Hopi affinities, the observations presented herein may prove helpful to those archeologists interested in that period of Hopi history which shortly preceded the coming of the Spaniards in 1540. The writer begs to remind his readers, however, that the 1929 explorations were undertaken solely for the purpose of collecting ancient beams that might contribute to the completion of the Douglass tree-ring chronology and thus disclose the actual age of Pueblo Bonito, in Chaco Canyon, New Mexico. The data herein recorded are, therefore, to be regarded merely as by-products of the expedition.

KIN TIEL RUIN

Wide Ruin, or Kin Tiel as the Navajo call it, is a well-known ruin situated on an eastern tributary of LeRoux Wash 18 miles north of Chambers, Arizona. On early maps the ruin is indicated as Pueblo Grande² and was first given prominence through the work of Mindeleff³ and Fewkes.⁴ At the time of their respective observations, the old village must have presented an inspiring sight, for many portions of its broken walls were standing two stories high. Today these have been reduced to a low mound which, from its shape, is sometimes referred to as "The Butterfly Ruin." The appropriateness of this term is at once apparent from the accompanying ground plan (fig. 23).

¹ The author wishes to thank Mr. E. C. Greene, Jr., for his services as field assistant, and for drawing the plans.

² 8th Ann. Rep., Bur. Amer. Ethnol., 1886-7, p. 91.

³ 8th Ann. Rep., Bur. Amer. Ethnol., 1886-7. A study of Pueblo architecture, Tusayan and Cibola, by Victor Mindeleff.

⁴ 22nd Ann. Rep., Bur. Amer. Ethnol., part 1, 1900-01, p. 124.

Unlike other known ruins in the district, the outer wall of Kin Tiel was unbroken save for narrow passageways.¹ Terraced dwellings looked down upon open courts as in the case of Pueblo Bonito; these courts were separated by a stream channel which appears to have been crossed by extensions of the outer wall of the village, if we may judge from Mindeleff's carefully prepared plan.

Toward the west end of the pueblo and crossed by the wash, or stream channel, a masonry-walled spring furnished the village folk with an abundance of clean pure water. Today this spring is used by Mrs. D. W. Balcolm,² the present owner, who has installed a pump to supply domestic water for her trading post, as well as water for the flocks of Navajo sheep that range the district. When Mindeleff made his reconnaissance the location of this spring was unknown,³ and he comments upon the apparent lack of an adequate water supply. The spring was discovered about 40 years ago by Mr. Hawthorn, who settled and built a trading post nearby, and who unfortunately destroyed most of the outer wall of the ruin in his search for suitable building material. This destruction has been completed within the past two years, for the foundation stones at Kin Tiel were quite naturally preferred in the construction of modern dwellings. In consequence, no primitive masonry today stands above ground. The Butterfly Ruin has been levelled utterly; its once terraced chambers have been reduced to a low, wide-spread mound of sandstone blocks and adobe mortar.

KIVA KT-I

Since the sole object of the National Geographic Society's 1929 expedition was to secure datable beam material, and since previous experience had taught us that the largest beams were likely to be found in kivas, the well-known subterranean ceremonial chambers of the Pueblo tribes, our initial efforts in Kin Tiel were directed toward discovering burned rooms of this type. A large circular depression was therefore chosen for excavation. This, because of its location and diameter, was thought to indicate a kiva of Pueblo Bonito type. Certain local resemblances to Bonitian architecture and pottery had greatly influenced this belief, in spite of the traditional connec-

¹ 8th Ann. Rep., Bur. Amer. Ethnol., 1886-7, p. 92.

² We wish to acknowledge Mrs. Balcolm's willing cooperation in the purpose of the expedition, her generous permission to excavate and her warm hospitality which was extended to the members of our party.

³ 8th Ann. Rep., Bur. Amer. Ethnol., 1886-7, p. 92.

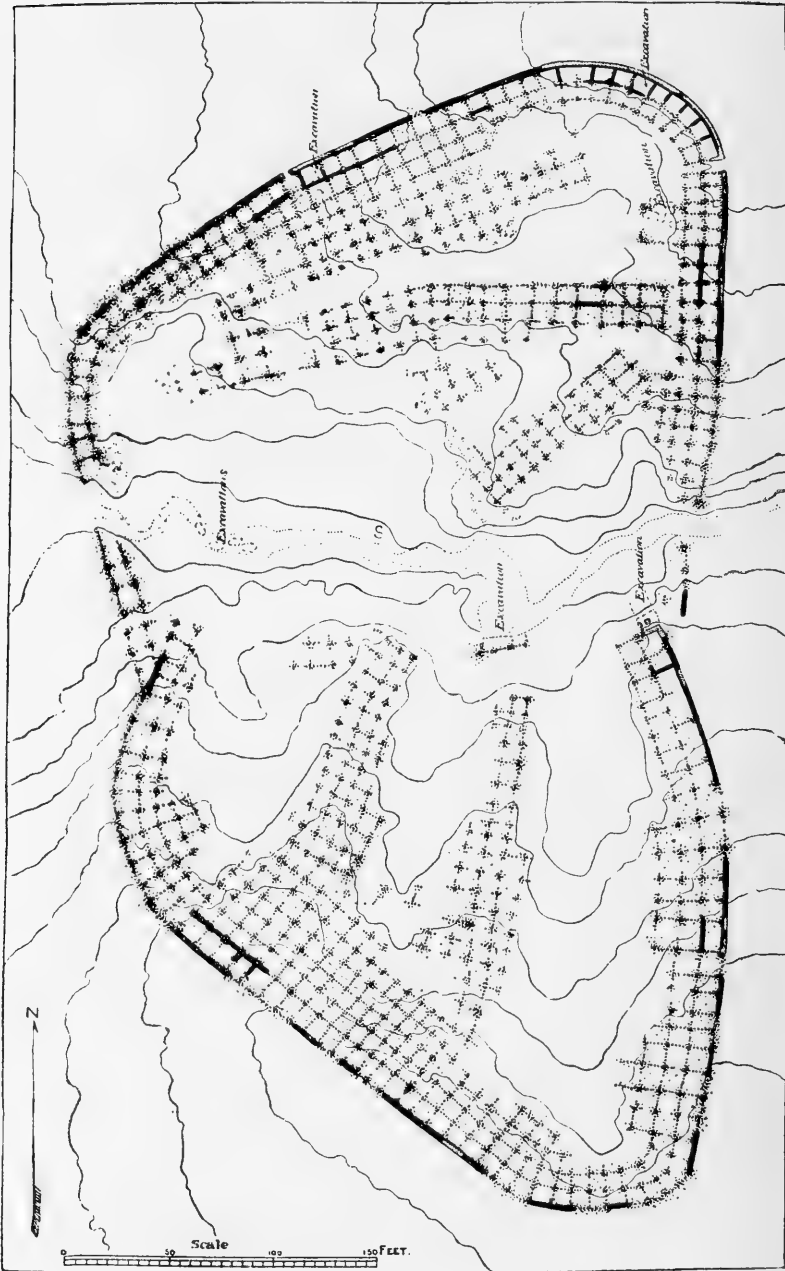

Fig. 23.—Plan of Kin Tiel.

Reproduced from plate L.XIII, 8th Annual Report, Bureau of American Ethnology. The "excavation" in the lower right corner, started by Mindeleff, is our KT-II. Traditionally Kin Tiel is Zuni; architecturally it resembles Pueblo Bonito; in ceramics it is a mixture of types, while kivas are of the Hopi type. Kin Tiel was inhabited as late as 1285 A. D.

tion with Zuñi.¹ Excavation, however, proved the absence of charred timbers and we turned to another depression of similar appearance.

Contrary to expectations this second test revealed a rectangular room which differed only in non-essentials from similar chambers in present-day Hopi villages. We had no reason to expect a subterranean room of this type even though there was some justification for the belief that Kin Tiel was contemporaneous with prehistoric Hopi settlements of the late Pueblo III and early Pueblo IV horizons. We had noted no superficial evidence of Hopi culture, but Mindeleff had remarked² that large circular depressions often revealed rectangular rooms. This statement was based on the fact that he had found, only a few feet from our second excavation, the walls of a rectangular room which for lack of time he was unable completely to lay bare. We finished the work he started in this particular chamber (our KT-II) and the resultant floor plan closely resembles that of KT-I, the first kiva we excavated at Kin Tiel.

For a better understanding of the Hopi type of kiva let us consider this latter chamber (fig. 24). Its floor is divided into what we may call the kiva room and the platform, or alcove. On the elevated platform, spectators might gather to witness the rituals performed in the larger space where the "altar" appropriate to each ceremony was arranged and the accompanying prayer dramatized.³

It is probable that this kiva, KT-I, is the oldest of the Hopi type yet excavated, and while its shape seems to be a modification of the earlier rectangular kiva, such as those at Betatakin, for example, in this instance there appear to be two rooms combined and remodelled. This is indicated by the difference in construction of the two divisions: the walls of the platform are of masonry, whereas those of the kiva room are merely the adobe plastered sides of a hole dug into hard-packed sand. The kiva floor, or area devoted to ceremonial purposes, is both wider and longer than that of the platform, though both were under the same roof.

Other general characteristics of the special type noted in KT-I are: offsets or jogs, in the side wall where the kiva room and platform alcove meet; the deflector, or fire screen; the firepit; the ventilator, in the lower face of the platform; the ventilator passageway beneath

¹ 8th Ann. Rep., Bur. Amer. Ethnol., 1886-7, p. 92.

² 8th Ann. Rep., Bur. Amer. Ethnol., 1886-7, p. 93.

³ A detailed architectural description of the Hopi kiva of the nineteenth century is given by Mindeleff in *A study of Pueblo architecture*, Tusayan and Cibola. 8th Ann. Rep., Bur. Amer. Ethnol., 1886-7.

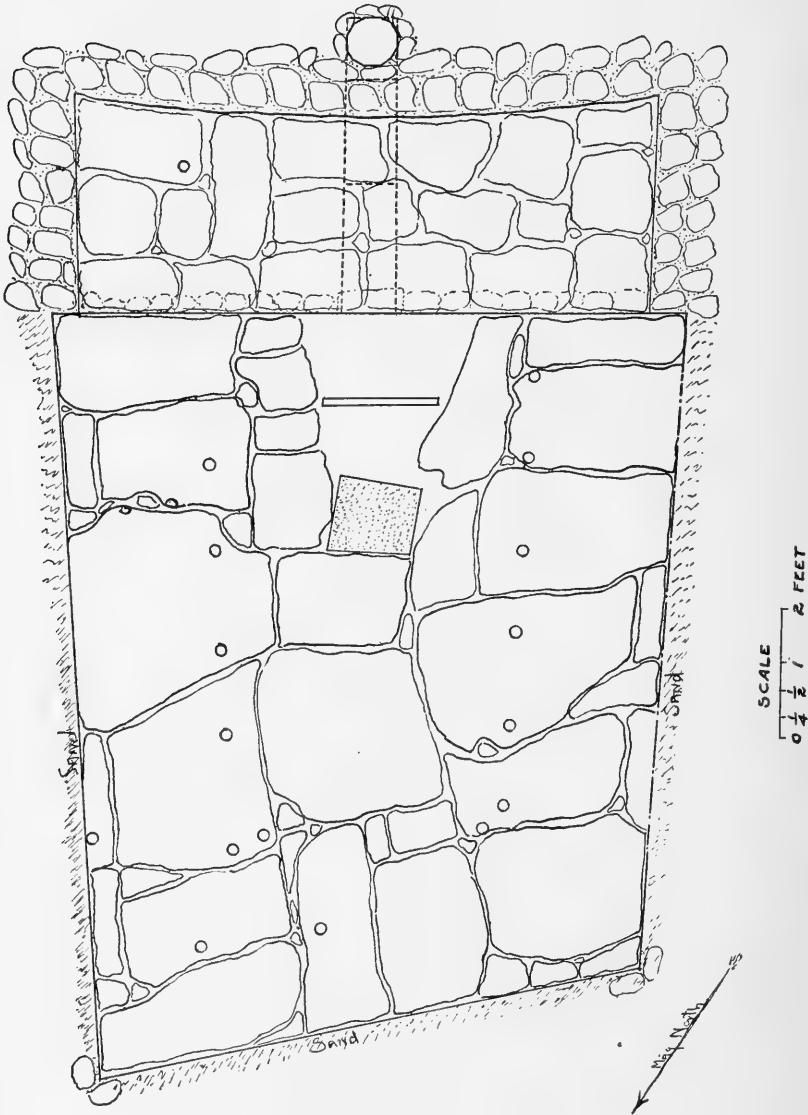

FIG. 24.—Plan of Kiva KT-I.

KT-I is probably the oldest of the Hopi type kiva yet reported. In arrangement it is typical, being divided into two sections, the kiva-room and platform, with offsets at the junction of the kiva-room and platform. It has a firepit, a deflector, and a ventilator passing under the platform and connecting with an airshaft on the outside. KT-I is unique because the kiva-room was excavated in a sand dune without the support of masonry walls—a poor practice as the collapse of the walls carried down the roof which crushed five men. KT-I was constructed and destroyed in 1276 A. D.

the platform and outer wall; and the ventilator or air shaft connecting with the passageway outside of the kiva wall. Banquettes and pilasters are absent in both KT-I and II, and the presence of a sipapu is questionable.

The ceiling height is not known, but in the northeast and southwest corners, 6 feet 11 inches above the floor, three courses of masonry remain as a possible support for the original roof timbers. The roof was probably just above ground, as is the case with the older historic Hopi kivas. The original ceiling height is estimated to have been between 7 and 8 feet.

In determining the length of the chamber, the raised platform alcove must be considered, for it is really a part of the same room. In KT-I, the depth of the platform is 4 feet 1 inch; this, added to the length of the kiva room, makes a total length of about 17 feet. Overlooking the principal floor area as it does, the platform provided space for spectators just as we saw them during practice of the Bean Dance at Oraibi in 1928.¹

In front of and on each side of the platform alcove is a jog or offset (pl. 21, fig. 1). That on the west is 8½ inches wide; that on the east, 6½ inches. Both offsets are of masonry abutting the cut banks which form the kiva walls.

As previously stated, the side walls of the kiva are of adobe plaster applied directly to the sandy face of the original excavation. I do not recall any other pueblo ruin so late as Kin Tiel in which plastered earth walls substituted for masonry. Only the firm condition of the sand bed made this possible. But that the builders were taking a chance is shown by the later collapse of the plastered banks.

The collapse of the roof was obviously caused by the caving of the west wall. That this accident came suddenly and without warning is evidenced by the fact that five men were caught between the settling ceiling and the floor. Two jumbled skeletons were on the southwest end of the platform. A few feet northeast of the fire-pit, and in a sprawled position with the head resting on a pile of tumbled rocks, was found the third skeleton, which was partly burned. The skull and upper part of the body were burned where they came in contact with the burned part of a large juniper beam. The lower part of the skeleton, lying free from the beam, was excellently preserved, being covered with wind-blown sand that had sifted through the roof. Two tubular bone beads, several large circu-

¹ Nat. Geogr. Mag., Vol. 56, No. 6, p. 755. Washington, 1929.

lar beads of a white chalky material, and a large flint point were found among the bones of the body. Fragments of both black-on-orange and corrugated pottery were under this skeleton, and on the floor nearby were sherds of black-on-white ware. The fourth skeleton was in the northeast corner, in a flexed position on the floor, with face toward the firepit, and only partially destroyed by fire. Wind-blown sand had sifted through the roof and covered the bones. Sherds similar to those with skeleton no. 3 were found near skeleton no. 4. Mixed with the charred bones of the latter were hundreds of blow-fly pupae cases that had been carbonized by the fire when the roof was burned. The fifth skeleton was found 3 feet 4 inches from the west wall, and 1 foot 6 inches from the north wall. The jaw was that of a youth whose burned bones were found 2 feet above the floor, resting upon the collapsed wall.

The presence of blow-fly pupae cases seems to explain why the kiva was burned, and from the facts found the story of the tragedy may be partially reconstructed. In time the natural earth walls of the kiva probably became so weakened by the weight of the roof, and from the absorption of moisture, that the west wall caved in. Five men were trapped and lost their lives. That the kiva and its unfortunate occupants were not entirely burned at the time of the accident is manifest by the occurrence of the carbonized pupae cases of the blow-fly, and can only mean that the structure was fired after the men had been dead for some time. From the proximity of dwelling rooms to the scene of the disaster, we might infer that the ruined kiva was intentionally fired for sanitary purposes.

Pueblo custom decrees that the kiva be partly if not wholly underground. Even among the Hopi, whose villages stand on rocky buttes, kivas are often built on a lower sandstone ledge. With at least one side abutting the cliff face the prescribed subterranean, or semi-subterranean, position was thus realized without excavation of solid rock—a tedious task for folk not formerly possessed of metal tools.

Returning to Kin Tiel, the masonry walls at the platform end of Kiva KT-I were excellently constructed of hard, fine-grained sandstone. This sandstone, possessing definite lines of cleavage, could with little effort be split into blocks of fairly uniform size. The average size is about 2 inches thick and 10 inches long. Breaking of joints and dovetailing of corners was practiced but neither occurred consistently. The mortar was fine, sandy and sparingly used because the flat surfaces of the building stones fitted easily together.

The floor of KT-I, and that of the platform as well, is of smoothly worn irregular sandstone slabs averaging 1 inch in thickness and about $2\frac{1}{2}$ by 3 feet square. In the stone floor, 2 feet 9 inches from the east wall, are five holes in line. They average approximately $2\frac{3}{4}$ inches in diameter and 19 inches from center to center. On the opposite side of the kiva is a row of six similar holes, slightly closer together, this second series being 14 inches from the base of the platform, whereas the first hole in the other row lies 2 feet 10 inches from the platform. Of six other holes, five lie in the main part of the floor; one, in that of the platform. Since these latter six were either plugged with clay or a sandstone stopper, it is believed that they had been abandoned and superseded by the two series above described. It is also a possibility that the slabs in which they occur may have been salvaged from other rooms and re-used.

A possible explanation of this belief may be the clay-plugged hole which lies 4 feet 6 inches from the north wall and 3 feet 3 inches from the east. The position of this hole, primarily, prompts a suggestion that it might be a sipapu, but it is not in line with the firepit, deflector, and ventilator, and it is too far removed from the firepit which, itself, is not carefully oriented (fig. 24). A careful examination of the earth beneath this hole revealed only undisturbed soil; not the clay-lined cylinder anticipated.

From our observations it would appear that only the two series of five and six holes, respectively, were in use at the time Kiva KT-I was abandoned. As to their functions, two theories have been advanced. The first is that such holes were used to anchor the lower end of a loom, a theory to which the writer subscribes. It is well-known that Hopi men have long woven blankets in their kivas.

The second and quite improbable explanation is advanced by a Hopi who admitted that while such holes are often used in fastening the looms to the floor their real purpose is ceremonial. According to our informant, holes such as those under discussion were designed to hold freshly grown plants. The writer has not observed flagstone floors in modern Hopi kivas nor has he seen this arrangement of round holes. In Hopi ceremonial chambers a square log or plank with a series of small rectangular holes is buried in the floor on either side.¹ These rectangular holes are definitely made for weaving. They may lie not only in the floor proper, but at either side of the platform, and even at the ends of the kiva, and cut as they are in

¹ Mindeleff, Victor, A study of Pueblo architecture, Tusayan and Cibola. 8th Ann. Rep., Bur. Amer. Ethnol., 1886-7, p. 132.

wood, they are entirely unsuited for potting plants. And yet it might be that, in prehistoric times, such floor holes served this dual purpose; that some tradition of that dual function has survived until the present.

The firepit, 3 feet $1\frac{1}{2}$ inches from the base of the platform, is in line with the ventilator and deflector, though not parallel to the latter. Though the length of the sides is not consistent, averaging 1 foot $4\frac{1}{2}$ inches, the firepit approximates a square. It is 7 inches deep and lined with clay-coated slabs of sandstone, but no evidence of the corners being rounded with clay was found. The top of the pit is flush with the floor of the room.

Seventeen inches from the firepit, and between it and the ventilator, was a deflector—a sandstone slab with rounded top and corners. The deflector is $1\frac{1}{2}$ inches thick, 2 feet 2 inches wide and 2 feet 1 inch high. It was set several inches deep into the floor and so firmly that it was broken off just above the floor by the falling roof. Though cleanly broken when found, it was still in an upright position supported by fallen débris. The narrow space between the deflector and platform was the only part of the kiva floor not paved with flagstones. Beneath the clay-surfaced area loose earth and rocks were found.

At the south end of the kiva, 19 inches from the deflector, was the platform (pl. 21, fig. 1) which was 2 feet $6\frac{1}{2}$ inches high and 4 feet wide. The vertical face of this platform as well as the natural walls of KT-I were coated with plaster. Upon this plaster was a coat of white-wash. As is usual in kivas of this type, fresh air was drawn in through a vertical shaft outside the walls of the chamber, through a passageway beneath the platform and thence by means of an opening in the middle front. In KT-I, this opening measured 12 inches wide by 22 inches high; its lintel consisted of two superposed sandstone slabs, 6 or 7 inches wide and separated by adobe mortar, making a total thickness of 6 inches. The total length of the passageway from the entrance in the face of the platform to the back of the air shaft was 5 feet $6\frac{1}{2}$ inches. The passageway, or ventilator duct, was roofed with small sticks covered by a $4\frac{1}{2}$ -inch layer of adobe mortar as a support for the flagstones of the platform. Most of these sticks had decayed but their imprints remained where the passageway had not collapsed under the weight of the falling roof. Like the sides of the ventilator opening, the duct walls were of undisturbed earth, heavily plastered with clay. At a point 2 feet 5 inches from the entrance was a plastered step 1 foot high. This level continued back to the base of the shaft where the width narrowed to 11 inches. Between the step and the shaft the height of the passageway remained 10 inches.

The ventilator shaft was built of sandstone blocks somewhat smaller than those used in construction of the room walls. The base of the shaft, where it opened to the passageway, was slightly D-shaped and averaged 14 inches in diameter. A short distance from the bottom, the shaft became circular; at its present top, 7 feet 6 inches above the duct floor, it was octagonal and 11½ inches in diameter. The upper portion of the shaft had collapsed with the wall against which it stood.

The roof construction of KT-I may be approximated by the burned material found in the northwest end of the chamber. Beams 3 to 5 inches in diameter had spanned the room and supported the customary series of ceiling poles. Upon these was a layer of brush and grass overlaid by several inches of adobe mud. The thoroughly charred timbers had been broken into fragments rarely more than a foot in length. Among these we recognized only one pine beam; all the others were either piñon or juniper. About the firepit and deflector were a number of sandstone slabs that obviously had fallen with the roof. Their positions suggest that they probably rimmed the kiva hatchway and that the latter, as in modern Hopi kivas, were above the firepit. If this supposition is correct, then the chamber was entered by means of a ladder extending through the hatchway and resting on the platform floor.

On removing the wind-blown sand and fallen roof, midden débris was found in quantity, and in such position that it was obviously not thrown through the roof entrance but through the hole left by the collapse of the west wall. At this point the top of the midden was 4 feet 2 inches above the floor, which, however, was not the greatest depth of débris, since the bottom of the midden rested upon the fallen wall. Transversely, the midden extended from the face of the south wall to the north edge of the firepit (see drawing). From the firepit to the north wall the roof rested upon the floor.

The midden fill of KT-I was principally of wood ash, scattered through which were discarded stone implements, bone awls, turkey and small-mammal bones, and quantities of potsherds of black-on-white, corrugated, and a ware of a peculiar shade of orange decorated in black. Differences and even local characteristics have been noted, though a more comprehensive study of the sherds collected will have to be made before these differences can be adequately defined.

While excavating KT-I, a flexed burial was found, though no relation to the conditions in the kiva was indicated. In the northeast corner, on top of the fallen roof and 2 feet above the floor, the

body was found against the wall and curved around the corner with the head against the east wall, though facing west. The bones were so well preserved that the skeleton was removed for later study. Between the skeleton and the roof were two sandstone slabs in a vertical position, across which the skeleton lay. The slabs appeared to be part of the fallen roof support, rather than those of a burial cist. In a horizontal position on top of the skeleton lay a flat, oval stone 1 foot wide, and 1 foot 8 inches long upon which was a crushed corrugated olla. The skeleton was found 4 feet 5 inches below the top of the excavation in alternating layers of sand and human excrement, overlaid by about 2 feet 6 inches of adobe. The kiva at this point was filled with rocks that were once a part of adjacent dwelling rooms.

ARTIFACTS

With the exception of the beads and flint point found with burial number 3, the only artifacts found came from the midden. Among these discards were three types of stone axes; single and double groove encircling the head, and three-quarter groove. Manos were of two types: oval with two flat sides, and triangular. Similar grinding stones are in use among the Hopi today, each type serving a different purpose. Metates of fine-grained stone, of which three were found, are used with the triangular manos to produce the finest meal. Hammerstones, pottery polishing stones, pot lids worked from thin sandstone tablets, a pestle, wedge, an "arrowshaft straightener," two stone mauls, and a triangular piece of sandstone grooved at two corners and weighing about four pounds, were also found.

KIVA KT-II

A depression just southeast of KT-I proved on excavation to be a second kiva, which we designated KT-II (fig. 25 and pl. 21, fig. 2). The two ceremonial chambers are not exactly in line, however, since the southwest corner of the platform in KT-I is only 12 feet from the northwest corner of KT-II, while the southeast corner of the platform is 15 feet from the northeast corner of KT-II. This difference indicates that the kivas, though facing the southwest, varied as to the number of degrees, a condition frequently noted in structures of this type. The interval between the kivas was not examined, but from its size and position it is thought to contain a room.

In comparing the kivas only minor differences were noted. They are of the same type and approximately the same size, though KT-II

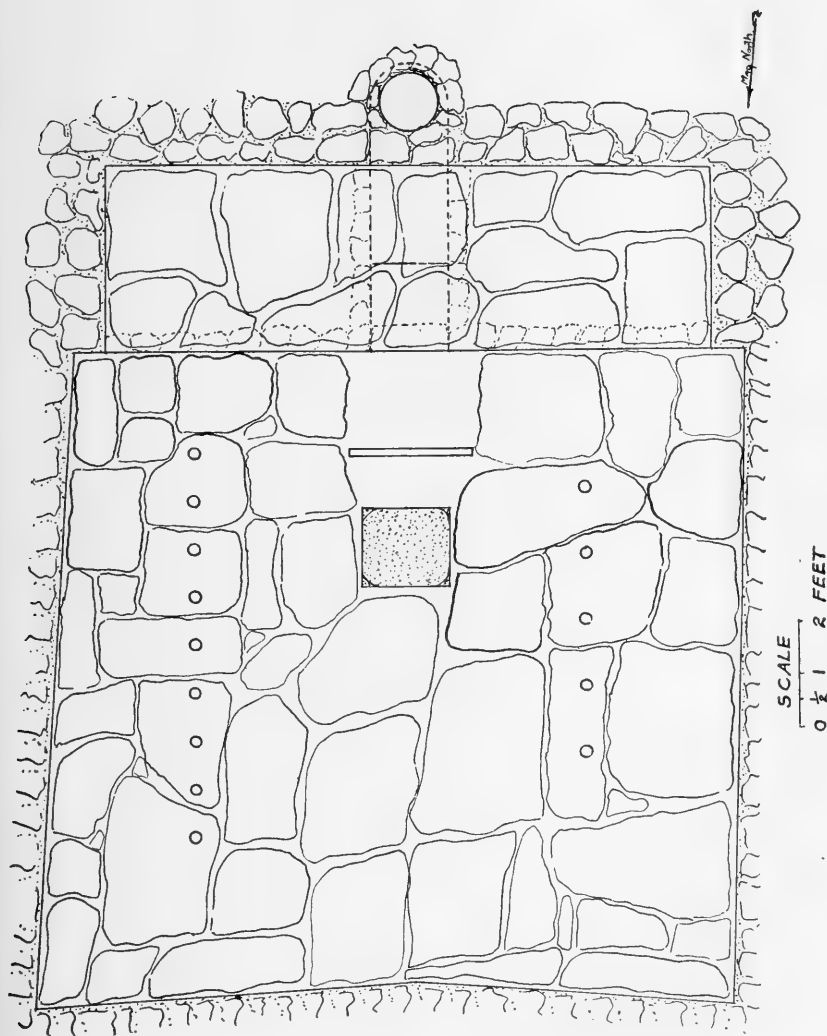

FIG. 25.—Plan of Kiva KT-II.

KT-II was constructed during the same year as KT-I and was probably built after the destruction of the former. It was far superior to KT-I both in workmanship and materials used. From a repair timber we know it was in use in 1285 A. D.

was not so deeply set into the ground. The masonry of KT-II is of the same type and material, but the method of construction is slightly different. The walls at the southeast and southwest corners of KT-II are joined together, but abut at the northeast and northwest corners where wedges were driven between to strengthen the walls (pl. 22, fig. 1). The tying of the walls in the two corners noted is well done and appears to have been intentional. All four walls are of masonry, plastered, and firmly constructed, contrasting greatly with the insecure walls of KT-I. The walls were straight and firm, with the exception of the north and south sides which were slightly bowed inward from pressure of the material against them.

The room floor consists of sandstone slabs of the same material and comparable in size to those in KT-I. On the east side of the floor are five holes, in line and averaging 11 inches from center to center. On the west side is another series of holes, averaging 15 inches apart. All holes are approximately $2\frac{3}{4}$ inches in diameter. That they were probably for the purpose of fastening loom frames to the floor is indicated by the fact that both series were immediately beneath roof beams running parallel with the series. The charred remains of these beams may be seen in the accompanying photograph (pl. 22, fig. 2). No evidence of a sipapu was found.

The roughly squared firepit is 3 feet $3\frac{1}{2}$ inches from the base of the platform, and is in line with the ventilator and deflector. The pit, 10 inches deep and lined with clay, is flush with the floor; its corners are rounded.

The deflector, a sandstone slab 1 foot $10\frac{1}{2}$ inches from the ventilator, is 1 foot 10 inches high, 2 feet $4\frac{1}{2}$ inches wide, and $1\frac{3}{4}$ inches thick. The top is slightly rounded and the base is firmly set in the floor.

As in KT-I, the ventilator entrance is in the front side of the platform, which lies 2 feet 6 inches above the floor. Across the bottom of this entrance, 18 inches wide by 23 inches high, is a sill 4 inches high; across the top, a sandstone lintel. The roof of the passageway had been composed of small twigs, placed close together and covered with adobe as in KT-I. Over this roof, which is 3 inches thick, are the flagstones of the platform. From front to back, the width of the platform is 3 feet 6 inches (fig. 25); the length of the passageway, including the base of the air shaft, is 5 feet 6 inches. The sides of the passageway are of masonry, and still show signs of plaster. In the passageway, 20 inches from the entrance, is a clay step 1 foot high. The floor is paved from the entrance to this step,

the remaining portion being of unplastered earth. The masonry walls follow the level of the floor, rising at the step and inclining slightly to the base of the air shaft which is D-shaped, with a diameter of 15 inches. Just above the base, the shaft is circular and 15 inches in diameter; its diameter decreases toward the top. No idea of the original height of the shaft could be ascertained since the south wall, against which the shaft was built, had collapsed, falling on the platform and breaking through the passageway.

Like its neighbor, KT-II was also destroyed by fire. Charred roof beams were on the floor and though they were for the most part completely burned, their position gives an idea of the arrangement of the roof. Three feet, one inch from the east wall was a pair of beams, each about 3 inches in diameter. Fragments of this pair were found at intervals for the entire north-south length of the kiva. Along the west side, 2 feet 11½ inches from the wall, was another pair of beams, also averaging 3 inches in diameter. These two pairs extended over the platform. In the middle of the kiva and parallel to those at each side was a third pair of beams, of approximately the same diameters as the others. Between these paired timbers were single poles but so completely burned that it was impossible to determine their spacing or diameter. Extending from east to west at intervals and resting upon the principal beams, were smaller logs, in pairs. One such pair lay against the north wall, while another pair crossed the kiva between the deflector and the platform. A third pair crossed the kiva about 2 feet north of the firepit. These last two pairs probably sustained the added weight around the entrance which, in kivas of this type, is in the ceiling over the firepit.

Evidence of the use of grass or brush in roof construction was found, but only in the northeast corner could the order be determined. Here was charcoal where the east-west timbers crossed the north-south beams; upon the latter was a charred mat of grass or twigs, covered with several inches of adobe. The clay of the roof was covered with wind-blown sand, through which were scattered a few potsherds, but the greater part of the depression between the fallen roof and ground level was filled with rocks from nearby walls.

Between the ventilator and the deflector, the only portion of the floor not paved with flagstones, were found three smooth stones, a large flint core, and a stone maul about 3 inches in diameter and 5 inches long with a groove encircling the middle. Between the deflector and the firepit were fragments of a corrugated olla, shattered by the fallen roof. The base of this olla lay near the firepit and still

contained pieces of small bones while part of the top and side was found in the pit. The only decorated pottery found on the floor were a few black-on-white sherds but as no two belong to the same vessel we assume they had weathered from the mortar of the walls. On top of the fallen roof, however, black-on-white sherds and other fragments of an unusual shade, somewhat between brown and orange, with black decoration were found mixed with the rocks and sand. Sherds from KT-II, in general, are the same types as those from KT-I.

DATING THE KIVAS

When selecting Kin Tiel for excavation it was hoped that a good selection of datable pine timbers would be recovered. The surrounding forests today consist almost wholly of piñon (*Pinus edulis*) and juniper (*Juniperus monosperma*) with here and there a lonely yellow pine (*Pinus ponderosa*). We may infer that comparable conditions obtained during the occupancy of Kin Tiel for, in the two rooms we cleared, only one pine timber was found and this, unfortunately, proved too complacent for dating. We may rejoice, however, in the fact that Doctor Douglass and Mr. Haury, concentrating upon the most promising of the material in hand, finally succeeded in determining the cutting dates of 27 piñon beams used in the two kivas.

Of this number, 13 were from KT-I and of these six were cut between A. D. 1264 and 1270; one in 1274; four in 1275; and two in 1276. The collecting of building material usually requires some time, at least among the Hopi, for never are beams plentiful in this region even since the advent of the telephone pole. My personal observations confirm this fact. We believe, therefore, that the building date of KT-I is 1276 rather than 1275 A. D., the year of preparation; that the earlier dates evidence re-use of timbers.

Of the 14 dated specimens from KT-II one was cut in 1266; one in 1272; nine in 1275 (four of these are from the same tree); two in 1276; and one in 1285. It is obvious from the grouping of these dates that the accumulation period was during 1275, and that KT-II was therefore probably constructed at about the same time as KT-I, sometime during 1276 A. D. It is a significant fact that KT-I had no timbers cut later than its supposed building date, which, in view of the unexpected collapse of the walls, suggests that it was destroyed soon after construction—probably when the summer rains saturated the sand walls. In contrast, KT-II was in use for at least ten years before its final abandonment, as is shown by the date 1285 which

doubtless marks a bit of repair. That the longer life of KT-II is due to better workmanship than that of KT-I is obvious from the manner in which the latter was destroyed. This, and the fact that both kivas were constructed during the same year, suggests that KT-II was built shortly after the destruction of KT-I.

SUMMARY

In brief, the season's work at Kin Tiel has contributed to southwestern archeology (1) by furnishing plans and details of construction of two kivas—the earliest of the Hopi type yet reported; (2) by determining the building dates of these kivas; (3) by showing the Hopi relationship of a pueblo that traditionally has been considered as Zuni; and (4) by securing new pottery types definitely associated with dated beams.

KOKOPNYAMA

The prehistoric Hopi Pueblo, Kokopnyama, lies 1 mile east of the Jeddito Trading Post, on the north side of Jeddito Valley and a few miles south of the Indian Agency at Keams Canyon, in central Navajo County, Arizona.

The Hopi mesas, of sandstone underlaid with shale, serve as natural water reservoirs while the broad valleys on either side are filled with alluvial deposits. Since the dip of the rocks is toward the south, numerous springs dot the south side of the mesas. In a desert region where permanent springs are few, such favorable conditions for permanent homes were eagerly sought by the aboriginal inhabitants and remains of their habitations are found in great number under the mesa rims. Though soil and water are the most important, other factors aided in making Jeddito Valley an important culture center in prehistoric times. The valley floor was green with herbs and grasses; the bordering mesas were covered with shrubs and timber (*Juniperus monosperma* and *Pinus edulis*). A few miles to the north and east were pine (*Pinus ponderosa*) and fir (*Pseudotsuga taxifolia*). Sandstone was available for building material; and deposits of clay and veins of coal were visible along the mesa slopes.

The earliest historical reference to the Jeddito Valley is included with an account of the discovery of Awatobi, visited in 1540 by Tobar and Cardenas with a small detachment from the Coronado Expedition.¹ Later explorers to visit this valley were Espejo in 1583. Oñate in 1598, and De Vargas in 1692.² In the first half of the 17th century

¹ Winship, George P., The Coronado Expedition, 1540-42. 14th Ann. Rep., Bur. Amer. Ethnol., 1896.

² Bull. 30, Bur. Amer. Ethnol., 1912, pp. 560-61.

a Franciscan mission was established at Awatobi and this thrived until its destruction during the Pueblo Revolt of 1680. In 1700 an attempt to re-establish the mission failed and Awatobi was destroyed by the irate inhabitants of some of the nearby Hopi villages.¹

Our first archeological reference to Jeddito Valley is from Victor Mindeleff,² who in 1882-83 devoted much time to mapping the larger ruins, of which there are five. These are all situated on the north side of the valley and are well known to all students of Pueblo archeology as Awatobi, Kawaioku, Chakpahu, Nesheptanga, and Kokopnyama. In 1892 limited excavations were made at Awatobi by the late Dr. J. W. Fewkes of the Smithsonian Institution,^{3, 4} who was followed, in 1907, by Dr. Frank Russell of Harvard.

With the exception of the survey made by Mindeleff, no archeological investigations were made at Kokopnyama until 1901 when Dr. Walter Hough of the Museum-Gates Expedition spent several weeks in the valley.⁵ In 1917 Spier, of the American Museum of Natural History, undertook a pottery survey,⁶ and in 1923 and 1926 Kidder made a stratigraphic test at Nesheptanga and surface examinations at other ruins.⁷ These are the archeological investigations made prior to the spring of 1928, when the writer determined a pottery sequence for Pueblo IV ruins in the Hopi country.

GENERAL DESCRIPTION

A surface survey of Kokopnyama reveals a ruin about ten acres in area with architectural features not unlike those of modern Hopi pueblos, if recent influence in the latter is disregarded. The general plan is essentially the same with house groups two or more stories in height surrounding open courts. Middens often contain pottery types of different periods. From this condition we surmised that new structures were erected in unoccupied portions when a building had become unsafe for living. Later investigations confirmed this supposition. This shifting back and forth of buildings as decay set in is found at the older inhabited Hopi towns. Having previously deter-

¹ Bull. 30, Bur. Amer. Ethnol., 1912, p. 561.

² 8th Ann. Rep., Bur. Amer. Ethnol., 1887

³ Hough, Walter, Ann. Rep., U. S. Nat. Mus., 1901, p. 333.

⁴ Fewkes, Jesse Walter, Expedition to Arizona in 1895. 17th Ann. Rep., Bur. Amer. Ethnol., Pt. 2, p. 592.

⁵ Ann. Rep., U. S. Nat. Mus., 1901, pp. 279-358.

⁶ Spier, Leslie, An outline for a chronology of Zuñi ruins. Anthropol. Papers, Amer. Mus. Nat. Hist., Vol. XVIII, pt. 3, New York.

⁷ Kidder, A. V., Southwestern archaeology.

mined the sequence of Hopi pottery types, it was easy to select that part of the ruin where beam material of the desired age might be found. Only the presence or absence of charred or decayed pine would affect the success of our 1929 work.

The accuracy of Mindeleff's survey of the site was confirmed through several tests, and having definitely located a point in the ruin corresponding to a known point on his map, we established a permanent benchmark. From this point a base line was run through the ruin. At convenient points cement monuments were erected from which all tests and excavations were accurately plotted.

After selecting a section to be worked, it was found that Mindeleff had considered only well-defined room outlines, probably considering the talus on the mesa slope to be fallen walls from rooms above. Tests along the slope, however, revealed midden-filled rooms with *débris* containing sherds of late Pueblo III and early Pueblo IV types. The greater part of the pueblo occupied in late Pueblo III and early Pueblo IV is then found to be outside of the ruin as mapped by Mindeleff, the heavy lines outlined by him giving a fair idea of the area occupied in late Pueblo IV (fig. 26).

DWELLING ROOMS

The distinctive characteristic of Kokopnyama masonry is the poor quality of stone used. This material, Mesa Verde sandstone, is friable and easily "blocked," but is unfit for "dressing." Also, because of its softness, this stone is readily affected by weathering, which accounts for the crumbled condition of exposed walls although Kokopnyama is much more recent than many ruins of the Southwest whose walls, excellently preserved, are constructed of more durable stone.¹ Clay used for mortar was dug from shale beds within the Mesa Verde sandstone formation, and occurs in quantities under the mesa rim.

Of the rooms we opened all vary somewhat in size (fig. 27). The normal thickness of walls is about 12 inches, though walls 24 or more inches in thickness are not unusual where strengthening measures were found necessary. No orderly arrangement of blocks was found, both large and small stones being used at random; nor was any attempt at coursing apparent in those walls examined. The granular surface of the walls was protected by coats of natural, yellow-clay plaster—as is common today among the Hopi. Plastering seems

¹ 22nd Ann. Rep., Bur. Amer. Ethnol., 1904, p. 134.

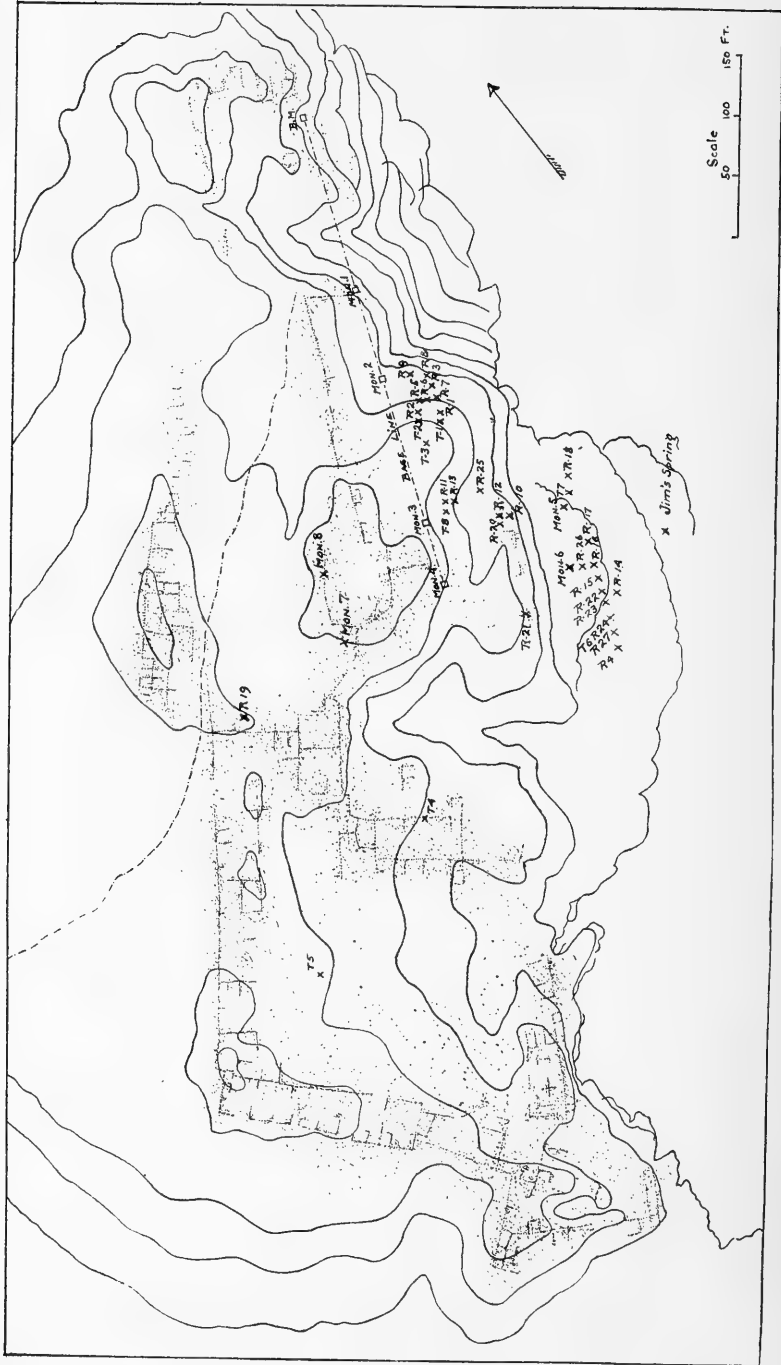

FIG. 26.—Plan of Kokopnyama.

Reproduced from plate VII, 8th Annual Report, Bureau of American Ethnology, but modified to indicate test holes and excavated rooms of the Third Beam Expedition. The outline of the village, as drawn by Mindeloff, is an excellent plan of the pueblo during Pueblo IV, Pueblo III dwelling rooms and Pueblo IV kivas being found on the slope below the mesa top. Of forty-two beams dated, the earliest cutting date is 1269 A. D.; the last date is 1430 A. D.

to have been confined to the interiors of rooms at Kokopnyama, however, and though some Hopi dwellings with plastered exteriors are found, they are few—the practice having been introduced into this

Size of Rooms

<i>Rooms</i>	<i>Length</i>	<i>Width</i>	<i>Depth</i>	<i>Door</i>	<i>Cache</i>	<i>Firepit</i>	<i>Mealing bin</i>
R-2	11' 9"	8' 2"			Yes		
R-3	6' 9"	6' 7"		Yes			
R-6	6' 6"	5' 2"					
R-7	7' 1"	4' 8"					
R-8	7' 4" 6' 10"	5' 6" 5' 4"					
R-9	8' 4"	6' 9" 6' 6"	5				
R-10	10' 8' 6"	6' 1"				Yes	
R-10a	8' 6"	6' 1"		Yes			
R-11	6' 10"	6' 6"	4' 3"	Yes	Yes		Yes
R-13	6' 6"	4' 6"					Yes
R-13a	?	?	5' 6"				Extends under R-11
R-14	11' 4" 12' 9"	9' 2" 8'					
R-15	9' 1" 9'	7'			2		
R-16	6' 11"	3' 10"					
R-17	8'	8'					
R-18	10'	9' 6"			Yes	Yes	
R-9a	8'	8'					
R-21	5'	5'					
R-22	11'	7' 9"					Yes
R-25	14'	7' 6" 8'	6				

FIG. 27.

region within recent years. Decoration of walls with painted designs, or with incised drawings was not found, though incised stones were found detached from the walls. Both methods of decoration have been found at Kawaioku, a nearby ruin occupied at the same time as

Kokopnyama, where Hough records a wall elaborately decorated in color,¹ and the writer found geometric designs scratched upon the wall plaster of a kiva.

DOORS

We found only seven doors, a surprising fact considering the number of rooms opened. But when it is realized that until a few years ago practically all entrances to first floor rooms of historic Hopi pueblos were made through the roof, this condition will be understood. Even today in Oraibi, the oldest inhabited Hopi village, many rooms now partly buried by accumulations of sand and débris are still entered in this manner. There is hardly a room, either above or below ground, in Oraibi or villages on the Second Mesa, that at some time

Doorways

Room	Type	Width	Height	Above floor	Lintel	Width offsets		Height offsets		Remarks
						Left	Right	Left	Right	
R-3	Rect.	1' 7"	2' 2"	2' 6"	Sticks					
R-10a	Square	1' 9"	1' 9"	-6"	Stone					
R-11	Rect.	1' 6"	2' ½"	—	Sticks					Base of door is floor level.
T-1	"	1' 4"	2' —	1' —	"					
R-23	?	1' 4"	?	2' 7"	?					Partly destroyed.
R-25	T-shape	2' 2"	3' 4"	2' —	Stone	-6"	-4½"	1' —	1' —	

FIG. 28.

the writer has not been permitted to enter. It was observed that in old dwellings on the ground floor which have for years been used for storage, entrance was usually made through the ceiling. The doorways at Kokopnyama were square to rectangular, or T-shaped. Dimensions in all vary (fig. 28). Lintels were either of split juniper sticks about 1½ inches in diameter set in adobe mortar, or of sandstone slabs.

CACHES

Caches used both for domestic and ceremonial purposes were found and the interiors of all were plastered. In some caches, corners were rounded with plaster and sometimes emphasized until the cache was

¹ Archeological Field-Work in Northeastern Arizona. The Museum-Gates Expedition of 1901. Ann. Rep., U. S. Nat. Mus., 1901, pp. 279-358.

oval or even circular while in others rounding was limited to the upper rear corners, producing an oval top. More often the lintel was a sandstone block of the wall masonry (fig. 29), but an exception is found in Room 11, where a cache is roofed with small sticks set into adobe after the manner of door lintels. Time has proved the strength of roofs made from adobe and wood, and it is not surprising that this knowledge should be used where a substantial covering for an opening is needed whether large or small.

Caches

Room	Above floor	Width	Height	Depth	Plastered	Lintel	Wall	From corner	Remarks
R-2	1' 5"	—6"	—6"	—6"	Yes	Stone	N.	4' 9"—N. E.	Circular
R-11	2' 6"	—8"	—7"	1' 1"	Yes	Sticks	W.		Near middle of room.
R-15	2' 3"	—8"	—7½"	—8"	Yes	Stone	S. E.	7½"—S. W.	Slightly rounded.
R-15	2' 3"	—9"	—7½"	—8"	Yes	"	S. E.	4' 9"—S. W.	" "
R-18	1' —	—5"	—4"	—6"	Yes	"	N. W.	4"—N.	No depth at top. Slopes backward and down to bottom.
R-23	2' 1"	—7"	—6"	—5"	Yes	"	N. W.	3' 6"—N. W.	D-shape. In kiva.
R-23	?	?	?	?	Yes	?	N. W.	?	No measurements.
R-24	—	1' 6"	2' 7"	1' 3"	Yes	Stone	N. W.	7"—N. W.	Top oval. Slopes down ward.
R-24	—8"	—6"	—5"	—8"	Yes	"	N. W.	2' 10"—S. W.	D-shape. Base flat. In kiva.

FIG. 29.

FLOORS

Floors were of clay, with the exception of those in kivas and in Room 10 which were of stone, and were found in all rooms, whether on bedrock or midden fill. These floors were easily identified by their smoothness, hardness, and thickness which varied from one to several inches.

FIREPITS

Nothing characteristic was noted in clay floors, except the position of the firepit, which was invariably in a corner, or against the wall 2 or 3 feet from the corner. This position does not apply to kiva

fireplaces, which will be discussed later. Firepits were made with sandstone slabs set below the floor surface and plastered, or by plastering the sides of a hole within the floor itself. Dimensions vary, as shown in the accompanying table (fig. 30).

Firepits

Room	Length	Width	Depth	Sides	Corners	Remarks
R-10	1' —	— 11"	— 8"	3 of Clay 1 of Stone	Slightly rounded	
R-18	1' 2"	1' 2"	?	Clay	Rounded	Against S. E. wall 4' 7" from S. W. wall.
R-19	1' 2"	— 10"	?	Clay	Slightly rounded	In N. W. corner.

FIG. 30.

MEALING BINS

Mealing bins were found in approximately the same position as firepits, *i. e.*, against the walls, but confusion in identity is not likely since firepits are usually lined with clay, contain ashes and extend below the surface of the floor, whereas mealing bins are not lined with clay, contain no ashes, and are built above the floor. In two rooms bins were found in the corner, the walls serving for two sides of the bin, while in one room a bin was constructed against the south-west wall, 4 feet from the nearest corner. All mealing bins found were larger than the firepits (fig. 31).

Mealing Bins

Room	Length	Width	Depth	Below floor	Number sides	Remarks
R-13	1' 10"	1' 3"	1' 4"	— 1"	2	In N. W. corner, two walls serve as sides.
R-19a	1' 9"	1' —	— 9"	No	3	N. E. wall 1' 6" from S. E. wall.
R-22	2' 3"	1' 5"	1' —	No	3	Along S. W. wall about 4" from S. E. wall.
R-11	2' 4"	1' 4"	— 11"	— 1"	2	In S. E. corner two walls serve as sides.

FIG. 31.

CEILINGS

Roof material was found in a number of rooms, but usually in such a poor state of preservation and in such small quantities that

only a faint idea of the ceiling arrangement could be inferred. Rooms 9 and 11 are the exceptions. In Room 9 the ceiling was so perfectly preserved that every step in construction was clearly defined. This room is of average size, which increases the value of the illustration, permitting the use of this roof as a typical example of those for house dwellings. In a north-south direction were two large beams of juniper and piñon of 6 and 4 inches diameter, respectively, supporting a framework of three small poles. These latter, averaging about 3 inches in diameter, were approximately 12 inches apart and were near the middle of the room (fig. 32). Many pieces of split juniper were placed between the east-west cross-poles, thus forming a ceiling upon which brush or grass was laid. The roof was finished with a layer of adobe. Beam holes in the walls naturally vary in size according to the diameter of the beams used. Only the beams were imbedded in adobe pockets in the walls, the split juniper sticks extending to the wall surface. From the beams to the room floor was 4 feet 4 inches; or, if one includes the diameter of the main beams, the ceiling height would be 4 feet 10 inches. As there was no door through the walls, the entrance must have been through the roof at the east end, the only side not covered by the roof when excavated.

The ceiling of Room 11 was largely destroyed by fallen rocks, but fully one-third remained in such excellent condition that comparison with the roof in Room 9 revealed the same kinds of material and same method of construction.

KIVA R-4

The best preserved kiva we found at Kokopnyama is indicated on the map as R-4, and may be seen in plan on figure 33. The kiva is built facing southeast on a sandstone ledge just below the mesa rim. There was little or no soil on the ledge, but the section was once covered by earlier house structures, the tumbled walls of which were sufficiently deep to favor the building of a kiva. This location is similar to that of many present-day Hopi kivas, and is in keeping with the current Hopi custom of building their ceremonial chambers on a lower ledge, if sufficient depth of soil cannot be found on the ground level.

Three sides of kiva R-4 were covered either by abandoned rooms or household débris but the fourth was exposed, being built on the edge of the ledge. The greater part of the southeast wall had weathered away but the remaining portion of the platform was easily recognized and provided a starting point for excavating the kiva. Above its fallen roof the chamber was filled with fallen masonry through which were occasionally found potsherds of Jeddito black-on-yellow and

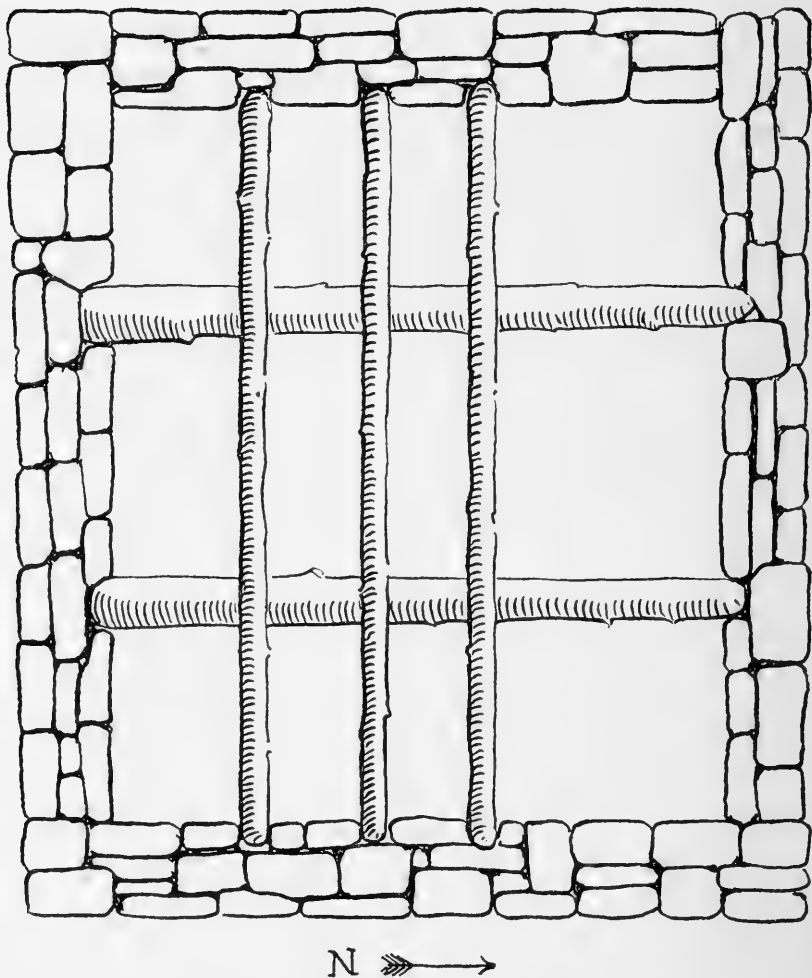

FIG. 32.—Diagram of roof structure in R-9.

Sikyatki polychrome. There is no reason to believe that the kiva became a refuse dump after it ceased to serve for ceremonial purposes since the sherds were too few and scattered, and were not always associated with ash deposits. It is believed these sherds were included in the roofing clay.

That the kiva was used after it was abandoned for ceremonial purposes, however, is clear, for the rear had been made into a small dwelling or storage room, by building in a cross wall, partitioning an area approximately 10 by 6 feet. The floor of this small room was 5 feet above that of the kiva and was made by leveling the accumulations of fallen wall masonry that lay beneath it. The northwest and southwest walls of the kiva were utilized in the smaller room, though an auxiliary wall was built against and parallel to the northwest side. These later walls were of inferior construction and were built of irregular sandstone blocks, chinked with smaller pieces of the same material set in thick clay mortar.

All walls of the kiva were of roughly shaped sandstone blocks averaging about 4 by 10 inches, and were set in thick mortar as in the walls of dwelling rooms, which only differed from kiva walls in that they were thinner and built of smaller stones. The kiva walls were heavily plastered, there being 32 coats on the northeast wall, the 29th of which was red. In the northwest wall, 4 feet 9 inches from the northeast side and 3 feet 7 inches above the floor, was a badly decayed wooden peg set in a hole approximately $2\frac{1}{2}$ inches in diameter. In the southwest wall and near each end, had once been two more pegs of about the same size and distance from the floor as that noted. Only small pieces of the decayed wood were found in these holes. It is presumed that these pegs were for hanging ceremonial paraphernalia or other objects, as in modern Hopi kivas.

Originally, the kiva was much larger than at the time of abandonment. On two separate occasions its dimensions were reduced by strengthening walls (fig. 33). The original dimensions of the kiva room, exclusive of the platform, were approximately 14 feet 6 inches, by $11\frac{1}{2}$ feet. The back of the kiva, or the northwest wall, originally was the plastered face of a midden, in which the kiva had been partly excavated, and apparently served for several years since it was plastered four times. That the "midden wall" weakened is indicated by a slight bow in the middle, which was strengthened by building against it a masonry wall about 8 inches in thickness which was in turn further strengthened by a second masonry wall constructed at a point 3 feet 5 inches from the "midden wall," and ingeniously arranged with a

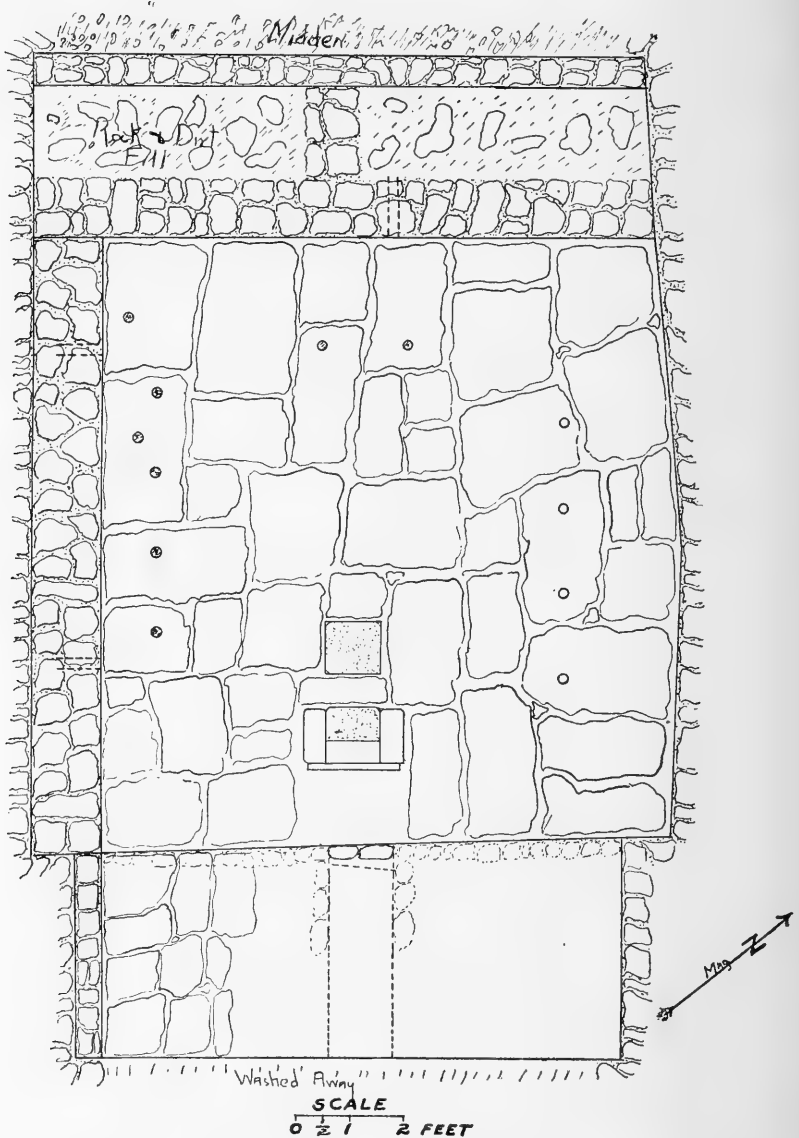

FIG. 33.—Plan of Kiva R-4.

When first constructed, the rear wall of R-4 was the plastered face of a refuse heap, like KT-I at Kin Tiel, and threatened another disaster which was timely averted by an ingeniously arranged brace wall. No datable beam material was collected.

brace wall of stone between it and the first masonry wall, the intervening space being filled with loose rocks and earth (fig. 33 and pl. 23, fig. 1). This was the northwest wall of the kiva when it was abandoned. Under the plaster coats, of which there were several, and imbedded in the mortar of the wall were two sherds of Jeddito yellow ware. One of these was an undecorated surface, while the other was an excellent example of Jeddito black-on-yellow. The northwest wall showed no further evidence of weakening, but the southwest wall eventually weakened, and was reinforced by building another masonry wall against it. The new southwest wall is 20 inches thick and wider than the offset on the southwest side by 5 inches.

A comparison of the various sizes of the kiva at different periods of remodeling may be made from figure 33. On the northeast side the offset is 11 inches. After the construction of the new wall on the southwest side there remained only the offset on the northeast, but by removing some of the masonry of the new wall the original size of the offset on the southwest side was found to be 15 inches. Originally the platform was 9 feet 10 inches long, but this length was reduced 5 inches by extending the extra width of the auxiliary southwest wall across the end. The platform is 3 feet 10 inches wide, and its floor is 21 inches above the floor of the kiva room. Though the southeast wall is missing to the level of the platform floor, the platform walls and face are of similar material and construction to the walls of the kiva room. The kiva, being on a ledge below the mesa top and surrounded on three sides by tumbled walls, was constantly subject to erosion from the slope above. As a result of this action the southeast ends of the kiva walls were reduced on the sides of the platform to only a foot or two high, and the southeast wall was reduced to the top of the platform. At the top of the wall in the northwest corner were two layers of masonry extending for several inches over the plastered wall of the midden excavation, and since the depth of the kiva at this point is 8 feet 4 inches, it is probable that this represents the original height of the kiva. The height of the kiva at the northwest corner of the present end wall is 7 feet 8 inches, but the weathered slope of the walls from beyond this point to the southeast wall indicates that the original height of the kiva was greater.

The floor was covered with flagstones of varying sizes, with the exception of the space between the ventilator entrance and the deflector, which was of hard packed rock and earth. As noted in the kivas at Kin Tiel, this space represents the hole dug in setting up

the deflector. About 6 inches below the level of the kiva floor in the earth and rocks, was found a Jeddito black-on-yellow sherd. The platform also was originally paved with flagstones but several were removed by our Indian workmen before the error was discovered. The only flagstones now remaining on the platform are at the southeast end. On the floor of the kiva 2 feet from the northeast wall and 3 feet from the base of the platform, is a line of four holes with an average diameter of 2 inches, which are 19 inches from center to center. The belief that these holes were used in weaving is supported by finding two "loom blocks" in the kiva (pl. 23, fig. 1). These blocks are of sandstone and are about $11\frac{1}{2}$ inches long, 8 inches wide, and $6\frac{1}{2}$ inches thick. Sandstone blocks similar to these, but longer, and with hand holds pecked in each end are found in modern Hopi kivas where their uses also vary. At the present time so little weaving is done that they are used primarily for seats. On the southwest side is another line of four holes, 4 feet 1 inch from the platform, and 1 foot from the southwest wall. These holes are slightly larger than those on the northeast side, being $2\frac{1}{2}$ inches in diameter, and are 18 inches from center to center. All holes on the southwest side were plugged with clay, which may be accounted for by their nearness to the southwest wall which was constructed after the kiva floor had been laid. Two other holes on the same side, and near the holes in line, were also plugged with clay, indicating that when the kiva was abandoned none of the holes on this side were being used. In the rear of the kiva and parallel to the northwest wall were two more holes, 2 inches in diameter, that were likewise plugged with clay. The position of these holes—2 feet from the northwest wall and almost in line with the firepit and deflector—made it appear that one of them might have been the sipapu, but this could not be definitely determined.

The deflector is a sandstone slab $1\frac{1}{2}$ inches thick, 20 inches wide, and standing 16 inches above the floor. The top was rounded into an arc. Seventeen inches from the ventilator entrance, the deflector was set 9 inches into the floor. An interesting feature of the deflector is its relation to a firepit of which it was part. At each side of the deflector was built an arm of sandstone and adobe that extended at right angles to the deflector, the whole resembling an arm-chair without legs (pl. 23, fig. 2). Each arm is 12 inches long, 5 inches wide, and 7 inches high. Between the arms is a peculiar firepit—peculiar in that it has two floor levels, the first level with the floor, the bottom being a sandstone slab, the two arms and the deflector serving for three sides; the fourth side is open. Five inches from

the deflector and parallel with it is a pit 12 inches long, $7\frac{1}{2}$ inches wide, and 10 inches deep, the bottom of which forms the second level of the firepit. This deeper part is filled with ashes, but its exact function is not known.

A second firepit $6\frac{1}{2}$ inches from the one described (pls. 23, fig. 2, and 24, fig. 1) is 12 inches square and 13 inches deep. There is nothing unusual about this pit, which was clay lined with hand rounded corners, and in line with the first firepit, the deflector, and ventilator. Like the first firepit it was fitted with a sandstone cover, and was filled with wood ashes. The top is level with the floor.

Near the center of the platform is the entrance to the ventilator, which is 14 inches square. Over the top, and sustaining the weight of the platform floor is a lintel of sandstone slabs set in mortar. The bottom of the lintel is a single slab, upon which are two shorter slabs, placed end to end. From the platform to the bottom of the lintel is 7 inches. The length of the passageway is not known since it is partly eroded near the southeast wall; it probably extended through the platform as in the kivas at Kin Tiel. The length of the part remaining is 3 feet 2 inches. For 7 inches back from the entrance, the floor of the passageway is formed of a sandstone slab; but at a point 5 inches from the entrance there is an upright slab 11 inches high, behind which were found several lumps of red paint, two manos covered with paint, two hammerstones, half of a Jeddito yellow bowl containing fragments of small bones, and a piece of chert, all of which were on the sandstone floor which extended about 6 inches beyond the upright slab. Covering these artifacts and reaching to the top of the upright slab was an unsmoothed floor of clay that gradually sloped upward and back to the end of the passageway. Between the level of the upright slab and the roof of the passageway was a distance of 6 inches. Though it could not be definitely determined that the upright slab with the clay behind it was a step reducing the height of the passageway, as found in the kivas at Kin Tiel, still there is a remarkable similarity both in principle and execution. The presence of the artifacts behind the slab and beneath the clay floor might, however, indicate that the slab or "step," was at one time farther back in the passageway—at the end of the sandstone floor possibly—if there was an abrupt change in the floor level. Owing to erosion, conditions near the rear of the passageway were unfavorable for accurate notations. The floor of the platform was broken over the passageway by the fallen roof of the kiva, but enough of the passageway roof remained intact to show the order of construction, which was

the same as that noted in the kivas at Kin Tiel, namely, a layer of small sticks across the passageway covered by a thick layer of adobe. In order to examine the interior of the passageway, however, it was necessary to remove the broken floor, but after completing the investigations the floor was replaced and the eroded section of the platform rebuilt. In addition to this repair the walls were strengthened by replacing with cement part of the adobe mortar between the blocks. Pressure from débris against the outside of the wall was partly relieved by removing much of the material, and drainage was provided by trenching around the sides. No provision was made to drain the interior of the kiva, since a crack in the bottom of the pit by the deflector was thought to be large enough to carry off rainwater. It is planned to make more permanent repairs at a later date.

A number of beam specimens were collected, but since the kiva was not burned and conditions were unfavorable for preservation, they were too badly decayed to give a comprehensive idea of the roof construction. All specimens were either piñon, juniper, or cottonwood, and at the time of writing none of the specimens has been dated.

KIVA R-27

The northeast wall of Kiva R-4 was the southwest wall of another room, R-27, which when partly opened proved to be another kiva. Due to lack of time this latter was not completely excavated, though sufficient material was removed to reveal the deflector and edge of the platform.

KIVA R-24

Previous to the discovery of Kiva R-27, another kiva, R-24, was opened and studied (pl. 25, fig. 1). Both R-24 and R-27 are on the sandstone ledge with R-4, and all face in the same general direction. As was shown in the case of R-4, kivas on the ledge are most susceptible to erosion at the southeast end, so it was not surprising to find that only the face of the platform remained intact. The weathering of the slope had reduced the walls at the edge of the platform to 15 inches in the northeast corner, and 2 feet 6 inches in the southeast. Though complete notes could not be taken at this end of the kiva, the ventilator passageway remaining showed evidence of having been roofed with sticks and adobe, while the entrance to the ventilator was covered with a sandstone lintel.

Walls were of the same material and construction as those in R-4, and were heavily coated with plaster, being about $1\frac{1}{2}$ inches thick.

The northeast wall was 10 feet 4 inches long as contrasted to 11 feet 2 inches for the southwest wall. The same lack of consistency was found in the length of the northwest wall and the corresponding width of the kiva between the walls of the platform face. The height of the kiva could not be determined, though those corners with less evidence of erosion are the northwest and southwest, which are 6 feet 10 inches, and 6 feet 2 inches respectively from the kiva floor to the top of the remaining walls. The vertical side of the platform is of masonry and extends to the side walls, but on account of the weathered condition it could not be determined whether there were offsets between the platform and walls.

In the northwest wall are two plaster-lined caches. The first of these is 7 inches from the northwest corner, and on the same level as the base of the cache and floor of the kiva. The height of the cache from the floor to the middle of the top, which is an arc, is 2 feet 7 inches. The depths and widths at the top and bottom differ. The bottom is 18 inches wide, the top 11 inches at the floor level, the depth 15 inches, while the top is oval and slopes downward toward the rear and base of the cache. An unusual arrangement in this cache is a shelf, 17 inches above the floor, composed of three cross sticks of split juniper about 1 inch in diameter upon which rest two sandstone slabs, one upon the other, the thickness of the shelf being about 3 inches. On the floor of the cache was found a large piece of gypsum. The second cache is at the opposite end of the northwest wall, 2 feet 10 inches from the southwest corner. It is D-shaped with the flat side at the bottom, which is 8 inches above the floor of the kiva. The cache is 6 inches wide, 5 inches high, and 8 inches deep. Within the cache was a quantity of red paint.

The floor of the kiva was paved with sandstone slabs, except between the deflector and the ventilator, where it was of clay; many of the flagstones were smeared with red paint. The writer has never heard of kiva floors being painted, and from the quantity of red paint found in the cache, he leans to the belief that possibly the sandstone flags of the floor were used for powdering the lump paint. Along the northeast side of the floor, and 18 inches from the northeast wall, was found the usual line of holes drilled into the stones of the floor. These holes were four in number, each with a diameter of $2\frac{1}{2}$ inches, and averaging 17 inches from center to center. On the southwest side was another line, also of four holes, 1 foot 3 inches from the southwest wall; 1 foot 5 inches from center to center; and averaging 2 inches in diameter. These holes on the southwest side were

plugged with clay, as were also two other holes between the first hole of the line and the firepit (fig. 34). The firepit might be said to be in line with the deflector and ventilator, though it does not "center" as in other kivas, the northeast side of the pit being almost in line with the northeast edge of the deflector. The firepit is 4 feet from the northeast wall and 18 inches from the deflector; is 10 inches square with slightly rounded corners, and 18 inches deep. It was filled with wood ashes. Over the top was a sandstone cover 1 foot square. The deflector was 18 inches from the ventilator entrance, or midway between the ventilator and firepit. As in other kivas described from this ruin, the deflector was a sandstone slab set firmly into the floor. There was a decided lean toward the platform, however, which might have been caused by the falling roof. The deflector was 1 inch thick, 21 inches long, and 18 inches from the floor to the top. The corners were rounded. On the northeast side of the deflector was a loom block, while another was found near the southwest corner of the room. Beneath the fallen roof and scattered on the floor near the deflector and firepit were fragments of Jeddito black-on-yellow and Jeddito corrugated ware.

In the southeast corner of the room and buried beneath the floor was found a cache of two Jeddito black-on-yellow ollas. Both were filled with a coarse sand identical to sand found on ant-hills of the region. Inquiry among the Hopi, however, failed to verify the belief that sand from ant-hills was used for ceremonial purposes, as the discovery seemed to indicate. Both ollas were neatly protected by a sandstone cover beneath the flagstones of the floor.

KIVA R-23

It will be noted that all kivas heretofore described in this paper have been of the Hopi type, and the consistency in plan and orientation would lead one to expect all other kivas of the same period and region to be of the same arrangement. This was found not to be the case, however, for on excavating the room northeast of R-24, a kiva was disclosed that differed greatly in several details. This kiva, R-23 is rectangular (fig. 35), faces north, and has no platform, all of which are radical changes; other departures from the usual arrangement will be noted in order. The material and construction of the walls is essentially the same as others described and the floor was paved with flagstones. This kiva, also located on the sandstone ledge below the mesa top, is therefore subject to erosion, and on account of the orientation, the southeast side was affected more than that in the other two

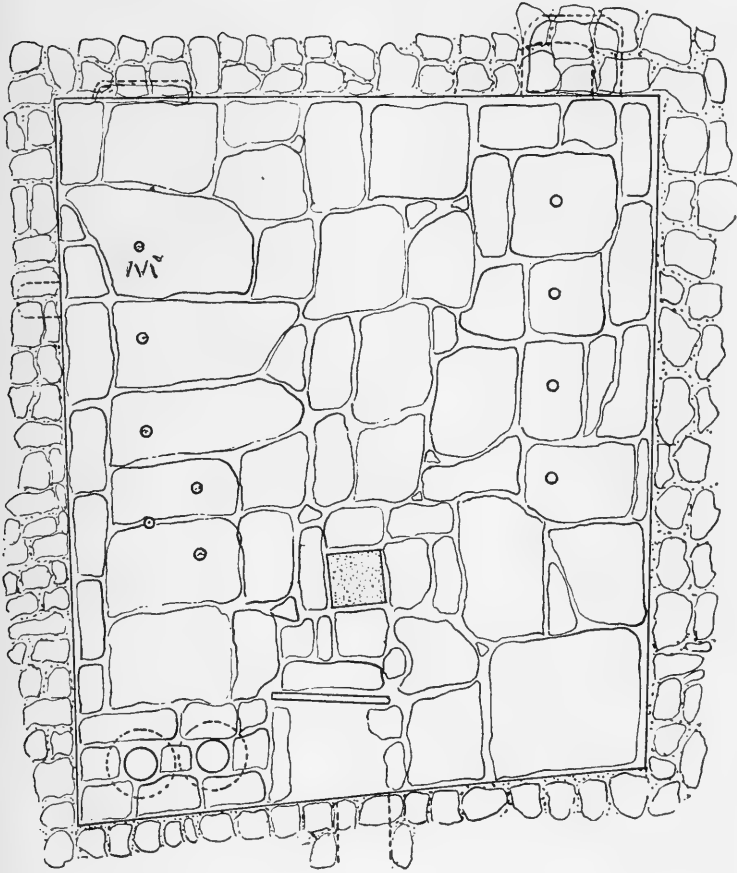

SCALE

0 1/2 1 2 FEET



FIG. 34.—Plan of Kiva R-24.

Beneath the floor of R-24 were found two Jeddito black-on-yellow jars filled with coarse sand which was probably reserved for ceremonial purposes. In the rear wall were two caches which are said by the Hopi to have been used in the Bean Ceremony. Kiva R-24 was constructed in 1380 A. D.

kivas, resulting in the complete destruction of the southeast wall and part of the flooring on that side. The northeast and southwest walls were also partly destroyed at the southeast ends, so that complete measurements could not be taken. The remaining portions of these two walls are 8 feet 2 inches, and 7 feet 10 inches respectively. The northwest is complete, though badly bowed from the weight of the débris on the outside, and is 10 feet 3 inches long. With the tops of the walls weathered, the ceiling height of the kiva could not be determined, though it is known to have been more than 4 feet 9 inches as determined from the present height of the walls in the northwest corner. In the northwest wall, 3 feet 6 inches from the northwest corner of the room, is a D-shaped cache 2 feet high, 1 inch above the floor. The cache is 7 inches wide, 6 inches high, and 5 inches deep. In the floor of the kiva, 3 feet 6 inches from the northeast wall, 1 foot 3 inches from, and parallel to the northeast wall, are four clay-plugged holes, 2 inches in diameter, and averaging 1 foot 5 inches from center to center. Three feet 9 inches from the northwest wall, and 3 feet 8 inches from the northeast wall is the sandstone deflector, $1\frac{1}{2}$ inches thick, and 18 inches wide. The height of the deflector is not known since the deflector was broken off 9 inches above the floor, nor could the missing top be found.

One foot 7 inches from the deflector and near the center of the kiva is a firepit of plastered sandstone slabs, with slightly rounded corners (pl. 26, fig. 1). The northwest side of the pit is 10 inches long, the northeast side is 12 inches; the other two sides correspond in length to their opposites. The depth is 21 inches. Between the deflector and the northeast wall is another firepit which lacks the regularity of the former. The southeast corner of the pit is 6 inches from the deflector as contrasted with 3 inches from the southwest. A better idea of the shape and position may be gained by referring to figure 35. The dimensions are 17 inches for the southwest side, 11 inches for the northeast, 12 inches for the northwest, and 10 inches for the southeast. The sides are of sandstone slabs, plastered and with slightly rounded corners. For a depth of 6 inches from the top of the pits, and level with the floor of the kiva, was wind-blown sand under which were ashes. Lying on top of the wind-blown sand in the second firepit were Jeddito black-on-yellow and Sikyatki polychrome sherds.

The ventilator is not as truly aligned with the deflector or firepit as in R-4 and R-24, nor does it conform specifically with other ventilators examined in Hopi type kivas. The entrance to the ventilator is in the face of the northeast wall 3 feet 6 inches from the northwest wall, and was originally 8 inches wide but has been reduced in width by partly filling the opening with clay. It is 9 inches high, 5 inches

deep, and is roofed with sticks covered with clay. The base of the entrance and passageway is level with the kiva floor, and is of clay (pl. 26). This short passageway—if it may be so termed—is built into the masonry wall of the kiva and connects with a circular airshaft 6 inches in diameter that extends upward at right angles to the passageway. The airshaft is a hole running vertically through the middle of the wall from the ventilator passageway to the remaining top of the wall, which is 3 feet above the floor of the kiva. The airshaft is strik-

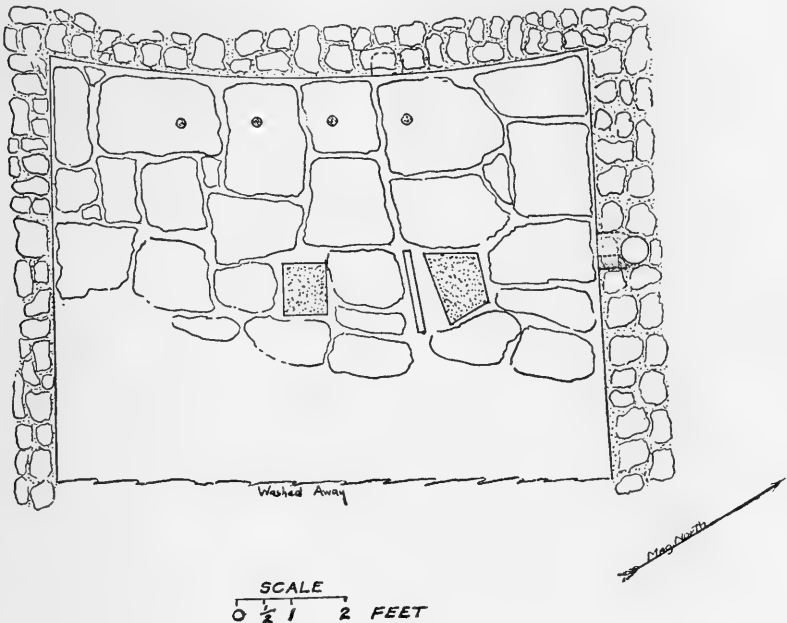

FIG. 35.—Plan of Kiva R-23.

Kiva R-23 is the only kiva excavated in which the ventilator is on the north side. In this instance the entire passageway and airshaft are within the north wall. From among the coals in the firepit a datable specimen gives the year 1416 A. D.

ingly like an ordinary flue. In a small midden-fill on top of the roof clay were sherds of Jeddito black-on-yellow and Sikyatki polychrome.

Further investigations of conditions concerning this kiva might determine it to be the rear of an abandoned kiva remodeled for ceremonial purposes, or another type of kiva used contemporaneously with the Hopi type. It is possible that the northeast and southwest walls can be followed along their bases for a sufficient distance to settle this question. It should be remembered, however, that the principal object of our limited excavations was search for beam speci-

mens, so the writer could not always investigate conditions as thoroughly as he would have liked.

BEAM SPECIMENS

As has been previously stated, the primary objective of the expedition was to secure datable beam material. With this in mind Kokopnyama was examined in 1928 and, though the site proved prolific in the desired pottery types, little hope was felt for the discovery of pine timbers, since the predominating woods today are juniper and pinyon. Our activities were, therefore, directed to Showlow where pine trees were still growing within a short distance of the ruin, and where previous examination had revealed that the ruin was destroyed by fire and pine charcoal was abundant.

After the memorable discovery of HH-39, which "bridged the gap," my attention was directed to the less favorable Hopi country in hope of substantiating the Showlow results from a widely separated district. The chance was admittedly slim since the mesas are devoid of pine, but having previously discovered several datable specimens from Kawaioku, a pueblo of later date, some slight encouragement was gained, and it was hoped that the earlier pueblo of Kokopnyama might fulfill our needs. At this time Doctor Douglass had not recognized pinyon as reliable material, and it was not until much laboratory work had been done by Mr. Haury that Doctor Douglass realized the value of pinyon, and that once familiar with its characters, absolute dates could be determined. This discovery was joyful news to me, for I had begun to feel that my efforts at Kin Tiel and Kokopnyama were wasted, since only a few unfavorable specimens of pine had been found. I had collected a number of pinyon specimens, both of wood and charcoal, and with this latest development, I knew that not only could Kin Tiel and Kokopnyama be dated, but that countless other ruins situated in similar desert regions would eventually give up their secrets.

Unlike the Showlow ruin, Kokopnyama was not burned, which further lessened our chances, since the preservation of wood is dependent upon many factors that are rarely encountered in the proper combination. To date 42 specimens from Kokopnyama have been dated, 20 of which are charcoal, among which was only one pine specimen. The remaining 22 wood specimens were all from dwelling or storage rooms and gave the following dates: 1380, 1430, 1383, and 1389; two of 1369, four of 1370, and one of 1399; three of 1400, and one of 1416; one of 1400; one of 1255; one of 1371; and two of 1269. These dates are grouped according to their association.

With the exception of one specimen of charcoal found in a refuse heap and which was dated in 1928¹ all others were from kivas. Kiva R-24 was the only one in which dated roof beams were found. Seventeen of these dated 1380, two others giving the years 1362 and 1368 respectively. The great number of specimens dating 1380 A. D. would indicate that the kiva was either constructed in that or the following year. The remaining charcoal specimen was found in the firepit of Kiva R-23 and dated 1416, proving that the kiva was in use after that year. Many specimens from Kokopnyama still remain to be dated.

POTTERY CHRONOLOGY

Though several expeditions were made to the Hopi country in the latter part of the 19th century, it was not until 1917 that an effort was made through correlation, and stratigraphic and statistical methods to work out a chronological sequence of pottery development for the Little Colorado area, which includes the Hopi country. This work was undertaken by Spier,² of the American Museum of Natural History, whose principal object was a determination of the Zuñi series. The occurrence of Hopi pottery was lumped under the term "Buff-ware," which term was applied to Hopi as well as Zuñi wares. Thus, the Hopi sequence remained unsolved, and it was Kidder in 1923 and 1926 who first threw light upon the subject. As a result of a survey of a number of ruins, from surface examination and stratigraphic investigation he was able to determine that a yellow ware with black decoration preceded the Sikyatki polychrome which was in use at the Hopi pueblos when the Spaniards arrived in 1540.

This was the condition of affairs in the spring and summer of 1928 when the writer made a survey for Dr. A. E. Douglass in the interest of the Second National Geographic Society Beam Expedition, in an effort to determine those sites occupied or abandoned during the period known in the Douglass tree-ring chronology as the "Gap," a period which covered the time between late black-on-white wares and the development of early historic pottery types.

Briefly, the result of the 1928 study of Hopi pottery was the establishment of a pottery sequence for Pueblo IV in the Hopi country,

¹ Douglass, Andrew Ellicott, The secret of the Southwest solved by talkative tree rings. *Nat. Geogr. Mag.*, Dec., 1929.

² An outline for a chronology of Zuñi ruins. *Anthrop. Papers, Amer. Mus. Nat. Hist.*, Vol. XVIII, pt. 3, New York, 1917.

which substantiated the order suspected by Dr. Kidder. This sequence has withstood the test of stratigraphy, and has been verified by dates from beams found at Kawaioku in close association with pottery specimens representing the different periods. This development is not clearly understood as yet, and will be presented at some future time after the study of pottery specimens collected has been completed. The tentative classification used in field research is based upon the order in which characteristic pottery types first appear, and though the order of development has been verified, the periods as designated may later be revised. In the following classification only the type specimen for each division will be given. The classification is as follows:

Pueblo III (Basic complex):	Kayenta black-on-white and Kayenta polychrome.
Pueblo IV, Period A	: Jeddito black-on-orange
Pueblo IV, Period B	: Jeddito black-on-yellow
Pueblo IV, Period C	: Sikyatki polychrome

In an effort to help clarify the matter of Southwestern terminology, names of ceramic types follow the recommendations of the 1927 Pecos Conference. They are binomial—a geographic locality followed by a descriptive term. Generally speaking the type specimens of Pueblo III and Pueblo IV of the Hopi region are easily described; specifically, they are difficult of description. Pueblo III at the present time embraces the types found at Betatakin and Keet Seel, as described by Kidder,¹ and others. Though it is reasonable to expect further divisions of Pueblo III in the Hopi country, our knowledge is not yet sufficient to designate any one type as representative of a definite division, so we are necessarily forced to classify the period by its ceramic development. Period A of Pueblo IV is different, however; it is characterized by a ware of a peculiar shade of orange, sometimes ranging from almost red to a near-brown, which is decorated with black paint and has sherd temper. This is Jeddito black-on-orange and is found consistently associated either with late black-on-white, an earlier developed ware, or with Jeddito black-on-yellow, the succeeding type. Color alone is not sufficient for the identification of these types, for specimens in peripheral sites often are similar in color though they differ in other details which are recognized by one familiar with either type. Frequently the difference cannot be fully

¹ An introduction to the study of Southwestern Archaeology. A. V. Kidder, Yale Univ. Press, New Haven, 1924.

explained, and is recognized by the "feel" of the ware—a fact noted by all familiar with Pueblo pottery. Sherds of the period types dealt with in this paper are common in ruins belonging to the same cultural development, the difficulty in identification being limited only to peripheral finds. Jeddito black-on-yellow is characterized by the smoothness and quality of the ware, partly depending upon the fineness of the tempering material, which is seldom obvious to the naked eye. The basic color shades vary from cream to rich orange, while the decoration may be from light brown to black. The appearance of this type is sudden, suggesting a radical change in technique or materials—possibly both. A paper dealing with important differences in decorative technique and correlation with dated beams is in preparation.

In addition to normal pottery types as given in the preceding paragraph, occasional intrusive sherds from other regions have been found on the surface of the pueblo and in refuse heaps. Most notable of these are Zuñi glaze-paint specimens as noted by Hodge.¹ A sherd of "green glaze on white or creamy slip" (Zuñi Chronology, Period C) was found associated with a few Jeddito black-on-yellow sherds mixed with the fallen walls of Kiva R-4. The relation of these sherds to the occupation of the kiva is rather indefinite, though it is felt that they were included in the wall masonry. No specific importance, other than the occurrence of this Zuñi type during Pueblo IV can therefore be given. Four-mile polychrome has also been found on the ground surface, but is less common than the Zuñi wares. It occurs commonly in Pueblo IV ruins along the Little Colorado River and at Chevelon to the south. Rarely a sherd of Middle Gila pottery is also found.

Though it is not intended to comment upon the various forms of pottery found at Kokopnyama since this subject is worthy of separate note, it is of interest to remark upon the discovery of a problematical form found in a test hole. The vessel is a plate-like object with perforations around the edge. This form is described by Mr. Haury. The Kokopnyama specimen is smaller than that from the White Mountains. It is 7 inches in diameter, has one row of perforations around the edge, and four rows quartering the vessel. Perforations are made from the inside and average $\frac{1}{2}$ inch from center to center. Like the Pinedale specimen, clay was adhering to the inside when discovered. This would strengthen the belief that it was made for a pot rest to sustain the weight of large jars in the making, though no plausible explanation has been given for the perforations. Hopi workmen suggested that it might have been used in an obsolete cere-

¹ Kidder, A. V., *Southwestern archaeology*, p. 91, 1924.

mony in which vessels of this description were used. It is reported that the perforations were to hold flowers as in a modern flower holder.

Kokopnyama would give little encouragement to a pot hunter, and the paucity of complete or restorable specimens was a blow to the investigators since we had expected a nice collection of these excellent wares as a by-product. Only one room, R-11, contained unbroken vessels, practically all other rooms either being filled with refuse or containing nothing at all. Room R-14 will prove of value, however, since it was filled with refuse containing a great quantity of broken pottery vessels, the majority of which were Jeddito black-on-orange. Associated with these specimens were a few late black-on-white vessels, but none of the later Jeddito black-on-yellow ware was found. This is the only occurrence of the orange ware found at Kokopnyama in which it was not also associated with the yellow ware. Many of these specimens are restorable, and it is expected that much will be learned from a study of them.

SUMMARY

Briefly, the results of the 1929 work at Kokopnyama have contributed to our knowledge of prehistoric Hopi culture, in that:

(1) Details of dwelling rooms have been found similar to those of modern Hopi pueblos, if Spanish and American influence is disregarded;

(2) A knowledge of ceiling construction is gained and found to be essentially the same as in historic Hopi structures;

(3) Three kivas, two completely and one partially excavated, furnished data for comparison with ancestral (at Kin Tiel) and modern Hopi types; thus making it possible to have the evolutionary development from 1276 A. D. (see Kin Tiel) to the present time;

(4) Many beam specimens were acquired which, when dated, will give approximate years for important stages of kiva development, and associated pottery types;

(5) A determination was made of the definite time of decadence of old and rise of new pottery types;

(6) Confirmation was obtained from stratigraphic evidence of prehistoric Hopi pottery sequence as previously determined by other means; and

(7) Much cultural material was acquired.



1. Deflector and platform, Kiva KT-I, Kin Tiel.



2. Note shadow of airshaft, Kiva KT-II, Kin Tiel.

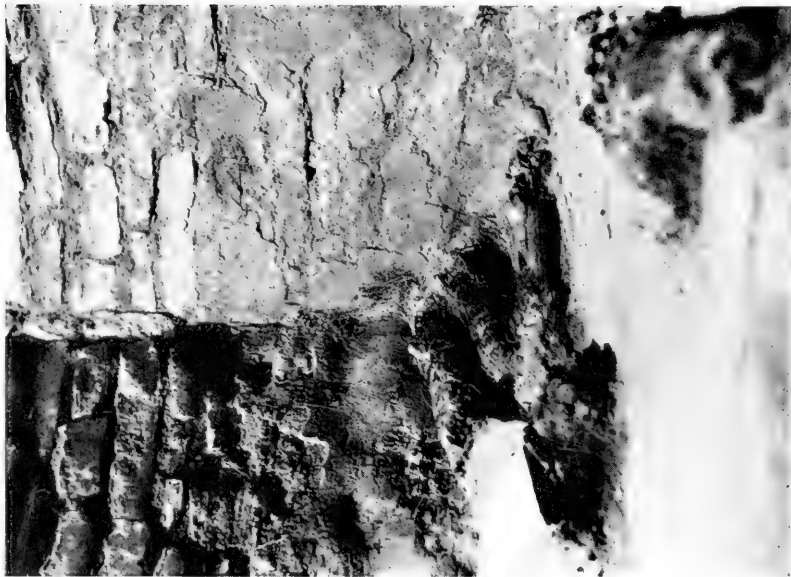

1. Showing charred beams in corner of Kiva KT-II,
Kim Tiel.



2. Fallen beams over loom-holes, Kiva KT-II, Kim Tiel.



1. Kiva R-4, Kokopnyama, showing brace wall between rear wall of kiva and first masonry wall.



2. Kiva R-4, Kokopnyama, showing combined deflector and firepit.



1. Kiva R-4, Kokopnyama, with platform restored.



2. Kiva R-4, Kokopnyama, showing covers to firepits.



1. Kiva R-24, Kokopnyama; general view. Note ollas buried in upper right corner of room.



2. Room 11, Kokopnyama; part of fallen roof removed showing buried olla in corner. Note beam hole (top) and cache.



1. Kiva R-23, Kokopnyama; general view of firepits, deflector and ventilator.



2. Room 10, Kokopnyama; firepit behind upright slab in corner.



1. Jeddito black-on-yellow bowls, Kokopnyama.



2. Late black-on-white ware ollas from Kin Tiel.



SMITHSONIAN MISCELLANEOUS COLLECTIONS
VOLUME 82, NUMBER 12

THE FIVE MONACAN TOWNS IN VIRGINIA, 1607

(WITH 14 PLATES)

BY
DAVID I. BUSHNELL, JR.



(PUBLICATION 3070)

CITY OF WASHINGTON
PUBLISHED BY THE SMITHSONIAN INSTITUTION
NOVEMBER 18, 1930



The "Indian Fish Traps," in the James River at Richmond.

SMITHSONIAN MISCELLANEOUS COLLECTIONS
VOLUME 82, NUMBER 12

THE FIVE MONACAN TOWNS IN VIRGINIA, 1607

(WITH 14 PLATES)

BY
DAVID I. BUSHNELL, JR.



(PUBLICATION 3070)

CITY OF WASHINGTON
PUBLISHED BY THE SMITHSONIAN INSTITUTION
NOVEMBER 18, 1930

The Lord Baltimore Press
BALTIMORE, MD., U. S. A.

THE FIVE MONACAN TOWNS IN VIRGINIA, 1607

BY DAVID I. BUSHNELL, JR.

(WITH 14 PLATES)

Late in April, 1607, three small ships sent out from England passed the Virginia Capes, entered Chesapeake Bay, and soon sailed a short distance up the James. These were the Godspeed, Discovery, and Sarah Constant, bearing colonists destined to form the first permanent English settlement in the New World. On May 14, they had come to anchor off a chosen site where Jamestown was soon to be established.

The spirit of adventure which had inspired many to undertake the long and tedious voyage across the Atlantic continued to dominate their acts, and within the following year they had reconnoitered much of the surrounding region, then a vast wilderness claimed and occupied by native tribes.

So venturesome were the colonists, and so desirous were they of becoming acquainted with the country and its primitive inhabitants that on May 21, one week after landing, a party of 23, one of them Captain John Smith, left Jamestown to explore the river. They continued up the stream, made rapid progress, and two days later arrived near Powhatan's village, not far from the eastern bounds of the present city of Richmond. The English desired to continue up the valley beyond the falls, and endeavored to persuade Powhatan to furnish guides to accompany them, but in this they were not successful. To quote from a narrative prepared by a member of the party: "Dyner Done we entred into Discourse of the Ryver how far it might be to the head therof, where they gat their Copper, and their Iron, and how many dayes Ioryne it was to *Monanacah, Rahowacah* and the Mountains *Quirank*: requesting him to have guydes with us also in our intended March; for our Captaine Determynd to have travelled two or 3 dayes Iornye a foote up the Ryver: but without gyving any answer to our Demaundes, he shewde he would meete us himselfe at the overfall and so we parted. This *Naviraus* accompanied us still in the boate. According to his promyse he (*Pawatah*) mett us; where the fellow whome I have called our kinde Consort, he that followed us from *Turkey Ile*, at the Coming of *Pawatah* made signe to us we must make a shoute, which we Dyd.

"Now sitting upon the banck by the overfall beholding the same, he began to tell us of the tedyous travell we should have if wee proceeded any further, that it was a Daye and a halfe Iorney to *Monanacah*, and if we went to *Quiranck*, we should get no vittailles and be tyred, and sought by all means to Disswade our Captayne from going any further: Also he tolde us that the *Monanacah* was his Enmye, and that he came Downe at the fall of the leafe and invaded his Countrye But our Captayne out of his Discreyton (though we would faine have seene further, yea and himselfe as desirous also) Checkt his intentyon and returned to his boate."¹ The party returned safely to Jamestown whère they arrived June 22.

On this, the first journey to the falls, the inhabitants of all the many native villages encountered were allies, but the colonists heard of others beyond, to the westward, who were enemies of the allied tribes. This is the earliest known reference to the Monacan.

Early in the spring of 1608 another expedition was projected "to discover and search the commodities of *Monacans* countrie beyond the Falles," but the exploration was not attempted as events at Jamestown made it necessary for all to remain near by. However, during the autumn of the same year Captain Newport, having just returned from England, "with 120 chosen men set forward for the discovery of *Monacan*." The expedition appears to have been quite successful, although scant records of the happenings have been preserved. One narrative tells how "Arriving at the Falles, we marched by land some fortie myles in two dayes and a halfe; and so returned downe the same path we went. Two townes we discovered of the *Monacans*, called *Massinacak* and *Mowhemenchouch*; the people neither used us well nor ill, yet for our securitie we tooke one of their petty Kings, and led him bound to conduct us the way."² This is the earliest known record of the entering of the Monacan territory by Europeans.

The region beyond the bounds of the Powhatan confederacy, up the valley of the James from the falls, was regarded by Indian and colonist alike as a separate and distinct land. This is suggested by a statement contained in a letter written by George Yardly to Sir Henry Payton in London, dated "James town, this XVIII of November, 1610," in which he referred to an expedition planned by the Governor, who intended going "up unto a famous fall or cataract of waters, where leaving his pinnasses & Boates safe riding, so purposely to loade up go into the Land called the Monscane."³

¹ Archer Relation. In Smith, Arber ed., pp. xlv-xlvi.

² Smith, Arber ed., p. 438.

³ Bodleian Library, Oxford. MSS. Eng. Hist., C. 4, fol. 3.

Strachey writing a few years later told what was then known of the country beyond the falls: "Concerning the high-land little can we say as yet, because thereof little have we discovered: only some Indians' relations and some few daies' marches into the Monocan country of our owne, have instructed us thus far.

"This high land, or Britannia, then say we, is the mayne and firme continent, which extendeth, we wot not how far, beyond that cataract or fall of water, which the Indians call Paquachowng, from whence one daies' journey into the Monocan country. Our elder planters (at their first comyng) proclaymed His Majestie King of the country at Mohominge (a neighbour village), and sett up a crosse there with His Majestie's name inscribed thereon From the falls our men have heretofore marched (as the river led them) about forty or fifty miles, and fownd a high land woody, little champion, with rising hills, rocky and mountanous" ¹

Continuing Strachey wrote (p. 131): "For mineralls we will promise nothing; but the hope of which, seeing the low grownd, yields manie faire shewes; the mountaines cannot be doubted but that in them manie sortes will be found: and our people, in their first discovery into the Monocan country discovered two mynes, the one within six miles of the head of the falls, which takes the name of Namantack, the fynder of yt: which is conceaved wilbe worth the exploring, and with little charge; the other lyes in the myd-waie betweene twoo townes of Monocan, the nearest called Mowheminke, the furthest, Massinnacock, distant one from another fourteen miles."

The preceding references must necessarily apply to discoveries made by Newport during the autumn of 1608.

A map of Virginia, usually attributed to Captain John Smith, was presented in his "Generall Historie of Virginia," 1624. It shows the course of the James far above the falls and many miles beyond the spot reached by Newport in 1608. A cross appears on the map at the beginning of the falls, the meaning of which may be understood by quoting from Strachey's reference to the map. He gave this quaintly worded explanation (p. 42): "In which mapp, observe this, that, as far as you see the little crosses either rivers, mountaines, or other places, have discovered; the rest was had by informacion of the salvages, and are set downe accordinge to their instruccions." In this instance it is evident the cross marks the farthest point reached by Smith in May or June, 1607. He had never gone beyond the falls

¹ Strachey, William, *The Historie of Travile into Virginia Britannia*, p. 25. Hakluyt Society, London, 1849.

and wrote, when describing the James then "called *Powhatan*, according to the name of a principall country that lyeth upon it. . . . It falleth from Rockes farr west in a Country inhabited by a nation they call *Monacans*. But where it commeth into our discovery it is *Powhatan*. In the farthest place that was diligently observed, are falles, rockes, shoules, &c. which makes it past navigation *any higher*."¹ And it is believed the dotted line following the left bank of the river indicates the trail traversed by Newport and his party in the autumn of 1608. The region beyond the end of the trail, as shown by the broken line, was described by the Indians. The Monacan with whom Newport came in contact would undoubtedly have been well acquainted with the country as far westward as the mountains and even beyond, and it may have been from "one of their pettie Werowances" that were learned the description of the course of the river, the position of its principal tributary beyond the falls, and the locations of the large towns. But whatever may have been the source of the information, the map made more than three centuries ago was remarkably accurate, as may be seen by comparing it with a very recent plan of the same region. The one tributary shown on the Smith map was the present Rivanna, but its name, by which it was known to the Indians, has not been preserved.

Five villages, or rather centers of population, are indicated on that part of the old map designated as the territory of the Monacans. These are:

- a. Mowhemcho. On the right bank of the James.
- b. Massinacack. On the right bank of the James beyond Mowhemcho.
- c. Rassawek. At the junction of the James and the Rivanna.
- d. Monahassanugh. On the James beyond the mouth of the Rivanna.
- e. Monasukapanough. On the Rivanna.

The spelling of the names differs in the text where they are often given as:

- | | |
|-------------------|---------------------|
| a. Monacans. | d. Monahassanuggs. |
| b. Massinnacacks. | e. Mowhemenchughes. |
| c. Russawmeake. | |

The name Monacan was first applied to the territory occupied by the five tribes as well as to the confederacy which they composed. Later the first town entered by the English—Mowhemcho—became known as Monacan Town. This was the village of the Monakins of

¹ *Op. cit.*, p. 346.

Lederer, and Manakin Town or Maningkinton of Michel. The meaning of the word is not known.

The spelling of the names as given on the Smith map will be followed when referring to the sites in the present sketch, although it is not possible to discover which form is the more nearly correct. A section of the map showing the five Monacan towns, the course of the James and of its principal tributary, the Rivanna, is reproduced in figure 1. A second map, figure 2, is presented for comparison with the preceding. The base is traced from a recent map issued by the United States Geological Survey, and on this have been indicated the sites of the five Monacan towns mentioned by the early writers. They will be described separately in the following pages.

How long the country had been occupied by the Siouan tribes can never be determined. Others had preceded them, but who they were or whence they came may ever remain unknown. The earlier habitat of the Siouan tribes, to which stock the Monacan belonged, is believed to have been in the valley of the Ohio, from which region they crossed the mountains to the eastward and later occupied the lands where they were encountered by the Virginia colonists early in the 17th century. A comparison of the material to be recovered from sites eastward from the Ohio may make it possible to trace the line of migration of these tribes; this would require much time and careful study, but if successful would prove of the greatest interest.

THE FALLS

The Falls of the James, which tended to separate the regions occupied by the two groups of tribes, may be more correctly described as a series of rapids extending several miles. It was an important place for fishing, and was frequented by the Indians whose camps would have been found scattered along the wooded banks of the stream, a very rough and broken bit of country.

The last village of the Algonquian tribes up the river was a mile or more below the foot of the rapids. It is not improbable that the upper part of the falls, some miles distant from the Algonquian village, was often visited by the inhabitants of the nearest Monacan town, Mowhemcho. Powhatan's statement to Captain Newport at the time of their first visit in 1608 that the Monacan "came Downe at the fall of the leafe and invaded his Countrye," would indicate that the Monacan rather than the Algonquian dominated the region and did not fear the latter.

There was formerly in "The Byrd Title Book"—a manuscript volume belonging to the Virginia Historical Society—a drawing or

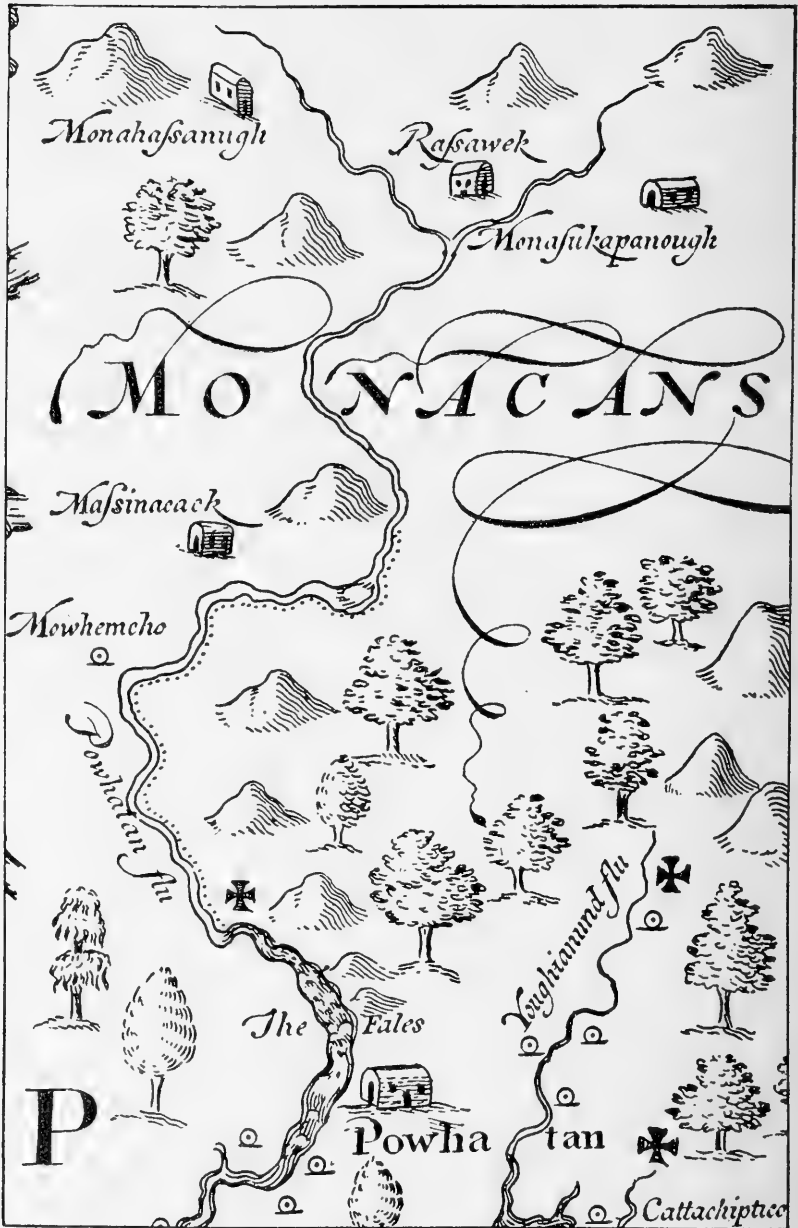

FIG. I.—Section of the Smith map, 1624, showing the country occupied by the Monacan.



FIG. 2.—Detail of a recent survey, with sites of Indian towns added For comparison with map of 1624, figure 1.

rather plan of the rapids and islands in the James which was made before the year 1700. At a point between an island and the right bank of the river was indicated the position of the "Indian Fish Traps." This was evidently just within the western limits of the present City of Richmond where ancient fish traps may still be seen in the river. They are clearly defined when the water in the James is low, and under such favorable conditions they were photographed by the writer in October, 1926. The view is reproduced as the frontispiece, plate 1.

Beverley¹ described several ways of fishing, and had undoubtedly witnessed all being practiced by Indians with whom he had come in contact. He wrote in part: "At the falls of the Rivers, where the Water is shallow, and the Current strong, the *Indians* use another kind of Weir, thus made: They make a Dam of loose Stones, whereof there is plenty at hand, quite across the River, leaving One, Two, or more Spaces or Trunnels, for the Water to pass thro'; at the Mouth of which they set a Pot of Reeds, wove in the Form of a Cone, whose Base is about Three Foot, and perpendicular Ten, into which the Swiftness of the Current carries the Fish, and wedges them so fast, that they cannot possibly return."

The preceding description applies perfectly to the fish trap in the James, where three "Spaces or Trunnels" may be distinctly traced pointing down the stream. Beverley may have had this exact site in mind when he wrote his account so many years ago.

White oak splints, similar to those used in making baskets, were formerly "wove in the Form of a Cone" to serve as fish traps. They were used extensively in this part of Virginia as elsewhere. The maximum diameter of the large end was usually about one-third the length of the finished trap. At this end the weaving returned inward for a short distance, the opening becoming smaller so as to prevent the escape of the fish. At the opposite end the warp elements extended some inches after the woof was discontinued, coming closer together and finally touching, thus serving to close the end of the trap. They were placed where the current was strong, with the small end pointing down stream.

MOWHEMCHO

This village, later to be known as Monacan Town, was the first encountered by Newport in 1608 in passing up the valley of the James from the falls. It stood on the right or south bank of the river and

¹ Beverley, Robert, *The history and present state of Virginia*, Book 2, p. 33. London, 1705.

probably covered some of the level area bordering the stream in the extreme eastern part of the present Powhatan County, between Bernards Creek on the east and Jones Creek on the west. It does not appear to have been a palisaded village but rather an open settlement. Gardens were probably near the scattered habitations. It was a beautiful site for a native village. On the north it was protected by cliffs rising abruptly from the left bank of the river, on the south it was bounded by high, rolling land from which issued springs of clear water. Game was abundant throughout the region.

Three centuries ago Mowhemcho was an important center, probably the home of some hundreds of individuals who lived in a land of plenty, where food was easily obtained. How long the site may have been occupied will never be known. By the close of the 17th century few Indians remained in the vicinity, and during the year 1699 a Huguenot colony took possession of the land and there established a settlement which continued for some years. Huguenot, near the middle of the tract, and Huguenot Springs on Bernards Creek, about 2 miles from the bank of the James, are names which tend to identify the site. At the present time few traces of a native settlement can be discovered on the surface, which has been subject to overflow during the past centuries, but much may be hidden beneath deposits of sand and alluvium.

The Huguenots settled part of the area in 1699, but it is quite evident that Indians continued to occupy a portion of the site. Three years later they were briefly mentioned by a Swiss traveler.¹ This was in April, 1702, when Michel stopped at "Manakin town," and later wrote in his journal (II, p. 123): "The Indians often visit there, bringing game, rum and other small things. There is a good opportunity to trade with skins. They (the Indians) often bring pottery and when desired fill'd with corn." How corn was prepared in Virginia at that time is not revealed. He continued and again mentioned the Indians (p. 132): "In their homes they are naked, as I have seen one at Maninginton, who came back from hunting. He had nothing but his gun, knife and powder horn, except a linen rag which covered his sexual parts a little, and a deer skin protecting his feet, that the thorns might not hurt him. He had also a tuft of feathers behind his ear." Such was the appearance of a Monacan in the early Spring of 1702. Several drawings made by Michel and

¹ Michel, Francis Louis, *Journey from Berne, Switzerland, to Virginia—October 2, 1701 to December 1, 1702*. The Virginia Magazine, Virginia Hist. Soc., Richmond. January and April, 1916.

reproduced in the articles cited, are believed to represent Monacan Indians as described by him, however the sketches are not mentioned in the journal and for that reason are not positively identified.

The Indians of the village, or those who frequented the settlement, had been in possession of guns for many years. When Lederer¹ and his party reached the village of the "Monakins," May 22, 1670, they were, so he wrote: "welcomed by them with volleys of shot." But the village at that time was already much reduced and undoubtedly many of the people had wandered away to seek new homes elsewhere. In 1669, the year before Lederer's visit, the Monacan could bring together only 30 warriors.

MASSINACACK

Massinacack was the second native village reached by Newport in 1608 after having entered the Monacan territory. It is shown on the Smith map of 1624 as situated south of the James. Strachey mentioned it being some 14 miles distant from Mowhemcho, or Monacan Town, which would place it on the right bank of the river about the mouth of the present Mohawk Creek, a mile or more south of the town of Goochland, on the opposite side of the James.

Lederer was at the Monacan village late in May, 1670. A crude map, part of which is now reproduced in figure 3, accompanied the narrative of his journey and shows the James, or *Pawathan fl.* from near the falls westward. A dotted line passes up the right bank of the river and is evidently intended to represent the trail which he followed. This reached Monakin and continued to Mahock. The former was the Mowhemcho of Smith, the latter was undoubtedly another form of Massinacack, from which the present name of the creek has been derived. Two streams are represented coming together at Mahock and at once suggest the confluence of the James and the Rivanna, but it probably indicates the creek now bearing the name Mohawk flowing into the James. This was, without doubt, the site of the ancient village of Massinacack.

Lederer's narrative is vague and uncertain, the distances given are not reliable, but the names of streams and of places which appear on the map and are repeated in the text may be quite accurate. For this reason the present Mohawk Creek is believed to have been the Mahock of Lederer. By continuing due westward from this creek the party would have reached the James flowing in a northerly

¹ Lederer, John, The discoveries of Begun in March 1669, and ended in September 1670. London, 1672. Reprint, Rochester, 1902.

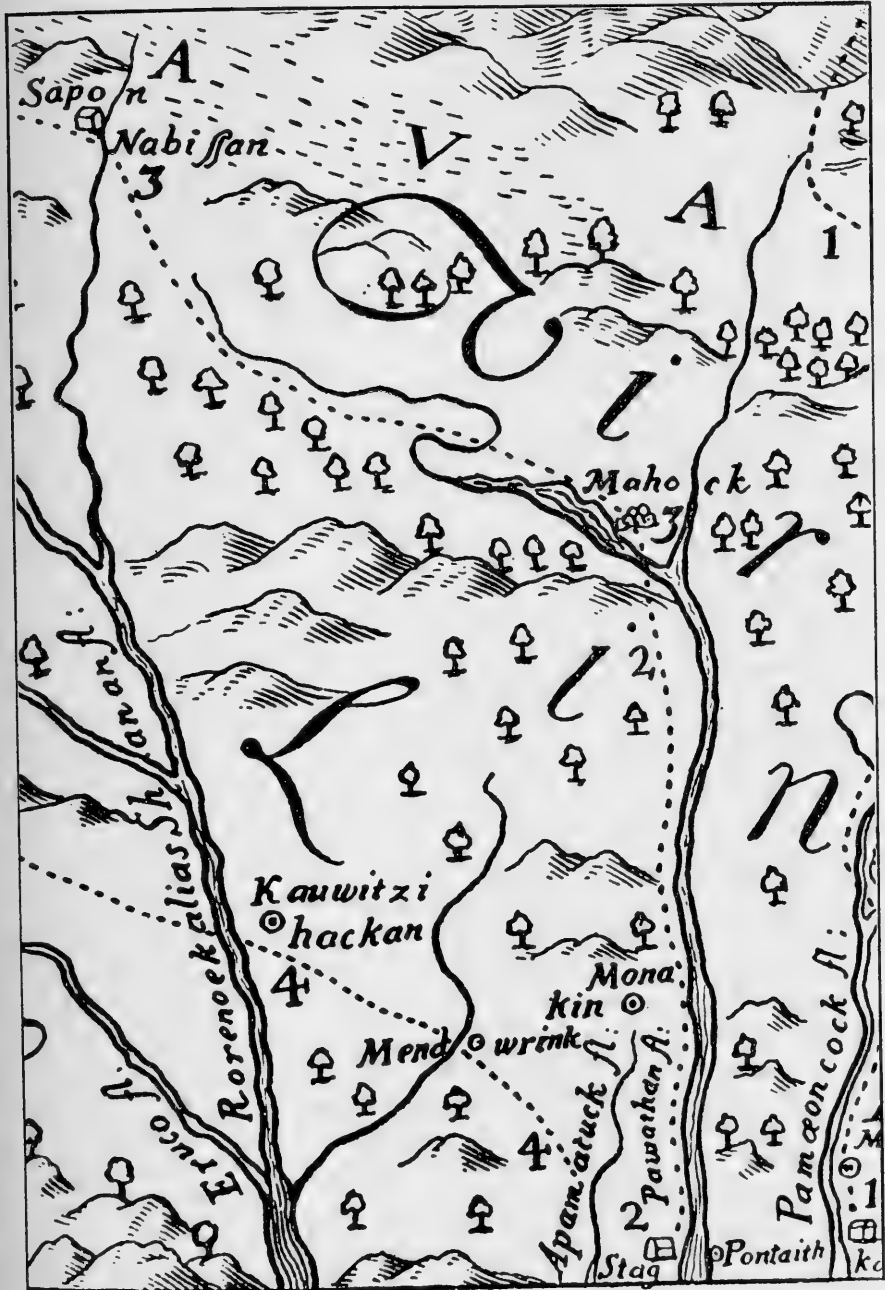

FIG. 3.—Section of the Lederer map, 1670, showing the trail up the James to Monakin and Mahock, with Sapon Nahissan far to the southwest.

direction; this was probably what they considered to be "the south-branch of James river, which Major Harris observing to run northward, vainly imagined to be an arm of the lake of Canada."

During the 18th century there was an important ferry across the James at, or very near, the site of this early native settlement. Leading southward from the ferry was a road over which colonists went to Carolina. As many of the roads developed by the first settlers followed the lines of ancient trails it is within reason to believe the same route had been traversed by Indians through generations.

RASSAWEK

No account has been discovered of a European having visited the village of Rassawek, although early writers referred to it as the principal town of the Monacan confederacy. Smith wrote in 1612: "Upon the head of the *Powhatans* are the *Monacans*, whose chiefe habitation is at Russawmeake," but all his knowledge of the place had been derived from Indians. It stood evidently at the confluence of the James and Rivanna, some miles beyond the point where Newport turned to retrace his way to Jamestown in the autumn of 1608. The site had been abandoned before white settlers entered the region and consequently its exact position may never be known.

Viewed at the present time the most desirable and logical location for an extensive village would have been on the right bank of the Rivanna, within the angle formed by the two streams. Here is a wide bottom with high, rolling land a short distance from the James touching the Rivanna. When timbered and in its natural condition this would have been a beautiful site for a native settlement. The proximity of the two streams would have afforded some protection. The wooded hills to the north would have sheltered the frail habitations from the winter winds. Fish and wild game, ever plentiful, could have been easily taken for food. This was probably the site of the village of three centuries and more ago.

Many traces of Indian occupancy have been discovered within a radius of a few miles of the mouth of the Rivanna, but all should not be attributed to the Monacan. The junction of two streams always attracted the Indian and it is evident others had lived there before the coming of the Siouan tribes to the valley of the James.

It is believed that the members of the five tribes or groups mentioned in the present sketch had similar manners and customs, and that all disposed of their dead as did the people of Monasukapanough, whose village stood on the banks of the Rivanna far above Rassawek.

Consequently the discovery of other sites along the course of the James, where the dead had been buried in shallow pits scattered through the village, suggests that some other tribe or tribes may have preceded the Monacan. Numerous signs of Indian occupancy have been encountered on Elk Island, a large island in the James a short distance below the mouth of the Rivanna, but there is no reason to believe it was ever occupied by the important village of Rassawek. The burials discovered on the island do not appear to have been of Monacan origin; however, related Siouan tribes could have occupied this and other sites in the valley of the James.

MONAHASSANUGH

As Mooney has so clearly shown, the Monahassanugh of Smith were the Tutelo of later narratives. To quote from his interesting work¹ (p. 37): "The Tutelo and Saponi tribes must be considered together. Their history under either name begins in 1670. . . . Monahassanugh and Nahysson are other forms of *Yesa*ⁿ, the name given themselves by the last surviving Tutelo, and which seems to have been the generic term used by all the tribes of this connection to designate them as a people." And again (p. 31): "In Nahysson we have the Monahassanugh of Smith, the Hanohaskie of Batts, and the Yesang of Hale. The last is evidently the generic root word, the prefix *Mo*, *Mona*, or *Na* in the other forms probably giving a specific local application to the common term. Thus from Lederer's statement that Sapon was a Nahysson town we understand that the Saponi were a subtribe or division of the people who knew themselves as Yesang."

The ancient village of Monahassanugh is believed to have stood on the left bank of the James, about 1½ miles up the stream from Wingina, in Nelson County. The river is here bordered on the north, or left bank, by broad fertile bottom lands which extend for some miles above and below the site; while on the opposite side cliffs rise abruptly, steep, rugged and broken. The site resembles that of Mowhemcho or Monacan Town, although the relative position of the cliffs and low ground is reversed, the former being on the left bank of the river and the latter, which was occupied by the village, on the right.

Stone implements have been found scattered over much of the low ground, arrowheads of white quartz and of brownish quartzite have been recovered in vast quantities. Numerous fragments of

¹ Mooney, James, *The Siouan tribes of the East*. Bull. 22, Bur. Amer. Ethnol., Washington, 1894.

pottery bearing the imprint of textiles, stone gorgets, pipes, etc., have been collected on the site—all proving the former existence here of an extensive, permanent village.

The site was visited by Fowke about the year 1892. He wrote:¹ “The Indian trail from the Shenandoah valley, through Rockfish gap, crossed James river at an island near Norwood. For 5 miles below in the river there is a succession of pools and rapids, with many large rocks in the channel which are covered only in time of high water. The hills on the south with scarcely an exception reach to the water, there being only a few narrow strips of level ground. On the north the bottom lands are wide and continuous.

“The only indications of Indian occupancy on the southern side in this vicinity are opposite the island. On the northern side, however, aboriginal remains may be found on every farm. They are most abundant on the lands . . . three miles below Norwood.

“The floods of 1870 and 1877 disclosed numerous small deposits, probably more than 200 in all, containing burned stones, pieces of pottery, arrowheads, and great quantities of quartz chips. They are in nearly straight rows, from 25 to 50 feet apart, and extend for several hundred yards along the river.” Many stone implements were discovered, and “all these things point to a village of considerable size, but a most careful search of the whole area, especially along the river bank and in the numerous gullies, failed to reveal a bone of any description.”

The material recovered was similar to that found on the site of Monasukapanough, on the banks of the Rivanna, to be described in the following section. The chipped ax- or celt-like implements found on both sites are the most characteristic of all the objects recovered. Three typical examples from the James River site are shown in figure 4, for comparison with others found on the banks of the Rivanna, plate 5.

Fowke's failure to discover a cemetery, or to find any traces of human remains, tends to strengthen the belief that this was a Siouan village where the burial customs were the same as those of the people of Monasukapanough, related tribes having the same customs and ways of life. Undoubtedly a large burial mound, or possibly several, once stood on the low grounds bordering the left bank of the James. These, the “Indian Graves” of early records, were probably to have been encountered in many localities, but were destined to be destroyed when the land was cleared and cultivated; soon all traces

¹ Fowke, Gerard, Archeologic investigations in James and Potomac Valleys. Bull. 23, Bur. Amer. Ethnol., Washington, 1894.

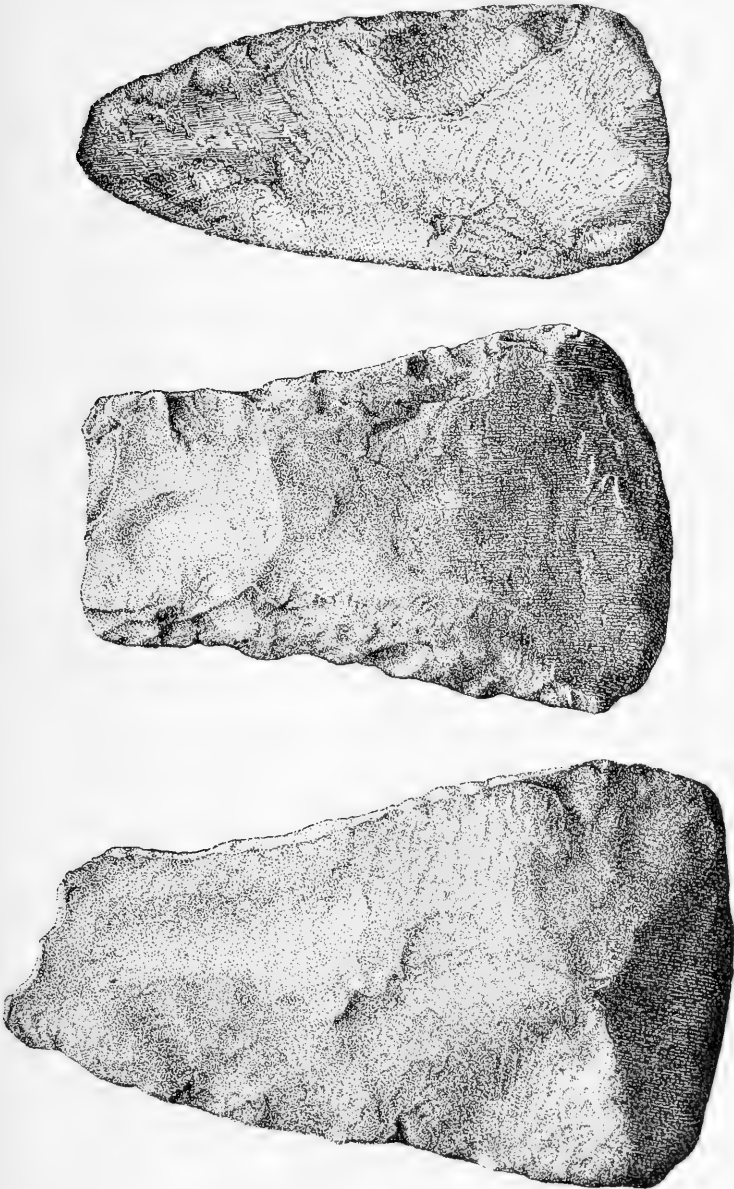

FIG. 4.—Implements found on the site of Monahassanugh. $\frac{1}{2}$ natural size.
(U. S. Nat. Mus. Cat. No. 136175)

of the mounds disappeared and their existence was forgotten. However the mound which stood on the bank of the Rivanna was to live in history, and the careful manner in which it was examined by Jefferson will ever be of interest.

About the year 1654 many Indians came from a distance and "settled down near the falls of James river, to the number of six or seven hundred."¹ It appears they came to seek a new home, in no manner antagonistic to the colonists and desiring peace. However, after they had been there some months the English endeavored to expel them and this resulted in one of the greatest and most disastrous battles ever fought by early settlers and Indians. Totopotomi and his Pamunkey warriors had become allies of the English, but he and the majority of his followers fell when the entire force was routed and defeated. The identity of the Indians who had thus come to the region of the falls to seek a peaceful home, and who proved themselves such worthy warriors, has never been determined. The name Rechahecrian or Rickohockan has been applied to them, believed by some to have been the Cherokee, although it was Mooney's later belief that they were Erie who had come southward. However, a statement by Lederer makes it appear they were the people of two Monacan groups, the Massinacack and Monahassanugh, who may have come from farther up the James to settle a new home more protected from the war parties of the Iroquois.

As has already been explained the *Mahocks* and *Nahyssans* of Lederer were probably the Massinacack and Monahassanugh of Smith and other early writers. Thus when Lederer mentioned the great encounter and said: "a great Indian king called Tottopotoma was heretofore slain in battle, fighting for the Christians against the Mahocks and Nahyssans"² he did not doubt the identity of the people against whom the English and the Pamunkey allies fought. Lederer, on his map, gave the name *Rickohockans* to a tribe then living far to the westward beyond the mountains. The name or term has never been clearly understood or translated, and with slight variation of spelling has been used to designate several tribes in widely separated parts of the country. But the word may have been a term applied under certain conditions and not the definite name of any tribe or group of tribes. If this belief is correct it could have been applied to Siouan as well as to Iroquoian or other tribes.

The Rickohockans, so-called, were to Lederer a vague group, evidently known to him only during his travels away from the English

¹ Hening, I, p. 402.

² *Op. cit.*, p. 10.

settlements. Had he associated them in any way with the great battle he would undoubtedly have mentioned them in that connection, but this he failed to do. The Algonquian and Monacan tribes had ever been enemies, it was known as early as 1608, and this fact may explain the willingness with which Totopotomi and the Pamunkey warriors joined the English in attacking their ancient tribal enemies.

MONASUKAPANOUGH

This name, as it appears on the Smith map, corresponds with the position of an extensive village site on the banks of the Rivanna, in Albemarle County, directly north of the University of Virginia and about one-half mile up the river from the bridge of the Southern Railway. At that point the Rivanna makes a wide bend, flowing from the west, then turning and continuing in a southeastwardly direction. On the right or south bank there is a wide, fertile bottom, bounded on the north by the river and on the south by cliffs sloping to the low grounds. On the left or north bank of the stream the bottom is far less extensive than on the opposite side, but it is rather higher and less liable to be overflowed, and the cliffs are nearer the river. This is believed to have been the site of the ancient settlement of Monasukapanough. The village appears to have occupied both sides of the river, with a ford that made it possible to pass from one side to the other, although canoes were probably in constant use on the stream. A plan of the region is shown in figure 5.

The translation of the name of the village has not been determined, nor has that of the name of the related settlement which stood on the bank of the James. As mentioned there is a ford across the Rivanna at this place—shallow water—which may have to do with the first part of the name. This is suggested by statements by William Byrd, in the year 1728, during the running of the line between Virginia and North Carolina,¹ when he had an old Saponi Indian acting as guide. To quote from the remarkable narrative (p. 42): On September 28 "We proceeded to the canoe landing on Roanoke, where we passed the river with the baggage. But the horses were directed to a ford about a mile higher, called by the Indians *Moni-seep*, which signifies, in their jargon, shallow-water. This is the Ford where the Indian traders used to cross with their horses, in their way to the Catawba nation." And on October 2 they crossed a large creek "which the Indians called *Massa-moni*, signifying, in their language, Paint

¹Byrd, William, *The Westover manuscripts: containing the history of the dividing line. . . . Petersburg, 1841.*

creek, because of the great quantity of red ochre found in its banks." Later on the same day they crossed another creek called "in the Saponi language, Ohimpa-moni, signifying jumping creek, from the frequent jumping of fish during the spring season." It would now be interesting to know if the name Jumping Branch, applied at the present time to a branch of Hardware River, in Albemarle County, perpetuates an ancient Siouan name.

Mooney was of the belief that Monasukapanough was possibly "the original of Saponi." There is little reason to doubt the correct-

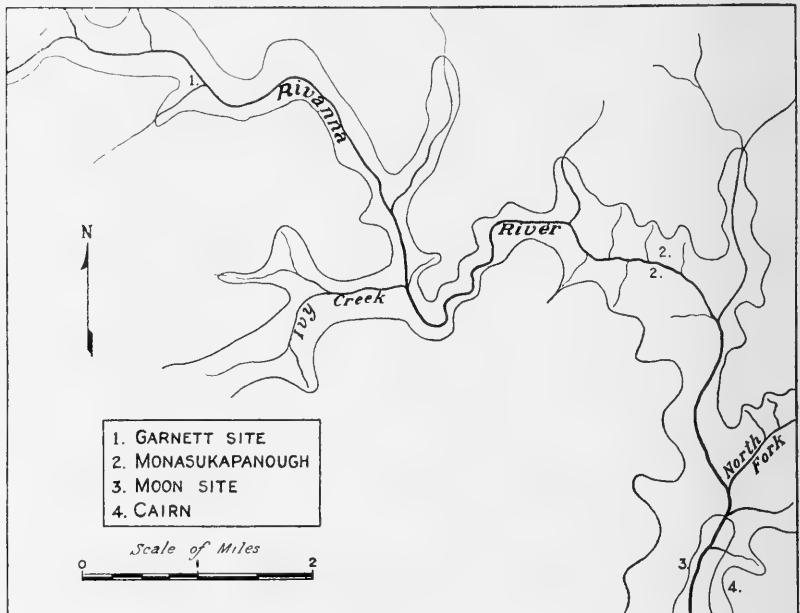

FIG. 5.—A section of the Rivanna Valley, in Albemarle County, Virginia, showing the position of Monasukapanough and lesser sites.

ness of this belief. Lederer stated that he "arrived at Sapon, a village of the Nahyssans." The latter, as previously shown, were the Monahassanugh whose name appears on the map of 1624. Therefore it is quite evident that at the time of the settlement of Jamestown, 1607, the site on the banks of the Rivanna was occupied by the Saponi, closely allied with the Monahassanugh or Tutelo, whose village stood on the bank of the James some miles away in a southwesterly direction.

Had it not been for the work and interest of Jefferson, no account of the great burial mound which once stood at the ancient village of Monasukapanough would now be available. It would have disappeared

as have the burial places once belonging to other villages of the Siouan tribes and no reference to it would have been preserved. The site of the Indian town was visible from Monticello, and the burial mound stood near the south, or right bank of the Rivanna within the area shown in plate 2. Jefferson desired to know the nature of the contents of the work and, so he wrote¹ (p. 139): "For this purpose I determined to open and examine it thoroughly. It was situated on the low grounds of the Rivanna, about two miles above its principal fork, and opposite to some hills, on which had been an Indian town. It was of spheroidal form, of about 40 feet diameter at the base, and had been of about twelve feet altitude, though now reduced by the plough to seven and a half, having been under cultivation about a dozen years. Before this it was covered with trees of 12 inches diameter, and round the base was an excavation of five feet depth and width, from whence the earth had been taken of which the hillock was formed. I first dug superficially in several parts of it, and came to collections of human bones, at different depths, from six inches to three feet below the surface. These were lying in the utmost confusion, some vertical, some oblique, some horizontal, and directed to every point of the compass, entangled, and held together in clusters by the earth. Bones of the most distant parts were found together, as, for instance, the small bones of the foot in the hollow of a scull, many sculls would sometimes be in contact, lying on the face, on the side, on the back, top or bottom, so as, on the whole, to give the idea of bones emptied promiscuously from a bag or basket, and covered over with earth, without any attention to their order." And to continue: "I proceeded then to make a perpendicular cut through the body of the barrow, that I might examine its internal structure. This passed about three feet from its center, was opened to the former surface of the earth, and was wide enough for a man to walk through and examine its sides. At the bottom, that is, on the level of the circumjacent plain, I found bones; above these a few stones, brought from a cliff a quarter of a mile off, and from the river one-eighth of a mile off; then a large interval of earth, then a stratum of bones, and so on. At one end of the section were four strata of bones plainly distinguishable; at the other, three; the strata in one part not ranging with those in another. The bones nearest the surface were least decayed . . . Appearances certainly indicate that it has derived both origin and growth from the accustomed collection of bones, and deposition of them together; that the first collection had been deposited on the common

¹ Jefferson, Thomas, Notes on the State of Virginia. Philadelphia, 1794.

surface of the earth, a few stones put over it, and then a covering of earth, that the second had been laid on this, had covered more or less of it in proportion to the number of bones, and was then also covered with earth; and so on."

There is reason to believe some Indians continued to occupy the site until after the beginning of the 18th century. They may have been few in number, but among the number must have been some who were descendants of others who had lived there when Monasukapanough was a large village. As late as the middle of the century some were living who knew of the burial place of their dead. Jefferson, referring to the mound which he had examined, told how "a party passing, about thirty years ago, through the part of the country where this barrow is, went through the woods directly to it, without any instructions or enquiry, and having staid about it some time, with expressions which were construed to be those of sorrow, then returned to the high road, which they had left about half a dozen miles to pay this visit, and pursued their journey." Only those who had retained a memory of the burial place could, or would, have made such a pilgrimage.

The exact position of the mound may never be determined, but it certainly stood on the low ground, on the right bank of the Rivanna, evidently nearer the river than the cliffs, and it may have been some distance above the ford.

During the month of June, 1911, I examined part of the low ground in the endeavor to find some trace of the native village to which the burial mound had belonged. Nothing was discovered on the surface; all had been covered in the past years. Nine excavations were made about 50 yards from the river bank, and beginning about that same distance west of the road leading to the ford. One excavation was 30 feet in length, others were 5 or 6 feet square, all were 2 feet or more in depth. In seven of the nine excavations small fragments of pottery were encountered at an average depth of about 20 inches, bits of quartz and quartzite, and pieces of charcoal were also met with in some excavations. No traces of bones of any sort were found. The superstratum, some 20 inches in thickness, represents the alluvium deposited by the river since the village was occupied, and may have resulted from one or more freshets during the past century. The greatest freshet known was in 1877, at which time, so it is said, most of the low ground was overflowed to a great depth. When the waters receded some parts of the area were covered with a thick deposit of sand while on other sections the soil had been washed away and the surface lowered. Many stone objects of Indian origin were exposed.



The site of Monastukapanough looking south from the cliffs north of the Rivanna. The stream is hidden by the trees bordering its banks.



Object found on the site of Monasukapanough, suggesting a human head.
Exact size.

(U. S. Nat. Mus. Cat. No. 350136)

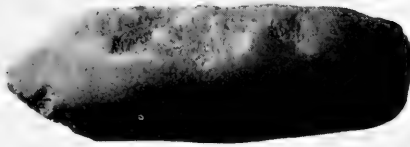

a

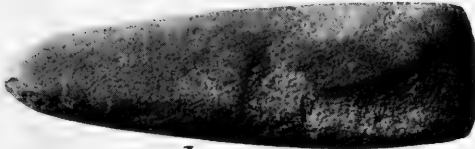

b

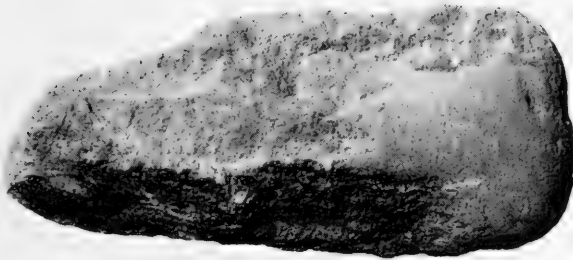

c

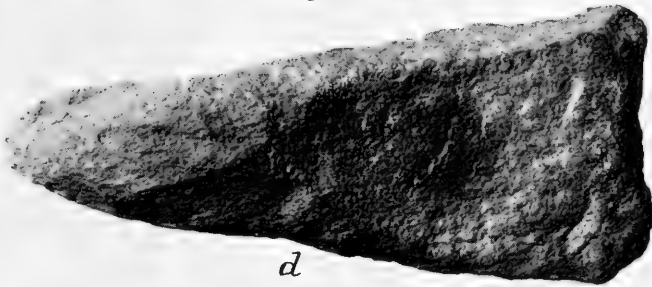

d

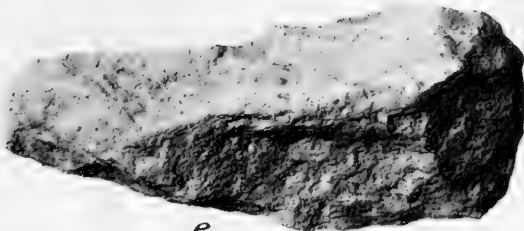

e

Objects found on the surface, Monasukapanough. $\frac{1}{2}$ natural size.
(U. S. Nat. Mus. Cat. Nos.: *a*, 350101; *b*, 350102; *c*, 350107; *d*, 350109; *e*, 350110)

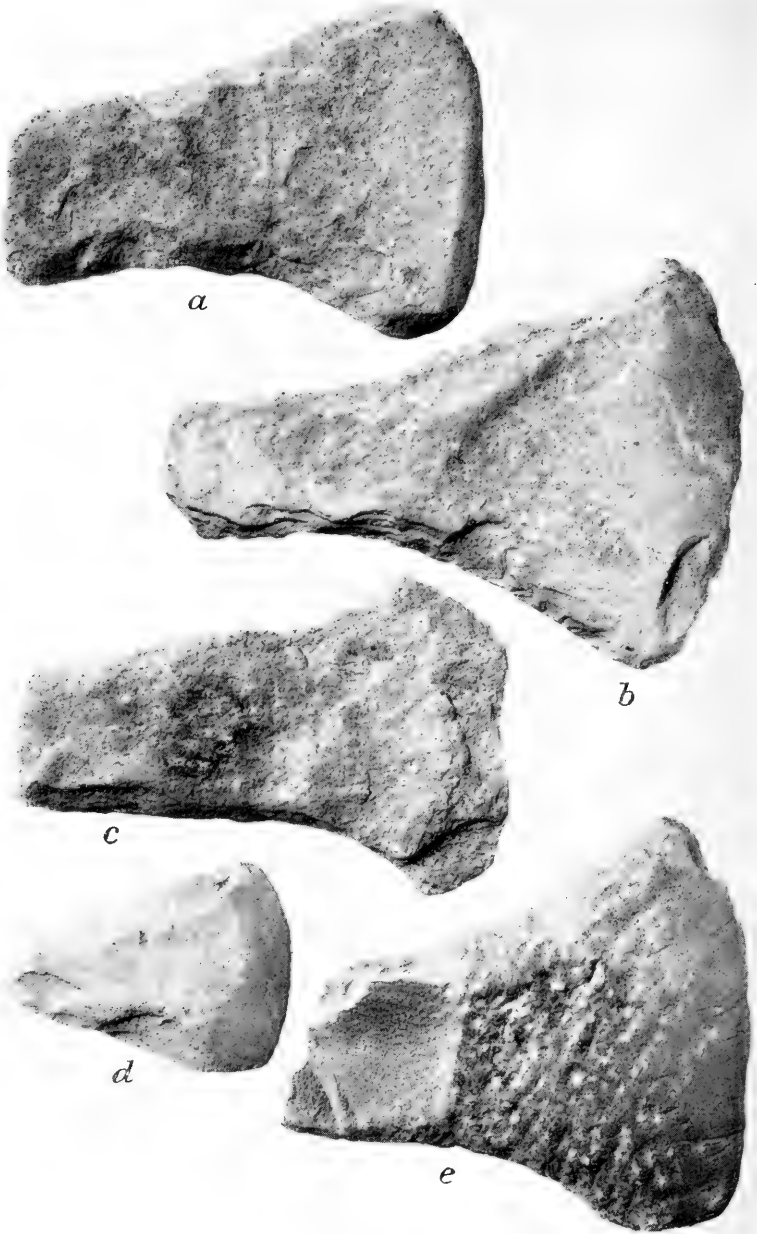

Objects found on the surface, Monasukapanough. $\frac{1}{2}$ natural size.
(U. S. Nat. Mus. Cat. Nos.: a, 350114; b, 350115; c, 350116; d, 350117; e, 350118)

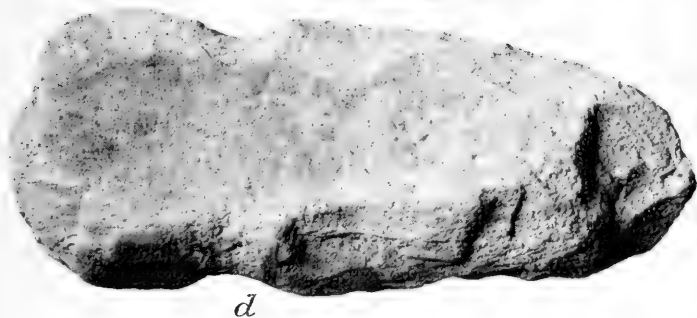
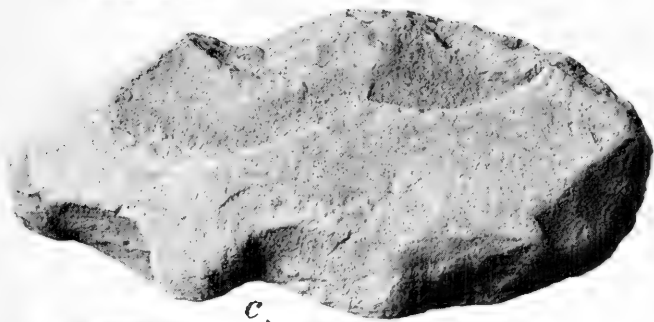
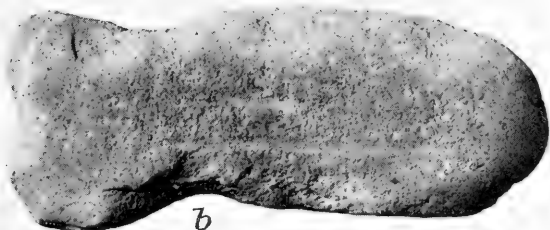

Objects found on the surface, Monasukapanough. $\frac{1}{2}$ natural size.
(U. S. Nat. Mus. Cat. Nos.: *a*, 350120; *b*, 350121; *c*, 350122; *d*, 350123)

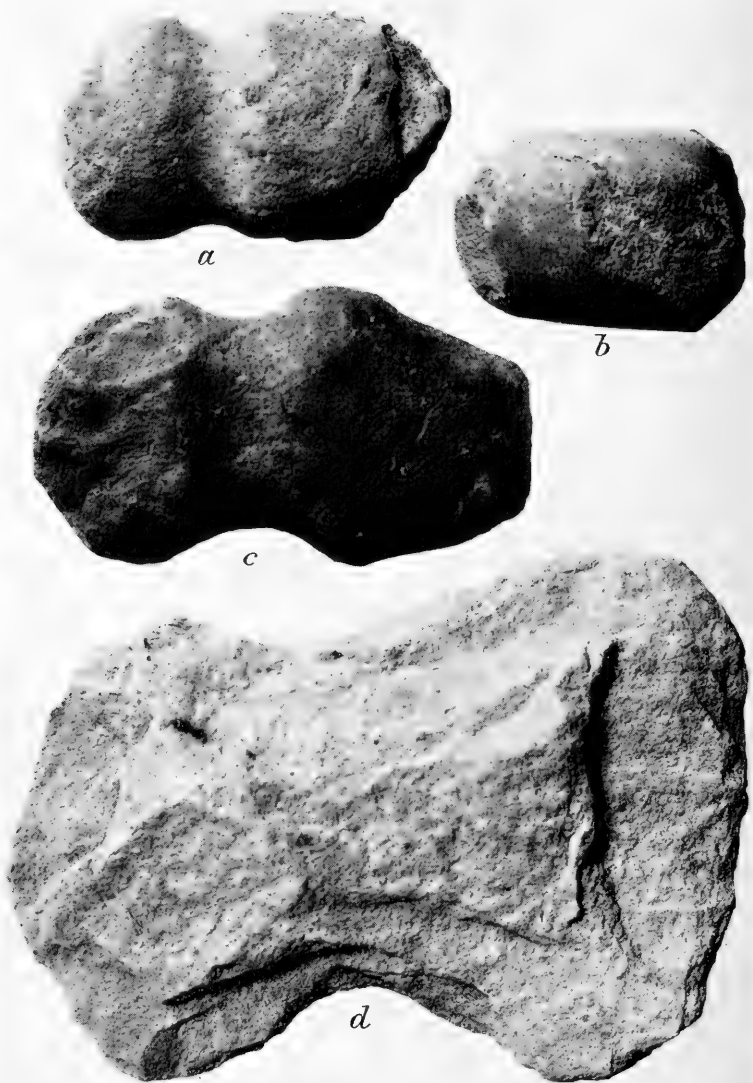

Objects found on the surface, Monasukapanough. $\frac{1}{2}$ natural size.
(U. S. Nat. Mus. Cat. Nos.: a, 350124; b, 350139; c, 350125; d, 350126)

Axes, discoidal stones, and numerous chipped implements are mentioned as having been discovered, but now all are scattered and lost. Undoubtedly a great number of interesting specimens could have been collected at that time, proving it to have been the site of an extensive native village. Evidently Jefferson did not suspect the existence of part of the great village on the side of the river on which the mound stood. He mentioned the hills on the opposite side "on which had been an Indian town," which may have been the more important part of the settlement, as it has now become the more interesting.

ON THE LEFT BANK

Much of that which precedes refers to conditions on the right bank of the Rivanna, but the great village also occupied some ground on the opposite side of the stream. The land on the north or left bank rises rather abruptly from the water, continues quite level for 100 yards or more and then becomes much higher. This comparatively level area of some 20 acres or more is thus bounded on one side by the Rivanna and on the east and north by rising ground which in some places is quite steep. On the west the cliffs approach the river. Several large springs issue from the surface on the site of the village. Before the land was cleared of timber the ground was necessarily irregular and broken, and was traversed by several gullies extending from the bordering cliffs to the river, worn deep by the waters flowing from the springs which would have supplied the wants of the settlement. The area has now been cultivated for many years, the surface leveled and worn down by the plow, but while it remained in its natural condition surrounded as it was by wooded cliffs, it would have appeared hilly and broken; these were the hills on which Jefferson said "had been an Indian town."

The central portion of the level area is the more elevated and slopes gradually to the west and east. It is believed this part has never been covered by the waters of the Rivanna although the lower ground has been overflowed several times within recent years, always leaving deposits of sand and alluvium on the surface.

A general view of the site is reproduced in plate 2. This was taken from the high land on the north. In the foreground is the section north of the river; the course of the stream is indicated by the line of trees bordering its banks. Beyond is the low ground on the right bank of the river, with the cliffs rising in the distance.

Many stone objects have been discovered scattered over the surface of the higher part of the level ground where they may never have been covered by water, even at the times of great freshets. The

specimens have thus remained since they were lost or abandoned by the last inhabitants of the village—believed to have been the Saponi, who left the site some time before the year 1670, although some may have lingered behind. About 70 years later colonists entered the valley of the Rivanna. The ground has now been cultivated for many years and, undoubtedly, numerous objects both large and small have been broken by the plow, but some of unusual interest have been discovered within the past few years.

The material collected on the surface consists of objects of stone, both chipped and polished, and numerous fragments of pottery, many of which bear the imprint of textiles. No specimens made of shell, bone, or metal have been discovered, and nothing of European origin to suggest contact with the colonists has been encountered on the site.

Many of the stone implements, or weapons, are crudely made, but with edges worn and polished as a result of much use. These are seldom broken or incomplete although a number of fragments of well made polished celts have been found, as well as more perfect specimens with only the cutting edge battered or fractured, suggesting rough usage. Perfect or complete objects of the finer workmanship are not found. This fact is difficult to explain unless the better pieces were carried away when, as it is believed, the majority of the people of the village moved to another locality during the latter part of the 17th century. The crudely chipped implements may have been made by the last native inhabitants of the site, thus representing the close of the stone age in this part of Virginia.

The material collected on this very interesting site is now in the United States National Museum and will be briefly described.

A very unusual specimen is shown in plate 3, the photograph being exact size; material, greenish gray chlorite schist. It was found by the writer on the surface near the center of the site, October, 1928. This suggests a human head with a pointed base; extreme height $3\frac{1}{2}$ inches, width $1\frac{3}{4}$ inches, thickness from front to back $1\frac{1}{8}$ inches. The material is comparatively soft and the surface of the stone has probably become smooth and somewhat worn away during the years since it was made, thus losing some of its sharpness and detail which it might otherwise have possessed. The true meaning or purpose of the object is not known, but it at once suggests Beverley's reference to an idol which he discovered in a temple belonging to one of the Algonquian tribes of Virginia, probably about the year 1700. The various parts of the idol were found with the exception of the head, which had been removed and secreted. This small stone head, although found on the site of a Siouan village, may have been some-

thing of the same sort. The pointed projection was undoubtedly fashioned to be inserted in a base or body to hold it in an upright position. Unfortunately very little is known of the customs and beliefs of the people who once occupied the ancient village.

Chipped objects, usually with ground edges and showing evidence of much use, are quite numerous on the site and many have been discovered during the past few years. All are crudely made—rough but apparently well suited for some definite purpose. The actual use of these specimens is not known although the majority may have been implements used in and about the village. Possibly some were hafted to serve as hoes in the gardens, others may have been inserted in wooden handles forming serviceable weapons. Four distinct forms are recognizable but no attempt will be made to distinguish them by name. They will be described and referred to as types A, B, C, and D. Examples of the four types, belonging to the collection, are illustrated in the plates.

Type A, plate 4. This is the simplest form. The great majority are made of greenstone, which occurs on the site. The two specimens at the top of the plate are exceptionally well made—far superior to the average. The cutting edge is sharp and well ground. The three examples below are rather more characteristic and many similar pieces have been recovered. The cutting edge of the largest of the three has been battered and worn away, causing it to become concave, as is shown in the photograph. However, the extremities of the edge, both above and below, are smoothed from use.

Type B, plate 5. These are the most interesting and distinctive objects found on the site. The flaring blade is quite unusual, and the narrow base suggests the use of a wooden handle in which the stone may have been inserted. Similar specimens have been recovered from the site of Monahassanugh, on the bank of the James. (Compare fig. 4.)

Type C, plate 6. Examples of this type are widely distributed throughout piedmont Virginia and eastward. All are recognized by the slight grooves on the narrow, opposite sides. They vary somewhat in detail, but are usually very rough, crudely made, and very often with the surface greatly weathered. These are far more numerous than the better made specimens with ground or polished surfaces and clearly defined grooves. Two of the latter are shown in plate 7.

Type D, plate 7. A type specimen is shown at the bottom of the plate, the distinguishing feature being the two cutting edges at opposite ends. A number of examples of this type have been discovered on the site but the majority are crude and roughly made, some being

fashioned from natural pebbles, and evidently intended for hard usage. However, two other specimens, quite similar to the type specimen which is illustrated, were found. The three were discovered within a very small area. All are rather massive and approximately the same size. The hafting evidently passed across the middle and rested in the two slight grooves. The fourth specimen shown in this plate is a fragment of a well finished implement which, after having been broken, was used as a hammer. The two ends show the effect of long use, being much battered and worn. In this condition it may or may not have been attached to a handle.

With very few exceptions all specimens illustrated in the four plates are made of greenstone or a related rock. Some are more weathered than others, but whether this condition should be attributed to greater age of the object or to the material of which it is made has not been determined.

Small stone objects, in addition to the numerous arrowheads and related forms, are found scattered over the surface of the site of the village. Thus far very few have been recovered, and although they are often fractured, they tend nevertheless to reveal some part of the art of the inhabitants of the ancient settlement. Examples are illustrated in the upper part of plate 8. Top row: *a* is a curious object made of soapstone. It appears to be complete and suggests, in form, the claw of a bear. It is believed to have been a fetish rather than an implement of any sort. Next, *b* is a small stone disk, maximum diameter $1\frac{3}{16}$ inches, thickness $\frac{5}{16}$ inch. It is made of an igneous rock, and the surface is now brownish and greatly weathered. There appear to have been two small perforations on the edge less than $\frac{1}{4}$ inch apart, but this part of the original surface has been broken away, allowing only a section of the perforations to remain. The third specimen on this row, *c*, is a fragment of a well made, polished tablet which had probably been perforated. Its greatest thickness is about $\frac{7}{16}$ inch; material, reddish brown slate.

Below the three pieces just described are four objects which may be termed tools. The use of *d* and *e* is not known, but the two chipped specimens, *f* and *g*, show evidence of having been used as scrapers. Both are made of chert.

On the lower part of plate 8 are shown typical examples of projectile points, *h*, together with some larger pieces which may have served as knives. All are made of grayish quartzite. There is also an excellent example of a disk or blade, *i*, being one of two similar specimens discovered on the surface of the slope of the hill rising just east of the site. The greatest thickness of this piece is less than one inch; material, grayish quartzite.

Fragments of two banner stones were found. Both are made of the same material, a light greenish-gray talc schist. The larger piece represents about one-half of the entire specimen. As restored it is shown in figure 6, full size.

The majority of the arrowheads recovered from the surface of the site are made of the white quartz which is so plentiful throughout the region. And of these more than one-half are of the simple triangular type, without notches. Many are roughly made. Examples are presented in plate 9, figure 2.

Two specimens are illustrated on this plate in addition to the quartz points. Plate 9, figure 1, *a*, is a pitted hammer stone made of quartzite greatly weathered. On it are two pits, on opposite sides. The second

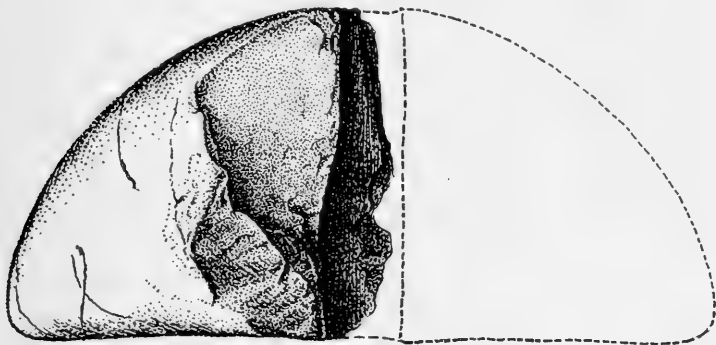

FIG. 6.—Banner stone as restored. Found on the site of Monasukapanough.
Natural size.

(U. S. Nat. Mus. Cat. Nq. 350135)

specimen, *b*, is smooth and worn; material, quartzite; thickness $1\frac{3}{4}$ inches. This may have been a chukey stone, used in the game, although its shape suggests a muller, or *mano* stone, which could have been used in conjunction with a mortar of the form shown in plate 10, figure 2. This mortar was discovered near the center of the site; material, coarse sandstone which occurs on the hill just east of the low ground; extreme length of slab of stone $15\frac{1}{2}$ inches; depth of depression 1 inch.

USE OF SOAPSTONE

A small object made of soapstone has already been described. Three fragments of vessels made of the same material have been found on the surface, but no trace of a tobacco pipe or of an ornament of any sort has been encountered. However, there is proof that small pieces of the stone were worked into shape. It is evident bits of the stone

were carried from the quarries to the village, there to be cut and made into finished products, but what they were has not been discovered.

Four small pieces of soapstone have recently been found on the site, not far from the left bank of the Rivanna and all close together. These show the effect of having been sawed on opposite sides, then broken apart. Three of the specimens are figured in plate 10, figure 1, and reveal clearly the shallow grooves worn in the soft stone during the process of cutting. A piece of stone had probably been used in sawing the comparatively soft material, and this had evidently been quite thick as is indicated by the angle of the cut surface of the remaining portion.

Another specimen of soapstone, showing the effect of sawing and breaking, is in the collection of the National Museum (U. S. Nat. Mus. Cat. No. 170257). This was found at the junction of the Dan and Staunton Rivers, near Clarksville, Mecklenburg County, where the two streams unite to form the Roanoke. Eastward, in the adjoining county of Brunswick, stood Fort Christanna. The region was much frequented by Indians, and the Saponi and Tutelo—the ancient inhabitants of Monasukapanough and Monahassanough—are known to have occupied islands in the Roanoke for a short period during their southern movement, before turning northward to settle at Fort Christanna.

CORDS, TEXTILES, AND BASKETRY AS REVEALED BY IMPRESSIONS ON POTTERY

The journal written by Col. William Byrd while engaged in running the dividing line between Virginia and Carolina contains much interesting information. In it are many references to the beliefs and customs of the Indians, and much of this is believed to have been related by Bearskin, the old Saponi hunter and guide from the village near Fort Christanna, who accompanied the expedition and served it so faithfully.

On November 10, 1728, Byrd wrote in part:¹ "One of the men, who had been an old Indian trader, brought me a stem of silk grass, which was about as big as my little finger. But, being so late in the year that the leaf was fallen off, I am not able to describe the plant. The Indians use it in all their little manufactures, twisting a thread of it that is prodigiously strong. Of this they make their baskets and the aprons which their women wear about their middles, for decency's sake. These are long enough to wrap quite round them and

¹ Byrd, William, *The Westover manuscripts: containing the history of the dividing line. . . .* Petersburg, 1841.

reach down to their knees, with a fringe on the under part by way of ornament.”

The plant to which Byrd referred was undoubtedly a milkweed, probably *Asclepias pulchra*, often termed Indian hemp, and known to many persons in this part of Virginia as silk weed. The long fiber is easily detached from the stalk, and when twisted forms a very tough and strong cord.

Milkweed is plentiful throughout the region, and the fiber derived from the stem was undoubtedly used by the people who occupied the ancient village which stood on the banks of the Rivanna. Innumerable small fragments of pottery have been recovered from the surface of the site, many of which bear the imprint of cords or of basketry. These fragments have been found on both sides of the river, but all examples to be considered at this time have been collected on the left bank and, with few exceptions, have been found within 50 yards of the water. The land has been plowed and harrowed for many years and as a consequence it is seldom that a piece of pottery more than an inch in length can be discovered. Much of it may never have been very hard and the bits have now worn away until the impressions on the surface of many have become faint and scarcely discernible. Casts of nine small pieces are shown natural size in plate 11, figure 2. These are the clearest impressions selected from several hundred.

The specimen in the middle of the top row is unusually hard and compact, and for that reason the impression of cords has remained very clear and distinct. It is an interesting fragment, but whether it represents basketry or cloth has not been determined. On either side of this are examples of coarser cords. The small triangular fragment in the middle of the bottom row, and likewise the specimen on the left, is believed to represent a form of basketry. No piece yet found bears the imprint of a coarse, net-like material.

White quartz, pulverized or reduced to very small pieces, was mixed with the clay of which the vessels were made.

As mentioned, the great majority of fragments of pottery have been found near the left bank of the river, where the ground is relatively high and has seldom been overflowed. A few pieces of rock showing the effect of fire together with small bits of charcoal have been revealed by the plow near the highest point of the bank, some 20 yards from the water. Quantities of flakes of quartz, quartzite, chert, and some of jasper occur on this part of the site, and near by were found the several pieces of worked soapstone already described. This may have been a much frequented section of the village and possibly sweat houses once occupied the high ground overlooking

the water, with the mat- or bark-covered habitations scattered through the surrounding wooded area—now cultivated lands where the crude stone implements are found.

Many objects have already been recovered from the site but it is expected that others, of equal or even greater interest, may be discovered during the continued examination of the area, to be described at another time.

THE "SAPPONEY INDIAN TOWN"

There is no known record of a white man having visited Monasukapanough, the ancient Saponi village on the banks of the Rivanna, and consequently no description of the settlement has been preserved. It was probably an extensive and important center. It is believed that some time before the year 1670 the people, or at least the greater part of them, moved from the valley of the Rivanna and went southward to establish a new village which, according to Mooney, "was probably on Otter river, a northern tributary of the Roanoke, in what is now Campbell county, Virginia, nearly south of Lynchburg."¹ Here they were visited by Lederer in 1670, and by the Batts party during the following year, but these explorers failed to describe the settlement. Soon the movement was resumed; they wandered far, nearly reaching the center of North Carolina, later returning to Virginia.

A generation after their first contact with Europeans, through the influence of Governor Spotswood, the Saponi and remnants of other tribes became established in the vicinity of Fort Christanna, about 10 miles north of Roanoke River, in the present Brunswick County, Virginia.

Although the Saponi had undoubtedly changed greatly from their primitive state, yet they must have retained many of the manners and ways of life practiced in earlier years at their ancient home on the Rivanna. An interesting and at this time most valuable account of the people as they appeared in the spring of 1716 is to be found in the journal of one who visited them at that time.² The journal is a record of a journey made by Fontaine and Governor Spotswood from Williamsburg to Fort Christanna and return during the first ten days of April, 1716. To quote from the journal: "*The 5th day.*—After breakfast, I went down to the Sapponey Indian town, which is about a musket-shot from the fort. I walked round to view it. It lieth in

¹ *Op. cit.*, p. 34.

² Journal of John Fontaine. In *Memoirs of a Huguenot family*, by Ann Maury. New York, 1853.

a plain by the river-side, the houses join all the one to the other, and altogether make a circle; the walls are large pieces of timber which are squared, and being sharpened at the lower end, are put down two feet in the ground, and stand about seven feet above the ground. These posts are laid as close as possible the one to the other, and when they are all fixed after this manner, they make a roof with rafters, and cover the house with oak or hickory bark, which they strip off in great flakes, and lay it so closely that no rain can come in. Some Indian houses are covered in a circular manner, which they do by getting long saplings, sticking each end in the ground, and so covering them with bark; but there are none of the houses in this town so covered. There are three ways for entering into this town or circle of houses, which are passages of about six feet wide, between two of the houses. All the doors are on the inside of the ring, and the ground is very level withinside, which is in common between all the people to divert themselves. There is in the centre of the circle a great stump of a tree; I asked the reason they left that standing, and they informed me it was for one of their head men to stand upon when he had anything of consequence to relate to them, so that being raised, might the better be heard." Continuing he described briefly the interior of the structures: "Their houses are pretty large, they have no garrets, and no other light than the door, and that which comes from the hole in the top of the house which is to let out the smoke. They make their fires always in the middle of the house; the chief of their household goods is a pot and some wooden dishes and trays, which they make themselves; they seldom have any thing to sit upon, but squat upon the ground; they have small divisions in their houses to sleep in, which they make of mats made of bullrushes; they have bedsteads, raised about two feet from the ground, upon which they lay bear and deer skins, and all the covering they have is a blanket. These people have no sort of tame creatures, but live entirely upon their hunting and the corn which their wives cultivate. They live as lazily and miserably as any people in the world.

"Between the town and the river, upon the river side, there are several little huts built with wattles, in the form of an oven, with a small door in one end of it; these wattles are plaistered without side very closely with clay, they are big enough to hold a man, and are called sweating-houses. When they have any sickness, they get ten or twelve pebble stones which they heat in the fire, and when they are red-hot they carry them into these huts, and the sick man or woman goes in naked, only a blanket with him, and they shut the

door upon them, and there they sit and sweat until they are no more able to support it, and then they go out naked and immediately jump into the water over head and ears, and this is the remedy they have for all distempers."

The appearance of the Indians, and the manner in which the Governor was received the day of his arrival at the fort, was told by Fontaine. He wrote in his journal: "About three of the clock, came sixty of the young men with feathers in their hair and run through their ears, their faces painted with blue and vermilion, their hair cut in many forms, some on one side of the head, and some on both, and others on the upper part of the head, making it stand like a cock's-comb, and they had blue and red blankets wrapped about them. They dress themselves after this maner when they go to war the one with the other, so they call it their war dress, and it really is very terrible, and makes them look like so many furies. These young men made no speeches, they only walked up and down, seeming to be very proud of their most abominable dress.

"After this came the young women; they all have long straight black hair, which comes down to the waist, they had each of them a blanket tied round the waist, and hanging down about the legs like a petticoat. They have no shifts, and most of them nothing to cover them from the waist upwards; others of them there were that had two deer skins sewed together and thrown over their shoulders like a mantle. They all of them grease their bodies and heads with bear's oil, which, with the smoke of their cabins, gives them an ugly smell. They are very modest and very true to their husbands. They are straight and well limbed, good shape, and extraordinary good features, as well the men as the women. They look wild, and are mighty shy of an Englishman, and will not let you touch them. The men marry but one wife, and cannot marry any more until she die, or grow so old that she cannot bear any more children; then the man may take another wife, but is obliged to keep them both and maintain them. They take one another without ceremony."

The children were bound to boards that were "cut after the shape of the child," with two pieces at the bottom to which the child's legs were tied. A cord passed through a hole in the top of the board with which it could be attached to a limb of a tree, "or to a pin in a post for that purpose, and there the children swing about and divert themselves, out of the reach of any thing that may hurt them." They were kept in this manner until they were about two years of age.

Governor Spotswood was evidently greatly interested in the Indians and on April 6, 1716, "asked the boys to dance a war dance,

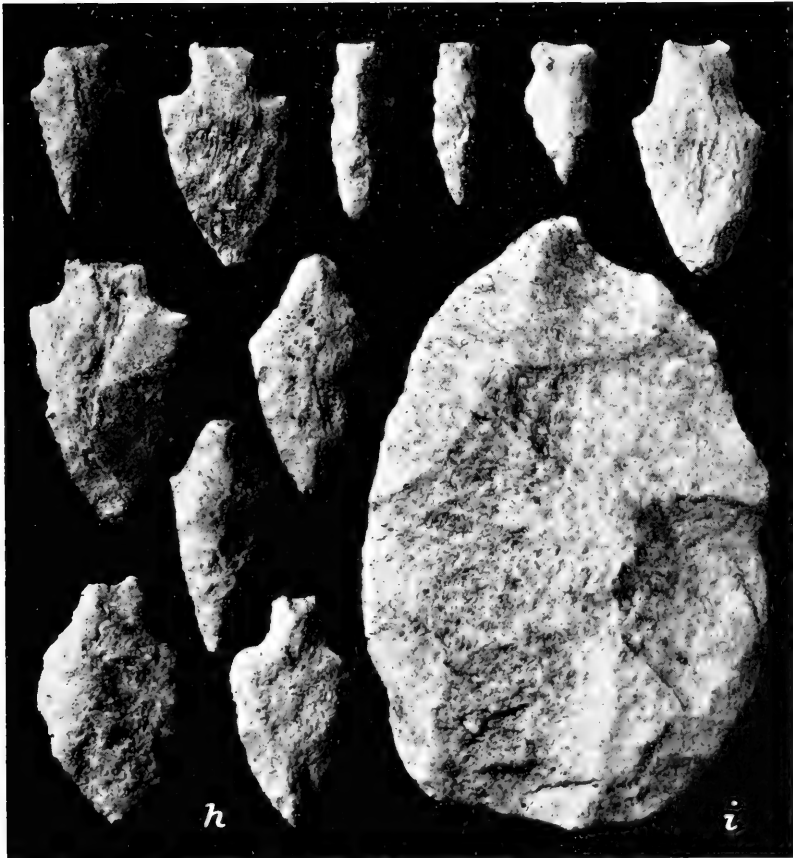
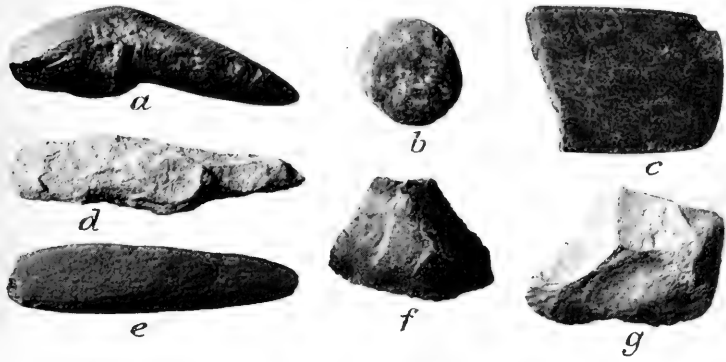

Objects found on the surface, Monasukapanough. $\frac{1}{2}$ natural size.

(U. S. Nat. Mus. Cat. Nos.: a, 350130; b, 350133; c, 350134; d, 350131; e, 350132; f, g, 350145; h, 350150; i, 350148)



1. *a*, pitted stone; *b*, mano stone, Monasukapanough. $\frac{1}{2}$ natural size.
(U. S. Nat. Mus. Cat. Nos.: *a*, 350140; *b*, 350141)

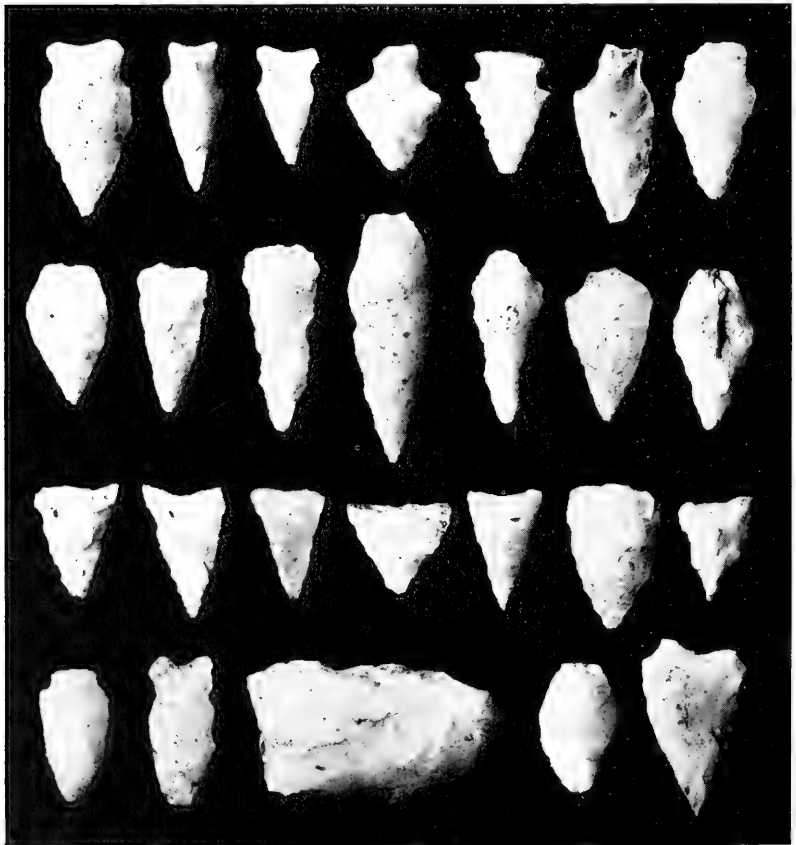

2. Objects found on the surface, Monasukapanough. $\frac{1}{2}$ natural size.
(U. S. Nat. Mus. Cat. No. 350151)

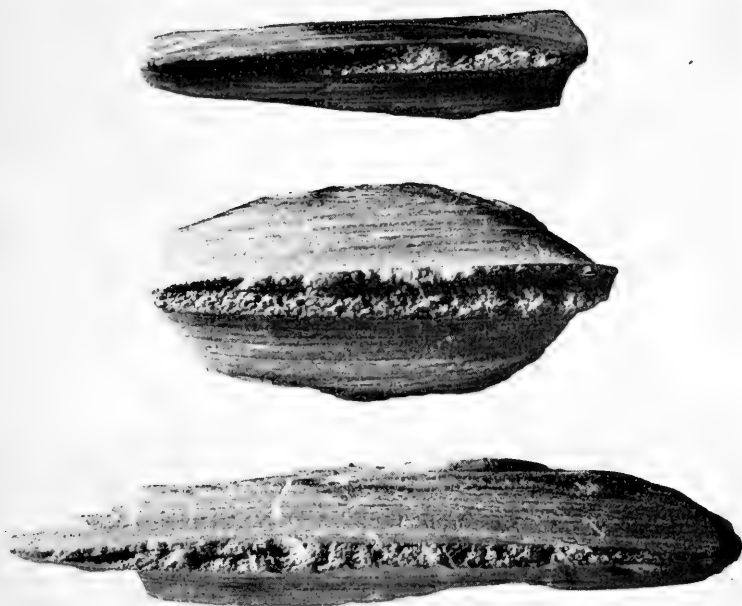

1. Three pieces of soapstone showing the effect of sawing, Monasukapanough.
Natural size.

(U. S. Nat. Mus. Cat. No. 350137)

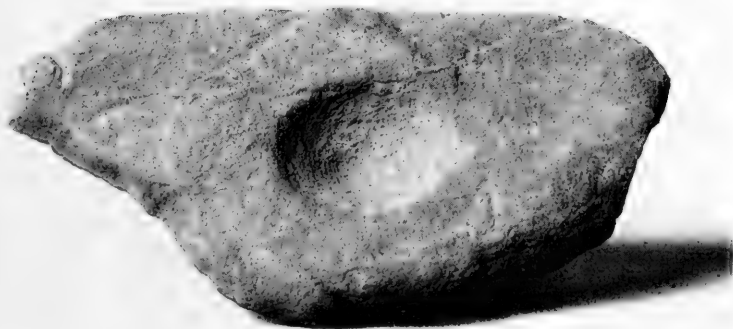

2. Sandstone mortar, Monasukapanough. About $\frac{1}{4}$ natural size.

(U. S. Nat. Mus. Cat. No. 350142)



1. Fragments of rims of vessels, Monasukapanough. Natural size.

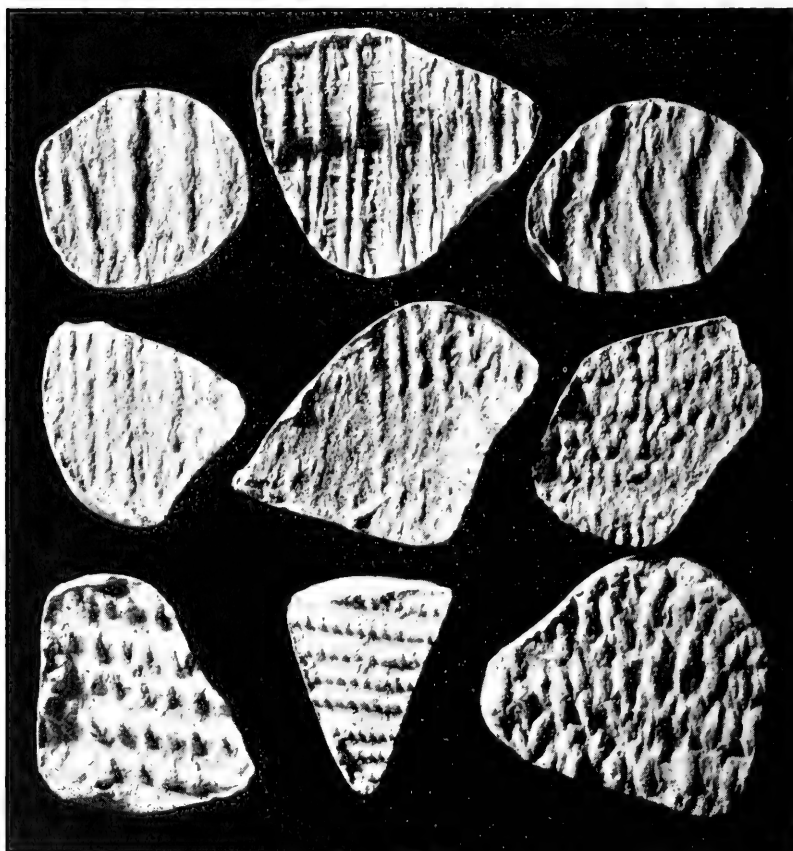

2. Casts of impressions on fragments of pottery, Monasukapanough.
Natural size.

(U. S. Nat. Mus. Cat. No. 350154)

so they all prepared for it, and made a great ring; the musician being come, he sat himself in the middle of the ring; all the instrument he had was a piece of board and two small sticks; the board he set upon his lap, and began to sing a doleful tune, and by striking on the board with his sticks, he accompanied his voice; he made several antic motions, and sometimes shrieked hideously, which was answered by the boys. As the men sung, so the boys danced all round, endeavoring who could outdo the other in antic motions and hideous cries, the movements answering in some way to the time of the music. All that I could remark by their actions was, that they were representing how they attacked their enemies, and relating one to the other how many of the other Indians they had killed, and how they did it making all the motions in this dance as if they were actually in the action."

It is within reason to believe that among the Indians who gathered at the Saponi village early in April, 1716, to greet Governor Spotswood were some who, as children, had lived at Monasukapanough on the banks of the Rivanna. But during that period of wandering, changes had taken place in the habits and ways of life of the people; nevertheless much that was witnessed and recorded by Fontaine had probably been similarly enacted long before at the older town. The earthen pots and wooden dishes and trays, the mats made of bulrushes, the mantles made of two deer skins sewed together, and the small sweat houses standing near the river bank—all were details that would have been seen at the more primitive town on the Rivanna.

In 1728, 12 years after Governor Spotswood's visit to Fort Christanna, the line between Virginia and North Carolina was being run westward from the coast. On September 29 Col. William Byrd, of the Virginia commission, secured a Saponi Indian from the village near the fort to serve as guide and hunter for the party during the latter part of their journey through the wilderness. To the English he was known as Bearskin. He was worthy and capable, and kept the camp well supplied with game. On Sunday, October 13, he explained the religion of the Saponi which was recorded at length by Byrd—¹ a remarkable account of the primitive beliefs of a tribe of which so little is known.

The habitations at the Saponi village near Fort Christanna, as described by Fontaine in 1716, were quite unusual and are believed to have been of English conception. It is doubtful if any structure of a similar nature ever stood at Monasukapanough, where the small

¹ *Op. cit.*, p. 51.

habitations were undoubtedly the typical mat- or bark-covered lodges. But strongly made log structures were to have been encountered elsewhere in Virginia, and their occurrence was likewise recorded by Fontaine. In the month of June, the year before he visited the Saponi settlement with Governor Spotswood, Fontaine made a journey from Williamsburg to the German colony on the Rappahannock. He had crossed the Mattaponi and was in King William County when at some point on the left or north bank of the river, possibly about due north of the present Pamunkey Indian Reservation, he encountered a single Indian habitation. This was June 12, 1715, and he wrote in his journal that day:¹ "The day very windy. We see by the side of the road an Indian cabin, which was built with posts put into the ground, the one by the other as close as they could stand, and about seven feet high, all of an equal length. It was built four-square, and a sort of a roof upon it, covered with the bark of trees. They say it keeps out the rain very well. The Indian women were all naked, only a girdle they had tied round the waist, and about a yard of blanketing put between their legs, and fastened one end under the fore-part of the girdle, and the other behind. Their beds were mats made of bulrushes, upon which they lie, and have one blanket to cover them. All the household goods was a pot." Unfortunately Fontaine failed to record the name of the tribe to which this family belonged, but the lodge, its surroundings and the condition of its occupants, were probably characteristic of the time and country and were in no way exceptional. Indian families such as this, living off and apart from others, would undoubtedly have been found in many parts of tide-water and piedmont Virginia. And after the towns of Mowhemcho, Massinacack, and Rassawek ceased to be important settlements, as they were during the early years of the 17th century, many isolated cabins would have been encountered within "The Land called the Monscane."

The five Monacan towns, as they are known to have stood early in the 17th century, have now been mentioned. It is believed the identification of the sites is accurate and conclusive. And although the exact position of Rassawek has not been determined, it must be agreed that the settlement was situated somewhere within a rather restricted area between the James and Rivanna, on or near the right bank of the latter stream and not far from its mouth. No other Monacan villages were referred to by the early writers and if any existed they have been lost to history. But throughout the entire

¹ *Op. cit.*, p. 264.

region once dominated by the Siouan tribes—a region embracing the valley of the James from the falls to the mountains, where wild game was abundant and food easily procured—are to be found traces of the period of Indian occupancy; village and camp sites on the banks of streams, quarries where soapstone was obtained, and innumerable stone implements scattered over the surface. However, as said elsewhere, all must not be attributed to the Monacan tribes.

Scattered sites have been visited and examined and it is planned to describe them, together with the material collected, in a subsequent paper. Two localities will now be mentioned, both on the banks of the Rivanna, one above, the other below the site of Monasukapanough, and both believed to have been in some manner related to the great village.

GARNETT SITE

The site of the large village, believed to have been Monasukapanough, is on the banks of the South Branch of the Rivanna, the

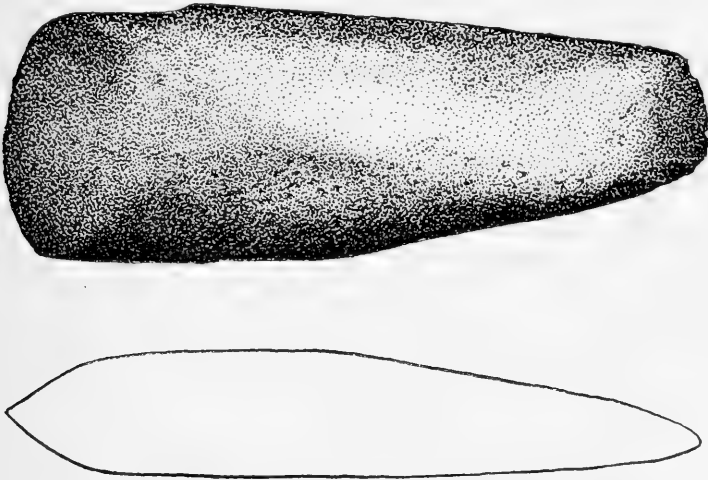

FIG. 7.—Double edged instrument found on the Garnett site. Natural size.

(U. S. Nat. Mus. Cat. No. 350156)

lesser North Branch joining it about 2 miles below. Some 7 miles above this site, and 1 mile or more below the junction of Moormans River and Mechum River—two streams which unite to form the South Branch of the Rivanna—is one of the best places for fishing on the entire river. On the right bank are great masses of rock against which the water flows to a depth of 10 feet or more. Cliffs reach near the bank on the opposite side. The water is usually clear and cold,

and shaded along the banks by overhanging trees. Just below this point a small creek flows into the Rivanna from the right or south. Evidences of a camp have been discovered near the creek, but whether it was large or small cannot be determined as the land has been cultivated for many years and the surface has often been covered by the waters of the river. Many objects of stone and some fragments of pottery have been found. The material is identical with that collected from the surface at Monasukapanough, which suggests that this may have been a fishing camp belonging to the people of the large village. The characteristic chipped ax- or celt-like implements are found here and the arrowheads are typical. One specimen from the site is quite rare. A small double edged chisel or celt, made of greenstone, $3\frac{5}{8}$ inches in length. It is shown exact size in figure 7.

This is a beautiful spot, secluded and well protected, and could have been reached by canoe from the large settlement down the river.

MOON SITE

Jefferson described the mound which he examined as being on the low grounds of the Rivanna "about two miles above its principal fork." The "principal fork" is now known as the North Branch. Where the two branches unite the main stream bends and flows in a more southerly course. A wide bottom on the right extends far above and below the mouth of the North Branch, on the opposite side, but this is quite low and consequently often overflowed. Traces of an encampment were discovered near the south end of the low ground, back from the river where the surface begins to rise. Several stone implements, bits of pottery, and a single fragment of a well-finished soapstone vessel were found scattered over the surface. Also many chips of white quartz, and larger masses of the same from which smaller pieces had been broken. Two small, crudely made, grooved implements were found on the higher ground not far from the residence. They are typical examples of the widely distributed form shown in plate 6.

High rugged cliffs rise a short distance from the left bank of the river, opposite the southern part of the low grounds on the Moon plantation. Quantities of white quartz encountered here may have been one source of material for the making of arrowheads, and the pieces discovered on the Moon site had probably been carried across the stream from this outcropping. The cliffs and low grounds on the left side of the river are heavily timbered and with much undergrowth, and as a consequence it is very difficult to discover any traces of Indian occupancy.

A cairn formed of rather small stones, shown in plate 12, figure 2, about 3 feet in height and 15 feet in diameter, stands on the summit of the cliff overlooking this part of the low grounds. The cliff is here a narrow ridge and the cairn commands an extensive view of the county westward to the Blue Ridge and in the opposite direction across the intervening valley to the South Western Mountain. This is about 1 mile below the mouth of the North Branch.

The map of Virginia and Maryland, drawn by Augustin Herrman, was completed in 1670 but not engraved and issued until three years later. No Monacan towns are indicated on the banks of the James or of its tributaries. Lederer made his journey up the valley of the James during the months of May and June of that year, but evidently his travels were not known to Herrman until the appearance of his brief volume of "Discoveries" which was printed in London in 1672. The engraving of the map may already have been completed by William Faithorne in England and consequently it would have been too late for Herrman to have added the newly acquired data.

The Herrman map shows the course of the James, with one large tributary far to the westward. This was probably the Rivanna, known from the earliest days of the colony. A legend on the map, placed north of the latter stream, reads thus:

Mount Edlo This name derives from a Person that was in his
Infancy taken Prisoner in the last Massacra over Virginia,
And carried amongst others to this Mount, by the Indians,
which was their watch Hill, the country there about being
Champion and not much Hilly.

Mr. Fairfax Harrison has suggested to the writer the possibility of *Mount Edlo* being some point in Albemarle County west of where the Rivanna passes the South Western Mountain. If this is correct the high narrow ridge, surmounted by the cairn, may have been the spot indicated. The great village, Monasukapanough, was less than 3 miles distant, and the entire region shows evidence of Indian occupancy. The country had probably not been seen by a European and the description of the land, as recorded in the legend, was necessarily vague and uncertain.

SOAPSTONE

Steatite, or soapstone, is found in several localities in the region between the Rivanna and the James. It was quarried and used by the Indians, and what is believed to be the most extensive quarry worked by them within these bounds was discovered in 1926, on a high ridge

a short distance south of Damon, Albemarle County. It is about 2 miles in a direct line north of east from Schuyler, and between 5 and 6 miles northwest from the nearest point on the left bank of the James. Schuyler is on the banks of Rockfish River, some 6 miles above its mouth, in Nelson County. Since 1926 the surface has been stripped and quarries have been opened on the site, thus destroying traces of the work done by Indians before the coming of Europeans to this part of Virginia.

When visited in 1926¹ great masses of soapstone outcropped on the surface. These followed a general direction from southwest to northeast and had a dip of about 60° to the southeast. The broken, irregular surface was heavily timbered, and evidently the entire region had changed little in appearance during the past centuries. Near by

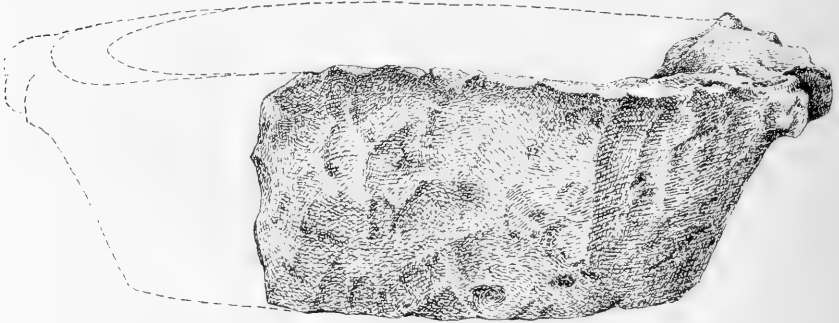

FIG. 8.—Fragment of an unfinished flat-bottomed soapstone vessel. $\frac{1}{3}$ natural size.
(U. S. Nat. Mus. Cat. No. 332025)

were several large springs. For 1,000 feet or more along the ridge it was possible to trace the pits, dug by Indians generations ago, from which quantities of soapstone had been removed. Twenty or more excavations were thus discovered and probably others were so filled with the accumulated mold and moss as not to have been distinguishable. The pits varied from 10 to 30 feet in diameter and appeared to have been from 2 to 4 feet in depth. Some were quite distinct; others may have been joined beneath the mass of mold and thus in reality have been parts of a large excavation.

The surface surrounding the pits was covered with pieces of the stone, some large, others small, which had been removed from the quarries and evidently rejected as being unfit for use. But only a

¹ Bushnell, David I., Jr., Ancient soapstone quarry in Albemarle County, Virginia. Journ. Washington Acad. Sci., Vol. 16, No. 19, November 18, 1926.

small amount of the stone was visible, or projected through the thick vegetal mold which had formed since the quarries were last used by the Indians (pl. 13).

Many broken, unfinished vessels were discovered in the vicinity of the pits. These had been fractured in the process of making and abandoned as useless. Consequently this was not only a quarry but a workshop, where the vessel was fashioned in the rough, later to be smoothed and polished.

That two types of bowls were made here is indicated by the many fragments recovered from the surface in the vicinity of the pits. One type had a flat bottom; in the second type it was more rounded. An admirable example of the first form, found near one of the pits on the northern part of the ridge, is shown in plate 14, figure 1; length

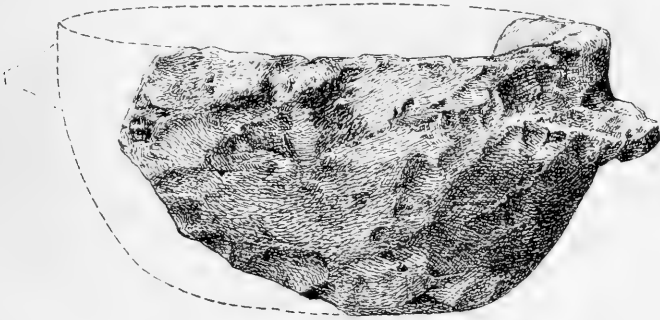

FIG. 9.—Fragment of an unfinished, round-bottomed soapstone vessel.
 $\frac{1}{3}$ natural size.

(U. S. Nat. Mus. Cat. No. 332024)

about 17 inches. It is very rough and unfinished, and the surface reveals distinctly the irregular cuttings made by crude stone implements. One side had been broken, probably while it was being hollowed out, and the vessel discarded. No attempt had been made to smooth or finish the surface, either within or without. The knobs to serve as handles project from the upper edge, at ends.

The second type, with rounded bottom, usually has knobs extending from the ends an inch or more below the upper rim to serve for handles. The two forms shown in figures 8 and 9 are examples found on the surface near the pits. Of the latter type are the two fractured specimens said to have been discovered in a cultivated field near the foot of Buck Mountain, in Buckingham County. This would be a short distance south of the right bank of the James, and a few miles from the extensive village site, believed to have been Monahassanugh, between Norwood and Wingina, in Nelson County on the opposite side of the river. The two specimens, as restored, are shown in plate

14, figure 2. The smaller is in the collection of the United States National Museum. The inside diameters are $13\frac{3}{4}$ inches and $10\frac{3}{4}$ inches; depth $5\frac{3}{4}$ inches; thickness from $\frac{1}{2}$ to $\frac{3}{4}$ inch. The larger specimen, not in the Museum collection, is of the same proportions but with a maximum diameter, inside, of $16\frac{3}{4}$ inches.

Innumerable vessels and smaller objects were undoubtedly made in the vicinity of the quarries to be carried away to distant villages, as well as for use in nearby camps; nevertheless very few pieces of soapstone vessels are found. Several small fragments have been discovered on the site of Monasukapanough, together with four pieces of the material that had been sawed. This latter may have been obtained from an outcropping a few miles north of the ancient site. Another small fragment of a well finished vessel was encountered on the Moon site, already mentioned. Two tobacco pipes made of soapstone are said to have been found some years ago on a ridge just east of the Southern Railway at Arrowhead, about 8 miles south of the University of Virginia. They were not seen by the writer but were described as being quite small and very well made. The lack of more traces of soapstone on the village and camp sites is difficult to explain. Many vessels were made and used, as shown by evidence at the quarries, but all have disappeared.

The quarries south of Damon may be the most extensive group worked by Indians in this immediate section of Virginia, but there are several other localities where soapstone was obtained and vessels made. Extensive quarries, possibly worked by the people of the ancient village of Monahassanugh, are situated midway between Norwood, on the left bank of the James at the mouth of Buffalo River, and Arrington, a small station on the Southern Railway in Nelson County. Many broken, unfinished vessels have been discovered here, and the two specimens shown in plate 14, figure 2, may have been made at this quarry. Another quarry, not visited by the writer, is in Goochland County about $8\frac{1}{2}$ miles in a direct line northeast of the site of Rassawek, at the mouth of the Rivanna, and $1\frac{1}{2}$ miles due south of the present village of Tabscott.

There are other outcroppings of soapstone in the region, in addition to those already mentioned, which show evidence of having been worked by Indians. And although all are well within the bounds of the territory occupied by the Monacan tribes, the last of the native tribes to claim this part of Virginia, the soft stone may have been discovered and worked by others who had preceded them. Nor is the scarcity of objects made of soapstone less mysterious than the identity of the tribes by whom the quarries were opened and the utensils and ornaments fashioned.



1. Looking east across the Rivanna, up the valley of the North Fork.



2. Cairn on summit of cliff below mouth of the North Fork.



1. Slope near a pit showing fragments of soapstone scattered over the surface.

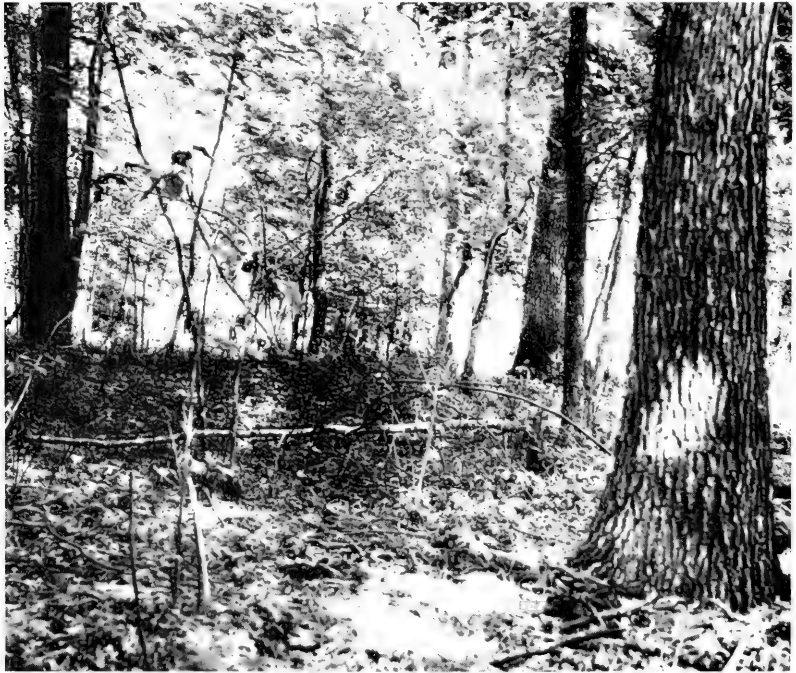

2. One of the larger pits worked by the Indians.



1. Unfinished soapstone vessel from quarry south of Damon.
About $\frac{1}{4}$ natural size.

(U. S. Nat. Mus. Cat. No. 332023)

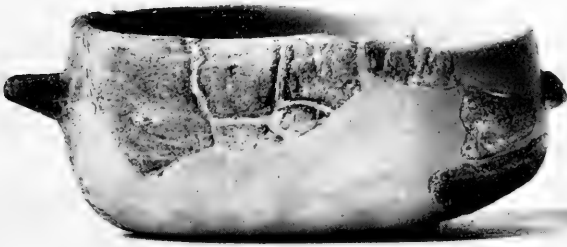

2. Two soapstone vessels, restored, from near foot of Buck Mountain,
Buckingham County, Virginia.

(Upper, U. S. Nat. Mus. Cat. No. 342083; lower, owned by Mrs. Wirt Robinson)

SMITHSONIAN MISCELLANEOUS COLLECTIONS

VOLUME 82, NUMBER 13

A NOTE ON THE SKELETONS OF TWO
ALASKAN PORPOISES

(WITH ONE PLATE)

BY

GERRIT S. MILLER, JR.

Curator, Division of Mammals, U. S. National Museum



(PUBLICATION 3107)

CITY OF WASHINGTON

PUBLISHED BY THE SMITHSONIAN INSTITUTION

DECEMBER 23, 1930

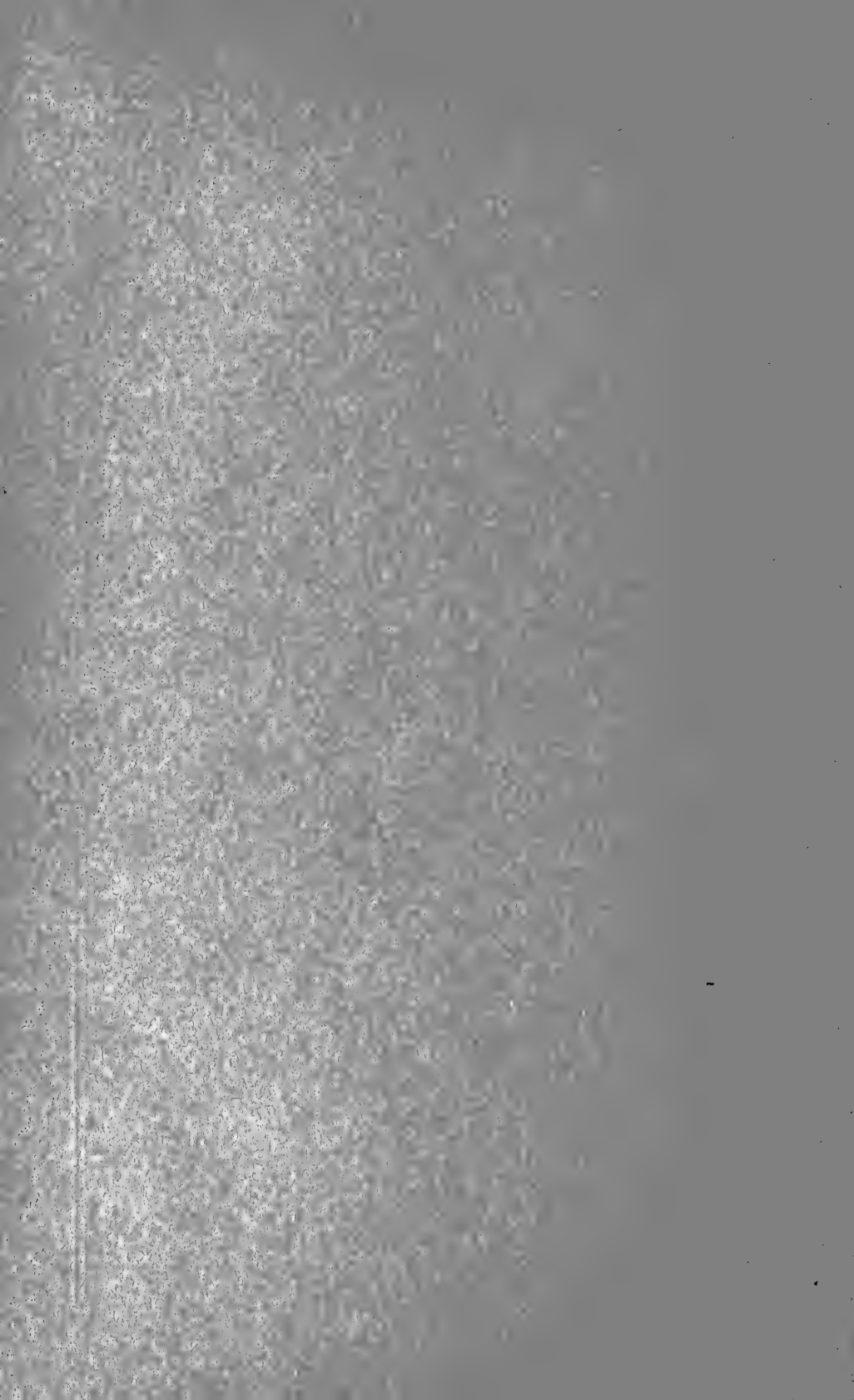

SMITHSONIAN MISCELLANEOUS COLLECTIONS
VOLUME 82, NUMBER 13

A NOTE ON THE SKELETONS OF TWO ALASKAN PORPOISES

(WITH ONE PLATE)

BY

GERRIT S. MILLER, JR.

Curator, Division of Mammals, U. S. National Museum



(PUBLICATION 3107)

CITY OF WASHINGTON
PUBLISHED BY THE SMITHSONIAN INSTITUTION
DECEMBER 23, 1930

The Lord Baltimore Press
BALTIMORE, MD., U. S. A.

A NOTE ON THE SKELETONS OF TWO ALASKAN PORPOISES

BY GERRIT S. MILLER, JR.

CURATOR, DIVISION OF MAMMALS, U. S. NATIONAL MUSEUM

(WITH ONE PLATE)

Skeletons of two Alaskan porpoises, *Phocæna phocæna* (Linnæus) and *Phocænoides dalli* (True), have recently been mounted in the United States National Museum. Before these skeletons were placed on exhibition the photographs were made that are reproduced on the plate accompanying this article.

In his original account of *Phocænoides* (Bull. Amer. Mus. Nat. Hist., Vol. 30, pp. 31-50, May 16, 1911) Andrews figured the skull, jaw, hyoids, sternum, scapula, flipper, and several vertebrae; but these individual parts fail to give an adequate idea of the striking peculiarities of the genus as compared with its relative *Phocæna*. Chief among these peculiarities are the length and slenderness of the chevron bones, of the ribs (length of longest rib contained about $4\frac{1}{2}$ times in length of vertebral series, as compared with $5\frac{1}{2}$ times in *Phocæna*), and of the dorsal spines (longest spines contained about $10\frac{1}{2}$ instead of $17\frac{1}{2}$ times in length of vertebral series); the shortness (or compression) of the vertebral centra by virtue of which the 45 centra of the dorso-lumbar series are crowded into appreciably less space than that occupied by only 29 dorso-lumbar centra in *Phocæna*. Particularly noticeable also are the differences in form of the scapula, arm and hand.

In the great height of the dorsal spines and the compression of the centra *Phocænoides* appears to be unique among living members of the family Delphinidæ. There is no approach to these conditions in the genus *Neomeris*.

The two skeletons, as mounted, are of the same length, 1,760 cm. In the *Phocæna* the depth of chest, including vertebral spines, is about 30 cm., while in the *Phocænoides* it is about 44 cm.

Considering the peculiarities of the skeletons, the skulls of *Phocæna* and *Phocænoides* are remarkably alike. In the teeth and gums, however, the differences are pronounced.¹

¹ See Miller, Proc. U. S. Nat. Mus., Vol. 74, Art. 26, pp. 1-4, pls. 1-4, January 26, 1929.

EXPLANATION OF PLATE

Both figures greatly reduced to approximately uniform scale

UPPER FIG. *Phocæna*. No. 218737, U. S. Nat. Mus. Collected at St. George Island, Alaska, by C. D. Hanna.

LOWER FIG. *Phocænoides*. No. 219334, U. S. Nat. Mus. Collected near Wrangell, Alaska, by E. P. Walker. (The skull is tilted slightly to the right. This exaggerates the flatness of the rostrum as compared with the rostrum of *Phocæna*.)

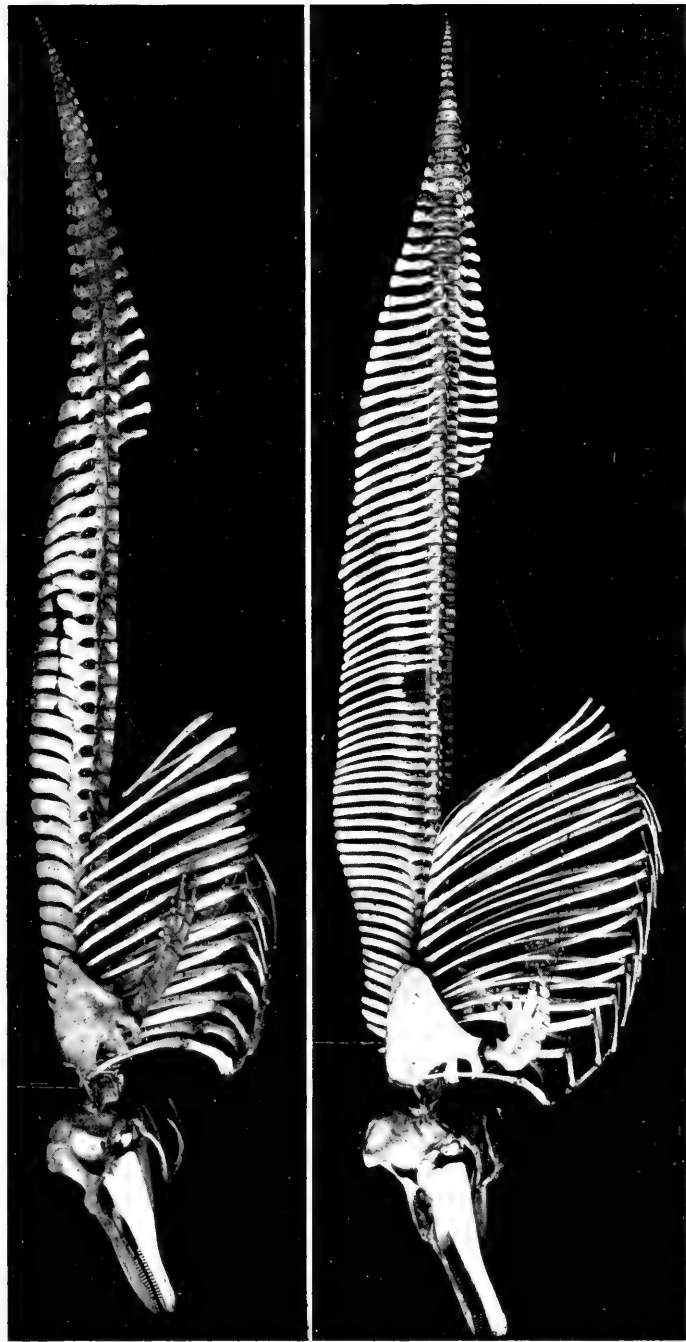

Upper figure, *Phocaena phocaena*.
Lower figure, *Phocaenoides dalli*.



SMITHSONIAN MISCELLANEOUS COLLECTIONS
VOLUME 82, NUMBER 14

THE SUPPOSED OCCURRENCE OF AN ASIATIC
GOAT-ANTELOPE IN THE PLEISTOCENE
OF COLORADO

(WITH TWO PLATES)

BY
GERRIT S. MILLER, JR.
Curator, Division of Mammals, U. S. National Museum



(PUBLICATION 3108)

CITY OF WASHINGTON
PUBLISHED BY THE SMITHSONIAN INSTITUTION
DECEMBER 22, 1930

SMITHSONIAN MISCELLANEOUS COLLECTIONS

VOLUME 82, NUMBER 14

THE SUPPOSED OCCURRENCE OF AN ASIATIC
GOAT-ANTELOPE IN THE PLEISTOCENE
OF COLORADO

(WITH TWO PLATES)

BY

GERRIT S. MILLER, JR.

Curator, Division of Mammals, U. S. National Museum



(PUBLICATION 3108)

CITY OF WASHINGTON
PUBLISHED BY THE SMITHSONIAN INSTITUTION
DECEMBER 22, 1930

The Lord Baltimore Press
BALTIMORE, MD., U. S. A.

THE SUPPOSED OCCURRENCE OF AN ASIATIC GOAT-
ANTELOPE IN THE PLEISTOCENE OF
COLORADO

By GERRIT S. MILLER, JR.

CURATOR, DIVISION OF MAMMALS, U. S. NATIONAL MUSEUM

(WITH TWO PLATES)

In the Bulletin of the Geological Society of America, Vol. 11, pp. 610-612, pl. 57, August 10, 1900, Mr. F. W. Cragin described and figured the right humerus and right metacarpal of a "Goat-antelope from the Cave Fauna of Pike's Peak Region." He proposed for this animal the new name *Nemorhædus palmeri*, and concluded that the discovery of the two leg bones extended the former range of the Asiatic genus *Næmorhedus* to Colorado. Furthermore he reasoned that:

If the range of the Pike's Peak capricorn corresponded nearly with that of the Himalayan, and the cave of the capricorn-eating carnivore was conveniently located within the zone of the greatest abundance of the quarry—5,000 to 6,000 feet above sea level—the Rocky Mountain plateau must have stood something like one or two thousand feet lower in its capricorn epoch than today, as the present elevation of the cave approaches 7,000 feet; and as the two conditions above predicated are those most likely to have prevailed, it seems quite probable that *Nemorhædus*, as an element of the North American fauna, belonged to the Champlain phase of the Glacial epoch.

Apparently no one has yet submitted these findings to critical examination. Hay (The Pleistocene of the Middle Region of North America and Its Vertebrated Animals, 1924, pp. 144, 273, 275) accepts the species as a genuine member of the Pleistocene fauna of Colorado.

The specimens of *Nemorhædus palmeri* are now in the United States National Museum. They were originally entered under the number 8042, Division of Vertebrate Paleontology, but they have now received the number 255680 in the Division of [recent] Mammals. A few months ago, at the request of Mr. E. R. Warren, these specimens were examined by Dr. J. W. Gidley, who concluded that they are geologically recent in origin and not of Pleistocene age. He therefore asked me to compare them with the corresponding parts of such ungulates as now occur in the Rocky Mountain region. On doing this

I am unable to find any characters by which they can be distinguished either generically or specifically from existing American sheep, notwithstanding Mr. Cragin's belief (Colorado College Studies, Vol. 8, p. 23, April, 1900) that they "differed widely" from the corresponding bones of these animals.

The similarity in both size and form between the type specimen, the humerus, of "*Nemorhædus palmeri*" and the humeri of three bighorns is made sufficiently evident by the photographs reproduced in plates 1 and 2. Individual peculiarities can be seen in the cave bone as in each of the others; but the specimen appears to be characterized by nothing more important.

Finally, the condition of the femur is such as to lend no support to the idea that the bone pertained to a member of the Pleistocene fauna. There is no indication of mineralization. On protected parts there are thin deposits of a fine reddish dust that is readily removed with water, leaving the surface clean and fresh in appearance. When charred a small fragment gives off the characteristic odor of burned bone.

In the absence of evidence to the contrary, I therefore have no hesitation in regarding the name *Nemorhædus palmeri* Cragin as a synonym of *Ovis canadensis* Shaw. Mr. Warren writes me under date of August 18, 1930, that the type locality is "Glen Eyrie," the former home of General Palmer, for whom the supposed new species was named. This place is in a valley or canyon about five miles north-west of Colorado Springs, across the "Mesa."

EXPLANATION OF PLATES 1 AND 2

All figures about two-thirds natural size

- FIG. 1. *Ovis dalli* Nelson. Female. Lapierre House, Yukon, Canada. No. 20963, U. S. Nat. Mus.
- FIG. 2. Type of *Nemorhædus palmeri* Cragin. Near Colorado Springs, El Paso County, Colorado. No. 255680, U. S. Nat. Mus.
- FIG. 3. *Ovis* sp. Male. Exact locality unknown (received alive from D. E. Wintermute, Gila, Arizona). No. 49777, U. S. Nat. Mus.
- FIG. 4. *Ovis canadensis* Shaw. Male. Delta County, Colorado. No. 49704, U. S. Nat. Mus.

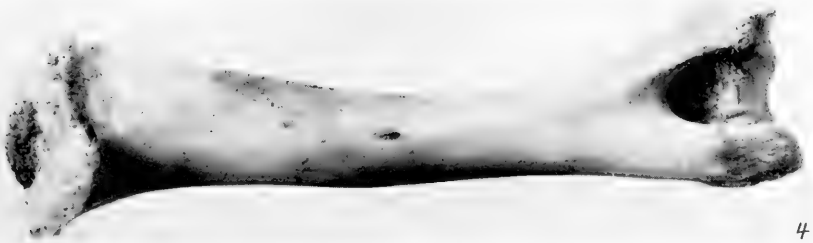
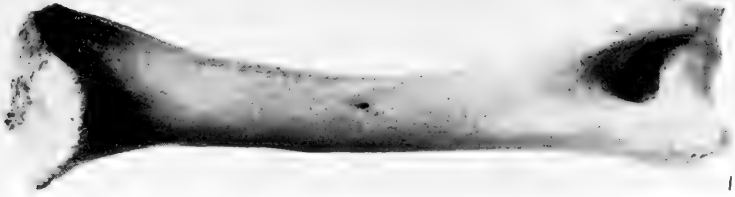

Right humerus of four specimens of Rocky Mountain sheep (Fig. 2, type of *Nemorhædus palmieri* Cragin).



Right humerus of four specimens of Rocky Mountain sheep (Fig. 2, type of *Nemorhædus palmieri* Cragin).

SMITHSONIAN MISCELLANEOUS COLLECTIONS

VOLUME 82, NUMBER 15

THREE SMALL COLLECTIONS OF MAMMALS
FROM HISPANIOLA

(WITH TWO PLATES)

BY

GERRIT S. MILLER, JR.

Curator, Division of Mammals, U. S. National Museum



(PUBLICATION 3109)

CITY OF WASHINGTON

PUBLISHED BY THE SMITHSONIAN INSTITUTION

DECEMBER 24, 1930



SMITHSONIAN MISCELLANEOUS COLLECTIONS

VOLUME 82, NUMBER 15

THREE SMALL COLLECTIONS OF MAMMALS
FROM HISPANIOLA

(WITH TWO PLATES)

BY

GERRIT S. MILLER, JR.

Curator, Division of Mammals, U. S. National Museum



(PUBLICATION 3109)

CITY OF WASHINGTON
PUBLISHED BY THE SMITHSONIAN INSTITUTION
DECEMBER 24, 1930

The Lord Baltimore Press
BALTIMORE, MD., U. S. A.

THREE SMALL COLLECTIONS OF MAMMALS FROM HISPANIOLA

By GERRIT S. MILLER, JR.

CURATOR, DIVISION OF MAMMALS, U. S. NATIONAL MUSEUM

(WITH TWO PLATES)

The United States National Museum has received from Haiti and the Dominican Republic three small collections of mammals that have not yet been reported on.

Of these, the first was made in a sheltered side crevice, probably once the nesting place of the giant Haitian barn owl, near the bottom of a deep sink hole called the Trujin, on the massif of La Selle, Haiti. How he explored this cavity by means of a tall pine, felled and lowered into the hole to serve as a ladder, has been told by Dr. Alexander Wetmore in "Explorations and Field-Work of the Smithsonian Institution in 1927," p. 36. The bones from this source are particularly interesting because they represent an almost "pure culture" of the native mammal fauna, nearly uncontaminated by introduced European rodents. Among the Trujin remains is the most nearly complete skull of *Brotomys* yet collected, and a series of *Nesophontes* skulls that indicates the presence of well-defined sexual characters independent of size.

The second collection was made during March, 1929, in caves near En Café on Gonave Island, Haiti, by Arthur J. Poole, who has described his experiences in "Explorations and Field-Work of the Smithsonian Institution in 1929," pp. 71-73. It shows that most of the genera of extinct mammals found in the caves of the Haitian mainland were also represented in the fauna of Gonave.

The third collection is from the neighborhood of Constanza, in the mountainous interior of the Dominican Republic (altitude about 4,000 feet), a region that Herbert W. Krieger visited during the spring of 1930. It consists of two lots of bones. One of these was dug from an Indian refuse deposit, about 2½ feet deep, on the valley floor at Cerro de Monte, 6 km. east of Constanza. The other was contained in owl pellets found in a shelter under an overhanging ledge about 100 feet up the northern flank of Monte Culo de Maco above the Arroyo Limoncillo at a point some 10 km. southwest of Constanza. The mass of about half a peck of dry, partly disintegrated pellets was

brought entire to Washington. In it I found, for the first time, remains of *Nesophontes*, *Brotomys*, and *Isolobodon* in dejecta that appear to be those of the small living barn owl. As usual with this bird the ubiquitous roof rats made up the bulk of the food, as indicated by the undigested remains. The *Brotomys* must have been about the same size as one of these rats, while the *Isolobodon*, a very young individual, could not have been much larger. The finding of these remains in recent owl pellets, and particularly in pellets from the rain forest region where there is no reason to suppose that disintegration is likely to be very long delayed, as it might be in the dry parts of the island, is extremely important. It points to the probability that members of three of the supposedly extinct genera of Hispaniolan mammals may, in reality, be still alive.

(1) TRUJIN COLLECTION

NESOPHONTES HYPOMICRUS Miller

Anterior part of skull, 5; palate, 1; right maxilla, 3; left maxilla, 5; right mandible, 20; left mandible, 20; periotic bones, 30; tympanic rings, 10; sternal manubria, 7; scapulae, 2; humeri, 43; ulnae, 27; radii, 4; innominates, 21; femora, 52; tibiae, 25; astragali, 35; calcanea, 42.

Two of these skulls first called my attention to the fact, afterward verified in many specimens from other localities, that individuals of *Nesophontes hypomicrus* (pl. 2, figs. 1 and 1a) and *N. paramicrus* (pl. 2, figs. 2 and 2a) possess upper canine teeth that are either high and strong or low and weak. The conditions in *N. zamicrus* are not yet known. That the weak teeth are not deciduous canines is shown by their presence in old individuals with much worn molars. It seems plain, therefore, that the differences should be attributed to sexual dimorphism and that the individuals with weak canines should be regarded as females, those with strong canines as males. While this conclusion seems necessary it must be admitted that such sexual differences in the size and form of the canine are unusual if not unique among the insectivores. I have been unable to find an approach to it in any of the insectivore genera represented in the National Museum collection.

EPTESICUS HISPANIOLÆ Miller

Skull, nearly perfect, 1; broken rostra, 3; fragments of palate, 37; mandibles, 89. Also many periotics, finger bones, and loose teeth.

The preponderance of remains of this species in the food of an owl that had a varied bat fauna to select from is rather remarkable.

TADARIDA sp.

Mandibles, 2.

RATTUS RATTUS subsp.

Mandible, 1; auditory bulla, 1; femur, 1; tibia, 1; heads of tibiae, 3; astragali, 2; calcaneum, 1; ulna, 1.

These few rat bones were the only remains of introduced European rodents found in the deposit. Bones of the house mouse were entirely absent.

BROTOMYS VORATUS Miller

Imperfect skull, 1; palate and rostrum, 1; right maxillae, 2; left maxilla, 1; left nasal, 1; fragmentary palates, 5; loose cheekteeth, 27; pieces of frontal, 2; pieces of braincase, 2; occipitals, 1; auditory bullae, 2; mandibles, right, 5; left, 5; humeri, 2; ulnae, 4; radius, 1; innominates, 12; sacra, 4; femora, 9; tibiae, 7; heads of tibia, 4; astragalus, 1; calcaneum, 1.

The skull (pl. 1, fig. 2), though imperfect, is the most nearly complete specimen that has yet been found. It permits, for the first time, a rather full comparison with the skull of *Proechimys* (pl. 1, fig. 1), and it shows conclusively that, so far as cranial characters are concerned, the differences between the two animals are of no more than generic importance. Chief among the characters in which the island genus differs from its mainland relative are the broader, deeper, less downward bent rostrum, deeper zygoma (in a perfect specimen this would be even more evident than it is in the slightly injured zygoma of the Trujin skull), less developed supraorbital bead (not well shown in the Trujin skull but obvious in other specimens), and less contrast in size and form between the alveolar pit made by the inner root of each cheektooth and the two pits made by the outer roots. Apparently there is less space between the paroccipital process and the posterior margin of the glenoid fossa, but this may be partly or wholly due to incorrect reconstruction of this part of the skull. The auditory bulla in the Trujin specimen is not exactly in place; it should lie about 1.5 mm. farther back. As compared with the mandible of *Proechimys semispinosus* that of *Brotomys voratus* (see Smithsonian Misc. Coll., Vol. 82, No. 5, pl. 1, fig. 3, December 11, 1929) is more robust. In particular the depth at the sigmoid flexure is noticeably greater in proportion to the total length of the mandible. The coronoid process is larger and the angular process is longer.

In its dental characters *Brotomys* likewise differs no more from *Proechimys* than the latter differs from some of its living South

American relatives. The upper incisors are more abruptly curved and their course is slightly if at all evident on the side of the rostrum or in the antorbital foramen. Similarly the shaft of the lower incisor is less conspicuous on the under side of the mandible; its base does not extend quite so far beyond the root of m_3 as in the case of *Proechimys*. All the maxillary cheekteeth are 3-rooted as in *Proechimys*, but the inner root is merely larger than either of the others and not specialized in form as it is in the South American animal. In both genera the mandibular teeth are 3-rooted with the exception of the 2-rooted premolar. The large root is placed behind and the two small roots in front.

The enamel pattern is less complicated than that of *Proechimys semispinosus*. In all of the teeth except pm_4 the pattern is unmodified pentamerous with the two reentrant folds of the paramere slightly deeper than the single reentrant of the protomere. In the lower premolar the protomere bears a shallow second reentrant fold near the front of the crown. This fold is so shallow that it is soon cut off as an enamel lake. No species of *Proechimys* that I have seen is as simple as this in its enamel folding. The fundamental conditions present in *Brotomys* are, however, exactly reproduced in *Cercomys*, though in this South American genus there is a slight specialization in the form of a peripheral narrowing of the reentrant folds of the metamere which causes these folds to become early isolated as lakes.

PLAGIODONTIA HYLÆUM Miller

Right mandible (no teeth), 1; left auditory bulla, 1; fragment of ulna, 1; fragments of innominates, 2; femur, 1; tibia, 1; epiphysis from head of tibia, 1; astragalus, 1; calcaneum, 1.

PLAGIODONTIA sp. ?

A first or second upper molar, a first or second lower molar, and three separate plates of a larger tooth, apparently m_1 or m_2 , suggest the occurrence of a *Plagiodontia* with teeth more compressed antero-posteriorly than they are in any of the three species now recognized. Two auditory bullae slightly different from those of *P. hylæum* may pertain to this animal.

ISOLOBODON LEVIR Miller

Probably two individuals, both immature, represented by the left half of a palate and three loose teeth.

(2) GONAVE COLLECTION

NESOPHONTES HYPOMICRUS Miller

Two skulls lacking most of the braincase. One retains the right canine; this tooth has the form and size that appears to indicate the female sex.

BROTOMYS VORATUS Miller

Fragment of palate, 1; mandibles, 35.

These specimens appear to agree in all respects with those collected on the Haitian mainland.

ISOLOBODON PORTORICENSIS Allen

Skull, lacking rostrum and teeth, 1; palate with three teeth, 1; right upper premolar, 1; mandibles, 23; humerus, 1.

All of this material is referable to the large *Isolobodon*. The tooth-rows of the 10 largest mandibles range from 19 to 20 mm. in alveolar length, thus closely agreeing with the measurements of 11 jaws of *I. portoricensis* from the mouth of San Juan River, Dominican Republic (19 to 20.8 mm.), and decidedly exceeding those of 15 jaws of *I. levir* picked for their large size from a series of 281 collected in the vicinity of Monte Cristi (16 to 17.6 mm.).

APHÆTREUS MONTANUS Miller

Six mandibles, all from immature individuals.

HEXOLOBODON PHENAX Miller

Imperfect mandible of a young individual, with pm_4 in place.

Two bullae, an atlas, and the lower extremity of a femur, all of which appear to be too large to have pertained to an *Isolobodon*, may represent this animal.

ACRATOCNUS COMES Miller

Upper canine, 1; imperfect molariform teeth, 2; left fourth metacarpal, 1; phalanges, 2; centrum of vertebra, 1.

(3) CONSTANZA COLLECTION

(A) OWL DEPOSIT

NESOPHONTES PARAMICRUS Miller

Anterior part of skull, 1; braincase, 1; mandibles, 11; humeri, 4; femora, 10.

All of these bones were found in the mass of partly disintegrated owl pellets. Many of them have the appearance of such freshness that it is easy to believe that they were dropped by the owls within a period not greater than a year or two before the time of Mr. Krieger's work. One of the femurs, for instance, retains a patch of dried tissue on the anterior basal portion of the greater trochanter and a loose web of hairs in the digital fossa and concave inner aspect of the greater trochanter. The braincase (pl. 2, fig. 3) is packed full of hair by the action of the owl's stomach, and the broken anterior part of a skull (pl. 2, fig. 3a) gives similar evidence of recent submission to digestive action. Most of the jaws have hairs adhering to the teeth or in the spaces between the roots. One has a felt-like mass plastered against the inner side of the ascending ramus.

As regards specific characters this material appears to be in perfect accord with the original material from St. Michel, Haiti.

NESOPHONTES HYPOMICRUS Miller

Imperfect rostra, 2; mandibles, 14; humerus, 1; femora, 3; tibiae, 4.

In one of the imperfect rostra the antorbital canal is packed with hair and there are tufts of hair in the spaces between the teeth. Most of the jaws have hairs adhering to the teeth.

NESOPHONTES ZAMICRUS Miller

A mandible, an ulna and a tibia represent this species. All three bones have traces of hair and other organic matter adhering to their surfaces. The mandible measures: total length, about 13 mm.; depth through coronoid process, 4.0; distance from articular process to anterior border of first molar, 8.4; combined four molariform teeth (alveoli), 5.2.

PHYLLOPS HAITIENSIS (J. A. Allen)

Broken skull of one individual and mandible of another.

EPTESICUS HISPANIOLÆ Miller

Broken skull and nearly perfect jaw, both apparently parts of one animal. The scarcity of bat remains is a peculiar feature of this owl deposit.

BROTOMYS VORATUS Miller

A mandible and femur. The femur is smeared with hair and half digested organic material. Its digital fossa and concave inner surface

of the greater trochanter are packed with a felt-like mass of fine hair (pl. 2, fig. 5), in the same condition as the femur of a roof rat (pl. 2, fig. 4) near which it was found.

ISOLOBODON sp.

Two halves of the palate from a young individual. On the left side the teeth have fallen out and the alveoli are packed with hair (pl. 2, fig. 6a). The femur of a young hystricoid rodent (pl. 1, fig. 6) is probably a part of the same animal. It is shorter and decidedly more robust than the femur that I refer to *Brotomys*.

(B) INDIAN DEPOSIT

Mr. Krieger informs me that he found numerous kitchenmiddens on the valley floor near Constanza. In most of those that he examined there were few bones, and these few were fragmentary. The midden at Cerro de Monte, from which he took numerous mammalian remains in fairly good condition was not more than 20 feet long, 6 feet wide and 2½ feet deep. In it he found no artifacts of Spanish origin; but the collection includes an atlas, calcaneum, astragalus, phalanx, and six teeth of the domestic pig (pertaining to at least two individuals) an upper molar of a colt, and five mandibles, two femurs and a humerus of *Rattus rattus* subsp. All of these remains of European mammals, together with a few human bones, are in exactly the same condition as the bones and teeth of the extinct rodents with which they were associated.

NESOPHONTES PARAMICRUS Miller

A femur 18 mm. in length unquestionably pertains to this species. Its presence in an open kitchenmidden like the one at Cerro de Monte rather strongly suggests that the Indians may have used the small insectivores, as well as the large *Solenodon*, for food. The humerus of *Nesophontes* that I found in the kitchenmidden in a cave on San Lorenzo Bay might easily have been dropped there by an owl (Smithsonian Misc. Coll., Vol. 82, No. 5, p. 4, December 11, 1929). Such an origin for the femur at Cerro de Monte seems unlikely.

BROTOMYS VORATUS Miller

Mandible, 1; femur, 1.

PLAGIODONTIA ÆDIUM F. Cuvier

Palates, 2; mandible, 1; odd cheekteeth, 4. One of the palates is represented on plate 2 (fig. 7).

PLAGIODONTIA HYLÆUM Miller

Palate with full set of teeth, 1 (pl. 2, fig. 8); premaxillae with incisors, 2; occipitals, 2; mandibles, 6.

ISOLOBODON LEVIR (Miller)

Palates, 4 (one with full set of teeth); premaxillae with incisors, 7; mandibles, 34 (18 left, 16 right). Also numerous small bones and fragments of skulls that appear to have pertained to this animal.

CAVIA PORCELLUS (Linnæus)

(Plate 2, figs. 9, 9a)

Fragment of zygoma and palate with pm^4 in place, 1; mandibles, 4 (2 left, 2 right); femora, 2. One of the femora pertained to an adult, the other to a young animal. The mandibles (two of which are figured on pl. 2, figs. 6 and 6a) represent four individuals. They are similar to those that Mr. Krieger unearthed at Anadel in 1929 (see Miller, Smithsonian Misc. Coll., Vol. 82, No. 5, p. 11, December 11, 1929), and I am unable to detect any characters by which they can be distinguished from jaws of the ordinary domestic animal. The same is true of the right half of a palate with all four teeth in place that Mr. Krieger collected at Boca Chica, on the coast about 20 miles east of Santo Domingo City in 1930.

From Oviedo's account of the "cori" it seems evident that guinea-pigs were well known to the Spaniards at Santo Domingo City during the first half of the sixteenth century. Whether they brought the animals from South America or found them already in the possession of the natives at the time when Hispaniola was discovered is a question that may never be answered. I was originally inclined to suppose that the Spaniards themselves were responsible for the occurrence of guinea-pigs on the island (Smithsonian Misc. Coll., Vol. 82, No. 5, p. 14, December 11, 1929). Oviedo's record for Santo Domingo City and Mr. Krieger's discovery of remains at Boca Chica and on the shore of Samaná Bay are in accord with this supposition, as both localities were settled by the Spaniards. In fact, some remnants of a Spanish house can still be seen at Anadel in the same field with the kitchenmidden. But it is less easy to harmonize the belief in Spanish

introduction of the guineapig with the finding of the animal's remains at such a remote and inaccessible locality as Constanza. This may point, like the occurrence of a South American monkey's teeth in a Precolumbian grave in Cuba (Miller, *Smithsonian Misc. Coll.*, Vol. 66, No. 13, December 8, 1916), to early native trade between South America and the Greater Antilles; but it must be admitted that the presence of remains of pig and horse in the midden near Constanza counts against such a view.

EXPLANATION OF PLATES

PLATE 1

All figures natural size

- FIGS. 1, 1a, 1b. *Proechimys semispinosus* Tomes. No. 113273, U. S. Nat. Mus. San Javier, Ecuador.
- FIGS. 2, 2a, 2b. *Brotomys voratus* Miller. No. 255696, U. S. Nat. Mus. Trujin, Massif de La Selle, Haiti. Altitude 6,500 feet.

PLATE 2

Figs. 1-3 enlarged $\frac{1}{2}$, other figures natural size

- FIG. 1. *Nesophontes hypomicrus* Miller, male. No. 255697, U. S. Nat. Mus. Trujin, Massif de La Selle, Haiti.
- FIG. 1a. *Nesophontes hypomicrus* Miller, female. No. 255698, U. S. Nat. Mus. Same locality.
- FIG. 2. *Nesophontes paramicrus* Miller, male. No. 255699, U. S. Nat. Mus. St. Michel, Haiti.
- FIG. 2a. *Nesophontes paramicrus* Miller, female. No. 255700, U. S. Nat. Mus. St. Michel, Haiti.
- FIGS. 3 and 3a. *Nesophontes paramicrus* Miller. Nos. 255301 and 255300, U. S. Nat. Mus. Near Constanza, Dominican Republic. From owl pellets.
- FIG. 4. *Rattus rattus* subsp. No. 255701, U. S. Nat. Mus. Near Constanza, Dominican Republic. From owl pellet. Mass of hair in digital fossa.
- FIG. 5. *Brotomys voratus* Miller. No. 255702, U. S. Nat. Mus. Same locality and condition as fig. 4.
- FIGS. 6 and 6a. *Isolobodon* sp. No. 255703, U. S. Nat. Mus. Same locality and condition as figs. 4 and 5. Hair in digital fossa of femur and in two alveoli of palate.
- FIG. 7. *Plagiodontia adium* F. Cuvier. No. 255704, U. S. Nat. Mus. Near Constanza, Dominican Republic. From Indian deposit.
- FIG. 8. *Plagiodontia hylæum* Miller. No. 255283, U. S. Nat. Mus. Same locality as fig. 7.
- FIGS. 9 and 9a. *Cavia porcellus*. Nos. 255299 and 255296, U. S. Nat. Mus. Same locality as figs. 7 and 8.

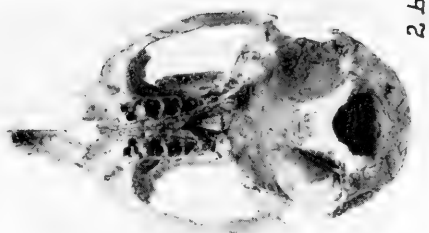
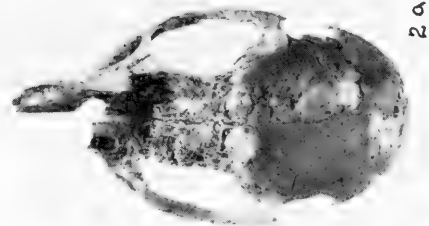
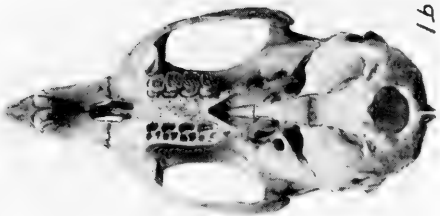
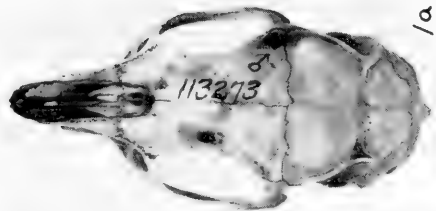
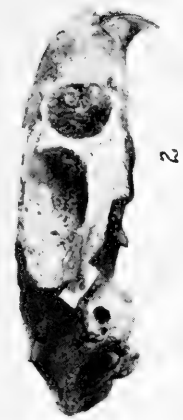
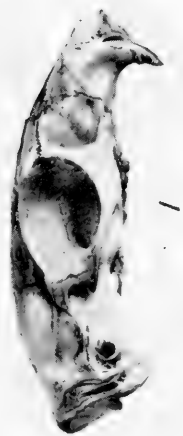

1, *Proechimys*; 2, *Brotomys*.

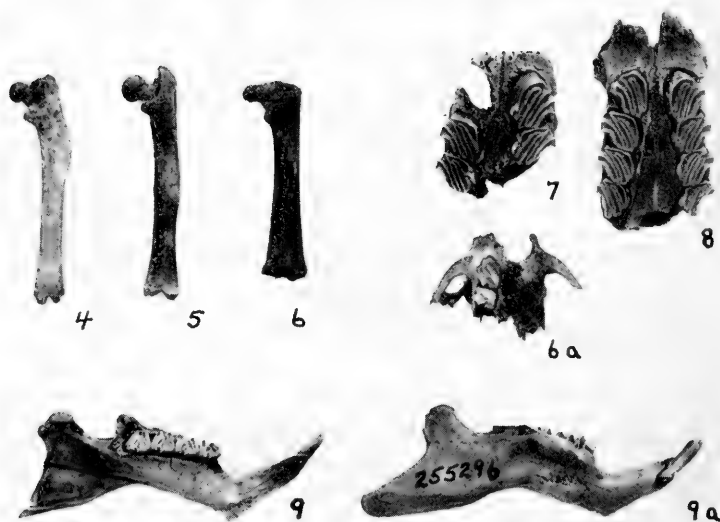
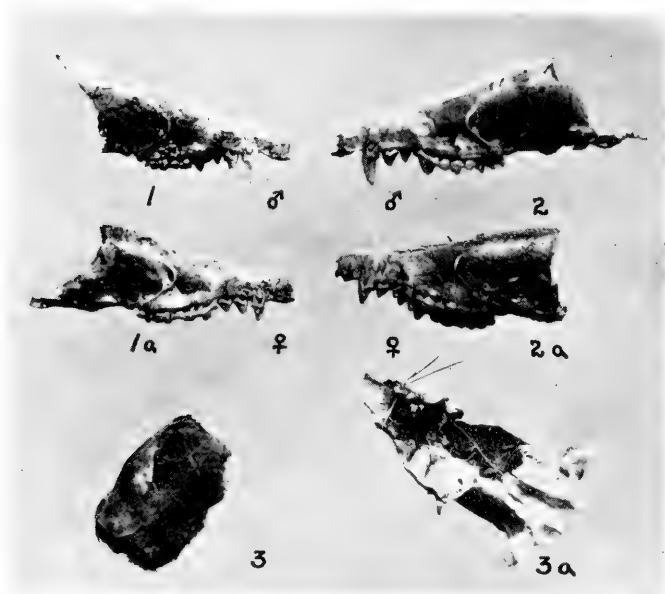

Insectivores and rodents from the Dominican Republic (1-3, *Nesophontes*; 4, *Rattus*; 5, *Brotomys*; 6, *Isolobodon*; 7-8, *Plagiodontia*; 9, *Caria*).

SMITHSONIAN MISCELLANEOUS COLLECTIONS
VOLUME 82, NUMBER 16

THE DUCTLESS GLANDS OF ALLIGATOR MISSISSIPPIENSIS

(WITH THREE PLATES)

BY
A. M. REESE
West Virginia University



(PUBLICATION 3110)

CITY OF WASHINGTON
PUBLISHED BY THE SMITHSONIAN INSTITUTION
MARCH 9, 1931

SMITHSONIAN MISCELLANEOUS COLLECTIONS

VOLUME 82, NUMBER 16

THE DUCTLESS GLANDS OF ALLIGATOR
MISSISSIPPIENSIS

(WITH THREE PLATES)

BY

A. M. REESE

West Virginia University



(PUBLICATION 3110)

CITY OF WASHINGTON

PUBLISHED BY THE SMITHSONIAN INSTITUTION

MARCH 9, 1931

The Lord Baltimore Press
BALTIMORE, MD., U. S. A.

THE DUCTLESS GLANDS OF ALLIGATOR MISSISSIPPIENSIS

By A. M. REESE

WEST VIRGINIA UNIVERSITY

(WITH THREE PLATES)

Although several workers have investigated certain of the ductless glands of reptiles, very little has been done upon these glands in the Crocodilia; so it has seemed worth while to work out the main features in the gross and microscopic structure of these organs in the alligator. Live animals from 2 to 3 feet long were obtained from a regular dealer and the glands were removed, fixed with various reagents, sectioned, and stained with the usual stains, mostly haematoxylin and eosin. Most of the researches of the author upon the Crocodilia have been made possible by grants from the Smithsonian Institution, the Carnegie Institution of Washington, and the Elizabeth Thompson Science Fund.

THE ADRENALS

According to Swale Vincent (11), the first definite description, with figures, of the adrenals was written by Eustachius in 1563; but so little attention was paid to these organs that Fabricius, as late as 1738, makes no reference to them.

At the present time, although the literature is very extensive, but little work has been done upon the anatomy of the adrenals in the Reptilia and almost nothing upon those of the Crocodilia. In man the cortical portion of the adrenal makes its appearance, in embryos of about 6 mm. in length, as a series of buds from the coelomic epithelium in the dorsal body wall, which later fuse to form a mass on each side of the base of the mesentery. The medulla of the adrenal arises, at about the same time, from the neural crest of the embryo in connection with the origin of the sympathetic nervous system, the "sympathochromaphil" tissue. Later the chromaphil tissue differentiates from the sympathetic nervous tissue, and by the time the embryo is 19 mm. in length the chromaphil bodies have begun to penetrate the above-mentioned cortical masses. At 9 or 10 cm. the

chromaphil cells are seen as groups or islands among the strands of the cortex. It is interesting to note that this embryonic condition of man is quite similar to the adult condition in some reptiles and birds.

Different investigators have claimed to have found structures that might be called adrenals in various invertebrate animals. It seems doubtful if these claims can be substantiated, at least for the cortex. According to Swale Vincent (11) the cyclostomes are the lowest chordates in which adrenal structures are certainly known to be found. In the various vertebrate classes the adrenals are, of course, variously developed. In the selachians, for example, the region known as the cortex in man is represented by a median, elongated body, the inter-renal, lying between the kidneys; while the medulla of the human adrenal is represented by a series of small paired masses of chromaphil tissue closely associated with the sympathetic ganglia, called by Balfour the "suprarenals." The Amphibia, as in other ways, exhibit a somewhat transitional condition in which the close association of the chromaphil or medullary tissue with the sympathetic nervous system is partially lost.

In Reptilia and Aves, as has been said, the chromaphil penetrates the inter-renal or cortical mass without forming the definite central mass known in the Mammalia as the medulla.

In the alligator, *Alligator mississippiensis*, the adrenals are yellowish, elongated bodies, between and anterior to the kidneys; they are closely associated with the anterior two thirds of the gonads and with the aorta and the post caval vein.

Plate 1, figure 1, represents a transverse section through the adrenals (*ad*), and the adjacent ovaries (*o*). In this region the adrenals are somewhat circular in section, in other regions they are flattened. They are united with the ovaries (*o*), and the dorsal aorta (*ao*), by a thick mass of connective tissue which is indistinctly differentiated into a surrounding capsule (*c*), for each gland. The inter-columnar spaces in the glands here figured were not as distinct as in the gland shown in the following figure and are not indicated.

The microscopic structure of the adrenal is shown in figure 3 (pl. 1), which was drawn under a camera lucida, with a magnification of about 500 diameters.

As noted above, the cortex and medulla are not sharply segregated into two regions as in the mammals, but the latter is seen as scattered groups of cells, chiefly in the interspaces between the strands or columns of the cortex. According to Vincent the conditions in Crocodilia and birds are "almost identical."

The cortical and medullary (or chromaphil) cells are easily distinguished from each other in material fixed in chromium salts, by the fact that the latter become colored from brown to bright yellow and stand out in strong contrast to the paler cortical cells.

In a medium-power view of the entire cross section of the gland (fig. 2, pl. 1) the chromaphil cell groups are seen to be much more numerous near the periphery of the gland, especially on the dorsal side, under the capsule, than in the more central region. The region shown in figure 3 is about mid-way between the center and the periphery.

The cortical cells form a compact mass, near the periphery, the interspaces of which seem almost completely filled by the medullary or chromaphil cells; but towards the center they separate into thick irregular columns or strands (fig. 2, *cc*) with wide interspaces (fig. 3, *is*). Some of the chromaphil masses seem to lie imbedded in the sides of these cortical columns rather than in the interspaces. The intercolumnar spaces are largely occupied by capillaries or sinuses in which blood corpuscles are seen.

As shown in figure 3, the cortical masses are made up of clear, finely granular, irregular cells, whose walls are difficult or impossible to see, in many places. The nuclei are of average size, usually spherical or oval in shape and are rather finely granular.

Each column of the cortex seems surrounded by a sort of basement membrane or pavement epithelium (*en*) in which occasional flattened nuclei may be seen. This epithelium represents the endothelium of the capillaries of the intercolumnar spaces mentioned above. There is apparently no other intercolumnar connective tissue.

The medulla or chromaphil material, as has been said, consists of masses of yellow or brown cells (in tissue fixed in chromic acid) lying between the cortical columns (figs. 2 and 3, *mc*). These cell-masses vary not only in color, the yellow cells mostly lying peripheral to the brown, but also in size and shape. The outlines of their constituent cells are even harder to see than those of the cortical cells, but the cells are easily distinguished from the adjacent cortical cells by their coloring. The nuclei apparently do not differ from those of the cortical cells; they often lie so close together that, if each one represents a cell, the medullary cells must be somewhat smaller, as a rule, than those of the cortex. In *Uromastix*, according to Vincent (11), the chromaphil cells are larger than the cortical. The chromaphil cells are more distinctly and more coarsely granular than are the cortical cells. No difference could be determined with certainty between the adrenals of an animal after a prolonged fast and

one during the feeding season, unless, possibly the chromaphil tissue in the former may be somewhat more in evidence than in the latter. The tissue available, however, was not sufficiently abundant to determine this point with entire certainty.

THE THYROID AND PARATHYROID GLANDS

The thyroid gland in the alligator is a small, bilobed structure (pl. I, fig. 4, *ty*) lying across the ventral surface of the trachea at the level of the auricular end of the heart. In a 40 cm. animal, the gland is of the size shown in figure 4. It consists of an oval or spherical lobe on each side and an interlobular portion or isthmus. The isthmus is relatively thick and short so that the lateral lobes are not sharply distinguishable from it as in some of the higher vertebrates. The gland has a reddish color and is easily removable without distortion from the body. The microscopic structure of the gland does not present any very unusual features. It is surrounded by a fibrous capsule (pl. I, fig. 5, *c*), which seems to consist of two layers; the capsule has a tendency to separate, as shown in figure 5, into an inner and an outer part.

The alveoli are, in some cases, very closely arranged; in other glands they are more widely separated by interstitial connective tissue, blood vessels and empty sinuses. In some cases the majority of the alveoli contain colloid; in other cases most of them are empty. Higher magnification shows the alveoli to be lined with the usual single layer of cubical or columnar cells (fig. 6) with large, spherical or compressed nuclei. The cells are clear or finely granular, the nuclei are coarsely granular. Even in tissue that seems otherwise perfectly fixed the walls between the cells can seldom be demonstrated. In some alveoli the cells are large; in other alveoli, especially in those free of colloid (pl. I, fig. 6, *A*) the cells are small and seem compressed, so that adjacent nuclei are almost in contact with each other.

Closely adherent to the lobe of the thyroid gland (fig. 5, *pt*) is a very small body which, at first, looks like scarcely more than a thickening of the fibrous capsule of the thyroid. More careful examination, however, brings to light certain structures that would seem to indicate that this small body is either the parathyroid or the post-branchial body or probably both. Swale Vincent (11) says that these two bodies are closely united in some of the other reptiles and that they are subject to much variation. He figures the combined bodies from some unnamed animal but from the figure it is difficult

to see any great difference between them, or to determine where one organ ends and the other begins.

In the small amount of alligator material examined, no vesicles of large size were present and no colloid was seen. Figure 7 (pl. 1) represents a portion of the organ under consideration as seen under moderately high magnification. The fairly distinct capsule (*c*) is continuous with the capsule of the thyroid gland. The main body or stroma is composed of a very indefinite, finely granular material, the structure of which is very difficult to determine. It stains with eosin, and contains scattered nuclei which stain deeply and are smaller and more irregular than the nuclei in the thyroid. This material in places gives the impression of irregular, indistinct cells; in other places it has almost a fibrous appearance. Numerous irregular spaces are seen in it.

The two characteristic structures of this organ are the degenerate alveoli, and the structures that Vincent calls "Hassall's corpuscles" from their resemblance to that characteristic feature of the thymus gland.

The alveoli (fig. 7, *a*) are small and under low magnification have the appearance of thick-walled blood vessels. Under higher magnification the alveoli have the appearance of being in different stages of degeneration, although whether this is really so the writer is not prepared to say. The alveolus figured has a thick granular wall in which two sets of small, irregular nuclei are scattered, and in which no indication of transverse cell walls is seen. One set of oval or spherical nuclei lies close to the lumen, into which many of the nuclei project. The other nuclei form an indistinct layer around the periphery of the alveolar wall.

Surrounding these structures is a fairly distinct layer of dense material resembling fibrous connective tissue; this is one reason for the resemblance of the alveolus to a blood vessel noted above. The resemblance of these alveoli to degenerate alveoli of the thyroid would lend support to the view, held by some, that the alveoli of the two glands are the same.

The other structures, the so-called "Hassall's concentric corpuscles" (*hc*) are small collections of nuclei, mostly spindlelike or crescentic in shape, that are arranged in concentric circles very much as in the true Hassall's corpuscles of the thymus gland. No empty space is seen in the corpuscle, the center of the circle being occupied by a group of small, round nuclei. Besides these concentric groups, other smaller groups of nuclei are seen which do not show any concentric

arrangement. The outlines of the cells to which the nuclei belong could not be determined.

Besides this small mass of parathyroid or post-branchial tissue, imbedded in the side of the thyroid gland, there are several small, more or less spheroidal bodies situated on each side of the neck, near, or even imbedded in the thymus glands. They are so small—about the size of an ordinary pin head in a 28-inch alligator—that they are distinguished with difficulty from the surrounding tissue.

J. B. Looper (7), who first called my attention to them, finds two or three on each side of the neck near, posterior or median to the thymus, sometimes imbedded in it and apparently continuous with it. Kingsley (5) does not mention the parathyroid in the alligator, but he figures the pharyngeal derivatives in a lizard and shows a single, rather large parathyroid lying against the trachea, posterior to the thyroid. Vincent (11) does not mention the parathyroid in the crocodiles. He says:

The parathyroids and post-branchial bodies are intimately united, paired, and placed anteriorly to the thyroid. Their precise anatomy differs in different groups. . . . In *Chrysemys picta* the post-branchial body also contains colloid, but the parathyroid and post-branchial body are very considerably confused together in this and some other species.

A section of a parathyroid and its adjacent structures from a 28-inch alligator is shown in plate 2, figure 8, drawn with a camera lucida under a magnification of about 100 diameters. The gland and adjacent structures are surrounded by a fairly compact capsule (*c*) of fibrous connective tissue. The capsule sends into the body of the gland many broad trabeculae (*t*) which are very vascular and break up the gland into numerous lobules or cords of cells. Capillaries (*ca*) generally filled with blood corpuscles, are seen at many places in the trabeculae and among the cells of the gland. To the right of the gland and inclosed in its capsule is seen an elongated, granular mass which may represent a post-branchial body (*pb*).

A portion of the same section, more highly magnified, is shown in figure 9 (pl. 2). Two masses of cells with a broad trabecula (*t*) between them are seen to the left, and to the right of a broad mass of connective tissue (*ct*) is a portion of the so-called post-branchial body (*pb*).

The gland cells (*gc*) are closely and irregularly packed together, and even under an oil immersion objective no cell walls could be made out, and in but few cases could any lines of demarkation between the cells be seen. The nuclei are oval or round and are densely

granular. The close arrangement of the nuclei would indicate that the cells are small.

Throughout the trabeculae numerous groups of red blood corpuscles are seen; usually, but not always, the endothelium of the capillaries in which they are contained may be seen. The trabeculae and capsule are made up of a fairly dense mass of fibres (*ct*) among which are scattered small, oval nuclei. The structure which has been called the post-branchial body (*pb*) consists of a mass of cells whose nuclei do not, perhaps, stain so deeply as those of the nearby parathyroid cells and are not so closely set. As in the parathyroid no cell walls can be determined, but the cells are probably somewhat larger than in the former organ.

Numerous blood capillaries (*ca*) are to be seen and also certain bodies (*hc*) that resemble Hassall's corpuscles. The distinctness of these bodies is exaggerated in the figure. No vesicles, with or without colloid, are to be seen in this section.

THYMUS GLAND

The thymus gland is a very inconspicuous organ in the alligator. It is very long and narrow and may easily be overlooked in dissecting a small animal. In an alligator of 85 cm. length it is about 75 mm. long and about 2 to 3 mm. wide, except at its extreme posterior end where it may be somewhat enlarged. It lies against the muscles of the neck, lateral and dorsal to the esophagus, with its enlarged posterior end near the main blood vessels of the heart. It is so closely associated with certain blood vessels of the neck that the latter may be easily removed with the gland in dissection. It has the same general color as the surrounding tissues, which adds to its inconspicuousness.

A part of a transverse section of the gland as seen under a rather low magnification is shown in plate 2, figure 10. The gland is surrounded by a rather thick mass of connective tissue (*c*) almost too diffuse to be called a capsule, which sends in numerous broad trabeculae (*t*) that divide the gland into the characteristic lobules. Numerous blood vessels (*bv*) are seen in the capsule and in the trabeculae.

The gland tissue proper shows but little difference between the outer, cortical region (*Cor*) and the central or medullary region, such as is seen in the higher vertebrates. In both regions, if any distinction between them be made, numerous corpuscles of Hassall (*hc*) may be

seen, even under this low magnification. The diameter of the gland is so small that but few lobules are to be seen in any one cross section.

Figure 11 (pl. 2) represents a small portion of the section shown in the previous figure as seen under a magnification of about 400 diameters. The gland is, of course, made up chiefly of the small, darkly-staining lymph cells (*lc*) which vary to some extent in size and shape but are mostly spherical. Their nucleus is densely granular and occupies practically the entire cell. No signs of mitosis, mentioned by Vincent (11), were seen in these cells. The reticulum supporting the lymph cells seems to be made up of small, angular cells (*rc*) with long fibrillar processes, extending between the adjacent cells. Scattered among the lymph cells are numerous capillaries (*ca*) in many of which erythrocytes (*er*) are to be seen, and in some, leucocytes (*lu*).

Irregular lymph sinuses (*ls*) may also be seen, sometimes containing large, finely granular cells. Occasional large cells (*er*) stained strongly with eosin, are apparently merely stray erythrocytes from some adjacent blood vessel.

The Hassall's corpuscles (*hc*) are numerous and varied in size and appearance. A rather large one is shown at the upper left of the figure, a smaller one to the right of this. The larger one is perhaps the more typical. It shows a central group of very small, dark cells, surrounded by a granular mass in which there are a number of elongated or crescentic cells exhibiting a fairly distinct concentric arrangement characteristic of Hassall's concentric corpuscles. Many of these corpuscles are so small that the characteristic structure cannot be made out.

THE SPLEEN

The spleen in the alligator has about the usual appearance and location as is seen in other animals, though perhaps of rather small relative size. For example, in a 40 cm. animal the spleen was an elliptical body, 8 mm. in its long, and 4 mm. in its short diameter.

A low-power sketch through such a spleen, at right angles to its long axis, is shown in plate 2, figure 12. The capsule (*c*) is well developed but varies much in thickness. It consists of a fairly distinct inner and denser layer and a less dense outer layer in which blood vessels are often seen; between these two layers large blood spaces, filled with blood, are often seen.

One of the characteristics of the alligator spleen, at least in the material studied, is the almost complete absence of trabeculae extend-

ing from the capsule towards the center of the gland. The only indication of trabeculae is an occasional strand of connective tissue extending a short distance into the pulp and lying almost parallel to the inner surface of the adjacent capsule (fig. 12, *t*).

The main body of the organ is, of course, made up of the splenic pulp (*p*) to be described later, as seen under higher magnification. Under this low magnification the pulp consists of a fairly dense mass of small cells among which are scattered numerous Malphigian corpuscles (*m*) and large numbers of conspicuous yellow masses (*y*).

The Malphigian corpuscles vary much in size in the same spleen and in number in different spleens; the inclosed artery is usually quite distinct. An occasional blood vessel (*bv*) of larger size is seen in the splenic pulp.

When examined under fairly high magnification several kinds of cells are seen to make up the splenic pulp (pl. 2, fig. 13). The most striking objects are the yellow cells noted above. They vary greatly in size from that of one of the regular lymphoid cells to ten times that bulk. Their color is a distinct brownish yellow, so that they stand out in strong contrast in sections stained in haematoxylin and eosin. They are non-granular and exhibit no nuclei, the only visible internal structures being faint, irregular lines that seem to divide the cell into irregular parts (*1*). Some of them seem to have a cell wall, but most of them, on close inspection, give the impression of being merely close agglutinizations of smaller, yellow masses. What these yellow masses are it is difficult to imagine, unless they are agglutinizations of disintegrating erythrocytes, though in this case it would seem that some nuclei should be in evidence unless the nucleus is the first part of the cell to disappear. Similar bodies have been described in the mammalian spleen as "extracellular pigment granules," probably originating from disintegrating erythrocytes.

The most numerous type of cell in the spleen is, of course, the small lymphoid cell (*2*). These cells are usually round or oval in outline, though some are quite irregular; they contain a few granules that take the haematoxylin stain readily, thus giving the distinct blue color to the section as a whole.

Scattered throughout the spleen are numerous erythrocytes (*3*) seen both flat and in profile.

Occasionally a large, polynuclear cell may be seen (*4*) with two or more nuclei, and more often a large, finely-granular cell with no visible nucleus (*5*).

THE HYPOPHYSIS

Owing to the small size of the alligator's brain, in proportion to the size of the animal, the hypophysis is very small and is quite difficult to remove, without injury, from the skull. Its position and size in relation to the brain are shown in the outline figures 14 and 15 (pl. 3).

Back of the optic chiasma the prominent infundibulum (*in*) is seen, projecting caudad and ventrad and connecting, more intimately than is indicated in figures 14 and 15, with the nervous portion (*nl*) of the hypophysis. This nervous portion, to be described later, was doubtless somewhat stretched in dissecting out the brain from which the two figures under discussion were drawn; its normal condition is probably better indicated in the drawing of the sagittal section (fig. 16, pl. 3).

The main mass of the hypophysis is made up of the glandular lobe (*gl*) from which the small middle lobe cannot here be distinguished. It is oval in outline, somewhat depressed, as shown in figure 15, and projects caudad from the nervous region.

A sagittal section through the infundibulum and hypophysis of an alligator is shown in figure 16, the anterior region being, of course, to the left. The infundibulum (*in*) has a deep cavity (V^3) lined with a distinct, darkly-stained ependyma (*ep*) somewhat thicker towards the base of the cavity, that is, to the left.

The nervous portion of the hypophysis (*nl*) is an irregular, lobulated mass continuous caudad with the infundibulum. As seen in this and the following figure its cavity (*ch*) has a complicated outline and is continuous, of course, as is its ependyma (*ep*) with the third ventricle (V^3) and its ependyma. Its capsule (*c*) is seen in figure 17 (pl. 3) to send a long projection into the tissue of the lobe from the ventral side. As mentioned above, this region of the hypophysis is seen, in the sagittal section, to be less elongated than is shown in figures 14 and 15.

The middle part of the hypophysis (*ml*) as is seen in figures 16 and 17, is continuous with the caudad surface of the nervous lobe, and, in fact, more or less surrounds it, especially on the dorsal and ventral sides. It is somewhat broken up into larger and smaller areas and is so closely continuous with the much larger glandular part that the two regions cannot be distinguished from each other in surface views, as has already been noticed. No cleft between the middle and glandular portions is to be seen.

The glandular part of the hypophysis (*gl*), as seen in sagittal section (fig. 16), is a large, darkly-stained mass directly continuous, caudad,

with the middle region. It is surrounded by the fairly thick capsule (*c*) already mentioned, in which blood vessels (*bv*) are to be seen. An occasional colloidal cyst may be seen, as at *cy*.

The finer structure of the hypophysis will now be considered. The glandular lobe (pl. 3, fig. 18) is, as has been said, much the largest region of the hypophysis. It consists of indefinite cords or strands of cells, between which are very numerous blood capillaries (*ca*) in most of which blood corpuscles (*bc*) may be seen.

The cells are of two, possibly three types, as judged by their nuclei. The cell boundaries are seen with the greatest difficulty, if at all, in sections stained with haematoxylin and eosin.

The most abundant type of cell (*1*) is spherical or polygonal and is characterized by a very large, usually spherical nucleus, in which are fine granules and often one or two larger granules or nucleoli. The nuclear granules do not stain so darkly as those in the next type of cells. The cytoplasm of these cells sometimes stains very faintly in eosin, but not a deep pink, like the adjacent red blood corpuscles. Possibly they correspond to the oxyphil cells of the human pituitary.

The second type of cell (*2*) is characterized by its small, darkly-staining nucleus. It is not quite so numerous as the former cells. The nuclei are much smaller than those of type *1*, and are pear-shaped or triangular in outline. Owing to their dark staining and characteristic shape they stand out in sharp contrast to the nuclei of type *1*.

Besides these two, a possible third type is shown (*3*) though these cells may be merely a variation of one of the preceding types. The nuclei are of intermediate size and are spherical or oval in shape.

An occasional vesicle with inclosed colloid (*co*) may be seen. The wall of the vesicle seems to be made up chiefly of cells of the smaller sizes, with an occasional cell of type *1*. Around the lobe is a connective tissue capsule (*c*) a part of the meninges of the brain.

A high-power drawing of a small region of the middle lobe and the adjacent nervous lobe is shown in figure 19 (pl. 3). This region differs from the main or glandular lobe in being much less vascular and in being made up almost entirely of only one, or possibly two, kinds of cells. Most of the cells shown in the figure are those containing the very large, round nuclei. These nuclei seem to stain darker than the corresponding nuclei of the glandular region. The cell outlines are more evident, in some cases, than in the glandular region. Only a few of the small, round nuclei are seen and still fewer of the pear-shaped ones that were so much in evidence in the glandular lobe.

A small section of the nervous lobe, through the region *a-b*, figure 17, is shown under fairly high magnification, in figure 20, (pl. 3). To the left is seen the fairly thick capsule (*c*) and to the right the ependyma (*ep*) lining the cavity of this region of the hypophysis and consisting of irregular columnar cells with large, round or oval nuclei. The cell divisions of the ependyma may be seen only at certain places and then with difficulty. The main body of this lobe consists of the structures usually described. A dense mass of fine fibers with widely scattered oval pyriform cells; and an occasional blood capillary (*bv*) are present and occasional groups of cells which, in some cases, are seen to surround an alveolus (*cy*) containing colloid.

REFERENCES

1. BEER, G. R. DE. Comparative anatomy, histology and development of the pituitary body. London, 1926.
2. CHRISTIANI, H. Histologie des griffes du corps thyroids chez les reptiles. C. R. Soc. Biol., Paris. T. 52, pp. 993-995. 1900.
3. GAUPP, E. Ueber die Anlage der Hypophyse bei Saurien. Archiv. f. mik. Anat., Bd. 42, 1893.
4. HERTWIG, O. Comparative embryology of vertebrates, Bd. 2, New York and London, 1906.
5. KINGSLEY, J. S. Comparative anatomy of vertebrates. Philadelphia, 1917.
6. KRAUS, R. Mikroskopische Anatomie der Wirbelthiere. 2, Vogel und Reptilien. Berlin und Leipzig, 1921.
7. LOOPER, J. B. From unpublished notes.
8. OPPEL, A. Lehrbuch der vergleichenden mikroskopischen Anatomie der Wirbelthiere. Vol. VIII, Jena, 1913.
9. STENDELL, W. Zur vergleichenden Anatomie und Histologie der Hypophysis Cerebri. Archiv. f. mik. Anat., Bd. 82, Abt. 1, 1913.
10. TILNEY, F. Contribution to the study of the hypophysis cerebri with especial reference to its comparative histology. Mem. Wistar Inst., No. 2. Philadelphia, 1911.
11. VINCENT, SWALE. Internal secretion and the ductless glands. New York, 1925.

LETTERING FOR ALL FIGURES

<i>a</i> , alveolus	<i>lc</i> , lymph cells
<i>ad</i> , adrenal	<i>ls</i> , lymph sinus
<i>ao</i> , aorta	<i>lu</i> , leucocytes
<i>bc</i> , blood corpuscles	<i>m</i> , Malpighian corpuscles
<i>bv</i> , blood vessel	<i>mc</i> , medullary or chromaphil cells
<i>c</i> , capsule	<i>ml</i> , middle part of hypophysis
<i>ca</i> , capillary	<i>nl</i> , nervous part of hypophysis
<i>cc</i> , cortical column	<i>o</i> , ovary
<i>ch</i> , cavity of hypophysis	<i>ov</i> , ovum
<i>co</i> , colloid	<i>p</i> , pulp
<i>cor</i> , cortex	<i>pb</i> , post-branchial body
<i>ct</i> , connective tissue	<i>pc</i> , post cava
<i>cy</i> , colloidal cyst	<i>pt</i> , parathyroid
<i>en</i> , endothelium	<i>rc</i> , reticular cells
<i>ep</i> , ependyma	<i>t</i> , trabeculae
<i>er</i> , erythrocyte	<i>tr</i> , trachea
<i>gc</i> , gland cells	<i>ty</i> , thyroid gland
<i>gl</i> , glandular lobe of hypophysis	<i>V</i> ³ , third ventricle
<i>hc</i> , Hassall's corpuscle	<i>y</i> , yellow cells
<i>i</i> , interstitial tissue	
<i>in</i> , infundibulum	
<i>is</i> , interspace	

EXPLANATION OF PLATES

PLATE I

- FIG. 1. A low-power drawing of a transverse section through the adrenals and adjacent structures of a 40 cm. alligator.
- FIG. 2. A medium-power view of part of a transverse section of the adrenal of a 75 cm. alligator, showing the massing of the chromaphil cells, under the capsule.
- FIG. 3. A part of a transverse section of the adrenal of a 60 cm. alligator as seen under a magnification of about 500 diameters. The region here shown was about half way between the center and the periphery of the gland.
- FIG. 4. A figure to show the shape and position of the thyroid gland in a 40 cm. alligator. About life size.
- FIG. 5. A portion of the thyroid and parathyroid glands of the alligator as seen under fairly low magnification.
- FIG. 6. A few alveoli of the thyroid gland of the alligator under a magnification of about 400 diameters. In some glands there is more interalveolar connective tissue.
- FIG. 7. A section through the parathyroid shown in figure 5, magnified about 400 diameters.

PLATE 2

- FIG. 8. A section of the parathyroid and post-branchial body of a 70 cm. alligator under low magnification.
- FIG. 9. A portion of the section shown in the preceding figure, drawn under much greater magnification.
- FIG. 10. A transverse section of the thymus gland of the alligator as seen under fairly low magnification.
- FIG. 11. A small portion of the thymus gland, shown in the preceding figure, magnified about 400 diameters.
- FIG. 12. A low-power sketch of a section through the spleen of the alligator, cut at right angles to the long axis of the organ.
- FIG. 13. The splenic pulp of the alligator magnified about 500 diameters.

PLATE 3

- FIG. 14. An outline sketch of a ventral view of the brain of the alligator to show relative size and position and the hypophysis.
- FIG. 15. A lateral view of the brain and hypophysis shown in the preceding figure.
- FIG. 16. A low-power, camera sketch of a sagittal section of the infundibulum and hypophysis of the alligator. Anterior end to the left.
- FIG. 17. A low-power, camera drawing of a transverse section through the nervous part of the hypophysis of the alligator.
- FIG. 18. A part of the glandular region of the hypophysis of the alligator, under high magnification.
- FIG. 19. The middle region of the hypophysis of the alligator, under high magnification.
- FIG. 20. The nervous part of the hypophysis of the alligator, under high magnification.



For explanation, see page 14.

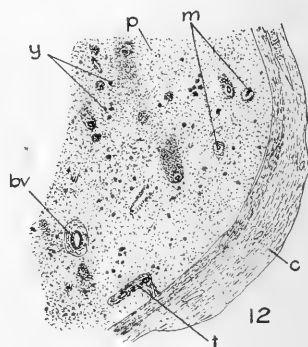
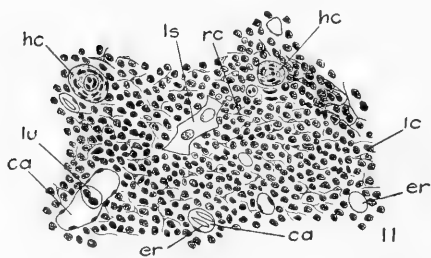
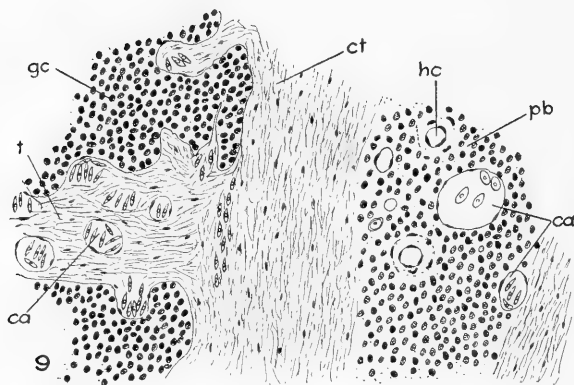
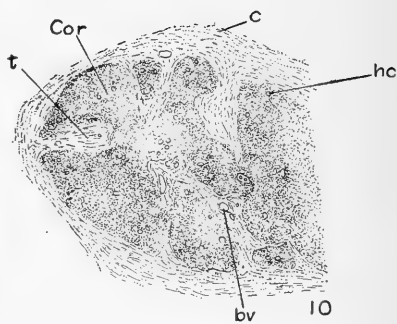
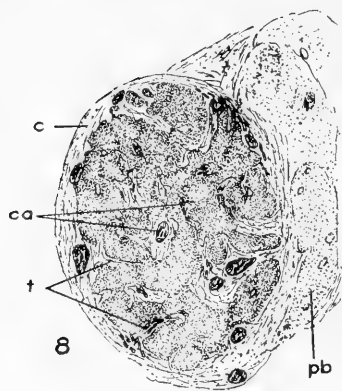

For explanation, see page 14.

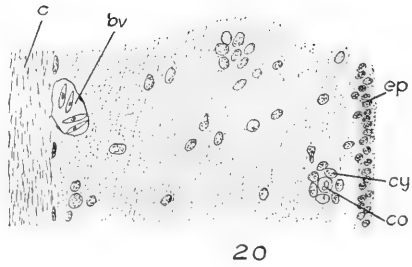
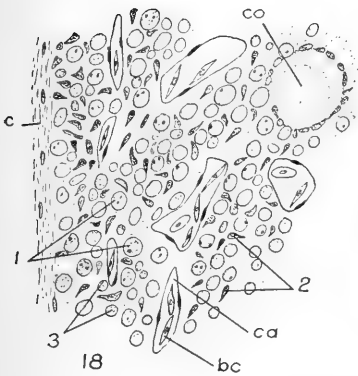
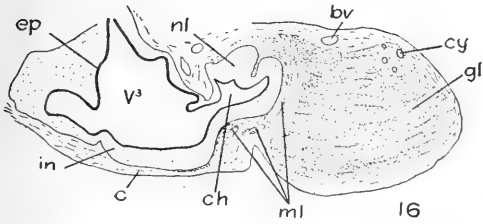
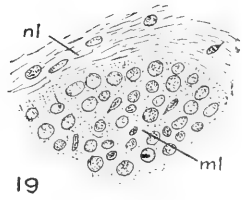
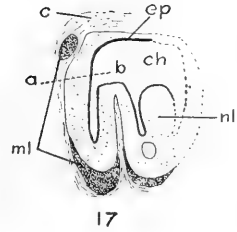
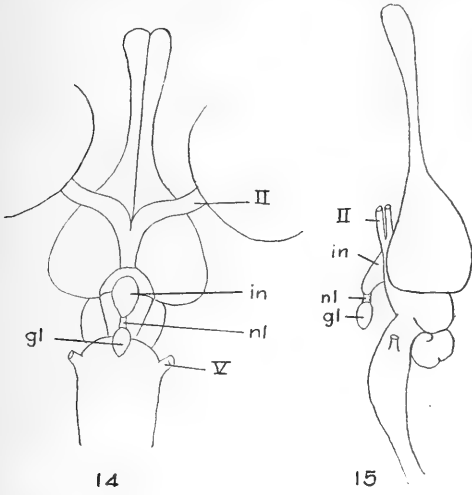

For explanation, see page 14.

SMITHSONIAN MISCELLANEOUS COLLECTIONS

VOLUME 82, NUMBER 17

THE TYPES OF LAMARCK'S GENERA OF
SHELLS AS SELECTED BY J. G. CHILDREN

IN 1823

FREE PUBLIC LIBRARY

BY

A. S. KENNARD, A. L. S., A. E. SALISBURY
AND B. B. WOODWARD, F. L. S.



(PUBLICATION 3112)

CITY OF WASHINGTON
PUBLISHED BY THE SMITHSONIAN INSTITUTION
JULY 11, 1931



SMITHSONIAN MISCELLANEOUS COLLECTIONS
VOLUME 82, NUMBER 17

THE TYPES OF LAMARCK'S GENERA OF
SHELLS AS SELECTED BY J. G. CHILDREN
IN 1823

BY

A. S. KENNARD, A. L. S., A. E. SALISBURY
AND B. B. WOODWARD, F. L. S.



(PUBLICATION 3112)

CITY OF WASHINGTON
PUBLISHED BY THE SMITHSONIAN INSTITUTION
JULY 11, 1931

The Lord Baltimore Press
BALTIMORE, MD., U. S. A.

THE TYPES OF LAMARCK'S GENERA OF SHELLS AS
SELECTED BY J. G. CHILDREN IN 1823

BY A. S. KENNARD, A. L. S., A. E. SALISBURY AND
B. B. WOODWARD, F. L. S.

In 1823, J. G. Children, an assistant keeper in the British Museum, published a small work entitled "Lamarck's/Genera of Shells,/ Translated from the French,/ By/ J. G. Children, F. R. S./ &c.&c.&c./ With Plates/ From Original Drawings,/ By Miss Anna Children./ 1823./ "

This little work, now very rare, first appeared serially, without the author's name, in the successive numbers of the Quarterly Journal of Science, the official organ of the Royal Institution of Great Britain, of which at the time Children was editor, between October, 1822, and January, 1824, as follows:

Reprint	Original in Quart. J. Sci.
pp. 1-24	Vol. XIV, Oct. 1822, pp. 64-86
pp. 25-49	Vol. XIV, Jan. 1823, pp. 298-322
pp. 49*, 50-78	Vol. XV, Apl. 1823, pp. 23-52
pp. 79-122	Vol. XV, July 1823, pp. 216-258
pp. 87-117	
err. typ. for	Vol. XVI, Oct. 1823, pp. 49-79
123-153	
pp. 154-177	Vol. XVI, Jan. 1824, pp. 241-264

Two plates were issued with each of the first four parts and were not renumbered for the reprint. The references in the text of the third part to "Pl. I" and "Pl. II" should read respectively "Pl. II" and "Pl. III." The last part was probably issued late in December, 1823.

The work consists of a translation of the diagnoses of the shell-bearing genera in Lamarck's "Histoire naturelle des Animaux sans Vertèbres", Tom. V-VII, 1818-22, with designation of a type to each. These types are in most cases the first species cited by Lamarck himself, but frequently a species other than the first is chosen, occasionally with reason given, or a species from some later work by another author, showing that Children understood "type" in its modern sense.

Practically forgotten until attention was called to it in the Proceedings of the Malacological Society of London (Vol. XV, 1922,

pp. 47-8), citation has since been made from it, but it still remains inaccessible to most, so that the accompanying list of Children's "types", omitting such forms as are now no longer included in the mollusca, should be of service to malacologists in general. At the same time it has seemed desirable to indicate those cases in which these "types" cannot be accepted in view of the International Rules of Zoological Nomenclature.

Children does not appear to have referred to the three French works of earlier date which had direct bearing on his own, namely: Lamarck's "Prodrome", Lamarck's "Système" and Montfort's "Conchyliologie." Nor does he allude to Fleming's articles on "Conchology" and "Mollusca".

The modern conception of a "type" has been rather a matter of growth.¹ Certainly Lamarck in both his "Prodrome" and his "Système" had no intention of doing more than cite examples, for in the former he states "je me borne . . . à la citation d'une seule espèce du chaque genre, afin de me faire mieux entendre," and in the latter "j'ai cité sous chacun d'eux [the genera] une espèce connue . . . et j'y ai joint quelques synonymes que je puis certifier; cela suffit pour me faire entendre". This is further borne out by the frequency with which Lamarck changed his examples.² At the same time where in these two works a new genus is proposed (or taken over from Bruguière not then having a named species attached) Lamarck's example, under the Rules, ranks as a *genotype*.

Montfort described each sole species cited under his genera as "Espèce servant de type au genre" and although not exactly a definite statement nevertheless these are "types" in the modern sense. Fleming seems to have been the first to definitely name "types". Unfortunately he was spasmodic in so doing.³

As customary at the time specific names were not regarded as sacrosanct, and Lamarck frequently changed them, not merely to avoid tautology when raising a specific name to generic rank, or when transferring a species to a new genus, but frequently (whether one of his own or some other writer) for no obvious reason. Fleming tilts at this (Molluscan Animals, 1837, p. 78) when discussing a new

¹ Cf. Proc. Malac. Soc. Lond., Vol. XV, p. 47, 1922.

² Opinion 79 of the International Commission on Zoological Nomenclature is that "'Rigidly construed,' Lamarck's (1801 A) *Système des Animaux sans Vertèbres* is not to be accepted as designation of type species."

³ See R. Winckworth: Notes on nomenclature. 3: Proc. Malac. Soc. Lond., Vol. XVIII, pp. 224-228, 1919.

genus founded by Groye, but later on (p. 180) is guilty of the practice when founding *Velutina*.

Children, of course, did not revive these passed-over names, nor was he careful when selecting a type to see that the species so selected was one of those included in the genus when that was originally described, a point now considered indispensable. To all such items attention is here called by notes in the detailed list that follows, as well as to cases in which the generic name was preoccupied or preceded by another, without, however, thereby necessarily advocating the adoption of such.

Much kind assistance has been given us by various friends to whom we would hereby tend our grateful acknowledgements. More especially to Dr. C. Davies Sherborn with his indispensable "Index", and to Dr. L. F. Spath for valuable help with regard to the fossil Cephalopoda, as well as to Mr. J. R. leB. Tomlin and Mr. R. Winckworth for valuable suggestions; while the Royal, Linnean, and Geological Societies rendered important aid by the special loan of books.

CHILDREN'S TYPES FOR LAMARCK'S GENERA

Where a Lamarckian species named by Children as type is not the first of those under the genus in the "Histoire" its number is prefixed in []. Types from other sources are specially noted.

Abbreviations most frequently used

Cuv. Tabl. = Cuvier's "Table élémentaire."

Fl. 1818 or 1822 = Fleming: articles in the Supplement to the Encyclopædia Britannica.

Gmel. 1791 = Linn. Syst. Nat., ed. 13.

Lk. Hist. = Lamarck's "Histoire"

Lk. Prod. = Lamarck's "Prodrome"

Lk. Syst. = Lamarck's "Système"

Mtf. = Montfort's "Conchyliologie"

For full titles see the Bibliography.

Q. J. S.

1822, Oct. Reprint

Page	Page	Genus	Type & Synonym
68	6	<i>Siliquaria</i>	<i>S. Anguina</i> (<i>Serpula Anguina</i> .)
69	7		Linn.)

§Genus founded by Bruguière, 1789, without species named. Adopted by Lamarck, Prod. 79, with genotype *Serpula anguina*, Lin. Same in Lk. Syst. 98, and Mtf. ii, 39 under changed specific name of *anguilus*.

Q. J. S. 1822, Oct.	Reprint Page	Genus	Type & Synonym
Page 69	7	<i>Dentalium</i>	<i>D. elephantinum</i> (Idem. Linn.) §Same in Cuv. Tabl. 629, Lk. Prod. 78, Lk. Syst. 326, and Mtf. ii, 23.
73	11	<i>Magilus</i>	<i>M. antiquus</i> §Genotype as Mtf. ii, 43.
80	18	<i>Aspergillum</i>	<i>A. Javanum</i> (<i>Serpula penis</i> . Linn.) §Cuv. Tabl. 629 adopts Bruguière's 1789 generic name <i>Penicillus</i> with genotype <i>Serpula pe- nicillata</i> [err. pr. <i>penicillus</i>] Lin. Lk. Prod. 79 cites <i>Serpula penis</i> , Lin., but in Lk. Syst. 98 the specific name is altered to <i>javanus</i> , n. [i. e. Brug.], n.n. for <i>S. penis</i> , Lin. [Fischer has revived the prior generic name <i>Brechites</i> , Guettard 1770, but it is question- able if this can be accepted. <i>Verpa</i> , Bolten Sept., 1798, is a synonym.]
80	18	<i>Clavagella</i>	<i>C. echinata</i> . Stet. §[The generic name first proposed in vernacular by Lamarck in 1812 and latinized by Blain- ville (Dic. Sci. Nat.) in 1817 without any species cited.]
80 81	18 19	<i>Fistulana</i>	<i>F. clava</i> Preoccupied by Fabricius 1780 and Müller 1776 §Genus founded by Bruguière 1789 without species named. Adopted by Lamarck, Prod. 90 for genotype <i>Teredo clava</i> , Gmel. Lk. Syst. 129 cites four species, <i>clava</i> being the first. [For a discussion of this genus, see Iredale, Proc. Malac. Soc. Lond., xi, 1915, p. 297. See also Sowerby "Genera", no. xxvii.]
81	19	<i>Septaria</i>	<i>S. arenaria</i> (<i>Serpula polythalamia</i> . Linn.) §Genotype. Should read <i>S. polythalamia</i> (Lin.) [Non <i>Septaria</i> , Férussac, 1807. Linn. Syst. Nat., ed. 10, 787 made Rumph's <i>Solen arenar- ius</i> a syn. of his own <i>Serpula arenaria</i> , but in ed. 12, 1266, while leaving <i>arenaria</i> distinct he transferred Rumph's species to the syn. of his new <i>S. polythalamia</i> .]

Q. J. S.			
1822, Oct.	Reprint	Genus	Type & Synonym
Page	Page		
81	19	<i>Teredina</i>	<i>T. personata</i> . §Stet.
81	19	<i>Teredo</i>	
82	20		<i>T. navalis</i> [Idem. Linn.] §Stet.
			§Lk. Prod. 90 cites <i>T. navalis</i> , Lin. for which he substitutes the n.n. <i>vulgaris</i> in Syst. 128.
82	20	<i>Pholas</i>	<i>P. dactylus</i> (Idem. Linn.) §Stet.
			§Lk. Prod. 90 cites <i>P. dactylus</i> , Lin., but in Syst. 127 cites <i>costata</i> , Lin. (6th species in the Hist.).
83	21	<i>Gastrochæna</i>	<i>G. cuneiformis</i> . <i>Pholas hians</i> . Chemn. §Stet.
83	21	<i>Solen</i>	<i>S. vagina</i> Idem. Linn. §Stet.
			§Same in Lk. Prod. 83 and Lk. Syst. 126.
83	21	<i>Panopæa</i>	
84	22		<i>P. Aldrovandi</i> (<i>Mya Glycimeris</i> . Linn.) [i. e. Gmel.]
			§Sole species, but type name should read <i>P. glycimeris</i> (Born) the species being of that author and not of Gmelin who cited it from him, while it does not occur in Linné. [Generic name preceded by <i>Glycimeris</i> , Lamk., 1799, non <i>Glycymeris</i> , DaCosta, 1778, non Lamk., 1801.]
84	22	<i>Glycimeris</i>	<i>G. Siliqua</i> . §Stet.
			§[Nec <i>Glycymeris</i> , DaCosta, 1778, nec <i>Glycimeris</i> , Lmk., 1799="Certodaire" Daudin= <i>Cyrtodaria</i> , Cuvier, 1800.]
84	22	<i>Mya</i>	
85	23		<i>M. truncata</i> (Idem. Linn.) §Stet.
			§Same in Lk. Prod. 83 and Syst. 127.
85	23	<i>Anatina</i>	<i>A. lanterna</i> [i. e. laterna].
			§Children's selection cannot stand. Type by tautonomy is <i>Solen anatinus</i> , Lin. which Lamarck renamed <i>subrostrata</i> . [Generic name preoccupied by Schumacher, 1817, and preceded by <i>Laternula</i> , Bolten, 1798, and <i>Auriscalpium</i> , Megerle v. M., 1811.]
86	24	<i>Lutraria</i>	<i>L. solenoides</i> .
			§Genotype, Lk. Prod. 85, is <i>Mya lutraria</i> , Lin.

Q. J. S. 1823, Jan.	Page	Reprint Page	Genus	Type & Synonym
	298	25	<i>Mactra</i>	<i>M. gigantea</i> . §Invalid § <i>gigantea</i> was not included in Linné's genus when founded. Lk. Prod. 85 and Syst. 121 cite <i>M. stultorum</i> which selected by Fleming must be taken as type.
	298	25	<i>Crassatella</i>	
	299	26		<i>C. Kingicola</i> . §Invalid. §Not one of the species named when the genus was founded. Genus first established by Lamarck in 1799 (Prod. 85) genotype <i>Mactra cygnea</i> , Chemn., which is a <i>Mactra</i> . Name utilized again in 1801 (Lk. Syst. 119) for <i>C. gibba</i> , Chemn. and another fossil species, while in 1818 the specific name was changed to <i>tumida</i> ; in both cases <i>Venus ponderosa</i> is cited as synonym and this was selected by Gray in 1847 as type. The <i>Crassatella</i> of 1801 and 1818 being pre-occupied by the <i>Crassatella</i> of 1799 the generic name <i>Crassatellites</i> of Krüger, 1823, has been substituted, type <i>Crassatella sinuata</i> , Lmk. (<i>Teste</i> Harris, 1897.) [<i>Paphia</i> created 1799 (Lk. Prod. 85) without type, but for which two species were cited in Lk. Syst. 120, was sunk in the Histoire in species 5 and 7 of <i>Crassatella</i> .]
	299	26	<i>Erycina</i>	<i>E. cardioides</i> . §Invalid. §Sole species in the Histoire, but not one of those when the genus was founded. Gray, 1847, selected <i>E. trigona</i> and this must be accepted.
	299	26	<i>Ungulina</i>	
	300	27		[2] <i>U. transversa</i> §Lamarck thought this might be only a variety of <i>oblonga</i> , which is generally considered to be the type, and it is the form figured in Bosc where Daudin described the genus.

Q. J. S. 1823, Jan.	Reprint Page	Page	Genus	Type & Synonym
300	27		<i>Solenomya</i>	[2] <i>S. Mediterranea</i> . §Stet. §[Lamarck wrote <i>Solemya</i> , usually emended to <i>Solenomya</i> .] <i>S. mediterranea</i> was n.n. for the <i>Tellina togata</i> of Poli, 1795.
300	27		<i>Amphidesma</i>	
301	28			<i>A. variegata</i> . §Stet. §[Lamarck in 1812 had proposed "Donacille" which was Latinized as <i>Donacilla</i> in 1819 or a year later than the present name. The genus is preceded by <i>Semele</i> , Schumacher, 1817, type <i>S. reticulata</i> , Schum.]
301	28		<i>Corbula</i>	[6] <i>C. nucleus</i> . §Invalid. §Genus founded by Bruguière, 1797, without species named. Adopted and defined by Lamarck (Prod. 89) also without species. Lk. Syst. 1801, p. 137, added species not including <i>nucleus</i> . Gray in 1847 selected Lamarck's first species <i>sulcata</i> as type, and that stands.
301	28		<i>Pandora</i>	
302	29			<i>P. rostrata</i> (<i>Tellina inequivalvis</i> . Linn.) §Bruguière founded the genus in 1797, but named no species. Lamarck adopted it (Prod. 88) with genotype <i>P. inaequivalvis</i> (Lin.). He afterwards changed the specific name first (Syst. 137) to <i>margaritacea</i> and then (Hist.) to <i>rostrata</i> .
302	29		<i>Saxicava</i>	<i>S. rugosa</i> (<i>Mytilus rugosus</i> . Linn.) §Stet.
302	29		<i>Petricola</i>	
303	30			[5] <i>P. striata</i> . invalid. § <i>P. striata</i> was a nomen nudum when the genus was founded. The type is <i>lithophaga</i> Retz.

Q. J. S. 1823, Jan.	Reprint Page	Genus	Type & Synonym
Page 303	30	<i>Venerupis</i>	<i>V. perforans</i> (<i>Venus perforans</i> . <i>Montag.</i>). §Stet. §[Gray, 1847, makes this a synonym of <i>Rupel- laria</i> of Fleuriau-Bellevue, which however was a composite genus and in part sunk by Lamarck in his <i>Petricola</i> .]
304	31	<i>Sanguinolaria</i> [2]	<i>S. rosea</i> (<i>Solen sanguinolentus</i> , Gmel.) §Genotype (Lk. Prod. 84) is <i>Solen sanguino- lentus</i> , Gmel. Name arbitrarily changed in Lk. Syst. 125 to <i>rosea</i> .
304	31	<i>Psammobia</i> [2]	<i>P. feroensis</i> (<i>Tellina fereonsis</i> [sic]. Gmel.) §The specific name is misprinted in Gmelin (3235) as <i>fervensis</i> , Chemnitz and Bolten both give <i>ferroensis</i> .
304	31	<i>Psammotea</i> [err. typ. pro <i>Psammotæa</i>]	[8] <i>P. donacina</i> . §Stet.
305	32		
305	32	<i>Tellina</i>	
306	33		<i>T. radiata</i> (Idem. Linn.) §Stet. §Lk. Prod. 84 cites <i>T. virgata</i> , Lin., but Lk. Syst. 124 gives <i>T. radiata</i> , Lin.
306	33	<i>Tellinides</i>	<i>T. Timorensis</i> . §Sole species.
306	33	<i>Corbis</i>	
307	34		<i>C. fimbriata</i> (<i>Venus fimbriata</i> , Linn.) §Stet.
307	34	<i>Lucina</i>	<i>L. Jamaicensis</i> (<i>Venus Jamaic- ensis</i> . Chemn.) §Genus founded by Bruguière in 1797 with un- named figures. Adopted and defined by La- marck, 1799 (Prod. 84) with genotype <i>Venus</i> <i>edentula</i> , Lin. Changed in Lk. Syst. 124 to <i>jamaicensis</i> , which is invalid.
307	34	<i>Donax</i>	
308	35		<i>D. scortum</i> (Idem. Linn.) §Stet.
308	35	<i>Capsa</i>	<i>C. laevigata</i> (<i>Donax laevigata</i> . Gmel.) §[Non <i>Capsa</i> , Lamk., 1799 (Prod. 84) ex Brug.; non Lamk., 1801, Syst. 125 = <i>Asaphis</i> , Modeer, 1793.

Q. J. S. 1823, Jan.	Reprint Page	Genus	Type & Synonym
			Children's selection stands for <i>Capsa</i> , Lamk. 1818= <i>Iphigenia</i> , Schumacher, 1817.
308	35	<i>Crassina</i>	
309	36		<i>C. Danmoniensis</i> (<i>Venus Danmoniensis</i> . Montagu.)
			§Genotype. [Genus preceded by <i>Astarte</i> , Sowb., 1816.]
310	37	<i>Cyclas</i>	<i>C. Rivicola</i> (<i>Cyclas cornea</i> [?]. Draparn.)
			§ <i>C. rivicola</i> , Leach, here first described, was not a member of the genus when founded and cannot stand as type. Genus founded 1798 by Lamarck on plate and figures in Ency. méth., was defined by him in 1799 (Prod. 84) with genotype <i>C. cornea</i> , Lin. [Genus preceded by <i>Sphærium</i> , Scopoli, 1777.]
310	37	<i>Cyrena</i>	
311	38		[3] <i>C. cor.</i> §stet.
311	38	<i>Galathea</i>	<i>G. radiata</i> (A variety of this genus is the <i>Venus subviridis</i> of Gmelin.)
			§Genus founded by Bruguière 1797 as <i>Galatea</i> [correct form of name]. Adopted by Lamarck 1805 as <i>Galathea</i> monotype <i>G. radiata</i> . [Preoccupied by Fabricius, 1793 (Crust.), so that <i>Egeria</i> , Roissy, 1805, must be accepted.]
311	38	<i>Cyprina</i>	
312	39		[2] <i>C. Islandica</i> (<i>Venus Islandica</i> . Linn.)
			§[Genus proposed in 1812 in vernacular dates from here. It is preceded by <i>Arctica</i> , 1817, which in turn is preoccupied for Aves by Moehring, 1758. <i>Armida</i> of Gistel 1848, is a synonym.]
312	39	<i>Cytherca</i>	

Q. J. S. 1823, Jan.	Reprint Page	Page	Genus	Type & Synonym
	313	40		<i>C. lusoria</i> (<i>Venus lusoria</i> , Chemn.) §Lamarck's original name of <i>Meretrix</i> (Prod. 85) stands for this genus, with genotype <i>Venus meretrix</i> , Lin. He changed the specific name in Syst. 122 to <i>labiosa</i> . The type is therefore <i>Meretrix meretrix</i> (Lin.). [Non <i>Cytherea</i> , Bolten, 1798, for which Dall gives as type <i>Venus puerpera</i> , Lin.]
	313	40	<i>Venus</i>	
	314	41		<i>V. puerpera</i> (Idem. Linn.) §Not one of the species included in Linné's genus. Gray, 1847, selected <i>V. verrucosa</i> , Lin.
	314	41	<i>Venericardia</i>	<i>V. planicosta</i> . §Stet. §Genus founded by Lamarck (Syst. 123) for <i>V. imbricata</i> and <i>V. planicosta</i> .
	315	42	<i>Cardium</i>	<i>C. costatum</i> (Idem. Linn.) §Stet. §Lk. Prod. 86 cites <i>C. aculeatum</i> , Lin., but in Syst. 119 transferred to <i>C. costatum</i> , Linné's first species.
	316	43	<i>Cardita</i>	<i>C. sulcata</i> (<i>Chama antiquata</i> , Linn.) Stet. §Genus founded by Bruguière in 1792 with 13 species. Lk. Prod. 86 cites <i>Chama calyculata</i> , Lin., but in Syst. 118 changed to <i>C. variegata</i> , Br., which in the Hist. is sunk in <i>C. calyculata</i> (Lin.).
	316	43	<i>Cypricardia</i>	<i>C. Guinaica</i> (<i>Chama oblonga</i> , Linn.) §Lamarck's name being a synonym the type name should read <i>C. oblonga</i> (Lin.) [Genus preceded by <i>Libitina</i> , Schumacher, 1817.]
	317	44	<i>Hiatella</i>	<i>H. arctica</i> (<i>Mya arctica</i> , Linn.) §Sole species quoted by Lamarck, who admits he was unacquainted with the genus, and certainly not one of Daudin's indeterminable two. Lamarck's synonymy cites both <i>Mya arctica</i> , Lin., and <i>Solen minutus</i> , Lin. The latter was selected by Gray, 1847, as type for Daudin's genus.

Q. J. S.					
1823, Jan.	Reprint				
Page	Page	Genus	Type & Synonym		
317	44	<i>Isocardia</i>	<i>I. cor</i> (<i>Chama cor</i> . Linn.)		
			§Genotype (Lk. Prod. 86) is <i>Chama cor</i> , Lin. Lk. Syst. 118 cited two species one being <i>globosa</i> , n.n. for <i>cor</i> .		
318	45	<i>Cucullaea</i>	<i>C. auriculifera</i> (<i>Arca cucullus</i> . Gmel.)		
			§Genus founded by Lamarck (Syst. 116) for <i>C. auriculifera</i> and <i>C. anatina</i> ; the former being n.n. for <i>Arca cucullata</i> , Chemn. (non binom.) = <i>cucullus</i> , Gmel. (3311). The type by tautonomy is <i>C. cucullus</i> (Gmel.).		
318	45	<i>Arca</i>			
319	46		<i>A. tortuosa</i> (Idem. Linn.) §Stet.		
			§Lk. Prod. 87 and Syst. 116 cite <i>A. noæ</i> , Lin., and this was accepted by Gray, 1847.		
319	46	<i>Pectunculus</i>			
320	47		<i>P. glycymeris</i> (<i>Arca glycymeris</i> ? Linn.)		
			§Genotype, Lk. Prod. 87, is <i>Arca pectunculus</i> , Lin. Lk. Syst. 115 cites <i>P. subauritus</i> , which in Hist. is sunk in <i>P. pectiniformis</i> , n.n. for <i>pectunculus</i> . [Genus preoccupied by DaCosta, 1778, for some Veneridae, and preceded by <i>Glycymeris</i> of the same author, type <i>Arca glycymeris</i> , Lin.]		
320	47	<i>Nucula</i>	[2] <i>N. rostrata</i> (<i>Arca rostrata</i> . Brug.)		
			§Genotype, Lk. Prod. 87, is <i>Arca nucleus</i> , Lin., renamed in Syst. 115 <i>N. margaritacea</i> , n.		
321	48	<i>Trigonia</i>	<i>T. pectinata</i> . §Invalid.		
			§The recent form, not having been discovered when Bruguière, 1789, named and figured the genus from fossil examples, cannot stand as type. Lk. Prod. 86 defined the genus, but gave no type. Lk. Syst. 117 cites <i>T. nodulosa</i> , n., and this accepted by Gray, 1847, must be taken for the type.		
321	48	<i>Castalia</i>			
322	49		<i>C. ambigua</i> . §Genotype.		

Q. J. S. 1823, April	Reprint Page	Genus	Type & Synonym
	24	<i>Unio</i> .	
	25		<i>U. sinuata</i> (<i>Mya margaritifera</i> ? Linn.)
			§Lk. Prod. 87 cites <i>Mya margaritifera</i> , Lin., but as already noted his citations in this work for genera other than his own cannot be accepted. In Lk. Syst. 114 the totally different <i>U. littoralis</i> , Cuv., is cited, but neither that species nor the <i>U. sinuata</i> , Lamk. [= <i>auricularius</i> , Spengler, 1793], named by Children, was included in the genus when founded by Retzius in 1788 and consequently are invalid. <i>U. margaritifera</i> was made the type of a new genus <i>Margaritifera</i> by Schumacher in 1816 and this invalidates Turton's selection of it in 1831. Hence <i>U. pictorum</i> , Lin., selected by Gray in 1847 becomes the type.
	25	<i>Hyria</i>	<i>H. avicularis</i> (<i>Mya syrmatophora</i> ? Gmel.)
			§The identity of <i>avicularis</i> with <i>syrmatophora</i> being doubtful Children's selection stands though Herrmannsen favors the latter. [Generic name preceded by <i>Paxyodon</i> , Schumacher, 1817.]
	25	<i>Anodonta</i>	
	26		<i>A. cygneus</i> (<i>Mytilus cygneus</i> . Linn.)
			§Genotype, Lk. Prod. 87, is <i>Mytilus cygneus</i> , Lin., though <i>anatina</i> is cited in Lk. Syst. 114.
	26	<i>Iridina</i>	
	27		<i>I. exotica</i> . §Genotype.
	27	<i>Diceras</i>	
	28		<i>D. arietinum</i> [sic] (<i>Chama bicornis</i> . Brug.)
			§Sole species, but Bruguière's specific name having priority holds, and type is <i>Diceras bicornis</i> (Brug.).

Q. J. S.					
1823, April	Reprint	Genus	Type & Synonym		
Page	Page				
28	54	<i>Chama</i>	<i>C. lazarus</i> (Idem. Linn.)	§Stet.	
			§Lk. Prod. 81 cites <i>C. lazarus</i> , Lin., and Lk. Syst. 131 gives the same and another species.		
28	54	<i>Etheria</i>			
29	55		[3] <i>E. semilunata</i> .	§Stet.	
			§[Generic name emended to <i>Ætheria</i> by Oken, 1818.]		
30	56	<i>Tridacna</i>			
31	57		<i>T. gigas</i> (<i>Chama gigas?</i> Linn.)		
			§Generic name proposed by Bruguière, 1797, on plate with figures. Adopted by Lamarck (Prod. 86) with diagnosis and genotype <i>Chama gigas</i> , Lin.		
			[Bolten, 1798, proposed <i>Tridachnes</i> for the generic name.]		
31	57	<i>Hippopus</i>	<i>H. maculatus</i> (<i>Chama hippopus</i> , Linn.)		
			§Genotype, Lk. Prod. 86, is <i>Chama hippopus</i> , Lin. Name arbitrarily changed in Lk. Syst. 117 to <i>maculatus</i> .		
32	58	<i>Modiola</i>	<i>M. papuana</i>		
			§Invalid. Proposed as <i>Modiolus</i> , Lk. Prod. 87, with genotype (p. 88) <i>Mytilus modiolus</i> , Lin.		
33	59	<i>Mytilus</i>	<i>M. magellanicus</i>		
			§ <i>magellanicus</i> was not a Linnean species and cannot stand as type. Lk. Prod. 88 and Syst. 113 cite <i>M. edulis</i> , Lin., and this selected by Gray, 1847, must be taken as type.		
33	59	<i>Pinna</i>			
34	60		<i>P. rudis</i> (Idem. Linn.)		
			§Same in Lk. Prod. 88 and Syst. 112.		
34	60	<i>Crenatula</i>			
35	61		[2] <i>C. modiolaris</i>		
			§Not a species included in the genus when founded by Lamarck in 1803. Sowerby (Genera, VIII, 1822) figured two of the original species and of these Gray, 1847, selected, as of Sowerby, <i>C. mytiloides</i> , which should therefore be reckoned the type.		

Q. J. S. 1823, April		Reprint	Genus	Type & Synonym
Page	Page			
35	61		<i>Perna</i>	<i>P. ehippium</i> (<i>Ostrea ehippium</i> . Linn.) §Genus founded by Bruguière, 1789 [non <i>Perna</i> , Retzius, 1788]. Adopted by Lamarck, Prod. 80, genotype <i>P. ehippium</i> [sic], Lin. The same citation occurs in Lk. Syst. 134. [Generic name preceded by <i>Isognomon</i> , So- lander, 1786, <i>Melina</i> , Retzius, 1788, and <i>Isogonum</i> , Bolten, 1798.]
36	62		<i>Malleus</i>	<i>M. albus</i> §Genotype, Lk. Prod. 82, is <i>Ostrea malleus</i> , Lin. Specific name changed in Lk. Syst. 133 to <i>vulgaris</i> .
36	62		<i>Avicula</i>	
37	63			<i>A. crocea</i> . §Bruguière created the name in 1792 for un- named figures. Lamarck, Prod. 82, cited <i>Mytilus hirundo</i> , Lin., but changed the specific name unnecessarily in Lk. Syst. 134 to <i>communis</i> . <i>A. crocea</i> was a species of much later date. Cuvier 1798 (Tabl. 422) adopted and defined the genus citing three species. Of these we here nominate <i>A. hirundo</i> , Lin., as the type. [Genus preceded by <i>Pteria</i> , Scopoli, 1777.]
37	63		<i>Meleagrina</i>	<i>M. margaritifera</i> (<i>Mytilus mar- garitiferus</i> . Linn.) §[Genus preceded by <i>Pinctada</i> , Sect. 1 of Bol- ten, 1798.]
38	64		<i>Pedum</i>	<i>P. spondyloideum</i> (<i>Ostrea spon- dyloidea</i> , Gmel.) §Bruguière created the name for figures in 1792. Lamarck adopted and defined it, Prod. 88, with sole species and genotype <i>Ostrea spon- dyloidea</i> , Chemn. [or rather Gmelin], which is repeated in Syst. 136.
38	64		<i>Lima</i>	

Q. J. S. 1823, April		Reprint	Genus	Type & Synonym
Page	Page			
39	65			[2] <i>L. squamosa</i> (<i>Ostrea Lima</i> . Linn.)
			§Bruguière created the name for figures in 1797. Genus adopted and defined by Cuvier 1798 (Tabl. 421), with genotype <i>Ostrea Lima</i> , Lin. Lamarck (Prod. 88) cited the same but changed the specific name unnecessarily in Syst. 136 to <i>squamosa</i> .	
39	65	<i>Plagiostoma</i>	<i>P. transversa</i>	§ <i>transversa</i> was not a member of the genus when founded by Sowerby. The type is <i>P.</i> <i>gigantea</i> , Sowb. (Min. Conch. 1814).
40	66	<i>Pecten</i>	<i>P. maximus</i> (<i>Ostrea maxima</i> . Linn.)	§Stet. Lk. Prod. 88 cites <i>P. jacobæa</i> , Lin., but changed in Lk. Syst. 135 to <i>P. maxima</i> , Lin.
40	66	<i>Plicatula</i>		
41	67		<i>P. cristata</i>	§ <i>P. cristata</i> was not named by Lamarck when founding the genus in 1801 (Syst. 132) only <i>P. gibbosa</i> , n.n. for <i>Spondylus plicatus</i> , Lin., and <i>P. depressa</i> are cited. The former is sunk in the Hist. in <i>P. ramosa</i> . <i>P. plicatus</i> must be taken for type as recommended by Sowerby in 1822 (Genera III) and selected by Gray in 1847.
41	67	<i>Spondylus</i>		
42	68		<i>S. gæderopus</i> (Idem. Linn.)	§Stet. Same in Lk. Syst. 131.
42	68	<i>Podopsis</i>	<i>P. truncata</i> .	§Stet.
43	69	<i>Gryphaea</i>	<i>G. angulata</i> .	§Stet.
43	69	<i>Ostrea</i>		
44	70		<i>O. edulis</i> (Idem. Linn.)	§Stet. Same in Lk. Prod. 81 and Syst. 132.
44	70	<i>Vulsella</i>	[4] <i>V. spongiarum</i> .	§Genotype Lk. Prod. 82 is <i>Mya vulsella</i> , Lin. Specific name changed unnecessarily in Lk. Syst. 133 to <i>lingulata</i> . [Bolten, 1798, also created the same generic name with same type.]

Q. J. S.		Reprint			
1823, April		Page	Page	Genus	Type & Synonym
45	71			<i>Placuna</i>	<i>P. sella</i> (<i>Anomia sella</i> . Linn.) §Bruguère founded the genus, 1789, without species named. Adopted by Cuvier 1798 (Tabl. 418) with two species of which we here select <i>P. placenta</i> , Lin., as type. Lamarck, Prod. 82, and Lk. Syst. 135, cite the same. [Same generic name used by Solander, 1786, for which Iredale, 1915, proposed the same type.]
45	71			<i>Anomia</i>	
46	72				<i>A. cphippium</i> (Idem. Linn.) §Lk. Prod. 83 and Syst. 138 cite it as <i>A. ephippium</i> [sic].
47	73			<i>Sphaerulites</i>	<i>S. foliacea</i> §Sole species: now ranked as a synonym of <i>Radiolites</i> .
47	73			<i>Radiolites</i>	
48	74				<i>R. rotulans</i> [sic, Lmk. wrote <i>rotularis</i>] §Genotype, Lk. Syst. 130 is <i>R. angiodes</i> , n., which in the Hist. is divided between <i>rotularis</i> and <i>ventricosa</i> .
48	74			<i>Birostrites</i>	<i>B. incquiloba</i> §Sole species: founded on an internal cast of <i>Radiolites</i> .
1823, July					
220	84			<i>Hyalæa</i>	<i>H. tridentata</i> (<i>Monoculus telemus</i> ? Linn.) §Genotype, Lk. Prod. 89, is <i>Anomia tridentata</i> , Forsk. Specific name changed unnecessarily in Syst. 140 to <i>cornea</i> .
221	85			<i>Clio</i>	[No shell.] §[Genotype, Lk. Syst. 61, is <i>Clione borealis</i> , Pallas. Non <i>Clio</i> , Lin., 1767. The valid generic name is <i>Clione</i> , Pallas, 1774.]
221	85			<i>Cleodora</i>	<i>C. pyramidata</i> (<i>Clio pyramidata</i> . Linn.) §Stet. Genus founded in 1810 by Péron and LeSueur, but species given there in vernacu-

Q. J. S. 1823, July Page	Reprint Page	Genus	Type & Synonym
			lar only. [Generic name preceded by <i>Clio</i> , Linné, 1767.]
221	85	<i>Limacina</i>	
222	86		<i>L. helicalis</i> (<i>Clio helicina</i> . Gmel.) §Sole species, but type name should read <i>L.</i> <i>helicina</i> (Gmel.).
222	86	<i>Cymbulia</i>	<i>C. peronii</i> §Sole species and genotype. Genus founded 1810 by Péron and LeSueur, but species then given in vernacular.
222	86	<i>Pneumodermon</i>	[No shell.] §[Monotype <i>P. peronii</i> , confirmed by Fl. 1822, 570.]
223	87	<i>Phyllidia</i>	[No shell.] §[Genus founded 1798 by Cuvier as <i>Phyllida</i> , with type <i>P. borbonica</i> . Generic name altered by him in his Table to <i>Phyllidia</i> . Lk. Syst. 66 cites <i>Phyllidia varicosa</i> , n.
223	87	<i>Chitonellus</i>	<i>C. lævis</i> . §Stet.
224	88	<i>Chiton</i>	[2] <i>C. squamosus</i> (Idem. Linn.) §Stet. Lk. Prod. 90 cites <i>C. tuberculatus</i> , Lin., but Lk. Syst. 67 cites <i>C. gigas</i> , which is not a Linnean species.
224	88	<i>Patella</i>	
225	89		[2] <i>P. granatina</i> (Idem. Linn.) §Stet. Lk. Prod. 78 cites <i>P. granularis</i> , Lin., but Lk. Syst. 68 cites <i>P. testudinaria</i> , Lin., while Mtf. ii, 67 cites <i>P. roseus</i> , which is a <i>Fissurella</i> . Fl. 1818, 313 suggested "the common limpet" as type. Gray, 1847, se- lected <i>P. testudinaria</i> .
225	89	<i>Pleurobranchus</i>	
226	90		<i>P. Peronii</i> §Sole species: was Cuvier's genotype, 1804.
226	90	<i>Umbrella</i>	<i>U. Indica</i> (<i>Patella umbellata</i> . Gmel.) §Gmelin's specific name having priority the type is <i>U. umbellata</i> (Gmel.). [Generic name preceded by <i>Umbraculum</i> , Schumacher, 1817.]

Q. J. S. 1823, July	Reprint Page	Genus	Type & Synonym
Page 227	91	<i>Pharmophorus</i>	<i>P. australis</i> §Blainville's genus, 1817, was preceded by <i>Scutus</i> , Montfort (ii, 59) with genotype <i>S. antipodes</i> for which Lamarck in his Hist. substituted the name <i>P. australis</i> .
228	92	<i>Emarginula</i>	<i>E. fissura</i> (<i>Patella fissura</i> , Linn.) §Lk. Syst. 69 cites the same under the synonym of <i>E. conica</i> , while Mtf. ii, 75 further alters it into <i>E. reticulatus</i> .
228	92	<i>Fissurella</i>	[2] <i>F. nimbose</i> (<i>Patella nimbose</i> , Linn.) §Genus founded by Bruguière, 1789, without species named. Adopted by Lamarck, Prod. 78, with genotype <i>Patella nimbose</i> , Lin. Lk. Syst. 69 and Mtf. ii, 103 cite <i>F. radiata</i> , a synonym for <i>Patella picta</i> , Gmel.
229	93	<i>Pileopsis</i>	<i>P. ungarica</i> (<i>Patella ungarica</i> , Linn.) §[Generic name preceded by <i>Capulus</i> , Montf., ii, 55 with same type.]
230	94	<i>Calyptrea</i>	[3] <i>C. equestris</i> (<i>Patella equestris</i> , Linn.) §Genotype, Lk. Prod. 78, is <i>Patella chinensis</i> , Lin., wrongly exchanged in Lk. Syst. 70 and Mtf. ii, 79 for <i>P. equestris</i> , Lin.
230	94	<i>Crepidula</i>	<i>C. fornicata</i> (<i>Patella fornicata</i> , Linn.) §Genotype, Lk. Prod. 78, is <i>Patella fornicata</i> , Lin., although Lk. Syst. 70 cites <i>C. porcellana</i> , n., Mtf. ii, 87 reverts to <i>fornicata</i> .
230	94	<i>Ancylus</i>	
231	95		<i>A. lacustris</i> (<i>Patella lacustris</i> , Linn.) § <i>lacustris</i> was Geoffroy's sole cited species and genotype. Mtf. ii, 64 admits the same.
231	95	<i>Acera</i>	[No shell.] §[Lamarck's sole species is <i>A. carnosa</i> (Cuv.).]

Q. J. S. 1823, July	Reprint Page	Genus	Type & Synonym
231	95	<i>Bullæa</i>	<i>B. aperta</i> (<i>Bulla aperta</i> . Linn.) §Sole species. Genotype Lk. Syst. 63 is <i>B. planciana</i> , n., which it is admitted includes the <i>Bulla aperta</i> , Lin. The latter therefore stands. [Generic name preceded by <i>Philine</i> , Ascanius, 1772, monotype <i>P. quadripartita</i> , Asc.= <i>aperta</i> , Lin.]
231	95	<i>Bulla</i>	
232	96		<i>B. lignaria</i> (Idem. Linn.) §Lk. Prod. 75, Lk. Syst. 90, Mtf. ii, 331 and Fl. 1818, 310 all name <i>B. ampulla</i> , Lin., as type and this must stand since Montfort, 1810 (ii, 335) took <i>lignaria</i> as genotype for his <i>Scaphander</i> .
233	97	<i>Laplysia</i>	<i>L. depilans</i> (Idem. Linn.) §Same in Lk. Syst. 62. [Generic name altered by Cuvier 1798 (Tabl. 386) to <i>Aplysia</i> with <i>depilans</i> as genotype. He is followed by Fleming, 1822, 576. Pilsbry's advocacy of the exchange of the generic names <i>Aplysia</i> and <i>Tethys</i> is to be deplored.]
233	97	<i>Dolabella</i>	<i>D. Rumphii</i> §Lk. Syst. 62 has genotype <i>D. callosa</i> , n., which in the Hist. is wrongly included in the later date <i>D. Rumphii</i> , Cuv.
234	98	<i>Onchidium</i>	[No shell.] §[Lk. Syst. 65 cites <i>O. typhae</i> , which is Buchanan's genotype.]
234	98	<i>Parmacella</i>	<i>P. caliculata</i> § Genotype <i>P. Olivieri</i> , Cuv., 1805, and sole species named by Lamarck. Children took his type from Sowerby (Genera XIII) which of course is inadmissible.
235	99	<i>Limax</i>	<i>L. rufus</i> (Idem. Linn.) §Same in Lk. Syst. 64. Férussac, however, in 1819 subdivided the genus and took <i>L. antiquorum</i> , Fér. [= <i>maximus</i> , Lin.] as type of <i>Limax</i> , and <i>rufus</i> , Lin. [= <i>empiricorum</i> , Fér.] as type of his new genus <i>Arion</i> . This allocation stands.

Q. J. S.			
1823, July	Reprint		
Page	Page	Genus	Type & Synonym
235	99	<i>Testacella</i>	
236	100	<i>Testacella</i>	<i>T. haliotidea</i> §Lk. Syst. 96 gives as genotype " <i>haliotoides</i> , n. ex D. Mauger, ex ins. Teneriffæ," which = <i>T. maugæi</i> , Fér.
236	100	<i>Vitrina</i>	<i>V. pellucida</i> §Draparnaud's genotype. Same in Mtf. ii, 239.
237	101	<i>Helix</i>	
238	102		<i>H. gigantea</i> (<i>Helix cornu militaire</i> . Linn.) §Lk. Prod. 76 cites <i>H. nemoralis</i> , Lin., but Lk. Syst. 94 and Mtf. ii, 231 cite <i>H. pomatia</i> , Lin., which Fl. 1818, 312 definitely designated and which is, therefore, the type.
238	102	<i>Carocolla</i>	<i>C. acutissima</i> §Montfort (ii, 139) founded the genus as <i>Caraculus</i> with <i>oculatus</i> (= <i>Helix carocolla</i> , Lin.) as genotype. The correct type is, therefore, <i>Caraculus carocolla</i> (Lin.). Lamarck's name for the species in the Hist. (sp. 2) is <i>albilabris</i> .
238	102	<i>Anostoma</i>	<i>A. depressum</i> [sic] (<i>Helix ringens</i> . Linn.) §Genus founded by Fischer de W., 1807, for <i>A. octodentata</i> and <i>A. hexodon</i> (= <i>ringens</i> , Lin., teste Pilsbry). Montfort (ii, 359) called it <i>Tomogeres ringens</i> . Lamarck in the Hist. changed the name to <i>depressa</i> . The type is, therefore, <i>A. ringens</i> (Lin.).
239	103	<i>Helicina</i>	<i>H. neritella</i> . §Stet. §Genus proposed by Lamarck (Prod. 76) without named type, but Lk. Syst. 94 gives <i>H. neritella</i> , n. Mtf. ii, 171 arbitrarily changed the name to <i>Pitonnillus muricinus</i> .
239	103	<i>Pupa</i>	<i>P. mumia</i> §Lk. Syst. 88, genotype <i>Turbo urva</i> , Lin. Montfort (ii, 299) cites the same. [Non <i>pupa</i> , Bolten, 1798; nec Draparnaud, 1805. Generic name preceded by <i>Cerion</i> , Bolten, 1798.]

Q. J. S. 1823, July	Reprint	Genus	Type & Synonym
Page	Page		
239	103	<i>Clausilia</i>	
240	104		<i>C. torticollis</i>
			§Not one of the species included in the genus as originally described. <i>C. rugosa</i> , Drap., selected by Turton, 1831, is the type.
240	104	<i>Bulimus</i>	[2] <i>B. haemastomus</i> (<i>Helix oblonga</i> . Gmel.)
			§Bruguière admits taking the name "employé par M. Scopoli [1786 non 1777] pour le Bulime oblong." Lk. Prod. 75 and Lk. Syst. 90 cite <i>B. Hæmastomus</i> , Scop., Mtf. ii, 259 cites the same under the changed name of <i>roseus</i> , but with the addition of the syn. <i>B. oblongus</i> , Brug., which is the <i>Helix oblonga</i> of Müller and of Gmelin. The type of Lamarck's <i>Bulimus</i> should, therefore, appear as <i>B. oblongus</i> (Müll.).
240	104	<i>Achatina</i>	<i>A. perdir</i> (<i>Bulla achatina</i> . Linn.)
			§Genotype, Lk. Prod. 75, is <i>Bulla achatina</i> , Lin. Lamarck subsequently changed the specific name without cause first to <i>variegata</i> (Syst. 91) and then to <i>perdir</i> . Mtf. ii, 419 selected <i>zebra</i> , Brug.
			[Preceded by <i>Ampulla</i> , Bolten, 1798.]
241	105	<i>Succinea</i>	[2] <i>S. amphibia</i> (<i>Helix putris</i> . Linn.)
			§ <i>amphibia</i> being only n.n. by Draparnaud for <i>Helix putris</i> , Lin., the type is, as first designated by Fleming (1822, 574), <i>Succinea putris</i> (Lin.).
			[Montfort, ii, 91, adopted Lamarck's later name of <i>Amphibulina</i> and gave <i>A. cucullata</i> as type.]
241	105	<i>Auricula</i>	<i>A. Midæ</i> (<i>Voluta auris Midæ</i> . Linn.)
			§Genotype, Lk. Prod. 76, is <i>Voluta auris-midæ</i> , Lin., shortened in Lk. Syst. 92 to <i>midæ</i> . Montfort, ii, 311, took <i>Judæ</i> , from the <i>auris-Judæ</i> of Lin.
			[Preceded by <i>Ellobium</i> , Bolten, 1798.]

Q. J. S. 1823, July	Reprint Page	Genus	Type & Synonym
241	105	<i>Cyclostoma</i>	[2] <i>C. volvulus</i>
242	106		§Lamarck's genotype for this genus in 1799 was <i>Turbo scalaris</i> , Lin., which in his Syst. 88 he transferred to <i>Scalaria</i> , a name which is preceded by <i>Epitonium</i> , Bolten, 1798. His second type in 1801, Syst. 87, was <i>Turbo delphinus</i> , Lin., which in 1803 he transferred to his genus <i>Delphinula</i> . Draparnaud, 1805, employed the generic name for a miscellaneous assemblage. Montfort in 1810 (ii, 291) chose as type the <i>Helix volvulus</i> of Müller, a Cyclophorid, and this remains the type of <i>Cyclostoma</i> , Lamk., of the Histoire.
242	106	<i>Planorbis</i>	[2] <i>P. corneus</i> (<i>Helix cornea</i> . Linn.)
			§Lk. Prod. 76 and Syst. 94 cite the <i>Helix cornuarietis</i> of Linné. Montfort, ii, 271, chose <i>Helix cornea</i> , Lin., and has been followed by most authors, but when Geoffroy founded the genus he included the <i>Helix planorbis</i> of Linné and so did Müller who followed him. The type by tautonomy is, therefore, <i>Planorbis planorbis</i> (Lin.).
242	106	<i>Physa</i>	
243	107		[2] <i>P. fontinalis</i> (<i>Bulla fontinalis</i> . Linn.)
			§Same in Fl. 1822, p. 574.
243	107	<i>Lymnaea</i>	[2] <i>L. stagnalis</i> (<i>Helix stagnalis</i> . Linn.)
			§Genotype, Lk. Prod. 75, is <i>Helix stagnalis</i> , Lin. The same is cited in Lk. Syst. 91 and Mtf. ii, 263 (with altered generic name of <i>Lymnus</i>) and by Fl. 1818, 312.
244	108	<i>Melania</i>	[2] <i>M. truncata</i> .
			§Genotype in Lk. Prod. 75 is <i>Helix amarula</i> , Lin., which is again cited in Syst. 91. Mtf. ii, 323, has the same under the changed name of <i>Melas melanus</i> .

Q. J. S. 1823, July Page	Reprint Page	Genus	Type & Synonym
			[Generic name preceded by <i>Plotia</i> and <i>Thiara</i> of Bolten, 1798.]
244	108	<i>Melanopsis</i>	[2] <i>M. lævigata</i> § <i>lævigata</i> is admittedly a synonym for <i>bucinoidea</i> , Oliv., which was Férussac's genotype in 1807.
244	108	<i>Pirena</i>	<i>P. terebralis</i> (<i>Strombus ater</i> . Linn.) §Generic name first given by Lamarck in the vernacular in 1812, Latinized by him in 1816 with (figure) genotype <i>P. madagascarensis</i> , changed in Hist. to <i>P. spinosa</i> . [Fischer considers this genus to be a synonym for <i>Faunus</i> , Montfort (ii, 427), genotype <i>F. melanopsis</i> .]
245	109	<i>Valvata</i>	<i>V. piscinalis</i> §Müller's genotype was <i>V. cristata</i> , which, therefore, stands.
245	109	<i>Paludina</i>	<i>P. vivipara</i> (<i>Helix vivipara</i> . Linn.) §In 1809 Lamarck used the vernacular name "Vivipare" for this genus changing it in 1812 to "Paludine." Its Latin form <i>Paludina</i> first occurs here (1822). Meantime Montfort 1810 (ii, 247) adopted and Latinized the former name with type <i>V. fluviorum</i> which was n.n. for <i>vivipara</i> , Lin. The correct name of the type is, therefore, <i>Viviparus viviparus</i> (Lin.).
246	110	<i>Ampullaria</i>	<i>A. Guyanensis</i> §Genotype, Lk. Prod. 76, is <i>Helix ampullacea</i> , Lin., which is renamed in the Hist. (sp. 3) <i>fasciata</i> . Lk. Syst. 93 cites <i>A. rugosa</i> , n., which Mtf. ii, 243 repeats giving as syn. <i>Bulinus urceus</i> , Brug. = <i>Nerita urcea</i> , Müll. [Generic name preceded by <i>Pila</i> , Bolten, 1798, with same type.]
246	110	<i>Navicella</i>	[3] <i>N. tessellata</i> . §Stet. §[Generic name first proposed in the vernacular by Lamarck in 1809 and first Latinized by him

Q. J. S. 1823, July Page	Reprint Page	Genus	Type & Synonym
			in 1816. It is preceded by <i>Septaria</i> , Férussac, 1807, and <i>Cimber</i> , Montfort, 1810.]
247	111	<i>Neritina</i>	[2] <i>N. pulligera</i> (<i>Nerita pulligera</i> . Linn.) §Genus first proposed in the vernacular, "Neritine," by Lamarck in 1809; this he Latinized in 1816 (Ency. méth. Vers, "Liste des Objects"). Children's selection holds for Lamarck's genus. [The fresh-water forms usually included under the genus had already been separated by Montfort in 1810 under his genera <i>Clithon</i> (ii, 327) and <i>Theodoxus</i> (ii, 351). <i>Neritina</i> , 1816, is preceded by <i>Laphrostoma</i> , Rafinesque, 1815.]
247	111	<i>Nerita</i>	<i>N. exuvia</i> (Idem. Linn.) §Same in Lk. Prod. 77 and Syst. 95. [S. P. Woodward in his "Manual" gives as type " <i>ustulata</i> ," which is a misprint for <i>undata</i> , Lin.]
247	111	<i>Natica</i>	
248	112		<i>N. glaucina</i> (Idem. Linn.) §Lk. Prod. 77, Syst. 95, and Mtf. ii, 219, all cite <i>N. canrena</i> , Lin., so that this must stand as type for Lamarck. [Preoccupied by <i>Natica</i> , Scopoli, 1777, syn. <i>Albula</i> , Bolten, 1798.]
248	112	<i>Ianthina</i>	<i>I. communis</i> (<i>Helix Ianthina</i> . Linn.) §Commonly spelled with a "J." Lk. Prod. 75 cites <i>Helix janthina</i> , Lin. Lk. Syst. 89 and Mtf. ii, 215 changed the specific name to <i>fragilis</i> . The type name should read <i>Ianthina ianthina</i> (Lin.) [Generic name first proposed by Bolten, 1798.]
248	112	<i>Sigaretus</i>	

Q. J. S. 1823, July	Reprint Page	Page	Genus	Type & Synonym
249		113		<i>S. haliotoideus</i> (<i>Helix haliotoidea</i> . Linn.) §Genotype, Lk. Prod. 77, is <i>Helix haliotoidea</i> , Lin. Same cited in Lk. Syst. 64. Mtf. ii, 107 renamed it <i>S. Adansonii</i> . [Generic name preceded by <i>Sinum</i> , Bolten, 1798.]
249	113		<i>Stomatella</i>	[3] <i>S. sulcifera</i> § <i>sulcifera</i> was not included in the genus as originally founded and cannot stand. Gray, 1847, selected <i>S. imbricata</i> , Lamk., which must be accepted. [Generic name first proposed by Lamarck in vernacular in 1809 and first latinized by him in 1816. It is preceded by <i>Phymotis</i> , Ra- finesque, 1815.]
249	113		<i>Stomatia</i>	<i>S. phymotis</i> (<i>Haliotis imperforata</i> . Chemn.) §Stet. Is Helbling's genotype. Lk. Prod. 77 cited the synonym <i>Haliotis im-</i> <i>perforata</i> , Chemn., but accepted <i>phymotis</i> in Syst. 96. Mtf. ii, 111 changed the names to <i>Stomax furonculus</i> .
249	113		<i>Haliotis</i>	[2] <i>H. Iris</i> (Idem. Gmel.) § <i>iris</i> was not one of the species in the genus as originally founded and cannot stand. Lk. Prod. 77 cites <i>H. tuberculata</i> , Lin., but renamed the species in Syst. 97 <i>vulgaris</i> , re- verting to <i>tuberculata</i> in the Hist. (sp. 4). Mtf. ii, 119, selected <i>H. asinus</i> of Roissy [i. e. Linné], and although Gray, 1847, named <i>H.</i> <i>tuberculata</i> as type, and this is the generally accepted one, Montfort's selection cannot be passed over.
250	114		<i>Tornatella</i>	<i>T. flammea</i> (<i>Voluta flammea</i> . Linn.) §Stet, but the specific name is due to Gmelin and not to Linné.

Q. J. S. 1823, July Page	Reprint Page	Genus	Type & Synonym
			[Lamarck's generic name proposed in 1812 in the vernacular only dates in Latin form from 1822, so that it is preceded by <i>Acteon</i> , Montf. (ii, 315) 1810, genotype <i>A. tornatilis</i> (Lin.), a species renamed by Lamarck in Hist. <i>fasciata</i> .]
250	114	<i>Pyramidella</i>	[2] <i>P. dolabrata</i> (<i>Trochus dolabratus</i> , Linn.) §Genotype, Lk. Prod. 76, is <i>Trochus dolabratus</i> , Lin. Same in Lk. Syst. 92 and Mtf. ii, 499.
251	115	<i>Vermetus</i>	<i>V. lumbricalis</i> §Generic name <i>Vermetus</i> first used by Adanson, who is pre-Linnean. Cuvier, 1800, used it as a nude name. Meantime Lamarck, 1799, Prod. 78, created <i>Vermicularia</i> with genotype <i>Serpula lumbricalis</i> , Lin., and the same appears in Syst. 97 and Mtf. ii, 31 so that this must stand.
251	115	<i>Scalaria</i>	<i>S. pretiosa</i> (<i>Turbo scalaris</i> , Linn.) §Genotype, Lk. Syst. 88, is <i>S. conica</i> , n.n. for <i>Turbo scalaris</i> , Lin. Mtf. ii, 295 has <i>Scalarius scalatus</i> a synonym for the same. In the Hist. Lamarck changed the specific name to <i>preciosa</i> . The correct name for Lamarck's type is <i>Scalaria scalaris</i> (Lin.). [Lamarck originally took this species in 1799 as genotype for his genus <i>Cyclostoma</i> (q.v. for other changes). The genus was preceded by <i>Epitonium</i> , Bolten, 1798.]
251	115	<i>Delphinula</i>	<i>D. laciniata</i> (<i>Turbo delphinus</i> , Linn.)
252	116		§In 1801 Lamarck, Syst. 87, cited the <i>Turbo delphinus</i> , Lin., as type of his genus <i>Cyclostoma</i> of that date (see antea <i>Cyclostoma</i>) changing it to the present genus in 1803. Montfort, ii, 131 has <i>Delphinus spinosus</i> a synonym for the same Linnean species. The

Q. J. S.			
1823, July	Reprint		
Page	Page	Genus	Type & Synonym
			type name should read <i>Delphinula delphinus</i> (Lin.). [Generic name preceded by <i>Angaria</i> , Bolten, (1798).]
252	116	<i>Solarium</i>	<i>S. perspectivum</i> (<i>Trochus perspectivus</i> . Linn.) §Genotype, Lk. Prod. 74, is <i>Trochus perspectivus</i> , Lin. Same in Lk. Syst. 86; and Mtf. ii, 163. [Generic name preceded by <i>Architectonica</i> , Bolten, 1798.]
252	116	<i>Rotella</i>	<i>R. lineolata</i> (<i>Torchus vestiarius</i> . Linn.) §Lamarck's specific name being n.n. for Linné's the type name should read <i>R. vestiarius</i> (Lin.). [Generic name preceded by <i>Umbonium</i> , Link, 1807.]
253	117	<i>Trochus</i>	<i>T. imperialis</i> (Idem. Gmel.) §Children's selection not being Linnean, species is not valid. Lk. Prod. 74, Lk. Syst. 86, Montf. ii, 179 and most later writers give <i>T. niloticus</i> . This, however, only dates from 1767, not 1758, and so must give way to <i>T. maculatus</i> , selected by T. Iredale in Proc. Malac. Soc. Lond., x, 1912, p. 225.
253	117	<i>Monodonta</i>	[2] <i>M. pagodus</i> (<i>Turbo pagodus</i> . Linn.) §Genotype, Lk. Prod. 74, is <i>Turbo labio</i> , Lin. The same selection occurs in Lk. Syst. 87, Mft. ii, 195 and Fl. 1818, 311.
253	117	<i>Turbo</i>	
254	118		<i>T. marmoratus</i> (Idem. Linn.) §Same in Lk. Prod. 74 and Lk. Syst. 86 but Mft. ii, 203 chose <i>T. petholatus</i> , Lin., which must therefore stand.
254	118	<i>Planaxis</i>	<i>P. sulcata</i> . §Stet.
254	118	<i>Phasianella</i>	

Q. J. S. 1823, July	Reprint Page	Genus	Type & Synonym
Page 255	119		<i>P. bulimoides</i> (<i>Buccinum australe</i> . Gmel.)
			§Not one of the species in the genus as originally founded by Lamarck in 1804 on fossil forms. Type, selected by Harris in 1897, is <i>P. tur-</i> <i>binoides</i> , Lmk. [Mtf. ii, 255 altered the genus to <i>Phasianus</i> , type <i>variegatus</i> , Roissy.]
255	119	<i>Turritella</i>	<i>T. duplicata</i> (<i>Turbo duplicatus</i> . Linn.)
			§Genotype, Lk. Prod. 74, is <i>Turbo terebra</i> , Lin., and the same is cited in Lk. Syst. 89. Mont- fort changed the specific name (ii, 211) to <i>terebratus</i> .
256	120	<i>Cerithium</i>	[2] <i>C. palustre</i> (<i>Strombus palus-</i> <i>tris</i> . Linn.)
			§Genus founded by Bruguière, 1789, no species being then named, but dealt with fully by him in 1792. Lk. Prod. 73 cites <i>Murex aluco</i> , Lin., Lk. Syst. 85 cites <i>C. nodulosum</i> , Brug. Mtf. ii, 511 chose <i>C. virgatum</i> [err. typ. pro <i>ver-</i> <i>tagum</i> , Lin.]. Fl. 1818, 311 designated “ <i>Tympanotonos asper</i> of Mart.,” which = <i>C.</i> <i>nodulosum</i> , Brug., the generally accepted type.
256	120	<i>Pleurotoma</i>	
257	121		<i>P. Babylonica</i> [sic] (<i>Murex Baby-</i> <i>lonius</i> . Linn.)
			§Genotype, Lk. Prod. 73, is <i>Murex Babylonius</i> , Lin. Same in Lk. Syst. 84 and Mtf. ii, 535. [Generic name preceded by <i>Turris</i> , Boltzen, 1798, with the same type.]
257	121	<i>Turbinella</i>	[7] <i>T. cornigerum</i> (<i>Voluta turbi-</i> <i>nellus</i> . Linn.)
			§Genotype, Lk. Prod. 73, is <i>Voluta pyrum</i> , Lin., though by tautonomy the type should be <i>T.</i> <i>turbinella</i> (Lin.). Lk. Syst. 83, Mtf. ii, 547 and Fl. 1818, 310, however, all accept <i>T.</i> <i>pyrum</i> (Lin.). [Generic name preceded by <i>Xancus</i> , Boltzen, 1798.]

- Q. J. S.
1823, July
- | Page | Reprint
Page | Genus | Type & Synonym |
|------|-----------------|--------------------|--|
| 257 | 121 | <i>Cancellaria</i> | <i>C. reticulata</i> (<i>Voluta reticulata</i> , Linn.)
§Type by tautonomy <i>C. cancellata</i> (Lin.), but Lk. Prod. 71 gives as genotype <i>Voluta reticulata</i> , Lin. Lk. Syst. 76 and Mtf. ii, 563 treat this as a synonym of <i>cancellata</i> , but in the Hist. Lamarck regards the two as distinct. |
| 258 | 122 | <i>Fasciolaria</i> | <i>F. tulipa</i> (<i>Murex tulipa</i> , Linn.)
§Genotype Lk. Prod. 73 is <i>Murex tulipa</i> , Lin., and the same is quoted in Lk. Syst. 83 and Mtf. ii, 491.
[Generic name preceded by <i>Colus</i> , Bolten, 1798 with same type.] |
| 258 | 122 | <i>Fusus</i> | [3] <i>F. colus</i> (<i>Murex colus</i> , Linn.)
§Genus founded, 1789, by Bruguière without species named. Adopted by Lamarck 1799, Prod. 73, with genotype <i>Murex colus</i> , Lin., but in Syst. 82 he changed the specific name to <i>longicauda</i> . Mtf. ii, 527 also cites <i>colus</i> .
[Generic name preoccupied by Helbling, 1779, and used again by Bolten, 1798, who proposed <i>Syrinx</i> for the present group.] |
| 258 | 122 | <i>Pyrula</i> | <i>P. canaliculata</i> (<i>Murex canaliculatus</i> , Linn.)
§Genotype, Lk. Prod. 73, is <i>Bulla ficus</i> , Lin. Same also cited in Lk. Syst. 82 and Mtf. ii, 487.
[Generic name preceded by <i>Ficus</i> , Bolten, 1798, with type by tautonomy <i>F. ficus</i> (Lin.).] |
- 1823, Oct.
49 87 [=123] *Struthiolaria* *S. nodulosa* (*Murex stramineus*, Gmel.)
§Lamarck's specific name being a n.n. for Gmelin's, the type name should read *S. stramineus* (Gmel.).

Q. J. S.

1823, Oct. Reprint

Page	Page	Genus	Type & Synonym
49	87 [= 123]	<i>Ranella</i>	<i>R. gigantea</i> (<i>Murex reticularis</i> . Linn.)

§Lamarck's specific name being a n.n. for Linné's, the type name should read *R. reticularis* (Lin.).

[Generic name preceded by *Bursa*, Bolten, 1798.]

50	88 [= 124]	<i>Murex</i>	[2] <i>M. brandaris</i> (Idem. Linn.)
----	------------	--------------	---------------------------------------

§Lk. Prod. 72 cites *M. ramosus*, Lin., but Lk. Syst. 81 cites *M. haustellum*, Lin., which was designated type by Gray in 1847. Montfort, ii, 619, took *M. tribulus*, Lin., which he renamed *M. pecten*, and placed *haustellum* in a new genus *Brontes* (p. 623) which is preoccupied by Fabricius in 1801 for Coleoptera. *M. tribulus*, Lin., is thus the type.

51	89 [= 125]	<i>Triton</i>	<i>T. variegatum</i> (<i>Murex Tritonis</i> . Linn.)
----	------------	---------------	--

§Genotype, Mtf. ii. 587, is *Murex tritonis*, Lin. Lamarck in the Hist. changed the specific name to *variegatum*.

[Generic name being preoccupied by Linné 1758, for a Cirriped and by Laurenti, 1768, for a reptile, has been replaced by *Charonia* of Gistel, 1848.]

52	90 [= 126]	<i>Rostellaria</i>	<i>R. curvirostris</i> (<i>Strombus fusus</i> . Linn.)
----	------------	--------------------	--

§Genotype, Lk. Prod. 72, is *Strombus fusus*; Lin., renamed in the Hist. *R. curvirostris*. Lk. Syst. 81 cites *R. subulata*, n., which was changed in the Hist. to *Rectirostris*, n.n. for *clavus*, Gmel. Mtf. ii, 519 took *R. ternatum*, n.n. for *fuscus*, Lin., while Fl. 1818, 311, designated *cornuta* of Martini = *fuscus*, Lin.

[Generic name preceded by *Tibia*, Bolten, 1798.]

52	90 [= 126]	<i>Pterocera</i>	
----	------------	------------------	--

Q. J. S.

1823, Oct. Reprint

Page Page

53 91 [= 127]

Genus

Type & Synonym

[2] *P. lambis* (*Strombus lambis*.
Linn.)

§Genotype, Lk. Prod. 72, is *Strombus lambis*,
Lin. Same in Lk. Syst. 81. Montfort, ii, 607,
gave *Pteroceras scorpius* (Lin.). Generic
name preceded by *Lambis* Bolten.

53 91 [= 127]

Strombus[3] *S. latissimus* (Idem. Linn.)

§Lk. Prod. 72, Lk. Syst. 81 and Mtf. ii, 515 give
S. pugilis, Lin., which should, therefore, be
taken as type.

54 92 [= 128]

Cassidaria

55 93 [= 129]

C. echinophora (*Buccinum echino-*
phorum. Linn.)

§[Generic name was originally given by La-
marck in 1812 in vernacular and so dates only
from 1822. Preceded by *Galeodea*, Link, 1807,
and *Morio*, Montfort, 1810 (ii, 479).]

55 93 [= 129]

Cassis[6] *C. glauca* (*Buccinum glaucum*.
Linn.)

§Genotype, Lk. Prod. 72, is *Buccinum cornutum*,
Lin. Lk. Syst. 80, Mtf. ii, 599 and Fl. 1818,
310, all have the same.

56 94 [= 130]

*Ricinula**R. horrida* (*Murex neritoideus*.
Gmel. [i. e. Linn.]])

§*horrida* being a synonym for *neritoideus* the
type name should read *R. neritoidea* (Lin.).
[Generic name preceded by *Drupa*, Bolten,
1798, and *Sistrum*, Montf., 1810.]

56 94 [= 130]

*Purpura**P. persica* (*Buccinum persicum*.
Linn.)

§Genotype, Lk. Prod. 71, is *Buccinum persicum*,
Lin. Same in Lk. Syst. 77 and Mtf. ii, 467.
[Generic name preceded by *Thais* and *Nucella*
both of Bolten, 1798.]

57 95 [= 131]

Monoceros[2] *M. imbricatum* (*Buccinum*
monodon. Gmel.)

§Lamarck's specific name being a n.n. for
Gmelin's the type name should read *Mono-*
ceros monodon (Gmel.).

- Q. J. S.
1823, Oct. Reprint
Page Page Genus Type & Synonym
- [Generic name preceded by *Acanthina*,
Fischer de W., 1807, and *Unicornus*, Montf.,
1810.]
- 57 95 [= 131] *Concholepas* *C. peruvianum* (*Patella lepas*.
Gmel.)
§Genotype and sole species, Lk. Syst. 70, is
C. peruviana, n.n. for *Buccinum concholepas*,
Brug. Mtf. ii, 367 gives the same. Gmelin's
specific name being of later date passes into
synonymy.
- 58 96 [= 132] *Harpa* [2] *H. ventricosa* (*Buccinum*
harpa. Linn.)
§Genotype, Lk. Prod. 72, is *Buccinum harpa*,
Lin. Lk. Syst. 79 renamed it *H. ventricosa*
and Mtf. ii, 471 called it *H. nobilis* both being
n.n. for Linné's species.
[Bolten proposed the same name in 1798.]
- 58 96 [= 132] *Dolium*
- 59 97 [= 133] [7] *D. perdix* (*Buccinum perdix*.
Linn.)
§Genotype, Lk. Syst. 79, is *Buccinum galea*,
Lin. Mtf. ii, 451 gives the same.
[Generic name preceded by *Tonna*, Brunnich,
1772, and *Cadus*, Bolten, 1798.]
- 59 97 [= 133] *Buccinum* *B. undatum* (Idem. Linn.)
§Same in Lk. Prod. 71, Lk. Syst. 78 and Mtf.
ii, 463.
[*Nassa*, Lk. Prod. 71, with genotype *Buc-*
cinum mutabile, Lin., changed in Lk. Syst.
76 for *N. arcularia*, Lin. (also adopted by
Mtf. ii, 475) was reduced in the Hist. (vii,
p. 276) to a section of *Buccinum*. *Nassa* was
also used by Bolten, 1798.]
- 60 98 [= 134] *Eburna* *E. glabrata* (*Buccinum glabratum*.
Linn.)
§Genotype, Lk. Syst. 78, under n.n. of *E. flavida*
is *Buccinum glabratum*. Lin. Mtf. ii, 507
changed the name to *flavus*.

Q. J. S.

1823, Oct. Reprint

Page	Page	Genus	Type & Synonym
60	98 [= 134]	<i>Terebra</i>	<i>T. maculata</i> (<i>Buccinum maculatum</i> , Linn.)

§Genus founded 1789 by Bruguière without species named. Adopted by Lamarck 1799 (Prod. 71) with genotype *Buccinum subulatum*, Lin. Lk. Syst. 78 cited instead *B. maculatum*, Lin. Mtf. ii, 371 adopted *tigreum*, n.n. for *subulatum*, Lin.

61	99 [= 135]	<i>Columbella</i>	[3] <i>C. mercatoria</i> (<i>Voluta mercatoria</i> , Linn.)
----	------------	-------------------	--

§Genotype, Lk. Prod. 70, is *Voluta mercatoria*, Lin. Same in Lk. Syst. 75 and Mtf. ii, 591. [Dall states that *Pyrene*, Bolten, 1798 (type *discors*, Gmel.) = *Columbella*, Lmk., pars, while Fischer makes *Conidea* of Swainson a synonym of this.]

61	99 [= 135]	<i>Mitra</i>	
----	------------	--------------	--

62	100 [= 136]		<i>M. episcopalis</i> (<i>Voluta episcopalis</i> , Linn.)
----	-------------	--	--

§Genotype, Lk. Prod. 70, is *Voluta episcopalis*, Lin. Same in Lk. Syst. 74 and Mtf. ii, 543.

62	100 [= 136]	<i>Voluta</i>	[2] <i>V. diadema</i> (<i>Voluta æthiopica</i> -var. Linn.)
----	-------------	---------------	--

§*Diadema*, Lmk., was not a member of the genus when founded. Lk. Prod. 70, Lk. Syst. 74 and Mtf. ii, 534 all cite *V. musica*, Lin., which therefore stands as type.

63	101 [= 137]	<i>Marginella</i>	<i>M. glabella</i> (<i>Voluta glabella</i> , Linn.)
----	-------------	-------------------	--

§Genotype, Lk. Prod. 70, is *Voluta glabella*, Lin. Same in Lk. Syst. 75 and Mtf. ii, 559.

63	101 [= 137]	<i>Volvaria</i>	[6] <i>V. bulloides</i>
----	-------------	-----------------	-------------------------

§Genotype, Lk. Syst. 93, is *V. bulloides*, n. Same in Mtf. ii, 411.

Q. J. S.

1823, Oct. Reprint

Page	Page	Genus	Type & Synonym
64	102 [= 138]	<i>Ovula</i>	<i>Ovula oviformis</i> (<i>Bulla ovum</i> , Linn.)

§Genus founded by Bruguière, 1789, without species named. Adopted by Lamarck, Prod. 69, with genotype *Bulla ovum*, Lin. Lk. Syst. 72 changed the specific name to *oviformis*, which was accepted by Mtf. ii, 635, but cannot stand.

[Bolten, 1798, proposed the name *Volva* for the genus.]

65 103 [= 139] *Cypræa*

66 104 [= 140]

C. cervina (*Cypræa oculata*,
Gmel.)

§*oculata*, Gmel., for which *cervina*, Lmk., is a n.n., is not a Linnean species and so not valid for type. Lk. Prod. 69 cites *C. mappa*, Lin., Lk. Syst. 72 cites *C. exanthema*, Lin., while Mtf. ii, 631 chose *C. tigris*, Lin., which is, therefore, the type.

66 104 [= 140] *Terebellum*

67 105 [= 141]

T. subulatum (*Bulla terebellum*,
Linn.)

§The generic name was independently created by both Bolten and Lamarck in 1798, the type in each case being by tautonomy *T. terebellum* (Lin.). Lk. Prod. 69 gave the same, but in Lk. Syst. 72 the specific name was changed to *sabulatum*, n. [err. typ. pro *subulatum*]. Mtf. ii, 379 adopted *subulatum*.

67 105 [= 141] *Ancillaria* *A. cinnamomea*

§[Generic name first proposed by Lamarck in 1799 was *Ancilla* (without species named). Lk. Syst. 73 cited *A. cinnamomea*, n., but Montfort, ii, 383, named *Ancillus buccinoïdes* type, taken from the synonym *Anaulax buccinoïdes*, Roissy, 1805.]

67 105 [= 141] *Oliva*

Q. J. S.

1823, Oct. Reprint

Page Page
68 106 [= 142]

Genus

Type & Synonym

O. porphyria (*Voluta porphyria*.
Linn.)

§Genus founded by Bruguière, 1789, without species named. Adopted and defined by Cuvier, 1798 (Tabl. 409) with genotype *O. porphyria*. Lk. Prod. 70 cited *Voluta oliva*, Lin., which was changed in Lk. Syst. 73 and Mtf. ii, 387 for *porphyria*.

[*Porphyria*, Bolten, 1798, is a synonym.]

69 107 [= 143]

*Conus**C. marmoreus* (Idem. Linn.)

§Same in Lk. Prod. 69 and Syst. 71. Montfort ii, 407 gave *fulgurans*, n.n. for *generalis*, Lin. Children's selection should stand.

[*Cucullus*, Bolten, 1798, non Linné is a synonym.]

73 111 [= 147]

*Belemnites**B. subconica* (*Nautilus belemnita*.
Gmel.)

§Genus founded by Gesner, 1758, with *B. prusicus*, Gesn. [ex Breyn] as type. The *Nautilus belemnita*, Gmel., only dates from 1791. Lk. Prod. 81 cites no species; while Lk. Syst. 104 and Mtf. i, 383 both cite *B. pavillosa*, n.

75 113 [= 149]

Hippurites

76 114 [= 150]

H. rugosa

§Genotype, Lk. Syst. 104, is *H. bioculata*, n. Same in Mtf. i, 287. This specific name does not occur in any form in the Hist.

76 114 [= 150]

Spirula

77 115 [= 151]

S. peronii (*Nautilus spirula*. Linn.)

§Genotype, Lk. Prod. 80, is *Nautilus spirula*, Lin. Name changed in Lk. Syst. 102 and Mtf. i, 99 to *S. fragilis* and in Hist. to *S. Peronii*.

1824, Jan.

[? really

Dec. '23]

246

159

Nautilus

247

160

N. pompilius (Idem. Linn.)

§Same in Lk. Prod. 79 and Syst. 100.

Q. J. S.
1824, Jan.
[? really
Dec. '23]

Page	Reprint Page	Genus	Type & Synonym
248	161	<i>Ammonites</i>	<i>A. Königi</i> §Genus founded by Gesner in 1758, no species named. The name was adopted by Bruguière, 1789 as "auct." and from him by Lamarck in Prod. 79 (no species named) and Syst. 101 where he cites <i>A. bisulcata</i> , Brug. which must be taken as type though the species is not cited in the Hist. neither is <i>A. Königi</i> , of Sowerby, 1820.
248	161	<i>Orbulites</i>	
249	162		<i>O. subradiatus</i> (<i>Ammonites subradiatus</i> . Sowerby.) §Genus founded by Lamarck, Syst. 100, for sole species, and therefore genotype, <i>O. laevis</i> , n., which does not reappear in the Hist.
249	162	<i>Ammonoceratites</i> .	<i>A. glossoidea</i> . §Stet. §[Generic name rendered in the heading <i>Ammonoceras</i> and in the descriptions of species that follow <i>Ammonoceratites</i> . The former is usually adopted.]
250	163	<i>Turrilites</i>	<i>T. costutata</i> [err. typ. pro <i>costulata</i>] §Genotype, Lk. Syst. 102, is <i>T. costata</i> . Same in Mtf. i, 119. Name changed in Hist. to <i>costulata</i> .
250	163	<i>Baculites</i>	<i>B. Faujasii</i> §In founding the genus, Lamarck, Prod. 80, cited no species. Lk. Syst. 103 and Mtf. i, 343, both cite <i>B. vertebralis</i> , which appears in the Hist. under the changed name of <i>B. Faujasii</i> . The correct name of the type is, therefore, <i>B. vertebralis</i> , Lmk.
251	164	<i>Argonauta</i>	

Q. J. S.
1824, Jan.
[? really
Dec. '23]

Page	Reprint Page	Genus	Type & Synonym
252	165		<i>A. argo</i>
			§Lk. Prod. 79 cited <i>A. argo</i> , Lin., but in Syst. 99 changed the name to <i>A. sulcata</i> , reverting, however, in the Hist. to <i>argo</i> . Mft. ii, 7 adopted the synonymic <i>A. sulcata</i> . By typographical error the generic name appears under his figure in some copies as " <i>Aargau-nota</i> ."
253	166	<i>Octopus</i>	[No shell.]
			§[Type <i>Octopus vulgaris</i> , Lmk.]
253	166	<i>Loligopsis</i>	[No shell.]
			§[Lamarck's generic name for sole species <i>L. peronii</i> dates from 1822 and is anticipated by <i>Leachia</i> , of LeSueur, 1821.]
254	167	<i>Loligo</i>	<i>L. vulgaris</i> (<i>Sepia loligo</i> . Linn.)
			[Genus originally founded by Schneider, 1784, who mentions in the text <i>L. maxima</i> , but type is obviously the <i>Sepia loligo</i> , Lin. Lamarck in 1798 employed the same generic name and amongst his species is <i>L. vulgaris</i> , a synonym for <i>Sepia loligo</i> , Lin.]
254	167	<i>Sepia</i>	
256	169		<i>S. officinalis</i> (Idem. Linn.)
			§Same in Lk. Syst. 59.
257	170	<i>Carinaria</i>	<i>C. vitrea</i> (<i>Patella cristata</i> . Linn.)
			§Genotype, Lk. Syst. 99, is <i>C. vitrea</i> , n.n. for <i>Patella cristata</i> , Lin. = <i>Argonauta vitreus</i> , Gmel. The correct type name is, therefore, <i>Carinaria cristata</i> (Lin.).
258	171	<i>Pterotrachca</i>	[No shell.]
			§[Lk. Syst. 61 cites <i>P. coronata</i> , Forsk.]
258	171	<i>Phylliroe</i>	[No shell.]
			§[Sole species cited by Lamarck is <i>P. bucephalum</i> , Peron. Genus founded in 1810 by Peron and LeSueur, but species cited by them in vernacular.]

BIBLIOGRAPHY

[Exclusive of Manuals]

- ASCANIUS (P.) *Philine quadripartita* . . . afterknadt och beskrifvet. (K. Svensk. Vet. Akad. Handl. XXXIII, 1772, pp. 325-7.)
- BLAINVILLE (H. M. D. de) Sur la Patelle allongée de Chemnitz. (Bull. Soc. Sci. Philom. Paris, 1817, pp. 25-28.)
- [Articles in] Dictionnaire des Sciences Naturelles.
- BOLTEN (J. F.) Museum Boltenianum . . . Pars secunda. 8vo. *Hamburgi* (1798). [Facsim. reprint 1906—Index by Dall (Smithsonian Inst., Publ. 2360, 1915).]
- BOSC (L. A. G.) Histoire naturelle des Coquilles. 5 Tom. (Buffon: Hist. Nat. . . . classé . . . par R. R. Castel, 1802.)
- BRUGUIÈRE (J. G.) Encyclopédie méthodique. Vers, Tom. I (A-Con) & Pls. CXC-CCCXC, 1789-98.
- BRUNNICH (M. T.) M. T. Brunnich Zoologiæ fundamenta. 8vo. *Hafniae*, 1772.
- BUCHANAN (F.) An account of the *Onchidium*, a new genus. (Trans. Linn. Soc. Lond., V, 1800, pp. 132-4.)
- COSTA (E. M. Da) Historia Naturalis Testaceorum Britanniae, or British Conchology. 4to. London, 1778.
- CUVIER, *Baron*. (Description d'une mollusque à l'île de Bourdon . . . *Phyllida*.) (Rapp. génér. Trav. Soc. Philom. Paris, Tom. II, 1798, p. 105.)
- Tableau élémentaire de l'Histoire naturelle des Animaux. 8vo. Paris, An VI [1798].
- Leçons d'Anatomie Comparée. 5 Tom. 8vo. Paris, An VIII [1800]-1805.
- Mémoire sur la Phyllidie et le Pleurobranche. (Ann. Mus. Hist. Nat. Paris, V, 1804, pp. 266-76.)
- Mémoire sur la Dolabelle . . . et sur un nouveau genre . . . nommée *Parmacella*. (Ann. Mus. Hist. Nat. Paris, V, 1805, pp. 435-44.)
- Mémoires sur les Acères. (Ann. Mus. Hist. Nat. Paris, XVI, 1810, pp. 1-18.)
- Regne Animal. 4 Tom. 8vo. Paris, 1817. [Issued early in Dec. 1816.]
- DALL (W. H.) Contributions to the Tertiary Fauna of Florida. (Trans. Wagner Free Inst. Sci. Philad., III, 1890-1903.)
- Early History of the generic Name *Fusus*. [With list of valid Boltanian Names.] (Journ. Conch., XI, 1906, pp. 289-297.)
- DRAPARNAUD (J. P. R.) Histoire naturelle des Mollusques terrestres et fluviatiles de la France. 4vo. Paris [1805].
- FÉRUSSAC, *Baron*. Essai d'une méthode conchologique appliquée aux Mollusques fluviatiles et terrestres . . . Nouvelle édition. 8vo. Paris, 1807.
- Histoire naturelle . . . des Mollusques. 2 Tom. fol. Paris, 1819[-51].
- FISCHER VON WALDHEIM (G.) Muséum Demidoff. Tom. III. 8vo. Moscou, 1807.
- FLEMING (J.) Article "Conchology," in "Supplement to the Fourth, Fifth and Sixth Editions of the Encyclopædia Britannica." Vol. III, Feb., 1818 (vide p. 1 of Advt. at end of vol. VI).
- Article "Mollusca" in idem Vol. V, May, 1822 (vide idem).

- FLEURIAU DE BELLEVUE (E.) Mémoire sur quelques nouveaux genres de Mollusques et de Vers lithophages. (Journ. de Physique, LIV, 1802, pp. 345-55.)
- FORSKAL (P.) Descriptiones Animalium . . . quæ in itinere Orientali observavit. 4to. Hauniae, 1775.
- GEOFFROY (E. L.) Traité sommaire des Coquilles . . . de Paris. 12mo. Paris, 1767.
- GESNER (J.) J. Gesneri . . . Tractatus physicus de Petrificatis. 2 Pt. 4to. *Lugduni Batavorum*, 1758.
- GMELIN (J. F.) C. a Linné . . . Systema Naturæ. 13 ed. Tom. I, pars 6, 1791.
- GRAY (J. E.) List of the Genera of Recent Mollusca. (Proc. Zool. Soc. Lond., Pt. XV, Nov., 1847.
- GUETTARD (J. E.) Mémoires sur différentes parties des Sciences et Arts. Tom. III. 4to. Paris, 1770.
- HARRIS (G. F.) Catalogue of the Tertiary Mollusca in the . . . British Museum. Pt. I. Australasian Tertiary Mollusca. 8vo. London, 1897.
- HELBLING (G. S.) Beiträge zur Kenntniss neuer und seltner Konchylien. (Abhandl. Privatgesell. Böhmen, IV, 1779, pp. 102-131.)
- HERRMANNSEN (A. N.) Indicis Generum Malacozoorum primordia. 3 vol. 8vo. Cassellis, 1846-52.
- KRÜGER (J. F.) Geschichte der Urwelt. Thl. II. 8vo. Quedlinburg, 1823.
- LAMARCK (J. B. P. A. DE M. DE) Extrait d'un mémoire sur le genre de la Sèche, du Calmar et du Poulpe. (Bull. Sci. Soc. Philom. Paris, No. 7, 1798, pp. 129-131.)
- Prodrôme d'une nouvelle classification des Coquilles. (Mém. Soc. Hist. Nat. Paris, An VII [1799], pp. 163-91.)
- Système des Animaux sans Vertèbres. 8vo. Paris, An IX, 1801.
- Mémoire sur les Fossiles des environs de Paris. (Ann. Mus. Hist. Nat. Paris. Tom. I-VIII.) 4to. Paris (1802-06).
- Liste des Objects représentés, &c. [Issued with "Encyclop. méthod. Vers." Tables 391-488.] pp. 16. 1816.
- Histoire naturelle des Animaux sans Vertèbres. Tom. V-VII. 8vo. Paris, 1818-22.
- LAMARCK, 1809, 1812. Names bearing these dates were given in the vernacular only and are invalid.
- LESUEUR (C. A.) Descriptions of Several New Species of Cuttlefish. (Journ. Acad. Nat. Sci. Phila., II, 1821, pp. 86-101.)
- See also Pérom & LeSueur.
- LINK (H. F.) Beschreibung der Naturalien-Sammlung der Universität zu Rostock. Abth. 2. 8vo. Rostock, 1807.
- LINNAEUS (C.) Systema Naturæ. 10 ed. 1758 and 12 ed. 1767.
- MEGERLE VON MUEHLFELD (J. C.) Entwurf eines neuen Systems der Schalthiergehäuse. (Mag. Gesell. Naturf. Freunde, Berlin. Jahrg. V, 1811, pp. 38-72.)
- MODEER (A.) Inledning til Kunskapen om Maskkraken i allmänhat. (K. Svensk. Vet. Akad. Stockholm. Nya Handl., XIV, 1793.)
- MONTAGU (G.) Testacea Britannica, &c. 2 Pt. and Suppt. 4°. London, 1803-08.
- MONTFORT (P. D. DE) Conchyliologie systématique. 2 Tom. 8vo. Paris, 1808-10.
- MÜLLER (O. F.) Vermium . . . Historia. Vol. II. 4to. *Havnæ*, 1774.

- PÉRON (F.) *Voyages de découvertes aux Terres Australes*. Tom. II. 4to. & fol. Paris, 1816.
- & LESUEUR (C. A.) *Histoire de la Famille des Mollusques Ptéropodes*. (Ann. Mus. Hist. Nat. Paris, XV, 1810, pp. 57-69.)
- RAFINESQUE-SCHMALTZ (C. S.) *Analyse de le Nature*. 8vo. Palermo, 1815.
- RETZIUS (A. J.) *Dissertatio . . . sistens nova Testaceorum Genera*. 4to. Lundæ, 1788.
- [Frequently misquoted as being the work of the respondent L. M. Philipsson.]
- ROISSY (A. F. P. M. DE) *Histoire Naturelle . . . des Mollusques*. (Suites à . . . Buffon, rédigé par C. S. Sonnini.) Tom. V & VI. 8vo. Paris, An XIII [1805].
- SCHNEIDER (J. G.) *Characteristik des ganzen Geschlechts und der einzelnen Arten von Blakfischen*. (Samml. Vermischt. Abhandl. z. Aufklärung d. Zool., pp. 105-34.) 8vo. Berlin, 1784.
- SCHUMACHER (H. C. F.) *Over conchylologiske Systemer*. (Overs. K. Dansk. Vidensk. Selsk. Forhandl., 1816, p. 7.)
- *Essai d'un nouveau Système des habitation des Vers testacés*. 4vo. Copenhagen, 1817.
- SCOPOLI (J. A.) *Introductio ad Historiam Naturalem*. 8vo. Praga, 1777.
- *Deliciae Floræ et Faunæ Insubricæ*. 3 Pt. Fol. Ticini, 1786-88.
- SOLANDER (D.) *A Catalogue of the Portland Museum*. 4to. London, 1786.
- [Shells named in part by Solander. Cf. Iredale: Proc. Malac. Soc. Lond., XII, 1916, pp. 85-93.]
- SOWERBY (J.) *The Mineral Conchology of Great Britain*. 8vo. London, 1812 (-46).
- & (G. B.) *I. The Genera of Recent and Fossil Shells*. 42 Nos. 8vo. London, 1820 [-34].
- SPENGLER (L.) *Beskrivelse over et nyt Slaegt af de toskallede Konkylier*. (Skrivt. Naturh.-Selskab. Kjöbenhavn, III, 1793, pp. 16-69.)
- TURTON (W.) *Manual of the Land and Fresh-Water Shells of the British Islands*. 8vo. London, 1831.

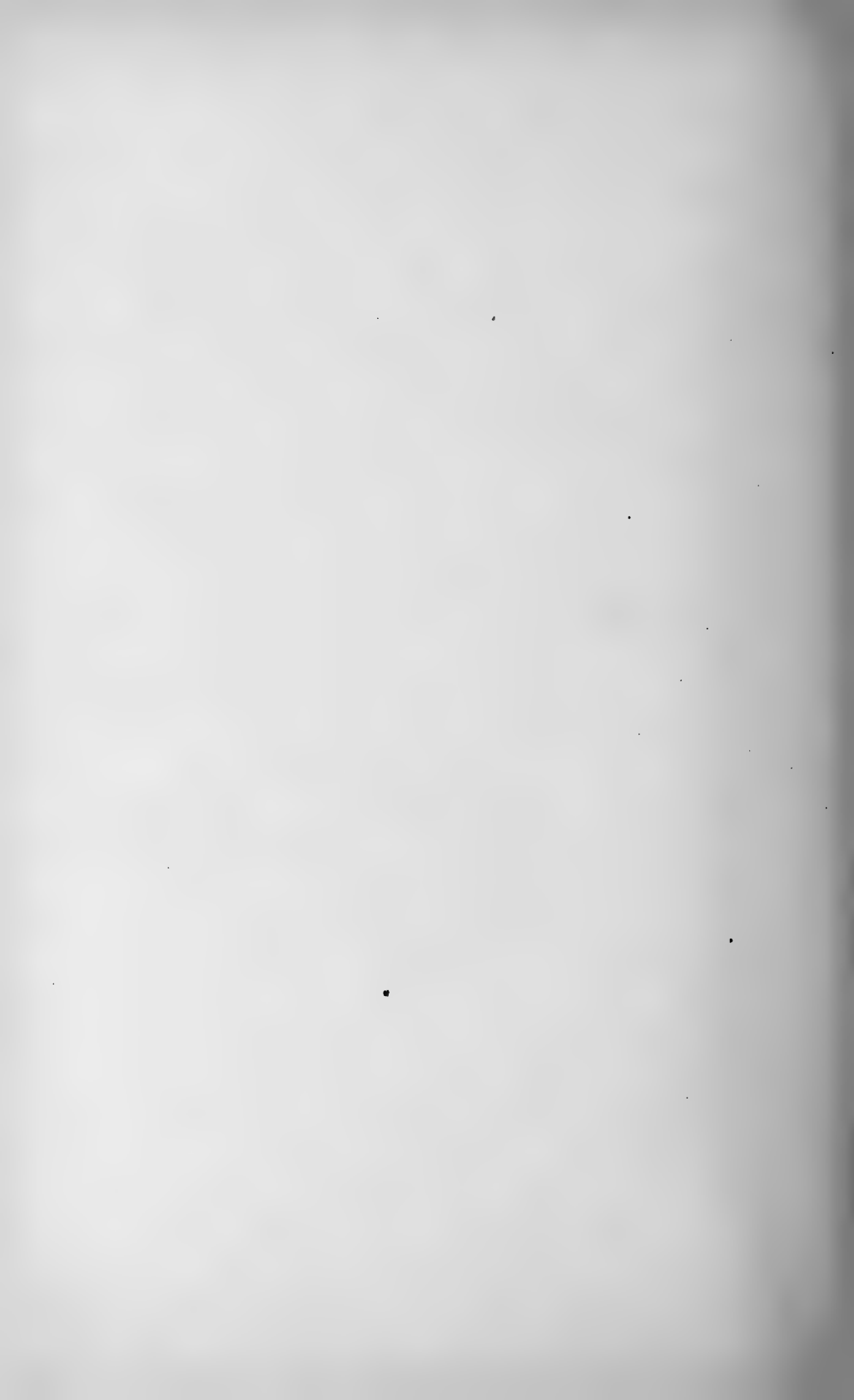

SMITHSONIAN MISCELLANEOUS COLLECTIONS

VOLUME 82, NUMBER 18

(End of Volume)

TROPISMS AND SENSE ORGANS OF
COLEOPTERA

(WITH TWO PLATES)

BY

N. E. McINDOO

Senior Entomologist, Deciduous-Fruit Insect Investigations,
Bureau of Entomology, U. S. Department of Agriculture



(PUBLICATION 3113)

CITY OF WASHINGTON

PUBLISHED BY THE SMITHSONIAN INSTITUTION

APRIL 18, 1931

SMITHSONIAN MISCELLANEOUS COLLECTIONS
VOLUME 82, NUMBER 18
(End of Volume)

TROPISMS AND SENSE ORGANS OF COLEOPTERA

(WITH TWO PLATES)

BY

N. E. McINDOO

Senior Entomologist, Deciduous-Fruit Insect Investigations,
Bureau of Entomology, U. S. Department of Agriculture



(PUBLICATION 3113)

CITY OF WASHINGTON
PUBLISHED BY THE SMITHSONIAN INSTITUTION
APRIL 18, 1931

The Lord Baltimore Press
BALTIMORE, MD., U. S. A.

TROPISMS AND SENSE ORGANS OF COLEOPTERA

By N. E. McINDOO

SENIOR ENTOMOLOGIST, DECIDUOUS-FRUIT INSECT INVESTIGATIONS, BUREAU OF
ENTOMOLOGY, U. S. DEPARTMENT OF AGRICULTURE

CONTENTS

	PAGE
Introduction	2
A. Tropisms	3
I. Phototaxis, geotaxis, and thigmotaxis.....	3
1. Review of literature.....	3
(a) General remarks	3
(b) Light traps for beetles.....	5
2. Original work on Mexican bean beetle.....	7
(a) Responses of larvae and adults to daylight.....	7
(b) Description of dark-room and apparatus.....	8
(c) Responses of adult beetles and their larvae in dark-room....	11
II. Chemotaxis	15
1. Review of literature.....	15
(a) Baits for wireworms and tenebrionids.....	15
(b) Baits for strawberry-root weevils.....	17
(c) Baits for the Japanese beetle.....	18
(d) Baits for other beetles.....	24
(e) Repellents used against beetles.....	26
2. Original work on Mexican bean beetle.....	30
(a) Search for attractants and repellents, using an olfactometer.	30
(b) Search for attractants and repellents, using feeding method.	31
(c) Search for attractants and repellents, using an improved feeding method	32
(1) Beetles can distinguish differences between water and salty liquids	34
(2) Beetles can distinguish differences between water and sour liquids	36
(3) Beetles can distinguish differences between water and bitter liquids	36
(4) Beetles can distinguish differences between water and sweet liquids	37
(5) Bean foliage sprayed with sweetened arsenicals is more attractive than unsprayed foliage.....	39
(6) Bean foliage sprayed with arsenicals is repellent.....	39
(7) Bean foliage sprayed with sweetened magnesium arse- nate is more attractive than foliage sprayed with non- sweetened magnesium arsenate	40

	PAGE
(8) Water extract and steam distillate of bean leaves tested.	41
(9) Chemotaxis more important than phototaxis in the finding of food.....	42
(10) Repellents would probably not protect beans.....	42
III. Thermotaxis	43
1. Review of literature.....	43
B. Sensory receptors	43
I. Photoreceptors	44
II. Chemoreceptors	44
1. So-called olfactory organs.....	44
(a) Antennal organs	44
(b) Olfactory pores	45
2. So-called taste organs.....	54
III. Audireceptors	56
1. Johnston organs	56
2. Chordotonal organs	56
IV. Thigmoreceptors	57
1. Tactile hairs	57
C. Scent-producing organs and reflex "bleeding".....	58
Summary	61
Literature cited	64

INTRODUCTION

This paper is a continuation of a series of studies dealing with the tropisms and sense organs of insects, suggested by Dr. A. L. Quaintance, Associate Chief of the Bureau of Entomology. It is written as a complement to the writer's former paper (47) entitled "Tropisms and Sense Organs of Lepidoptera," and contains practically no information found in the former one, although, of course, the information which deals with the Coleoptera alone, is of a similar nature.

In the paper on Lepidoptera the original work dealt mostly with the codling moth, but since this species was not a favorable insect on which to experiment in the laboratory, the original plan for conducting tests was much curtailed. In the present study the experimental work has been expanded and the Mexican bean beetle (*Epilachna corrupta* Muls.), which first appeared in Takoma Park and Sligo, Md., in 1927, was selected to represent the Coleoptera, owing to its abundance and great economic importance. When tested to odor stimuli alone it also was found to be an unfavorable insect; but when the adults were allowed to come in contact with the substances to be tested as foods, the beetles clearly demonstrated their likes and dislikes; and when tested to light and gravity in a dark-room, the adults proved to be almost ideal for this purpose.

In order to obtain comparative results which could be treated statistically, new technique and apparatus were devised, and the more important experiments were repeated over and over under controlled conditions.

A. TROPISMS

The tropisms of Coleoptera will be discussed first and then the sense receptors.

I. PHOTOTAXIS, GEOTAXIS, AND THIGMOTAXIS

I. REVIEW OF LITERATURE

Information concerning the phototaxis, geotaxis, and thigmotaxis of beetles is limited. Publications pertaining to light traps are numerous, but papers concerning the geotaxis, thigmotaxis, and other phases of phototaxis are scarce. In regard to the reactions of beetles to wave length and intensity of light, the field is practically unexplored.

(A) GENERAL REMARKS

Loeb (37, p. 20) remarked that an imago animal may respond to light in one way, its larva in a different way. For example, an adult June beetle moves toward light and is called photopositive, whereas its larva moves away from light and is thus photonegative. He further said (p. 70-73) that mealworms (larvae of *Tenebrio molitor*) are photonegative and behave under red glass as they do in the dark; but under blue glass, just as they do in the light. They adhere closely to objects, being positively stereotropic or thigmopositive. They flee from moisture and seek dry spots. He believed that positive thigmotaxis (stereotropism) and negative phototaxis determine the habits of these insects, which live in flour, protected from the light. The behavior of cockchafer (*Melolontha vulgaris*) under red and blue glass is similar to that of mealworms. Loeb believed that negative phototaxis may cooperate, but that thigmotaxis is doubtless the chief factor concerned in causing the larvae of cockchafers to burrow in the ground. The same writer (p. 85-86) put coccinellid beetles in a wooden box which was then placed in a dark closet. After repeated tests these lady-beetles were always found at the top of the box, proving that they were geonegative.

Weiss (94) placed three species of lady-beetles at the base of a 15-foot pole, which they soon climbed. He believes that this behavior demonstrates negative geotaxis.

Wodsdalek (97) has demonstrated that the phototactic responses of certain dermestids vary at different life-history periods. The larvae of *Trogoderma tarsale* immediately after hatching are photonegative. Negative phototaxis persists throughout the larval period, and even for a short time after the adults mate. Soon after ovipositing, the females become gradually indifferent to light and later become photopositive.

Breitenbecher (7) experimented with potato beetles, under dry and moist conditions, to ascertain what their tropic responses would be in a desert. When the beetles were confined in a moist medium, they were found to be photopositive and geonegative; but when desiccation resulted in a dry medium, they were photonegative and geopositive.

Runner (69, p. 25) tested tobacco beetles with color screens or ray filters which transmitted practically monochromatic light rays. He remarks that these beetles, in common with other insects, reacted most strongly to colors of shortest wave length. The movement toward blue or blue-violet was most pronounced, and the movement toward red least of all. These beetles, like other insects reacting negatively toward intense sunlight, were only slightly sensitive to light at the lower end of the spectrum, and rays of longer wave length, limited to red and orange, seemed to act on them in much the same manner as darkness. Beetles exposed to bright sunshine under color screens of red and blue were observed to collect under the red screen almost as readily as they did when an opaque screen was used instead of the red, although the apparent intensity of light under the two screens was the same.

Smith (75) remarks that the larvae of the Japanese beetle are thigmopositive to living roots, and if these are not available, they adhere to stones, sticks, or the bottom and sides of the breeding cage. The adult beetles apparently can see colors, particularly green. This is taken advantage of by painting the bait traps green and by using green lead arsenate (78).

Moore and Cole (56) report that Japanese beetles collect in great numbers at the tops of trees, bushes, and weeds. This is caused by two tropic responses—positive phototaxis and negative geotaxis, which determine the head-tail orientation of the body. In the field and laboratory certain degrees of heat and light are necessary to cause active movements. These writers further say that since a geotactic response is shown by the beetles only when they are illuminated, it therefore follows that their movement in a lighted field is the result of three factors—negative geotaxis, photokinesis, and positive phototaxis. The first is constant, while the other two factors are functions of the

intensity of the illumination. Moore and Cole conducted many tests by confining Japanese beetles in a specially constructed wire-screen cage. Five light intensities were used in securing the reaction time of the beetles. The results obtained are presented in tables and graphically. Their summary is about as follows. Light and temperature above 23° C. are necessary to cause activity in the Japanese beetle. The effect of light as indicated by the rate of locomotor responses was related to light intensity according to Fechner's expression of Weber's law.

Richmond (67) devised an apparatus to determine the value of color and intensity of light. Over 100 tests were conducted, using Japanese beetles, but no definite conclusions were drawn from the results obtained.

Crozier (12) states that when creeping mealworms are tested to light rays, a definite intensity of white light (about 136 m. c.) is required to produce negative orientation away from contact with a vertical glass surface. This gives a measure of stereotaxis in terms of phototaxis, or vice versa. The effectiveness of light for the suppression of stereotaxis varies with the wave length. By determining the minimum energy required to inhibit stereotaxis with the different regions of the spectrum, it was found that the maximum effectiveness was sharply localized in the neighborhood of 535 millimicrons. The same author (11) conducted other experiments to show that mealworms, while creeping, exhibit homostrophic responses and stereotropic orientation to lateral contacts. Crozier finally concludes that stereotropism is truly a tropic character.

(B) LIGHT TRAPS FOR BEETLES

Artificial light as a control measure was probably first used in 1787 for attracting vine moths in Europe. Since that date light traps have been gradually developed and improved until today there are many types and varieties of gasoline, kerosene, acetylene, and electric lamps used for this purpose. Most of these have been devised primarily for catching Lepidoptera, but many beetles also are caught in them, and other traps are designed primarily for Coleoptera. It seems that none, however, has given complete satisfaction as a control measure.

Since 1914 Jarvis and his co-workers (28, 33, 35) have been devising light traps to catch sugarcane beetles in Queensland, Australia. Their object has been to develop a trap so simple that it might come into general use in sugarcane-growing regions. A very successful trap has finally been developed. It consists of a large pan about a yard square, with sides about 4 inches high, and of an ordinary acetylene

lamp. In Cuba, Barreto (5) reports that light traps are an effective means of dealing with other species of sugarcane beetles.

For many years light traps have been used for catching May beetles (*Lachnosterna*), but it is still doubtful whether this method, as a control measure, is really worthwhile. Sanders and Fracker (70) in Wisconsin used gasoline lantern traps to collect May beetles. Results were obtained concerning the distribution of species over a comparatively limited area, the optimum temperature for flights, and the most favorable location and arrangement of the light traps. Seventeen out of the 19 species known to occur in Wisconsin were caught in the traps. Van Zwaluwenburg (91) reports that in Porto Rico large numbers of May beetles were caught by means of a 400-candlepower gasoline lamp, and that the use of light traps should constitute a valuable means of control. Harned (22) reports that, in pecan orchards in Mississippi, where trapping May beetles at night by lanterns placed over tubs of oil and water has been practiced for many years, their numbers have been considerably reduced, and they appear to have caused less damage there than in previous years.

Runner (69, p. 49-51) reports that the tobacco beetle may be attracted to light traps in tobacco factories or warehouses and large numbers of them destroyed. An efficient trap can be made quickly and easily by pinning sheets of sticky fly paper around an electric light. Other types of light traps are discussed. One consists of a large globe connected with a cyanide jar; another, of a light and a shallow pan of oil; another, of a suction fan and a light; and another method is to collect the beetles at windows. Some of the beetles caught were examined for the purpose of determining their sex; nearly two-thirds proved to be females.

Smith (77) reports that light traps, placed over large funnels, have proved effective against the adults of the Asiatic garden beetle (*Aserica castanea* Arrow). In one instance as many as 157,774 beetles were caught in one trap during a period of 30 days.

For several years Williams (96) has been developing and improving light traps for insects. At last he has perfected one which has been proved successful. The source of the light is acetylene or electricity, and the killing agent is carbon tetrachloride or potassium cyanide.

In New York State, Collins and Nixon (9) have just published a second report concerning an investigation conducted on a large scale, in which 105 water-pan electric-light traps were installed in an orchard. Most of the insects caught were Lepidoptera, but incidentally many beetles were trapped. The method recently employed by Hermes

(23) in California is also recommended to future investigators. He used large electric lights in an orchard to attract codling moths.

Gourdon (20) states that ultra-violet rays have been found to attract both diurnal and nocturnal insects. The rays appear to produce in the insects a sensation which is at first agreeable, but which soon becomes dangerous, if not fatal; in certain cases they are immediately blinded. A trap for use in vineyards, orchards, or fields is described, to which insects are attracted by means of ultra-violet rays, and are either drawn by the suction of an electric fan into a metal basket or fall blinded outside the trap, where they become an easy prey to birds.

Many more references on light traps are cited in "The Review of Applied Entomology, Series A," but perhaps enough has been said to convince the reader that this method of control is worth further investigation.

2. ORIGINAL WORK ON MEXICAN BEAN BEETLE

(A) RESPONSES OF LARVAE AND ADULTS TO DAYLIGHT

When the sun is shining brightly on warm days, larvae and adult bean beetles are rarely seen exposed to the direct sunshine in bean patches. During cloudy days and early in the morning many may be seen on the upper surface of the leaves, but most of them at all times live and feed on the under surface.

When brought into the laboratory most of them move toward the windows, being photopositive, while occasionally one moves away from the light, thus being photonegative. When tested in a phototactic box, 18 inches long, 12 inches wide, 12 inches high, and lined with a dead-black cloth (fig. 1), their responses were similar to those of codling-moth larvae, recently described by the writer (47, pp. 12-13). This box lay on a table by a south window in bright light, although not in direct sunshine. Dozens of insects were placed in it and the tracks of most of them were traced with a lead pencil. Larvae of the first and second instars were found to be weakly photopositive or indifferent to light. Many moved slowly, bending to the right and left, in any direction as if searching for food, while a few moved in circles toward the light (fig. 1, *a* and *b*).

Most of the larvae of the third instar were strongly photopositive (fig. 1, *c*), while the remainder were weakly photopositive or indifferent to light. The more active larvae of the fourth instar were usually strongly photopositive, but a few were indifferent. The less active ones were usually strongly photonegative (fig. 1, *d*). It was

later ascertained that most of the larvae, when about ready to pupate, became photonegative. These were sluggish in action, were deeper yellow in color, and their intestines usually were not visible through the integument as they are in the more active larvae.

Hundreds of adult bean beetles, including the overwintering ones, those of the second and third broods, and many ready to hibernate, were tested in one way or another. Practically all were found to be photopositive, most of them being strongly so (fig. 1, *e*). At no time were photonegative beetles observed. The nearest approach to this

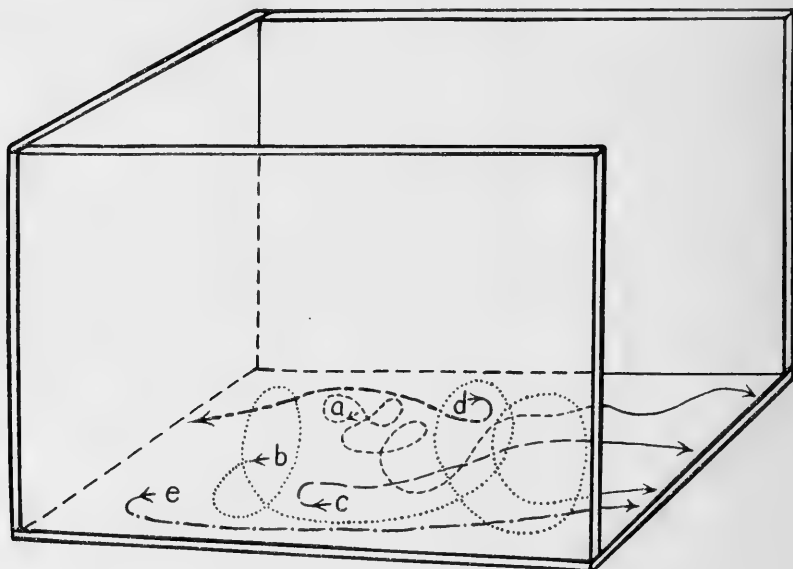

FIG. 1.—Diagram of phototactic box and tracings of tracks of Mexican bean beetle, illustrating responses to light of this insect. The tracings are as follows: *a*, larva just hatched; *b*, larva of second instar; *c*, larva of third instar; *d*, larva of fourth instar; and *e*, adult ready to hibernate.

condition was found among old ones of the second brood, but when repeatedly tested it was decided that they too were still photopositive.

(B) DESCRIPTION OF DARK-ROOM AND APPARATUS

Since it is often difficult to separate phototactic responses from geotactic ones, special apparatus is then necessary. Not having a dark-room whose temperature and relative humidity could be controlled, an attempt was made to construct one by using a room, 10 feet long, 9 feet wide, and 9 feet high. It was made totally dark as follows: Boards were nailed to the wooden shutters which closed

snugly, and then a dark green window shade (fig. 2, A) was pulled to the bottom of the window. The door (B) was made light-proof by fastening strips of black cloth around all its edges, and its transom

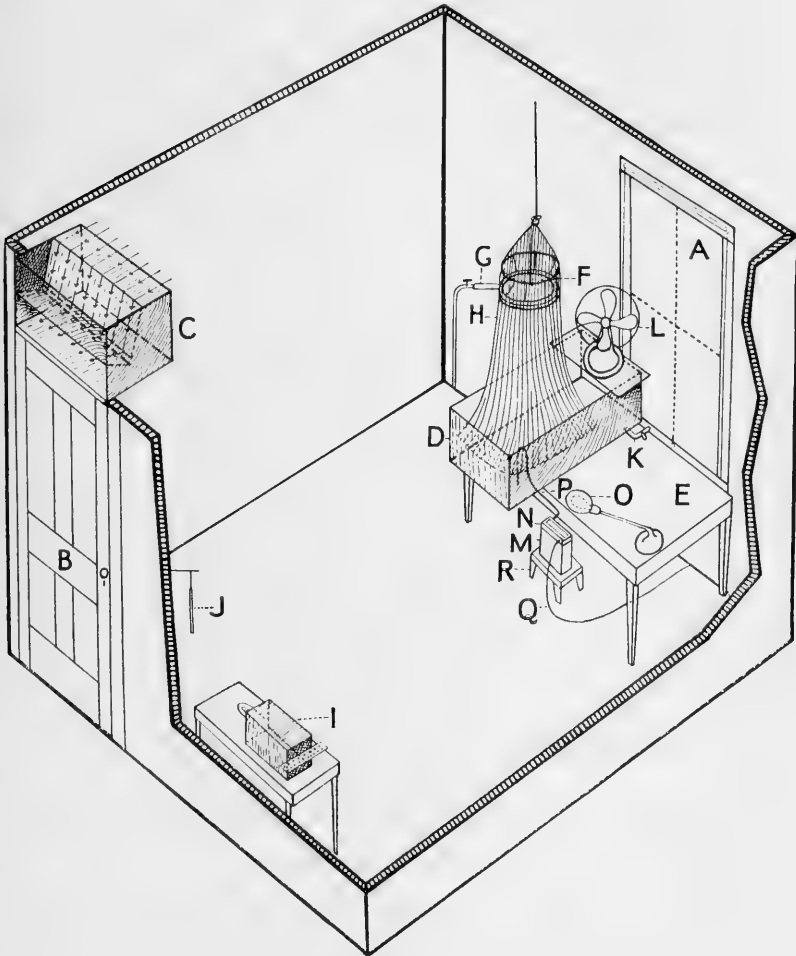

FIG. 2.—Diagram of a constant temperature and humidity dark-room, showing parts of room and apparatus used in testing photo-geotactic responses of Mexican bean beetle. The parts and apparatus are as follows: A, window shade; B, door; C, ventilator; D, box; E, table; F, lawn sprayer; G, garden hose; H, bath towels; I, hygrothermograph; J, thermometer; K, outlet water pipe; L, electric fan; M, photo-geotactic box; N, water screen; O, electric lamp; P, siphon running to water screen; Q, siphon running from water screen; and R, stool.

was changed into a ventilator (C) through which air passed freely, but no light. The temperature and humidity were partially controlled by the following means. A box (D), 40 inches long, 24 inches wide,

and 12 inches high, lay on a table (*E*) by the window at the south end of the room. A wire frame-work, supporting a circular lawn sprayer (*F*), was suspended from the ceiling directly over the box; and a garden hose (*G*), running to a water spigot, was connected with the sprayer. Two large bath towels (*H*), put around the frame-work above the sprayer reached half-way to the bottom of the box, which was kept two-thirds full of water. A hygrothermograph (*I*) lay on another table at the north side of the room, and near this table there was a centigrade thermometer (*J*) the scale of which was marked in fifths of degrees. Before starting an experiment in this dark-room, water was turned on at the spigot, passed upward and outward from the spray, struck the bath towels, ran down them into the box, and finally passed through a pipe (*K*) to the outside of the room. In order to have good ventilation and a more humid atmosphere, air from an electric fan (*L*) was directed against the wet towels and water in the box. If the temperature and relative humidity could not have been satisfactorily controlled for the tests planned, the original idea was to use ice and water in the box for cooling the air, and a stove for heating it. Since small variations in temperature and relative humidity did not seem to affect the responses of the bean beetle, the ice and stove were not used.

Experience showed that the temperature and relative humidity inside the dark-room were influenced only slightly by outside climatic conditions. During the forenoons the temperature was often held nearly constant, and never varied more than two degrees centigrade, but during the afternoons the variation was usually larger. Table 1 shows that the greatest variation of temperature, between 9:00 o'clock a. m. and 4:30 o'clock p. m., was 4.2° C. and the smallest variation was 1.8° C. When the outside relative humidity was exceedingly high, water was not run through the sprayer, because it made the inside humidity too high.

The testing apparatus consisted of a tall box (fig. 2, *M* and fig. 3), a shallow water screen (*N*), and a lamp (*O*). The inside dimensions of the box (fig. 3, *A*), called a photo-geotactic box, were 12 inches by 5.5 inches by 1.75 inches. It had two sets of shutters, one of glass (*a*) and the other of wood (*b*), which fitted snugly in slots. The four sides inside the box were covered with a dead-black cloth, while one of the glass shutters was covered with cheesecloth. The inside of the box was marked with white lines into ten equal sections, numbers 1 to 10. When all four shutters were in place it was almost totally dark in the box.

The inside dimensions of the water screen (fig. 3, B) were 6 inches by 2 inches by 0.25 inch. The two pieces of glass (*c*) were held securely one-fourth inch apart by a strong wooden frame (*d*). The running water passed through a siphon (fig. 2, *P*) and a glass tube (fig. 3, B, *e*), having a bore of one-eighth inch, into one end of the water screen and out again at the other end through another tube and siphon (fig. 2, *Q*, fig. 3, B, *f*).

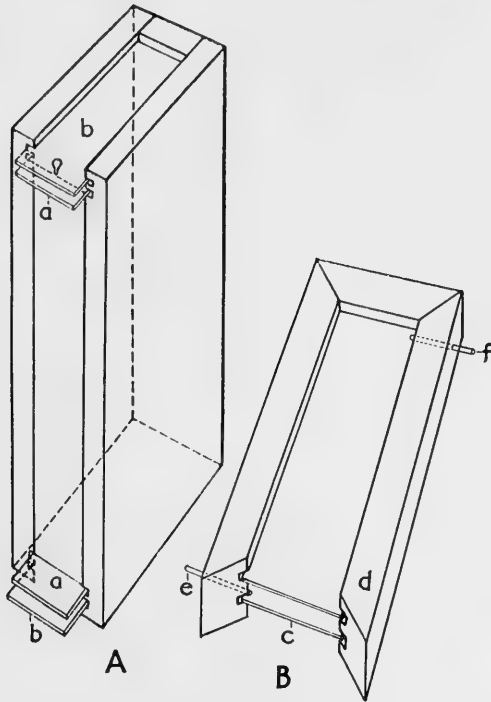

FIG. 3.—Diagrams of photo-geotactic box (A) and water screen (B), showing following parts of them: *a*, glass shutter; *b*, wooden shutter; *c*, piece of glass; *d*, wooden frame; *e*, inlet glass tube; and *f*, outlet glass tube.

The lamp (fig. 2, *O*), consisting of a blue daylight bulb 100 W, 110 V, rested on the table (*E*), or on a box, while the photo-geotactic box and water screen lay on a stool (*R*).

(C) RESPONSES OF ADULT BEETLES AND THEIR LARVAE IN DARK-ROOM

Since the writer was not able quickly and accurately to separate the live bean beetles according to sex, sex was disregarded in all the tests conducted. The beetles, otherwise, were selected so that those in each set were of practically the same age and responded to daylight readily.

After the temperature and relative humidity in the dark-room had become nearly constant, both shutters at the bottom of the photo-geotactic box were inserted and 25 adult beetles were then put in the box on the cloth-covered glass shutter, after which the glass shutter at the top of the box was inserted, and finally the testing apparatus was assembled as shown in figures 2 and 3. The blue electric light bulb was then placed 10 inches directly above the water screen, which prevented the infra-red or heat rays from the light from reaching the insects. After a period of 15 minutes the wooden shutter was removed and the box was gently raised and turned toward the light so that the observer could see through it from end to end. The position of the beetles in the ten sections was then quickly noted and recorded in a table.

In test number 2 the beetles were again put in the bottom of the box on the cloth-covered shutter, but this time the box was gently turned upside-down and rested on the water screen, 10 inches below which was the light. In this case the beetles clung to the cloth and did not fall when turned upside-down. During the same forenoon tests number 1 and 2 were repeated alternately three times, and finally the results obtained in the two sets, each consisting of four tests, were treated statistically and recorded in table 1.

To secure a frequency distribution the responses were given values ranging from 1 to 10, corresponding to sections 1 to 10 in which the 25 insects were counted at the end of a test. If all 25 insects remained in section 1, the total value would be 25, or 1 as an average; and if all moved to section 10, the total value would be 250, or 10 as an average; but neither one of these extremes was actually observed, because the insects were always counted in two or more sections. To secure the arithmetic mean, which in each test lay somewhere between 1 and 10, the total value was divided by 25, and since each set of experiments consisted of four tests the frequency curve was represented by only four means. Owing to the small number of statistical items, Bessel's formula

$$\left(P. E. m = \pm 0.6745 \sqrt{\frac{\sum d^2}{n(n-1)}} \right)$$

was used to calculate the probable errors.

The values were accurate for those insects counted in sections 2 to 10, but not so for those counted in section 1, because they may have responded little or none, although most of them had left the cloth-covered shutter on which they were put. Consequently, the mean positions given in table 1 under the headings "up" and "down"

TABLE I.—*Tests to determine differences between phototactic and geotactic responses of Mexican bean beetle, with and without use of light*

Stage of insects tested	Phototactic and geotactic responses combined (100 watt light used)			Geotactic responses alone (No light used)			Num-ber of tests	No. of set	Tempera-ture C.	Relative humidity	Date
	Mean position of insects forced		Difference	Mean position of insects forced		Difference					
	Up	Down		Up	Down						
Over-wintering beetles...	8.21 ± 0.041	5.81 ± 0.113	2.40 ± 0.120	8.05 ± 0.156	2.78 ± 0.083	5.27 ± 0.177	4	4	26.4-29.0	89-93	June 17
	7.75 ± 0.224	4.92 ± 0.337	2.83 ± 0.405	7.49 ± 0.309	2.01 ± 0.113	5.48 ± 0.329	4	5	26.0-29.2	90-93	June 20
	9.42 ± 0.065	6.98 ± 0.176	2.44 ± 0.188	7.98 ± 0.062	2.35 ± 0.108	5.63 ± 0.124	4	6	26.0-30.2	92-95	June 21
General average of above.	8.46 ± 0.072	5.90 ± 0.120	2.56 ± 0.140	7.84 ± 0.106	2.38 ± 0.055	5.46 ± 0.119	12	5			
Old beetles of 2nd brood...	7.41 ± 0.188	6.48 ± 0.029	.93 ± 0.190	6.31 ± 0.688	2.25 ± 0.173	4.06 ± 0.709	4	15	24.5-26.6	93-96	Aug. 19
Larvae of third instar....	2.24 ± 0.087	2.14 ± 0.059	.10 ± 0.105	2.28 ± 0.118	1.41 ± 0.098	.87 ± 0.153	4	4	24.0-25.8	86-88	June 26
Larvae of fourth instar..	9.05 ± 0.177	6.42 ± 0.192	2.63 ± 0.261	2.25 ± 0.149	1.47 ± 0.151	.78 ± 0.212	4	5	23.0-27.0	84-87	June 27

are slightly too high for those insects which did not respond readily; but the figures given under the heading "difference" are practically the same as those when all the insects counted in section I were eliminated.

Usually during the afternoon similar tests were conducted four times, using the same beetles, but no light was used. In this case, without the use of light, the geonegative response was 5.27 ± 0.177 more than the geopositive one, while with the use of light it was only 2.40 ± 0.120 more (table I), 10.00 being equal to a 100 per cent response.

On later dates the preceding tests were again repeated, using two other sets of overwintering beetles. The general average and probable errors of the three series were therefore obtained by using the 12 means and the mean of them. Thus, for active, overwintering beetles the geonegative response, when light was used, was 2.56 ± 0.140 more than the geopositive one; but when no light was used, it was 5.46 ± 0.119 more, indicating that when the beetles were forced downward by the light this stimulus overcame about one-half of the geotactic one. In two of these series of tests the light was used during the forenoon, but in the third series during the afternoon. The sequence in which these insects were tested, therefore, had little or no effect on the results obtained.

The preceding tests were repeated by using one set of old beetles of the second brood. These insects were not so active as they were when younger and did not respond so readily to light and gravity as did the more active overwintering beetles. Their lower responses were due mostly to the fact that the insects soon became tired of being forced to respond.

Two sets of larvae were likewise tested in the photo-geotactic box and were found to be photopositive and geonegative (table I). Compared to the adults they were sluggish and three times in four did not respond as readily to light and gravity. Larvae of the third instar reacted weakly to light and gravity, while the larvae of the fourth instar responded strongly to light but weakly to gravity.

The reader has doubtless noted that the writer has designed his experiments and discussed his results from the point of view that rate of movement is a measure of tropic response. After an animal is oriented, some writers claim that the rate of its movement toward or away from the source of excitation is not a measure of its tropic response. If a tropic response includes nothing more than the mere act of orienting, the preceding results then have little to do with the subject of tropisms. The writer in various publications has dis-

cussed the subject of tropisms from a broad point of view, and has not yet accepted any definition nor does he know exactly what a tropic response includes, but he believes that it includes more than orienting in a certain direction.

In conclusion, bean beetles and their larvae are usually found on the upper portions of their host plants, because they are photopositive and geonegative; but since direct sunshine in warm weather is harmful to them, they are usually found on the lower surface of the leaves.

II. CHEMOTAXIS

I. REVIEW OF LITERATURE

Most of the information regarding chemotaxis found in the widely scattered literature pertains to the subject of baits. Scores of references have been consulted, but only the more important ones will be cited.

(A) BAITS FOR WIREWORMS AND TENEBRIONIDS

It is not known when the practice of using baits for beetles was first begun, although this is an old control method. The Japanese growers, according to Treherne (85), were probably the first ones to use baits for catching wireworms, the larvae of elaterid beetles. After roasting dry rice shorts or rice bran, the Japanese then moistened the roasted material with water and made it into small balls, which had a strong odor said to be attractive to wireworms. The Japanese claimed that a single ball would catch 100 or more wireworms, but when this method was tested by Treherne a single bait buried in heavily infested soil never yielded more than 90 larvae.

Treherne (86) also tells about the old-fashioned way of attracting wireworms, which is still recommended as one of the few control measures. Pieces of cut potatoes, to which white wires have been attached, are buried in the infested soil. Upon visiting the infested area the potatoes are pulled from the ground by means of the wires, the wireworms are removed and destroyed, and then the potatoes are buried again. In Canada attractive baits, consisting of potatoes, balls of dough, shorts, meal, or rice bran, are set in the soil. The addition of molasses or other attractant ("attractant") in these bran baits does not improve their attractiveness, nor has the inclusion of arsenicals been of any practical value.

Weldon (95) reports that small pieces of potatoes were planted between rows of beans in California. This bean crop was saved, while 30 acres of beans nearby, not thus protected, were entirely destroyed.

Borodin (6) reports that in Russia the best remedies for wireworms are various baits, consisting of sliced potatoes, carrots, beets, oil cakes, cabbage stalks, etc., buried 3 or 4 inches in the soil. Those poisoned with Paris green or arsenic need no further attention. The unpoisoned ones must be inspected weekly. Poisoned maize baits are also recommended.

French (15) says that in Australia poisoned baits consisting of cut-up turnips, carrots, etc., soaked in lead arsenate, have given good results.

Lovett (38) states that in Oregon poisoned-bran mash may be placed under stones or boards in the fields as a control measure for wireworms.

Masaitis (39) reports that in Siberia baits of horse dung, poisoned with sodium arsenite, appeared to be considerably more effective than those of poisoned linseed or hempseed cake.

More recently special attractants have been given serious attention. Comparative tests, conducted in Washington State by Spuler (83), in which rice flour, graham flour, graham flour and sugar, bran, graham flour and oranges, graham flour and lemons, potatoes, carrot roots, carrot tops, and apples were used as baits gave a descending order of attractiveness as listed. Other tests, in which baits consisting of germinating Alaska peas, beans, corn, graham flour, and potatoes were used, indicated that the seeds and flour were about equal in attractiveness, but that the potatoes were far inferior. For practical control work use baits, particularly germinating seeds, to allure the wireworms to definite spots, and then the worms may be easily killed with a soil fumigant, such as calcium cyanide. When the worms have gathered around the bait, spaced about four feet apart, to partake of the feast prepared for them, all that remains to be done is to bury a little of this granular fumigant near the bait. Shortly the deadly fumes send the banqueters to their happy hunting ground and all is ended.

Federal entomologists (1) at Clarksville, Tenn., have recently made an interesting discovery in connection with poisoned-bran bait fed to tobacco wireworms, which have hitherto stubbornly resisted all efforts at direct control. These worms were easily attracted to bait flavored with ordinary nitrobenzene. In five series of large-scale experiments in tobacco fields these worms were reduced from 50 to 60 per cent by the use of this chemical as a bait flavoring. Other entomologists (2) at the Florida experiment station remark that a flavoring of nitrobenzene added to poisoned-bran bait is very attractive to a variety and large range of insects, and they found it quite

attractive to the celery leaf-tier. If it is attractive to such diverse insects as wireworms and caterpillars it is quite possible that it will be found of value against a large number of insects.

Melander (50) states that a dough made of flour or bran proved very attractive to wireworms, but the addition of sugar, oranges, lemons, etc., added little to the drawing power of the baits.

Since the larvae of certain tenebrionid beetles are destructive, why not attack the evil at the source by destroying their parents? This was the way Wakeland in Idaho reasoned during the season of 1921. After discovering that these beetles feed greedily for a month before egg-laying time, he next found out that they could be easily killed during this period by feeding them poisoned-bran bait, thus largely eliminating them before they had a chance to start a new generation. The following season he (93) continued his experiments and states that the bait used consisted of bran, Paris green, amyl acetate, and water. It was distributed broadcast or in the bottom of furrows, plowed at regular intervals, over an area of 18,000 acres. This method is said to be practical and economical, because the beetles were effectively killed at a cost of about two and a half cents per acre for materials, and the labor involved was not a large item.

In 1920 Jack (29) in Rhodesia poisoned the adults of certain tenebrionids by using the bait recommended against cutworms.

Swenk (84) remarks that a promising remedy against the adults of *Eleodes opaca* is a bait prepared by mixing, dry, 25 pounds of coarse wheat bran and 1 pound of Paris green, to which is added $\frac{3}{4}$ ounces of amyl acetate in enough water to make a stiff mash. This quantity is sufficient for several acres when put in furrows.

Other species of tenebrionids in the United States (8), Russia (73), and Rhodesia (30) are more or less controlled by poisoned baits. In Southern Rhodesia several formulas have been used (31) successfully against so-called wireworms (tenebrionids). One of them is made of chopped green stuff, dipped in a solution consisting of 1 pound of sodium arsenite, 8 pounds of cheap sugar or 1 gallon of molasses, and 10 gallons of water. This bait may be broadcast or applied like bran bait.

(B) BAITS FOR STRAWBERRY-ROOT WEEVILS

During the past 25 years strawberry growing in the western parts of Washington, Oregon, and British Columbia has been handicapped by strawberry-root weevils. For 20 years or more many efforts have been made to develop a remedy for this serious pest, but not until recently has a satisfactory control measure been discovered. An

attractive poisoned bait was developed by M. J. Forsell of Seattle, Washington, who, at the suggestion of the present writer, attacked the problem through the weevil's sense of smell. In the preliminary experiments dried ground apples were found to be the most attractive substance tested, and magnesium arsenate was the most satisfactory poison. It is further claimed that the discovery and perfection of this bait marks an important horticultural step in the fruit industry of the State of Washington, as these weevils had become so serious in many places that the strawberry-growing industry seemed doomed.

Melander and Spuler (51) report their results concerning the poison-bait remedy for the strawberry-root weevils in Washington. They say that these destructive weevils can be satisfactorily, economically, and practically controlled by the distribution of a poisoned bait immediately at the close of the berry harvest. This bait consists of sun or oven dried sliced apples, ground into pulp or granules, to which an arsenical is added, magnesium arsenate being the most satisfactory. The bait is broadcast over the strawberry plants at the rate of about 70 pounds per acre.

Mote and Wilcox (57) tell about the bait method used in Oregon. They remark that a homemade bait consisting of 95 pounds of ground dried apple waste, mixed with 5 pounds of calcium arsenate, kills the strawberry-root weevils. A commercial bait is also reported to be efficient.

Downes (13) further experimented with baits for strawberry-root weevils. He states that apple waste containing about 20 per cent of moisture was found more attractive than super-dried bait, and that sodium fluosilicate was the most suitable poison to use with apples containing that percentage of moisture. Two applications of the bait are recommended, the first in April and the second in June.

(c) BAITS FOR THE JAPANESE BEETLE

A study of the chemotaxis of the Japanese beetle was begun in 1922 at the Japanese Beetle Laboratory in New Jersey, and since that date several persons have worked on it, but some of them have never received credit in the published papers on this subject. This is particularly true of F. J. Brinley, who did the work in 1923 and discovered that geraniol was the most important attractant used. Richmond and the present writer continued the work in 1924, the former doing the field-work and the latter the laboratory work. Some of Richmond's results have been published, but since those of the writer were only preliminary they still remain unpublished.

The first authentic report on this subject is by Smith (76), who states that in chemotactic studies it has been found that Japanese beetles are strongly attracted by geraniol, and nearly 50,000 beetles in 1924 were collected from baits containing this substance. Bait mixtures, containing bran, molasses, and geraniol retain the odor for a long time if protected from the rain. Eugenol, citral, and citronellol as attractants, and tar oil as a repellent, appear to have some value.

Richmond (66) gives a detailed report on this subject and tells about the earliest experiments conducted. Since the beetles were known to have favored food plants and were strongly attracted to ripening fruit, various chemicals were tested in 1922 to ascertain if the fruit odors might be imitated. To determine whether beetles could be attracted to the sources of odors, a number of essential oils were sprayed on foliage. The results indicated that the oils of sassafras, hemlock, mustard, and lemon, and iso-amyl valerate were somewhat attractive. More detailed experiments were conducted in 1923 and a large number of compounds were studied. Bran-bait mixtures, put in cans which hung in trees, were used. Among the oils, sassafras and clove were easily the leaders, while ethyl alcohol, geraniol, and eugenol proved to be the most important constituents. In 1924 greater detailed studies were undertaken. The adult beetle was found exceedingly susceptible to the influence of color, odor, temperature, humidity, and light. The six leading chemicals tested are geraniol, eugenol, citronellal, citral, citronellol, and diphenyl ether. Geraniol proved to be far superior to the other five. In other experiments emulsions were tested. When cloths (1 foot square) were dipped in a 10 per cent emulsion of geraniol and suspended in orchards (pl. 1, A), beetles were drawn as if by a magnet and 13,000 beetles were collected on 12 cloths over a period of 5 successive days. In 1925 and 1926 this project was much expanded so that it included the testing of various types of bait cans and bait traps. The best type of trap devised was cylindrical in shape. A single one of these caught over 13,000 beetles in 8 hours. Richmond's summary follows:

Geraniol is clearly the primary attractant of the Japanese beetle but its combination with eugenol materially lowers the cost and increases its effectiveness. During the summer of 1924 over 65,000 beetles were actually collected from the bait can experiments. Nearly 50,000 of these beetles were present on geraniol baits alone. The results of experimentation in 1925 and 1926 were in keeping with these remarks, but, inasmuch as more extensive tests were conducted, the number of beetles collected was proportionately greater. The activities of the adult varied with temperature, humidity and vapor pressure. Females are attracted approximately one-third more frequently than males when geraniol and most other chemicals are employed. Molasses has only a slight attractive

value. Satisfactory traps have been evolved and it seems possible that they will have considerable value in reducing the number of beetles in a given orchard. Bran retains odors over long periods if protected from the rain. Geraniol has been satisfactorily incorporated in poison sprays although its odor is not retained for a long enough period. To this end experiments on the absorption of this chemical on charcoal, clays, etc., are under way. The value of geraniol, when used in connection with a contact spray, has been demonstrated. Eugenol, citral, citronellol and citronellal follow geraniol as attractive agents.

It is further stated (3) that methods have been devised whereby geraniol may be used to concentrate the beetles in a relatively small area. It was found that by spraying less than an acre of orchard with geraniol, beetles could be drawn on the leeward side of the orchard for a distance of nearly one-half mile within the first 15 minutes after the spray had been applied. This makes it possible to destroy large numbers of beetles with a comparatively small quantity of a contact spray.

Van Leeuwen and others (87, 90) determined that acetic acid, an accumulation of beetles, geraniol, and fermented apple juice attract these beetles. It was discovered that the beetles would gorge themselves upon foliage sprayed with a mixture of lead arsenate and refined sugar, on trees to which they had been attracted by geraniol (pl. 1, B). More beetles fed on this foliage than on unsprayed leaves, and consequently the mortality was greater than ever before obtained. Smith (78) more recently reports that a combination of lead arsenate and refined cane-sugar sirup has been found useful as a spray on non-economic plants. The beetles are strongly attracted to it and eat it readily. He says that this preparation is probably one of the most effective lethal sprays yet devised for the Japanese beetle. Owing to its tendency to injure foliage it is not recommended for use on economic plants.

Metzger (52) and Richmond and Metzger (68) describe various types of traps, one being called the standard bait trap. Each kilogram of the standard bait contains 500 grams of bran, 455 grams (350 cc.) of molasses (refiners' sirup 75 per cent), 44 grams (40 cc.) of glycerine, and a quantity of an attractant. With geraniol as the attractant making 5 per cent of the prepared bait, the bran-glycerine-molasses mixture does not deteriorate to any marked degree when exposed to the weather, and its attractive odor has been retained more than three years in some traps. In practice, baits were renewed twice a month, 150 grams of the prepared bait being put in each trap. The best bait, however, was found to be a technical geraniol, 58.8 per cent pure, used in the proportion of 2.5 per cent with eugenol in the proportion of 0.25 per cent of the total material. The total number of

beetles caught in 39 traps in 1926 was about 2,000,000, one trap catching 13,476 in one day. These traps were used also in connection with ecological investigations, and to obtain data on the degree of infestation at different points in different years. Beetles are caught in the traps before any are observed in the immediate neighborhood. As a result of these investigations various types of traps have been put on the market by commercial firms. In the 1929 report on the Japanese beetle, Smith (78) has the following to say about geraniol and traps:

Several years ago chemotropic investigations revealed that geraniol, one of the higher alcohols, was extremely attractive to the Japanese beetle. Few, if any, other insects have been found to be attracted to any degree by this chemical and it is apparently a specific for this insect. In commerce it is commonly used as an ingredient in the cheaper perfumes. Geraniol has been utilized in several ways in the control of the beetle; these include combining it with poisoned baits, as a means of concentrating the beetles in a small area where they may be killed with contact sprays, or more often as a constituent of baits used in mechanical traps. The Japanese beetle traps have come into wide use by residents in the suburban area around Philadelphia. In conjunction with spraying, the traps are useful in capturing large numbers of beetles. During the summer of 1929, 500 traps were placed on a 15-acre estate in the heavily infested district near Roxborough, Pennsylvania. The record of collections in these traps during the period between July 9 and August 23 gives a total of 1,874½ pounds of adult beetles and represents approximately 10,000,000 individuals. Many types of beetle traps are now on the market, ranging in price from 10 cents upward. The traps have not yet become sufficiently effective to warrant their use on farms. In fact, the presence of large numbers of traps may attract many beetles which are not captured, with the result that the grub population in the soil, in the vicinity of the traps, is greatly increased over what it would have been had the traps not been used.

During the past few years traps have come into general use for catching large numbers of Japanese beetles, but for various reasons a large percentage of the insects attracted to the traps are not caught; therefore, Mehrhof and Van Leeuwen (49) devised and perfected an electric trap (pl. 2) which not only attracts the beetles but kills practically all of them that come to it. This trap, in the form of a hollow cube, is 3 feet on each side, with parallel wires, $\frac{5}{8}$ inch apart, on all four sides and on the top. The most effective bait was geraniol emulsion, sprayed on peach foliage which was suspended in the center of the trap. By this method beetles were at times attracted from a distance of one-fourth mile.

Siegler and Brown in 1927 (74) first published on the idea that attractive baits might be used advantageously in scouting for injurious insects. During the season of 1929 the Federal Plant Quar-

tine and Control Administration made practical use of this idea by installing bait traps along the edges of the Japanese-beetle infested zones. So far little has been published on this particular phase of the work. According to the report of Secretary of Agriculture Hyde (27) the use of beetle traps at Baltimore and Washington, and in Alexandria County, Virginia, has resulted in the collection of great numbers of beetles. The possibility of substantial control at such isolated points by this method will thus be given. It has already been demonstrated that enormous quantities of beetles can be collected by trapping. In fact, on a single property in Pennsylvania (not New Jersey as reported) nearly a ton of beetles were thus collected in 1929. In the heavily infested areas, such trapping is of little value unless the employment of this method is general. Van Leeuwen (88) states that 25,000 of the Government standard traps, which he illustrates, were used by the Plant Quarantine and Control Administration during 1929 in its scouting work to determine the presence of beetles. Rex (65) illustrates and briefly discusses these traps and gives the bait formula recommended by the Japanese Beetle Laboratory in New Jersey. Van Leeuwen and Metzger (86) give the very latest information about traps for the Japanese beetle. They recommend the following formula for one baiting of a standard trap.

Geraniol (at least 58 per cent pure).....	15	grams (4 teaspoonfuls)
Eugenol (U. S. P.).....	1.5	grams ($\frac{1}{2}$ teaspoonful)
Bran	75	grams ($1\frac{1}{2}$ cups)
Water	13	cc. (1 tablespoonful)
Molasses	39	cc. ($2\frac{1}{2}$ tablespoonfuls)
Glycerine (C. P.).....	6	cc. ($1\frac{1}{2}$ teaspoonfuls)

Figure 4 was drawn by the present writer and illustrates the various parts of one of the standard traps.

At this place a few more remarks concerning the attractiveness of geraniol should be made. The effort is usually made to correlate attractive odors either with the food or opposite sex of an animal; but in some cases it is questionable whether food, or sex, or some unknown factor, is involved. For example, why should the banana-like odor of amyl acetate attract grasshoppers, or certain beetles? And why does the odor from the catnip plant attract members of the cat family? In regard to the attractive power of geraniol, a food odor is probably involved, although we know little about it. Smith (76, p. 59) and Smith and Hadley (79, p. 58) in two of their earlier reports remark that several of the essential oils were found to be highly attractive to the Japanese beetle, and that on studying these oils, it was discovered that one of the higher alcohols, geraniol, was

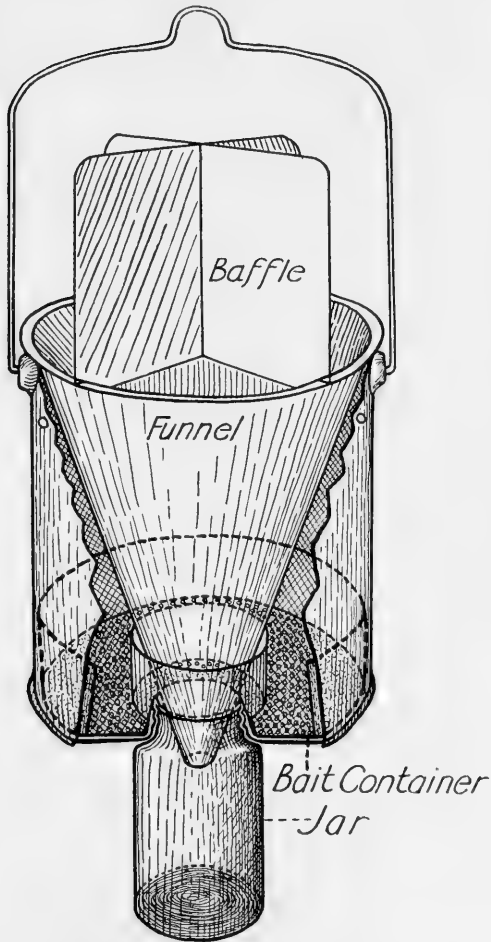

FIG. 4.—Japanese beetle trap, used by the Federal Plant Quarantine and Control Administration, showing parts of it in a cut-out perspective view. It is one-fourth natural size and was drawn by the writer by using a 1929 trap and a drawing of a 1930 trap, the latter being furnished by Mr. Courtney. The beetles, attracted by the odor from the bait in the bait container, fly directly into the funnel or strike the baffle and then fall down through the funnel into the fruit jar, where they cannot escape because they can neither fly out nor climb the walls of the jar.

a constituent of all the oils found to be distinctly attractive. Tests were made of a series of the preferred food plants, and in all cases these plants contained geraniol in varying quantities. The present writer has seen no report by a chemist concerning the last statement; but as regards fruit, Power and Chesnut (61) found geraniol in apples. They used only the parings of the McIntosh, one of the most fragrant varieties of apples, and say that geraniol, either in the free state or in the form of esters, is probably contained in varying quantities in all the numerous varieties of apples, although to the greatest extent in those which possess its distinctive odor. Power and Kleber (62) tell us that the two oils, one from sassafras bark and the other from sassafras leaves, are fundamentally different in regard to their chemical compositions. Oil from sassafras bark contains eugenol but no geraniol, while oil from sassafras leaves contains geraniol but no eugenol. There are also other differences. The fact that Japanese beetles were observed to be fond of sassafras leaves led to tests in which the oil of sassafras was used; after learning that oil from sassafras leaves contains geraniol it was only natural to continue using geraniol in bait mixtures.

A popular impression is that Japanese beetles are fond of geraniums and that our supply of geraniol comes from these plants, but this is far from the truth. Ballou (4) informs us that these beetles do feed upon the flowers and to a limited extent upon the foliage of cultivated geraniums (*Pelargonium* spp.), but with deleterious effects to themselves, because this food is toxic to them. Most of our commercial supply of geraniol is said to be derived from the oil of citronella, but in perfumery much of it also comes from the oil of palmarosa or Turkish geranium. Geraniol also occurs in the oils of lemon-grass, geranium, rose, sassafras leaves, and other essential oils.

(D) BAITS FOR OTHER BEETLES

Since 1916 it has been reported in numerous publications that certain sugarcane cockchafers in Australia can be attracted by odors from various chemicals and by the aromas distilled from their food plants, but it seems that so far no practical results have been obtained. Other reports by Jarvis (34, 36), however, indicate that poisoned baits have a practical value in helping to control the grubs of these beetles.

For years it has been known that poisoned-bran baits are of considerable value against the common May beetles and more recently Vickery and Wilson (92) used a bait consisting of 20 pounds of

wheat bran, 1 pound of Paris green, 1 quart of sirup, and the juice of 3 lemons or 1 teaspoonful of anise oil successfully against a wingless May beetle.

McKinney and Milam (48) and Gilmore and Milam (19) have successfully used a poisoned-bran bait against the grubs of the green June beetle in tobacco-plant beds and in a tobacco field.

A large white grub of a dynastid beetle is the most serious pest of sugarcane in St. Croix. The control recommended in 1916 by Smith (80) was a poisoned bait.

Poisoned-bran mash was the best control used by Cooley (10) in 1917 against the spinach carrion beetle.

Using a poisoned-bran bait in 1916 Scholl (71) destroyed the striped blister beetle on alfalfa and tomatoes.

Newman (59) in 1929 reports that a poisoned-bran bait gave excellent results against a subterranean clover weevil.

Jack (32) in 1928 reports that over 95 per cent of certain weevils in a maize field were killed by one application of a bait consisting of 1 pound of sodium arsenite, 8 pounds of sugar, and 10 gallons of water on chopped fodder.

During the seasons of 1926, 1927, and 1928, over 1,000 traps, containing fermenting sugar or molasses, were used in a peach orchard in Pennsylvania for the purpose of trapping oriental fruit moths. Frost and Dietrich (16) report that incidentally 40 families of beetles, including 188 genera and 258 species, were also caught in these traps.

Snapp and Swingle (81) have recently tested a large number of aromatics, including various steam distillates and other odorous materials derived from the food of peach insects. A large number of chemicals were found, under orchard conditions, to be slightly attractive to various peach insects, as well as to the plum curculio, but none showed much promise of being valuable from the standpoint of control.

Garman and Zappe (18) have also recently conducted many tests, trying to find attractants and repellents for the plum curculio. They remark that curculios are very sensitive to odors. Acetaldehyde and malic acid were the only substances used in the laboratory which showed much attractive power, but when these substances were tested in the field no curculios were trapped.

In conclusion under this heading a few remarks may be made about the present writer's (45) results obtained when testing potato beetles in an olfactometer. In this study no baits were actually used, but it was proved for the first time that plants (not flowers) attract insects

by emitting odors. Since odors from the steam distillates and emanations from 4 or 5 species belonging to the potato family attracted potato beetles, it was then suggested that the chemist tell us what constituent or constituents, common to these plants, did the attracting. If we had this information, we might be able to use these substances in poison baits.

(E) REPELLENTS USED AGAINST BEETLES

Under this heading many repulsive substances are regarded as repellents, but for some of them a more appropriate word would be deterrents; nevertheless, there is little distinction between these two words. Let us define a repellent as an odorous substance, which by means of its unpleasant exhalations repels insects before they have touched it; and a deterrent as an inodorous substance which repels insects after they have touched it. Thus defined, a deterrent repels mostly, if not entirely, through the sense of touch; while a repellent operates either through the sense of smell or, if its exhalations are poisonous, then through the breathing pores. These definitions are easily made, but it is perhaps almost impossible to have a deterrent which is totally inodorous to insects; and furthermore, other factors are often involved. These terms have been used loosely by various writers, and since this subject is yet confused, the present writer will still continue to use them without attempting to explain how the enumerated substances repel, deter, or otherwise keep insects away from plants. The following remarks by the writer's reviewers help to elucidate the subject.

In regard to the Japanese beetle, Doctor Van der Meulen and Mr. Van Leeuwen believe that there should be another subdivision of repellents to include those substances which mask attractive odors; for example, those from geraniol. We might call these "maskers" or "neutralizers," because they repel from a short distance merely by covering up or neutralizing the attractive odors. Relative to "inodorous" materials, Japanese beetles may also be repelled before touching dusted or sprayed food by means of the sense of sight. In regard to the repellency of the arsenates, the subject of toxicity should also be considered; but at present we are not able to evaluate the various factors, including the senses of sight, smell, touch, taste, and probably a general sense connected with the digestive system.

After reading the preceding definitions, Dr. F. L. Campbell proposed that attractants, now usually called attractants, should be divided. The odor from geraniol causes the Japanese beetle to orient and to move toward this substance; therefore, geraniol is a true

attractant. In the course of random movements certain other insects may come upon sugar, for example, which holds them after they have touched it. In this case, Campbell says that sugar might be called a true "arrestant." If insects have true senses of smell and taste, an attractant then attracts through the sense of smell and an arrestant arrests through the sense of taste.

Since entomologists already know much of the following information, only the more important references consulted will be cited here. The substances inodorous or slightly odorous to us, which have been found repulsive to insects, may be briefly discussed as deterrents. Whitewash may be considered the first deterrent used. White-washing the bases of fruit trees has been practiced for years. It is still questionable whether such a practice is of any real economic importance, but its advocates claim that the lime in it has a tendency to drive away noxious insects and may be slightly injurious to insect eggs. The most improved and best mixture of whitewash, as recently recommended in France, consists of lime, calcium arsenate, lime sulphur, and water. In this case the lime might act as a deterrent and the lime sulphur, which has a strong disagreeable odor, as a repellent. One of the most efficient deterrents used in the United States is air-slaked lime, which is employed extensively for dusting melons and cucumbers to prevent the attacks of the striped cucumber beetle. It is also said to prevent injury to stored beans by the bean weevil. In Germany a mixture of white sand and hydrated lime has recently been used to deter flea-beetles. Paints, particularly white-lead paint, are recommended for preventing boring beetles from entering wounds on fruit trees. The coat of paint covering the fresh wound preserves the wood and also acts as a mechanical barrier to the beetles. Lead arsenate, when sprayed or dusted on foliage, deters a number of insects, including the Japanese beetle, western cabbage flea-beetle, desert corn flea-beetle, and striped cucumber beetle. Most of the arsenicals deter the Mexican bean beetle. Bordeaux mixture sprayed on the leaves of eggplant and potatoes deters flea-beetles and the potato leafhopper, which causes the disease called "hopperburn."

In regard to repellents used against beetles, the first ones used were probably decoctions of certain poisonous plants. As early as 1848 leather waste from tanneries, when put among plants in Germany, was found to be a repellent against flea-beetles, and more recently in France sawdust coated with coal tar when placed among the plants repelled these insects. The most successful repellent used against these tiny insects and the striped cucumber beetle in the United States

is nicotine dust. Since it is almost impossible to kill flea-beetles by using arsenicals or other insecticides, the repellent method is an important control measure.

In Europe there has been considerable experimenting with repellents to keep beetle larvae, particularly white grubs, from attacking the roots of plants. The odorous substances were usually worked into the soil around the bases of the plants, but it is doubtful whether much protection ever resulted. In France and Belgium crude naphthalene mixed with sand was used. In France three other repellents were found more or less effective—first, residue of glue; second, naphthalene and kerosene mixed with sawdust; and third, crude oil mixed with lime, plaster of Paris, and feces. In Germany sulphur was worked into the ground around strawberry plants. In England naphthalene was successfully used against wireworms in gardens, and in Australia crude naphthalene was effective against wireworms injuring sugarcane.

McColloch and Hayes (40) have recently reviewed the methods and enumerated the repellents used to protect germinating seeds and roots and to prevent the invasion of the soil by underground insects, particularly beetles. Numerous substances have been recommended as repellents, including crude carbolic acid, turpentine, naphthalene, paradichlorobenzene, creosote, coal tar, oils of lemon and tansy, kerosene, and phenol. They state that no satisfactory repellent has yet been found which can be depended upon under varying conditions existing in the soil. They believe that this subject needs further investigation.

Since the Japanese beetle is fond of ripening fruit, particularly apples and peaches, and since it is not advisable to spray early fruit with arsenicals, ripening fruit should be protected by other means. Therefore, much experimental work has been done to develop an effective repellent to take the place of the arsenicals. Metzger and Grant (54) have developed smudge candles, which, when lighted and hung in peach trees, give off ill-smelling smoke for a period of five to eight hours. The mixture, to be burned slowly without producing a flame, was put in a wire-screen cylinder, 31 inches long and 2.25 inches in diameter. In conclusion they say that wood flour and potassium nitrate, when properly mixed, form a satisfactory base for smudges. The fumes from pine-tar oil, Dippel's oil (bone oil), and a commercial mixture of chloronaphthalenes, when given off from burning smudge candles, are definitely repellent to Japanese beetles. Air currents in the orchard, however, prevented the repellent smoke from giving satisfactory control of beetles on early peach trees.

Metzger (53) describes five methods used in testing 430 materials, alone and in combination, as repellents for the Japanese beetle. Under method 1, "testing material in comparison with a known attractant," 306 materials were tested, and 45 of them decreased the attraction of the geraniol-eugenol combination. Beginning with the one most repellent, the first ten in the list are o-cresol, pine-tar oil, phenol, Dippel's oil, high boiling tar acids, coal-tar neutral hydrocarbon oil, trichlorobenzene, crude dichlorobenzene No. 1, alpha chloronaphthalene, and crude dichlorobenzene No. 2.

Another difficult test has been to find a successful repellent for wood-boring beetles. The first object is to prevent them from entering the living trees, lumber, or manufactured wooden articles, and the second object is to kill them or drive them out of their burrows after they have once entered. Little success has yet been accomplished along this line, but it is easier to prevent their entrance than to control them later. In Brazil a mixture consisting of crude carbolineum 1 part, quicklime 10 parts, and water 40 parts is painted on the trunks of citrus trees to prevent the entrance of borers. In the United States carbolineum and creosote are often applied to the trunks of aspen trees in forests to prevent the entrance of the aspen borer. A successful repellent has recently been recommended by Pettit (60) against flat-headed borers which do considerable damage to apple trees. Following a special procedure a thick solution is prepared by using 50 pounds of laundry soap, 3 gallons of water, 25 pounds of flake naphthalene, and 2 pounds of flour. After warming and thinning this mixture to the consistency of heavy cream, it is applied several times with a brush to the trees.

The *Lyctus* powder-post beetles, which cause much damage to hardwood lumber, implement handles, furniture, etc., throughout the world, may be deterred and repelled by several substances. In the United States, according to Snyder (82), the usual method recommended is to immerse the lumber, already infested or liable to infestation with these borers, in vats of kerosene, or in a mixture of creosote and kerosene, or in one of creosote and naphtha. The writer has recently been told that these beetles may be repelled by using coal-tar creosote and orthodichlorobenzene. The lumber and handles which can not be treated by the vat method may be stored in closed sheds and close-fitting houses and then sprayed at intervals with these chemicals. In Great Britain lumber stacked in the open is often treated with cold paraffin mixed in equal parts with oil of cedar, linseed oil, or a heavy mineral oil. To lumber stored in sheds orthodichlorobenzene is applied with a brush or sprayer, or paradichlo-

robenzene is scattered on top of the stacks and suspended in bags from the roofs of the sheds.

Carpet beetles, also called "buffalo moths," often do considerable damage to carpets, woolens, furs, feathers, and upholstered furniture. One of the control measures is to prevent them from coming in contact with these articles by using repellents, such as naphthalene in the form of flakes and moth balls, paradichlorobenzene, or camphor, or by the use of red cedar chests.

2. ORIGINAL WORK ON MEXICAN BEAN BEETLE

In 1928, Mr. J. E. Graf, Assistant Chief of the Bureau of Entomology, handed the writer a manuscript entitled "Some chemotropic responses of the Mexican bean beetle," by Wallace Colman, who tested over 200 materials, but found only a few to be attractive while a larger number were repellent. According to the results in this unpublished manuscript, which deals with the sense of smell alone, the following seemed to be attractive: banana peel, amyl acetate, vanillin, coumarin, corn sirup, honey, and molasses of the higher grades; while certain lead and arsenic compounds, including lead arsenate, seemed to be repellent. Using different methods the present writer tested all of the above supposed attractants, but found only the corn sirup and molasses to be attractive, while lead arsenate proved to be repellent.

(A) SEARCH FOR ATTRACTANTS AND REPELLENTS, USING AN OLFACTOMETER

Using the writer's (45) olfactometer, with the plant chamber disconnected, no important results were obtained, but the following remarks may have some theoretical interest. On several occasions fresh bean leaves were put in the small bottle, used for holding the odorous substance to be tested. In each test in which only a few leaves were used the odor or exhalation from the leaves was attractive to the bean beetles, although the highest attraction was only 57.9 per cent. In two other tests the bottle was filled full of leaves. The results (61.8 per cent and 72.5 per cent), instead of showing attraction, showed repulsion, indicating that attractants when concentrated become repellents. The odors from table molasses (1 part molasses and 1 part water) and the water extract (diluted juice) of bean leaves were also found to be slightly attractive.

The following, used in minute quantities, were repellent: oil of peppermint, creosotum, nicotine sulphate, banana peel, amyl acetate, and geraniol.

(B) SEARCH FOR ATTRACTANTS AND REPELLENTS, USING FEEDING METHOD

A search for attractants and repellents was begun in 1928, but during that year no important results were obtained. The following remarks, however, may be of some interest. A liquid, highly scented with skatol, when sprayed on bean foliage in the laboratory did not delay the eating of the leaves. A piece of cotton, scented with oil of peppermint, was put among some bean leaves. The leaves were eaten as usual. Four odorous powders were prepared with the aid of heat by using (1) nicotine sulphate and lead arsenate; (2) nicotine sulphate and lime; (3) tar and lead arsenate; and (4) tar and lime. When these powders were mixed with soap solution and sprayed on bean foliage in the laboratory the sprayed leaves were eaten almost as readily as were the untreated leaves nearby.

A wire-screen cage, 4 feet long, 3 feet wide, and 3 feet tall, containing hundreds of adult beetles, was put in the insectary. A pan containing bran bait was suspended in each corner. The first bait was flavored with black-strap molasses; the second, with amyl acetate; the third, with vanillin; and the fourth contained only bran and water. The second and third baits each attracted only a few beetles; the fourth, many; while the first, more than twice as many as the fourth. It thus seems that the molasses bait was slightly attractive.

The preceding test was repeated by putting a pan containing black-strap molasses and water in each corner, an aromatic being put in each of three pans. The pans containing coumarin and vanillin attracted practically the same number of beetles; the pan containing amyl acetate, several more; and the pan containing only molasses and water, a few more, but the attraction was not significant.

The foregoing test was repeated by putting three pans in the cage. One contained the juice from bean leaves; the second, the remaining pulp of the leaves and diluted table molasses; and the third, diluted table molasses. The first and third attracted beetles in equal number, while the second attracted three times as many, not a sufficient number to appear significant.

A pan containing fermenting table molasses was next put in the center of the cage. For five days the beetles in it were counted, but no striking attraction was noticed at any time.

Not yet having found any substance which seemed promising as an attractant, the writer in 1929 decided to test a large number of materials. After spending much time, 104 aromatic chemicals, 3 brands of molasses, 2 varieties of canesugar, and 1 highly scented honey were tested. The method consisted of testing 8 substances at one time in a small wire-screen cage. This method was found to be

faulty, yet the writer believes that if a strong attractant in the proper concentration had been used striking results could have been obtained quickly. No important results were really obtained, but the following remarks may be worth recording. Using water as a control, methyl anthranilate, benzaldehyde, methyl benzoate, terpinyl acetate, dibenzyl ether, tertiary amyl alcohol, and ethyl iso-valerate seemed to be more or less attractive, but not sufficiently so to be significant. The most promising chemical, methyl anthranilate, was tried in the bean patch but attracted no beetles. In the preliminary tests while using water and portions of bean leaves as controls, a good grade of table molasses diluted with water was nearly always preferred to the controls. Fermenting table molasses was attractive up to the vinegar stage of fermentation, after that its attractiveness ceased. During warm weather when the beetles were thirsty, a long series of tests was conducted to ascertain their preferences when given water, molasses, sugar, and honey. The final results showed their preferences to be: (1) water alone; (2) corn sirup and granulated sugar, practically the same; (3) table molasses and sugar sirup, the same; (4) brown sugar; (5) honey; and (6) black-strap molasses. The sugar sirup consisted of boiled brown sugar and water (about 1 to 1). The brown sugar was a saturated solution. Each of the others was half sweet substance and half water. On August 5 and 12, pans containing table molasses, corn sirup, and black-strap molasses were put between rows of beans in the garden. Observations were taken thereafter for several days, but not a bean beetle was seen in the pans, although many moths and certain other insects were caught in the baits.

(C) SEARCH FOR ATTRACTANTS AND REPELLENTS, USING AN IMPROVED
FEEDING METHOD

In order to obtain comparative results which could be treated statistically, four cages were constructed. Each cage was 8.75 inches square, 0.75 inch deep (inside dimensions), and had a wooden bottom and a top of wire-screen and glass (fig. 5, A). The substances to be tested were put on pieces of cardboard (W, X, Y, and Z), 1.75 inches square, which were arranged in a row, being equally spaced between themselves and the sides of the cage. From left to right the positions of the cardboard were numbered 1, 2, 3, and 4. In the first series of tests the substances were arranged in the four cages as indicated by the first row in the four diagrams (B, C, D, and E); in the second series, as indicated by the second row; in the third series, as indicated by the third row; and in the fourth series, as

indicated by the fourth row. According to this arrangement of food, no two rows in the same cage were exactly alike; likewise, no two rows of all 16 rows were identical, although the distribution of food was not so complete. These four series of tests were conducted during the forenoon, and then usually repeated in the afternoon. Each

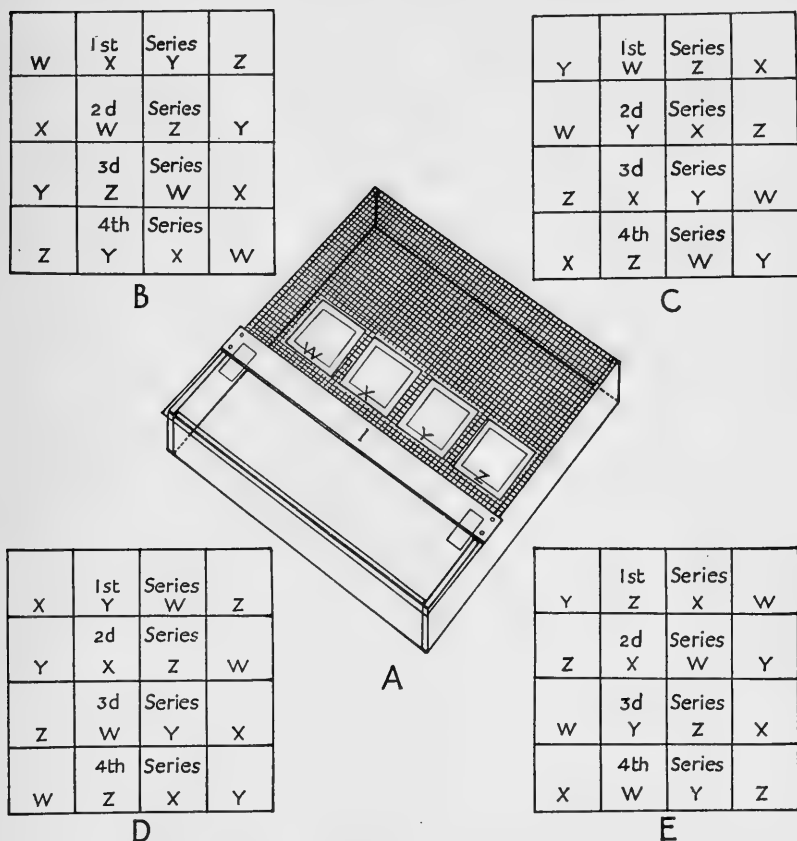

FIG. 5.—Diagrams of wire-screen cage (A) and arrangement of substances (B, C, D, and E) to be tested by bean beetles. See text, p. 32, for further explanation.

individual substance used was therefore tested 16 times in the forenoon and usually 16 times in the afternoon.

It was difficult to decide whether tests of this kind should be conducted in the dark-room or in the well-lighted laboratory. After trying the dark-room it was observed that the bean beetles did not eat freely either in artificial light or in total darkness. So it was decided to place the cages on a table by a south window, but not in the

direct sunshine. As suspected under these conditions, the number of beetles counted in the four positions varied greatly. More beetles were always counted in the outer positions (Nos. 1 and 4) than in the inner ones (Nos. 3 and 4). This was caused largely by the beetles following the sides of the cage while moving toward the window. In 40 series of tests, selected at random, 67.04 per cent of the beetles were counted in the outer positions and 32.96 per cent in the inner positions. The following percentages were counted in the four positions: 37.06 per cent in position 1; 17.01 per cent in position 2; 15.95 per cent in position 3; and 29.98 per cent in position 4. Since each substance used lay in all four positions during any one series of tests, these large differences did not supposedly change the arithmetic mean, but they greatly affected the probable error, because each number of beetles counted on a substance was considered a statistical item. Since the beetles ate more freely during the forenoon than during the afternoon, the probable errors were further affected.

In addition to the preceding statements, the general plan in conducting these tests was to put 60 beetles of approximately the same age and physiological condition in each cage. The number of beetles on (or touching) the food was counted at intervals of 45 minutes, and this number was considered a statistical item. The food was renewed whenever necessary to keep it in an appetizing condition, and to prevent contamination it was usually put on unused pieces of cardboard. Since the beetles had a tendency to congregate at the ends of the cages nearest the window, the cages were often turned end for end, thus causing the insects to scatter more evenly. The daily temperature and relative humidity in the laboratory were recorded, and a record of the outside climatic conditions was also kept. In brief, everything possible was done to obtain reliable data which could be treated statistically. The arithmetic mean and probable error are stated in tables 2 to 11 for reference in connection with the following discussion. Since the statistical items were never less than 16, the following formula for calculating the probable error was used—

$$P. E. m = \pm 0.6745 \frac{\sigma}{\sqrt{N}}$$

(1) *Beetles can distinguish differences between water and salty liquids.*—To determine whether Mexican bean beetles “like” or “dislike” the four classes of substances which produce the four human attributes of taste, many series of tests were conducted. The results obtained are given in tables 2 to 5.

To ascertain whether these insects “like” salty water, sodium chloride, potassium nitrate, and magnesium sulphate (epsom salts)

TABLE 2.—*Tests to determine whether Mexican bean beetles can distinguish differences between water and salty liquids*

Methods of feeding salty liquids	Total number of beetles on cotton	Mean and probable error	Relative value of beetles on cotton	Number of set of beetles	Date	Number of tests
Water on cotton (control)	106	3.31 ± 0.44	1.00	} 16	Aug. 29-30	32
Sodium chloride on cotton	13	0.41 ± 0.12	0.12			
Potassium nitrate on cotton	30	0.94 ± 0.28	0.28			
Magnesium sulphate on cotton	56	1.75 ± 0.27	0.53			

TABLE 3.—*Tests to determine whether Mexican bean beetles can distinguish differences between water and sour liquids*

Methods of feeding sour liquids	Total number of beetles on cotton	Mean and probable error	Relative value of beetles on cotton	Number of set of beetles	Date	Number of tests
Water on cotton (control)	150	9.38 ± 1.12	1.00	} 16	Aug. 31	16
Acetic acid on cotton.	36	2.25 ± 0.61	0.24			
Hydrochloric acid on cotton	31	1.94 ± 0.47	0.21			
Lemon juice on cotton.	27	1.69 ± 0.44	0.18			

TABLE 4.—*Tests to determine whether Mexican bean beetles can distinguish differences between water and bitter liquids*

Methods of feeding bitter liquids	Total number of beetles on cotton or leaves	Mean and probable error	Relative value of beetles on cotton or leaves	Number of set of beetles	Date	Number of tests
Water on cotton (control)	171	10.69 ± 0.84	1.00	} 14	Aug. 16	16
Strychnine on cotton.	102	6.38 ± 0.78	0.60			
Quinine on cotton....	83	5.19 ± 0.72	0.49			
Picric acid on cotton.	46	2.88 ± 0.26	0.27	} 20	Sept. 14	32
Leaves, sprayed with water (control) ..	198	6.19 ± 0.29	1.00			
Leaves, sprayed with beetle extract	172	5.38 ± 0.39	0.87			

were used at the rate of 1 gm. of salt to 25 cc. of water (table 2). Pieces of cotton of equal size were wet with tap water and with the three salty solutions, and then they were put on the pieces of cardboard, as already described.

(2) *Beetles can distinguish differences between water and sour liquids.*—To ascertain whether the above statement is true, three

TABLE 5.—*Tests to determine whether Mexican bean beetles can distinguish differences between water and sweet substances*

Methods of feeding sweet substances	Total number of beetles on cotton or leaves	Mean and probable error	Relative value of beetles on cotton or leaves	Number of set of beetles	Date	Number of tests
Water on cotton (control)	34	1.06 ± 0.23	1.00	} 16	Aug. 29-30	32
Cane sugar on cotton..	307	9.60 ± 0.75	9.03			
Grape sugar on cotton.	87	2.72 ± 0.35	2.56			
Saccharine on cotton..	15	0.47 ± 0.12	0.44	} 20	Sept. 13	32
Leaves, sprayed with water (control)	141	4.41 ± 0.36	1.00			
Leaves, sprayed with cane sugar	254	7.94 ± 0.41	1.80			
Leaves, sprayed with grape sugar	202	6.31 ± 0.44	1.43			
Leaves, sprayed with saccharine	113	3.53 ± 0.27	0.80			
Leaves, sprayed with water (control) ...	108	3.38 ± 0.33	1.00			
Leaves, sprayed with table molasses	261	8.16 ± 0.51	2.42	} 21	Sept. 16	32
Leaves, sprayed with corn sirup	174	5.44 ± 0.40	1.61			
Leaves, sprayed with black-strap molasses.	203	6.34 ± 0.41	1.88			

sour liquids were used, each of two being prepared at the rate of $\frac{1}{2}$ cc. of glacial acetic acid (99.5 per cent) or hydrochloric acid (85.9 per cent) to 25 cc. of water, and the third at the rate of 4 cc. of lemon juice to 21 cc. of water (table 3).

(3) *Beetles can distinguish differences between water and bitter liquids.*—To determine whether the above statement is correct, four bitter liquids were used, each of three being prepared at the rate of

50 mg. of picric acid, quinine sulphate, or strychnine sulphate to 25 cc. of water. The fourth was prepared by adding 25 cc. of water to the macerated bodies of 20 live bean beetles. The resulting liquid, when filtered, was yellowish and to the writer had a bitter taste and an unpleasant odor. It was sprayed upon bean leaves, which when dry were cut into pieces, one inch square, then put on the pieces of cardboard, and finally fed to the beetles (table 4).

TABLE 6.—*Tests to determine whether bean foliage sprayed with sweetened arsenicals is more attractive to Mexican bean beetles than unsprayed foliage*

Leaves: un-sprayed and sprayed with:	Total number of beetles on leaves	Mean and probable error	Relative value of beetles on leaves	Number of set of beetles	Date	Number of tests
Unsprayed (control) ..	74	2.31 ± 0.35	1.00	18	Sept. 5	32
Calcium arsenate and sugar	106	3.31 ± 0.31	1.43			
Magnesium arsenate and sugar	131	4.10 ± 0.33	1.77			
Lead arsenate and sugar	132	4.12 ± 0.30	1.78			
Unsprayed (control) ..	131	4.10 ± 0.38	1.00			
Magnesium arsenate and table molasses ..	194	6.06 ± 0.40	1.48	22	Sept. 25	32
Magnesium arsenate and corn sirup	157	4.90 ± 0.49	1.20			
Magnesium arsenate and black-strap molasses	113	3.53 ± 0.40	0.86			

(4) *Beetles can distinguish differences between water and sweet liquids.*—To determine whether the above is correct, 24 series of tests were conducted by using six sweet solutions, each of five of them being prepared at the rate of 1 gm. or 1 cc. of granulated cane sugar, grape sugar (dextrose), a high quality table molasses, corn sirup, or black-strap molasses to 25 cc. of water; and the sixth at the rate of 20 mg. of saccharine to 25 cc. of water (table 5).

From the information given in tables 2 to 5, with additional notes, it may be concluded that Mexican bean beetles exhibit "likes" and "dislikes" when fed substances which produce the four human at-

tributes of taste. They "disliked" water containing salts, acids, bitter materials, and saccharine, but "liked" the other sweet substances, including cane sugar, grape sugar, table molasses, corn sirup, and black-strap molasses, and even showed preference between them. To the writer the saccharine solution was sweetest, but distasteful; the cane sugar, less sweet, and tasteful; and the grape sugar, least sweet, and less tasteful. The beetles showed "dislikes" and

TABLE 7.—*Tests to determine whether bean foliage sprayed with arsenicals, is repellent to Mexican bean beetles*

Leaves: un-sprayed, and sprayed with:	Total number of beetles on leaves	Mean and probable error	Relative value of beetles on leaves	Number of set of beetles	Date	Number of tests
Unsprayed (control) .	191	5.97 ± 0.49	1.00	} 17	Sept. 3	32
Calcium arsenate	160	5.00 ± 0.62	0.84			
Magnesium arsenate..	177	5.53 ± 0.56	0.93			
Lead arsenate	111	3.47 ± 0.40	0.58			
Unsprayed (control)..	275	8.59 ± 0.67	1.00	} 17	Sept. 4	32
Calcium arsenate	177	5.53 ± 0.50	0.64			
Magnesium arsenate..	122	3.81 ± 0.42	0.44			
Lead arsenate	122	3.81 ± 0.48	0.44			
Unsprayed (control)..	172	5.38 ± 0.46	1.00	} 24	Sept. 27	32
Calcium arsenate	159	4.97 ± 0.35	0.92			
Magnesium arsenate..	104	3.25 ± 0.25	0.60			
Lead arsenate	101	3.16 ± 0.22	0.59			
SUMMARY of above:				}	above 96
Leaves, unsprayed (controls)	638	6.64 ± 0.33	1.00			
Calcium arsenate	496	5.17 ± 0.29	0.78			
Magnesium arsenate..	403	4.20 ± 0.26	0.63			
Lead arsenate	334	3.48 ± 0.22	0.52			

"likes" in somewhat the same order. To the writer the picric-acid solution was most bitter, the quinine less bitter, and the strychnine least bitter. The insects "disliked" these solutions in about the same order. To the writer the solutions containing acetic acid and hydrochloric acid had practically the same degree of sourness, while the diluted lemon juice was sourer. The beetles also showed only slight differences between them. In regard to the salty solutions, the writer disliked only the magnesium sulphate solution, but the beetles preferred it to the other two.

(5) *Bean foliage sprayed with sweetened arsenicals is more attractive than unsprayed foliage.*—To ascertain whether the above is correct, 16 series of tests were conducted. The arsenicals were prepared as stated on the following page, then 1 gm. of granulated cane

TABLE 8.—*Tests to determine whether bean foliage sprayed with sweetened magnesium arsenate is more attractive to Mexican bean beetles than foliage sprayed with non-sweetened magnesium arsenate*

Leaves sprayed with:	Total number of beetles on leaves	Mean and probable error	Relative value of beetles on leaves	Number of set of beetles	Date	Number of tests
Magnesium arsenate (control)	71	2.22 ± 0.26	1.00	} 23	Sept. 26	32
Magnesium arsenate and table molasses (2 to 50)	192	6.00 ± 0.61	2.70			
Magnesium arsenate and corn sirup (2 to 50)	114	3.56 ± 0.39	1.60			
Magnesium arsenate and black-strap molasses (2 to 50)	122	3.81 ± 0.43	1.72			
Magnesium arsenate (control)	82	2.56 ± 0.28	1.00	} 25	Sept. 30	32
Magnesium arsenate and black-strap molasses (2 to 50)	132	4.12 ± 0.36	1.61			
Magnesium arsenate and black-strap molasses (1 to 50)	115	3.59 ± 0.29	1.40			
Magnesium arsenate and black-strap molasses (½ to 50)	134	4.19 ± 0.32	1.63			

sugar or 1 cc. of a high quality table molasses, corn sirup, and black-strap molasses was added to 25 cc. of the spray mixture (table 6).

According to the results given in table 6, it is again shown that these beetles like their food sweetened.

(6) *Bean foliage sprayed with arsenicals is repellent.*—To determine whether bean foliage sprayed with arsenicals is eaten as readily as are unsprayed bean leaves, 24 series of tests were conducted. The

leaves were sprayed with calcium arsenate, magnesium arsenate, and lead arsenate at the rate of 1 pound of powder to 50 gallons of water. The calcium-arsenate mixture also contained lime at the rate of 1.5 pounds to 50 gallons of water (table 7).

The results given in table 7 clearly show that arsenicals are repellent, but not sufficiently so to prevent the foliage from being eaten. Lead arsenate was most repellent, magnesium arsenate was less so, and calcium arsenate was least repellent. The word "deterrent" is probably the better expression in this case.

TABLE 9.—*Tests to determine whether water extract and steam distillate of bean leaves are attractive to Mexican bean beetles*

Methods of feeding leaves and liquids	Total number of beetles on leaves or cotton	Mean and probable error	Relative value of beetles on leaves or cotton	Number of set of beetles	Date	Number of tests
Leaves, unsprayed (control)	190	5.94 ± 0.30	1.00	} 21	Sept. 18	32
Water on cotton.	28	0.87 ± 0.14	0.15			
Water extract on cotton	167	5.22 ± 0.40	0.88			
Water extract and cane sugar (1 to 25) on cotton.	677	21.16 ± 0.82	3.56	} 21	Sept. 19	64
Water on cotton (control)	415	6.48 ± 0.41	1.00			
Distillate on cotton.	436	6.81 ± 0.43	1.05			

(7) *Bean foliage sprayed with sweetened magnesium arsenate is more attractive than foliage sprayed with non-sweetened magnesium arsenate.*—To determine whether the above is true 16 series of tests were conducted by using magnesium arsenate (1 pound to 50 gallons water) with molasses added at the rate of 2, 1, and ½ gallons to 50 gallons of the spray mixture (table 8).

The results given in table 8 once more show that sweetened food is preferred to non-sweetened food.

On September 30 four small bean plants, each bearing six leaves, were sprayed. Two of these were sprayed with magnesium arsenate alone and the other two with a mixture of magnesium arsenate and black-strap molasses (1 to 50). One plant sprayed with the non-sweetened mixture and one with the sweetened mixture were put to-

gether in one end of a cage, and the other two sprayed plants were arranged likewise at the other end of the cage. Soon after placing 100 beetles in the cage the insects climbed upon the sprayed foliage, paying apparently no more "attention" to the sweetened leaves than to the non-sweetened ones, but after a few hours and thereafter until October 3, when the experiment was ended, the sweetened leaves bore the more beetles and were the more eaten. The final result

TABLE 10.—*Tests to determine whether chemotaxis or phototaxis is more important in the finding of food by Mexican bean beetles*

Methods of feeding leaves and liquids	Total number of beetles on leaves or cotton	Mean and probable error	Relative value of beetles on leaves or cotton	Number of set of beetles	Date	Number of tests and remarks
Bean leaves, not sprayed (control).	68	2.12 ± 0.31	1.00	} 22	Sept. 23	32 tests. Beetles in direct sunshine.
Apple leaves not sprayed	4	0.12 ± 0.02	0.06			
Green water on cotton	196	6.12 ± 0.76	2.88			
Green sugar water (1 to 25) on cotton..	635	19.84 ± 0.99	9.34			
Bean leaves, not sprayed (control).	116	3.62 ± 0.24	1.00	} 22	Sept. 24	32
Mulberry leaves not sprayed	19	0.59 ± 0.11	0.16			
Mulberry leaves, sprayed with sugar water (1 to 25)...	73	2.28 ± 0.30	0.63			
Bean leaves, sprayed with sugar water (1 to 25).....	221	6.91 ± 0.42	1.90			

showed that the sweetened leaves bore 69.7 per cent of all the beetles counted on the four sprayed plants.

(8) *Water extract and steam distillate of bean leaves tested.*—To test the diluted juice of bean foliage, a water extract was prepared by adding 50 cc. of water to 10 gm. of leaves, cut into small pieces. After macerating the pieces and decanting the liquid through cheesecloth, 50 cc. of a greenish liquid was secured. To test the steam distillate of bean foliage, 100 cc. of water was added to 30 gm. of leaves, cut into small pieces, and then 50 cc. of a clear and odorous distillate was collected (table 9).

The results given in table 9 show that when water extract of bean leaves was compared to unsprayed leaves it was about equally attractive, while sweetened water extract was about 3.56 times as attractive. Steam distillate from bean leaves was not attractive, but gave practically the same result as did water, indicating that its faint odor had no attractive influence.

(9) *Chemotaxis more important than phototaxis in the finding of food.* Sixteen series of tests were conducted to ascertain whether phototaxis or chemotaxis, or possibly thigmotaxis, is the more important in the finding of food. Squares of bean leaves, apple leaves,

TABLE II.—*Tests to determine whether repellents would protect beans from the Mexican bean beetle*

Leaves: un-sprayed and sprayed with:	Total number of beetles on leaves	Mean and probable error	Relative value of beetles on leaves	Number of set of beetles	Date	Number of tests
Unsprayed (control) ..	226	7.06 ± 0.49	1.00	} 19	Sept. 9	32
Tar and lime.....	216	6.75 ± 0.53	0.96			
Nicotine sulphate and lime	196	6.12 ± 0.47	0.87			
Derris product	120	3.75 ± 0.47	0.53	} 19	Sept. 10	32
Unsprayed (control) ..	256	8.00 ± 0.64	1.00			
Cresol	251	7.84 ± 0.49	0.98			
Nicotine sulphate	219	6.84 ± 0.56	0.85			
Beta naphthol	142	4.44 ± 0.47	0.55			

and mulberry leaves, all of the same shape and size (1 in. square), but some bearing a film of cane sugar, represented practically the same color, form, and texture, but differed chemotactically. Cotton wet with green water and with green sugar water (a green dye being used) also somewhat resembled the leaves in color but differed in other respects (table 10).

The results given in table 10 show that sweetened food is preferred to non-sweetened food and that chemotaxis is more important than phototaxis in bringing about the results obtained.

(10) *Repellents would probably not protect beans.*—To ascertain whether certain substances, usually known as repellents, would keep the beetles away from the treated leaves in the four small cages, bean foliage was sprayed with the following: Tar and lime, combined as a dust; nicotine sulphate and lime, combined as a dust, a com-

mercial Derris product, consisting mostly of pyridine; cresol, U. S.P. (1 cc. shaken in 400 cc. water); 40 per cent nicotine sulphate in water (1 to 400); and beta naphthol (1 gm. powder in 400 cc. water; powder not all in suspension) (table 11).

The results given in table 11 show that the repellents more or less protected the leaves, but not sufficiently so to prevent them from being eaten. The Derris product and beta naphthol were the only ones which might be considered promising, yet their protective value was about equal to that of lead arsenate, as already shown in table 7.

III. THERMOTAXIS

After having searched the literature for references on other tropisms not yet discussed, the writer found a few more concerning Coleoptera, but only two of these references pertain to the orientation of beetles to temperature. Much experimental work on various temperatures, particularly as control measures, has been done, but very little of it can be discussed from the tropic point of view.

I. REVIEW OF LITERATURE

Fulton (17) devised a crude temperature gradient with which he determined that the choice of temperature of adult click beetles is much below the usual maximum temperature in open fields during summer. He also says that negative phototaxis causes the beetles to seek dark hiding places during the day. Wireworms, or the larvae of these beetles, were found more resistant to heat than were the adults, but they did not voluntarily seek higher temperatures. Seasonal movements of the larvae may be closely correlated with changes in soil temperature.

Grossman (21) tried three methods to determine the orientation of cotton boll weevils to heat stimuli, but decided that only the results obtained by using a new apparatus were reliable. This apparatus was constructed by using 16 copper bars $\frac{1}{8}$ inch wide and $\frac{1}{16}$ inch thick, with $\frac{1}{4}$ inch insulating space between each two bars. Using only two variables, temperature and light, 126 boll weevils were tested 1,993 times. The average temperatures to which they reacted definitely were 130° F. at the hot end of the apparatus and 26° F. at the cold end.

B. SENSORY RECEPTORS

Since tropic responses are brought about largely by external stimuli affecting either the special sense organs or others not definitely known and localized, called the general sense organs, it is only natural to discuss the tropic responses and sensory receptors in the same paper.

I. PHOTORECEPTORS

According to the phototactic responses of the Mexican bean beetle and its larva, already discussed, the compound eyes and ocelli in this species are normally developed and seem to function adequately, so far as beetles are concerned. It is recalled that the adults are always photopositive and that the larvae up to the time of pupation are photopositive, too, but when ready to pupate they become photonegative. Whether the negative reaction is caused by a change in the structure of the ocelli is not known.

Since the morphology of insects eyes has often been discussed and as the writer (46, 47) has recently cited reviews on this subject, no further discussion is needed here. Also, the other sense organs and senses of beetles will be discussed only briefly.

II. CHEMORECEPTORS

Chemoreceptors include both olfactory and gustatory organs, but we are not absolutely sure that insects have true chemoreceptors, although their organs certainly belong to the same category.

I. SO-CALLED OLFACTORY ORGANS

(A) ANTENNAL ORGANS

The organs on the antennae of the Mexican bean beetle are comparatively few; that is, these antennae are nearly bare in comparison to most antennae (fig. 6). Only four types of sense organs were found on them. They are as follows: (1) Two groups of tiny hairs (*St*); and (2) three or four pores (*P*), called olfactory by the writer, lie on the base of the first antennal segment; (3) the Johnston organ (*J*) lies at the distal end of the second segment; and (4) five areas of thin-walled hairs (*OHR*) were found on the distal ends of the ninth, tenth, and eleventh segments. All of these structures are sense organs, because sense cells were found connected with them, while the larger hairs (*Hr*), usually called sense bristles, were found to be non-innervated.

Of these four types of sense organs only the olfactory pores and thin-walled hairs may be regarded as so-called olfactory organs. The thin-walled hairs are numerous and most of them lie on the dorsal surface of the antennae (fig. 6, *OHR*). Under a high-power lens they appear long and slender, have thin, almost transparent walls (*C, OHR*), and are connected with sense cells.

From the preceding it is evident that pore plates, found only on the antennae of aphids, bees, wasps, and on some beetles, are totally absent on the antennae of the Mexican bean beetle. The pore plates,

when present, are considered the olfactory organs by most writers. Figure 7 illustrates the antennal organs of a water beetle, copied from Hochreuther (25). The pore plates (*PP*), hollow pit pegs (*HPPg*), and massive pit pegs (*MPPg*) might be called olfactory organs, but Hochreuther regarded only the hollow pit pegs as probably olfactory in function. If they really act as olfactory organs, then the mouth parts, thorax, legs, and sexual organs must aid in receiving odor stimuli, because Hochreuther found them also on these parts of the anatomy.

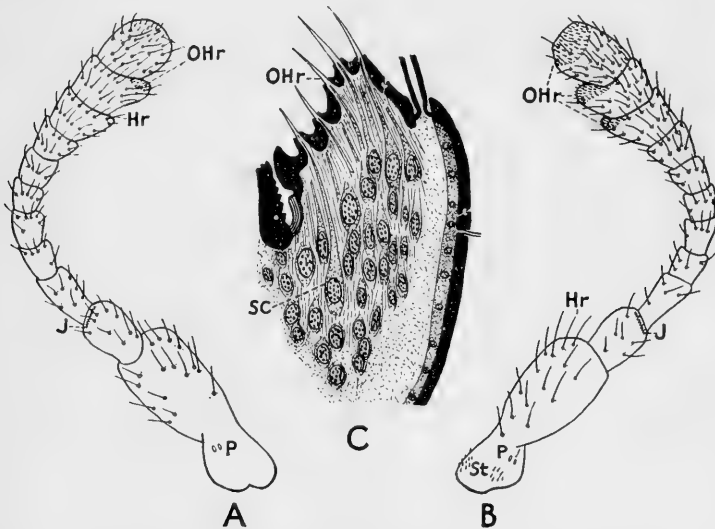

FIG. 6.—Drawings of antennae of adult Mexican bean beetle, showing organs on them. A, ventral surface, and B, dorsal surface, showing location of following: *Hr*, noninnervated hairs; *J*, Johnston organs; *P*, pores called olfactory by the writer; *Ohr*, so-called olfactory hairs; and *St*, tactile hairs. C, a semi-diagrammatic drawing from a section through tenth segment, showing structure of so-called olfactory hairs (*Ohr*) and their sense cells (*SC*). A and B, $\times 53$; and C, $\times 500$.

(B) OLFACTORY PORES

The writer (46, p. 1105) in 1926 cited references pertaining to these organs in beetles and in 1929 he (47, p. 27) stated why they were called "olfactory pores." In 1915 (41) he made a comparative study of them in 50 species of beetles belonging to 47 genera and representing 34 families. In that study only the legs, elytra, and wings were examined for these pores. A group of pores (fig. 8, A and B, 1) was always found on the peduncle of each elytron. The number of pores in it ranged from 12 to 310, and the more pores in the group the smaller they were and the closer they were together. Of the 47

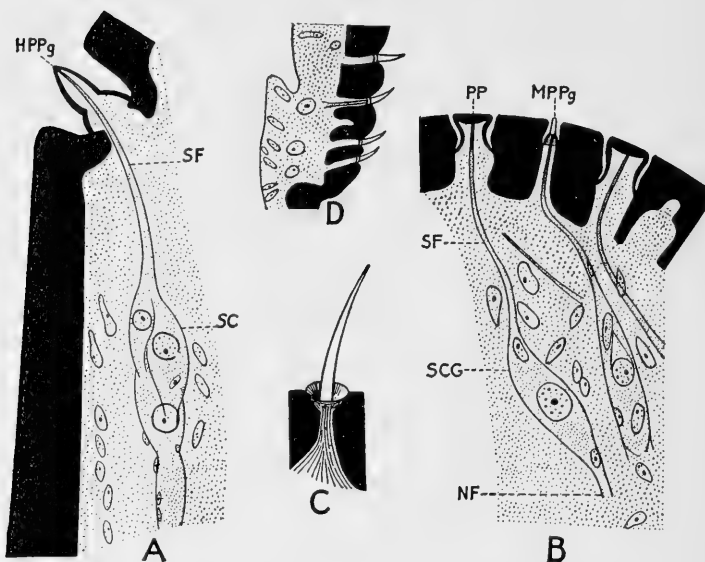

FIG. 7.—Antennal organs of a water beetle, *Dytiscus marginalis*, copied from Hochreuther (25). A, longitudinal section through a hollow pit peg (HPPg); B, longitudinal section through a small massive pit peg (MPPg) and 2 pore plates (PP). This drawing is a combination of Figs. 32 and 58 from Hochreuther, slightly modified. C, a small tactile hair from first segment, total preparation; and D, portion of Fig. 12 from Hochreuther, showing 4 small sense bristles from second segment. *NF*, nerve fiber; *SC*, sense cell; *SCG*, sense cell group; and *SF*, sense fiber.

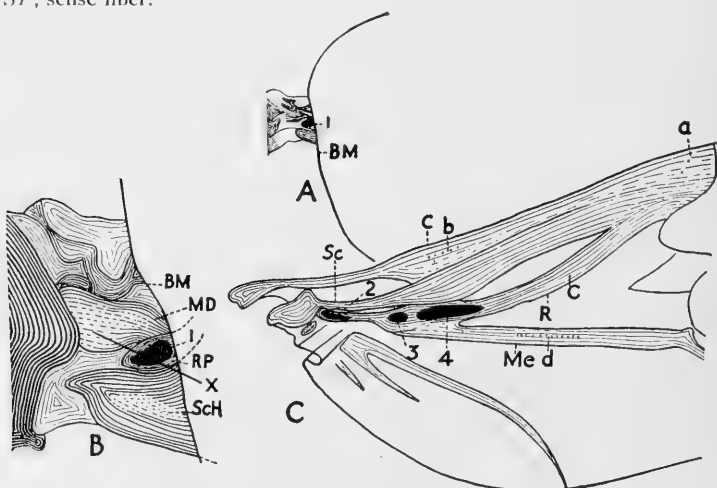

FIG. 8.—Portion of left elytron (A and B) and left wing (C) of Mexican bean beetle, showing position of olfactory pores as indicated by numbers 1 to 4 and letters a to d on dorsal surfaces. A shows relative sizes of peduncle of elytron and group 1 when compared with size of basal margin (BM) of elytron; A and C, $\times 12$; and B, $\times 67$. The lower side of A and B is the outer margin of the elytron. C, costa; *MD*, muscle disk; *Me*, media; *R*, radius; *RP*, radial plate; *Sc*, subcosta; *Sch*, subcostal head.

winged species examined, 11 had only one group of pores on each wing, 21 had two groups on each wing, 12 had three groups on each wing (C, 2, 3, and 4), and 3 had four groups on each wing. The

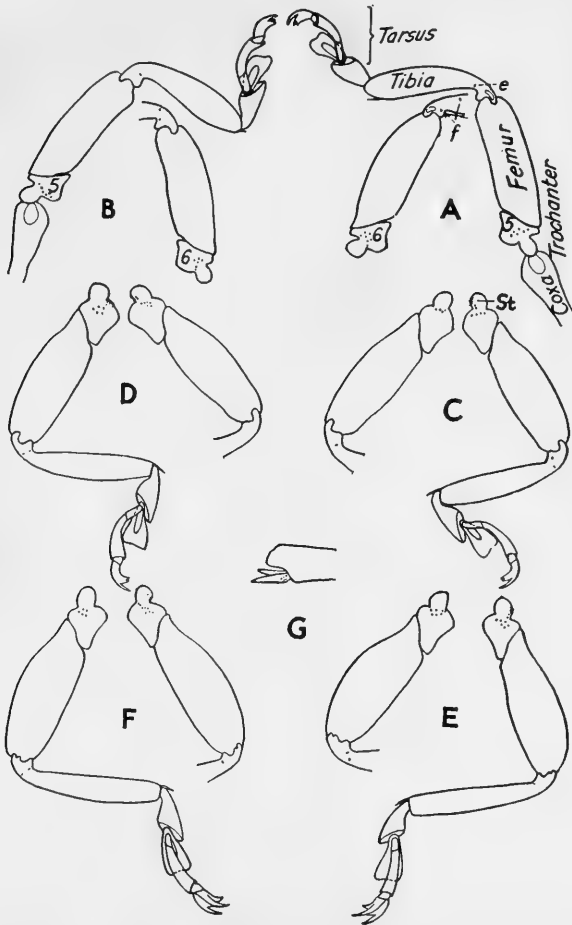

FIG. 9.—Position of sense organs on legs of adult beetles; dots, marked 5 and 6, and *e* and *f*, being olfactory pores; and *St*, tactile hairs. A to F, legs of Mexican bean beetle, $\times 12$; and G, distal end of tibia from front leg of *Epicauta marginata*, showing 5 olfactory pores on tibial spine. The drawing of each leg in which the tarsus is shown represents the outer surface and the portion of leg without tarsus represents the inner surface of the same leg. A, right front leg; B, left front leg; C, right middle leg; D, left middle leg; E, right hind leg; and F, left hind leg.

number of pores on a pair of wings ranged from 130 to 982. The number of pores counted on all six legs of an individual ranged from 49 to 341. There were usually two groups of pores on each trochanter (fig. 9, 5 and 6). Sometimes a pore was found at the proximal end of

the femur. A few pores were always found at the proximal end of each tibia (*e* and *f*), and sometimes pores were found in the tibial spines (*G*) and on the tarsi.

In regard to water beetles, the better the legs are adapted for locomotion in water, the fewer pores they have. The smallest winged species examined had 273 pores, which is the smallest number counted of all the species, and the largest species had 1,268 pores which is the largest number of all the species examined. The wingless species had more pores on the legs than usual. As a rule, the smaller the species, the fewer its pores and the larger they are, comparatively speaking. As a rule, no generic and specific differences were found, except variations in number of pores, the amount of variation depending on the sizes of the individuals compared. There were no individual and sexual differences other than slight variations in number of pores.

The pore apertures or pits are round, oblong, slitlike, or club-shaped. On the elytra and wings (fig. 10, *A* and *B*, *Ap*) they are always round or oblong. On the legs (*C*) they have all four of the enumerated shapes.

The spindle-shaped sense cells (fig. 10, *C*, *SC*) of most beetles lie in the lumens of the appendages outside the pore cavities. A small chitinous cone (*Co*) is always present. It is formed by the hypodermal cell at the mouth of the pore after the insect has emerged from the last pupal instar, and at the same time when the chitinous integument is being considerably thickened. The sense cells are fully developed when the insect emerges into the imago. The sense fiber pierces the cone, and comes in direct contact with the outside air. This statement is denied by other writers. In the legs of the lady-beetle *Epilachna borealis* the pore apertures lie in the center of domes (fig. 10, *C*) above the general surface of the legs.

A large nerve and a large trachea run into each elytron (fig. 10, *A*, *N* and *Tr*) and wing. In the peduncle of the elytron they run through the radial plate just beneath the group of olfactory pores. Branches from the nerve are given off which connect with the sense cells. The large nerve and trachea passing into the wing soon divide so that a smaller nerve and a smaller trachea (*B*, *N* and *Tr*) run through each main vein. The largest trachea passes through the subcosta, and the largest nerves pass through the veins bearing the olfactory pores. These nerves give off branches which connect with the sense cells. The sense cells (*C*, *SC*), wherever found, are always surrounded by blood (*Bl*).

In a study of the sense organs of the cotton boll weevil, the writer (46) found the olfactory pores common to both the adult and larva;

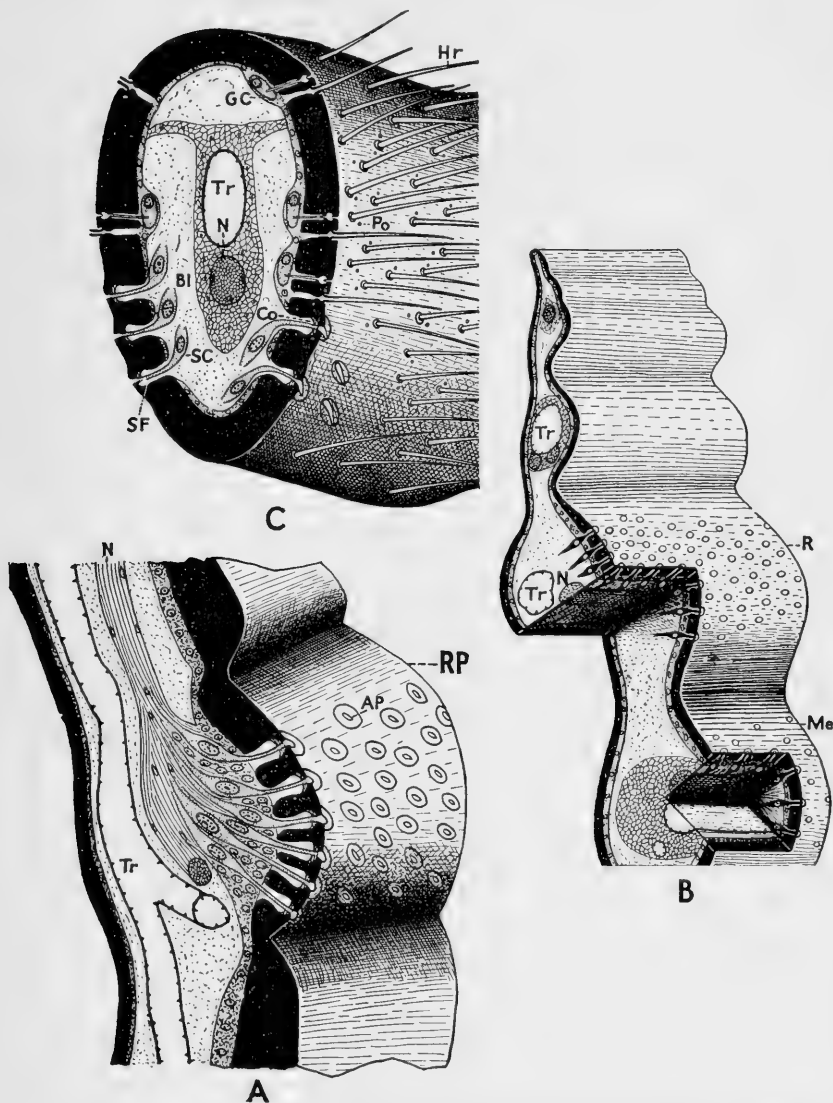

FIG. 10.—Diagrams showing portions of elytron, wing, and leg of adult beetles, to illustrate internal and external anatomy of these appendages and of olfactory pores and hypodermal glands. A, oblique transverse-longitudinal view of portion of peduncle of *Epilachna borealis*. The transverse portion passes through group 1 of the olfactory pores and radial plate (RP) in the direction of the line marked X in figure 8 B. B, transverse-longitudinal view of portion of wing of *Orthosoma*, passing through pores on radius (R) and media (Me). C, transverse-longitudinal view of proximal end of trochanter belonging to right hind leg of *E. borealis*, passing through group 6 of olfactory pores (4 pores on right) and group 5 (3 pores at left). Ap, pore aperture, BI, Blood; Co, chitinous cone; GC, hypodermal gland cell; Hr, noninnervated hair; N, nerve; Po, pore of hypodermal gland; SC, sense cell; SF, sense fiber; and Tr, trachea.

but the other so-called olfactory organs, which are nothing more than ordinary innervated hairs, are common only to the antennae of the adult, although similar innervated hairs are also found on other parts of both adult and larva. In the adult the olfactory pores were found on the head capsules, legs, elytra, wings, and mouth parts, and at the base of the antennae; in the larva, on the head capsule, base of antennae, mouth parts, clypeus, and second thoracic segment. The individual and sexual variations found in the pores were small, although the females have 13.7 per cent more pores than have the males.

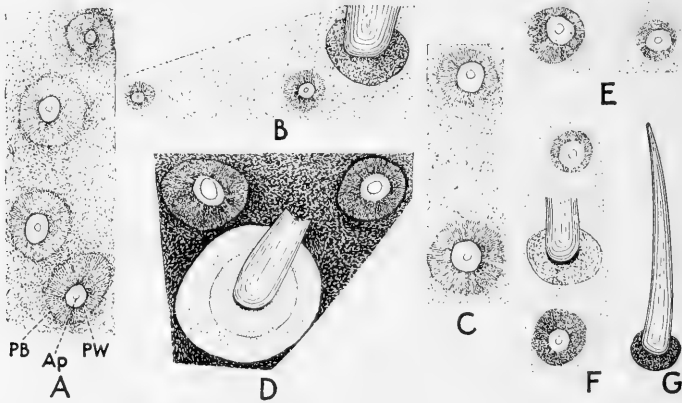

FIG. 11.—External view of single olfactory organs and noninnervated hairs on larva of *Cotinis nitida*, $\times 320$. A, 4 organs from trochanter, showing pore border (PB), pore aperture (Ap), and pore wall (PW). B, 2 organs and a hair from hypopleural region; C, 2 organs from maxilla; D, 2 organs and a hair from labrum; E, 2 organs from labium; F, 2 organs and a hair from epicranium; and G, a hair from first antennal segment.

On the larva of the green June beetle (*Cotinis nitida* L.) the writer (44) found the olfactory pores unusually numerous and consisting of two types. The single olfactory organs are isolated pores, not arranged in groups. They were found on the antennae, all mouth parts, head capsule, thorax, and legs, and average 1,359 pores per individual larva. This number is slightly more than the total number of pores found on the elytra, wings, and legs of an adult of the same species. Their external anatomy is unusual in that the pore border (fig. 11, PB) is radially striated, while the border around the hairs never shows striae. The compound olfactory organs (fig. 12) are variously shaped plates, each of which bears many apertures. They were found only on the distal halves of the last antennal segments. Figure 13 illustrates the internal anatomy of the single and compound organs.

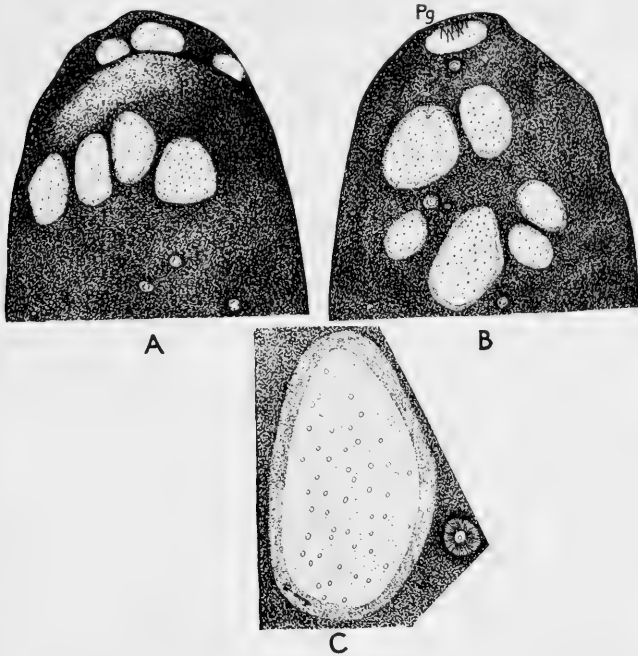

FIG. 12.—External view of compound and single olfactory organs and olfactory pegs on distal half of last antennal segment of larva of *Cotinis nitida*. A, 9 compound organs and 3 single ones on ventral side of antenna, viewed from a flat surface, $\times 100$; 2 of the compound organs at extreme tip are not shown. B, σ compound organs, 4 single ones, and 1 group of olfactory pegs (*Pg*) on dorsal side of antenna, viewed from a flat surface, $\times 100$. C, external view of a compound and a single organ, $\times 320$; the small circles represent pore apertures.

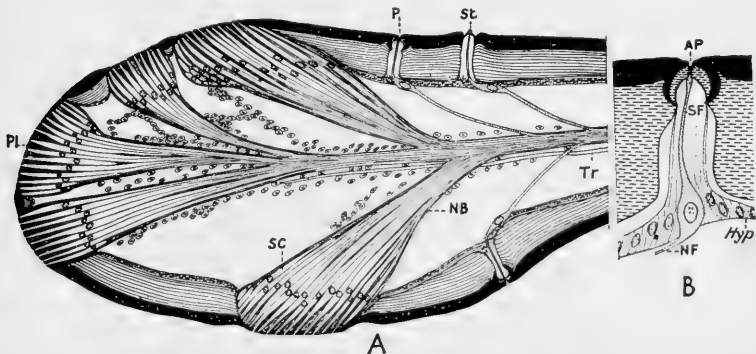

FIG. 13.—Internal anatomy of sense organs on antenna of larva of *Cotinis nitida*. A, longitudinal section through tip of antenna, showing innervation of compound (*Pl*) and single olfactory organs (*P*), and tactile hair (*St*); two-thirds diagrammatic, $\times 100$. (At this magnification the pore apertures are never discernible). B, cross section through single olfactory organ from antenna, $\times 500$. *Ap*, pore aperture; *Hyp*, hypodermis; *NB*, nerve branch; *NF*, nerve fiber; *SC*, sense cell; *SF*, sense fiber; and *Tr*, trachea.

The olfactory pores on several males and females of the Mexican bean beetle were examined, but they were actually counted on only one female, and these are illustrated in figures 6, 8, 9, 14, and 15. In this study only one totally new fact was learned. In all the previous studies on beetles, no olfactory pores were seen on the ventral side of the peduncles of the elytra, but in this position on the bean beetle 7 pores were seen on one elytron and 6 pores on the other. The groups

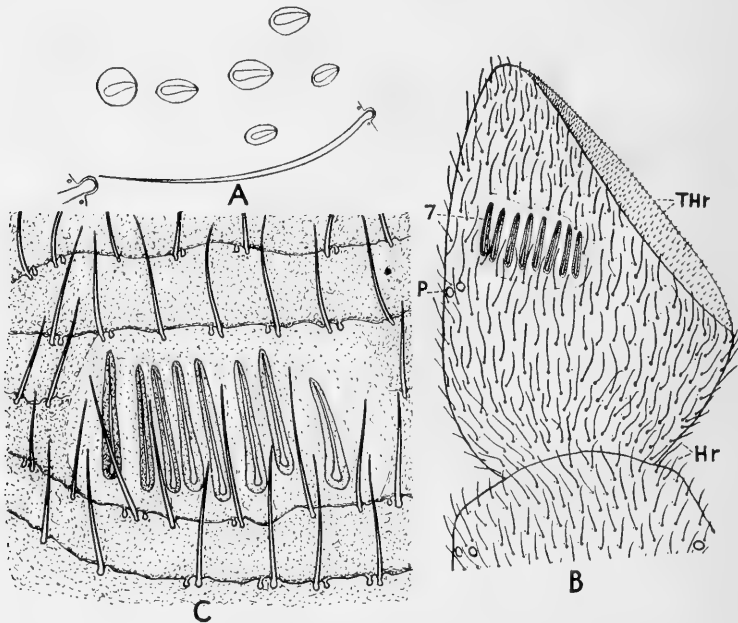

FIG. 14.—External view of chemoreceptors of adult Mexican bean beetle. A, noninnervated hairs and group 5 of olfactory pores on trochanter of front leg, $\times 500$. B, ventral surface of distal end of maxillary palpus, showing numerous noninnervated hairs (*Hr*) with their gland pores, isolated olfactory pores (*P*), group 7 of olfactory pores (*7*), and a plate bearing numerous so-called taste hairs (*Thr*), $\times 100$. C, group 7 of olfactory pores, markings on chitin, hairs, and gland pores, $\times 500$.

of pores are numbered, as usual, from 1 to 7, and small letters are used to indicate the position of some of the isolated pores. Group 1 on the elytra (fig. 8, A) contains 58 pores on the left peduncle and 65 on the right one. Groups 2, 3, and 4 on the dorsal surface of the wings (C) have as follows: Group 2, 58 and 64 pores; group 3, 43 and 38 pores; and group 4, 70 and 64 pores. Isolated pores on the wings are as follows: At *a*, 2 on the ventral side; at *b*, 8 on the dorsal side; at *c*, 1 on the dorsal side; and at *d*, 12 on the dorsal side and 8 on the ventral side. The number of pores in groups 5 and 6 and at *e*

and *f* on the legs (fig. 9) can be counted by inspection. Group 7, consisting of 8 slit-shaped pores, lies on the ventral surface of the terminal segment of the maxillary palpus. All the remaining pores counted are isolated ones found on the antennae and mouth parts. The total number of pores on all appendages of the same bean beetle are as follows: Wings 397, elytra 136, legs 95, maxillae 32, labium 14, antennae 8, mandibles 6, and labrum 4, making 692 in all. The

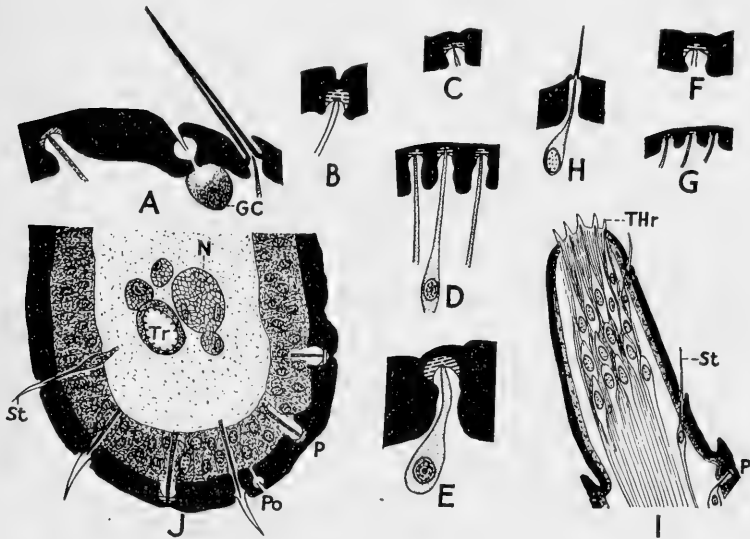

FIG. 15.—Internal structure of sense organs on adult Mexican bean beetle, $\times 500$. A, an olfactory pore, gland cell (*GC*), and sense hair from dorsal surface of labrum. B to G, olfactory pores; B, from mandible, C, from maxilla; D, from elytron; E, from trochanter; F, from tibia; and G, from wing. H, sense hair from trochanter. I, drawing, two-thirds diagrammatic, from longitudinal sections of distal end of labial palpus, showing innervation of so-called taste hairs (*THr*), tactile hairs (*St*), and olfactory pore (*P*). J, semidiagrammatic drawing from 3 cross sections through base of first antennal segment, showing tactile hairs (*St*), gland pore (*Po*), olfactory pore (*P*), trachea (*Tr*), and nerve (*N*).

fact that this number is small for an adult insect might be correlated with the fact that the bean beetle is "stupid" when the olfactory responses are considered.

The olfactory pores on several individuals of all four instars of bean-beetle larvae were examined. Since no differences in number and position were observed, the pores were carefully studied on only individuals of the fourth instar. They are illustrated in figure 16. The total number of pores on all appendages and the head are as follows: Legs 30, maxillae 12, head capsule 6, antennae 4, labrum 4,

labium 4, and mandibles 2, making 62 pores in all. The fact that this number is extremely low for any insect may help to explain why these larvae did not respond readily to odor stimuli.

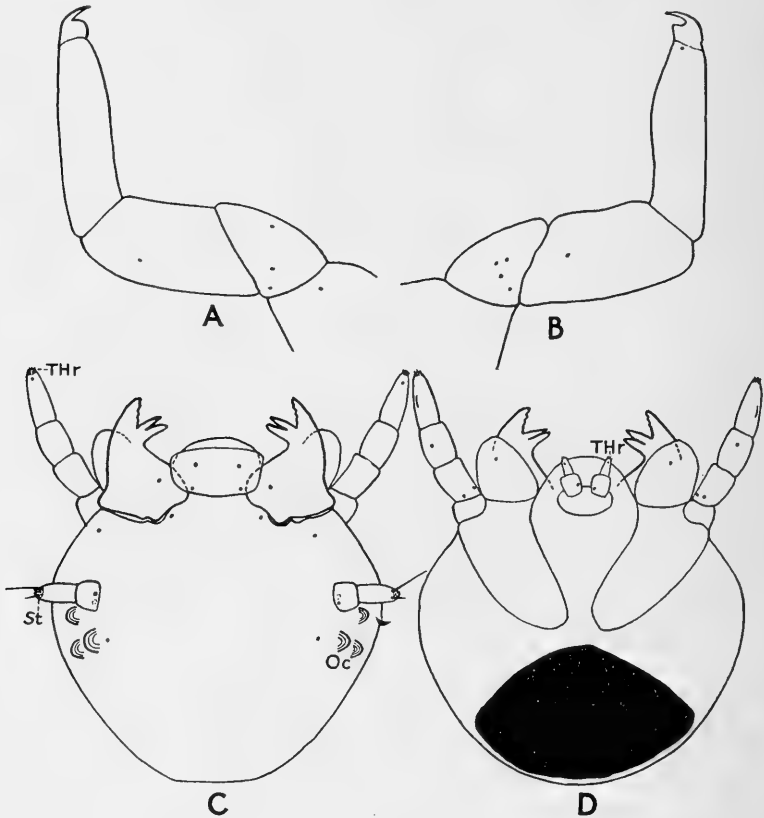

FIG. 16.—Position of olfactory pores (dots), 12 to 15 so-called taste hairs (*Thr*) at tip of each maxillary palpus, 8 tactile or so-called olfactory hairs (*St*) at tip of each antenna, and ocelli (*Oc*) on larva of bean beetle, $\times 32$. A and B, inner and outer sides respectively of right front leg. The number of pores on the legs is nearly constant, and they shift only slightly in position. C and D, dorsal and ventral surfaces respectively of the head and head appendages. On the base of each antenna one pore is on the dorsal side and one on the ventral side. On each terminal maxillary segment there is a slit-shaped pore.

2. SO-CALLED TASTE ORGANS

Several writers, particularly Nagel (58), have described certain tiny peglike hairs on the mouth parts of insects as taste organs, but no one has ever demonstrated that they perform such a function. Hochreuther (25) found many "Tast- und Geschmackszäpfchen" on the maxillary and labial palpi of the water beetle *Dytiscus margi-*

nalis. The earlier papers concerning the chemoreceptors of Coleoptera are reviewed by Deegener (see Schröder (72, pp. 150-151). Since Minnich's papers on the taste organs of butterflies and flies have recently been reviewed by the writer (47, pp. 36-39), they will not be discussed here. The reader should know, however, that according to the experiments conducted by Minnich certain butterflies bear so-called taste organs in their tarsi, and certain hairs on the proboscis of the blowfly serve as gustatory organs. The most recent paper by Minnich (55) discusses the chemical sensitivity of the legs of a blowfly.

The writer (46) described and illustrated many tiny peglike hairs found on the cotton boll weevil, but did not attribute a gustatory

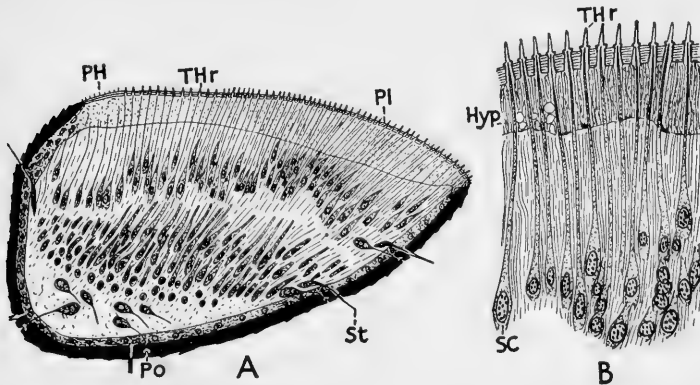

FIG. 17.—Internal anatomy through tip of maxillary palpus of adult Mexican bean beetle, showing following: *Hyp*, thick hypodermis; *PH*, pseudohairs; *PI*, soft plate; *Po*, gland pore connected with gland cell, which lies some distance from pore; *SC*, sense cells; *St*, tactile hairs; and *THR*, so-called taste hairs. A, drawing, two-thirds diagrammatic, $\times 300$; and B, semidiagrammatic, $\times 500$.

function to any of them. According to position, and possibly to structure, the ones on the tips of the labial and maxillary palpi are best suited to be taste organs. The same type of hairs was also found at the same place on both adult and larva of the Mexican bean beetle (figs. 14-17, *THR*). The ones at the tip of the maxillary palpus of the adult (fig. 14, B) are the most numerous and most conspicuous of any yet observed by the writer, and consequently they would appear to have some function other than that of touch. These tiny, thin-walled, and transparent hairs arise from a slightly convex plate, which is soft, flexible, and transparent. The number of hairs on the organ illustrated in figure 17 is about 447. An oblique cross section through the fourth or terminal maxillary segment is represented by figure 17,

A. The transparent plate (*Pl*) is bordered by tiny pseudo-hairs (*PH*) and the hypodermis (*B*, *Hyp*) just beneath the plate is very thick. Each hair is connected with a sense cell (*SC*) and these cells almost fill the lumen of the segment. The sense cells are very long and slender and have conspicuous nuclei.

Now, if aqueous solutions can pass quickly through the walls of these sense hairs in order to stimulate the nerves inside, these structures would be excellent taste organs. Or, if air can pass quickly to the nerves, they would then be olfactory organs. The fact that the bean beetle possesses two of these highly developed sense organs helps to explain how these insects were able to distinguish so readily between the various aqueous solutions and insecticides fed to them.

III. AUDIRECEPTORS

Since the writer (46, p. 1119; 47, p. 39) has already reviewed the literature on the sense of hearing in insects, no further review is necessary here, other than to cite the recent book by Eggers(14).

I. JOHNSTON ORGANS

In caustic-potash preparations of the antennae of the adult bean beetle the location of the Johnston organs may be determined by focusing downward with the microscope when looking at the distal end of the second antennal segment. A serrated structure (fig. 6, A and B, *J*) will be observed to encircle the segment. The distal ends of the sense cells are attached to this structure. In longitudinal sections the Johnston organs appear about as shown in figure 18, A. At the base of the second segment the nerve divides into two branches, which run directly to the sense cells (*SC*). Formerly the Johnston organs were assumed to be auditory in function, but more recently they have been called muscular receptors or statical-dynamic organs to register the movements of the antennae.

2. CHORDOTONAL ORGANS

Chordotonal organs very often accompany the Johnston organs, as illustrated by the writer in the cotton boll weevil; but none was found in the Mexican bean beetle. Many sections through the larvae were also made and studied, but no chordotonal or Johnston organs were found.

Since the writer has never reviewed the literature on the so-called auditory organs in larvae, the reader is referred to the paper by Hess (24) who gives a brief history of the chordotonal organs and de-

scribes them in cerambycid larvae. Hess determined that the pleural discs in these larvae are the points of attachment of abdominal chordotonal organs. Two of Hess's drawings (fig. 18, B and C) were copied to illustrate the internal structure of these organs in coleopterous larvae.

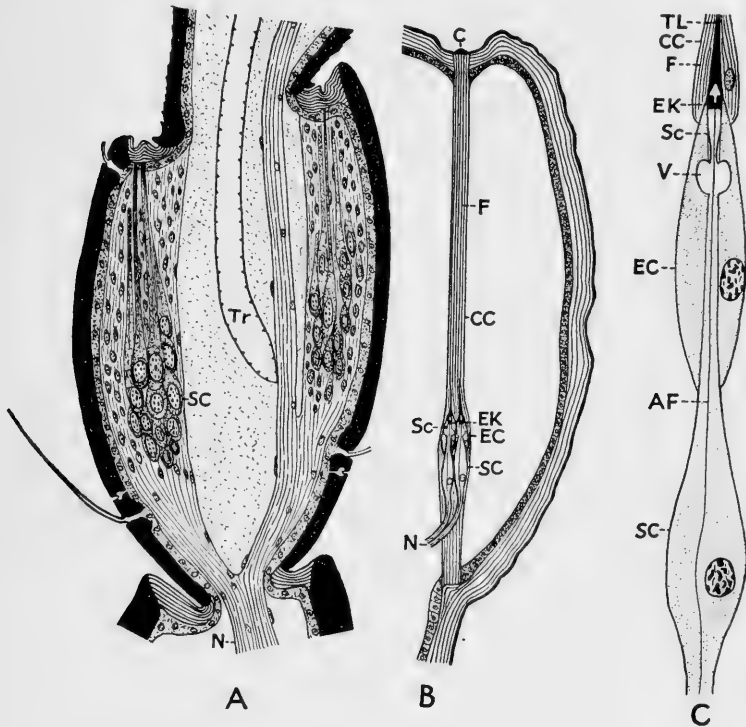

FIG. 18.—Internal anatomy of so-called auditory organs of beetles. A, drawing, two-thirds diagrammatic, from longitudinal sections through second antennal segment of an adult Mexican bean beetle, showing Johnston organs consisting of groups of sense cells (SC), $\times 500$. B and C (after Hess), longitudinal-vertical section of the pleural zone and chordotonal ligament from a larva of *Ergates spiculatus*, showing following: AF, axis fiber; C, chitinous cap; CC, cap cell; EC, enveloping cell; EK, end knob; F, fibrils of cap cell; N, chordotonal nerve; Sc, scolopale; SC, sense cell; TL, terminal ligament; and V, vacuole.

IV. THIGMORECEPTORS

I. TACTILE HAIRS

Hochreuther (25) made a thorough study of the sense hairs on a water beetle (*Dytiscus marginalis*). On the basis of external structure, he separated them into five divisions. Vom Rath (63, 64) found sense cells connected with all the small hairs on the maxillary palpi of *Coccinella septempunctata*, *Melolontha vulgaris*, and *Tenebrio*

molitor, and also with all the small hairs on the labial palpi of the last species. The present writer (46) found tactile hairs on the cotton boll weevil as follows: Sense hairs (*Sensilla trichodea*) on the head capsule, antennae, mouth parts, thorax, legs, wings and abdomen; sense bristles (*S. chaetica*) on nearly the same parts; and sense pegs (*S. basiconica*) on the head capsule, mouth parts, and genitalia.

In regard to tactile hairs on the Mexican bean beetles, all parts of the integument were not searched for them, but practically all the innervated hairs already discussed might be considered as touch hairs; however, the sense hairs (*Sensilla trichodea*) are considered to have no function other than that of touch. On the base of each antenna lie two groups of these hairs (figs. 6, B, and 15, J, *St*) and each trochanter bears one or two groups (fig. 9, C, and 15, H, *St*). They were also found on the maxillary and labial palpi (fig. 15, I, *St*) of the adult and on the head (fig. 16, C, *St*) of the larva.

C. SCENT-PRODUCING ORGANS AND REFLEX "BLEEDING"

The study of scent-producing organs follows as a corollary to that of tropisms and sensory receptors, and reflex "bleeding" is closely related to them. Since the sense of smell is such an important means of communication among insects, it is probably true that all insects have structures for producing odors. In fact these structures have already been described for most insect orders, and particularly for Coleoptera.

The writer (43) in 1917 reviewed the literature on this subject. A brief summary of that review concerning beetles follows: The simplest type of a scent-producing organ in beetles is composed of unicellular glands distributed over the entire body surface. In some beetles these unicellular glands are grouped and thus form glands varying considerably in complexity. In *Malachius* two pairs of caruncles serve as the scent-producing organs; unicellular glands lie in the walls of these structures. In *Dytiscus*, *Gyrinus*, and *Acilius* two different kinds of liquids issue from unicellular glands situated in the articular membranes between the thoracic segments. The liquid emitted at the femoro-tibial articulation during reflex "bleeding" of certain beetles seems to be secreted by two types of unicellular glands at this location. The highest type of scent-producing organ among insects is the anal glands of beetles. These have been found in several families.

In regard to the Mexican bean beetle, no careful search was made for the purpose of finding scent-producing organs other than the

unicellular glands distributed over the entire body surface. In fact this type of scent organ is the only one in lady-beetles known to the writer. The bean beetle, like other coccinellids, is well supplied with these glands. All parts of the body surface are covered with comparatively large hairs. Near the base of each hair there is usually one and sometimes two gland pores (figs. 6, 10, 14, 15, 17-19, *Po*). The large gland cells (figs. 10, C, and 15, A, *GC*) are variously constructed, but are always connected with reservoirs lying in the integument. In some of the smaller appendages, for example the maxillary palpi, where the available space is limited, the gland cells lie some distance from their pores and often nearly fill the lumen of the appendage.

The writer (42) in 1916 reviewed the literature on reflex "bleeding" in beetles and added further information by using the squash lady-beetle, *Epilachna borealis*. When disturbed certain coccinellid and meloid beetles fold the antennae and legs against the body, eject small drops of liquid from the femoro-tibial articulations, and feign death. There has been a controversy as to how the liquid is expelled so quickly and as to whether the liquid is blood or is a glandular secretion. The writer has now shown that in regard to the squash lady-beetle and the Mexican bean beetle (*E. corrupta*) the phenomenon is a true reflex, but that instead of the liquid being blood, it is a secretion from two types of hypodermal glands and that it passes to the exterior through innumerable tubes opening near and in the articular membrane. The gland pores of the first type, with reservoirs, lie in groups on the tarsi and around the femoro-tibial articulations. Two groups of these are located at the extreme proximal end of the tibia and two at the distal end of the femur around the articular membrane (fig. 19, A, *Po*). The gland pores of the second type, without reservoirs, lie in the articular membrane, marked *a* in figure 19. The discharge of the amber-colored secretion is accomplished by putting the gland cells under a high blood pressure. This is made possible by a muscular contraction in the femur whereby the blood is forced into a specially devised chamber containing the gland cells which belong to the pores in and near the femoro-tibial articulation. The glandular secretion is bitter and has an offensive odor. Its chief purpose is that of protection, but it probably also aids the beetles in recognizing the different individuals and sexes of the same species.

Hollande (26) in 1911 wrote a large paper in which he reviewed the literature on the phenomenon of discharging "blood" in insects and on the toxicity of this substance. He also added new information on these subjects. He reports that self-bleeding has been found in

Orthoptera, Hemiptera, Coleoptera, Diptera, Lepidoptera, and Hymenoptera. Under his general conclusions he states that some authors believe that the discharged liquid is blood, while others think it is a glandular secretion. The manner in which the liquid is discharged is little known, except in a few cases. In general it is admitted that the blood is discharged by a reflex action, being a means of defense. He discusses four methods in which the blood is discharged and gives

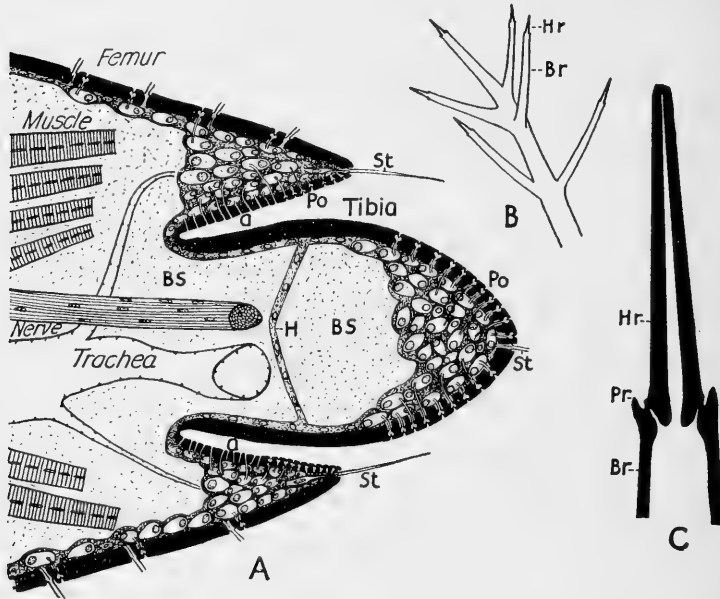

FIG. 19.—Drawings, illustrating reflex "bleeding" in lady-beetles. A, diagram of a section through femoro-tibial articulation of *Epilachna borealis*, showing following: *a*, pores of gland cells without reservoirs; *BS*, blood sinus; *H*, membrane dividing lumen of leg into two chambers; *Po*, pores of gland cells having reservoirs; and *St*, sense hairs. B and C, portion of tubercle on larva of bean beetle; B, distal end of tubercle having 6 branches (*Br*), each of which is terminated with a hair (*Hr*), $\times 32$; and C, distal end of a branch, showing hair arising from a socket, which is surrounded by 5 processes (*Pr*), only 2 being shown, $\times 320$.

examples of insects for each method. He further remarks that the ejected blood is usually very toxic.

While discussing coleopterous larvae, Hollande shows how coccinellid larvae protect themselves by discharging blood. As an example he used *Epilachna argus*, whose body is covered with chitinous tubercles, which in turn bear many smaller branches, each of which is terminated by a hair. The discharged blood is accomplished by a rupture of the chitin near the base of the hair. When one seizes the

larva with the fingers, the hairs pierce the epidermis on the fingers and are then broken off, causing the blood of the larva to exude as small drops.

The larvae of the bean beetle are likewise covered with hairlike tubercles (fig. 19, B), which bear many branches (*Br*); each of which is terminated by a hair (*Hr*). While picking up the larvae the writer observed a yellowish liquid on his fingers. This liquid was bitter and very distasteful. After carefully examining the larvae under a binocular, it was learned that the bitter liquid came from the tips of the branches (*C, Br*). Using a needle it was possible to touch the hairs (*Hr*) lightly, so that they broke at their weakest point; that is, at the socket which is surrounded by five processes (*Pr*).

SUMMARY

This paper is written as a complement to the writer's (47) former one entitled "Tropisms and Sense Organs of Lepidoptera," and contains information of a similar nature, but dealing with Coleoptera alone. A large mass of literature on the sense organs and tropisms of beetles, including papers on light traps, attractive baits, and repellents, has been consulted; but only the more important information found has been briefly summarized.

The Mexican bean beetle was selected to represent the Coleoptera. When tested to odor stimuli alone this beetle was found to be an unfavorable insect; but when the adults were allowed to come in contact with the substances to be tested as foods, the beetles clearly demonstrated their "likes" and "dislikes"; and when tested to light and gravity in a dark-room, the adults proved to be almost ideal for this purpose. In order to obtain comparative results which could be treated statistically, new technique and apparatus were devised, and the more important experiments were repeated many times under controlled conditions. The more important results obtained are as follows:

When tested in a phototactic box, which lay on a table by a south window in bright light, although not in direct sunshine, larvae of the first and second instars were weakly photopositive or indifferent to light. Most of the larvae of the third instar and the more active ones of the fourth instar were strongly photopositive. As a rule, the larvae up to the time of pupation were found to be photopositive, but when ready to pupate they became photonegative. Whether the negative reaction is caused by a change in the structure of the ocelli is not known. Hundreds of adult bean beetles were also tested and all proved to be photopositive, most of them being strongly so.

In a dark-room in which the temperature and relative humidity were fairly constant many tests were conducted to determine the difference between the phototactic and geotactic responses of adult bean beetles and their larvae, with and without the use of light. The insects were confined in a photo-geotactic box, just above or below which lay a water screen to prevent the infra-red or heat rays from reaching the beetles. Under these conditions the following results were obtained. For active, overwintering adult beetles the geonegative or upward response, when light was used, was 25.6 ± 0.20 per cent stronger than the geopositive or downward one; but when no light was used, it was 54.6 ± 0.17 per cent stronger, indicating that when the beetles were forced downward by the light this stimulus overcame about one-half of the geotactic one. Old beetles of the second brood did not respond so readily, yet their geonegative responses were stronger than their geopositive ones. Larvae of the third instar did not respond readily and they went up only slightly more than down. When light was used, active larvae of the fourth instar reacted as readily as did the overwintering adults; but when no light was used, they did not respond so readily, although they went up more than down.

While searching for attractants and repellents an improved feeding method was devised. The adult bean beetles were confined in four small wire-screen cages, each of which contained a row of the same four foods, but differently arranged. This series of tests, with the foods differently arranged each time, was then repeated three times in the forenoon, and usually the four series were again repeated in the afternoon. Each individual food used was therefore tested 16 times in the forenoon and usually 16 times in the afternoon. According to the arrangement of food, no two rows in the same cage were exactly alike; likewise, no two rows of all 16 rows were identical, although the distribution of food was not so complete. This plan was adopted in order to equalize the number of beetles counted on the same food which lay in all four positions during any one series of tests; and furthermore, everything possible was done to obtain reliable data which could be treated statistically. Using this plan the following results were obtained.

To determine whether bean beetles "like" or "dislike" the four classes of substances which produce the four human attributes of taste, many series of tests were conducted. It was soon learned that they have "likes" and "dislikes" in regard to food. They "disliked" water containing salts, acids, bitter materials, and saccharine; but "liked" the other sweet substances tested, including cane sugar,

grape sugar, table molasses, corn sirup, and black-strap molasses, and even showed preferences between them.

Bean foliage, sprayed with arsenicals, was repellent, but not sufficiently so to prevent the leaves from being eaten. Lead arsenate was most repellent; magnesium arsenate was less so; and calcium arsenate was least repellent. Bean foliage sprayed with sweetened arsenicals was more attractive than unsprayed foliage. Bean foliage sprayed with sweetened magnesium arsenate was more attractive than foliage sprayed with nonsweetened magnesium arsenate. This would indicate that it might be of economic importance to use sweetened arsenicals in control measures, particularly to poison the overwintering beetles early in the season.

In regard to the tropic receptors of the bean beetle, the following may be stated. The structure of the compound eyes and ocelli was not studied, but these organs are normally developed and seem to function adequately, so far as beetles are concerned.

Two kinds of so-called smelling organs—certain hairs on the antennae, and pores, called olfactory by the writer—are fully described. These hairs appear long and slender, have thin, almost transparent walls, and are connected with the sense cells. They are numerous and lie in five groups on the distal ends of the ninth, tenth, and eleventh segments. The olfactory pores on the adult beetle were found as usual on the elytra, wings, legs, mouth parts, and antennae. The total number counted was only 692. The pores on the larva lie on the head, antennae, legs, and mouth parts. The total number found was only 62. The fact that the total number of pores on both adult and larva is comparatively small might be correlated with the fact that this species is "stupid" when olfactory responses are considered.

A so-called taste organ was found at the tip of the maxillary palpus of the adult. It is a soft plate which bears about 447 tiny, thin-walled sense hairs. The fact that the bean beetle possesses two of these highly developed sense organs helps to explain how these insects were able to distinguish so readily between the various aqueous solutions and insecticides fed to them.

The only so-called auditory organ found in the bean beetle lies in the second antennal segment. These structures, called Johnston organs, were formerly assumed to be auditory in function, but now are believed to be muscular receptors to register the movements of the antennae.

The remaining receptors described are the tactile hairs, which are widely distributed over the surface of the beetle.

In connection with the receptors the scent-producing organs and the phenomenon of reflex "bleeding" were studied. The only scent-producing organ found was the unicellular glands, which are distributed over the entire body surface. The bean beetle, like other coccinellids, is well supplied with these hypodermal glands. The chief purpose of the secretion is that of protection, but it probably also aids the beetles in recognizing the different individuals and sexes of the same species. When disturbed the adults eject small drops of a glandular secretion from the femoro-tibial articulations. This is called reflex "bleeding." The larvae of the bean beetle also protect themselves in a similar manner. When they are handled or even touched the yellowish and bitter "blood" exudes from ruptures at the bases of the hairs, which terminate the branches on the tubercles.

LITERATURE CITED

- (1) ANONYMOUS
1923. Promising wireworm bait found. Official Record, July 18, p. 3.
- (2) ———
1923. A promising new bait. Fla. Entomologist 7:24.
- (3) ———
1927. Geraniol fatal lure to beetles. Official Record 6:8, Jan. 5.
- (4) BALLOU, C. H.
1929. Effects of geranium on the Japanese beetle. Journ. Econ. Ent. 22:289-293, 4 pls.
- (5) BARRETO, B. T.
1923. El gusano taladrador del tallo y otros insectos dañinos a la caña de azúcar. Segunda parte Los gusanos blancos. Agricultura, Sanitago de las Vegas 1 (3):2-3.
- (6) BORODIN, O.
1914. [Measures against elaterid larvae.] In Russian. [Chutorianin.] Poltava, no. 12, p. 382 (Rev. Appl. Ent. A, 2, pt. 6:344).
- (7) BREITENBECHER, J. K.
1918. The relation of water to the behavior of the potato beetle in a desert. (See "The Mechanism of Evolution in *Leptinotarso*," by W. L. Tower), Carnegie Inst. Pub., no. 263, pp. 341-384, illus.
- (8) CAMPBELL, R. E.
1924. Notes on injurious southwestern Tenebrionidae (Col.). Ent. News 35:1-7.
- (9) COLLINS, D. L., AND NIXON, M. W.
1930. Responses to light of the bud moth and leaf roller. N. Y. Agr. Exp. Sta. (Geneva) Bull. 583, 32 pp., 23 figs.
- (10) COOLEY, R. A.
1917. The spinach carrion beetle, *Silpha bituberosa*, Lec. Journ. Econ. Ent. 10:94-102, 1 pl.

- (11) CROZIER, W. J.
1924. On stereotropism in *Tenebrio* larvae. Journ. Gen. Physiol. **6**:531-539, 6 figs.
- (12) ———
1924. Wave-length of light and photic inhibition of stereotropism in *Tenebrio* larvae. Journ. Gen. Physiol. **6**:647-652, 1 fig.
- (13) DOWNES, W.
1927. Recent developments in strawberry root weevil control. Journ. Econ. Ent. **20**:695-698.
- (14) EGGERS, F.
1928. Die Stifführenden Sinnesorgane. Morphologie und Physiologie der chordotonalen und der tympanalen Sinnesapparate der Insekten. Bd. 2, Heft 1 of Schulze, Paul. Bausteine. Ausschnitte aus dem Gesamtgebiet der Zool., 354 pp., 149 figs. Gebrüder Borntraeger, Berlin.
- (15) FRENCH, C., JR.
1913. Insect pests of the potato. Journ. Dept. Agr. Victoria **11**:729-748, 13 pls.
- (16) FROST, S. W., AND DIETRICH, H.
1929. Coleoptera taken from bait-traps. Ann. Ent. Soc. Amer. **22**:427-437.
- (17) FULTON, B. B.
1928. Some temperature relations of *Melanotus* (Coleoptera, Elateridae). Journ. Econ. Ent. **21**:889-897, 1 fig.
- (18) GARMAN, P., AND ZAPPE, M. P.
1929. Control studies on the plum curculio in Connecticut apple orchards. Conn. Agr. Expt. Sta., Bull. 301: 371-437, illus.
- (19) GILMORE, J. U., AND MILAN, J.
1928. Control of the green June beetle in a tobacco field. Journ. Econ. Ent. **21**:677.
- (20) GOURDON, G.
1929. La destruction des insectes nuisible par les rayons "ultra-violet." Prog. Agr. Vitic. **91**:204-207, 1 fig.
- (21) GROSSMAN, E. F.
1929. Thermotropism of the Mexican cotton boll weevil. Journ. Econ. Ent. **22**:662-665.
- (22) HARNED, R. W.
1922. Annual report of the entomology department. 35th Ann. Rept. Miss. Agr. Expt. Sta., 1921-22, pp. 19-23.
- (23) HERMES, W. B.
1929. A field test of the effect of artificial light on the behavior of the codling moth, *Carpocapsa pomonella* Linn. Journ. Econ. Ent. **22**:78-88.
- (24) HESS, W. N.
1917. The chordotonal organs and pleural discs of cerambycid larvae. Ann. Ent. Soc. Amer. **10**:63-78, 4 pls.
- (25) HOCHREUTHER, R.
1912. Die Hautsinnesorgane von *Dytiscus marginal* L., ihr Bau und ihre Verbreitung am Körper. Ztschr. Wiss. Zool. **103**:1-114, illus.

- (26) HOLLANDE, A. Ch.
1911. L'autohémorrhée ou le rejet du sang chez les insectes (toxicologie du sang). Thèses a la Fac. Sci. Paris, 148 pp., 41 figs., 3 double pls.
- (27) HYDE, ARTHUR M.
1930. Japanese beetle. U. S. Dept. Agr. Yearbook, pp. 58-60.
- (28) ILLINGWORTH, J. F., AND JARVIS, E.
1918. Cane grub investigation. Queensland Agr. Journ. Ser. 2, 9:72-73.
- (29) JACK, R. W.
1920. Tobacco pests of Rhodesia. Part II. Rhodesia Agr. Journ. 17: 28-33, 5 pls.
- (30) ———
1927. Tobacco pests of Rhodesia, Rhodesia Agr. Journ. 24:1235-1246, 1928. 5 pls.; 25:13-25, 6 pls.
- (31) ———
1928. The lesser tobacco wireworms, Rhodesia Agr. Journ. 25:465-469, 1 pl.
- (32) ———
1928. Report of the Chief Entomologist for the year 1928. Rep. Secy. Dept. Agr. S. Rhodesia, p. 39-46.
- (33) JARVIS, E.
1916. A new light-trap for cane beetles. Queensland Agr. Journ. Ser. 2, 5:226-230, 1 fig.
- (34) ———
1916. On the value of poison bait for controlling cane grubs. Queensland Bureau of Sugar Expt. Sta., Div. Ent., Bull. 4, 14 pp., 1 pl.
- (35) ———
1924. The life history and control of insects affecting sugar-cane in North Queensland. Queensland Agr. Journ. Ser. 2, 21:28-33, 91-97.
- (36) ———
1925. Cane pest combat and control. Queensland Agr. Journ. Ser. 2, 24: 219-223.
- (37) LOEB, J.
1905. Studies in general physiology. Chicago, 423 pp., illus.
- (38) LOVETT, A. L.
1913. Insect pests of truck and garden crops. Oregon Agr. Expt. Sta., Ext. Bull. 91:1-39, illus.
- (39) MASAÏTIS, A. I.
1927. [On the study of elaterids in Siberia.] (In Russian) Izv. sibirsk. kraev. Stantz. Zashch. Rast., no. 2 (5), pp. 53-65. Tomsk, July, 1927. (Rev. Appl. Ent. A, 18, pt. 1: 6-7.)
- (40) MCCOLLOCH, J. W., AND HAYES, W. P.
1929. Some problems in the control of underground insects. Trans. 4th Int. Congress Ent. 2:306-315.
- (41) MCINDOO, N. E.
1915. The olfactory sense of Coleoptera. Biol. Bur. Mar. Biol. Lab. Woods Hole, 28:407-460, 3 figs., 2 pls.

- (42) McINDOO, N. E.
1916. Reflex "bleeding" of the coccinellid beetle, *Epilachna borealis*.
Ann. Ent. Soc. Amer. **9**:201-221, 2 pls.
- (43) ———
1917. Recognition among insects. Smithsonian Misc. Coll. **68**(2): 1-78.
- (44) ———
1918. The olfactory organs of a coleopterous larva. Journ. Morph. **31**:
113-131, 33 figs.
- (45) ———
1926. An insect olfactometer. Journ. Econ. Ent. **19**:545-571, 8 figs.
- (46) ———
1926. Senses of the cotton boll weevil—An attempt to explain how
plants attract insects by smell. Jour. Agr. Research **33**:
1095-1141, 16 figs.
- (47) ———
1929. Tropisms and sense organs of Lepidoptera. Smithsonian Misc.
Coll. **81** (10): 1-59, 16 figs.
- (48) McKINNEY, K. B., AND MILAM, J.
1926. The green June beetle larva in tobacco plant beds. U. S. Dept.
Agr., F. B. 1489, 5 pp., 4 figs.
- (49) MEHRHOF, F. E., AND VAN LEEUWEN, E. R.
1930. An electrical trap for killing Japanese beetles. Journ. Econ. Ent.
23:275-278, 2 figs., 2 pls.
- (50) MELANDER, A. L.
1923. Division of Entomology. Wash. Agr. Expt. Sta., Bull. 180,
pp. 26-29.
- (51) ——— AND SPULER, A.
1926. Poisoned baits for strawberry root weevil. Wash. Agr. Expt. Sta.,
Bull. 199, 22 pp., 8 figs.
- (52) METZGER, F. W.
1928. Information concerning Japanese beetle traps. N. J. Dept. Agr.,
Cir. 146, pp. 8, 5 figs.
- (53) ———
1930. Methods used in testing materials as repellents against the Japa
nese beetle. Journ. Agr. Research **40**:659-671, 6 figs.
- (54) ——— AND GRANT, D. H.
1930. The value of simudges as repellents for the Japanese beetle. Journ.
Econ. Ent. **23**:278-281, 1 pl.
- (55) MINNICH, D. E.
1929. The chemical sensitivity of the legs of the blow-fly, *Calliphora*
vomitaria Linn., to various sugars. Ztschr. verg. Physiol. Abt.
C. Ztschr. Wiss. Biol., Bd. 11, Heft 1, pp. 1-55, 11 figs.
- (56) MOORE, A. R., AND COLE, W. H.
1921. The response of *Popillia japonica* to light and the Weber-Fechner
law. Journ. gen. Physiol. **3**:331-335, 1 fig.
- (57) MOTE, D. C., AND WILCOX, J.
1927. The strawberry root-weevils and their control in Oregon. Oregon
Agr. Expt. Sta., Circ. 79, 24 pp., 13 figs.

- (58) NAGEL, W. A.
1894. Vergleichend Physiologische und anatomische Untersuchungen über den Geruchs- und Geschmackssinn und ihre Organe. Bibliotheca Zool. **18**:1-207, illus.
- (59) NEWMAN, L. J.
1929. The subterranean clover weevil (*Listroderes praemorsa*). Journ. Dept. Agr. W. Aust. **6**:29-36, 6 figs.
- (60) PETTIT, R. H.
1923. A repellent for flat headed borers. Journ. Econ. Ent. **16**:97-98.
- (61) POWER, F. B., AND CHESNUT, V. K.
1922. The odorous constituents of apples. II. Evidences of the presence of geraniol. Journ. Amer. Chem. Soc. **44**:2938-2942.
- (62) ——— AND KLEBER, C.
1896. On the chemical composition of the oil of sassafras bark and oil of sassafras leaves. Pharmaceutical Review **14**:101-104.
- (63) RATH, O. VOM
1888. Ueber die Hautsinnesorgane der Insekten. Ztschr. Wiss. Zool. **46**:413-454, illus.
- (64) ———
1896. Zur Kenntnis der Hautsinnesorgane und des sensiblen Nervensystems der Arthropoden. Ztschr. Wiss. Zool. **61**:499-539, illus.
- (65) REX, E. G.
1930. Facts pertaining to the Japanese beetle. N. J. Dept. Agr., Circ. 180, 31 pp., 10 figs.
- (66) RICHMOND, E. A.
1927. Olfactory response of the Japanese beetle (*Popillia japonica* Newm.). Proc. Ent. Soc. Wash. **29**:36-44.
- (67) ———
1927. A new phototropic apparatus. Journ. Econ. Ent. **20**:376-382, 1 pl., 2 figs.
- (68) ——— AND METZGER, F. W.
1929. A trap for the Japanese beetle. Journ. Econ. Ent. **22**:299-314, 4 figs., 3 pls.
- (69) RUNNER, G. A.
1919. The tobacco beetle: an important pest in tobacco products. U. S. Dept. Agr. Bull. 737, 77 pp., 16 figs.
- (70) SANDERS, J. G., AND FRACKER, S. B.
1916. Lachnosterna records in Wisconsin. Journ. Econ. Ent. **9**:253-261, 3 figs.
- (71) SCHOLL, E. E.
1916. Division of Entomology, Field Work. Ninth Ann. Rept. Commiss. Agr., Texas, pp. 11-15.
- (72) SCHRÖDER, CHR.
1912. Handbuch der Entomologie, Jena.
- (73) [SHCHEGOLEV, V. N.]
1925. [The use of poison baits in the control of tenebrionids.] In Russian—[Rostov-Nakhichevan-on-Don Regional Agr. Expt. Sta.], Bull. 195, 15 pp., 6 figs. Rostov-on-Don (summary in English). (Rev. Appl. Ent. A, 15, pt. 5: 212.)

- (74) SIEGLER, E. H., AND BROWN, LUTHER
1927. Can baits be used in scouting for injurious insects? Journ. Econ. Ent. **20**:428-429.
- (75) SMITH, L. B.
1922. Larval food habits of the Japanese beetle (*Popillia japonica* Newm.). Journ. Econ. Ent. **15**:305-310.
- (76) ———
1924. Japanese beetle reports. N. J. Dept. Agr. Bull. 41 and 45, pp. 1925. 55-63 and 59-75.
- (77) ———
1930. Asiatic beetles of three kinds, recent invaders, are studied. U. S. Dept. Agr. Yearbook, pp. 120-124, 3 figs.
- (78) ———
1930. The Japanese beetle in 1929. Journ. Econ. Ent. **23**:495-501.
- (79) ——— AND HADLEY, C. H.
1926. The Japanese beetle. U. S. Dept. Agr. Circ. 363, 66 pp., 36 figs.
- (80) SMITH, LONGFIELD
1916. Insects attacking sugar-cane. Report Agr. Expt. Sta. in St. Croix for 1914-1915, p. 24.
- (81) SNAPP, O. I., AND SWINGLE, H. S.
1929. Preliminary report on attractants for peach insects. Journ. Econ. Ent. **22**:98-101.
- (82) SNYDER, T. E.
1926. Preventing damage by *Lycetus* powder-post beetles. U. S. Dept. Agr. F. B. 1477, 12 pp., 10 figs.
- (83) SPULER, A.
1925. Baiting wireworms. Journ. Econ. Ent. **18**:703-707.
- (84) SWENK, M. H.
1923. The plains false wireworm and its control. Neb. Agr. Expt. Sta. Circ. 20, 11 pp., 3 figs.
- (85) TREHERNE, R. C.
1919. Wireworm control, with special reference to a method practised by Japanese growers. Agr. Gaz. Canada **6**:528-530.
- (86) ———
1923. Wireworm control. Canada Dept. Agr., Ent. Branch, Pamphlet N. S. No. 33, 6 pp., 3 figs.
- (87) VAN LEEUWEN, E. R.
1926. A preliminary note on the attractiveness of acetic acid to the Japanese beetle. Journ. Econ. Ent. **19**:190.
- (88) ———
1930. Japanese beetles are caught plentifully in geraniol-baited traps. U. S. Dept. Agr. Yearbook, pp. 334-336, 3 figs.
- (89) ——— AND METZGER, F. W.
1930. Traps for the Japanese beetle. U. S. Depart. Agr. Circ. 130, pp. 16, 6 figs.
- (90) ——— EL AL.
1928. Some phases of the Japanese beetle insecticide investigations. Journ. Econ. Ent. **21**:805-813, 2 pls.

- (91) VAN ZWALUWENBURG, R. H.
1918. Report of the entomologist. Rept. Porto Rico Agr. Expt. Sta. for 1916, pp. 25-28.
- (92) VICKERY, R. A., AND WILSON, T. S.
1919. Observations on wingless May beetles. Journ. Econ. Ent. **12**: 238-247, 2 pls.
- (93) WAKELAND, C.
1923. Practical control of *Eleodes hispilabris* over an extensive area. Journ. Econ. Ent. **16**:96.
- (94) WEISS, H. B.
1913. Notes on the negative geotropism of *Corythuca ciliata* Say, *Adalia bipunctata* Linn., *Coccinella 9-notata* Hbst. and *Megilla fuscilabris* Muls. Journ. Econ. Ent. **6**:407-409.
- (95) WELDON, G. P.
1915. Potatoes as a trap-crop for wireworms. Monthly Bull. State Commis. Hortic., Calif. **4**:374.
- (96) WILLIAMS, C. B.
1924. An improved light trap for insects. Bull. Ent. Research **15**: pt. 1, 57-60, 2 figs.
- (97) WODSEDALEK, J. E.
1913. The reactions of certain Dermestidae to light in different periods of their life history. Journ. Animal Behav. **3**:61-64, 1 fig.

EXPLANATION OF PLATES

PLATE 1

Photographs taken at the Japanese Beetle Laboratory in New Jersey, showing hundreds of Japanese beetles attracted by geraniol; 1, loaned by the Japanese Beetle Laboratory, and 2, by Van Leeuwen *et al.*

1. When cloths (1 foot square) were dipped in a 10 per cent emulsion of geraniol and suspended in orchards, beetles were drawn as if by a magnet. Some of the attracted beetles, shown in the photograph, are on the cloth, but most of them lie on the peach tree.
2. It was discovered that the beetles would gorge themselves upon foliage, sprayed with a mixture of lead arsenate and sugar, on trees to which they had been attracted by geraniol.

PLATE 2

Photographs taken at the Japanese Beetle Laboratory, showing an electric trap which attracts and kills Japanese beetles. (After Mehrhof and Van Leeuwen.)

1. The trap rests on supports 4-1/2 feet high. A 250-Watt step up transformer, a resistance coil, and a condenser lie in the box under the trap. Several dead beetles may be seen below the trap. The danger sign was placed on the trap to prevent outsiders from molesting it.
2. Near view of the trap, showing its construction and the bait inside. The most effective bait was geraniol emulsion, sprayed on peach foliage which was suspended in the center of the trap.



1



B

2

For explanation, see page 70.

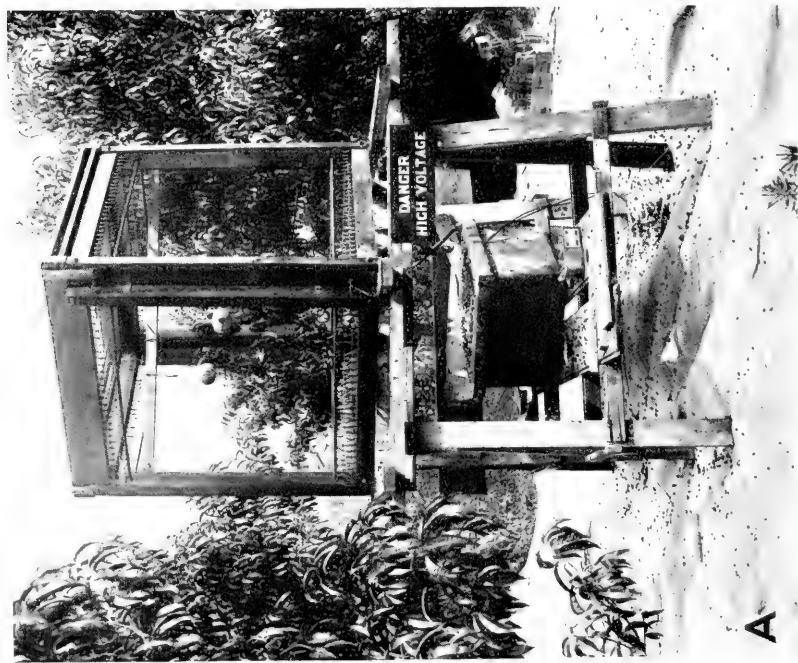

1

For explanation, see page 70.

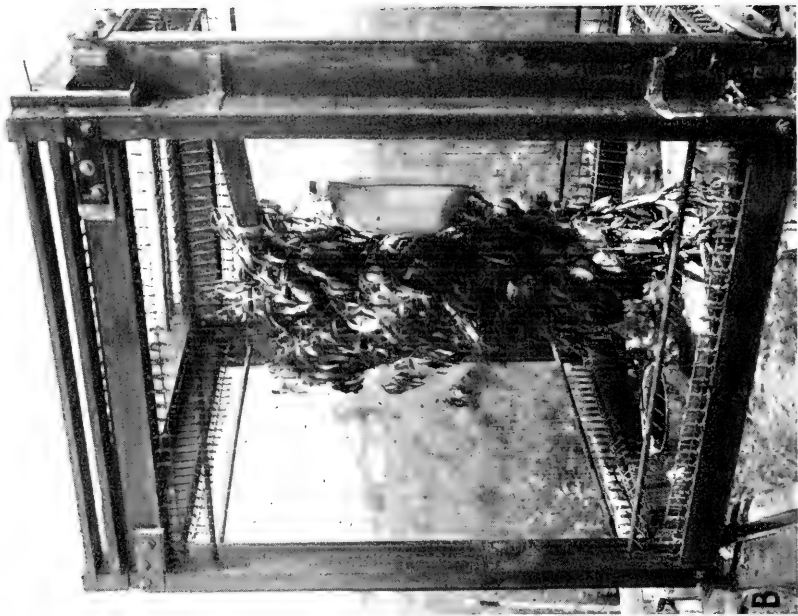

2



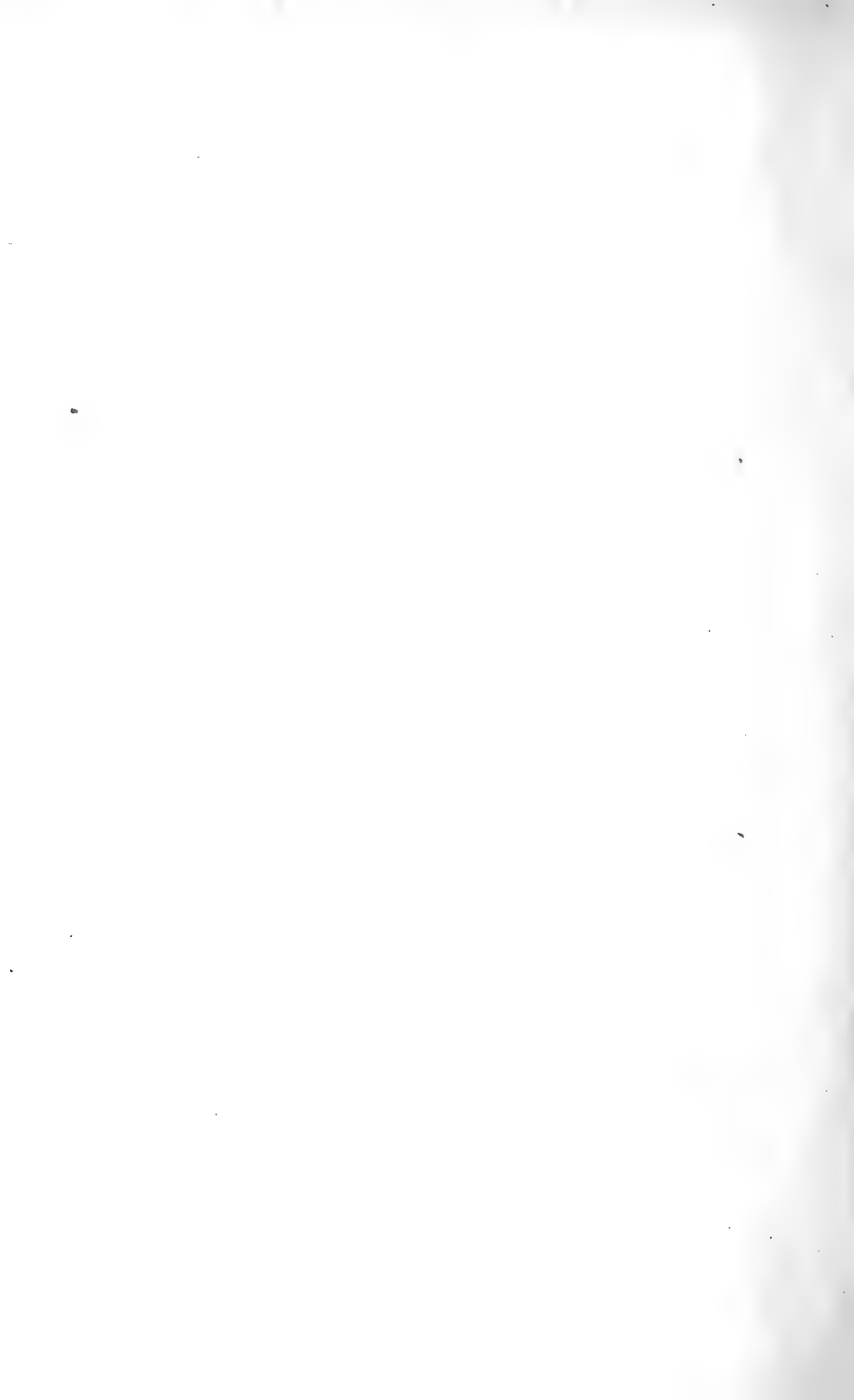





SMITHSONIAN INSTITUTION LIBRARIES



3 9088 01421 4704