

J. Ray Thompson
~~17 S. Hancock St~~

Madison, Wis

B

UNIVERSITY OF CALIFORNIA
AT LOS ANGELES

Pl



bound.

Soi
Soi

EX LIBRIS

GIFT OF
Arthur M. Joanson

W. Johnson



Digitized by the Internet Archive
in 2007 with funding from
Microsoft Corporation

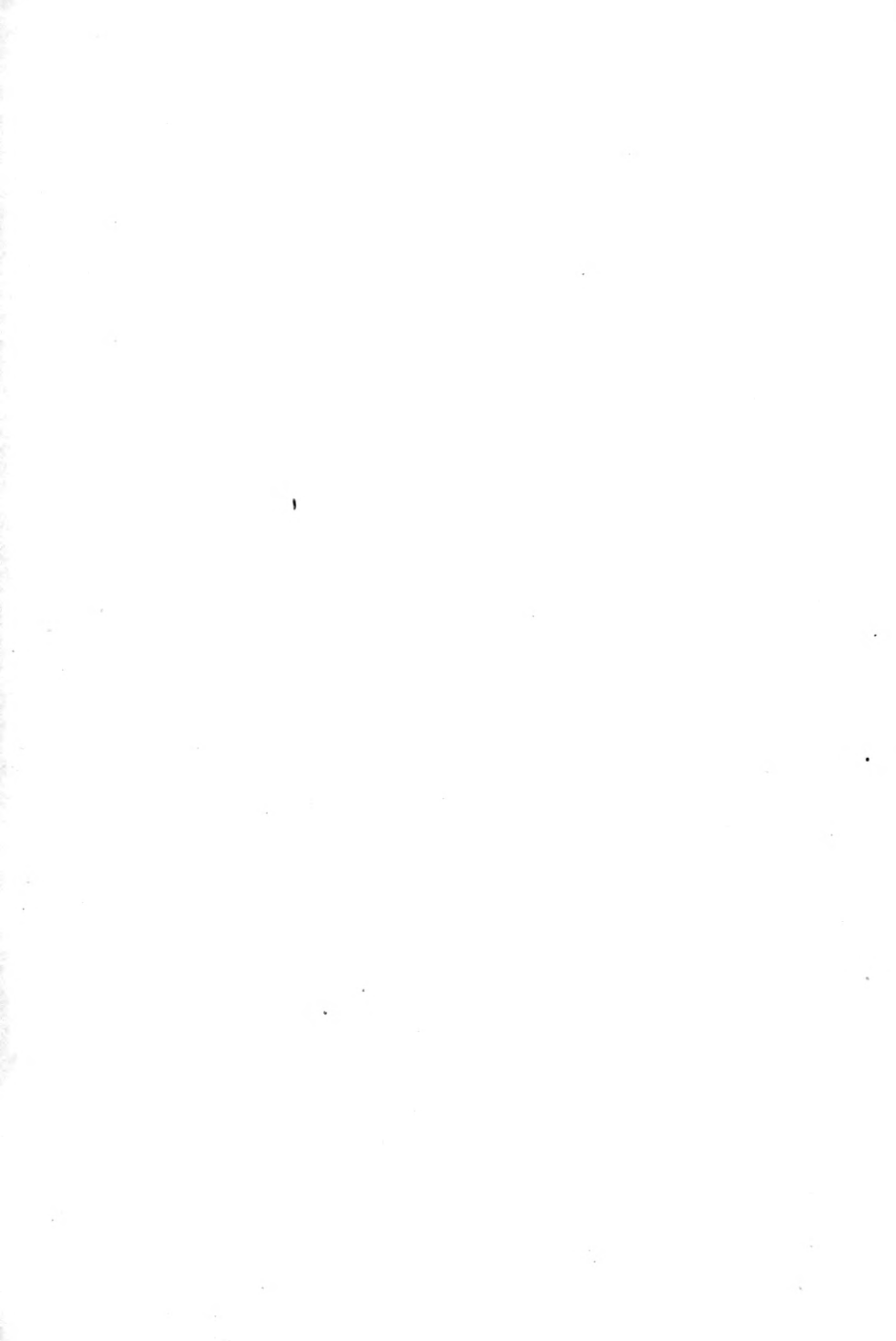

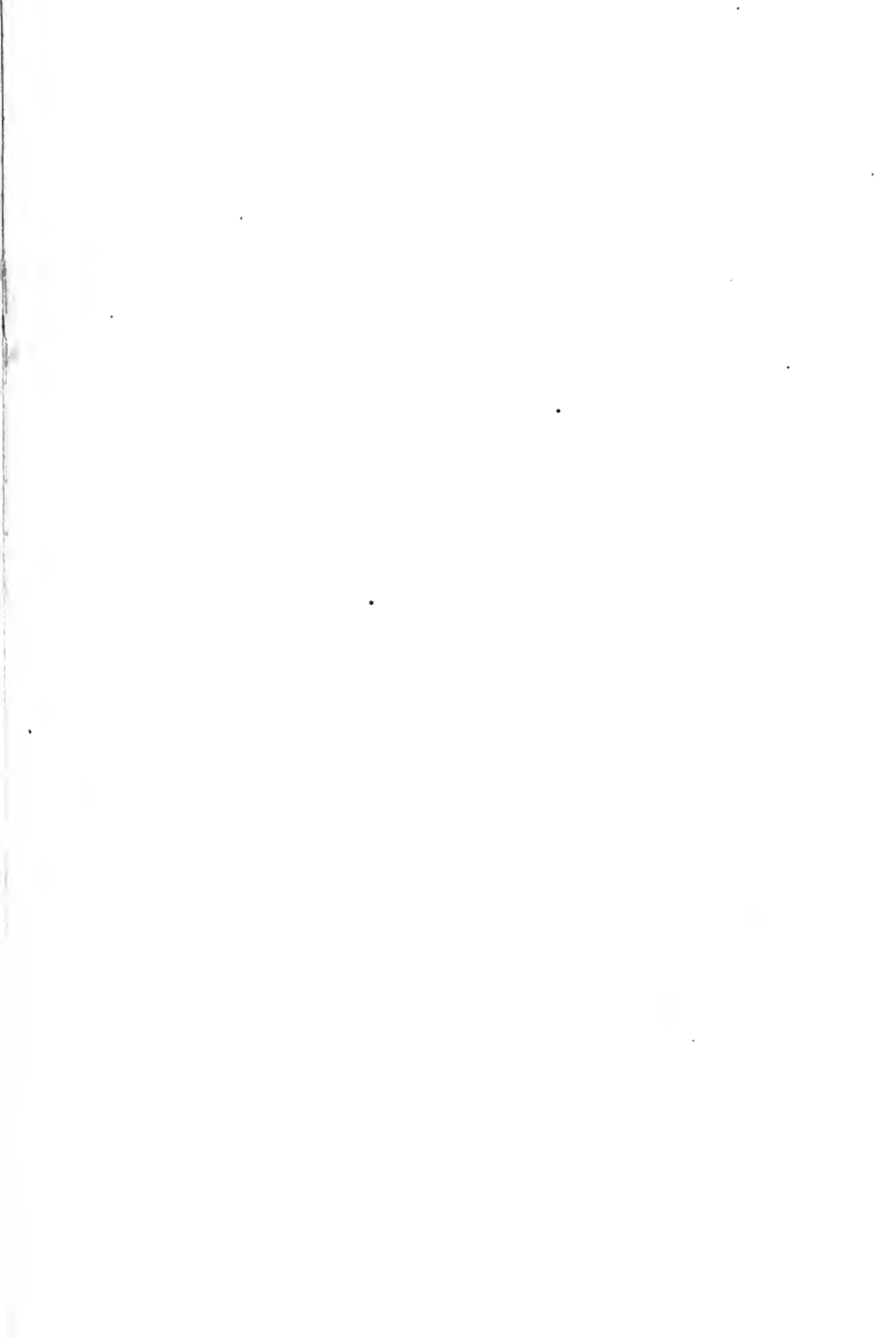



Map showing the soil provinces and soil regions of the United States



Bureau of Soils, Bul. 96, 1913. (Courtesy The Macmillan Company.)



LIPPINCOTT'S COLLEGE TEXTS
AGRICULTURE

EDITED BY K. C. DAVIS, PH.D. (CORNELL)

SOIL PHYSICS AND
MANAGEMENT

BY

J. G. MOSIER, B.S.

PROFESSOR OF SOIL PHYSICS, UNIVERSITY OF ILLINOIS; CHIEF OF SOIL PHYSICS,
AGRICULTURAL EXPERIMENT STATION

AND

A. F. GUSTAFSON, M.S.

ASSISTANT PROFESSOR OF SOIL PHYSICS, UNIVERSITY OF ILLINOIS; ASSISTANT
CHIEF OF SOIL PHYSICS, AGRICULTURAL EXPERIMENT STATION

202 ILLUSTRATIONS IN THE TEXT



PHILADELPHIA & LONDON
J. B. LIPPINCOTT COMPANY

COPYRIGHT, 1917, BY J. B. LIPPINCOTT COMPANY

*Electrotyped and Printed by J. B. Lippincott Company
The Washington Square Press, Philadelphia, U. S. A.*

WOLFE TO VINE
ALPHA 20.17A

S591

M955

PREFACE

THIS book is written for three purposes: first, as a text-book for agricultural students; second, as a reference book for the practical farmer; and, third, as an aid to the land owner who desires information in the personal management of his land.

Soil physics is the application of physics to soils. It is so closely related to other sciences that it becomes necessary to trespass upon the ground of some of them, notably botany, geology, chemistry, and zoölogy, to present certain subjects clearly and completely. Soil physics dovetails in with the closely-related phases of agronomy, as soil biology, soil fertility, crop production, and agricultural engineering, to such an extent that it is necessary to give material very closely related to all of these.

An attempt has been made to emphasize the principles of soil physics, omitting the details of practice except where necessary for purposes of illustration. Although the book is written in the Middle West, yet the principles given apply anywhere.

The arrangement of the matter presented has been carefully planned from the teaching standpoint, and has been tested in the classroom for several years.

Various sources of information have been used by the authors and acknowledgment made accordingly.

J. G. MOSIER,

A. F. GUSTAFSON.

College of Agriculture,
University of Illinois,
Urbana, Ill., October, 1917.

442928

Gift of A. M. Johnson 10-5-43



CONTENTS

CHAPTER	PAGE
<p>I. SOIL MATERIAL AND ITS ORIGIN.....</p> <p style="padding-left: 2em;">Definition of Soil—Elements of the Earth's Crust—Soil Forming Minerals—Rocks—Igneous Rocks—Aqueous Rocks—Metamorphic Rocks.</p>	1
<p>II. WEATHERING.....</p> <p style="padding-left: 2em;">Physical Agencies—Heat and Cold—Freezing and Thawing—Glaciers—Erosion of Streams—Waves—Wind—Plants—Chemical Agencies—Acids—Carbon Dioxide—Oxidation—Deoxidation—Hydration—Solution—Plants—Animals.</p>	11
<p>III. THE PLACING OF SOIL MATERIAL. I. RESIDUAL, GRAVITY-LAID AND WATER-LAID DEPOSITS.....</p> <p style="padding-left: 2em;">Sedentary Formations—Residual Soils—Cumulose Soils—Swamps and Marshes—Transported Formations—Colluvial or Gravity-laid Soils—Sedimental or Water-laid Soils.</p>	27
<p>IV. THE PLACING OF SOIL MATERIAL. II. GLACIAL OR ICE-LAID DEPOSITS.....</p> <p style="padding-left: 2em;">The Glacial Period—The Jerseyan or Nebraskan Glaciation—The Kansan Glaciation—The Illinoisan Glaciation—The Iowan Glaciation—The Early Wisconsin Glaciation—The Late Wisconsin Glaciation—Incidental Features.</p>	41
<p>V. THE PLACING OF SOIL MATERIAL. III. EÖLIAL OR WIND-LAID DEPOSITS.....</p> <p style="padding-left: 2em;">Classes of Wind-laid Material—Dunes—Loess—Adobe—Volcanic Dust.</p>	53
<p>VI. SOIL AND SUBSOIL.....</p> <p style="padding-left: 2em;">The Top Soil—Surface—Subsurface—Subsoil—Tight Clay—Hard Pan—Humid and Arid Subsoils—Plow Sole.</p>	67
<p>VII. CLASSIFICATION OF SOILS.....</p> <p style="padding-left: 2em;">Need of Classification—Basis of Classification—Geological—Lithological—Temperature—Moisture—Arid Soils—Humid Soils—Vegetation—Color—Texture.</p>	72
<p>VIII. CLASSIFICATION BY THE BUREAU OF SOILS.....</p> <p style="padding-left: 2em;">Soil Province—Soil Region—Soil Class—Soil Type—Piedmont Plateau Province—Appalachian Mountain and Plateau Province—Limestone Valleys and Uplands Province—Glacial and Loessial Province—Glacial Lake and River Terrace Province—Atlantic and Gulf Coastal Plains Province—River Flood Plains Province—Great Plains Region—Rocky Mountain and Plateau Region—Northwestern Intermountain Region—Great Basin Region—Arid Southwest Region—Pacific Coast Region.</p>	78

IX. SUB-PROVINCES, CLASSES, TYPES, AND SURVEYS	112
Sub-provinces—Soil Classes—Soil Types—Naming of Soil Types—Classes, Types, and Phases in Illinois—Soil Surveys—Surveys in Different States—Objects of a Soil Survey—Methods of the Survey—Sampling of Soils.	
X. MINERAL CONSTITUENTS.....	123
Soil Particles and Their Separation—Mechanical or Physical Analysis—Methods of—Mineral Soil Constituents and Their Properties—Colloids—Colloids in Soils—Mineral Colloids—Clays and Clay Loams—Silt and Silt Loams—Sands and Sandy Loams—Gravel and Gravelly Loams—Stones.	
XI. ORGANIC CONSTITUENTS OF SOILS.....	142
Kinds of Organic Matter—Amount of Organic Matter in Soils—Changes of Organic Matter—Nitrogen Content of Humus—Distribution of Organic Matter in the Soil Strata—Value of Organic Matter to Soils—Losses of Organic Matter—Estimation of Organic Matter.	
XII. MAINTAINING AND INCREASING THE ORGANIC-MATTER CONTENT OF SOILS.....	158
Addition of Limestone—Application of Phosphorus—Accumulations in Pastures—Green Manures—Catch and Cover Crops—Barnyard Manures—Loss of Manure and Its Prevention—Methods of Applying Manure—Organic Residues—Growing Non-tilled Crops—Rotation of Crops.	
XIII. PHYSICAL PROPERTIES OF SOILS.....	175
Real or Absolute Specific Gravity—Apparent Specific Gravity—Weight of the Soil—Color of Soils—Odor of Soils—Number of Particles—Shape of Particles—Arrangement of Particles—Internal Area of Surface—Porosity of Soils.	
XIV. WATER OF SOILS.....	186
Some Physical Characteristics of Water—Specific Heat—Viscosity—Uses of Water—Amount of Water Required by Plants—Dependent Upon Transpiration—Supply of Moisture in Soils—Ways of Expressing Moisture Content.	
XV. WATER OF SOILS. I. HYGROSCOPIC MOISTURE.....	194
Determination of Hygroscopic Coefficient of Soils—Use of Hygroscopic Moisture.	
XVI. WATER OF SOILS. II. CAPILLARY WATER.....	199
Surface Tension—Moisture in Soil Columns—Effect of Size of Soil Particles—Moisture Equivalent—Determination of Moisture Equivalents from Other Soil Constants—Movement—Thickness of the Film—Viscosity—Texture—Organic Matter—Maximum Capillary Capacity or Moisture-holding Capacity of Soils—Amount of Water Moved by Capillarity—The Capillary Pull of Soils—Osmosis in Soils—Use of Capillary Water—Wilting Coefficient—Available Moisture.	
XVII. WATER OF SOILS. III. GRAVITATIONAL WATER.....	217
Percolation—Physical Composition or Texture—Granulation—Organic Matter—Viscosity—Atmospheric Pressure—Shrinkage Cracks—Roots of Plants—Lysimeters or Drain Gages.	

XVIII. CONTROL OF MOISTURE. I. DRAINAGE.....	222
Removal of Excess of Water—Stability—Granulation—Available Moisture—Aëration—Temperature—Decomposition and Nitrification—Heaving—Erosion—Types of Drainage—Open Drains—Tile Drains.	
XIX. CONTROL OF MOISTURE. II. TILLAGE.....	230
Moisture Capacity of Soils—Excess of Moisture—Losses from Soils—Artificial and Soil Mulches—Fineness of Mulch—Depth of Mulch—Maintenance of Mulch.	
XX. CONTROL OF MOISTURE. III. DRY-LAND AGRICULTURE.....	238
Adaptation of a Region to Dry Farming—Water Requirements of Plants—Loss of Water—Method of Preventing Loss of Water—Tillage—System of Cropping—Crops for Dry Farming—Seeding—Acclimated Seed.	
XXI. CONTROL OF MOISTURE. IV. IRRIGATION.....	257
Area and Projects—Sources of Water—Preparation of Land for Irrigation—Character of Water Used for Irrigation—Composition of River Sediments—Time of Irrigation—Amount of Water to Apply—Loss of Water from Canals—Duty of Water—Duty of Water in Different Countries—Measurement and Distribution of Water—Methods of Irrigation—Cultivation after Irrigation—Crops for Irrigated Lands—Irrigation in Humid Climates.	
XXII. ALKALI LANDS AND THEIR RECLAMATION.....	278
Origin of Alkali—Kinds of Alkali—Effect on Physical Condition of Soil—Vertical and Horizontal Distribution—Effect of Irrigation on Rise of Alkali—Effect of Alkali on Plants—Limit for Germination and Growth—Utilization and Reclamation of Alkali Lands—Growing Alkali-resistant Crops—Retarding Evaporation—Deep Plowing and Turning Under Alkali—Neutralizing Black Alkali—Removing the Salts from the Soil—Hardpan—Value of Alkali Land—Alkali Soils of Humid Regions.	
XXIII. TEMPERATURE.....	293
Sources of Soil Heat—Direct Radiation from the Sun—Precipitation—Chemical Changes—Physical Changes—Loss of Heat—Radiation—Conduction into the Soil—Evaporation of Water—Convection Currents of Air—Soil Temperature for Vital Functions of Plants—Temperature for Germination—Temperature for Growth—Temperatures Favorable for Osmosis and Diffusion—Temperatures for Nitrification—Conditions Affecting Soil Temperature—Specific Heat—Evaporation of Water—Drainage—Presence of Water—Absorption and Radiation of Heat—Latitude or Angle of Sun's Rays—Conductivity of Soil Material and Soils—Tillage.	
XXIV. SOIL AIR AND AERATION.....	309
Use of Air in Soils—Amount of Air in Soils—Composition of Soil Air—Aëration or Soil Ventilation—Water-logged Soil—Running Together.	

XXV. SOIL ORGANISMS.....	315
Macro-organisms—Rodents—Insects—Worms—Plants— Micro-organisms—Injurious Organisms—Beneficial Organ- isms—Distribution and Conditions for Their Activity— Distribution—Conditions for Development—Loss of Ni- trates—Leaching—Denitrification.	
XXVI. TILLAGE.....	325
Objects of Tillage—Pulverizing and Loosening the Soil —Turning Under Vegetable Matter—Killing Weeds— Storing and Conserving Moisture—Compacting the Soil —Planting the Seed—Implements of Tillage—Plows— Harrows—Compactors—Seeders—Cultivators—Plowing— Time of Plowing—Depth of Plowing—Dynamiting—Effect of Deep-rooting Crops—Preparation of the Seed Bed— Wheat—Corn—Oats—Cultivation—Value of Mulch— Root Injury—Level Cultivation.	
XXVII. SOIL EROSION.....	358
Cause of Erosion—Effect of Topography—Texture and Structure of the Soil—Vegetative Covering—Character of the Rainfall—Results of Erosion—Removal of Organic Matter and Nitrogen—Changes Physical Character of Soil—Changes of Color—Kinds of Erosion—Sheet Erosion —Methods of Prevention and Reclamation—Application of Limestone—Protection by Crops—Residues—Increas- ing the Organic Matter—Deep Contour Plowing—Contour Seeding—Terraces—Reforestation—Tiling—Gullying— Methods of Prevention and Filling—Straw-brush—Dams —Vegetation—Filling with Soil.	
XXVIII. ROTATION.....	376
Advantages of Rotation—Better Distribution of Work— Control of Insects and Plant Diseases—Control of Weeds— Variation in Depth of Root Systems—Maintenance of Good Tilth—Maintenance of Organic Matter—Toxic Substances—Increased Yields—Planning a Rotation— Places in Rotations for Crops—Practical Rotations—Corn and Winter Wheat Belt—Cotton Belt—Hay and Pasture Province—Spring Wheat Region—Great Plains Province.	
APPENDIX I. SOIL FERTILITY.....	389
Permanent Agriculture—Are Soils Inexhaustible?—Plant Food Elements—Removal of Plant Food—Crop Require- ments—Supply of Plant Food in Soils—Nitrogen— Phosphorus—Potassium—Other Elements.	
APPENDIX II.....	407
Average Yield of Crops Per Acre by States in United States, Ten-year Average, 1906-1915—Average Yield of Wheat Per Acre for Ten Years, 1905-1914, United States and European Countries.	
APPENDIX III.....	410
Farm Land Value Per Acre—Farm Property Value—Corn Acreage—Corn Production—Oats Production—Spring Wheat Acreage—Winter Wheat Acreage—Wheat Produc- tion.	

ILLUSTRATIONS

FIG.	PAGE
Map Showing the Soil Provinces and Soil Regions of the United States.....	<i>Frontispiece</i>
1. Limestone Composed Chiefly of Shells of Brachiopods.....	9
2. Limestone Containing Large Amounts of Crinoid Stems.....	9
3. Irregular Weathering of Rock Due to Joints and Stratification.....	11
4. A More Advanced Stage of Weathering.....	12
5. "Capitol Rock," Butte, Montana.....	12
6. Exfoliated Granite in the Sierra Nevadas, California.....	13
7. Columbia Glacier Overriding a Forest, Alaska.....	14
8. Front of Columbia Glacier in 1910 Compared in Height to Bunker Hill Monument.....	15
9. The Material Carried and Rolled by Streams Gives Them Their Great Eroding Power.....	16
10. Inner Gorge of Grand Cañon of the Colorado River, Arizona.....	17
11. Wind-carved Granite.....	18
12. The Roots of Trees Form Wedges for Prying Rocks Apart.....	19
13. Stalactites and Stalagmites Formed in a Cavern from Limestone Dissolved by Carbonated Water While Passing Through the Rocks Above.....	23
14. Sinkholes in a Cave Region—Southern Illinois.....	24
15. The Outlets of Sinkholes Sometimes Become Clogged and "Sinkhole" Ponds Result.....	24
16. Ox-bow Lakes Formed by Shifting of Channel.....	28
17. Typical Eastern Swamp Land.....	29
18. Florida Everglades.....	29
19. Section Showing One Step in the Filling of the Lake with Peat.....	29
20. Hummocks 6 to 12 Inches High Found in Swampy Places Produced by Trampling of Stock.....	30
21. Weathering of Jointed Rock Above and Thin Bedded Beneath.....	31
22. Rock Disintegration and Formation of Talus Slope.....	32
23. The Side of a Ravine Near Crawfordsville, Indiana.....	32
24. Mud Flow.....	34
25. Map Showing the Early Stages in the Formation of Coast Marshes.....	36
26. Section of Marine Marsh.....	36
27. Mangrove Marsh, Biscayne, Florida.....	37
28. Level Floor of Lake Chicago, with the Shore-line in the Distance.....	37
29. Terraces of Frazier River at Lilloet, B. C.....	38
30. Terrace Along Creek, Near Rockford, Illinois, Showing Stratification.....	38
31. Closer View Section of Gravel Terrace of Fig. 30.....	39
32. Front of Chenega Glacier Compared with Washington Monument, 550 Feet High.....	41
33. Very Stony and Gravelly Phase of Glacial Drift Near Whitewater, Wisconsin.....	41
34. Limestone Boulder Showing Glacial Scratches, Urbana, Ill.....	42
35. Glacial Grooves or Stria on Rock Surface, Northern Ohio.....	43
36. Typical Topography of Terminal Moraine Near Oconomowoc, Wisconsin.....	43
37. Drumlins—Remnants of Former Terminal Moraines.....	44
38. Drumlins—Transverse View.....	44
39. Adeline Esker, Ogle County, Illinois.....	44
40. The Material Composing Adeline Esker Consists of Coarse Sand and Gravel.....	45

41. Map Showing Extent and Southern Limit of Glaciation in North America.....	46
42. Map Showing the Three Centers of Ice Accumulation in North America.....	47
43. Map Showing Extent of Ice-sheet, Europe.....	48
44. A Section Showing the Black Sangamon Soil with the Illinois Glacial Drift Beneath and the Iowan Loess Above, with the Present Soil on the Surface.....	49
45. A Section Showing Bloomington Gravel, Shelbyville Till Sheet, Iowan Loess, Sangamon Soil, Silt Below Peat.....	49
46. Granite Boulder Weighing About 30 Tons, at Depot of Northwestern R. R., Waukegan, Illinois.....	51
47. Heap of Boulders Collected from a Moraine in Northern Illinois.....	51
48. A Dust Storm in Kansas, May 26, 1912.....	54
49. Sand Dune Advancing Over Forest, Beaufort Harbor, N. C.....	55
50. A Resurrected Forest, Dunc Park, Indiana.....	55
51. Wind Ripples on Sand Dune.....	56
52. Transplanting Beach or Marram Grass.....	56
53. The Grass in the Foreground Holds the Sand Which Drifts from the "Waste" Beyond the Fence.....	57
54. Sand is Being Held by Vegetation.....	57
55. Fences Being Used to Check the Movement of Sand.....	58
56. Large "Blowout" in Sand Area, Mason County, Illinois.....	59
57. Black Locusts Growing on Sand to the Right, Drifting Sand on Left.....	59
58. The Trailing Wild Bean Makes a Large Growth.....	60
59. Pines Growing on Sand Dunes in England.....	60
60. Alluviation by Glacial Stream, Below Hidden Glacier, Alaska.....	62
61. Calcium Carbonate Concretions from the Loess of Illinois.....	63
62. A Road Through a Deposit of Deep Loess Along the Lower Illinois River.....	63
63. Map of United States, Showing Timber and Prairie Areas.....	76
64. Soil Samplers.....	119
65. Bottle for Subsidence Method of Mechanical Analysis.....	125
66. Nobel's Elutriator.....	126
67. Schöne's Elutriator.....	126
68. Hilgard's Churn Elutriator.....	126
69. Machine for Centrifugal Analysis of Soils.....	127
70. Yoder's Centrifugal Elutriator.....	127
71. King's Aspirator for the Determination of the Effective Diameter of Soil Particles.....	128
72. Shrinkage of Different Types of Soil.....	133
73. Cracks in Black Clay Loam After a Long Dry Period.....	136
74. Fragments of Plants Found in Soils.....	143
75. Fragments of Insects Found in Soils.....	143
76. Specimens of Charcoal and Charcoal-like Material Found in Soils.....	146
77. Specimens of Coal Found in Soils.....	146
78. The Effect of the Removal of Humus and of Wetting and Drying Upon Granulation.....	149
79. Arrangement of Apparatus for Determining Organic Matter by Chromic Acid Method.....	155
80. Clover on Gray Silt Loam on Tight Clay.....	159
81. How Does This Man Handle Manure?.....	165
82. When the Spreader is Filled the Manure is Hauled to the Field.....	165
83. Manure Spreader in Action.....	167
84. An Expensive and Wasteful Way of Handling Manure on the Farm.....	169
85. Burning Corn Stalks.....	170
86. Adding Organic Matter to the Soil in the Form of Sweet Clover.....	172

87. A. Showing Angular Character of Quartz Particles in Decomposed Gneiss. B. Quartz Granules from Beach Sand. C. Showing Outlines of Shreds of Volcanic Dust as Seen Under Microscope.	179, 180
88. Diagram Showing the Arrangement of Soil Particles.	180
89. The Annual Rainfall Over the United States.	190
90. Soil Particles Showing Films and Waists of Capillary Water.	200
91. Large and Small Bubble Connected by a Tube.	200
92. Showing Theoretically the Thickness of Films in a Vertical Soil Column.	201
93. Showing the Effect of Various Amounts of Organic Matter on the Rise of Capillary Water from a Free-water Surface for a 14-day Period.	208
94. Diagram Showing the Relation of Different Forms of Moisture to the Available and Unavailable Moisture of Soils.	214
95. The Difference in Germination and Growth on Undrained and Drained Soil.	223
96. Pipe Heaved Nearly 6 Inches During Winter of 1915-1916.	225
97. Alfalfa that was Completely Killed by Heaving.	226
98. The Obstructions Interfere with the Current and Cause Deflections.	227
99. Ditch Gradually Being Filled by Soil Due to Current Being Retarded by Grass.	227
100. A Neglected Ditch Often Seen in Heavily Wooded Areas.	227
101. Showing the Water Table with Lines of Tile Soon After the Insertion of Another Line.	228
102. A Good Method of Conserving Moisture.	234
103. Types of Rainfall Over Dry-farm Area of the United States.	239
104. Sage Brush on Land Well Adapted to Dry Farming. Utah.	239
105. A Gravelly Soil Not Well Adapted to Dry Farming.	240
106. A Deep, Medium-grained Soil Well Adapted to Dry Farming. Utah.	243
107. Campbell Subsurface Packer.	247
108. Turkey Red Fall Wheat, Without Irrigation, Yield 58 Bushels Per Acre.	249
109. White Hulless Barley on Land Continuously Cropped.	249
110. White Hulless Barley on Land Fallowed the Previous Year.	249
111. Corn Grown on Dry-land Farm. Utah.	252
112. Dry-farm Potatoes. Utah.	253
113. Conduit for Conducting Water to Where it May be Used for Irrigation.	258
114. Concrete-lined Canal that Permits no Loss by Seepage.	258
115. Roosevelt Dam, Salt River, Arizona.	260
116. Granite Reef Diversion Dam, Salt River Project, Arizona.	260
117. Desert Lands and Homestead, Huntley Project, Montana.	261
118. Wheat Field, Minidoka Project, Idaho.	261
119. Chains for Puddling the Mud of Canals to Prevent Seepage.	267
120. Rectangular Weir.	268
121. Trapezoidal or Cipolletti Weir, Showing Method of Dividing the Stream.	269
122. Basin or Cheek System of Irrigating Orchards.	270
123. Irrigating Potatoes by Furrows.	271
124. Method of Irrigating by Overhead Sprays.	272
125. Mallin Ranch, Salt River Project, Arizona.	274
126. Alfalfa Field, Yuma Project, Arizona.	274
127. Beginning of an Alkali Spot.	279
128. Alkali Area Showing the Absence of Vegetation.	279
129. Apricot Trees. The Scanty Foliage Shows the Effect of Alkali.	283
130. An Orchard Well Cultivated Prevents the Rise of Alkali.	286

131. Growth of Barley on Partly and Fully Reclaimed Alkali Land.	288
132. Wheat on Reclaimed Alkali Land Near Fresno, Cal.	289
133. A Dwarfed Bushy or Leafy Corn Plant Growing on Alkali Soil of Humid Area.	291
134. Difference in Growth on Light and Dark Colored Soils.	303
135. Showing the Comparative Areas Covered by the Sun's Rays When Vertical, 30, 60 and 80 Degrees from the Vertical.	304
136. Effect of Slope on the Area Covered by the Sun's Rays	305
137. Diagram Showing the Theoretical Action of the Plow.	327
138. Showing the Three Types of Mold-boards.	327
139. Plow with Separate Jointer and Rolling Coulter Attached Ready for Use.	328
140. The Combined Jointer and Rolling Coulter.	329
141. Disk Plow.	329
142. Lister for Preparing the Ground and Planting Corn.	330
143. Work Done by Lister.	331
144. Subsoil Plow.	331
145. Spike-tooth Harrow.	332
146. Spring-tooth Harrow.	332
147. Acme Blade Harrow.	333
148. The Solid Disk.	333
149. The Cut-away Disk.	334
150. The Spading Disk Harrow.	334
151. Smooth or Drum Roller.	335
152. The Culti-packer, a Form of Corrugated Roller, Showing Work Done	336
153. Disk Drill and Its Work.	336
154. Press Drill.	337
155. Ordinary Corn Planter with Attachment for Planting Cowpeas in Hill or Row with Corn.	338
156. Three-shovel Cultivator.	338
157. Disk Cultivator.	339
158. Surface or Blade Cultivator with Leveler.	339
159. Weeder.	340
160. An Early Form of Plow.	340
161. The Sod is Well Turned and Represents Good Work.	341
162. Good Plowing in Stubble Land.	342
163. A Crooked Furrow Does Not Look Well.	342
164. Previous to Plowing, Disking Should be Done.	344
165. Grain Produced from Five Tenth-acre Plots Prepared in Different Ways for Winter Wheat.	346
166. A Good Seed Bed on Stalk Ground.	348
167. Nine-year Average Yield 43.3 Bushels Per Acre.	351
168. Nine-year Average Yield 48.9 Bushels Per Acre.	351
169. Nine-year Average Yield 7.4 Bushels Per Acre.	351
170. Yields of Corn (Field Weight) with Different Methods of Tillage.	354
171. Yield of Corn (Field Weight) with Different Method of Tillage.	354
172. Level Cultivation.	355
173. Ridged Cultivation with Drilled Corn.	356
174. Two Hundred Square Miles of Once Forested Mountains in China.	359
175. Sweet Clover on Badly Eroded Land.	361
176. Cultivated Terraces in China.	364
177. Guide-row Terraces.	365
178. Level-bench Terrace.	366
179. A Terraced Park in Mississippi.	367
180. The Mangum Terrace.	367
181. Locusts Growing on Gullied Land.	368

182. Erosion in Pasture Near Crest of Slope	370
183. Old Field Erosion in Mississippi	370
184. Old Erosion	371
185. Brush Checking Erosion	372
186. Headwater Erosion	372
187. Earth-dam for Checking Erosion	372
188. Filling a Gully by Means of a Concrete Dam	373
189. Agricultural Provinces	383
190. Wheat Growing on a Soil Very Deficient in Nitrogen	397
191. Legumes Turned Under Have the Same Effect as the Addition of Nitrogen	397
192. Wheat, 1911, Urbana Field	401
193. Wheat, 1911, Urbana Field. Finely Ground Rock Phosphate Applied	401
194. Corn on Peaty Swamp Land, 1903	404
195. Farm Land, Value Per Acre, 1910	410
196. Farm Property, Value, 1910	411
197. Corn Acreage, 1909	412
198. Corn Production, 1909	413
199. Oats Production, 1909	414
200. Spring Wheat Acreage, 1909	415
201. Winter Wheat Acreage, 1909	416
202. Wheat Production, 1909	417

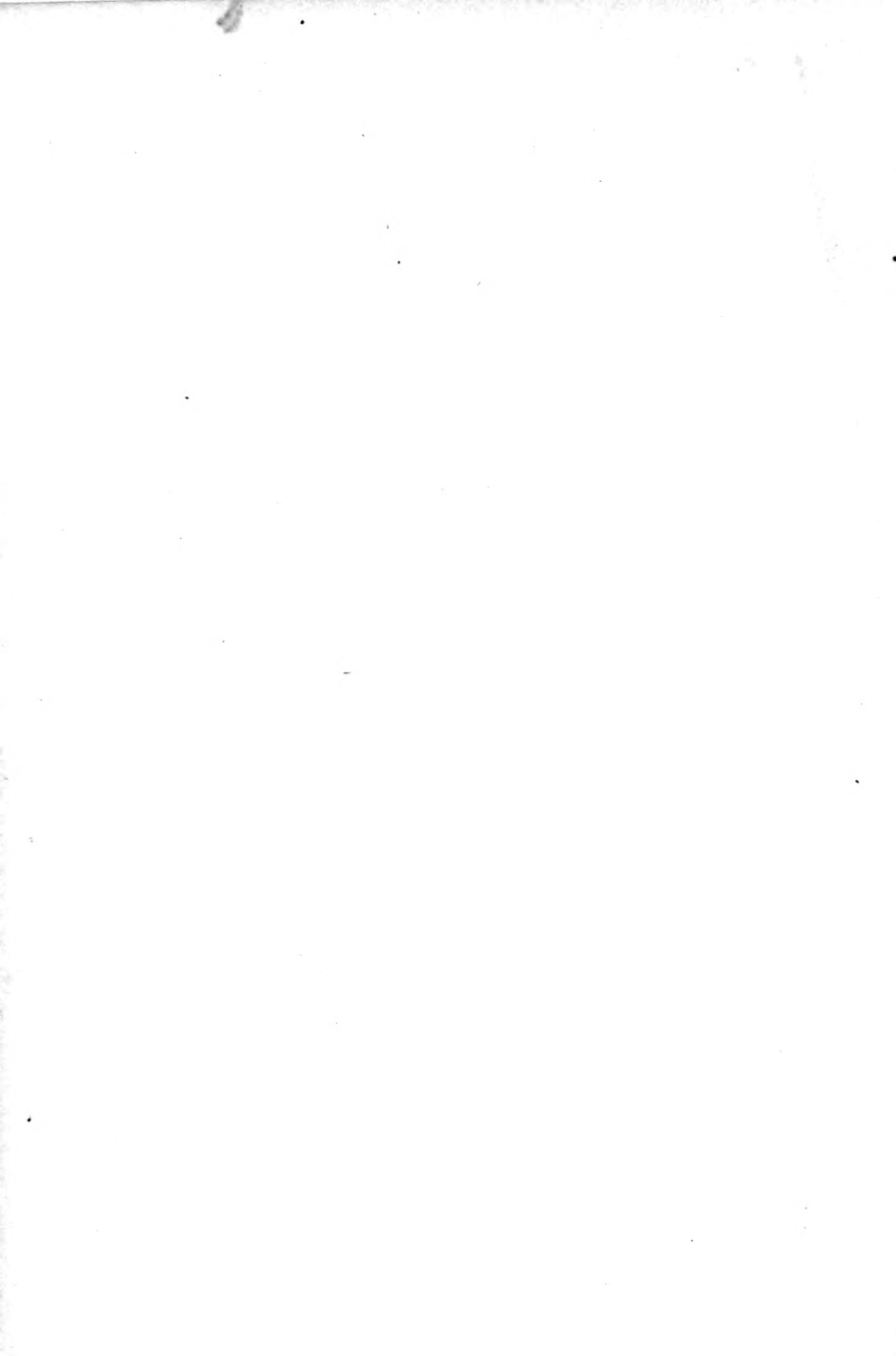

SOIL PHYSICS AND MANAGEMENT

CHAPTER I

SOIL MATERIAL AND ITS ORIGIN

Definition of Soil.—The land surface of the earth is covered almost everywhere with a layer of unconsolidated material derived from rocks by the processes of weathering. This stratum varies in thickness from a few inches to hundreds of feet and may even be absent from small areas, not because it was never formed there, but because it has been carried away. The agencies of transportation have done so much work that in many instances much or all of the loose material covering the rocks was not derived from those beneath, but from rocks at some distance, even hundreds of miles away. This material varies in composition with the rock from which it was derived and the agencies producing it. It cannot be termed a soil until organisms have worked upon it, modifying it to a greater or less extent. The depth of the layer upon which the organisms have acted is only a few feet.

From its origin, a soil may be defined as disintegrated and decomposed rock mixed with more or less organic matter, while from its use it is defined as that part of the earth's surface adapted to the mechanical support and nourishment of plants.

Elements of the Earth's Crust.—The earth has been studied by various means and the composition determined to a depth of approximately twenty miles. Of the elements known, comparatively few occur in any large quantities in this stratum. Eight constitute about 98.5 per cent. The following table shows the relative abundance of these elements.

Soil Forming Minerals.—Aside from oxygen and nitrogen as air, and carbon as graphite or diamond, these elements rarely ever exist in a free state, but are found in combinations as minerals. These are natural substances, possessing definite physical characteristics as, specific gravity, hardness, brittleness, color, cleavage, and sometimes crystalline form and having a more or less definite chemical composition.

*Average Composition of the Known Earth*¹

Elements	Lithosphere † 93 per cent	Hydrosphere ‡ 7 per cent	Average, including atmosphere
Oxygen *.....	47.33	85.79	50.02
Silicon.....	27.74	25.80
Aluminum.....	7.85	7.30
Iron	4.50	4.18
Calcium	3.47	.05	3.22
Magnesium	2.24	.14	2.08
Sodium.....	2.46	1.14	2.36
Potassium	2.46	.04	2.28
Hydrogen22	10.67	.95
Titanium.....	.4643
Carbon19	.002	.18
Chlorine.....	.06	2.07	.20
Bromine.....008
Phosphorus1211
Sulfur12	.09	.11
Barium.....	.0808
Manganese.....	.0808
Strontium.....	.0202
Nitrogen03
Fluorine.....	.1010
All other elements.....	.5047
	100.00	100.00	100.00

* The elements essential for crops are in bold type.

† The solid part of the earth's crust.

‡ The liquid part, oceans, seas, etc.

The hardness of minerals is indicated by the following scale: (1) talc—finger nail scratches it easily; (2) gypsum—thumb nail scratches slightly; (3) calcite—can be scratched by common soft pin; (4) fluorite—soft iron scratches it; (5) apatite—scratched by a good knife; (6) feldspar—very hard knife scratches it; (7) quartz—scratches glass; (8) topaz—scratches quartz; (9) corundum—scratches topaz; (10) diamond.

The number of minerals that form soils is not large, but they may be found in many intermediate stages because the process of decomposition is a gradual one.

1. **Quartz, silica** (SiO_2) is a very abundant mineral in rocks and the most abundant in soils. When crystalline it possesses a glassy appearance and is transparent in thin slices, but impurities render it more or less opaque. The common crystalline varieties are quartz crystal, rose, smoky and milky quartz. The non-crystalline varieties are usually opaque and include flints, cherts, chalcedony and the different forms of agate. In rocks such as

granite, quartz occurs as glassy masses which do not decompose as most other minerals do, but remain as distinct grains of quartz when the rock is broken down. In limestones it frequently occurs as chert, an impure rather soft form, or as flint. Sand, sandstones, and quartzite are formed principally of quartz. The fact that its hardness is 7, that it is almost insoluble, decomposes very slowly and possesses no cleavage, makes it very abundant among the coarser constituents of soils. It may be distinguished by its glass-like appearance, hardness, shell-like fracture, lack of cleavage and its resistance to the action of all acids with the exception of hydrofluoric.

2. **Feldspars.**—The feldspars include double silicates of potassium, sodium, calcium and aluminum. They possess a hardness of 6, distinct cleavage and decompose rather readily in the presence of carbonated water. The action of carbonic acid is to dissolve out the base or bases, forming the soluble carbonates, leaving a hydrated aluminum silicate, kaolin, and finely divided free silica which constitute the clay of soils. The process is known as kaolinization. The following table gives the composition of the principal feldspars.

Composition of Principal Feldspars²
Per cent

Varieties	SiO ₂	Al ₂ O ₃	K ₂ O	Na ₂ O	CaO
Orthoclase.....	64.7	18.4	16.9
Albite.....	68.0	20.0	12.0
Oligoclase.....	62.0	24.0	9.0	5.0
Labradorite.....	53.0	30.0	4.0	13.0
Anorthite.....	43.0	37.0	20.0

As an illustration of the decomposition of feldspar, orthoclase may be taken. Carbonated water coming in contact with this mineral dissolves out the potassium, forming potassium carbonate, which being soluble is carried away. In the process the excess of silica, which amounts to approximately 20 per cent in orthoclase, is separated as extremely fine particles most of which are classed as clay. The alumina is left in combination with silica as a hydrous aluminum silicate forming the mineral kaolin which also constitutes clay. The result then of the decomposition of feldspar is a light-colored clay composed of free silica and kaolin.

3. **Amphibole and Pyroxene.**—These groups of minerals are

very abundant in some rocks and vary a great deal in composition and physical properties. They have about the same hardness as feldspar and possess more or less definite cleavage planes. They may be either aluminous or non-aluminous. Magnesium, calcium and iron are nearly always present. The iron is frequently in the ferrous condition. As a general rule these groups of minerals decompose somewhat readily, giving rise to hydrous magnesium silicates and soluble carbonates, the latter of which are carried away in solution. The hydrous magnesium silicate may be in the form of serpentine or talc, the latter of which, because of its softness, is readily broken down into clay. The ferrous iron present becomes oxidized and generally gives a yellow or brownish color to the soil formed. As these groups of minerals are frequently magnesian, the soil resulting is not generally highly productive.

4. **Muscovite—White Mica.**—This mineral is made up of transparent laminae or folia possessing a hardness of 2 to 2.5. These folia are thin, elastic and tough.

The chemical composition and physical properties of this mineral seem to indicate that it would decompose rather readily, but on the other hand it is very stable and resists decomposition so well that in most cases the mica remains in the residue as distinct shining flakes, giving the soil a peculiar glittering appearance where the flakes are of considerable size. The first step in its decomposition is hydration, resulting in a hydrated mica having a pearly luster. When decomposition is complete the product is the hydrous aluminum silicate or clay. Muscovite is found in granites to a considerable extent, but is not very often associated with the more basic rocks or those containing a large per cent of magnesium, calcium or iron.

5. **Biotite—Black Mica.**—Biotite differs from the preceding mica in color, and in the fact that it decomposes more readily. It contains aluminum and iron in both ferrous and ferric states with both magnesium and potassium. It decomposes into a mixture of hydrated aluminous and magnesian silicates, both of which constitute clay. Biotite occurs associated with the more basic rocks.

6. **Zeolites.**—The zeolites comprise a group of secondary minerals of somewhat doubtful importance, whose function, it is believed, is to retain the potassium and calcium in the soil against leaching. In the decomposition of minerals to form soil material the potassium, sodium and calcium unite with the aluminum and silica in loose combinations instead of being carried away in solu-

tion and lost. From these combinations the elements are liberated somewhat as needed by plants. The minerals of this group are decomposed by hydrochloric acid with the separation of colloidal silica.

The preceding minerals are silicates, but there are a few non-silicates that should be considered in the study of soils.

7. **Calcite** (CaCO_3).—Calcite is a very common mineral existing as limestone and marble. Its composition is CaO, 56 per cent, and CO_2 , 44 per cent, when pure. It possesses a hardness of about 3, distinct cleavage and is soluble in carbonated water, one part in 1020 of water, forming the bicarbonate ($\text{CaH}_2(\text{CO}_3)_2$). In the formation of soil material from rock made up largely of calcium carbonate, the insoluble impurities are left and form the soil. As a general rule limestone soils are quite fertile.

8. **Dolomite** ($\text{CaMg}(\text{CO}_3)_2$).—The hardness of dolomite is 3.5. It is composed of 54.35 per cent of calcium carbonate and 45.65 per cent of magnesium carbonate. Dolomitic limestone is made up of these minerals, though probably not always in these proportions. It is slowly soluble in carbonated water, leaving the impurities to form soil material. A large amount of magnesium carbonate is injurious to some crops and constitutes much of the alkali in soils of humid areas.

9. **Gypsum** ($\text{CaSO}_4 \cdot 2\text{H}_2\text{O}$).—Gypsum possesses a hardness of 2 and the following composition: sulfur trioxid, 46.5 per cent, lime 32.6 and water 20.9 per cent. It is found in considerable quantities in arid regions where salt lakes formerly existed, but is of comparatively little importance as a soil former, since the soil derived from it has very little value. It has, however, some value as a remedy for black alkali that is so frequently found in arid and semi-arid regions.

10. **Apatite** ($\text{Ca}_5(\text{PO}_4)_3\text{Cl}$).—This mineral is important in soils because of the phosphorus it furnishes. Fortunately it exists in all rocks, though in very small amounts, and when these decompose very little of the phosphorus is lost through solution. Hence a soil will usually show a higher per cent of phosphorus than the original rock. In some cases the chlorine is replaced by fluorine.

11. **Limonite** ($2\text{Fe}_2\text{O}_3 \cdot 3\text{H}_2\text{O}$) and **Hematite** (Fe_2O_3).—Several other minerals might be mentioned, among which are limonite, the hydrated ferric oxide having 85.6 per cent of Fe_2O_3 and 14.4 per cent of water, and hematite 30 per cent of oxygen and 70 per cent of iron. One or the other of these and sometimes both are found in

nearly all soils giving the characteristic iron color, the former imparting a yellowish or brownish yellow color while the latter gives a decidedly reddish color. Varying proportions of these mixed together give many shades of red, brown and yellow.

12. **Magnetite** (Fe_3O_4) or ($\text{FeO} \cdot \text{Fe}_2\text{O}_3$).—Magnetic iron ore or magnetite exists in nearly all igneous rocks in small quantities but in some in sufficient amounts to form a very important soil constituent. It does not decompose very readily, but remains as black magnetic particles in the soil. Black sands of some parts of North Carolina and some of the alluvial soils of California contain this mineral. It may be easily recognized by its magnetic properties. Like quartz sand it is inert and soils formed largely of this mineral would be very poor.

ROCKS

Rocks are masses of minerals or mineral aggregates and are divided into three classes, *igneous*, those formed through the agency of heat, *aqueous*, those formed through the agency of water, and *metamorphic*, where igneous or aqueous rocks are changed through one or both of these agencies into different forms, but having practically the same chemical composition.

1. **Igneous rocks** are divided into two groups, first, *intrusive* or *plutonic*, those formed at considerable depth in the earth's crust where they cooled with sufficient slowness to crystallize, and later exposed through erosion; second, *eruptive* or *volcanic*, those thrown out on the surface of the earth through volcanic agencies. Both classes of igneous rocks are formed by the fusing and mixing of rocks, such as limestones, shales and sandstones, due to the heat developed in the folding of the earth's crust in its adjustment to the shrinking interior. After the adjustment takes place, this molten mass gradually cools, the minerals crystallize, forming the group of crystalline rocks. In this folding, if a fracture should occur extending to the surface of the earth, much of this molten mass may be forced out on the surface and constitute the volcanic rocks. This may cool rapidly and solidify into a glassy or semi-crystalline condition. In some cases the violence of the explosion that frequently accompanies volcanoes throws immense masses of this material into the air, which falls in the form of ash in the vicinity of the volcano, but sometimes as dust is carried over large areas of the earth's surface by air currents. The igneous rocks are divided into several groups according to their mineral composition.

(a) **Granite-Rhyolite.**—This group is composed of quartz, feldspars, chiefly orthoclase and albite, mica, either black or white, and amphibole or pyroxene. A small amount of apatite is always present. Rhyolite is the principal volcanic rock of this group. In the decomposition of this group carbonated water attacks the feldspars, dissolving out the potassium and sodium in the form of carbonates, leaving the clay residue. The quartz is broken down into sand and gravel while the other minerals are decomposed into other products as given under those special minerals above. The resulting soil material formed is a sandy clay, the color depending upon the amount of iron-bearing minerals in the granite. The soil material formed from rhyolites and other volcanic granites differs only in fineness from that resulting from intrusive granites.

(b) **Syenite-Trachyte.**—This group consists chiefly of the feldspars, orthoclase or albite, minerals of the mica, amphibole or pyroxene groups and a small amount of apatite. It differs from the granites in the absence of quartz. Its decomposition is similar to that of the granite but gives a clay free from sand, colored by iron compounds. This rock is not so common as granites. Trachyte is the volcanic form of syenite.

(c) **Diorite-Andesite.**—These rocks contain oligoclase, mica, usually biotite, amphibole or pyroxene and apatite. Quartz may be present. The soil material formed is either a rather highly colored clay or sandy clay, depending on the absence or presence of quartz in the original rock. Andesite is a common volcanic form.

(d) **Diabase-Basalt.**—This group of rocks consists of labradorite, amphibole or pyroxene, usually the latter, and small amounts of apatite. Quartz may be present in small quantities as in the case of the diorites. Usually large amounts of magnesium and iron-bearing minerals are present. The decomposition of this group gives a highly colored clay containing large amounts of hydrated magnesium silicates. Basalt is the volcanic form.

Other groups of igneous rocks might be given, but these are sufficient to illustrate the changes that take place in the formation of soil material from them.

2. **Aqueous rocks** are divided into three classes, (a) those whose constituents have been in solution and have been deposited by cooling, evaporation, release of pressure or by direct chemical precipitation; (b), sedimental or fragmental deposits, those formed by the breaking down of preëxisting rocks and deposited by the action of water; and (c), those formed largely by plants and

animals. It is quite impossible to draw any distinct lines between the groups.

(a) **Chemical Precipitates.**—Rocks formed in this way are not of a great deal of importance as soil formers, but have great economic value. These include the precious stones, the ores both of useful and precious metals and deposits of plant food, especially potassium and phosphorus.

(b) **Sedimentary or Fragmental.**—This division includes sandstones and shales. *Sandstones* may be divided into classes according to the material that cements the particles together, as siliceous, ferruginous, or calcareous. Siliceous sandstones break down largely through physical or mechanical agencies, forming a sandy soil of unusually low agricultural value. A good example of this is the St. Peter's sandstone of northern Illinois. Ferruginous sandstones are broken down in a way similar to the siliceous, except that chemical agents are more apt to affect the cementing material. The resulting soil is a sand, colored by compounds of iron and does not possess a high degree of fertility. In the breaking down of calcareous sandstones, the lime is dissolved out by the action of carbonated water, thus freeing the particles and forming a rather poor sandy soil. The decomposition of felspathic sandstones may give rise to soils of fair fertility because of the potassium and lime present, but on the other hand micaceous sandstones produce soils of low value.

Shales vary largely in physical composition. Some are composed of clay while others contain much coarser material, such as silt or even sand. The indurated character of shales is principally due to pressure and they are consequently easily broken down into soil material. The stratification also aids this process. The soils formed from shales vary from very heavy clay to silty or sandy ones, and may be extremely difficult to work. In general shale soils are not of high agricultural value.

(c) **Organic.**—This includes those deposits that have been formed through the agency of organisms. They consist of coal, chalk, marl, and limestone.

Calcareous rocks include chalk, marl, and the various limestones (Fig. 1.) Soils are formed from these through the solvent power of carbonated water which removes the lime and magnesia as the bicarbonate, leaving the insoluble impurities as soil material. This may consist of particles of sand or quartz or some of the finest soil constituents as silt or clay (Fig. 2). Limestones frequently con-

tain masses of chert, impure quartz, or flint which may constitute no small part of the soil, thus giving rise to cherty or flinty soils. The rapidity with which a soil is formed from a limestone depends

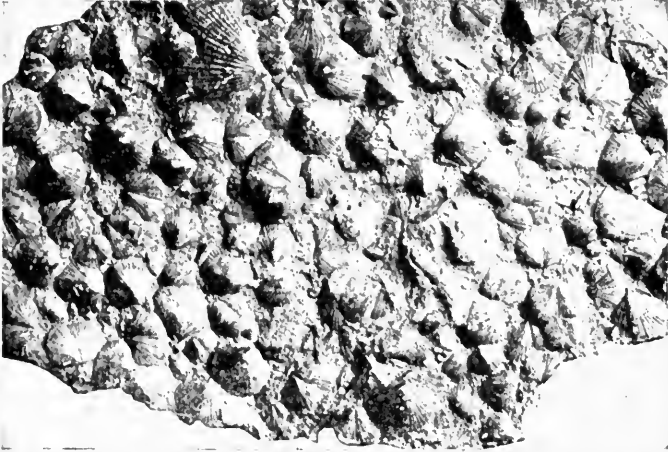

FIG. 1.—Limestone composed chiefly of shells of Brachiopods. (Church.)

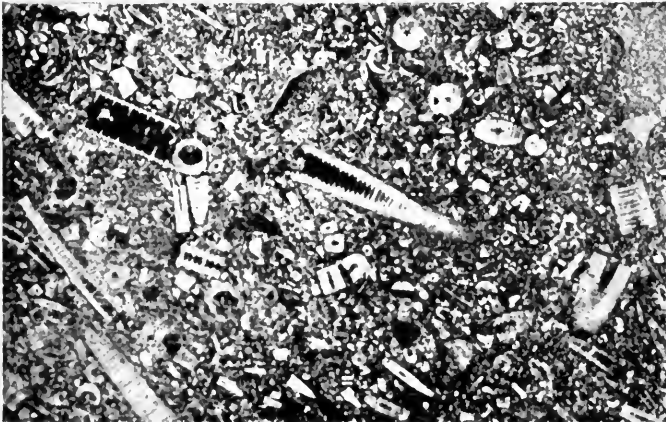

FIG. 2.—Limestone containing large amounts of Crinoid stems. (Church.)

upon the amount of impurities present. A limestone containing two per cent of impurities could leave approximately two feet of residue for each 100 feet of limestone removed in solution provided nothing is lost by erosion. Limestone soils are usually fertile.

3. **Metamorphic rocks** include those that have been changed from their original condition by both physical and chemical agencies. These may have been of either aqueous or igneous origin. Changes have given rise to marbles from limestones, slates from shales, and gneisses and schists from igneous rocks.

QUESTIONS

1. Define soil.
2. Which of the elements essential for crops are taken from the air and which from the soil?
3. What is the significance of the hardness of a mineral in the formation of soils?
4. Why should quartz be such a common constituent of soils?
5. Why is little feldspar found in soils when it is so abundant in rocks?
6. What is the chief value of zeolites?
7. What is the importance of non-silicates as soil formers?
8. Which are the principal non-silicate minerals in soils of humid regions?
9. How are igneous rocks formed?
10. Give distinctions between granites, syenites, diorites, and diabases.
11. Distinguish between chemical precipitates and sedimentary rocks.
12. How are soils formed from calcareous rocks?
13. Where do we find soils formed from chalk? From limestone?

REFERENCES

- ¹ Clark, F. W., Bulletin 616 U. S. Geological Survey, The Data of Geochemistry, 1916, p. 34.
- ² Merrill, G. P., Rocks, Rock-Weathering and Soils, 1906, p. 15.

CHAPTER II

WEATHERING

Rocks are broken down into soil material through the processes of weathering (Figs. 3, 4, and 5). These may be divided into (1) physical agencies that break the rock into smaller pieces without affecting it chemically, and (2) chemical agencies that change the composition of the minerals forming the rock and in so doing exert



FIG. 3.—Irregular weathering of rock due to joints and stratification. Note talus at base. (Chamberlain and Salisbury, Courtesy Henry Holt & Co.)

a marked influence upon its physical character. The work of the physical agencies is *disintegration*, while that of the chemical agencies is *decomposition*. Each is accompanied and aided by the other in its work and the changes tend to produce more stable forms under existing conditions. As an illustration, feldspars are not very stable minerals under ordinary conditions, and hence break down into substances that are more stable. The chemical changes produce hydrous aluminum silicate, carbonates and free silica which are much more stable than the feldspar from which they are derived. Physically, the clay is much more stable than the original mineral

or even the coarse soil constituents because it has approached more closely the limit of mechanical division. The others may be broken down into smaller fragments by the agencies of weathering.



FIG. 4.—A more advanced stage of weathering than Fig. 3. (Chamberlain and Salisbury, Courtesy Henry Holt & Co.)

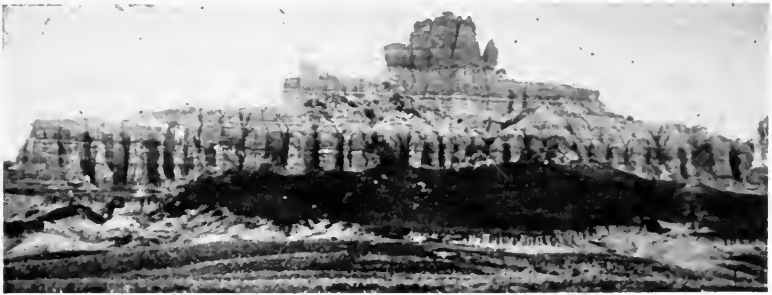

FIG. 5.—“Capitol Rock,” Butte, Montana. The different levels are due to varying hardness of the rock strata.

1. PHYSICAL AGENCIES.

(a) **Heat and Cold.**—In general, substances expand when heated and contract when cooled. This is true of rocks. They are, however, poor conductors of heat and the high temperature of the

rock extends to only a slight depth. The greater expansion of the surface produces a strain that frequently causes a layer to break off, sometimes with considerable violence (Fig. 6). In Lower California, slabs as much as ten feet long and from eight to ten inches thick have been observed on the southwest side of rock exposures that were produced in this way. Many similar cases may be seen in the arid regions in southwestern United States. Boulders are sometimes found in this latitude that show peculiar exfoliation due to unequal heating. This action is more noticeable in fine-grained



FIG. 6.—Exfoliated granite in the Sierra Nevada, California. Previous glaciation has removed the loose material, giving the agency of heat a better chance. Rocks, Rock-Weathering and Soils, Merrill. (Courtesy The Macmillan Company.)

than in coarse-grained rocks, and in higher altitudes where the temperature changes are great and sudden. W. H. Bartlett¹ has shown that granite expands or contracts .0000018 of an inch per foot for each degree Fahrenheit. Marble changes .0000056, while sandstone changes .0000095 of an inch per degree. Practical applications of this principle have sometimes been made in quarrying and in removing rocks in constructing roads. Boulders may be broken up by heating and cooling suddenly. Rocks are made up of various mineral crystals that possess different coefficients of expansion. The

repeated differential expansion and contraction of adjacent unlike minerals due to temperature changes of day and night loosen the crystals, causing the rock to crumble. This plays a more prominent part in the breaking down of coarse- than fine-grained rocks. In this way rocks are weakened and finally reduced to soil material by other agencies.

(b) **Freezing and Thawing.**—When water passes from the



FIG. 7.—Columbia Glacier overriding a forest, Alaska. (Courtesy National Geographic Magazine, Washington, D. C. Copyright.)

liquid to the solid condition its volume is increased by about nine per cent, and the force exerted is 150 tons per square foot, or over a ton per square inch. Water frequently freezes under conditions such that part of this force is used in enlarging crevices in rocks, breaking off small fragments or displacing masses to such an extent that when thawing occurs they may roll down the slope. This is especially noticeable during a morning thaw on stony slopes free from

vegetation. Very porous rocks are frequently disintegrated rapidly by freezing, especially when the rocks approach saturation. Rocks possessing vertical joints or made up of inclined strata of different material will weather rapidly because of greater absorption of water. This action does not occur in tropical or subtropical climates, but in temperate regions it is very important in breaking down rocks and in keeping the subsoil open so that both air and water may enter the soil much more readily and carry on their work to a greater extent upon the underlying rocks.

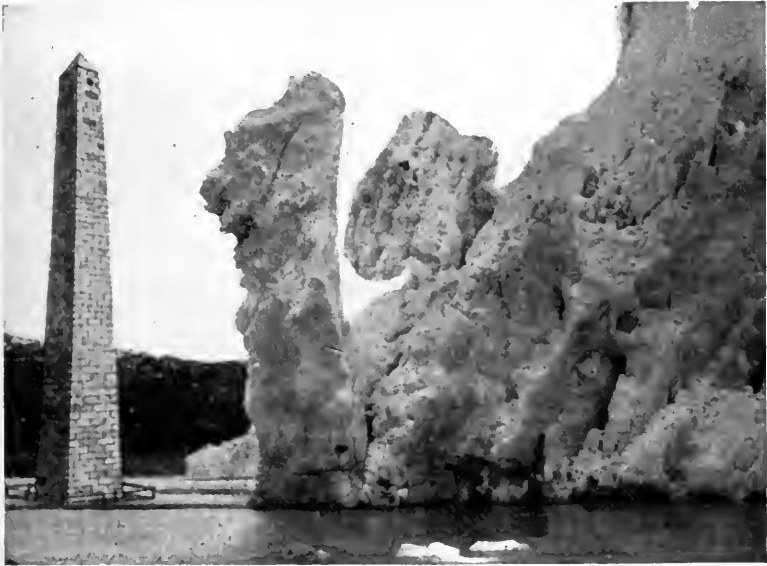

FIG. 8.—Front of Columbia Glacier in 1910 compared in height to Bunker Hill Monument. The pinnacle fell a few minutes after the picture was taken. (Lawrence Martin.)

(c) **Glaciers.**—At the present time the work of glaciers is limited to a comparatively small area of the earth's surface (Figs. 7 and 8). During the glacial period about half of North America and Europe were covered with an ice sheet, and the work of this agent was very important in that it leveled hills and filled valleys, ground up and deposited large amounts of fine soil-forming material. This deposit is found not only on the glaciated areas, but was carried far beyond the ice sheet by water and further distributed by the wind. Glacial areas are now confined to polar and a few mountainous regions. Greenland with an area of 500,000 square miles is

almost entirely covered by an ice sheet. This approaches somewhat the condition that existed over North America and Europe during the glacial period.

Glaciers are drainage systems of regions of perpetual snow. The moving ice obeys the same laws as streams and does the same kind of work, but the fact that ice is a solid body gives it great grinding power. Ice exerts a pressure of forty pounds per square inch for every one hundred feet in thickness, and geologists estimate the ice to have been from a few hundred to five thousand feet or more in thickness during the glacial period. This great pressure gives the ice immense denuding and grinding power. Glaciers move from a few feet to one hundred feet per day, the movement being more rapid



FIG. 9.—The material carried and rolled by streams gives them their great eroding power. (U. S. Reclamation Service.)

in summer. In their movement large masses of rock become imbedded in the bottom of the glaciers, grooving and grinding the solid rock over which they pass. It must be remembered, however, that the ice did not hold these rigidly.

(d) **Erosion of Streams.**—Flowing water doubtless is the most extensive physical agent in the formation of soil material at the present time. The streams with their load of clay, silt, sand, gravel, and even boulders are not only using these tools to deepen and widen their valleys but they also grind the materials into powder fitted for soil formation. The work of moving water varies as the square of the velocity. If the velocity is doubled the work that the stream is capable of doing will be increased four times, since by doubling the velocity, twice the number of particles will strike an object with double the force. The deepening and widening of the stream chan-

nel is due mainly to the mechanical wear or friction of the material carried by the water (Fig. 9). Clear water abrades very slowly. A rapidly flowing stream carrying large amounts of material abrades its bed very rapidly. This may be illustrated in the valleys that have been cut by streams that contain water only after very heavy rains. Level plateaus have been dissected and changed into a rugged country of hills and valleys by comparatively small wet weather streams. The entire land surface has been greatly modified by this process and the transported material used largely in soil formation.



FIG. 10.—Inner gorge of Grand Cañon of the Colorado River, Arizona. (Walcott, U. S. Geol. Survey.)

Captain C. E. Dutton² estimates that 10,000 feet of rock strata have been removed from an area of 13,000 to 15,000 square miles by the Colorado River (Fig. 10).

When quartz is ground up through the action of moving water much sand is produced, and after these particles have been reduced to a certain size the permanent water film protects them largely from further attrition. On the other hand, feldspars when subjected to attrition form an impalpable mud or clay accompanied by considerable loss of bases such as potassium, sodium, or calcium, according to the kind of feldspar.

(e) **Waves.**—Wave action is confined to the shores of seas and the larger lakes. In many places this agency breaks down solid cliffs into masses of rock that become broken and worn into rounded boulders, then to pebbles, and finally into fine material that is carried away and deposited in deeper water or in sheltered inlets to form bars. On the Atlantic coast of Britain waves sometimes exert a pressure of three tons per square foot. The average force is 611 pounds per square foot in summer and 2086 pounds in winter. Each wave results in the movement of more or less material, and



FIG. 11.—Wind-carved granite. The tools were grains of sand. Camps Bay, S. Africa. (Chamberlain and Salisbury, Courtesy Henry Holt & Co.)

this movement is accompanied by attrition producing fine material. Shaler has observed that at Cape Ann, Mass., granitic paving blocks, weighing about twenty pounds, when exposed to the action of the surf for a year, were worn into spheroidal boulders that would indicate a loss of more than an inch.

(f) **Wind.**—The movement of wind is universal, but its effect is destroyed or greatly reduced, at least, at certain seasons of the year over large areas of the land surface by the covering of vegetation. Along the coasts, in the arid interiors of continents, and during winter and spring in many areas, a large amount of work is

done by the wind in wearing down solid rocks and coarse soil materials into dust. The impact of sand particles against rocks and against each other gradually wears them down into fine materials (Fig. 11). The largest number of particles are moved near the surface of the ground, hence the greatest amount of abrasion will take place there. A boulder will be worn away slowly on the windward side at the base until it topples over, and the process will then be repeated until it is entirely destroyed. Along shores the glass in windows of houses is sometimes worn through by the impact of sand particles, and an instance is given by Merrill³ where the glass in a lighthouse was ruined during a single storm. Sand blasts are used to produce ground glass. The natural monuments and "mushroom" rocks in the West owe their origin largely to the work of the wind.

(g) **Plants.**—The mechanical action of plants is shown by the growth of roots in crevices or fissures of rocks and the prying apart of great masses, thus giving other agencies an opportunity for effective work. The force exerted by mushrooms or toadstools is sometimes sufficient to raise blocks of stone, while cement walks are frequently ruined by the lifting action of roots of trees growing adjacent (Fig. 12). Hilgard⁴ makes this statement, "Actual measurement has shown the force with which the root, *e.g.*, of the garden pea penetrates, to be equal to from seven to ten atmospheres per square inch."



FIG. 12.—The roots of trees form wedges for prying rocks apart. (Gilbert, U. S. Geol. Survey.)

II. CHEMICAL AGENCIES.

(a) **Acids.**—The atmosphere in all localities contains more or less acid gases, which in combination with the moisture of the air form acids that are brought down with the rain. These acids are much more abundant in the vicinity of manufacturing plants, smelters, and large cities where they are produced, largely by the burning of coal. Sulfuric acid is probably the most common of these and

contributes much toward the breaking down of rocks. Nitric acid is formed under certain conditions in the atmosphere, and, although the amount reaching the surface of the earth per acre per annum is small, amounting at Rothamsted, England, to from 2.81 pounds to 2.98 pounds, yet the long-continued action of this acid during geological time has done a great deal toward breaking down rocks into soil material. In some localities hydrochloric acid forms a very active agent, especially upon limestone and marble.

(b) **Carbon Dioxide.**—The most effective acid in decomposing rocks is that produced by the union of carbon dioxide and water, or carbonic acid. Carbon dioxide is found in the atmosphere in all localities, but, of course, in slightly greater quantities near cities and factories than at other places. It is considered a weak acid, yet because of the fact that it is always present, it exerts an immense influence in breaking down rocks, especially those containing lime, magnesia, potash, and soda. The soil air contains much larger amounts of carbon dioxide than the air above, thus percolating water becomes highly charged before coming in contact with the rocks beneath. Carbonated water is an almost universal solvent. The amount of carbon dioxide in air under different conditions is shown by the following table:

*Amount of Carbon Dioxide in the Soil Air, and in the Atmosphere*⁵

	Parts per million by weight
Ordinary atmosphere	285 to 600
Air from sandy subsoil of forest	3,800
Air from loamy subsoil of forest	12,400
Air from surface soil of forest	13,000
Air from surface soil of vineyard	14,600
Air from pasture soil	27,000
Air from soil rich in humus	54,300

Fischer has shown that in rain and snow-water the amount of carbon dioxide varies between 0.22 and 0.45 per cent by volume of water. These figures according to Merrill would give for the Atlantic Coast States a depth of 3.75 mm. of carbon dioxide brought to the surface in rain and snow, for the upper Mississippi valley 2.50 mm., for the lower Mississippi valley 4.50 mm., and for the Northern Pacific States 6.25 mm. Water percolating through soil would absorb additional amounts.

(c) **Oxidation.**—The only element that free oxygen of the air acts upon is iron when in the sulfide or ferrous condition. When the iron of the sulfide is oxidized, iron sulfate is formed, which is

soon further oxidized so that the hydrated ferric oxide and sulfuric acid are produced. The resulting oxide is much softer, more easily removed by water and more bulky than the sulfide, hence becomes quite absorbent of moisture and is then readily affected by freezing and thawing. The expansion produced by the change tends to loosen the crystals of the rock and make it very susceptible to other agencies. The same is true in the case of iron existing in the ferrous condition either as a carbonate or silicate. The resulting products of decomposition tend to color the soil material, producing a yellowish, brownish, or reddish color.

(d) **Deoxidation.**—Under certain conditions oxygen will be removed from some compounds, but as a means for breaking down rocks this is not very important. The chief agency in deoxidation is organic acids. The great affinity of these acids for oxygen enables them to take part or all of it from certain compounds, especially those of iron, as oxides or sulfates producing a different mineral with entirely different physical properties, the most noticeable of which are color and hardness. In swamps organic acids frequently reduce ferric oxides to ferrous oxides and sulfates to sulfides, resulting in a grayish or drab color in the subsoil. The gray subsurface and subsoil of many of our poorly drained soils are undoubtedly due to the process of deoxidation. The soil under a peat bed is usually drab, indicating a reduction of iron.

(e) **Hydration.**—During the process of weathering certain of the common minerals that compose igneous and metamorphic rocks unite with water which not only changes the chemical composition, but produces very important changes in the physical character of the minerals that aid greatly in breaking them down into soil material. This change is usually attended with more or less loss by solution. One of the most important changes is the increase in volume, by which there is a tendency to rupture the rock. If no loss took place by solution, the change of granite into soil through various processes of weathering would give an increase in bulk of as much as 88 per cent,⁶ a large part of which is due to hydration. At the same time the hardness of the rock is lowered very materially, and this, of course, gives other agencies a better chance. The absorption of water will also be increased and freezing and thawing will be more effective. The general result of hydration is to render the rock very susceptible to other agencies. The process of hydration goes on to great depth. Apparently solid but hydrated rock taken from many

feet beneath the surface will crumble or "slake" upon exposure to the air.

(f) **Solution.**—Water is a universal solvent, but its power is greatly increased by the presence of substances in solution so that it becomes a very active agent in breaking down rocks. Its efficiency is greatly increased by the presence of carbon dioxide which is absorbed by rain water from the atmosphere and still more from the soil air as it percolates through the soil, the air of which contains large amounts of carbon dioxide. The water thus becomes a very active solvent (see table, page 20).

Effect of Decomposition on Loss of Constituents from Rocks ⁸

	Biotite granite, Georgia		Syenite, Arkansas		Diabase, Virginia		Diorite, Virginia		Limestone, Arkansas	
	Fresh 35 feet below surface	Decom- posed 5½ feet below surface	Fresh	Decom- posed	Fresh	Decom- posed	Fresh	Decom- posed	Fresh	Resid- ual clay
SiO ₂ ...	69.88	51.29	59.70	46.27	45.73	37.09	46.75	42.44	4.13	33.69
Al ₂ O ₃ ...	16.42	29.69	18.85	38.57	13.48	13.19	17.61	25.51	4.19	30.30
Fe ₂ O ₃ ...	1.96	6.33	4.85	1.36	16.79	19.20	2.35	1.99
FeO....			11.60	35.69	MnO	4.33
CaO....	1.78	0.07	1.34	0.34	9.92	0.41	9.46	0.37	44.79	3.91
MgO...	0.36	0.14	0.68	0.25	15.40	0.57	5.12	0.21	0.30	0.26
Na ₂ O...	4.46	1.12	6.29	0.37	3.24	1.75	2.56	0.56	0.16	0.61
K ₂ O....	5.63	1.50	5.97	0.23	.47	0.33	0.55	0.49	0.35	0.96
P ₂ O ₅	0.25	0.29	3.04	2.54
CO ₂	34.10	0.00
Ignition	0.36	10.36	1.88	13.61	0.92	10.92
H ₂ O....	0.94	11.83	2.26	10.76
Total...	100.85	100.50	99.56	101.00	100.78	100.86	100.01	99.99	100.00	100.00

In 1848 Rogers Brothers ⁷ carried on some experiments to show the power of carbonated water in dissolving minerals of different kinds. The minerals were powdered and digested for 48 hours in carbonated water, and from 0.4 to 1 per cent of the whole mass was dissolved. When 40 grains of powdered hornblende were digested for 48 hours in carbonated water at a temperature of 60 degrees F., the following percentages were dissolved: Silica, 0.08; oxide of iron, 0.095; lime, 0.13; and magnesia, 0.095. It is to be understood that this process will not take place so rapidly under natural conditions because the minerals are more massive, but at the same time the process is going on constantly. Richard Müller has shown that during seven weeks of treatment of minerals with carbonated

water that 0.533 per cent of the entire weight of oligoclase, 1.536 per cent of hornblende, 0.307 per cent of magnetite, 2.018 per cent of apatite, 2.111 per cent of olivine and 1.211 per cent of serpentine were dissolved. The calcium, magnesium, and other alkalis were in solution in the form of carbonates. Carbonated water acts very readily upon limestone, and the caverns found in our large limestone deposits in Illinois, Indiana, Kentucky, and Virginia bear

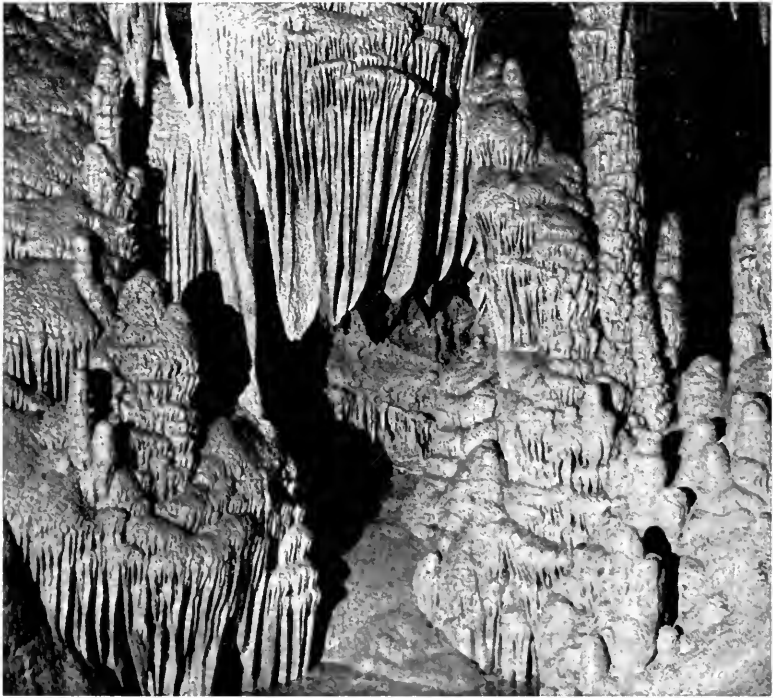

FIG. 13.—Stalactites and stalagmites formed in a cavern from limestone dissolved by carbonated water while passing through the rocks above. Rocks, Rock-Weathering and Soils, Merrill. (Courtesy The Macmillan Company.)

evidence of the great solvent power of water. It is stated that there are 150,000 miles of subterranean passageways in the limestone region of Kentucky, and practically all of this material was removed by carbonated water. In these caves the stalactites and stalagmites owe their origin to the limestone dissolved by the water before it enters the cavern (Fig. 13). The solution of the limestone has produced sinkholes on the surface that gives a peculiar topography

to cave regions. These sinkholes or basins vary in size from ten to two hundred feet or more across and from three to fifty feet in depth (Fig. 14). They vary in frequency as well as size. In some localities there are only a few small ones that are not objectionable,



FIG. 14.—Sinkholes in a cave region—Southern Illinois. The bottoms of the sinkholes are still occupied by brush. (H. C. Wheeler.)

while in other regions they are so large and frequent that the land is entirely worthless for cultivation. When the outlet from these to the cave becomes clogged, "sinkhole ponds" result (Fig. 15). In



FIG. 15.—The outlets of sinkholes sometimes become clogged and "sinkhole" ponds result. (H. C. Wheeler.)

Hardin County, Illinois, a lake varying in size from 100 to 400 acres was produced by the stopping of the sinkhole outlets.

The process of solution forms soil material by the removal of soluble substances, as in the case of limestone, leaving the impurities, or as in sandstone, by taking out the cementing material, leaving the incoherent sand, and in the case of igneous rocks removing some of the potash, soda, lime, magnesia, or some other compounds, and leaving a residue more or less modified as soil-forming material.

From the amount of lime carbonate carried by the Thames River it has been estimated that the average amount of this material dissolved from the limestone area drained by this stream is 143 tons per square mile in one year.⁹ It is estimated that on the average something like one-third as much matter is carried to the sea in solution as in the form of sediment, and that by this process alone land areas would be lowered something like one foot in 13,000 years.¹⁰

(g) **Plants.**—The roots secrete acids that attack the rocks and aid solution. The roots of a plant growing on a polished marble surface removed the polish by acid from the roots showing the action of the acids on the rock. While this action in the case of a single root is very slight, yet it plays a rather important part in aiding decomposition because of the infinite number of roots coming in contact with the soil particles, and their long-continued action. This may be shown where the surface^s of stones are covered with lichens. Enough rock is broken down to give higher plants, such as ferns, a chance to grow, and these in turn by the action of their roots and other agencies produce more soil material that encourages still higher plants to grow. These plants hold the material in place and allow sufficient accumulation to form soils. The action of the roots of plants on the minerals in soils is very important while they are alive, and even when they decay they aid materially in the solution and liberation of plant food and decomposition of rocks.

(h) **Animals.**—Many animals burrow in the soil, and their action on the minerals tends to aid decomposition and disintegration. This is especially important in the case of earthworms, ants, and similar animals. Many of these carry vegetable matter into the soil, which, by its decomposition, aids in the breaking down of minerals. Earthworms pass large quantities of soil through their bodies, the minerals of which are acted upon by the acids in the alimentary canal and partly decomposed. Even the larger rodents, such as gophers, ground squirrels, and mice exert considerable influence in

the formation of soils, both in the breaking down of minerals and in mixing of soil and subsoil.

QUESTIONS

1. Define weathering.
2. Distinguish between the two forms.
3. Does kaolin change into other minerals? Why?
4. In what ways do heat and cold disintegrate rocks?
5. Why does not a single hard freeze break all frozen rocks into fragments?
6. Give the principal glacial areas of the present time.
7. What is the law for the work of streams?
8. Give some good local example of erosion.
9. How do the waves do their work?
10. Why is the wind such an effective erosive agent?
11. What is the source of each of the acids that aid in weathering?
12. Why does the soil air contain more carbon dioxide than the atmosphere?
13. How does oxidation hasten the breaking down of rocks?
14. Does deoxidation aid in mineral decomposition?
15. Bring in a sample of feldspar that shows hydration.
16. Calculate the percentage of lime lost from each rock given in table on page 22.
17. Calculate the loss of magnesia in the same way.
18. How are stalactites and stalagmites formed?
19. Why are limestone soils so frequently acid?

REFERENCES

- ¹ American Journal of Science, volume xxii, 1832, p. 136.
- ² Dutton, C. E., Tertiary History of the Grand Cañon of the Colorado.
- ³ Merrill, G. P., Rocks, Rock-Weathering and Soils, 1906, p. 161.
- ⁴ Hilgard, E. W., Soils, 1906, p. 19.
- ⁵ Johnson, How Crops Feed, 1910, p. 139.
- ⁶ Merrill, G. P., Rocks, Rock-Weathering and Soils, 1906, p. 166.
- ⁷ American Journal of Science, volume v, 1848.
- ⁸ Merrill, G. P., Rocks, Rock-Weathering and Soils, 1906 (Adapted), pp. 195-202.
- ⁹ Prestwich, Quarterly Journal Geological Society, volume xxii, p. 47.
- ¹⁰ Reade, Liverpool Geological Society, 1876 and 1884.

CHAPTER III

THE PLACING OF SOIL MATERIAL

I. RESIDUAL, GRAVITY-LAID AND WATER-LAID DEPOSITS

THE mineral part of soils is derived from rocks through the work of the geological forces given. Only a small part of the disintegrated and decomposed rock material produces soil where first formed. By far the larger portion is moved from the place of its origin a few feet, or it may be thousands of miles. The material remaining in place produces sedentary soils.

I. SEDENTARY FORMATIONS

Sedentary Formations are those in which the greater part of the material was formed in place, as when rocks weather into débris fitted for the formation of soils, or when large amounts of organic matter accumulate through the growth and partial decay of mosses, grasses, sedges, and other plants. This class of formations is divided into residual and cumulose soils.

1. **Residual Soils.**—A residual soil is one formed *in situ* through the decomposition and disintegration of rocks and the action of organic agencies. It varies in composition with the rocks from which it is derived, and we have in general those materials (a) from igneous rocks, as granites, syenites, diorites, diabases and others; (b) from aqueous rocks, such as sandstones, limestones, shales; and (c) from metamorphic rocks, as gneisses, schists, marbles, and slates. By subsequent changes quite different soils result even from the same kind of rocks. The impression often prevails that most soils are residual. This, however, is not the case. Not over two per cent of the soils surveyed in the United States by the Bureau of Soils¹ are derived from igneous and metamorphic rocks, and not over five per cent from sedimentary rocks such as sandstones and shales.

2. **Cumulose Soils.**—Cumulose soils are formed by the accumulation of organic matter in undrained areas to such an extent that it forms a very large portion of the soil. These are divided into swamps and marshes. *Swamps* are fresh water formations, while the *marshes* are formed in brackish or salt water areas. The organic matter of these cumulose deposits is derived chiefly from mosses, sedges, and grasses, but almost any form of vegetation may add to the deposit. In north temperate and subarctic regions sphagnum

moss gives rise to immense deposits of peat, in some cases probably hundreds of feet in thickness. Grasses usually grow with the mosses and add to the accumulation. In more southern regions, grasses, cattails and sedges form a large part of the deposit, while in subtropical regions the palmetto and saw grass constitute the chief plants from which the organic matter is derived.

Swamps may be divided into river swamps, peat bogs, lake swamps, quaking bogs, climbing bogs, wet woods and ablation swamps. These terms are almost self-explanatory. *River swamps* may occur in the flood plain where ox-bow lakes, representing



FIG. 16.—Ox-bow lakes formed by shifting of channel, A, B and C. Sedimentation on inner side of curve. (Shaler.)

former channels, have been transformed into swamps by filling with both organic matter and sediment (Fig. 16). In wide flood plains low swampy land may lie back toward the bluffs away from the river. Delta lands are usually swampy.

Peat deposits may be formed (1) in low places where the water is shallow but the supply constant (Figs. 17 and 18). This type is found in sand dune or gravelly areas where the water seeps out at the base of sand hills or gravel terraces. Peat formed in this way is rarely of any great depth. Peat bogs may also be formed (2) as shown in figure 19. The sphagnum moss begins to grow at the margins of the lake and extends out over the water, forming a *quaking bog*, and up the bank, as a *climbing bog*. The growth over the water is quite rapid and the small pond or lake may become

covered with a floating mass of vegetation which soon becomes sufficiently solid to form a support for other plants such as rushes, grasses, and sedges. The growth of these soon so strengthen this floating mass that still other species of swamp vegetation, including



FIG. 17.—Typical eastern swamp land. The grass will be preserved from decay in the water. Leaves from the forest will add to accumulation. A soil rich in organic matter will result.



FIG. 18.—Florida everglades.

some shrubs, gain a foothold. Forest trees may ultimately cover it. While the process above described is taking place partly decayed vegetation is dropping to the bottom of the lake from the under side of the floating mass, and this accumulation may go on till the



FIG. 19.—Section showing one step in the filling of the lake with peat; *cc*, moss growing on surface of lake; *dd*, partly decayed peat that has fallen from floating mass; *cc*, climbing bog. (Shaler.)

pond or lake becomes completely filled. Accumulations of peat also occur around springs, giving rise to quaking bogs (Fig. 20). In poorly drained areas the moss may grow on the surface of the soil in sufficient amounts to form peat. Oftener, however, it forms only a soil rich in organic matter.

A *wet woods swamp* is where a forest area with a slope of less than five degrees has been transformed into a swamp through the accumulation of vegetable material and the consequent increase of moisture. The original forest may be entirely destroyed and replaced by plants adapted to swamp conditions.

An *ablation swamp* is produced by the solution and carrying away of certain more soluble strata, such as gypsum, salt or even limestone, between less soluble strata, thus causing a lowering of the surface and bringing about swamp conditions.

II. TRANSPORTED FORMATIONS

Various agencies are engaged in the movement of soil material, namely: gravity, water, ice, and wind, and the deposits formed by



FIG. 20.—Hummocks 6 to 12 inches high, found in swampy places produced by trampling of stock. Commonly called "bogs." (R. W. Dickenson.)

these are known as colluvial, sedimental, glacial, and eöial. During the transportation of these materials many particles are reduced in size and other changes brought about. Over ninety per cent of the soils surveyed by the Bureau of Soils¹ in the United States are formed from transported material.

1. **Colluvial or Gravity-laid Soils.**—Gravity might be said to be the active agent in the formation of all of the above, but gravity, unaided, is very limited in its work, being confined to areas of vertical cliffs or very steep slopes. The material transported by gravity and deposited at the base of cliffs consists of a heterogeneous mixture of detritus that has been loosened by the processes of weathering and carried downward by gravity. This accumulation is commonly designated as *talus* or *cliff débris* (Figs. 21 and 22).

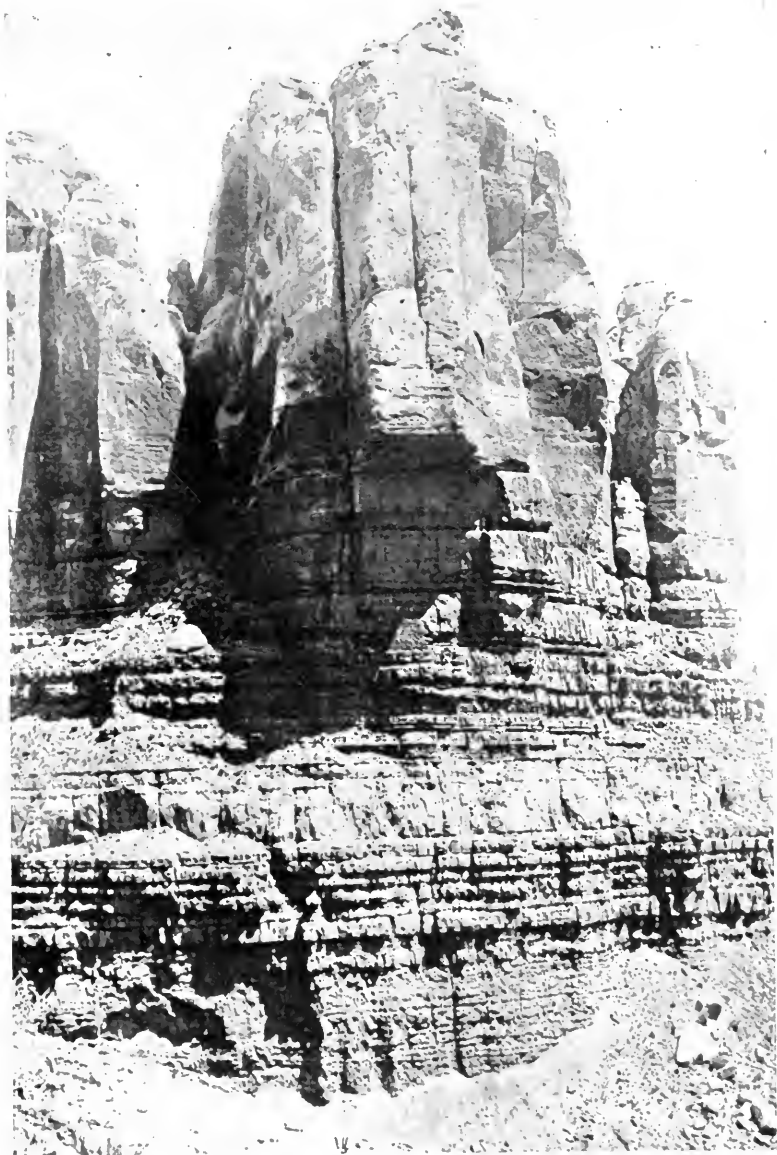

FIG. 21.—Weathering of jointed rock above and thin bedded beneath. Note talus deposit at base. Near Bluff City, Utah. Rocks, Rock-Weathering and Soils, Merrill (Courtesy the Macmillan Co.)

It shows very little or no assorting action, although in some cases the finer material may be washed out by water and deposited at the base, thus leaving the coarser material higher up on the slope, while



FIG. 22.—Rock disintegration and formation of talus slope. More advanced stage. Mount Sneffels, Colo. (Merrill.)



(From Elements of Geology, Copyright 1911, by Elliot Blackwelder and Harlan H. Barrows. American Book Company, Publishers)

FIG. 23.—The side of a ravine near Crawfordsville, Indiana. The more rapid creep of surface material has caused the trees to lean down hill.

in other cases the coarser material may roll down the slope to a greater distance, leaving the finer at the top. This process of weathering and downward movement of material will finally transform the vertical cliff into a steep slope which will represent the angle

of rest of the detritus. The downward movement does not stop here, for there is a certain amount of "creep" due to freezing and thawing, and the action of water aided by gravity (Fig. 23) that ultimately reduces the slope so that it may be cultivated. These talus slopes are small in extent and are of very little agricultural value because of their stony character.

2. **Sedimental or Water-laid Soils.**—The material forming these deposits has been carried in suspension or rolled along the beds of streams for a greater or less distance from their place of origin. When a body is immersed in water, it loses weight equal to the weight of the water displaced by it. This buoyant effect enables fine particles to remain in suspension for a long time and renders coarser material more easily moved than when in the atmosphere. The total amount of material carried by running water varies as the fifth² power of its velocity while the size of particles carried varies as the sixth power, so that doubling the velocity increases the amount of material thirty-two times and the size of material carried sixty-four times. If the velocity were trebled the amount is increased two hundred and forty-three and the size is increased seven hundred and twenty-nine times. Then if a given current carries particles .1 mm. in diameter doubling its velocity enables it to carry material 6.4 mm. in diameter, or trebling the velocity enables it to carry particles 72.9 mm. in diameter. The following table shows the character of material that may be carried or swept along by the current.

The Material Carried by Water of Varied Velocity²

Inches per second	Miles per hour	
3.....	0.170	—will just move fine clay.
6.....	0.240	—will lift fine sand.
8.....	0.4545	—will lift sand as coarse as linseed.
12.....	0.6819	—will sweep along fine gravel.
24.....	1.3638	—will roll rounded pebbles 1 inch in diameter.
36.....	2.045	—will sweep along slippery, angular stones the size of an egg.

Another factor in the transportation of soil material is given by King.⁴ When a particle is immersed, it attracts a film of water, which becomes an essential part of the particle, moving with it wherever it goes. The specific gravity of soil particles is approximately 2.65. The immersed solid-liquid body has such low specific gravity that very little force is required to keep it in suspension and so it becomes possible for a particle to be carried hundreds of miles. This adherent film averages about .05 mm. in thickness. By computation we find that a clay particle .001 mm. in diameter with



FIG. 24.—Mud flow. A form of movement intermediate between colluvial and sedimental, Colorado. (U. S. Geol. Survey.)

a film .01 mm. thick has a specific gravity of 1.0002. This is so near the specific gravity of water that the particle will remain in suspension indefinitely. Professor King estimates that a force of only 4.4 pounds is necessary to keep the 11 tons of sediment in suspension that is delivered at the mouth of the Mississippi River each second. The increase of the effective diameter of the particle augments the effective cross-section 441-fold, and so only a very small vertical motion would be required to maintain suspension. The effective volume would be increased 9,261-fold by the adhering film. When a particle of dust is suspended in the atmosphere it attracts a film of air which moves with it in the same way as the film of water and lessens its specific gravity, thus enabling it to be held in suspension with a much smaller force than would otherwise be necessary. The specific gravity of a clay particle .001 mm. in diameter, with an adherent film of air, is 1.2336. For computing the specific gravity of a particle immersed in water the following formula may be used:

$$\text{Sp. Gr.} = \frac{\frac{\pi d^3 \times \text{sp. gr.}}{6} + \left(\frac{\pi D^3}{6} - \frac{\pi d^3}{6} \right)}{\frac{\pi D^3}{6}} = \frac{d^3 \times \text{sp. gr.} + (D^3 - d^3)}{D^3}$$

$$\frac{\pi D^3}{6} = \text{volume of a sphere.}$$

d = diameter of particle or solid nucleus

sp. gr. = specific gravity of the nucleus

D = diameter of solid-fluid system

Sp. Gr. = specific gravity of the solid-fluid system

The amount of material carried by the Mississippi River and deposited in the Gulf of Mexico annually is equivalent to the removal in 6,000 years of a layer one foot thick over the entire drainage area.

*Amount of Sediment Carried in Suspension Annually*⁵

River	Drainage areas in sq. mi.	Mean annual discharge in cu. ft. per second	Total tons annually	Ratio of sediment to water by weight	Height in ft. of column of sediment, base 1 sq. mi.	Thickness of sediment, in. if spread over drainage area
Potomac...	11,043	20,160	5,557,250	1: 3,575	4.0	.00433
Mississippi	1,244,000	610,000	406,250,000	1: 1,500	241.4	.00223
Rio Grande.	30,000	1,700	3,830,000	1: 291	2.8	.00116
Uruguay...	150,000	150,000	14,782,500	1: 10,000	10.6	.00085
Rhone.....	34,800	65,850	36,000,000	1: 1,775	31.1	.01075
Po.....	27,100	62,200	67,000,000	1: 900	59.0	.01139
Danube....	320,300	315,200	108,000,000	1: 2,880	93.2	.00354
Nile.....	1,100,000	113,000	54,000,000	1: 2,050	38.8	.00042
Irrawaddy..	125,000	475,000	291,430,000	1: 1,610	209.0	.02005
Mean.....	334,693	201,468	109,649,972	1: 2,731	76.65	.00614

Classes of Sedimental Soils.—There are three classes of sedimental soils, marine or sea-laid, lacustrine or lake-laid, and alluvial or stream-laid.

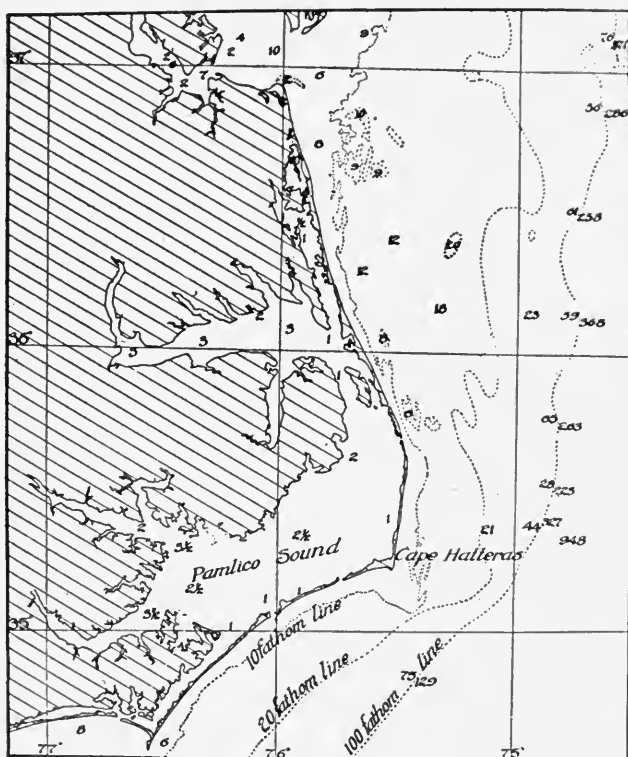

FIG. 25.—Map showing the early stages in the formation of coast marshes. The numbers indicate the depth of water in fathoms. (C. and G. Survey.)

(a) The **marine** or sea-laid deposits are formed along sea coasts (Fig. 25) and include bars, spits, hooks, and marshes. Bars frequently produce lagoons that ultimately become marshes. Marine

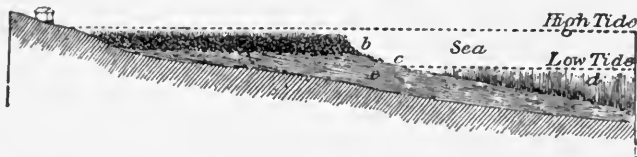

FIG. 26.—Section of marine marsh; b, grass marsh; c, mud bank, or mud flats; d, eel-grass. (Shaler.)

and salt marshes are divided into those above mean tide, as the grass marshes and mangrove marshes, and those below mean tide, mud banks and eel-grass areas (Fig. 26). The mangrove marshes occur along the Florida coast and have played a very important part in adding to the land area (Fig. 27). The other form of marshes occur in more northern regions, the grass marshes being



FIG. 27.—Mangrove marsh, Biscayne, Florida. This mangrove advances into the water by throwing out new roots. (From *Elements of Geology*. Copyright 1911, by Eliot Blackwelder & Harlan H. Barrows. American Book Company, Publishers.)

sufficiently high so that they are covered only during the highest tides. The eel-grass banks are always covered, while the mud bank is intermediate between these. Holland is an illustration of what the marsh lands may become when drained and protected by dikes.

(b) **Lacustrine.**—Lacustrine or lake-laid deposits consist of



FIG. 28.—Level floor of Lake Chicago, with the shore-line in the distance. (R. W. Dickenson.)

(1) terraces and beaches representing old water levels and shores and (2) the beds of extinct lakes. During glacial times, many lakes were formed by the obstruction of drainage and many more

were filled to a greater or less height with gravel and sand. Lake Agassiz, covering a large area in Minnesota, North Dakota, and Canada, represents the former, while Lake Chicago (Fig. 28), an extension of Lake Michigan to the south, and Maumee Lake, an enlargement of Lake Erie, are examples of the latter (Fig. 41).



FIG. 29.—Terraces of Frazier River at Lilloet, B. C. Six in number. (Chamberlain and Salisbury, Courtesy Henry Holt & Co.)

All of the Great Lakes were much more extensive than now and subsequent drainage lowered the water and exposed parts of the old bed which now constitute lacustrine deposits. These give us some of our best soils. Loess and adobe may be formed, in part at least, in lakes.

(c) **Alluvial.**—The alluvial, or stream-laid deposits, include, first, terraces, commonly called second bottom or bench lands, that



FIG. 30.—Terrace along Creek, near Rockford, Illinois, showing stratification. (H. W. Stewart.)

represent the former flood plains of streams which now flow at a lower level; second, first bottom lands, or present flood plains; third, deltas; and fourth, alluvial cones and fans.

Terraces originate in three ways: (1) those formed by deposition of material from *overloaded streams* giving rise to sand, gravel, or silt terraces (Fig. 29). These occur principally along the streams that carried the drainage from the melting glaciers.



FIG. 31.—Closer view section of gravel terrace of Fig. 30. (H. W. Stewart.)

When the current decreased, the load was dropped and the valleys were filled to a greater or less height with gravel and sand. In some cases the valleys were filled almost to a level with the upland (Figs. 30 and 31). Farther down the stream the terrace became lower and the finer material was deposited. When the glacier retreated, the stream, having no load to carry, would begin to cut down through the gravel and soon this formation would be much above the stream and constitute a terrace, second bottom, or bench land. The same action might take place down the stream where the finer material was deposited. (2) Those formed through *elevation of land* and consequent rejuvenation of the stream, thus causing it to cut down through and abandon the old flood plain and form a new

one. (3) Those formed by *ponding of tributary streams* due to the building up of the flood plain of the main stream more rapidly than that of the tributaries. In this way the lower part of the tributary valley is formed into a lake which would receive a deposit of fine material from the tributary but coarse from the intruding waters from the main stream during floods. A reduction of the water supply and the amount of sediment carried by the main stream will enable the tributary to cut down into the flood plain, drain the lake, and form a new valley in the fill. Good examples of this are

seen along the tributaries of the Mississippi and Wabash Rivers. The very heavy soils along these have been formed in this way.

QUESTIONS

1. What are sedentary formations?
2. Distinguish between residual and cumulose soils.
3. Give history of an ox-bow lake; its formation and filling.
4. Give four ways in which lakes may become extinct.
5. What conditions give rise to peat?
6. How is peat formed?
7. What is a climbing bog and how formed?
8. How may a wet woods become a swamp?
9. Draw a diagram showing how ablation swamps may be formed.
10. How are colluvial soils formed?
11. What is meant by the "creep" of material on hillsides?
12. What are the laws for the carrying power of running water.
13. Give an example of this power.
14. What is the specific gravity of a soil particle .01 mm. in diameter and its inclosing film of water .05 mm. thick?
15. How long would be required for the Potomac River to remove 12 inches³ of material from its drainage basin at the rate given in table p. 35?
16. What are the divisions made of marshes?
17. What are the forms of lacustrine deposits?
18. How are terraces formed?

REFERENCES

- ¹ Marbut, C. F., Bennett, H. H., Lapham, J. E., and Lapham, M. H., Bulletin 96, Bureau of Soils, U. S. D. A., 1913, p. 10.
- ² Deacon, G. F., Inst. Civil Engineering Proceedings, volume 118, 1894, p. 93-96.
- ³ Geikie, Textbook of Geology, 3rd edition.
- ⁴ King, F. H., Suspension of Solids in Fluids and the Nature of Colloids and Solutions, Transactions Wisconsin Acad. Sci., Arts and Letters, volume 16, part 1, 1908.
- ⁵ Babb, Science, volume 21, 1893, p. 343.

General References.—McGee, W. J., Bulletin 71, Bureau of Soils, U.S.D.A., 1911, Soil Erosion. Davis, R. O. E., Bulletin 180, U.S.D.A., 1915, Soil Erosion in the South. Salisbury, R. D., Agencies which Transport Material on the Earth's Surface, Journal of Geology, volume iii, p. 170.

CHAPTER IV

THE PLACING OF SOIL MATERIAL (Continued) II. GLACIAL OR ICE-LAID DEPOSITS

THE glaciers and ice sheets of former times covered extensive areas with deposits of material that may be divided into morainal, intermorainal, drumlins, kames, and eskers. During the glacial period, practically all of North America north of the Ohio and Missouri Rivers, amounting to 4,000,000 square miles, was covered with an ice sheet (Fig. 32) that had gradually pushed southward



FIG. 32.—Front of Chenega Glacier compared with Washington Monument, 550 feet high.
(Lawrence Martin.)



FIG. 33.—Very stony and gravelly phase of glacial drift near Whitewater, Wisconsin
(King.)

from three centers of accumulation in Canada. The northwestern half of Europe was covered at the same time. Vast quantities of material of all sizes and all kinds of rocks were transported and deposited when the ice melted, leaving a mantle of boulder clay, drift, or till, varying from a few inches to several hundred feet in thickness. The average depth of the deposit for Illinois, according to Leverett,¹ is about 115 feet. These glacial deposits constitute the material from which the soils were formed over a large area east and north of Illinois, but in the middle west a deposit of loess has buried the drift, producing soils of an entirely different character (Fig. 33). In glaciated Europe the same conditions exist in regard to soils.



Fig. 34.—Limestone boulder showing glacial scratches. Urbana, Ill.

The drift left by glaciers is only one of the important things accomplished by them. The enormous pressure of the ice, 40 pounds per square inch for each hundred feet in thickness, enabled it to wear down hills and fill valleys, especially if they extended nearly at right angles to the direction of the movement. Otherwise it might deepen and broaden them, but on the whole its effect has been to leave the country more nearly level than before. Many regions have been transformed from hilly areas of low agricultural value to undulating or rolling lands well adapted to agriculture. The ice in its movement southward picked up large quantities of detritus of all kinds and sizes and ground it into fine material fitted to form soils. Much of this material was carried from 400 to 1,000 miles or more and during its transportation boulders (Fig. 34) and gravel would rub and grind against each other and against the rock sur-

faces over which they moved (Fig. 35), producing immense quantities of rock flour. The whole glacier was an immense mill that was slowly grinding rocks into powder. This rock flour was lib-



FIG. 35.—Glacial grooves or striae on rock surface. Northern Ohio. (From *Elements of Geology*, Copyright 1911, by Eliot Blackwelder & Harlan H. Barrows, American Book Co.)



FIG. 36.—Typical topography of terminal moraine near Oconomowoc, Wisconsin. Wisconsin Geol. Survey. (Fenneman.)

erated by the melting ice and was distributed over the land by water and wind, forming the very best of soil material. In some instances it was carried much farther than the limit of the ice sheet and distributed as immense aprons beyond the ice front.



FIG. 37.—Drumlins—remnants of former terminal moraines. (U. S. Geol. Survey.)



FIG. 38.—Drumlin—transverse view. By Alden. (U. S. Geological Survey.)



FIG. 39.—Adeline esker, Ogle County, Illinois. This esker is over nine miles in length. (R. W. Dickenson.)

The material carried and pushed along by the ice is usually very irregularly distributed, giving the glaciated areas an undulating to rolling topography. The ridge formed at the terminus of the glacier is the *terminal moraine* (Fig. 36). It usually presents a steep outward slope with a very gradual inward slope. The surface of the moraine is rolling, billowy, or has "rounded knob and basin" topography. The height of moraines may vary from a few feet to several hundred, while the width may be from a half mile to ten miles or more. Recessions and advances of the glacier may build up new moraines or override old ones, tearing them down completely or transforming the material into lenticular hills, called *drumlins* (Figs. 37 and 38), whose longer axis is in the direction of movement of the latest ice sheet.

Super- and subglacial streams formed hills of gravel and sand called *kames*, or ridges of the same material called *eskers* (Figs. 39 and 40).



FIG. 40.—The material composing Adeline esker consists of coarse sand and gravel. The ledge is conglomerate formed by cementing the sand and gravel with carbonate of lime. (R. W. Dickenson.)

The Glacial Period.—The three centers of accumulation in North America during the glacial period were the Labradorian in Labrador, the Keewatin immediately west of Hudson Bay, and the Cordilleran in the Rocky Mountains of Canada. These centers covered large areas (Fig. 42), and ice movement started from these in practically all directions, but probably not from all centers at the same time, or at least not to the same extent. Smaller centers of ac-

accumulation existed in the Rocky and Sierra Nevada Mountains and on the Island of Newfoundland. In Europe (Fig. 43) the Scandinavian was the principal and the Ural, a secondary center. The glaciers of the Alps and Caucasus were much more extensive than at present.

(a) **The Jerseyan or Nebraskan Glaciation and Aftonian Interglacial Stage.**—The first glacial advance probably came from the Keewatin center and is called the Jerseyan or the Nebraskan, because small areas of surface deposits made by this glacier are found in those states. All other deposits of this advance have been buried by subsequent ice sheets and it is difficult to make a careful study of them because of superposed material. There is no evidence that the area between New Jersey and Nebraska was covered by



FIG. 41.—Map showing extent and southern limit of glaciation in North America. Also Lakes Agassiz, Lahonton and Bonneville. (Compiled from several sources.)

this ice sheet. This glacier receded and the drift deposited by it became eroded, weathered and the surface was changed into soil. Even peat beds were formed in undrained areas. This interglacial stage is known as the Aftonian.

(b) **The Kansan Glaciation and Yarmouth Interglacial Stage.**—The second glacial advance was from the Keewatin center also, and extended into Iowa, Illinois, Nebraska, and Kansas, and derived its name from the exposure of drift in the latter state. After the ice receded soil was formed from the surface of the drift

and organic matter accumulated as peat in some swampy areas. This stage is known as the Yarmouth.

(c) **The Illinoian Glaciation and Sangamon Interglacial Stage.**—The third glacial advance was from the Labradorean

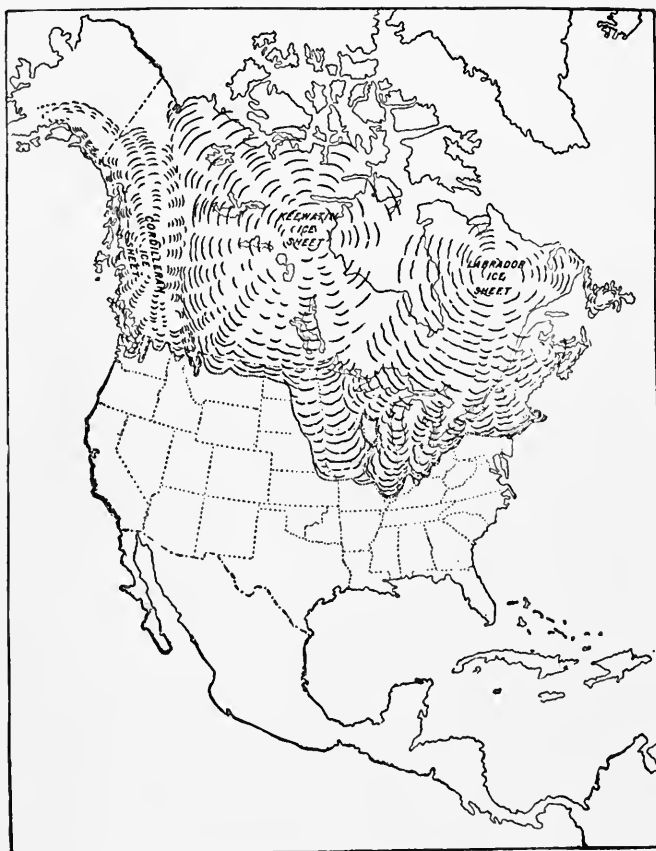

FIG. 42.—Map showing the three centers of ice accumulation in North America. (Chamberlain and Salisbury. Courtesy Henry Holt & Co.)

center and was the most extensive in the middle west during the entire period of glaciation. The greatest area of surface deposits is in Illinois, hence the name. It is exposed in Ohio, and Indiana, also. This glaciation was followed by a long interglacial stage during which weathering and soil formation occurred. It is known as

the Sangamon stage (Fig. 44). Peat deposits have been found as much as 22 feet in thickness that were formed during this period.

(d) **Iowan Glaciation, Loess Deposits and Peorian Interglacial Stage.**—The Sangamon interglacial stage was followed by the Iowan advance from the Keewatin center and covered a considerable part of Minnesota, Wisconsin, northeastern Iowa and the northern part of Illinois. The conditions at the time of the melting of this glacier gave rise to extensive loess deposits. During sum-

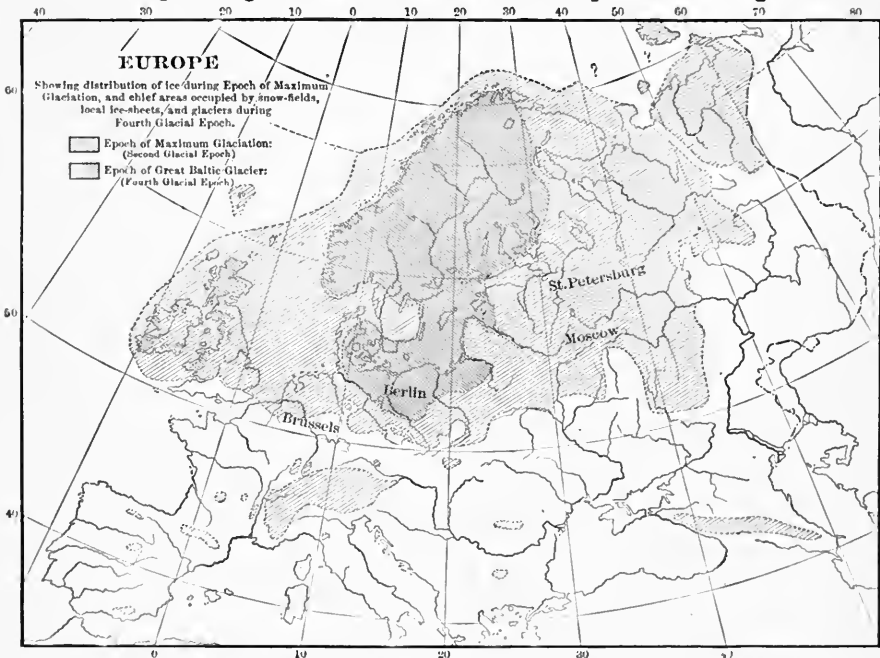

FIG. 43.—Map showing extent of ice-sheet, Europe. (Reproduced from Dana's Manual of Geology, by special arrangement with American Book Company.)

mer the melting was very rapid so that the flood plains of streams draining from the glacier received deposits of rock flour during these periods of overflow. During times of little melting the streams contracted to their ordinary channels, leaving the material exposed on their flood plains. This was picked up by the wind and distributed over the upland where it occurs as a deposit from 3 to 150 feet in thickness over part of the states bordering the Mississippi and Missouri Rivers. The loess buried the Sangamon soil.

The Peorian interglacial stage followed the Iowan glaciation,



FIG. 44.—A section showing the black Sangamon soil with the Illinois glacial drift beneath and the Iowan loess above, with the present soil on the surface. Knox County, Illinois. (F. Leverett, U. S. Geol. Survey.)



FIG. 45.—A section showing (a) Bloomington gravel; (b) Shelbyville till sheet; (c) Iowan loess; (d) Sangamon soil; (e) Silt below peat. (Dr. Samuel Calvin, U. S. Geol. Survey.)

during which the surface loess was changed into soil which was later buried in part by subsequent glaciers. The soils and peat beds of the Peorian stage contain remains of cedar trees which grew in the extensive swamps that existed at that time.

(c) **Early Wisconsin Glaciation, Loess and Interglacial Stage.**—The Peorian stage was ended by another ice advance known as the Early Wisconsin (Fig. 45), which came from the Labradorian center of accumulation and formed a very extensive advance reaching into Iowa, Illinois, Indiana, Ohio, Pennsylvania and covering practically all of New York and the New England states. This glacier built up a system of moraines in the middle west that is one of the most characteristic features. The terminal moraine of the greatest advance is usually a distinct ridge. In Illinois and Indiana it is known as the Shelbyville moraine. This glacier made several advances and recessions, building up a moraine with each advance, giving a series somewhat concentric with Lake Michigan and other Great Lakes. A deposit of loess covers this drift in Illinois and parts of Indiana to a depth of from three to six feet. This glaciation was followed by a comparatively short unnamed interglacial stage.

(f) **Late Wisconsin Glaciation.**—This stage was terminated by an ice advance, the late Wisconsin, from all centers of accumulation and in addition from many local centers. It was one of the most extensive and uniform ice sheets during the entire glacial period. The ice front did not extend southward as far as some other advances except in New England, but there was probably a solid ice front from the Atlantic to the Pacific. The erosive and transporting power of the ice seemed to have been greatest at this time, as is shown by the very high and characteristic moraines formed near some of the Great Lakes.

Incidental Features.—Certain incidental features were developed in connection with the glaciers that served to modify the soils in many regions. The drainage from the melting ice during part of the time was entirely to the south. The streams were flooded and overloaded with sediment, the deposition of which built up terraces of gravel, sand, silt, and even clay. When the glacier had receded so that the region in northern United States was partly covered, the outlet of the lakes, which is naturally to the north and northeast, was obstructed so that they overflowed the margin of the basins and drained into the Mississippi River. Lake Agassiz, the enlarged Lake Winnipeg, is responsible for the soils of the Red River

valley. (Fig. 41). Lake Chicago, the extension of Lake Michigan, Lake Maumee, an extension of Lake Erie, and other lakes at Green and Saginaw Bays produced lake-laid soils and formed characteristic beaches.

The material deposited by the glaciers is of every grade from the finest clay to boulders weighing many tons (Fig. 46). Its value



FIG. 46.—Granite boulder weighing about 30 tons, at depot of Northwestern R. R., Waukegan, Ill.



FIG. 47.—Heap of boulders collected from a moraine in northern Illinois. (R. W. Dickenson)

for forming soils depends upon its fineness and the rocks from which it was derived. Many areas known as boulder belts contain so many boulders that it is impossible to cultivate the soil, while in others they were not so abundant but that it is practicable to remove them. These boulders are sometimes used for making fences, or piled up on waste land (Fig. 47).

In many cases where the glacier passed over rather soft rocks, such as sandstones or shales, large amounts of this were picked up and pushed along and sometimes formed a very large part of the deposit. The soil formed from it is very inferior. Where the crystalline rocks, such as granites and syenites, are mixed with limestones a very fertile soil results.

Most of the boulder clay is sufficiently fine for good soils, although nearly the entire glaciated area contains some boulders. In the middle west the drift is covered with a layer of fine wind-laid material.

QUESTIONS

1. What was the extent of the ice sheet during the glacial period?
2. To what extent was material deposited?
3. What pressure did the ice exert?
4. How are terminal moraines formed?
5. Distinguish between kames, eskers, and drumlins.
6. Name and locate the centers of accumulation in North America and Europe.
7. Tell about the Jerseyan or Nebraskan glaciation.
8. Give the facts in regard to the Kansan advance.
9. Tell about the Illinoisan glaciation.
10. What was characteristic of the lowan?
11. What was the extent of the Early Wisconsin advance?
12. What was the extent of the area covered by the Late Wisconsin?
13. What effect did this have on drainage?
14. Give some illustrations.
15. What are boulder belts?
16. What was the general effect of glaciers on soils? On topography?
17. What is boulder clay?

REFERENCES

- ¹Leverett, F., Illinois Glacial Lobe, Monograph 38, U. S. Geol. Survey, 1899, p. 549.

General References.—Leverett and Taylor, Monograph 53, U. S. Geol. Survey, The Pleistocene of Indiana and Michigan and the History of the Great Lakes, 1915, op. Cit. Complete Bibliography, pp. 33-54. Chamberlain and Salisbury, Geology, volume iii, Earth History, The Cause of the Glacial Period, pp. 424-446. Wright, G. F., The Ice Age of North America and Its Bearing on the Antiquity of Man, New York, 4th ed., 1896, pp. vii-xxv, 315-358.

CHAPTER V

THE PLACING OF SOIL MATERIAL (Continued)

III. EÖLIAL OR WIND-LAID DEPOSITS

THE statement has been made that every square mile on the earth's surface has received particles from every other square mile. Whether this is absolutely true or not, it shows that a very wide distribution of material has been going on, and this distribution has been brought about by the agency of wind. No place on the earth's surface is free from dust. Even the snow on the great continental ice sheet of Greenland contains a perceptible amount. Dust storms all over the world are carrying fine material into the upper atmosphere, where it is transported for thousands of miles, falling on all parts of the earth. Dust falls have occurred in which a measurable amount has fallen in a few hours. In Indiana in 1895 a snow fall was colored brown by the large amount of dust it contained. One sample, collected just after the storm, contained .37 per cent of dust by weight. The same year a sample of snow collected in London contained 10.65 grains of solid material per gallon of water from the melted snow. Darwin observed that the water in the Atlantic 300 miles from the coast of northern Africa was distinctly colored by the dust, and that dust was falling in the ocean in perceptible quantities 1,600 miles from the Desert of Sahara. The sirocco winds of the Sahara sometimes carry dust in perceptible quantities as far north as Scotland. Professor J. A. Udden¹ estimated that during an ordinary breeze a cubic mile of air will contain 225 tons of dust, while in a heavy storm it will contain 126,000 tons (Fig. 48). The dust picked up by winds together with that thrown into the atmosphere by volcanoes has played an important part in the formation of soils.

Classes of Wind-laid Material.—The wind-laid deposits are dunes, loess in part, adobe in part and volcanic dust.

1. **Dunes.**—Sand is the common constituent forming dunes, but other materials sometimes compose them. Clay and silt dunes are not unusual. Coffey² found clay dunes in southern Texas, while silt dunes are frequently met with in areas of deep loess. Many of these are found on the eastern borders of the Mississippi

and Illinois Rivers, notably in Carroll, Whiteside, Rock Island and St. Clair Counties in Illinois. The conditions necessary for the formation of sand dunes are a supply of sand and a somewhat high and constant wind. Sea and lake shores furnish excellent conditions for the formation of sand dunes. The waves throw the sand upon the beach and the strong winds which so often prevail there carry it landward. Shaler estimates that ninety per cent of the coast line of the world is fringed with sand. The total dune area of Europe is 4,562,000 acres, while the sand wastes add about 9,000,000 acres more.



FIG. 48.—A dust storm in Kansas, May 26, 1912. (Jardine, *Jour. Am. Soc. Agronomy*, Vol. 5, No. 4.)

Sand is not raised far above the surface as in the case of dust, and a shrub, a tuft of grass or a fence may give lodgment to the sand and origin to a dune. After accumulations have once begun by means of an obstruction, the dune itself will furnish the necessary conditions for growth. In shape, dunes may be either in the form of hillocks, crescents, or ridges, transverse or parallel to the prevailing winds. The shape of the individual dune is a steep leeward and a gradual windward slope, especially where the prevailing wind is constantly from the same direction.

Sand dunes are of two classes, migratory or wandering (Fig. 49), and permanent or fixed. With a constant wind, dunes migrate or advance a few feet each year, burying objects in their paths.

Even villages and forests cannot withstand the advance of sand dunes. The usual height is from ten to thirty feet, but some have been found 300 feet high. Through some temporary change in climate, as increased rainfall or diminished wind velocity, vegetation may start on the sand and gain such a foothold that the dune becomes *fixed* or *permanent*. This fixed feature is sometimes



FIG. 49.—Sand dune advancing over forest, Beaufort Harbor, N. C. (U. S. Geol. Survey.)

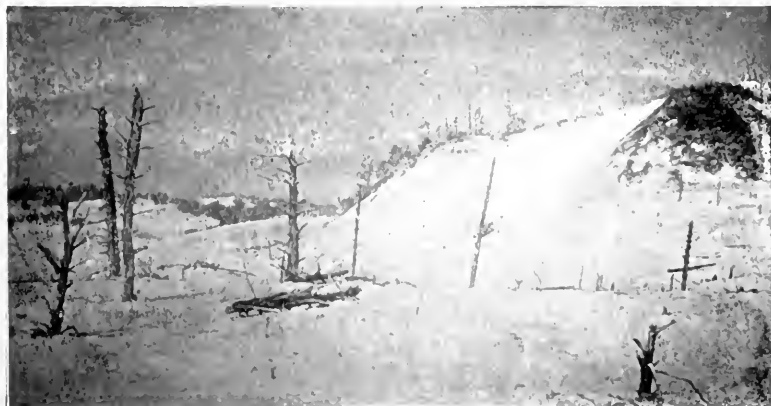

FIG. 50.—A resurrected forest, Dune Park, Indiana. (Chamberlain and Salisbury, Courtesy Henry Holt & Co.)

brought about by plantings on the windward side. In Denmark, Prussia, Scotland, Massachusetts, and North Carolina, beach or marram grass (Fig. 52) whose roots extend to a great depth



FIG. 51.—Wind ripples on sand dune. (Cross, Chamberlain and Salisbury, Henry Holt & Co.)



FIG. 52.—Transplanting beach or marram grass. (Bureau of Plant Industry.)



FIG. 53.—The grass in the foreground holds the sand which drifts from the "waste" beyond the fence. (U. S. Dept. of Agriculture.)



FIG. 54.—Sand is being held by vegetation. In this way wandering dunes may be changed to permanent ones. (U. S. Dept. of Agriculture.)

has been used quite extensively to hold the sand. This grows luxuriantly as long as the sand is drifting, but dies and is replaced by other forms of vegetation as soon as movement ceases. After fixation is accomplished certain varieties of trees may be



FIG. 55.—Fences being used to check the movement of sand. (U. S. Dept. of Agriculture.)

planted, transforming these dunes into valuable forest lands. Permanent or fixed dunes may be changed to *migratory* ones by injudicious management, such as very close grazing, tillage or anything that destroys or removes the protecting vegetation. This has occurred in some western states where close grazing by sheep has destroyed the vegetation so that sand movement has begun. Michigan, Illinois, Wisconsin and Indiana have considerable areas of sand dunes. A large part of these areas is covered with a scrubby growth of black oak and other trees, which furnish complete protection. When this growth is removed, however, it is very difficult to hold the sand and it is the part of wisdom to leave even the poor growth of forest for purposes of protection. The dune areas covered with prairie grasses peculiar to the sand present different problems. As a general rule, there is sufficient organic matter in the surface six to eight inches to hold the sand particles. When the soil is cropped or pastured, some of this surface soil may be removed by the wind in exposed places, forming

what is called a "blowout" (Fig. 56). The tendency is for this to increase in size and often results in ruining large areas. To reclaim these "blowouts" it is necessary to grow legumes, plants able to take their nitrogen from the air. The black locust (Fig. 57)



FIG. 56.—Large "blowout" in sand area. Numerous small ones may be seen in the distance. Mason County, Illinois



FIG. 57.—Black locusts (*Robinia pseudo acacia*, L.), growing on sand to the right, drifting sand on left. (L. A. Abbott.)

is probably one of the best, although if the common sensitive plant, the partridge pea (*Cassia chamaecrista*), can get a start it will stop the movement. The trailing wild bean (Fig. 58) is another plant that grows luxuriantly on sand and does much toward building up

the soil. The particular advantage of this is that it reseeds itself and follows rye and wheat with a good growth of renovating material. Bunch grass grows very well upon the blowouts and fre-



FIG. 58.—The trailing wild bean (*Strophostyles helvola*, Britton) makes a large growth that not only protects the sand against blowing but adds organic matter and nitrogen to the soil. Illinois.



FIG. 59.—Pines growing on sand dunes in England at Burry Port. (Carmarthen.)

quently is the means of stopping the movement. The use of pines for this purpose is shown in figure 59.

2. **Loess.**—Sand dunes are limited to regions where sand is abundant and where vegetation does not prevent its being moved.

It is never carried any distance by the wind but is rolled along the surface of the ground. Sand dunes rarely travel more than ten or fifteen miles. Finer material, however, may be picked up by the wind and transported for hundreds or even thousands of miles. This brings about a very wide distribution of the finer soil material. In many cases this is carried in sufficient amounts to form deposits several hundred feet in thickness. This fine deposit has been called "loess" by the Germans and the term is applied to the same deposit in this country. Loess is distributed over a large area in North America, comprising over 600,000 square miles, but is really limited to the states bordering the Mississippi River and its tributaries. Its depth varies from two to six feet over the principal part of this loess-covered area, but near the larger streams reaches a depth of 25 to 150 feet. In Europe the loess is not so generally distributed as in North America, but occurs in somewhat isolated areas and seldom over 12 feet in depth. It extends, however, from northern France across Belgium, Germany, Austria, and southern Russia, where it forms the soil known as the "black earth," or chernozem. It continues eastward across Asia into China, where some of the deepest and most interesting deposits occur that are to be found anywhere. This deposit covers an area of 400,000 square miles in China, mostly in the basin of the Hoang Ho, in places to a depth of 1,500 to 2,000 feet. It will be noticed that this belt follows the temperate zone. Loess deposits are found in Argentina and South Africa, but little is known of their extent.

The origin of loess has been much discussed and several theories have been advanced, but it is very likely that no one theory will account for the deposit in all cases. Since a careful study of the work of the wind has been made it is generally conceded that this agency is responsible for much the larger part of the deposit. There is little doubt but that some loess may have been deposited as a sediment from water and in some instances both wind and water have played a part.

As evidence of its eöliäl origin, it is found at all altitudes up to 5,000 feet above sea level in Europe and probably as much as 3,500 feet in the United States. To have this deposited by water would have required these regions to have been submerged to that extent and there is no evidence of such submergence. The depth of the deposit is quite uniform over hills and valleys as if it came like a gentle snow. In the United States, where the subject has received much attention, it is believed that the material has been

taken from the flood plains of streams that carried the waters from the melting glaciers, depositing the rock flour over the flooded plains of these streams (Fig. 60). During the cold part of the year the flood plains were bare and dry and this fine material was carried over the upland by the wind. The depth of the deposit varies with the width of the flood plain from which the material was derived and the distance from the stream. The coarser material was deposited on the upland adjoining the flood plain, while the finer was carried to much greater distances. Near the flood plains from which it was derived it was occasionally deposited upon the uplands



FIG. 60.—Alluviation by glacial stream below Hidden Glacier, Alaska. This occurred to a large extent during the Glacial Period. The upland loess was derived from these alluvial deposits. (Chamberlain and Salisbury, Courtesy Henry Holt & Co.)

in the form of dunes, either as hillocks or ridges. These frequently show the typical dune topography. In Illinois and other states we find that along the larger streams the loess deposit is deeper on the upland adjoining the wide bottom lands. Where no bottom land exists, the deposit on the adjacent upland is very thin. This indicates a very close relation existing between the loess and the bottom land. The deposit is deeper on the east side of the flood plains than on the west, indicating prevailing westerly winds at the time of deposition. Very much of the loess of North America was deposited at the close of the Iowan glaciation. The melting of this glacier seems to have been accompanied, as Leverett says, by heavy periodic

rainfall which caused floods that completely covered the flood plains. These periods of alluviation were followed by those in which the rivers contracted to their ordinary channels and left the sediment



FIG. 61.—Calcium carbonate concretions (*Loess Kindchen*), from the loess of Illinois.



FIG. 62.—A road through a deposit of deep loess along the lower Illinois River. The deposit is 30 to 50 feet deep. The vertical walls are characteristic.

to dry. It was then picked up by the wind and carried over the upland. This Iowan loess was very extensive, reaching as far east as southwestern Ohio, north into Wisconsin, and as far south as Louisiana on both sides of the Mississippi River.

Loess is quite uniform in texture, consisting primarily of particles of silt mixed with fine sand and a small amount of clay. Since much limestone was ground up by the glaciers, the loess contains a large proportion of carbonates, as much as 28 per cent in some cases. The percolating carbonated water has dissolved the carbonate from the upper part and carried it downward, depositing it in the form of concretions of various sizes and shapes as shown in figure 61. Some of these are tubular. It is probable that these were formed in the openings left after roots had decayed. Concretions of iron are formed occasionally.

The deeper loess deposits show characteristic vertical cleavage and cuts through this maintain vertical walls for long periods of time (Fig. 62). Terrestrial shells, such as snails, are frequently found in the deeper deposits, with an occasional fresh water shell.

The following table gives the analysis of loess from different sources for comparison with a dust fall in Indiana:

Physical Analysis of Loess and Dust ³ (Grades of Bureau of Soils)

Constituents	Upland loess, Virginia City, Illinois	River loess, Virginia City, Illinois	Loess, Nebraska	Dust from snow, Rock- ville, Indiana
	<i>per cent</i>	<i>per cent</i>	<i>per cent</i>	<i>per cent</i>
Moisture.....	5.40	3.17
Organic matter.....	4.96	11.98
Gravel.....	0.00	0.00	0.00	0.00
Coarse sand.....	0.00	0.00	0.00	0.00
Medium sand.....	0.00	0.01	0.00	0.00
Fine sand.....	0.01	0.10	0.00	0.00
Very fine sand.....	7.68	24.84	23.14	0.00
Silt.....	61.85	60.98	54.81	69.37
Fine silt.....	9.60	2.80	2.46	5.80
Clay.....	15.15	6.15	9.45	9.68
Total.....	94.29	94.88	99.22	100.00

The chemical analysis of five samples from different places is given in the next table. Note the amount of lime and magnesia. The deposit is usually characterized by a large amount of carbonate.

*Chemical Analyses of Loess from Various Sources*⁴

Constituents	Galena, Illinois	Kansas City, Missouri	Vicksburg, Mississippi	Valley of the Rhine	Neubad, Switzerland
	<i>per cent</i>	<i>per cent</i>	<i>per cent</i>	<i>per cent</i>	<i>per cent</i>
Silica (SiO ₂).....	64.61	74.46	60.69	58.97	71.09
Alumina (Al ₂ O ₃).....	10.64	12.26	7.95	9.97	} 16.78
Iron sesquioxide (Fe ₂ O ₃)..	2.61	3.25	2.61	4.25	
Iron protoxide (FeO).....	0.51	0.12	0.67	
Titanium oxide (TiO ₂)....	0.40	0.14	0.52	
Phosphoric anhydride (P ₂ O ₅).....	0.06	0.09	0.13	0.11
Manganese oxide (MnO) .	0.05	0.02	0.12
Lime (CaO).....	5.41	1.69	8.96	11.31	1.81
Magnesia (MgO).....	3.69	1.12	4.56	2.04	None
Soda (Na ₂ O).....	1.35	1.43	1.17	0.84	1.23
Potash (K ₂ O).....	2.06	1.83	1.08	1.11	1.30
Water (H ₂ O).....	2.05*	2.70*	1.14*	1.37†	1.96
Carbon dioxide (CO ₂)....	6.31	0.49	9.63	11.08	0.80
Sulfurous anhydride (SO ₂)	0.11	0.06	0.12
Carbon (C).....	0.13	0.12	0.19	2.87‡
Total.....	99.99	99.78	99.54	100.94	97.95

* Contains H of organic matter.

† Organic matter dried at 100° C.

‡ Ignition.

3. **Adobe.**—Adobe is a calcareous clay of a gray, gray-brown or dull yellowish color, very fine grained and porous, friable and yet standing in vertical escarpments for many years. The adobe soils are found in the arid and semi-arid regions and represent both wind and water deposits. Much of the adobe was undoubtedly formed in shallow lakes by the deposition of very fine material which contained a large amount of carbonate, resembling loess in this respect. Professor Russell⁵ speaks of this deposit as assorted and spread out over the valley bottom by the action of ephemeral streams where it becomes mixed with dust blown by the winds from the neighboring mountains and rendered more or less coherent by the cementing action of carbonate of lime. It occurs from Mexico northward to Oregon and Idaho and from California to Colorado. In altitude it varies from sea level in Arizona to 8,000 feet and in thickness from a few feet to 3,000 feet or more.

4. **Volcanic Dust.**—During the explosive eruptions of volcanoes large quantities of dust and ashes are thrown into the air which may be carried long distances by the wind. Volcanoes existed formerly where no active ones are found at present. North-western United States was a region of great volcanic activity in

comparatively recent geologic time. As a result of this action, large deposits of volcanic dust are found in Washington, Oregon, Idaho, Montana, Wyoming, and Nebraska. In the latter state the deposit varies from 4 to 30 feet in thickness, while in some of the northwestern states the deposit is much deeper. To give some idea of the amount of dust that is transported by the wind during a volcanic eruption, and the distance to which it may be carried, it is said that the dust from a volcano in Nicaragua was distributed by the wind over 1,500,000 square miles and that ashes from Krakatoa fell to a depth of several inches at a distance of a thousand miles from the volcano.

QUESTIONS

1. Give some examples of dust falls.
2. Give classes of wind-laid material.
3. Where are sand dunes found and what is the source of the sand?
4. What is the shape of sand dunes? How may they vary from this?
5. How is sand movement stopped on the shores?
6. How may fixed dunes be changed to wandering ones?
7. What is a "blowout"?
8. What special advantage does beach grass have for preventing drifting of sand?
9. Where are loess deposits found?
10. Give reasons for believing that loess is a wind deposit.
11. Do dust particles carry a film of air?
12. If so, what is the effect of this on the specific gravity of the particle?
13. What are some of the characteristics of loess?
14. How does it compare with dust?
15. Give characteristics of adobe.
16. Where is it found?
17. How extensive are deposits of volcanic dust?

REFERENCES

- ¹ Udden, J. A., *Popular Science Monthly*, September, 1886.
² Coffey, G. N., *Journal of Geology*, vol. xvii, No. 8, 1909.
³ Merrill, G. P., *Rocks, Rock-Weathering and Soils*, p. 319.
⁴ *Op. Cit.*, p. 318.
⁵ *Subaërial Deposits of North America*, *Geol. Mag.*, August, 1889.

General Reference.—Free, E. E., *Bulletin 68, Bureau of Soils, U. S. D. A.*, *The Movement of Soil Material by the Wind*, with Bibliography.

CHAPTER VI

SOIL AND SUBSOIL

THE soil may be conveniently divided into two strata: (1) the top soil, consisting of (a) surface 0 to $6\frac{2}{3}$ inches and (b) subsurface $6\frac{2}{3}$ to 20 inches, and (2) subsoil, which extends to an indefinite depth, but is sampled from 20 to 40 inches. The difference between the two divisions, the top soil and subsoil, is mainly due to the action of organisms, both plants and animals, although physical and chemical agencies have played no inconsiderable part in producing these differences.

1. **The Top Soil.**—(a) *Surface.*—The surface soil is confined to the part usually turned by the plow and is the stratum with which the farmer is most familiar. Organic matter and fertilizers are incorporated in this stratum and for this reason the roots of our common crops are largely confined here. The most obvious distinction in most soils between this and any other layers is the darker color produced by the larger content of organic matter or humus. This brings about decided color changes, such as darkening when moistened. Hydrated ferric oxide, if very abundant, may obscure the dark color of organic matter.

The surface soil frequently differs from the other strata, and more particularly the subsoil, in being made up of slightly coarser material. This difference is not found in arid regions. It is due to the washing downward of the fine particles by percolating water, as well as by their removal through surface run-off during heavy showers. This stratum contains the largest amount of fertility but generally the least of lime. Organisms of all kinds, usually found in soils, are more abundant in this layer. Here are found the most favorable conditions for bacterial growth and activity. The germs of fungous diseases, if present in the soil, are more abundant in this stratum. It is the only part of the soil that we can change materially and hence its importance.

(b) *Subsurface.*—The subsurface stratum lies between the surface and the subsoil, but usually resembles the surface more closely than it does the subsoil. The stratum is a natural one, extending from the plowed soil to the line where the change in color, physical composition and structure indicates the beginning of the subsoil.

The thickness of this stratum varies from 0 to 30 inches and even more, as in the case of peat and other swamp soils. That of normal upland loessial soils is from eight to ten inches.

The amount of organic matter decreases with depth and varies with that of the surface soil. Under normal conditions it is never as abundant as in the surface because the root development is never so great and the chances for the introduction of other vegetable material are not so good. Exceptions sometimes occur in alluvial land. The same downward movement of fine material has taken place as in the surface soil, thus giving a slightly coarser texture than in the subsoil. The subsurface may be made of distinct layers that differ in color or texture or both. The color in prairie soil is usually due to organic matter, while in timber soils it is principally due to iron in some form.

2. **Subsoil.**—The subsoil extends to an indefinite depth, but is sampled to 40 inches in humid climates. This stratum is of great importance because drainage, capillary movement, root penetration and resistance to drouth depend largely upon its character, and this in turn depends largely upon its origin. If residual, its character will vary with the parent rock from which it was derived. It will be uniform if the parent rock was massive, and variable if the parent rock was formed of strata of widely differing mineral and physical composition. In cumulose, lacustrine, glacial and alluvial deposits, the subsoil is likely to vary to almost any extent. There may be substrata of gravel, sand, silt, clay and even peat with all their variations. In loessial deposits two distinct layers usually occur in the subsoil, the upper from 6 to 15 inches thick consisting of a clayey silt or a silty clay, formed by the fine material carried downward from the upper strata by water and deposited in the upper subsoil, and the lower composed largely of silt and very fine sand, the very pervious ordinary loess. Subsoils are usually less pervious and more retentive of moisture than other strata.

Tight Clay.—All soils in humid climates permit more or less water to percolate through them. When a rain falls water passes into the soil through cracks, burrows, along roots and through the pore spaces, carrying with it a small amount of very fine clay and some iron oxide to the depth of percolation. In time the deposition of this fine material between the coarser particles may produce a very heavy, dense stratum, reducing the pore space to such an extent as to make it almost impervious to air and water. This is especially liable to take place in acid soils where no lime is present to precipi-

tate or flocculate the suspended clay. These tight clay soils are found in Southern Illinois, Missouri, Arkansas and many other places.

The tight clay layer becomes very hard when dry, but when saturated with water it is very soft and posts may be driven into it easily.

The tight stratum prevents underdrainage and the topography is almost invariably too flat for surface drainage. Damage to crops by water is very liable to occur. To remove the excess, plowing is done in small lands, the dead furrows are left open and by this means water may be removed, especially since these furrows are usually connected with a ditch at the end of the field. This tight stratum very seriously interferes with the capillary movement. The tight layer limits the storage of water to that part of the soil above it. Even if water is abundant below, it is cut off because the roots cannot penetrate this stratum and capillary movement through it is so extremely slow as to furnish but a scanty supply, with the result that crops are seriously affected by drouth. The effect of tight clay is very difficult to overcome. For the permanent improvement of soils of this kind, large applications of ground limestone, four to six tons per acre, with the growing of deep rooting crops, such as red, mammoth or sweet clover, are recommended. The puncturing of the tight clay by these roots will without doubt produce better conditions of drainage and aëration. Dynamite is sometimes used to break up the tight clay, but this method is too expensive for general farm use and besides the subsoil runs together again when saturated. The loess beneath this tight clay, which is from eight to twelve inches thick, is ideal in physical composition.

Hard Pan.—Hard pan proper is formed by the deposition of substances from solution around soil particles cementing them together into a more or less stony mass. The deposition of this cementing substance is due, possibly, to the stoppage of percolation by an impervious stratum, evaporation brought about by some cause, or loss of carbon dioxide, causing precipitation, as in the case of lime carbonate. The cementing material is usually derived from the decomposition of rocks and may consist of such substances as iron, magnesia, lime or sodium carbonate and sodium chloride.

Since the cause of hard pan is the stoppage of water in its movement downward the renewal of percolation will be sufficient frequently to destroy the hard stratum. If not too deep it may be broken with plow or subsoil plow, but if beyond the reach of these

implements dynamite must be resorted to. In planting trees on hardpan land dynamite may be used and thus allow the roots their usual penetration. If the hardpan is caused by sodium carbonate, it may be necessary to apply gypsum to destroy this carbonate and thus break up the hardpan.

Humid and Arid Subsoils.—The subsoils of arid regions do not differ materially from the surface and subsurface because the fine particles are not moved downward to any extent by percolating water. In addition to this, soluble substances are present, which flocculate the colloidal clay and prevent its movement downward. The arid subsoils do not possess the “raw” or unproductive nature that characterizes the humid ones. In arid regions very deep plowing may be done immediately preceding the planting of the crop without detriment; in fact, it is of great benefit, because it allows deeper root penetration and greater moisture retention. In the process of leveling, preparatory to irrigating, the soil is sometimes removed to a depth of several feet without injurious effect on the crop that follows. In humid regions the farmer must be careful not to turn up much of the “raw” unweathered material, just preceding time of planting the crop, but if deep plowing is done sufficient time should be given for the soil to “weather” before the crop is put in. This is probably partly due to biological conditions.

The color differences do not obtain in the arid regions because the organic matter is derived almost entirely from roots, and these penetrate very deeply; so there is no great accumulation of organic matter in the surface stratum. Oxidation of iron has not generally gone very far because of lack of moisture, hence arid soils are not usually highly colored.

Plow Sole.—Where plowing takes place at a somewhat uniform depth for a long time, the tramping of horses and the sliding action of the plow in the bottom of the furrow have a tendency to form a compact layer or plow sole. The washing of the fine material from the loose, plowed soil down on the furrow bottom tends to increase the tightness of the plow sole. In order to break up this stratum and prevent the formation of another, plowing should be done at variable depths, and when the moisture condition is such that puddling will not take place.

QUESTIONS

1. What are the most obvious differences between the surface stratum and others?
2. What agencies have been instrumental in producing these?
3. What are the upper and lower limits of the subsurface stratum?
4. Under what conditions might the subsurface be absent?
5. What differences between it and the surface?
6. Why is the subsoil of much importance?
7. Upon what do the differences in subsoils largely depend?
8. What is the origin of the tight clay stratum?
9. Where are they found?
10. Does limestone aid or prevent their formation?
11. What are some objections to tight clay?
12. What are the methods of improvement?
13. How is hardpan formed?
14. How may hardpan be destroyed?
15. Give differences in subsoils of humid and arid regions.
16. What is meant by "raw" soil material?
17. What effect does weathering have on subsoil?
18. How do humid and arid soils differ in color? Why?
19. How is a plow sole formed?
20. What are the remedies for it?

CHAPTER VII

CLASSIFICATION OF SOILS

Need of Classification.—The formation of soils by means of the various agencies described has given rise to great complexity. As in any other natural group of objects, the study of the relationship existing between the different members of the group is necessary for a complete understanding of them. This brings about comparison and classification. A very simple assumption would be that all soils derived from the same kind of rocks are the same. They do usually have some points of similarity, but so many modifying factors have been at work that important differences are produced even in these. It must be remembered that soils are very complex bodies, due to the infinite variety of rocks from which they are derived and the large number of agencies taking part in their formation.

By far the larger portion of soil material is moved from the place of its origin for varied distances, perhaps hundreds of miles. In its travels it may be deposited over and over again, and as a general rule the loose surface of the earth is a mass of drifting material, here to-day and a hundred or even a thousand miles from here in the next geological age.

BASIS OF CLASSIFICATION

1. **Geological.**—Soil is a geological formation derived from rocks by geological forces. It is very natural, then, that the geological formation should be used as the basis of classification. A number of States have made general soil maps, basing the areas upon the geology. In many cases this may serve a good purpose, as where the soils are closely related to the underlying geological formation. In other places the same formation may give rise to a great variety of soils, and in this case a classification on a geological basis would mean nothing. In extensive glaciated regions the soil usually bears little or no relation to the geological formations beneath the drift. General soil divisions may be based upon the geological agencies that have produced them, and in this way form an important factor in classification. This gives rise to residual, glacial, loessial, alluvial, and other formations.

2. **Lithological.**—In many cases soils have been classified according to the rocks from which they have been derived or upon a lithological basis. Rocks of the same name are so different in composition and are exposed to so many and such varying conditions and agencies of change that they may give rise to very different soils. A soil derived from a granite may be very fertile under one set of conditions or almost absolutely sterile under another.

3. **Temperature.**—Besides breaking down rocks into soil material and aiding solution slightly, heat does not play such an important part directly in the formation of soil, but indirectly through its effect and influence upon other agencies, temperature is of the greatest importance. Moderately high temperatures influence the growth of plants and bacterial action as manifested in oxidation and humification of organic matter. This brings about most important physical, chemical, and biological differences. On the basis of temperature soils may be divided into (a) tropic, (b) subtropic, (c) temperate, (d) subarctic, and (e) arctic. These are only very general and have but little significance in a system of classification.

4. **Moisture.**—Moisture is not only a very important factor in breaking down rocks into soil material, but it brings about very fundamental changes in the soils themselves, both chemically and physically. The presence of moisture is necessary for all chemical changes, hence decomposition of minerals can take place only when water is present. It is usually accompanied by the formation of soluble compounds that are leached out and carried away, and frequently to such an extent as to leave the soil deficient in plant food.

Soils are sometimes divided into *arid*, where the annual precipitation is less than 10 inches; *semi-arid*, 10 to 20 inches; *sub-humid*, 20 to 30 inches; *humid*, more than 30 inches, and *super-humid*, including swamps. There can be no distinct line of difference between the soils of such groups. In some parts of India, with a rainfall of 28 inches, the conditions are extremely arid because the rainfall comes in a very few months and as torrential showers, resulting in much loss by run-off. The evaporation is very great during the rest of the year. In parts of Texas, with a rainfall of 30 inches, it is much more arid than in North Dakota with the same rainfall, because of the character of the rainfall and the greater evaporation in the former.

Great differences exist between soils of arid and humid regions, primarily due to the amount of rainfall. The moisture as well as the temperature influences the amount and character of organic

matter in soils. The presence of water in large amounts arrests decomposition, as in swamps, by excluding oxygen, while its presence in moderate quantities stimulates nitrification in drained land. In its movement downward through a soil, water not only carries soluble compounds with it, but moves the fine particles downward, thus producing differences in physical composition in the different strata.

(a) **Arid Soils.**—The agencies of disintegration predominate over those of decomposition in arid regions. As a result the soils are characterized by large amounts of original minerals that have been changed very little.

*Mineral Content of Soils*¹

Region	Number of samples	Minerals other than quartz in the	
		Sand	Silt
		<i>per cent</i>	<i>per cent</i>
Arid.....	30	37	39
Prairie (subhumid and humid).....	40	20	29
Timber (humid).....	160	8	12

The great agency in chemical changes of rocks is water, and its deficiency in arid regions has protected the minerals from those profound changes that take place in humid regions. The minerals have been broken down into rather fine material, but not into clay, which results largely from decomposition. Silt and various grades of sand predominate. Their mineral content is indicated in the above table.

The low rainfall renders any large amount of leaching impossible, so that the soluble salts formed during the limited decomposition remain in the soil. They may be moved downward to some extent by the water, but when evaporation takes place they are brought to the surface again. If excessive evaporation occurs these salts may be brought to the surface in sufficient quantities to be quite injurious as "alkali."

*Soluble Salts in Soils*²

	Per cent
Arid.....	0.333
Prairie (subhumid and humid).....	0.048
Timber (humid).....	0.013

Although somewhat easily soluble, lime is a very abundant constituent of soils of arid regions. The amount varies from 0.69 to 5.66 per cent. The table below gives the average for arid and humid soils.

Lime and Magnesia in Soils of Different Regions *

Region	Number of samples	Per cent	
		Lime (CaO)	Magnesia (MgO)
Arid.....	318	2.65	1.20
Prairie (subhumid and humid).....	215	1.09	.51
Timber (humid).....	743	.41	.37

These arid soils are generally gray or light in color, with no very decided change in texture in the subsoil. The rainfall is not sufficient to carry the fine material downward in any large amount.

The organic-matter content of arid soils is generally low, although it contains a larger percentage of nitrogen than the organic matter of humid regions.

(b) **Humid Soils.**—In this group of soils the agencies of decomposition have predominated over those of disintegration. The feldspar and many other minerals have largely undergone chemical change, producing the finer soil constituents. Hence the soils contain large amounts of clay. The subsoil differs quite noticeably in texture from the surface. Leaching has done very effective work in removing soluble salts, as shown by the second table on page 74. Limestone has been leached out, and most of the soils are acid and in great need of this most important constituent. The colors are more highly developed, due to the greater oxidation of iron and the larger amount of organic matter.

5. **Vegetation.**—Not only do bacteria, fungi, and algae play a very important part in soil formation and soil changes, but the higher plants, especially grasses and trees, exert a most important influence upon soil in several ways. They are responsible to a very large extent for the amount of organic matter in soils. The character of the vegetation has given rise in humid and subhumid regions to two great groups of upland soils, (a) prairie, and (b) timber (Fig. 63).

(a) **Prairie Soils.**—Prairie soils are usually characterized by a dark color, due to a large content of organic matter. The prairies were covered with a rank growth of grasses which produced a dense

network of roots whose partial decay has provided the soil with an abundance of organic matter. This extends to a depth of 12 to 24 inches in amounts sufficient to impart the predominating dark color. The prairie soils contain a larger amount of lime than the timber soils, and this may be one important factor in their origin. They usually give an alkaline or neutral reaction. An exception to this is found in Southern Illinois, some parts of Missouri, and Arkansas. These prairies are acid and have a tight clay or so-called "hardpan" subsoil.

Prairie soils have had sufficient rainfall to leach out the larger

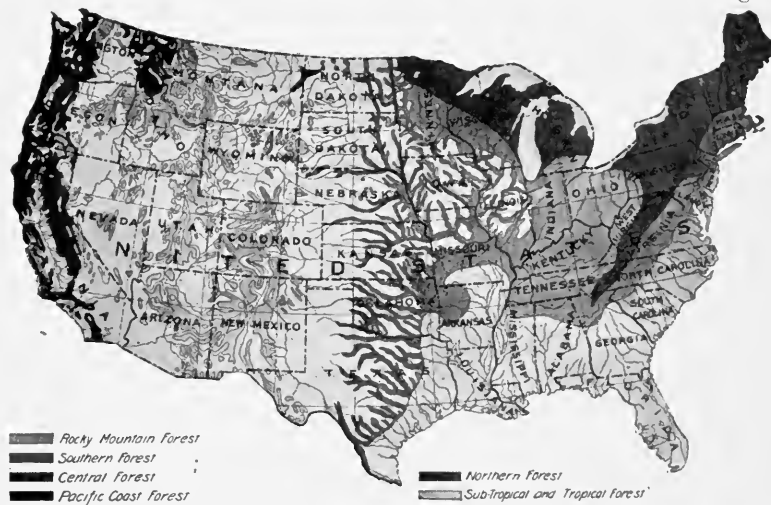

FIG. 63.—Map of United States, showing timber and prairie areas. Unshaded area, Prairie. Dark shade in Northeast and North, Central forests. Lighter shaded area in Southeast, Southern forests. Very lightly shaded area, Rocky Mountain forests. Deep shade, Pacific Coast forests. (Graves, U. S. D. A. Forest Service.)

part of the soluble salts, so that alkali is found only in small areas, and then consists principally of the more insoluble magnesium carbonate. The second table on page 74 shows 0.048 per cent of soluble salts in prairie soils, as compared with 0.013 for timber soils.

The prairie soils extend from Southern Texas northward into Canada, widening to the east into west central Indiana. A belt which is not shown in figure 63 extends across Mississippi and Alabama and over into Texas.

(b) **Timber Soils.**—The timber soils are characterized by a lighter color, due to a small amount of organic matter. This has

been brought about by the growth of forests, which place large quantities of organic matter, as leaves and twigs, on the surface of the soil, yet very little becomes incorporated in it. This material either completely decays or is burned by forest fires. The resulting soils are light colored.

The relatively heavy rainfall on timber soils has leached out the soluble material, including limestone, so that they are neutral or acid. It is likely true that the leaves have aided in this process.

6. **Color.**—One of the most important factors in distinguishing soils is that of color. This is primarily due to two things, organic matter and compounds of iron. Color is a fair indication of the value of a soil. If a large amount of organic matter is present the soil will be black or brown, while a smaller amount may be obscured by the more highly colored iron compounds. Dark brown or black soils are usually fertile. The color imparted by iron compounds varies with the degree of oxidation.

7. **Texture.**—The size of the soil particles and the proportion of each grade are the most important factors in grouping soils into classes and types.

QUESTIONS

1. Why are soils so complex?
2. Why should the geological formation be used as the basis of classification?
3. What is the value of a soil map based upon the geological formation?
4. Are all soils, derived from the same class of rocks, the same? Why?
5. What part does heat play in forming soils?
6. What is the significance of moisture in soil formation?
7. What are the divisions of soils based on moisture?
8. Why may Texas with a 30-inch rainfall be more arid than North Dakota with 20 inches?
9. What effect does heavy rainfall have on organic matter?
10. What agency predominates in the formation of soils of arid regions?
11. Why do humid soils have a larger percentage of quartz than arid soils?
12. Why are arid soils gray or light in color?
13. What agency is most active in the formation of humid soils?
14. Why do arid soils have large amounts of carbonates?
15. Why are humid soils more highly colored than arid ones?
16. Explain the source of organic matter of soils.
17. Give differences between timber and prairie soils.
18. Locate the large prairie region of the United States.
19. Why do the heavy forests add so little organic matter to the soils?
20. What is the significance of color in soil classification?
21. What is meant by texture of a soil?

REFERENCES

- ¹Coffey, G. N., A Study of the Soils of the United States, Bulletin 85, Bureau of Soils, U. S. D. A., p. 15.
- ²Op. Cit. p. 15.
- ³Op. Cit. p. 14.

CHAPTER VIII

CLASSIFICATION BY THE BUREAU OF SOILS

THE results of all the preceding factors involved in soil changes find expression and application in the system of classification developed by the Bureau of Soils. The United States has been divided into 13 great geographic divisions; the six in the western part are known as soil regions, while the seven in the eastern part are called soil provinces.

A soil province is an area which has the same general physiographic expression and in which the soils were produced by the same forces or groups of forces.

A soil region may include several soil provinces which later study may establish. The soils of a province are grouped together into series on the basis of the same range of color, the same character of subsoil, as regards color and structure, the same type of relief and drainage, and a common or similar origin. A soil series is divided on the basis of texture into classes.

Soil Provinces and Regions.—Area Surveyed up to 1915

Provinces	Estimated area	Detailed survey	Reconnais- sance survey	Total area
	<i>acres</i>	<i>acres</i>	<i>acres</i>	<i>per cent</i>
Piedmont Plateau	47,214,000	16,638,950	2,388,416	40.3
Appalachian Mountain and Plateau	84,837,000	19,643,709	23,509,504	50.8
Limestone Valley and Up- land	67,870,000	11,660,094	2,040,896	20.2
Glacial and Loessial	385,083,000	43,475,366	37,724,608	21.1
Glacial Lake and River Terrace	442,788,000	12,956,602	7,397,728	45.0
Atlantic and Gulf Coastal Plains	218,362,000	52,718,882	22,748,096	34.6
River Flood Plains	75,247,000	26,913,813	7,561,216	45.9
Regions				
Great Plains	331,968,000	13,170,106	127,711,616	42.4
Rocky Mountains	265,575,000	2,674,560	1.0
Northwest Intermountain	75,984,000	2,322,884	3.06
Great Basin	118,034,000	1,399,072	1.18
Arid Southwest	81,148,000	1,674,138	46,080	2.10
Pacific Coast	109,180,000	16,953,491	4,015,360	19.2
Total	1,903,290,000	222,201,667	234,043,520	23.9

A soil class includes all soils having the same texture, such as clays, peats, mucks, clay loams, etc., and are divided into soil types.

A soil type is a soil which throughout the area of its occurrence has the same texture, color, structure, character of subsoil, general topography, processes and sources of derivation.

The soil surveys are of two kinds, reconnaissance and detailed. The former furnishes only general information, while the latter gives the soil types in considerable detail.

I. THE PIEDMONT PLATEAU PROVINCE

The Piedmont Plateau comprises the rolling to hilly region lying between the eastern foot of the Appalachian Mountains and the Atlantic Coastal Plain. The northern end of this province lies in northeastern New Jersey, along the glacial boundary, in the vicinity of the Hudson River. It extends southwestward, and in Virginia is a belt ranging from 20 to 50 miles in width. Widening here it continues in a southwesterly direction to central Alabama with an average width of approximately 115 miles. The province has a length of 900 miles, and embraces an area of approximately 73,770 square miles. The following are the most important series of this province:

Alamance Series.—The surface soils of this series are gray to almost white and of silty texture. The subsoils are composed of yellow, rather compact silty clay. Scattered over the surface are fragments of the parent rocks which belong to the "Carolina slates." It forms a belt in central North Carolina, and extends a short distance into South Carolina. The topography varies from nearly flat to rolling, or in some places steeply rolling.

Cecil Series.—The Cecil series include the most important and widely distributed soils of the Piedmont Plateau. The heavier members are known as the "red-clay lands." These soils are residual, derived from gneisses and schists and characterized by their red-clay subsoils and gray to red soils, ranging in texture from sand to clay, the lighter colors prevailing in the sandy members. A characteristic of the subsoil is the content of sharp quartz sand and the frequent occurrence of the remains of veins of quartz. Mica flakes are also usually present in the subsoil. The topography is slightly rolling to hilly. The soils are adapted to general farm crops and in the South to cotton. Over seven and one-half million acres have been mapped.

Chester Series.—The Chester series occurs in the northern part of the Piedmont Plateau, having been mapped only in Pennsylvania, Maryland, and Virginia. The types in this series differ from those in the Cecil series in having yellow or only slightly reddish yellow subsoils and gray or brown surface soils, the latter being, on the whole, lighter and more friable than the Cecil. Locally they are known as “gray lands,” to distinguish them from the “red lands” of the Cecil series. The soils are adapted to general farm crops and fruit.

Durham Series.—The soils of the Durham series are characterized by the grayish color of the surface and the yellow color of the subsoils. They are derived from light-colored, rather coarse-grained granite and gneiss, consisting principally of quartz and feldspar, with some mica.

Iredell Series.—The soils of the Iredell series are light brown to almost black in color and frequently carry small iron concretions. The subsoils consist of extremely plastic, sticky or waxy clay of a yellowish brown to greenish yellow color. Disintegrated rock is often encountered within the three-foot section. The soils are best suited to grain and grass.

Lansdale Series.—The Lansdale series is characterized by the gray, drab, or brownish color of the soils and by the slaty gray to pale yellowish color of the subsoil. They are derived from metamorphosed Triassic sandstone and shale. Moderate yields of hay, corn, oats, wheat, and Irish potatoes are secured.

Louisa Series.—The soils of this series are predominantly gray to light gray and the subsoils red. The material is derived from talcose and micaceous schists and imperfect crystalline slates. They are suited to corn, grain, forage crops, and cotton.

Manor Series.—The Manor soils are characterized by their yellowish-brown to brown surface color and the yellow to yellowish-red or dull red color of the subsoils. This series is also high in mica in both soils and the subsoil. They are derived from mica and chlorite schists. Good yields of corn, wheat, oats, Irish potatoes, and hay are obtained.

Penn Series.—The Penn series includes Indian-red soils derived through the processes of weathering from red sandstones and shales of Triassic age. Detached areas of these rock formations occur in shallow basins in the Piedmont Plateau from the vicinity of New York to South Carolina. Corn, wheat, oats, potatoes, grass, apples,

and peaches are produced in the northern and tobacco and cotton in the southern states.

York Series.—The types included in the York series are predominantly gray to light gray at the surface and have yellow subsoils. They are derived from talcose and micaceous schists and imperfectly crystalline slates. Crop yields are usually low and the soils are exceedingly difficult to improve.

II. THE APPALACHIAN MOUNTAIN AND PLATEAU PROVINCE

This province embraces three subdivisions of the Appalachian system, which extend from New Jersey and northern Pennsylvania to central Alabama. They are as follows: (1) The Blue Ridge region on the east and southeast side; (2) The Cumberland-Allegheny plateau on the west; and (3) the Appalachian ridge and valley belt between. The province includes two subordinate divisions lying outside of this general area: (1) the Ouachita and Boston mountain ridge of the Ozark uplift west of the Mississippi River, and (2) the area of Coal Measure rocks in western Kentucky and southern Indiana. The Appalachian constitutes the greater part of the province and forms a broad belt approximately 900 miles long. It includes the mountains, ridges, and valleys of this area. This province is about 200 miles wide in Pennsylvania and attains a maximum breadth of about 270 miles in Virginia.

Berks Series.—The soils of the series are yellowish-brown to brown with yellowish subsoils. The soils are derived from the Hudson River shales, which are yellow, brown, grayish, and olive-colored. They occupy rounded ridges and hills with good drainage. They are suited to corn, oats, wheat, and Irish potatoes.

Conasauga Series.—The Conasauga series are light brown, and the subsoils are yellow and prevailingly of silty clay loam to silty clay in texture. These soils are developed typically in flat to gently rolling valley lands. They are derived from interbedded shale, limestone, and fine-grained sandstone. Good yields of cotton, corn, wheat, oats, and forage crops may be secured.

De Kalb Series.—The surface soils of this series are gray to brown, while the subsoils are commonly some shade of yellow. The soils are derived from the disintegration of sandstones and shales. The surface features consist of gently rolling table lands, hills, and mountains. The soils are generally not very productive, but the stony and sandy members are adapted to orchard fruits, while the

heavier ones produce hay and pasture grasses. Sixteen million acres of this series have been mapped.

Fayetteville Series.—This series consists of grayish brown to brown soils with yellowish brown to reddish brown subsoils. The soils are formed by the weathering of sandstones and shales and are found throughout a large part of western and northwestern Arkansas and eastern Oklahoma. They are moderately fertile.

Hanceville Series.—The Hanceville series has a light brown to reddish brown surface and a red subsoil. The topography ranges from rolling to steeply rolling. The soils are derived from sandstones and shales and are moderately productive.

Meigs Series.—This series is variable in character and particularly in color, which ranges from Indian red to gray or pale yellow. The soils are derived from red, fine-grained sandstones and shales and from grayish sandstone and shales. The topography is steeply rolling. The soils are suited to grass and the production of hay.

Porters Series.—This series includes the residual soils of the Appalachian mountains derived from igneous and metamorphic rocks. They occur at high elevations. The soils are particularly adapted to fruit culture.

Talladega Series.—The soils of this series are grayish brown to light brown. The subsoils are red and have a greasy feel. The soils are derived from metamorphic rocks, principally micaceous schists. The topography is strongly rolling to mountainous. They give moderate yields of corn, forage crops, and cotton.

Upshur Series.—In the Upshur series both soils and subsoils are Indian red. Some types have the grayish to grayish-red color in the surface soils. They are derived from Indian-red sandstones and shales, frequently of calcareous nature. They occupy rolling to mountainous regions. They are generally more productive than the De Kalb series.

Westmoreland Series.—This series is marked by the grayish brown to yellowish brown color and mellow structure of the surface soils and the yellowish brown to yellow color and friable structure of the subsoils. The soils are derived from shales and sandstones, with interbedded limestones and calcareous shales. The topography ranges from gently sloping to quite rolling or steep lands. These soils are very productive, being particularly adapted to corn, oats, wheat, grass, potatoes, apples, peaches, plums, cherries, berries, and vegetables.

III. LIMESTONE VALLEYS AND UPLANDS PROVINCE

This province includes two important topographic divisions—the limestone valleys and uplands. The limestone valleys are most extensively developed within the Appalachian Mountain System, and besides these the Central Basin of Tennessee and the bluegrass region of Kentucky.

The uplands division includes a large area extending from Alabama through Tennessee and Kentucky almost to the Ohio River. The Ozark region of southern Missouri, northern Arkansas, northeastern Oklahoma, and southeastern Kansas is included.

The principal soil series are as follows:

Brooks Series.—The soils are grayish brown to brown with yellowish brown to slightly reddish brown clay subsoils. The soils are derived from pure limestones, with an occasional admixture of material from associated sandstone and shales. These soils have good drainage. Wheat, corn, oats and apples do well.

Clarksville Series.—The soils are gray and the subsoils yellow and usually silty clay in texture and frequently underlain by a reddish substratum. The depth to red material varies with the topography, being deeper on the more level areas. The soils are derived from a cherty limestone and occur over both level and undulating uplands and rough and hilly country with steep slopes. They are adapted to tobacco, grass, small grains, corn, strawberries and cantaloupes. Over five million acres have been mapped.

Colbert Series.—The surface soil is grayish to light brown and the subsoil yellow and frequently plastic. The series is derived from pure limestone or a limestone mixed with sandstone. The topography is flat to undulating and drainage is generally poorly established. With proper drainage wheat, oats, corn, and forage crops can be grown with good results.

Conestoga Series.—These soils are yellowish brown to brown. The subsoils are yellow greenish, occasionally mottled with gray, and have a greasy feel. These soils are derived from schistose limestone and calcareous shale or shaly limestone. They are adapted to general farm crops.

Decatur Series.—The soils are characterized by a reddish brown to deep red color and subsoils by an intensely red or blood red color. They are derived mainly from pure limestone, with some traces of chert, and are adapted to corn, small grains and forage crops. They occur as nearly level to gently rolling valley lands.

Hagerstown Series.—The soils of this series are prevailingly

brown in color, with light brown to reddish brown subsoils, but never so distinctly red as the Decatur series. The topography is undulating to gently rolling. They are derived from limestone. The soils are very productive and well adapted to corn, small grain, clover, blue grass, timothy, and apples. Three million acres have been mapped.

IV. THE GLACIAL AND LOESSIAL PROVINCE

The glacial and loessial province includes that part of the United States lying east of the Great Plains in which the soils are derived from (1) ice-laid deposits left by the retreat of the ice at the close of the glacial period, (2) water-laid material intimately associated with the ice-laid material, deposited during the advance and retreat of the ice in the form of out-wash plains, and (3) silt deposits laid down by water or wind during, or subsequent to, the retreat of the ice. The ice-laid deposits are found north of an irregular line running from Cincinnati to La Crosse, Wisconsin, thence southward to Iowa City, Iowa, continuing in a westerly direction to the southeastern corner of South Dakota. South of that line they are mainly loessial, presumably wind-laid deposits. The two tongues, the one running down the Mississippi and the other southwestward across Kansas and Oklahoma, are entirely so.

Bangor Series.—This series is characterized by grayish to yellowish brown surface soils, with subsoils of lighter gray and yellowish brown. All of the types are stony and gravelly. The soils are derived from glacial till containing more or less material from the local sercitic schist rock. The topography is rolling to hilly. With the exception of the stony loam and shallow phase of the loam the types of this series are fair general farming soil.

Caribou Series.—The members of this series have yellowish brown soils which usually rest upon a light gray lower till. The soil material is derived from glacial till overlying calcareous shales or shaly limestone, the till itself being derived from the underlying calcareous formation, having been transported for only short distances. The soils are very productive, being especially adapted to Irish potatoes, grain and peas.

↓ **Carrington Series.**—These soils are derived through weathering of the glacial till with little or no modification from loessial deposits. The soils are generally prairie, black in color, ranging in some cases to dark brown. The subsoils are lighter colored gen-

erally, having a light brown or yellowish color. The topography is gently undulating to rolling. Corn and wheat are the principal crops grown. Nearly four million acres have been mapped.

Cazenovia Series.—These soils are brown in color with a brown to reddish subsoil resting on limestone at a depth of about 3 feet. Fragments of limestone and red sandstone are found throughout the soil and occasionally large boulders are scattered over the surface. These soils are derived from glacial till containing considerable limestone material. The principal crops are grass, alfalfa, corn, wheat, and potatoes.

√ **Coloma Series.**—The soils of this series are light brown to grayish in color with yellow or reddish subsoils. The topography is generally rolling to rough and hilly, representing terminal and ground moraines. The series is formed from relatively coarse glacial material modified to some extent by the action of the wind and water. They once supported extensive pine forests and are found in northern Michigan, Wisconsin, and Minnesota. Nearly two and one-half million acres have been mapped.

Cossaymna Series.—These soils are brown or snuff colored, with subsoils of the same color, but of a lighter shade. Both strata contain considerable quantities of shale and calcareous sandstone fragments with a small percentage of foreign boulders. They are derived from glacial till and occupy rolling to hilly uplands. The principal crops are corn, oats, hay, potatoes, apples and other tree fruits.

Dutchess Series.—The Dutchess soils are brown to light brown with bluish, light brown, yellowish or reddish brown subsoils. The soils are friable, the subsoils being somewhat heavier in texture than the soil. In some types rounded and angular gravel occur in both soil and subsoil. These are rarely of limestone. The topography is rolling to undulating and rough. The soils are adapted to oats, grass, potatoes, and tree fruits.

Flushing Series.—The soils are brown in color and overlie yellowish or reddish subsoils, sometimes micaceous and in some instances resting on crystalline rock. The material is of glacial origin.

Gloucester Series.—The soils of the Gloucester series are light brownish or often grayish at the immediate surface and overlie yellow subsoils. The soils are derived from a rather local glaciation of crystalline rocks of granites and gneiss. The drainage is fair to good. The topography ranges from gently undulating to rolling or hilly. Scattered rocks and boulders of large size occasionally

occur, rendering the use of farm machinery somewhat difficult. They give fair yields of corn, potatoes, oats, hay, and fruit.

Holyoke Series.—The soils are brown to dark yellow in color. The subsoils are yellow and somewhat heavier than the soils. They are of glacial origin and derived from metamorphic, diabase and crystalline rocks. The topography is rough and the soils are moderately productive.

↓ **Kewaunee Series.**—This series is characterized by grayish to reddish brown or pinkish soils overlying pinkish red silty clay and rather calcareous subsoils. They are derived from till and contain more or less angular pebbles. The topography varies from undulating to hilly, but the underdrainage is generally poor.

↓ **Knox Series.**—These soils are light brown and are derived from loessial or other wind blown deposits. The topography is gently undulating to rolling. Grain crops constitute the chief agricultural products. About three million acres have been mapped.

Lackawanna Series.—These soils are derived from glacial drift that forms a relatively thin mantle overlying the red shales and limestones. The topography is slightly rolling to hilly and mountainous.

Lexington Series.—Lexington soils are gray to yellowish gray in color and mellow in structure. The subsoil is yellow to brown, with a tinge of red in places, and is often somewhat heavier than the soil. Drainage is good and the topography is moderately rolling to hilly. The types are derived from loess with orange sand a few feet below the surface. These soils are adapted to corn, cotton, forage crops, vegetables, and strawberries.

Marion Series.—These soils are gray, white or ash colored. The subsoils are white at the top, the white layer varying in thickness from 2 to 12 inches and averaging about five inches. This layer is compact, impervious, whitish silt or very fine sand, often containing iron concretions and locally known as "hard-pan." Beneath this the true subsoil is a gray, light yellow to reddish yellow or mottled brownish yellow, hard, impervious clay containing occasional concretions of iron and lime. The topography is flat to undulating. Drainage is poor. They are derived from modified loess.

↓ **Marshall Series.**—The Marshall series includes the dark colored upland loessial soils which predominate in the great prairie region of the central west. The surface soils have a dark brown to black color. The topography is level to rolling and artificial drainage is usually necessary to secure best results. They are very

productive and constitute the great corn soils of the country. Nearly four million acres have been mapped.

Memphis Series.—The Memphis series is characterized by the light brown to yellowish brown color and silty texture of the surface soils and by the slightly lighter colored and more compact structure of the subsoils. They occur south of the latitude of St. Louis and are most extensive in the loessial belt following the east bank of the Mississippi river. Erosion has been active and has resulted in a prevailing rolling to broken topography. They are well suited to corn, oats, peanuts, forage crops, and cotton. The amount mapped is 2,000,000 acres.

√ **Miami Series.**—The soils are brown, light brown or grayish and are underlain by yellowish and brown heavier textured soils. Mottlings of brown and light gray are present in the subsoils. Surface drainage is usually good. The soils in the main are derived from the weathering of glacial till composed largely of ground-up limestone. Dairying is an important industry on the heavier types. Nearly four million acres have been mapped.

Mohawk Series.—The Mohawk soils consist of dark colored glacial material derived in part from dark colored calcareous shales and limestones, but modified by admixture of glacial till from other formations. The topography is rolling to hilly and they are considered good general farming soils.

Ontario Series.—These soils are brown to chocolate brown in color, the subsoils being lighter and in many cases grading into yellow. Both soil and subsoil usually contain scattered fragments of limestone and are derived from glacial till of the drumlin region of New York. The topography is undulating to hilly.

Plymouth Series.—These soils are derived from moderately coarse glacial material largely from granites. The series includes the morainal and till deposits found in southeastern New England and on Long Island. The surface soil is shallow and brown, underlain by a pale yellow subsoil.

Putnam Series.—This series includes dark gray to black soils overlying impervious drab or brown subsoils of fine texture and close structure. One of its principal characteristics is the presence of a whitish silty layer between the soil and the subsoil. The soils occupy level to gently undulating prairies and are derived from loessial deposits. Drainage is poor because of the dense compact structure of the subsoil. They are confined to Missouri.

Richland Series.—The Richland series is characterized by a

light brown to yellowish brown color and silty texture of the surface soils and the somewhat lighter color and more compact structure of the subsoils. These soils are derived from the loess and occur in association with the Memphis soils. The topography is smooth, flat to undulating. Cotton, corn, peanuts, oats, forage crops, clover, cabbage and Irish potatoes give very good results.

Shelby Series.—The soils of this series are yellowish gray or yellowish brown to brown in color. The subsoils are yellow or reddish yellow or light brown tenacious sandy clays. The subsoils are derived from the Kansas drift and occupy steep stream slopes. They were originally covered with white oak, some hickory, red oak and elm.

Trumbull Series.—The Trumbull series consists of gray surface soils, underlain by light gray or gray mottled with yellow subsoils, which at an average depth of about 18 inches becomes a mottled gray and yellow. The soils are without limestone to a depth of 3 feet. They are derived from shales and sandstones. Corn, oats, wheat and hay are the principal crops grown.

Union Series.—The soils of this series are characteristically brown to grayish brown in color, of silty texture and friable structure, with yellowish brown silty and moderately friable subsoils. It is probably partly of loessial origin. The topography is gently rolling to hilly.

Volusia Series.—The soils of this series are the result of feeble glaciation of the shales and sandstones of the Devonian and the Upper Carboniferous rocks of eastern Ohio, southern New York, and northern Pennsylvania. The underlying shales and sandstones have given rise to a large proportion of the soil material, which has been modified in varying degrees by other glacial material. The series is well adapted to the production of timothy and small grains. Wheat and corn give good yields at lower elevations. Over six million acres have been mapped.

Williams Series.—The soils of this series are of a dark gray to brown or dark brown color, generally underlain at 8 to 12 inches by lighter brown subsoils which grade quickly into light gray, ashen or putty colored subsoils of calcareous character and usually of fine and often of silty texture. They are derived from glacial material and contain gravel and boulders. The surface is treeless and varies from level prairies to rough hilly terminal, moraine belts. Nearly 14,500,000 acres have been mapped.

Wooster Series.—The Wooster series includes the yellowish

brown glacial shale and sandstone soils, having unmottled brownish gray subsoils. When dry the surface in plowed fields is a light gray, but underneath the surface or when moist the soils are always yellowish or light brown. The subsoils are of a brownish yellow with just a slight tinge of red. They are derived from shales and sandstones. Wheat, corn, oats, hay, and potatoes are the principal crops grown.

V. GLACIAL LAKE AND RIVER TERRACE PROVINCE

The Glacial Lake and River Terrace Province embraces two classes of deposits. The first class includes deposits in the basins of lakes formed by the advance and retreat of ice during the Glacial period. These were temporary lakes which took form during the period of the retreat of the ice or lakes that were formed then but have since been drained through the operation of natural drainage forces.

The second class of deposits consists of those left within the glaciated area by the streams that flowed from the ice during the Glacial period. These streams were more abundantly supplied with water from the melting ice than at present from the normal rainfall of the glacial region. They also carried large quantities of gravel, sand and finer material which were deposited in the valleys, forming new slopes whose grades were determined by the load and current of the streams. Since the reduction of the volumes of the streams new valleys have been formed through the old material.

The province consists of a large number of isolated areas, many of them a square mile or less in extent. The river terraces are developed as small, irregular areas or strips along the streams. The larger areas lie within the former basins of the lakes. The principal series are as follows:

Chenango Series.—This series consists of yellowish to light brown surface soils and brown to yellow subsoils. The surface soils vary in texture. The subsoils pass into stratified gravel or coarse sand at three feet or more in depth. The series includes terrace soils occurring along streams. The soils are of high agricultural value, and are well adapted to corn, alfalfa, potatoes, and truck crops.

Clyde Series.—This series is characterized by dark brown to black surface soils and gray, drab or mottled gray and yellowish subsoils derived through deposition or reworking of the soil

material in glacial lakes or ponds. The soils of this series grade into muck and peat. The topography is level and the soil is naturally poorly drained. They are highly productive and valuable for corn, grass, sugar beets, cabbage, and onions. About 1,500,000 acres have been mapped.

Dunkirk Series.—The soils are derived from the weathering of glacial lake deposits and include the lighter colored soils formed from such material. The surface soils range from brown to gray in color and the subsoils from brown to yellow or gray with or without mottling. The topography varies from smooth to rough. An area of almost two million acres has been mapped.

Fargo Series.—This series occurs principally in the old glacial Lake Agassiz, in the Red River Valley, and in other old glacial lake beds in the same region. They are very black in color, containing a very large per cent of organic matter, in some cases enough to make them slightly mucky. The subsoil contains a large amount of lime. The topography is level. The area mapped is nearly 3,000,000 acres.

Fox Series.—These are gray to brown and of level or slightly undulating topography. The material was laid down as outwash plains or terraces along streams within the glacial area.

Manchester Series.—The soils of the Manchester series are generally rather sandy in texture and the surface soils are red or brown in color. The subsoils are red or reddish and in the lower part grade into the glacial till. They are formed from old alluvial or lacustrine sediments disposed as terraces in the Connecticut Valley. They are adapted to fruit, early truck, grains, and tobacco.

Merrimac Series.—The surface soils of the Merrimac series are brown to light brown in color and usually underlain by yellowish sand and gravel. They constitute the glacial terraces found along nearly all streams in New England. The material consists principally of crystalline rocks which were ground up by the ice and reworked by water.

Orono Series.—The surface soils are light brown and gray and the subsoils are gray. The heavier types occur as estuarine and glacial lake plains or outwash plains. The lighter types are derived from esker and glacial-delta material. The adaptation to crops varies with the texture and drainage. The heavier soils are best suited to grass and grains, the intermediate, to general farming, and the light sandy ones to truck crops.

✓ **Plainfield Series.**—The surface soils of the Plainfield series

range in color from brown to grayish yellow, while the subsoils are usually yellow to pale yellow. The series is developed in the deep drift-covered areas of Wisconsin, Michigan, and Minnesota, and are derived from sandy and gravelly glacial débris washed out from the fronts of the glaciers. The type is also found in deep filled-in valleys. The greater part of the material of the series has been considerably assorted by glacial waters and consists mainly of sand and gravel.

Sioux Series.—This series occurs in the glaciated region of the central and northwestern states and comprises the dark brown to black terrace soils and with a bed of gravel within three feet of the surface. It occurs as narrow areas along streams instead of broad outwash plains.

↳ **Superior Series.**—The surface soils are gray, brown or reddish, with pinkish red to light chocolate red rather dense clay subsoils. The series comprises a group of glacial-lake soils developed mostly along the margin of Lake Superior. The topography is usually level to slightly undulating. The series is well adapted to the production of grasses, grains and the general farm crops.

Vergennes Series.—This series is marked by brown, yellowish or gray soils underlain at varying depths by drab to blue or light gray clay subsoils, often calcareous. It consists of deep-water sediments known as the Champlain clays deposited in post-glacial times over glacial drift during a period of submergence. Since the uplift these clays have been more or less modified by the stream action and colluvial wash from the surrounding highlands. The surface is level to gently rolling.

↳ **Waukesha Series.**—The Waukesha series is characterized by dark brown to black surface soils underlain by yellow subsoils in which fine gravel is usually present. They are derived from water-assorted glacial débris deposited in broad filled-in valleys or as outwash plains and terraces, and are sandy and gravelly in general character. They are more productive than Plainfield soils.

VI. ATLANTIC AND GULF COASTAL PLAINS PROVINCE

The Atlantic and Gulf Coastal Plains Province constitutes one of the most important physiographic divisions of the United States. This province comprises approximately 365,000 square miles of the predominantly flat to smoothly rolling region bordering the Atlantic Ocean and extending from the northern end of Long Island in New

York to the southern extremity of Florida and along the Gulf of Mexico to the mouth of the Rio Grande. There is a broad gap in the Gulf Plain represented by the Mississippi bottoms and the belt of loessial soils adjoining the bottoms on the east.

In its general aspect, the Atlantic and Gulf Coastal Plains Province consists of a broad plain which rises gradually either from sea level or low bluffs along the coast to the border of the high inland regions of different topographic forms. The inner boundary, representing the highest part of the main province, varies from 200 to 500 or 600 feet above sea level. This region, although formerly a plain changing to a gradual slope from the sea inland, has been eroded since its uplift above sea level to its present varying topographic features of low to moderate relief as compared with the much more uneven surface of the Appalachian and Piedmont regions. The most important series are as follows:

Acadia Series.—The surface soils are light gray or white, with mottled gray and yellow, or gray, yellow and red friable subsoils, carrying lime nodules and iron concretions. They are derived mainly from reworked loessial material. The surface is gently rolling, and the series is now timbered with pine, oak, gum, hickory and some cypress. It is adapted to the production of corn, cotton, peas, and oats.

Brennan Series.—This series consists of gray calcareous soils containing a small amount of humus and a large amount of lime. They have been derived from Pleistocene deposits in broad valleys. They are of higher agricultural value than the former.

Caddo Series.—The soils are gray to yellow in color. The subsoils are mottled gray and yellow, or gray, yellow and red, and of a rather stiff structure. In some places the subsoil has a pronounced grayish color, while in others it is a mottled yellow and gray. Low sandy mounds or hummocks are a feature of the series. Cotton and corn are the principal crops. These soils are most extensively developed in northwestern Louisiana and northeastern Texas and are derived from reworked loessial material.

Coxville Series.—The series comprises dark gray to nearly black soils derived from the quiet or deep-water deposits of the Columbia formation. The subsoils range from a moderately mellow friable clay in the upper portion to yellowish plastic compact clay mottled with drab and bright red in the lower portion. The topography is prevailingly flat. They are well adapted to cotton, corn, oats, and certain varieties of strawberries.

Crowley Series.—The soils range from ashy gray to light brown in color, with mottled brown, yellow and red, to almost uniformly yellow clay subsoils. Lime and iron concretions are present in the subsoil, which is quite impervious to water. This feature favors the production of rice. The topography is flat. They are typical prairie soils of Louisiana and Arkansas formed or reworked loessial material.

Durant Series.—The series consists of dark gray to dark brown surface soils, with yellow to dark brown subsoils. They are derived from soft sandstone and calcareous marl. The soils are productive, giving fair yields of general farm crops.

Duval Series.—The soils are marked by their bright red color and rather low lime content. They are derived from fluvial deposits of red sands and sandy clays. Three and one-half million acres have been mapped.

Edna Series.—The soils of this series are gray to dark gray. The subsoils consist of gray or mottled gray and yellow, heavy, impervious clay. The topography is level to gently undulating. They are derived from the weathering of noncalcareous marine deposits. The supply of organic matter is low. They are not very productive, but cotton, corn and general farm crops are grown to some extent. The area mapped comprises 1,500,000 acres.

Elkton Series.—The soils are light gray to white and the subsoils are mottled whitish gray and yellow. Gravel or coarse sand usually saturated with water is found at a depth of $2\frac{1}{2}$ to 3 feet. They are of rather low agricultural value.

Goliad Series.—These soils are prevailing dark gray to black with reddish brown to red sandy loam or sandy clay subsoils, in the lower portions of which a white, soft, calcareous substratum is encountered. The soil material consists of weathered marine deposits. They are fairly productive.

Greenville Series.—These soils are reddish brown to dark red and generally loamy. The subsoils consist of red friable sandy clay. The types occupy level to gently rolling areas in the Coastal plains uplands. They are well adapted to cotton, corn, forage crops and oats.

Houston Series.—The soils are black and high in lime, especially the subsoils, which in some of the types consist of white chalky limestone. The members of the series occur principally in the black calcareous prairie regions of Alabama, Mississippi and Texas. The soils have been derived from the weathering of cal-

careous clays, chalk beds and rotten limestone, of Cretaceous age. The soils of this series are very productive and are devoted chiefly to cotton and corn, but alfalfa will grow on some of the types. The area mapped comprises 6,300,000 acres.

Lake Charles Series.—The soils of this series are gray to black in color, with mottled yellow and red subsoils carrying lime and iron concretions. The surface is marked by low sandy mounds or hummocks. The subsoil is quite resistant to the movements of moistures, and drainage is poorly established. The soils are best suited to sugar cane and grass. The series occurs on both prairie and tree-covered areas and consists mainly of reworked loessial material. The sand mounds are inclined to be drouthy. Some rice is grown.

Leonardtwn Series.—The soils of this series are gray to pale yellow in color. The subsoils are mottled gray, yellow and red and ordinarily carry clay lenses and pockets of sand. They are gently rolling to rolling. They are best suited to general farm crops.

Lufkin Series.—The surface soils are light gray and underlain by impervious, plastic and gray to mottled gray and yellow subsoils. The difference in texture between the surface soil and subsoil in the case of the sandy members is very marked. The topography is flat and drainage is poor. The soils are locally known as "flatwoods" land. The timber growth consists largely of scrubby oak and post oak. About two million acres have been mapped.

Maverick Series.—The soils are light gray to brownish in color and the subsoils yellowish brown to drab and of heavier texture. They are formed by the mixing of limestone and sandstone with calcareous clays.

Monroe Series.—These soils are gray to brown, with mottled yellow and red friable structure of the subsoils. They occupy nearly level to rolling uplands throughout the Atlantic and Gulf Coastal Plains and have been derived mainly from the Piedmont-Appalachian material. The soils are usually deficient in organic matter. They are variously adapted to early, medium and late truck crops. The area mapped comprises thirteen and one-half million acres.

Nueces Series.—The soils and subsoils of this series are gray and are underlain by a stratum of stiff, mottled, grayish clay. The soils are derived from wind-blown material originally from the residual prairies, which has drifted inland from the coast. The surface is prevailing flat, with a few dunes. They are poor agriculturally. The soils are devoted to corn, truck crops, and pasture.

Oktibbeha Series.—These soils are prevailingly dull brown to yellowish brown. The subsoils are composed of somewhat mottled yellow, gray and red, rather plastic, silty clay. They are underlain by soft rotten limestone. The topography is flat to gently sloping. They are locally known as "post oak lands" or "post oak prairie lands." When properly handled they produce good crops of cotton, corn, Johnson grass, lespedeza, bur clover, and a number of other crops.

Orangeburg Series.—The soils of this series are marked by their gray to reddish brown color and open structure. The subsoils consist of friable sandy clay. They are confined to the uplands of the Atlantic and Gulf Coastal Plains, being most extensively developed in a belt extending from southern North Carolina to central Texas. This is a very valuable series, its heavier members being adapted to corn, cotton, cowpeas, peanuts, potatoes, and cigar leaf tobacco. Nearly five million acres have been mapped.

Portsmouth Series.—These soils are dark gray to black and are high in organic matter. The subsoils are light gray to mottled gray and yellow and the heavier types are always plastic. These soils are developed in flat to slightly depressed, poorly drained situations and require drainage before they can be used for agriculture. They are adapted to corn, strawberries and truck crops such as cabbage, onions and celery. Altogether 2,410,000 acres have been mapped.

Ruston Series.—The soils are gray to grayish brown, and are underlain by reddish yellow to yellowish red or dull red moderately friable subsoils, prevailingly of sandy clay. They are slightly lower in productiveness than Orangeburg.

San Antonio Series.—These soils are brown to chocolate brown in color and have brownish red calcareous subsoils. They are developed in the semi-arid regions of southern Texas. They are derived from calcareous material of sedimentary origin. Under irrigation they give excellent yields of a number of crops such as cotton, corn, sorghum, vegetables, and alfalfa.

Sassafras Series.—These soils are distinguished by their yellowish brown to brown color and mellow structure. The subsoils are reddish yellow and friable in structure, resting upon beds of gravel or sand varying from 2½ to 5 feet in thickness. They are developed along flat marine or estuarine terraces from 10 to 250 feet above sea level. They include some of the most productive soils of the Atlantic seaboard. Excellent crops of wheat, corn, clover, potatoes,

melons, berries and vegetables are secured. The area mapped is 1,717,000 acres.

Scranton Series.—These soils are dark gray to black, with yellow friable subsoils. The topography is flat and the soils are generally in need of better drainage. They are well suited to corn, oats, forage crops and a number of vegetables.

Susquehanna Series.—These are gray to reddish gray in color and are underlain by mottled red and gray or red, gray and yellow plastic heavy clay subsoils. Red is always the predominating color in subsoils, the other colors appearing as mottlings. The soils are developed in the higher portions of the Coastal Plain from Chesapeake Bay to Central Texas. The heavier members are heavy to handle on account of the intractable subsoil. Corn and oats are grown extensively in the northern, with cotton in southern states. More than 2,800,000 acres have been mapped.

Tifton Series.—The soils are gray to grayish brown in color and are underlain by bright yellow, friable, sandy clay subsoils. Small iron concretions occur on the surface and throughout the soil section. Their presence gives rise to the local name of "pimply or pebbly land." They are considered very valuable and are adapted to cotton, sugar cane, corn, cowpeas, velvet beans, oats, rye, sweet and Irish potatoes, pecans, figs, plums, and vegetables.

Victoria Series.—This series consists of brown to black soils with gray to whitish, calcareous subsoils, derived from the Pleistocene deposits of the Gulf Coastal Plains. The topography is rolling. Over four million acres have been mapped.

Webb Series.—The soils of this series are brown to reddish brown with reddish brown to red subsoil. They are found in the semi-arid areas of the Coastal Plains of Texas. They are cultivated to some extent. Most types are covered with thick growth of mesquite.

Wilson Series.—The series embraces dark gray to black soils, with mottled gray and drab to black subsoils, usually of stiff, heavy clay. They are typically developed in the mixed prairie and timbered regions of Texas and apparently hold a position intermediate between Houston and Lufkin series. Red is practically absent. The surface is frequently flat so that water stands after heavy rains. The heavier members dry out and bake quickly. Cotton and corn are the principal crops.

VII. RIVER FLOOD PLAINS PROVINCE

The soils of this province occupy the first bottoms and adjoining terraces of streams throughout that section lying east of the Great Plains region. Some areas of flood plains soil cover the bottoms and terraces of valleys which have been abandoned by their main streams.

These soils occur in continuous and interrupted strips along the banks of streams. They vary from narrow strips a few rods wide along the minor drainage courses and those streams which pass through gorge-like valleys to broad bottoms several miles in width. The broadest strip of strictly alluvial land is along the Mississippi River, where, at its confluence with the Arkansas, it is 75 to 100 miles.

The soils of this province include two topographic divisions: (1) The first bottoms or present flood plains, and (2) the terraces or old flood plains. The material composing these soils is derived from very widely distributed sources and from every species of rock. The principal series are as follows:

Bibb Series.—This series is marked by light-colored to white compact surface soils and by compact plastic and white or mottled white and yellowish subsoils. The material is derived mainly from Coastal Plains soils. They are best suited to grass and pastures under present conditions.

Blanco Series.—These have gray to light brown soils and brownish subsoils which in the lower portions change to plastic heavy materials of a decidedly brown color. The soil and subsoil are calcareous. These soils occupy terraces mainly above overflow. Soils are well adapted to cotton, corn, Irish potatoes, and alfalfa.

Cahaba Series.—The surface soils are brown to reddish brown and the subsoils are yellowish red to reddish brown. They are terraces principally above overflow. These soils are well suited to cotton, corn, oats, and forage crops.

Cameron Series.—These are soils of dark brown to black color and tenacious character and highly calcareous subsoil. The series occupies broad, shallow basins, occurring typically between river channels, and in general is poorly drained. The lower portions remain flooded during the greater part of the year. Alkali is frequently present in the lower depression. Good crops of corn, sugar cane, cotton, and vegetables are successfully grown.

Congaree Series.—The soils and subsoils of this series are brown to reddish brown, there being comparatively little change in

texture, structure and color from the surface downward. They occur as first bottom of the Piedmont region and in the Coastal Plain. Soils are productive, yielding corn, cotton, cane, oats and forage crops.

Frio Series.—These consist of dark-colored soils which have been brought down from the Edwards Plateau and deposited in terraces along the larger streams. They are excellent agricultural soils.

Genesee Series.—The Genesee series consists of dark brown to grayish brown alluvial sediment deposited along the major streams and their tributaries throughout the northeastern glaciated region. They are subject to overflow. Good soils for corn, oats, sugar beets, potatoes, cabbages, and grass.

Holston Series.—These consist of yellowish brown to brown surface soils and yellow subsoils. It is developed in old alluvial terraces, sometimes standing 200 feet or more above the first bottom of streams. The material is derived principally from sandstone and shale. The soils give fair to good crops of corn, wheat, oats, grass, clover, and forage crops.

Huntington Series.—These are light brown to brown and the subsoils yellow to light brown. Frequently there is little change in the color or character of the material. They occur in the limestone and Appalachian Mountain regions as first bottoms. They are excellent soils and well adapted to corn, oats, grass and forage crops under proper climatic conditions. More than 1,237,000 acres have been mapped.

Kalmia Series.—The surface soils are gray to grayish yellow. The subsoils are mottled gray and yellow. The series is found along streams of the Coastal Plain on terraces above overflow. The surface is flat. When properly drained the soils are suited to corn, cotton, sugar cane, and forage crops.

Laredo Series.—This series consists of gray to light brown, calcareous soils with gray, calcareous subsoils. They occur as terraces along streams in south Texas, and are quite valuable when irrigated.

Lintonia Series.—The surface soils of this series are light brown or yellowish brown and of silty texture. The subsoils are of slightly lighter color. They occupy stream terraces and alluvial land. Grass, forage crops, corn, oats, Irish potatoes, peanuts, cabbage, and vegetables are grown.

Miller Series.—These soils are of chocolate brown to pinkish

red color, with chocolate red or pinkish red subsoils. Both strata are calcareous. They are first bottom soils in Texas and are well adapted to cotton, corn, alfalfa, forage crops, and cabbage.

Myatt Series.—The Myatt soils are gray to dark gray. The subsoils are of gray to mottled gray and yellow color and impervious character. They represent the poorest drained portion of the Coastal Plain stream terraces. They lie principally above overflow. When drained they may be used quite profitably for sugar cane, corn, and a number of forage crops.

Ocklocknee Series.—These soils are dark gray to brownish, with brownish or mottled brownish, yellowish and gray subsoils. They occur in the Coastal Plains and are subject to overflow. Corn, oats, and forage crops are grown.

Osage Series.—They consist of dark gray to almost black alluvial wash from the sandstone and shale soils of the prairie regions. They produce good yields of general farm crops.

Podunk Series.—These are dark brown in color and overlie lighter brown to brownish gray or yellowish gray subsoils. They occur as rather high bottom lands, but are subject to overflow. They produce grass and heavy truck crops well.

Sarpy Series.—These soils range from light gray to nearly black. They possess loose silty or fine sandy subsoils distinctly lighter than the surface. They occur in the bottoms of the Mississippi and Missouri rivers and their large tributaries. They are very productive and adapted to grains, grasses, and alfalfa.

Sharkey Series.—These soils are of yellowish brown to drab color, with mottled rusty brown, bluish, drab and yellowish subsoils, of very plastic structure. They are very heavy alluvial soils of the Mississippi river, commonly called "buckshot land." They are well adapted to corn, sugar cane and cotton. About 1,600,000 acres have been mapped.

Trinity Series.—These soils are dark brown to black first bottom lands mainly derived from the Huston series. The organic matter content is high and lime is usually present. They occur as flat lands in shallow valleys. Large crops of alfalfa, cotton and corn are produced when the soil is well drained. The area mapped comprises 1,280,000 acres.

Uvalde Series.—These soils are alluvial and occupy broad level flood plains in Texas. They are light in color and very floury to the feel.

Wabash Series.—The soils are of a dark brown to black color

and high in organic matter. The subsoils are lighter drab or gray. They occur as first bottoms along the Mississippi. They grow large crops of grass and corn. One million nine hundred acres have been mapped.

Waverly Series.—The soils are light gray in color and overlie gray or mottled yellowish and grayish subsoils. They occur as first bottom land along streams issuing from the loessial region of the central prairie states. They are fairly well adapted to corn and grass.

Wheeling Series.—These soils are brown to yellowish brown and are underlain by gravel usually within 3 feet of the surface. They occupy the gravel terraces along the streams that flowed from the ice-covered regions.

Yazoo Series.—The color of the surface soil ranges from gray slightly darkened with organic matter to light brown, while the subsoils are of mottled grayish, rusty brown and sometimes bluish. They occur in the flood plains of the Mississippi river. They are well suited to cabbage, onions, peas, lettuce, Irish and sweet potatoes, cucumbers, melons, etc. Cotton, corn, and forage crops give good results on the heavy types.

VIII. GREAT PLAINS REGION

The Great Plains Region is bounded on the north and east by the Glacial and Loessial province, on the east and southeast by the Limestone Valley and Uplands province and the Gulf Coastal Plains, and on the west by the Rocky Mountains. It has a maximum width of 600 miles. In altitude it varies from 1000 to 6000 feet above sea level. Where not eroded it is a level or gently sloping plain. There are areas of excessively eroded or "bad land" topography. The Great Plains region extends from the Rio Grande to Canada. The Upland soils are divided into the following as to origin:

(1) **Residual Material.**—The residual soils are of widespread occurrence and constitute the most extensively developed and important province. Owing to their wide distribution these soils are subject to a wide variation of climatic influences that have been important factors in their formation. The series are as follows:

Bates Series.—These are of dark gray color, while the subsoils are yellowish and mottled red or yellowish or buff in the upper part and mottled with yellow and red in the deeper sections. They are treeless and of undulating topography. The crops are chiefly corn, wheat, flax, and oats.

Benton Series.—The soils are light brown or grayish brown to gray colored, with light gray subsoils. They are derived from limestone and shale and mostly used for grazing.

Boone Series.—This series consists of light gray soils of low organic-matter content underlain by pale yellowish to slightly reddish yellow and often mottled, porous subsoils. They are derived from sandstone and shales. The soils are often timbered and are frequently thin and unproductive. The principal crops are corn, oats, wheat, and hay.

Clark Series.—This series includes dark gray to brown or black soils and grayish calcareous subsoils. They produce fair crops of corn, kafir, wheat, sorghum, and alfalfa.

Crawford Series.—These comprise residual limestone soils of dark brown to reddish brown surface soils and reddish brown to red subsoils. Cotton, corn, wheat, oats, alfalfa, clover, and timothy are grown.

Englewood Series.—The soils are of brown to reddish brown color. The subsoils are usually reddish brown but sometimes brown. They are derived from shale and sandstone. They are generally adapted to corn, kafir, sorghum, and hay.

Epping Series.—The soils are white or light gray to buff and are underlain by subsoils of similar character. They are derived from shales and indurated clays. Wheat, barley, potatoes, and alfalfa are the principal crops.

Morton Series.—The soils are brown in color and contain a high content of organic matter. The subsoils are light brown to gray and are rich in lime. They are derived from sandstone and shales. Wheat, barley, and flax are the principal products. More than 13,000,000 acres have been mapped.

Oswego Series.—The soils are light gray to dark gray, while the subsoils are drab to yellow and are compact and impervious. They are derived from shale and sandstone. Wheat, corn, oats, flax, rye, and potatoes are grown.

Pierre Series.—The soils of this series are light brown to dark brown, the immediate surface often being light gray. They are usually compact and refractory. The subsoils are brown and compact and grade into a substratum of partially weathered shale. The surface is generally irregular, being dissected or eroded and marked by hills and ridges. Drainage is generally good. The types frequently contain rather excessive amounts of alkali.

Sidney Series.—The soils consist of brown surface soils, with

light gray to white, calcareous, floury, silty clay subsoils. They are derived from calcareous conglomerate. The more loamy types are good for general farming.

Summit Series.—The soils are dark gray to black, with mottled yellow and gray subsoils. They occupy nearly flat to sharply rolling prairies and are derived from calcareous shales. Corn, wheat, oats, timothy, clover, and alfalfa are the principal products.

Vernon Series.—The soils are reddish brown to red. The subsoils are usually red but sometimes reddish brown or brown in the upper part. Corn, wheat, oats, cotton, kafir and sorghum are the chief products. They are derived from sandstones and shales.

(2) **Glacial Material.**—The soils derived from this material do not occur extensively in this region. They are represented by a single series, the **O'Neill**. The soils are dark gray to brown, underlain by light brown subsoils resting upon sand or gravel. The topography varies from nearly level to rough and broken. The series is derived from glacial drift which underlies the loess. The deeper members have a high value for small grains, corn, potatoes, and forage crops.

(3) **Lake-laid Material.**—The soils of lacustrine origin are of only local occurrence. They are represented by three series of small extent.

(4) **Wind-laid Material.**—This series occupies a very extensive area in Kansas, Nebraska and South Dakota. The principal series are the **Canyon**, **Colby**, and **Valentine**.

Canyon Series.—These soils are light brown or ashy brown and the subsoils are yellowish gray. They are mainly derived from loessial material and are adapted to grazing and locally to corn, milo, kafir, and sorghum. The series occurs in Kansas and Nebraska.

Colby Series.—The soils are ashy gray or brownish gray. The upper subsoil is similar to or lighter in color. They are derived from loessial deposits. Wheat, corn, and forage crops are grown.

Valentine Series.—The soils consist of brown to dark brown, with light brown to brown and usually heavy subsoils. They are adapted to corn, potatoes, truck, and hay crops.

(5) **Alluvial Fan and Valley Filling Material.**—These have been derived from the great areas of Tertiary deposits with those less extensive areas of local alluvial fan and colluvial material.

They are unconsolidated, but include certain zones of material which is calcareous and more or less indurated or cemented.

Amarillo Series.—These include chocolate brown to reddish brown soils, with brown to reddish brown subsoils. The subsoil grades into a white or pinkish white calcareous material within three feet of the surface. They are derived from sandstone, shale, limestone, and crystalline rock. More than eleven million acres have been mapped.

Colorado Series.—The soils are of gray to reddish brown color and contain fine quartz and feldspar fragments. The subsoils are reddish brown. They grow vegetables, tree fruits, alfalfa, and melons.

Dawes Series.—The soils are ashy gray to light brown in color, with white to pinkish white subsoils.

Gannett Series.—The soils are light brown, with yellowish sand to light sandy loam subsoils. They are mostly utilized for pasture.

Greensburg Series.—The soils are brown to dark brown in color and the subsoils brown to yellowish brown. The soils are derived mainly from Plains Marl. They are usually treeless and produce wheat, corn, kafir, and sorghum.

Pratt Series.—The soils are brown, with dark reddish brown rather compact sticky subsoils, usually loam to clay loam in texture. They retain water well and under favorable conditions the soils are quite productive, giving good yields of kafir, corn, sorghum, and wheat. Nearly 2,000,000 acres have been mapped.

Richfield Series.—The soils are grayish brown, with grayish brown calcareous subsoils. They are retentive of moisture and produce wheat, corn, alfalfa, and forage crops. More than 8,000,000 acres have been mapped.

Rosebud Series.—The surface soils are dark gray to brown. The subsoils are light colored, almost white, and very calcareous. The topography ranges from undulating to steeply rolling and where badly eroded constitutes "bad land." More than 5,000,000 acres have been mapped.

Zapata Series.—The soils have gray calcareous surface, with subsoils of similar color and texture. They have a very low value for agriculture. They are used for grazing.

(6) **River Flood Plain Material.**—These soils are the flood plains and terraces along streams. They occur widely scattered

over the region, but are especially well developed as the wide valleys along the larger streams. The series are as follows:

Arkansas Series.—This series includes grayish brown or dark brown soils, with yellowish brown subsoils resting upon gravels and sands. The substratum is sometimes so near the surface as to cause deficiency of moisture. Soils may be subject to overflow. Wheat, corn, forage crops, and alfalfa are the principal crops.

Cheyenne Series.—The soils are brown with lighter brown or yellow subsoils underlain by sands and gravels. The soils occupy high valley terraces laid down while the streams were choked with ice. They are productive and adapted to grazing, small grains, corn, and potatoes. Under irrigation they grow alfalfa and fruits.

Laurel Series.—The soils are dark gray to brown and the subsoils are usually lighter in color and are underlain by porous gravel. Corn, small grains, forage, melons and cantaloupes are grown.

Lincoln Series.—The soils are dark brown to dark gray or nearly black, while the subsoils are dark gray to brown. Corn, forage crops, small grains, and alfalfa are grown. More than 2,300,000 acres have been mapped.

Tripp Series.—The soils are brown to light gray, while the subsoils are light gray to white. They are of alluvial origin. They are adapted to corn, wheat, oats, potatoes, and vegetables.

Wade Series.—The soils are brown to dark gray, drab or dark brown, while the subsoils are light brown, brown or gray to dark drab, rather heavy and compact. The crops are corn, small grain, flax, potatoes, and alfalfa.

IX. ROCKY MOUNTAIN AND PLATEAU REGION

This region covers the areas of elevated mountains and plateaus extending from Canada southward to the lower lying, arid, treeless plains and isolated ranges of the arid region of Arizona and New Mexico.

The soils vary widely in character owing to the great variety of material from which they are derived and the number of agencies active in their formation. Weathering in places has given rise to extensive areas of residual soils, while at the bases of the mountains large areas of colluvial soils are found. The stream valleys have terraces and flood plains, while the broad intermountain basins have extensive deposits of sediments.

(a) **Uplands.**—**San Luis Series.**—The soils are reddish brown in color and porous in structure and are underlain by sands

and coarse rounded gravel. They are derived mainly from volcanic rock.

(b) **River Flood Plains.—Billings Series.**—The soils are gray to drab, with the subsoils similar in color, structure and texture. They are derived mainly from shales and sandstones, and are adapted to a wide range of crops under favorable conditions of irrigation.

Laramie Series.—These soils are light brown to grayish brown with a slight reddish cast. The subsoils are lighter gray or more reddish, sometimes becoming yellowish gray, and are underlain by sand or sandy loam with gravel. They are treeless plains.

Mesa Series.—The soils are pinkish red or reddish gray to light reddish brown. The subsoils are of lighter reddish gray or gray color and heavier texture. Where irrigated, fruits, alfalfa, and general farm crops do well.

X. NORTHWESTERN INTERMOUNTAIN REGION

This region lies between the Pacific Coast region on the west, the Rocky Mountain region on the north and east, and the Great Basin region on the south.

The rocks of this region are mostly effusive or volcanic and the soil material is derived largely from these, either by weathering of solid material or from fragments ejected from volcanoes.

(a) **Uplands.—Ephrata Series.**—These soils are of light grayish brown to yellowish brown color, while the subsoils are porous but compact. They consist largely of glacial subangular or rounded gravel or boulders.

Quincy Series.—The soils are grayish brown and usually of loose porous structure. The subsoils are similar in color and texture but slightly more compact. They are wind-laid material.

Walla Walla Series.—This series consists of sticky, brown to dark brown soils about three feet deep underlain by yellow silt loam subsoils which are often sticky and plastic. The topography is high rolling hills. The soil material is wind-laid. Wheat, barley, and oats are the principal crops.

Winchester Series.—The soils and subsoils of this series are dark gray to nearly black and consist mainly of dark-colored angular fragments of basalt. The fine material is wind-laid.

(b) **River Flood Plains.—Boise Series.**—Soils are of light gray to light brown color. The subsoils are similar to the soils in color. They are underlain by a calcareous hardpan stratum. They are of alluvial origin.

Caldwell Series.—The soils range in color from gray to dark gray or black. The subsoils are usually of somewhat lighter shade, varying from light gray to drab, and are underlain by gravel. Small grains, timothy and other grasses, alfalfa, potatoes, and sugar beets are grown.

Yakima Series.—The soils range from light to grayish brown to yellowish brown or light brown in color. They are usually treeless plains and of alluvial origin. The immediate surface material is derived from basaltic or other eruptive rocks.

XI. GREAT BASIN REGION

This region embraces practically all of the Great Basin of Interior Drainage. It includes all of Nevada with the exception of the extreme southeastern parts, the western part of Utah, a small part of southwestern Idaho, the south central part of Oregon, and the greater part of the eastern margin of California.

The region is characterized by numerous isolated ridges and mountain ranges running in a general north and south direction, arid treeless plains and intermittent streams which disappear in the gravelly or sandy soil or discharge into broad lake basins mostly without outlets. Many of these basins were lakes in Quaternary time.

The soils are classified according to the agencies contributing to their formation.

(a) **Uplands.—Bingham Series.**—This series occupies the lower mountain and upper valley slopes and valley terraces or plains and is formed from mountain wash and delta cone deposits. They are quite fertile when irrigated and are adapted to alfalfa, grains, sugar beets, vegetables, and fruits.

(b) **River Flood Plains.—Jordan Series.**—The soils are usually dark in color but sometimes light gray or reddish, the heavier lower lying members being underlain by gray, black, yellow or red compact heavy and often calcareous subsoils. They are devoted to grains, alfalfa, fruits, and truck crops.

XII. ARID SOUTHWEST REGION

This region covers the southwestern third of Arizona, a large area in south central New Mexico and in northwestern Texas. It includes also a small area in southeastern Nevada and the southeastern extremity of California.

The region consists of sandy, gravelly sloping or flat treeless plains from which rise frequent low rounded hills and occasional

flat topped mesas and many isolated, elongated mountain ridges.

(a) **Uplands.—Glendale Series.**—These soils range from light gray or grayish brown to dark brown or chocolate in color and are underlain by gray to light brown highly calcareous subsoils. When irrigated they produce alfalfa, forage crops, vegetables, grapes and citrous fruits.

Imperial Series.—The soils are generally of light or reddish color, the heavier members being compact and plastic, poorly drained and alkaline. The soil material represents old lake deposits derived mainly from sandstone and shales.

Indio Series.—The soils are light gray to slate colored, porous, and underlain by coarser sand. They are derived from granites mixed with shales and sandstones. Melons, sweet potatoes, truck crops, etc., are grown under irrigation.

Yuma Series.—These soils are usually rather compact. The subsoil is similar to the soil except that at a depth of 2 to 6 feet layers occur that have the particles slightly cemented together with calcium carbonate. They generally occupy mesh lands. They are adapted to citrous fruits, figs, grapes, and vegetables.

(b) **River Flood Plains.—Gila Series.**—The soils of the lighter types are prevailingly of light yellowish brown, light grayish brown or slightly reddish brown color and porous structure. The heavier types range in color from brown or chocolate brown to dark gray or black and are compact. The series occupies stream flood plains and second bottoms or recent terraces.

XIII. PACIFIC COAST REGION

This region includes the area of California, Oregon and Washington west of the Cascade, Sierra Nevada, Sierra Madre and San Jacinto Mountains. A broad valley extends almost the entire length with only slight interruptions.

(a) **Upland.—Altamont Series.**—Soils are light brown to dark brown in color with a reddish tinge when wet. Subsoil is heavy, rather compact reddish brown or light brown clay loam or clay. The series occupies hilly to mountainous regions. The members of this series are residual, being derived from sandstone and shales. Hay and fruits are grown.

Corning Series.—The soils are of reddish brown or red to deep red color, rather shallow, easily puddled, and hard to handle except under proper moisture conditions. The subsoils are reddish brown to deep red, of heavy and compact structure and impervious to moisture. The soils occupy sloping to undulating and hilly and

dissected upland terraces and valley plains. They are poorly adapted to general farming.

Everett Series.—These soils range from light brown to light reddish brown in color and are of silky texture and porous structure. Large amounts of organic matter often occur in the immediate surface. The subsoils are light brown to gray and usually gravelly and porous. The material is of glacial origin and is derived from basaltic and intrusive rocks. Heavy forests abound. Some of the less porous types are adapted to dairying, orchard, and small fruits.

Fresno Series.—The soils vary in color from gray to light ash brown, the heavier low-lying members sometimes assuming a dark gray color as a result of accumulations of organic matter. They are usually free from gravel; a layer of white or bluish gray, impervious, calcareous, alkali-carbonate hardpan varying in thickness from a fraction of an inch to several inches separates the soil and subsoil. The hardpan slowly softens under irrigation, but is normally impenetrable to the roots of growing plants. They occur as old alluvial or colluvial deposits derived from granite rocks. If the hardpan is not too near the surface and irrigation is practiced alfalfa, grapes, fruits, and vegetables do well.

Hanford Series.—The soils are generally of light grayish brown or buff to light brown color, the heavier members carrying considerable organic matter and becoming dark gray to nearly black when wet. They are micaceous, smooth to the touch, friable, and of porous structure, generally free from gravel or boulders. The soil material represents recent alluvial stream deposits derived mainly from granite rocks. When irrigated they are well adapted to tree fruits, raisin and table grapes, nuts, vegetables and truck crops.

Hesson Series.—The soils are dark reddish brown and underlain by yellowish brown to reddish brown subsoils of compact structure. Rounded gravel and small boulders are common on the surface. The series occupies eroded terraces of undulating to rolling topography, usually several hundred feet above the valley bottoms. The material has been derived mainly from basaltic rocks and consists of old alluvial or marine terrace deposits. They are well adapted to general farming and orchard fruits.

Melbourne Series.—These soils are light brown to reddish brown in color and often dark brown in the immediate surface. When wet they are sticky and untractable, but under favorable moisture conditions are easily tilled. They are derived principally from shales and sandstones. The topography varies from

rolling to hilly. Much is too rough for the use of farm machinery.

Maracopa Series.—The soils range from dark gray through the darker shades of brown and chocolate to black. They are loose, porous, ordinarily well drained and free from alkali. The soils represent assorted, colluvial material, largely derived from granite rocks. When water is supplied they are well adapted to fruits, vines and general farm crops.

Lynden Series.—The soils are light brown to reddish brown and in the lighter textured sandy types often light gray on the surface. The subsoil is sandy or gravelly. Drainage is usually excessive. The soils are derived principally from stratified deposits of sand and gravel formed by glacial outwash. They occupy gently rolling upland terraces and plains formerly glacial flood plains, now dissected and eroded. All types are suited to agriculture.

Olympic Series.—These soils are light brown and brown with a reddish cast. The subsoils are generally of compact structure and somewhat lighter in color than the soils. They are derived mainly from basaltic rock. The topography is rough to mountainous. Rainfall is abundant and the soils are heavily forested. When not too rough they may be used for general farming and dairying.

Oxnard Series.—The soils are generally of dark color and compact structure, and though sometimes underlain by porous subsoils of light texture, are generally underlain by heavier subsoils. The subsoils lack the red color and adobe structure of the subsoils of the Placentia series. They represent alluvial delta plain deposits. These are particularly adapted to the production of lima beans. Sugar beets, barley, and vegetables do well.

Placentia Series.—The soils are reddish brown or brown and underlain by heavy, compact, red loams or clay loams of tough, impervious adobe structure. The soil material consists of alluvial outwash, deposits of intermittent or torrential mountain streams. They are derived from granitic rocks. They are tilled with difficulty but retain moisture well and produce grains, citrus fruits, and beans.

San Joaquin Series.—The soils are prevailingly red and frequently gravelly. Both the finer soil particles and gravel are rounded. The soils are underlain at depths ranging from 2 to 3 feet by red or mottled indurated clay or sandy layers and sometimes by gravel and cobbles cemented by iron salts into a dense, impenetrable hardpan. Some of the members are used in the

production of citrous and stone fruits, figs, grapes, small fruits, and truck crops.

Stockton Series.—The lighter members of this series have a buff to reddish or chocolate brown color. The heavier members generally exhibit a marked adobe structure, are usually free from gravel, and range from dark brown to dark gray or black in color. The heavier members are devoted mainly to the production of grains and hay.

Redding Series.—The soils range from reddish gray to deep red, are usually gravelly and sometimes carry large amounts of alkali and partially indurated clay-iron hardpan. Strawberries and bramble fruits yield abundantly.

Whatcom Series.—The soils of the Whatcom series are of a deep reddish brown color and prevailing of fine texture and rather compact structure. The surface soil is often dark brown or nearly black. Subsoils consist of drab to gray plastic and compact heavy silts, the upper portion carrying some gravel and glacial boulders. Soils are derived from compact glacial drift and occupy areas of undulating to rolling upland. The soils are adapted to small and orchard fruits, potatoes, vegetables and hay crops.

Willows Series.—The soils range in color from brown to reddish brown or dark chocolate brown and are free from gravel. The subsoils are light brown to reddish brown or sometimes yellowish and mottled with gray. They have a compact, relatively impervious structure and often contain lime and gypsum. They are derived mainly from calcareous shales, sandstone, and shaly sandstone rocks. Where well drained and free from alkali, they are well adapted to the production of alfalfa, grains and, with the exception of those areas of extremely heavy texture, sugar beets.

Yolo Series.—This series embraces alluvial soils of brown or dark brown color, underlain by lighter brown subsoils. The types have been derived from schists and other metamorphic rocks, with some material from shaly sandstones and shales. Where capable of irrigation, fruits, vegetables, and forage crops can be grown.

(b) **River Flood Plains—Chehalis Series.**—The soils are of recent alluvial origin, occupying stream valleys, traversing the region of residual basaltic soils that vary from gray or drab to reddish brown, some of the heavier types containing very much organic matter and showing a dark brown to black color. The subsoils vary from yellow, gray or mottled to light brown, dark brown,

or reddish brown to black in color. These soils are very productive.

Puget Series.—The soils are brown to grayish brown or drab and frequently mottled with iron stains. The heavier members are of rather compact and tenacious structure, containing a large amount of organic matter, and are usually friable under cultivation. The subsoils are light brown to drab or gray marked with iron stains. They occupy flood plains in the vicinity of estuaries or stream outlets. They are very productive and are classed among the very best soils of the region. Oats, forage, hay and truck crops and fruits all do well.

Sacramento Series.—The soils are dark gray, drab or black, often contain large quantities of organic matter and are six feet or more in depth. The series occupies stream bottoms and river flood plains. Alkali salts are sometimes encountered. Where protected by levees, the soils are productive and adapted to the intensive production of sugar beets, truck crops, beans, hops, potatoes, alfalfa, and prunes, pears and other fruits.

Salem Series.—The soils are dark brown to black in color and underlain by compact reddish yellow subsoils or by sands and gravels. They are recent alluvial deposits derived from basaltic rocks. Grains, truck crops and hops are the principal crops.

QUESTIONS

1. What is a soil Region? A Province?
2. How many of each?
3. Define a soil series.
4. Define a soil class.
5. What is a soil type?
6. Where does the Cecil series occur?
7. What are its characteristics?
8. What are the characteristics of the De Kalb series?
9. Give characteristics of Clarksville series.
10. Give characteristics of Carrington series.
11. Give characteristics of De Kalb series.
12. Give characteristics of Marshall series.
13. Give characteristics of Miami series.
14. Give characteristics of Volusia series.
15. Give characteristics of Williams series.
16. Give characteristics of Norfolk series.
17. Give characteristics of Orangeburg series.
18. Where is the Great Plains region? Give two series.
19. Where is the Arid Southwest region?
20. Locate the Piedmont Plateau Province.
21. Locate the Appalachian Mountain and Plateau Province. What are the two principal series?

REFERENCE

Marbut, C. F., Bennett, H. H., Lapham, J. E., and Lapham, M. H., Bulletin 96, Bureau of Soils U. S. D. A.

CHAPTER IX

SUB-PROVINCES, CLASSES, TYPES AND SURVEYS

IN working out the classification of soils in detail in a single state, it may be necessary to make other divisions, or sub-provinces, the soils of which have a common origin, but differ from those of other sub-provinces in some fundamental characteristics.

Sub-provinces.—On this basis the glacial and loessial province of Illinois has been divided into the following sub-provinces: (1) Unglaciated, comprising three areas, the largest being in the south end of the state; (2) Illinoisan Moraines, including the moraines of the Illinoisan Glaciation; (3) Lower Illinoisan Glaciation, covering the south third of the state; (4) Middle Illinoisan; (5) Upper Illinoisan; (6) Pre-Iowan, but now believed to be part of the Upper Illinoisan; (7) Iowan Glaciation; (8) Deep Loess Area, including a zone a few miles wide along the Wabash, Illinois and Mississippi rivers; (9) Early Wisconsin Moraines; (10) Late Wisconsin Moraines; (11) Early Wisconsin Glaciation; (12) Late Wisconsin Glaciation; (13) Old River Bottom and Swamp Lands, found in the older or Illinois Glaciation; (14) Sand, Late Swamp and Bottom Lands, those of the Wisconsin and Iowan Glaciation; (15) Gravel Terraces formed by overloaded streams draining from the glaciers and gravel outwash plains; (16) Lacustrine Deposits, formed by Lake Chicago or the enlarged Lake Michigan.

Soil Classes.—The soils of these sub-provinces are divided into classes based primarily on texture. The classes are as follows: (1) Peats, (2) Peaty Loams, (3) Mucks, (4) Clays, (5) Clay loams, (6) Silt loams, (7) Loams, (8) Fine sandy loams, (9) Sandy loams, (10) Sands, (11) Gravelly loams, (12) Gravels, (13) Stony loams. These are further divided into soil types.

Soil Types.—A soil type is the unit of soil classification. It is a soil unit which throughout the area has the same physical, chemical and biological characteristics. In the establishment of soil types, the following factors are taken into account: (1) Origin, whether residual, cumulo-se, colluvial, sedimental, glacial or cöial. (2) The topography or lay of the land. (3) The native vegetation, as forest or prairie. (4) The strata or character of surface, sub-surface or subsoil. (5) Physical composition or texture of the

different strata. (6) The structure or granulation. (7) The color of the strata. (8) The natural drainage. (9) The amount of organic matter present. (10) The agricultural value, based upon its natural productiveness. (11) The ultimate chemical composition and reaction, whether acid, neutral or alkaline.

Naming of Soil Types.—At first thought it might seem a very easy and simple matter to name soil types. It is on a single farm, but the difficulty increases with the size of the area, the number of different soils, and the detail desired. From the standpoint of everyone concerned, but more especially from that of the farmer, the simpler and more expressive the name the better, and the easier it will be to associate it with the soil. To a certain extent the name should be descriptive of the type. According to the nomenclature in use by the Bureau of Soils, names of soil types usually consist of two parts, the series name and the class name, with sometimes a modifying word included. The series name is that of some locality where the soil in question was first found or where it is well developed. This gives names as follows: Cecil silt loam, Marshall fine sand, Marshall black clay loam, etc.

The above system of naming is applicable to extensive areas, but for a limited area, such as a single state, a more expressive system may be devised. After the texture, one of the most striking characteristics of soils is the color. In the naming of soils in Illinois, a combination of color and texture together with other descriptive terms, when necessary, has been adopted as conveying the most meaning to those who use the name. Without ever having seen it, the name, so constructed, gives a very good idea of the character of the soil. As illustrations, gray silt loam on tight clay, yellow silt loam, brown silt loam on gravel, and medium peat on rock may be given.

There are such great variations in color that these color distinctions do not always strictly apply. The soil on rolling and hilly land is usually of a yellow color either on the surface or immediately beneath the surface soil, so that these are called yellow silt loams, yellow fine sandy loams, etc. The undulating timber soils are yellow or grayish and the term or name yellow-gray is applied to them. Prairies are either dark gray, brown, or black. The use of the term "on" as part of a soil type name indicates the presence of certain substrata within 30 inches of the surface. If the term "over" is used, the material, such as sand, gravel, or rock, is more than 30 inches below the surface.

Classes, Types and Phases in Illinois.—It may be of interest to give the classes of soils and their limits, with some of the types and their phases as used in the Illinois classification. In numbering soil types a system somewhat similar to the Dewey library system has been used, in which the whole numbers represent the sub-provinces and types, and the decimals, the phases. To illustrate: A soil has the number 726.5. The number 7 means that it occurs in the Iowan glaciation, the 26 that it is brown silt loam, and .5 that rock is found less than 30 inches below the surface. These numbers are convenient for use upon the soil maps in numbering small soil areas.

Peats—consisting of 35 per cent or more of organic matter sometimes mixed with some sand, silt or clay.

1. *Deep peat*—with peat more than 30 inches in depth. It is best drained by open ditches because of the unequal settling of tile, thus getting them out of line.
2. *Medium peat on clay*—with peat between 12 and 30 inches in depth. Tile drains are usually below the peat and therefore have a good bed.
 - 2.1 Medium peat on clayey sand.
 - 2.2 Medium peat on sand.
 - 2.4 Medium peat on gravel.
 - 2.5 Medium peat on rock.
 - 2.6 Medium peat on marl.
3. *Shallow peat on clay*—with peat 6 to 12 inches deep. It may be plowed sufficiently deep to bring up some clay for supplying potassium.
 - 3.1 Shallow peat on clayey sand.
 - 3.2 Shallow peat on sand.
 - 3.4 Shallow peat on gravel.
 - 3.5 Shallow peat on rock.
 - 3.6 Shallow peat on marl.

Peaty loams—consisting of 15 to 35 per cent of organic matter with a large proportion of sand and very little silt or clay.

10. *Peaty loam on clay*.
 - 10.1 Peaty loam on clayey sand.
 - 10.2 Peaty loam on sand.
 - 10.4 Peaty loam on gravel.
 - 10.5 Peaty loam on rock.

Mucks—15 to 35 per cent of decomposed organic matter mixed with much clay and silt.

13. *Muck on clay*.
 - 13.1 Muck on clayey sand.
 - 13.2 Muck on sand.
 - 13.5 Muck on rock.

Clays—soils with more than 25 per cent of clay, usually containing much silt.

15. *Drab clay*.
 - 15.1 Sandy drab clay.
 - 15.2 Gravelly drab clay.
 - 15.3 Drab clay on sand.

16. *Gray clay*.

Clay loams—soils with from 15 to 25 per cent of clay with much silt and some sand.

- 20. *Black clay loam.*
 - 20.1 Sandy black clay loam.
 - 20.2 Gravelly black clay loam.
- 21. *Drab clay loam.*
 - 21.2 Drab clay loam on sand.
- 22. *Gray clay loam.*
- 23. *Red brown clay loam.*
- 24. *Yellow gray clay loam.*

Silt loams—soils with more than 50 per cent of silt and less than 15 per cent of clay, mixed with some sand.

- 25. *Black silt loam.*
 - 25.1 Black silt loam on clay.
- 26. *Brown silt loam.*
 - 26.1 Brown silt loam on clay.
 - 26.2 Brown silt loam on sand.
 - 26.4 Brown silt loam on gravel.
 - 26.5 Brown silt loam on rock.
- 27. *Brown silt loam over gravel.*
- 28. *Brown-gray silt loam on tight clay.*
- 29. *Drab silt loam.*
 - 29.1 Drab silt loam on clay.
- 30. *Gray silt loam on tight clay.*
- 31. *Deep gray silt loam.*
- 32. *Light gray silt loam on tight clay.*
 - 32.1 White silt loam on tight clay.
- 33. *Gray-red silt loam on tight clay.*
- 34. *Yellow-gray silt loam.*
 - 34.1 Yellow gray silt loam on clay.
 - 34.2 Yellow gray silt loam on sand.
 - 34.4 Yellow gray silt loam on gravel.
 - 34.5 Yellow gray silt loam on rock.
- 35. *Yellow silt loam.*
 - 35.1 Yellow silt loam on clay.
 - 35.2 Yellow silt loam on sand.
 - 35.4 Yellow silt loam on gravel.
 - 35.5 Yellow silt loam on rock.
- 36. *Yellow-gray silt loam over gravel.*
- 37. *Yellow-brown silt loam.*
- 44. *Yellow-gray fine sandy silt loam.*
- 45. *Yellow fine sandy silt loam.*

Loams—soils with from 30 to 50 per cent of sand and with less than 15 per cent of clay. No one constituent predominates sufficiently to impart very definite characteristics.

- 50. *Black mixed loam.*
 - 50.1 Black mixed loam on clay.
 - 50.2 Black mixed loam on sand.
 - 50.5 Black mixed loam on rock.
- 51. *Brown loam.*
 - 51.1 Brown loam on clay.
 - 51.2 Brown loam on silt.
 - 51.3 Brown loam on sand.
 - 51.4 Brown loam on gravel.
 - 51.5 Brown loam on rock.

52. *Gray loam.*

53. *Yellow loam.*

54. *Mixed loam*—usually first bottom land.

Sandy loams—soils with 50 to 75 per cent of sand and less than 15 per cent of clay.

60. *Brown sandy loam.*

60.1 Brown sandy loam on clay.

60.2 Brown sandy loam on sand.

60.4 Brown sandy loam on gravel.

60.5 Brown sandy loam on rock.

60.6 Light brown sandy loam.

61. *Black sandy loam.*

62. *Gray sandy loam.*

64. *Yellow-gray sandy loam.*

64.4 Yellow-gray sandy loam on gravel.

64.5 Yellow-gray sandy loam on rock.

65. *Yellow sandy loam.*

65.5 Yellow sandy loam on rock.

66. *Brown sandy loam over gravel.*

67. *Yellow-gray sandy loam over gravel.*

68. *Brown-gray sandy loam on tight clay.*

Fine sandy loams—soils with from 50 to 75 per cent of fine sand and with much silt and less than 15 per cent of clay.

70. *Black fine sandy loam.*

71. *Brown fine sandy loam.*

71.5 Brown fine sandy loam on rock.

72. *Gray fine sandy loam.*

73. *Mixed fine sandy loam.*

74. *Yellow-gray fine sandy loam.*

75. *Yellow fine sandy loam.*

76. *Mixed sand and loess.*

77. *Brown fine sandy loam over sand.*

Sands—soils with more than 75 per cent of sand.

80. *River sand.*

81. *Dune sand.*

82. *Beach sand (Lake Michigan).*

83. *Residual sand.*

86. *Fine dune sand.*

Gravelly loams—soils with 25 to 50 per cent of gravel with much sand and little silt.

90. *Gravelly loam.*

Gravels—soils with more than 50 per cent of gravel and much sand.

95. *Gravel.*

Stony loams—soils containing large numbers of stones over one inch in diameter.

98. *Stony loam.*

Rock Outcrop.

The complete type number may be formed in each by prefixing the number of the area or sub-province in which it occurs.

SOIL SURVEYS.

In order to make a scientific study of soils and to apply the knowledge to practical agriculture, it is very desirable that the samples studied be taken from areas that are representative of more

than a single farm. The study of a sample that is ordinarily sent in by a farmer for analysis means little to the agriculture of a state or even a county. The samples must be taken from areas that represent some distinct type of soil and care must be taken to avoid errors due to local variations. In order to place the sampling and analysis of soils upon a truly scientific basis, a soil survey in which the different types of soil are located on a map should be made, and the samples secured according to the types shown by the soil map.

Soils are sufficiently uniform and constant in texture to be divided into distinct types with fairly well defined boundaries, and a soil survey consists in working out these boundaries in the field and locating them on a map. The type is the unit of the soil survey. The soils are examined to a depth of 40 inches by means of an auger, and the variations not only of the surface but also of sub-surface and subsoil are noted. In some cases where the deeper subsoil is peculiar and affects drainage, the examination may extend to a depth of 80 inches. This applies especially where sand or gravel subsoils occur.

Surveys in Different States.—Some soil survey work has been carried on in every state. It was begun in 1899 and since then 479,059,000 acres, or 25.2 per cent of area of the United States, have been surveyed. The soil survey of one state, Rhode Island, has been completed. Nearly all of the work that has been done has been in coöperation with the Bureau of Soils, this organization furnishing half the men and their expenses, while the state does an equal amount. In a few cases, as in Kentucky and Illinois, survey work has been done independently of the Bureau of Soils. In the latter state, 60 per cent of the entire area has been surveyed.

1. Objects of a Soil Survey.—The objects of a soil survey may be stated as follows: (a) to take an invoice of the agricultural resources of a country, for they depend first of all upon the soils; (b) to provide a scientific basis for consistent soil investigation so that time may be used to the best advantage in studying the various types and problems; (c) to furnish a basis for intelligent recommendations for permanent soil improvement; (d) to give the farmer who desires to study and improve his soil the information necessary; (e) in many counties to give to the county agriculturist a valuable asset to aid in his work; and (f) to give a basis for the introduction of new crops or farm practices. If the work ceases with the mapping

of the soils, very little of real value is accomplished, as the soil survey is only preliminary to a more complete investigation. If, however, the soils are analyzed, field experiments carried on, reports published giving the results of the work, and recommendations for improvement and management made, the farmer may avail himself of all this information for improving his soil and his farm management generally.

2. **Methods of the Survey.**—For the application of this information to the individual farm, it is necessary that the maps showing the soils of the farm should be accurate in all details. To accomplish this, three things at least are necessary: first, careful, well-trained men to do the work; second, an accurate base map upon which to show the results of their work; and third, the means necessary to enable the men to place the soil type boundaries, streams, etc., accurately upon the map.

For work in the field each man must be familiar with the soil types and their variations in the area he is surveying; he carries an auger for examining the soil to a depth of 40 inches, a map of the area made to the proper scale mounted upon a small, smooth, light board. Where a satisfactory base map is not available, one must be made before the mapping is begun or as the work progresses. A compass is carried to enable him to keep his directions, and he should be an expert at pacing distances and keeping his location. The mapper should have pencils for drawing in soil boundaries and other features, and coloring soil areas. A traverse plane table should be within easy reach to be used for getting the direction of roads and railroads. If buggies are employed the odometer may be used for measuring distances along roads or the revolutions of the wheel may be counted.

The party consists of two men who work side by side. It has been found necessary, in order to get the detail with sufficient accuracy, that all areas must be traversed and every ten acres inspected. To facilitate this, each section on the map used is divided into 40-acre plots and these form the most convenient unit area for work.

Certain lines are selected that form the center of the work, such as a section line in one case and a half section line in the other, and each man works an area one-half mile in width, inspecting the soil, locating and indicating on his map the soil boundaries, roads, streams, railroads and any other features that should be shown.

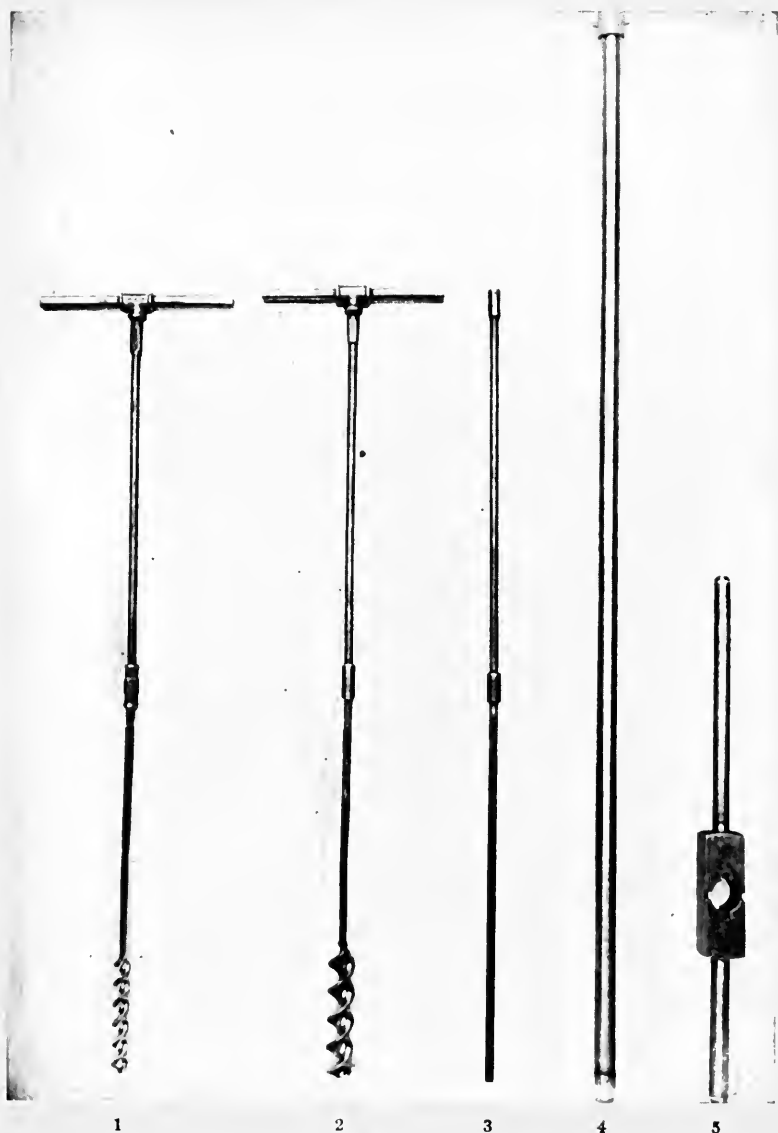

FIG. 64.—Soil Samplers; (1) one-inch field auger; (2) one and one-half inch sampling auger; (3) rods for extension of auger for examining deep subsoil; (4) King sampling tube, (5) hammer for forcing tube into soil and bar for lifting it out again.

In some cases areas of five acres or even less are shown, but only when the area is a very distinct type. In states where no land surveys have been made the roads form convenient lines from which to work.

3. Sampling of Soils.—In collecting soil samples for analysis each investigator has used his own method. Uniformity is very desirable for purposes of comparison. Since the samples are to be the basis of investigations and plans for soil improvement, it is highly important that they should be representative of their respective area or type. Whatever the stratum divisions made, they should be secured without mixing or contamination in any way. Various devices have been used, but the soil auger (Fig. 64), 40 inches long, seems best for the purpose in humid climates.

The total depth to which the sample is taken varies with the

Weight of Soil Strata

Pounds per acre			
Thickness, inches	Sands	Peats	Clays, clay loams, silt loams, loams and sandy loams
\wedge $6\frac{2}{3}$ Surface..... \vee	2,500,000	1,000,000	2,000,000
..... $13\frac{1}{3}$ Subsurface..... \vee	5,000,000	2,000,000	4,000,000
..... 20 Subsoil..... \vee	7,500,000	3,000,000	6,000,000

} 1
 } 2
 } 3

character of the soil and purpose for which it is collected. In arid regions sampling is frequently done to a depth of 10 feet, especially for moisture determinations, while in humid regions 40 inches is sufficient. The divisions are frequently made in 6-, 9-, or 12-inch depths, regardless of any natural divisions in the soil. At the Illinois Experiment Station the samples are taken with a 1½-inch auger to a depth of 40 inches. The samples are divided into (a) surface soil, 6⅔ inches in depth, about as deep as plowed, and representing an approximate weight of 2,000,000 pounds per acre for the common clays, clay loams, silt loams, sandy loams and loams; (b) the subsurface stratum, 6⅔ to 20 inches in depth, twice the thickness of the surface and representing approximately a weight of 4,000,000 pounds per acre; and (c) the subsoil, 20 to 40 inches in depth and weighing approximately 6,000,000 pounds per acre. Each of the three samples is put into a separate bag and analyzed separately.

Sands are the heaviest soils and peats and mucks are lightest, the latter two being only half as heavy as the former. The weights of the strata are given in the preceding table.

These divisions do not always represent the natural strata in the soil, but the depth of 20 inches is usually near the natural line of change between subsurface and subsoil, and although there is no change at 40 inches yet that is a very convenient point, since it gives the three strata with a relative thickness of 1, 2, and 3.

The sample should be composite, and this is much more important for the surface than either of the other strata, since it may have been modified more or less by tillage or other treatment. At the Illinois Experiment Station the surface sample is secured from 12 to 16 different borings at some distance apart, but all from the same ten acres. The subsurface and subsoil are secured from 6 to 8 different borings.

QUESTIONS

1. Define a sub-province.
2. What is the basis upon which classes are made?
3. What factors are taken into account in making soil types?
4. What is the system of soil nomenclature as used by the Bureau of Soils?
5. What is the significance of color in naming soils?
6. How are "on" and "over" used in naming soils?
7. Define peats.
8. Define deep, medium and shallow peat.
9. Define peaty loams and mucks.

10. How do clays differ from clay loams?
11. Distinguish between silt loams and loams.
12. What are the classes of sands?
13. Why should care be exercised in the selection of samples for study?
14. Give the objects of a soil survey.
15. Why should the surveyor examine the soils to a depth of 80 inches?
16. What is necessary to make the soil map valuable?
17. What apparatus is necessary for the soil surveyor?
18. How are samples taken?
19. To what depth are they taken and what divisions are made?
20. What precautions are to be observed in taking samples?
21. What is a composite sample?
22. What is the weight of the strata of peat? Of sand?

REFERENCES

- Soil Reports, Illinois Station.
Field Operations of the Bureau of Soils, U. S. D. A.
Kentucky Station Bulletins 162, 193, 194, 195.
Iowa Station Bulletin 82, 1905. Iowa Soil Survey Report, No. 1, 1917.
Soil Survey Reports. Wisconsin Survey Bulletins Nos. 28-40, 1913-14.
Ohio Reconnaissance Soil Survey. Field Operations Bureau of Soils, 1912.
Missouri Station Research Bulletin 3, 1910.
Pennsylvania Station Bulletin 132, Soils of Pennsylvania, 1914.
Michigan Geological and Biological Survey, Publication 7, Geological Series 5; Publication 9, Geological Series 7.
Tennessee Station Bulletin, vol. x, No. 3, 1897.

CHAPTER X

MINERAL CONSTITUENTS

I. SOIL PARTICLES AND THEIR SEPARATION

THE forces at work on rocks break them down into soil material, the particles of which are of various sizes and shapes. The relative proportion of the different sizes is a very important factor in the character of a soil. As a general rule where soils contain large percentages of a certain grade of particles, one or two per cent makes very little difference in the physical phenomena that take place. It is, however, of considerable importance to know the approximate physical composition or texture, as it usually gives some idea of the capillary power, aëration, percolation and other properties of the soil.

There are frequent exceptions to this, however. The physical composition gives no idea of the arrangement of the particles or structure of the soil. The aggregation of the particles into granules or crumbs plays a most important part in the physical phenomena that take place. Some expression for showing this is very desirable.

Mechanical or physical analysis, which is the process of separating a soil into the different grades of particles according to size, is an attempt to accomplish this.

As yet, however, no very scientific grouping of the soil particles has been devised. That of Dr. Hopkins is without doubt one of the best, as it recognizes a constant factor or ratio, the square root of ten, between groups. In other methods or schemes the ratio between grades varies quite widely. The result is that when an analysis is made of soils of a regularly decreasing or increasing size of particles no uniformity is shown.

Several systems have been devised, of which the principal ones in this country are given in the accompanying table.

It will be noted that in the Osborne system the factors vary from 2 to 5; in the Bureau of Soils from 2 to 10; in Hilgard's from 1.3 to 3; in the Hopkins system the constant factor is 3.16 or the square root of 10.

Different Systems of Physical Analysis, with the Grades and Ratio or Factor Between Grades¹

Number of group	Osborne		Hopkins		Bureau of Soils		Hilgard	
	Grades mm.	Factor	Grades mm.	Factor	Grades mm.	Factor	Grades mm.	Factor
1	3.000	..	1.0000	2.000	3.000
2	1.000	3	0.3160	3.16	1.000	2	1.000	3
3	.500	2	0.1000	3.16	0.500	2	0.500	2
4	.250	2	0.0316	3.16	0.250	2	0.300	1.66
5	.050	5	0.0100	3.16	0.100	2.5	0.160	1.87
6	.010	5	0.00316	3.16	0.050	5	0.120	1.33
7	0.0010	3.16	0.005	10	0.072	1.65
8	0.047	1.53
9	0.036	1.30
10	0.025	1.44
11	0.016	1.56
12	0.010	1.6

1. **Methods of Mechanical or Physical Analysis.**—(a) **The Sieve Method.**—The sieve method is used as a part of practically every system for the separation of gravel and some or all grades of sand. It consists of using sieves with openings of the required size for making the necessary separation. The separations may be made dry or by washing the material through with water. The latter is preferable.

(b) **The Subsidence Method.**—The soil to be analyzed is thoroughly disintegrated by shaking with water containing a few drops of ammonia. It is then passed through a battery of sieves to remove the sand and gravel. The water with the fine material in suspension is then placed in a wide-mouthed bottle and the finer grades are decanted first. This is accomplished by filling the bottle such as shown in figure 65 to a certain mark with water and allowing it to stand sufficiently long for the coarser grades to settle below the mouth of the tube. The supernatant liquid with its grade of soil particles is then blown off through the tube *B* by forcing air through the tube *A*. The contents of the bottle are stirred and sufficient time is allowed for the coarser particles to subside again. As the sands tend to carry the fine material down with them this operation must be repeated several times. The same thing is done for each of the other grades. The microscope is used to determine whether the proper size is being removed. The great amount of time required is a serious objection to this method.

(c) **Schöne's Elutriator Method.**²—The method of separating soil particles by currents of water of varying velocities was first

applied by Nobel in his apparatus given in figure 66. This was not very satisfactory and the same principle was applied somewhat differently by Schöne in his elutriator. The apparatus consists of a conical glass tube, as shown in figure 67. The sample, after thorough disintegration and passing through sieves to remove the coarser material, is placed in the tube and a current of water allowed

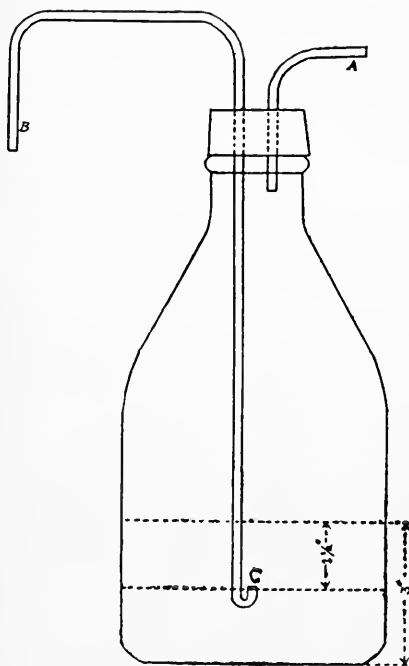

FIG. 65.—Bottle for Subsidence Method of mechanical analysis. By forcing air into the bottle through A, the water with the suspended particles is forced out through B to the level of C.

to enter at G. It is evident that the size of the particles carried upward and through the outlet tube will depend upon the rate of flow of the water, and by regulating this the separations are made. There are some inaccuracies in this method caused by counter-currents in the elutriation cylinder and the tendency of the particles to collect into granules. In order to overcome this, Hilgard devised his churn elutriator.

(d) **The Churn Elutriator Method of Hilgard.**³—This consists of an apparatus as shown in figure 68. The soil in suspension is placed in the base of a cylindrical tube which contains a rapidly revolving stirrer. Water is forced into the base of the tube in amounts sufficient to create an upward current just rapid enough to carry out the finest particles. When these are removed the rate of

FIG. 66.

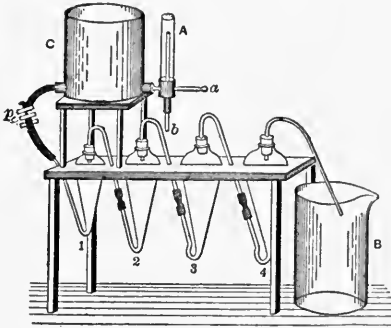

FIG. 68.

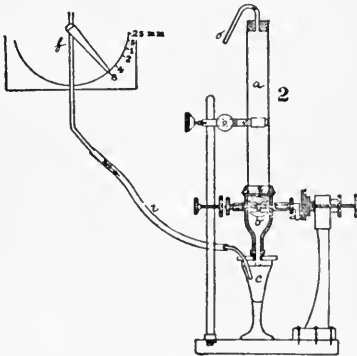

FIG. 67.

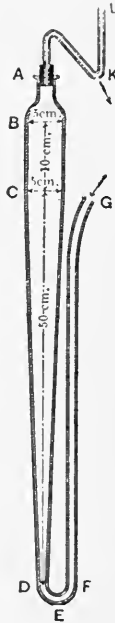

FIG. 66.—Nobel's Elutriator. The suspended soil is placed in *C* and allowed to flow through the conical glasses 1, 2, 3, and 4, giving five different grades.

FIG. 67.—Schöne's Elutriator. The water enters at *G* and the grades are collected at *K*.

FIG. 68.—Hilgard's Churn Elutriator.

the current is increased and another grade is carried out. A screen between the stirrer and the separating chamber prevents the agitation of water in this chamber. In this way all separations except the finest particles are made. Particles of clay less than 0.0023 mm. must be separated by subsidence. This is done by allowing the larger particles to subside for 24 hours and then decanting the clay.

(c) **Centrifugal Method.**⁴—The centrifugal method has been perfected by the Bureau of Soils and is now used more extensively in this country than any other. The machine for this purpose is shown in figure 69. It consists of a centrifuge suspended from the

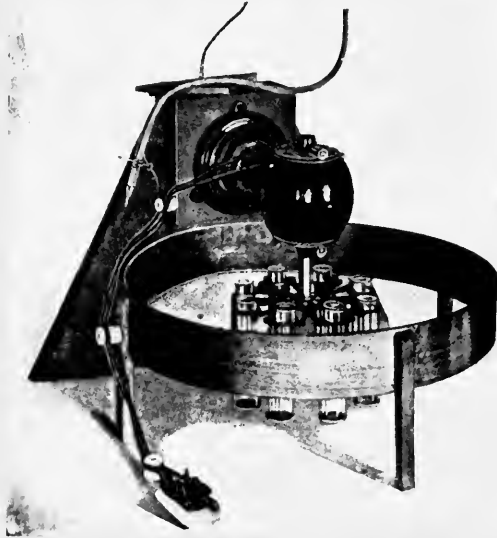

FIG. 69.—Machine for centrifugal analysis of soils. Bureau of Soils, U. S. D. A.

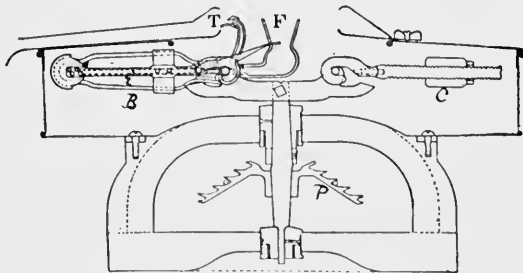

FIG. 70.—Yoder's Centrifugal Elutriator.

shaft of an electric motor. The sample to be analyzed is delocculated by shaking with water containing a few drops of ammonia. This requires from two to thirty hours. The clay and silt are separated from the sands by subsidence and decantation or by sieves

The water containing the silt and clay is put in test tubes and whirled at a speed of about 1000 revolutions per minute. The time necessary to throw down the silt is determined by microscopic examination of the material in suspension. After decanting the clay remaining in suspension, the test tube is filled with water, the sediment is stirred and the operation repeated until the clay is all removed. By running the centrifuge at a slower rate or shorter time another grade may be left in suspension and decanted.

(f) **Yoder's Centrifugal Elutriator.**⁵—One of the best machines for physical analysis is Yoder's, in which he has combined the principles of the centrifuge and the elutriator, as shown in figure 70. The particles are subjected to two forces, the centrifugal tending to throw them down and the hydraulic carrying them upward. The centrifugal effect is exerted to a greater extent upon the coarser particles and the hydraulic upon the finer. By this combination a more rapid separation may be accomplished. The apparatus consists of an elutriating bottle, *B*, into which the suspended soil is placed after the sands are removed. Water enters at *F*, and the overflow with the sediment

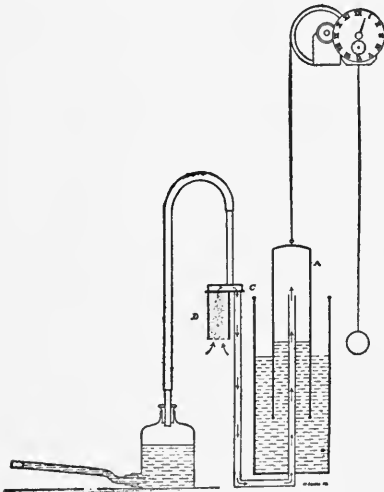

FIG. 71.—King's aspirator for the determination of the effective diameter of soil particles.

is collected in the tube *T*. While it does its work very thoroughly and quickly, it is a very expensive and a rather delicate piece of apparatus.

(g) **King's Aspirator Method.**⁶—King was of the opinion that ordinary mechanical analyses do not furnish a basis for determining any very important data for soils. The arrangement of the particles into groups is of much consequence in physical phenomena, but mechanical analysis does not indicate the structure. In order to overcome this difficulty he worked out the method for finding the "effective diameter" of soil particles. The grouping of particles upon which the percolation of air and water and other phenomena depends is taken into account. The rate at which air passes through a column of air-dried soil of a given cross section and length under

standard conditions of temperature and pressure gives the data by which the diameter is determined. The soil is placed in *D*, figure 71, a tube having a capacity of 100 or 200 c.c. with a wire gauze bottom. This is connected by means of a tube to the aspirator *A*. A cord with a weight attached exerts sufficient "pull" to draw the air through the soil. The "effective diameter" is deduced by means of a formula using the data determined. The flow of water through the soil computed from the "effective diameter" obtained corresponds very closely to that actually observed, as shown in the table.

Comparison Between Computed and Observed Flow of Water

Grade of sand	Effective diameter of particles	Computed flow of water	Observed flow of water
	<i>mm.</i>	<i>Gms.</i>	<i>Gms.</i>
8	2.54	2,277	2,296
7	1.808	1,132	1,090
6	1.451	757	756
5½	1.217	522	542
5	1.095	453.2	504.6
4	.9149	297.5	329.2
3	.7988	193	210.0
2	.7146	122	138.6
1	.6006	80.6	94.8
0	.5169	66.8	72.3

II. MINERAL SOIL CONSTITUENTS AND THEIR PROPERTIES

1. **Colloids.**—While the colloids of soils are usually classed along with clay, their importance justifies separate treatment. Although not as abundant in soils as many other constituents, yet they possess such distinctive characteristics and impart these so noticeably that they are of the greatest consequence not only from a physical standpoint but from a chemical and biological as well. Non-colloids are called crystalloids.

Colloids are substances composed of the very finest of particles and when mixed with water appear to go into solution. When containing a certain amount of water they appear jelly-like or gelatinous. Since the colloidal state is dependent upon the size of particles, it follows that many substances may exist in both colloidal and crystalloidal forms. Up to the present time only about 400 substances have been found that exist in both.

Examples of Colloids.—The word colloid is derived from *colla*, meaning glue. A glue or jelly-like consistency is one of the most familiar characteristics of colloids. In the inorganic world almost

all metals and metalloids have been produced in a colloidal state. The simplest compounds of these, as oxides, sulfides, chlorides, hydroxides, some carbonates, chromates, phosphates, sulfates, and silicates, occur in this form. Among the organic substances that occur as colloids are starch, dextrin, gum, rubber, glue, gelatine, caseins, albumins, humus, and proteins in general.

Properties of Colloids.—The difference between colloids and crystalloids is one of physics and not of chemistry. The chemical composition is the same in whichever state they occur. Hence, a study of colloids is largely a study of their physical properties and characteristics.

(a) *Size of Particles.*—The upper limit of size for colloids is near the limit of visibility with the ordinary high-power microscope, which is not far from 0.0001 mm. With the most powerful microscope some of the largest colloidal particles may be seen; with the ultra-microscope, particles 0.000005 mm. in diameter are about the limit of visibility. Many smaller particles exist, but their presence is revealed only by the properties of their suspensions. The particles larger than 0.0001 mm. give ordinary suspension and may sometimes show some properties of colloids. Those between the above size and the molecule give colloidal suspensions, while the molecules give true solutions.

The smaller the particle the longer it will remain in suspension. This is due to the fact that the specific gravity of the particle and its adhering film of water have such a low specific gravity that it varies but little from that of water (see page 35).

(b) *Brownian Movement.*—Very fine particles in water are constantly in motion. This movement is not a definite progressive one, but an irregular, jerky motion from one side to the other. Particles as large as 0.01 mm. sometimes show a slow movement of this kind, but it is best developed in the very finest particles. The movement is increased by higher temperature.

(c) *Dialysis.*—Dialysis is the diffusion of a substance through a membrane. Experiments show that colloids will not pass through membranes or at best only very slowly. Separation of colloids from crystalloids may be made in this way.

From the following table it will be seen that dialysis takes place about 80 times as rapidly with crystalloids as with colloids. This is due to the fact that the parchment itself is a colloid.

(d) *Diffusion.*—Colloids diffuse very slowly and they do not allow other colloids to pass into them. Crystalloids may pass into

or through them quite readily. Because of this lack of power to diffuse, colloids possess very little osmotic pressure. Pfeffer gives the osmotic pressure of a one per cent solution of sugar as equivalent to a column of mercury 51.8 cm. high, while that of a one per

Dialysis and Diffusion of Colloids and Crystalloids

Substances	Amount dialyzed in equal times	Times of equal diffusion
<i>Crystalloids</i>		
Sodium chloride.....	1.00	1.0
Ammonia	0.85	0.6
Alcohol.. ..	0.47	2.0
Glucose.....	0.36	3.0
Cane sugar.....	0.47	3.0
Average.....	0.63	1.92
<i>Colloids</i>		
Gum arabic.....	0.008	7.0
Tannin.....	0.015	11.0
Albumin.....	0.003	21.0
Caramel.....	0.005	42.0
Average.....	0.00775	20.25

cent of gum is only 6.9 cm. From the above table it will be seen that crystalloids diffuse over ten times as rapidly as colloids.

(e) *Freezing and Boiling Points.*—The lowering of the freezing and boiling points by crystalloids such as common salt in solution is familiar to every one. The change in these is in proportion to the amount dissolved. Colloids have very little effect. Forty-four grams of protein dissolved in 100 grams of water lowered the freezing point only 0.06° C.⁷

(f) *Electrical Behavior.*—Colloids are poor conductors of electricity as compared with crystalloids, and their conductivity decreases with the amount of colloid in the disperse medium. Any substance in contact with water and many other liquids acquires an electric charge. Most substances become negatively charged in contact with water. The charge can be varied and even reversed by electrolytes and may even become zero at certain suitable concentrations. If a current of electricity is passed into a colloidal solution, the particles migrate to one pole or the other. If they migrate to the negative pole (cathode) they are positive, and if toward the positive pole (anode) they are negative. The colloidal condition

exists as long as the charge is the same. This condition is not confined to colloidal particles alone, but to coarser material in suspension.

If an electrolyte is added to the solution and the ions and particles carry opposite electric charges, floccules are formed which settle to the bottom. If the ions and colloidal particles have the same electric charges the colloidal condition is maintained. If two colloids of opposite charges are brought together, mutual precipitation will take place, and if they are the same their stability will be increased. In adding an electrolyte to completely precipitate a colloid a sufficient amount must be added so that the charge of one exactly neutralizes the charge of the other.

(g) *Adsorption*.—Adsorption is a surface phenomenon and hence any increase in the total amount of surface area will increase the adsorption. Colloids possess this property to a high degree because of the large total area of the small particles. When a solid is exposed to a gas a certain amount of gas adsorption occurs. When a solid and a liquid come in contact, concentration occurs on the interface between the two. This concentration is known as adsorption. All substances are not equally adsorbed by colloids. The same is true of all ions. If potassium chloride is passed through a soil more of the potassium ions will be adsorbed than of the chlorine.

(h) *Shrinkage*.—The property of shrinkage is very characteristic of colloids (see Fig. 72).

Colloids in Soils.—The colloids in soils consist of both organic and inorganic or mineral substances.

(a) *Organic Colloids*.—Some of the various forms of humus constitute the organic colloids and probably form the larger part of colloids in many soils. These are formed as a result of bacterial action in the process of humification. Part of the organic matter is broken down into such minute particles as to form colloids. The amount is constantly changing in the same soil. Since granulation takes place more perfectly in the spring than at any other time of the year, it would seem that there is a greater supply in the soil at this time than at other periods. This may apply to mineral colloids as well. The adsorptive power of these organic colloids for water is of great economic importance in soils. Schlössing states that one per cent of calcic humate (colloidal) has as much cementing power as 11 per cent of plastic clay.

(b) *Mineral Colloids*.—Mineral colloids are found most abundantly in fine-grained soils such as clays and clay loams. The col-

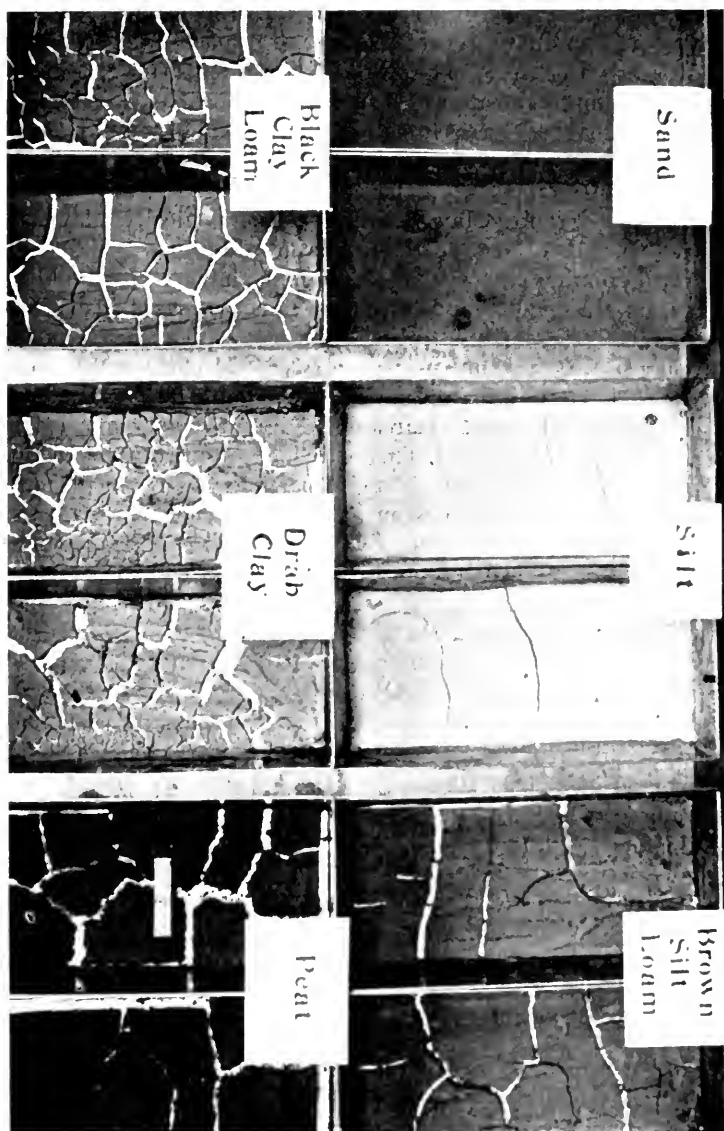

FIG. 72.—Shrinkage of different types of soil. The effect of clay and organic matter is well shown in black clay loam, drab clay and peat. Sand shows very little shrinkage. Soils were almost saturated at beginning. College of Agriculture, University of Illinois.

loids consist largely of ferric oxide, ferric hydrate, silicic acid and hydrated aluminum silicate. These are formed in the decomposition of rocks. In the decomposition of most feldspars the silicic acid and aluminum silicate are formed, but not all in a colloidal state. Zeolites easily give rise to colloidal silica. While many substances exist in a colloidal state in soils, yet the total amount is not large. Warrington estimates it at never over two per cent.

2. **Clays and Clay Loams.**—Mineralogically clay is composed largely of kaolinite, a hydrous aluminum silicate that is formed from decomposition of aluminous minerals. In addition, it may contain very finely divided particles of quartz, feldspar or other minerals. In fact, clay may be composed entirely of other minerals than kaolinite, although this is not usually the case. Physically, clay consists of particles less than 0.001 mm. in diameter (Hopkins), 0.005 mm. (Bureau of Soils) or 0.0023 mm. (Hilgard) (see table on page 124). This is divided into two parts, which may be called clay proper, consisting of particles large enough to be distinguished with the microscope, about 0.0001 mm. in diameter, and a small amount of hydrous aluminum silicate whose particles are very small and constitute part of the mineral colloids.

(a) **Tenacity.**—Tenacity is that quality of cohesiveness by which substances resist disruption, imparting more or less stability to them. In soils this property is due primarily to colloids. Clays and clay loams, however, possess this property to a high degree. Soils have been divided according to their tenacity into "heavy" and "light." A "light" soil is one that works easily, as sand or peat, and incidentally has a high specific gravity, as sand, or a low specific gravity, as peat, but all possessing very little cohesiveness. "Heavy" soils, on the other hand, are those containing a great deal of clay, and hence possessing a high tenacity. Clays, clay loams, and heavy silt loams and some sandy loams are examples of these. In absolute weight they are not as heavy as the sand soils, but the greater tenacity possessed by them makes them more difficult to plow. Hence the term "heavy" is applied to them.

A high moisture content decreases tenacity. However, a medium amount of moisture imparts a high degree, as does also an extremely small amount of moisture, as where the soil becomes dry and cloddy. This is due to the hardening of colloids and the deposition of soluble salts as a cementing material between the soil particles. The tenacity of "heavy" soils may be diminished by the addition of or-

ganic matter, and in general by anything, as lime, that will produce granulation.

(b) **Shrinkage.**—Clay possesses the property of shrinkage to a remarkable degree, due to the loss of moisture from the particles in general but the colloidal constituent particularly. This shrinkage is emphasized when a large amount of humus is present, because the humus is partly colloidal. Clay has been found to shrink 31.9 per cent, and peat 32.6 per cent (see accompanying table). Hence a soil composed of both of these will possess the property of shrinkage to a great and sometimes injurious degree.

Shrinkage of Soils of Varied Physical Composition, with the Moisture and Organic-Matter Content ⁸

Soils	Total organic matter	Moisture	Areal shrinkage
	<i>per cent</i>	<i>per cent</i>	<i>per cent</i>
Sand.....	0.75	9.67	1.88
Yellow fine sandy loam.....	0.80	21.39	2.48
Brown sandy loam.....	2.90	17.43	4.94
White silt loam.....	0.79	23.69	4.11
Brown silt loam.....	4.88	31.93	10.26
Black clay loam.....	5.50	40.83	19.00
Drab clay.....	3.60	61.94	31.93
Peat.....	64.40	193.94	32.64

This property is frequently detrimental to crops, because of the formation of large cracks that tear the roots of the plants as well as cause excessive loss of moisture (Figs. 72 and 73). The property of shrinkage is a primary cause of granulation, and this is only possessed by soils which contain colloids. It is also an aid to percolation and drainage, because the cracks produced by shrinkage do not close entirely, thus leaving passageways for water. During the dry summer of 1914, a clay loam shrank to such an extent that an inch auger could be pushed into cracks without any effort to a depth of 24 to 28 inches. The cracks undoubtedly extended to a depth of 36 inches.

(c) **Plasticity.**—A moist clayey soil may be molded into any form or pressed into thin plates, retaining the shape indefinitely. The property permitting this is called plasticity. The degree of plasticity varies directly as the amount of colloids present. It is not a desirable quality for soils to possess, as such are liable to be more readily puddled. The amounts of shrinkage, hygroscopic water and adsorption are approximate indications of the plasticity of clay soils.

Highly plastic soils become very hard upon drying. Plasticity may be diminished by organic matter, granulation or change of texture.

Plasticity may be increased by the breaking down of soil granules into their individual soil particles. While this is detrimental to soils, it is of decided advantage to the ceramist.

(d) **Puddling.**—Clays and clay loams are usually made up of crumbs or granules, composed of many soil particles united by a weak cementing substance, such as humus or some other colloid. If



FIG. 73.—Cracks in black clay loam after a long dry period. Photographed August, 1916.

the soil is worked or trampled by stock when wet these granules are broken down, the colloids become somewhat uniformly distributed throughout the mass and an impervious condition results. The soil is puddled. Water or air will not penetrate it and a worse condition could not well be produced. The presence of sodium carbonate or black alkali, or the long-continued application of certain fertilizers, such as ammonium sulfate or sodium nitrate, brings about a puddled condition. Some clay and clay loam soils are puddled naturally. This is likely to be the case if they are strongly acid and low in organic matter.

Water in a soil acts as a lubricant and movement takes place more readily between the particles. It also softens the cementing material so that the granules are easily broken down. When the soil is turned by the plow a shearing, slipping movement is produced as it curves over the mold board. This will pulverize it if in good condition, but puddle it more or less if wet. When a heavy animal steps on the dry soil it is compacted, but if wet the foot sinks into the soil, causing a movement which breaks down many granules, thus puddling the soil.

When puddling is produced in a heavy soil it may be almost worthless for a time, but the natural agencies of freezing and thaw-

ing and wetting and drying will gradually restore the soil to its granular condition. The time required for this depends somewhat upon the organic matter and lime content of the soil. It is never a wise plan to permit stock to run on a moderately heavy soil when wet so late in spring that its granular condition will not be restored again by freezing and thawing. In the corn belt considerable damage is done to the soil by pasturing the cornstalks too late in the spring.

(e) **Coagulation or Flocculation.**—The examination of a clay soil usually shows it to be made up of fine particles cemented into granules, crumbs, or grains. If a few grams of clay soil be pulverized and put into a liter of water and stirred and allowed to stand for several weeks, some material will be found still in suspension. If some mineral acids or certain salts or lime water are added to this liquid coagulation will occur and floccules may be seen forming, which gradually settle to the bottom, carrying with them the suspended clay particles. This may be well shown by putting a drop of water with suspended clay under the microscope. Introduce a drop of lime water under the cover glass. The particles will at once begin to collect in groups, showing the formation of floccules. This process takes place in soils due to the presence of certain substances in solution in the soil moisture that act as electrolytes. In some cases, fertilizers when added produce this effect, and limestone, which gives rise to the soluble bicarbonate, produces flocculation. This is, however, a slow process and will not produce granulation as quickly as is ordinarily supposed, although heavy acid soils are undoubtedly benefited physically by the application of limestone. Common salt produces the same effect and likewise many other salts. Most alkaline substances, however, detlocculate clay soils and produce a puddled condition. Ammonia and most of its salts are good examples. The black alkali of the West is especially detrimental because of the physical effect it has on soils in producing a puddled, impervious condition. This, however, may be remedied by the application of gypsum, calcium sulfate. The injurious effect of sodium carbonate or black alkali is destroyed by this reaction and sodium sulfate and calcium carbonate produced, the latter of which has a flocculating effect on the soil and soon changes the puddled condition entirely. It has been observed frequently that the water of glacial streams is extremely muddy, while that coming from limestone regions is characterized by clearness. The difference is due to the lime content of the water from the two sources. In

regions where limestone is absent and where the sediment of streams comes from acid soils the water is rarely clear. Even stock ponds in regions of acid soils where the water is seldom disturbed never become clear.

While clay soils are difficult to manage, due to the danger of puddling when too wet and from clods when too dry, yet with proper care, drainage, incorporating organic matter and maintaining the supply of limestone, the condition of these soils may be improved so they work fairly well. In addition to the flocculation produced by the substances mentioned above, natural causes hasten it. Wetting and drying, and freezing and thawing, will change the character of the soil from a cloddy to a granular condition, or cause it to "slake." The alternate expansion and contraction of the colloidal material, whether of mineral or organic origin, tend to break the soil into granules. Fall plowing is especially desirable on "heavy" soils that are well drained, because of the good tilth developed during winter by these natural agencies. If a clay soil becomes cloddy it is practically impossible to reduce it to a condition of good tilth by any mechanical means, but if freezing and thawing occur, or a shower falls, working it under the right moisture conditions will break the clods easily into masses of granules.

3. Silt and Silt Loams.—Silt is divided into three classes, fine, medium, and coarse, ranging in size from 0.001 to 0.032 mm. in diameter (Hopkins), 0.005 to 0.05 m. (Bureau of Soils) or 0.01 to 0.07 mm. (Hilgard). The particles of fine silt are sufficiently small to give to soils properties somewhat similar to those of clay, but without so much danger of puddling. Silt enables soils to retain much moisture and gives great capillary power, and hence forms some of the best soils for resisting drouth. They are sufficiently coarse, however, to permit of fair aëration, but not to an excessive degree, as in the case of sands. The silt loam soils cover extensive areas in the middle west of the United States and owe their origin to the loess.

They possess sufficient tenacity to give the necessary stability, but not enough to cause them to work with any great difficulty. The shrinkage, however, is not usually sufficient to produce very injurious effects. Since granulation depends upon the amount of colloids present, and since organic matter as well as clay may furnish this constituent, the silt loams containing the largest amount of organic matter granulate best. Silt soils deficient in organic matter, such as gray or yellow timber soils, show little or no granulation

and may be easily reduced to a powder or dust made up of individual particles. These run together badly with heavy rains.

4. **Sands and Sandy Loams.**—Sand is divided into three groups, fine, medium, coarse and sometimes very fine, varying from 0.032 to 1 mm. in diameter (Hopkins), 0.05 to 1 mm. (Bureau of Soils), or 0.12 to 1 mm. (Hilgard). Sand possesses very little tenacity, hence little stability. There is usually great danger of movement by the wind and in many cases sand soils are seriously damaged in this way, as is seen in the "blow-outs" in sand areas (see p. 59). This movement may be prevented by incorporating organic matter which imparts sufficient tenacity to hold the sand. The fine and medium grades of sand allow fair moisture movement both up and down, but the coarse allows too much percolation, while capillary movement is exceedingly limited. It is generally believed that sands are very deficient in moisture and that the "firing" of corn on sandy lands is always due to this cause. Often, however, it is due to a lack of nitrogen, the drying of the lower leaves being produced by translocation of nitrogen to carry on further growth in other parts of the plant. This drying of the leaves may be almost entirely prevented by supplying the crop with the necessary food. The fact that sands do not retain much moisture enables them to warm up early in the spring.

5. **Gravel and Gravelly Loams.**—Many types of soil contain considerable percentages of gravel. It is of very little use except that through its extremely slow decomposition it furnishes a small amount of plant food. It may form a part of any type of soil, but is more commonly associated with the coarser constituents.

6. **Stones.**—Stones are quite common in many soils of the glaciated and residual areas, but have very little value except to modify temperature and conserve moisture to a slight extent. Their slow decomposition may provide a small amount of plant food.

QUESTIONS

1. What benefit is a knowledge of the physical composition of soils?
2. What is meant by mechanical or physical analysis?
3. Why is the Hopkins method considered superior to others?
4. Note the different factors or ratios between the grades. How much do they vary?
5. Should these factors be constant? Why?
6. How is the sieve method used?
7. Explain how the separations are made in the subsidence method?
8. What is the principle of Schöne's elutriation method?

9. What advantage does Hilgard's method possess over Schöne's?
10. What effect does whirling the sample in the centrifuge have?
11. What is the principle of Yoder's machine?
12. What is the advantage of King's aspirator?
13. Describe the method of King.
14. What is the importance of colloids in soils?
15. What are colloids?
16. Why may substances be in both colloidal and crystalloidal forms?
17. Give examples of inorganic colloids.
18. Give examples of organic colloids.
19. Does colloidal condition depend upon physical condition or chemical composition?
20. What about the size of particles in colloids?
21. Why do small particles remain in suspension so long?
22. What is Brownian movement?
23. What is dialysis?
24. What difference in the dialysis between colloids and crystalloids?
25. Discuss diffusion of crystalloids in comparison to colloids.
26. What effect do colloids have upon the freezing and boiling points of liquids?
27. What is peculiar in the electrical behavior of colloids?
28. What effect does an electrolyte have upon the colloids?
29. When will an electrolyte completely precipitate clay in suspension?
30. What is adsorption?
31. Is it uniform for all substances?
32. What are the organic colloids in soils?
33. What are the mineral colloids?
34. What may be the mineral composition of clay?
35. What is tenacity?
36. Define a "light" soil. A "heavy" one.
37. What is the effect of moisture on tenacity?
38. How may the tenacity of soils be diminished?
39. What causes soils to shrink?
40. What benefit is derived by shrinkage? What disadvantage?
41. Define plasticity.
42. How may plasticity be increased? Diminished?
43. What is the condition of a puddled soil?
44. What effect does water have on ease of puddling?
45. Why does plowing tend to puddle a wet soil?
46. What agencies destroy a puddled condition?
47. Why is fall plowing of heavy soils beneficial?
48. What advantages do silt soils possess over clays?
49. What about shrinkage and granulation of silt soils?
50. Why does sand possess little tenacity?
51. What effect does this have?
52. What is "firing" of corn and what is the cause?
53. What value has gravel in soils?
54. What value have stones in soils?
55. Define tenacity.
56. Of what value are colloids in soils?
57. What property causes black clay loam to "roll" upon wagon wheels?

REFERENCES

- ¹ Briggs, L. J., Martin, F. O., and Pearce, J. R., Bulletin 24, Bureau of Soils, U.S.D.A., The Centrifugal Method of Soil Analysis, 1904, p. 33.
- ² Wiley, H. W., Principles and Practice of Agricultural Analysis, 1906, p. 231.
- ³ Op. Cit., p. 246.
- ⁴ Bulletin 24, Bureau of Soils, 1904, p. 12.
- ⁵ Yoder, P. A., Bulletin 89, Utah Station, The New Centrifugal Soil Elutriator, 1904.
- ⁶ King, F. H., Physics of Agriculture, 1907, p. 121.
- ⁷ Zt. f. phys. Chem., Leipsic, 9, 88 (1892).
- ⁸ Unpublished data, Soil Physics Division, University of Illinois.

General References.—Fletcher, C. C., and Bryan, H., Bulletin 84, Bureau of Soils, U.S.D.A., Modification of the Method of Mechanical Analysis, 1912. Rohland, Paul, The Colloidal and Crystalloidal States of Matter, 1914, D. Von Nostrand Co., New York. Hatschek, Emil, An Introduction to the Physics and Chemistry of Colloids, 1913, J. & A. Churchill, London. Ostwald, translated by Fischer, Handbook of Colloid-Chemistry, 1915, P. Blakiston's Sons & Co., Philadelphia.

CHAPTER XI

ORGANIC CONSTITUENTS OF SOILS

By far the most valuable constituent of soils is the organic material derived from the plants and animals that have lived in and on the soil. The term *organic matter* will be used to include all material from organisms, to distinguish it from the term humus of more restricted use. *Humus* refers, in its restricted meaning, only to that portion of organic matter that is soluble in dilute alkali.

Kinds of Organic Matter.—Organic matter exists in the soil in every stage of decay, from that whose cellular structure is still visible, to that very similar to coal. It may be divided into (a) *active* or fresh, which decomposes readily; (b) the *inert*, which is usually old and decomposes too slowly for the use of crops; and (c) the coal-like material that oxidizes with extreme slowness, if at all, and whose chief use is to impart a dark color to the soil (Figs. 74 and 75). The active is the most important and is that form which is ordinarily supplied to the soil as manure and legumes. Under long-continued, injudicious systems of cropping the active organic matter is largely removed and the result is exhausted, "run-down" or "worn-out" land. To maintain the productiveness the organic matter must be supplied in considerable quantities and of a form that will decay readily. It is equally essential to supply organic matter in a more stable or less readily decaying form, as straw, corn stalks or other non-leguminous material, since these benefit the soil physically for a longer time than legumes.

Amount of Organic Matter in Soils.—The organic-matter content of soils varies quite widely in the same locality. Even in soils from which it has not been removed by erosion a distance of a few rods may make a great difference in the amount. Soils contain from a small fraction of a per cent to 90 per cent. Swamp lands generally contain most, while sand soils contain least.

How much organic matter a soil should contain is a question often asked and one very difficult to answer. A soil may contain five per cent of organic matter and be less productive than one with only two per cent. Much depends upon its activity or rapidity of decomposition. The chances for large yields are decidedly in favor of the soil with a large organic content. A soil with a few tons of fresh

or quickly decaying organic matter, such as clover or manure, may give better results than a soil full of old, slowly decomposing organic matter unless the conditions are most favorable. There should be sufficient organic matter to keep the soil in good physical condition and also furnish nitrogen for maximum crops. The organic content depends upon several factors, as follows:

(a) **Moisture** exerts a double influence in aiding the accumulation of organic matter in soils. In the first place, it is favorable to the growth of plants. It makes very little difference how little or how much moisture is present in the soil, some plants have adapted themselves to growing under those conditions. Even where water stands nearly all the year, cat-tails, flags, sedges, and some grasses

FIG. 74.

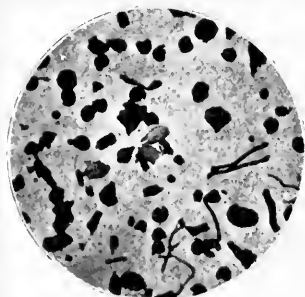

FIG. 75.

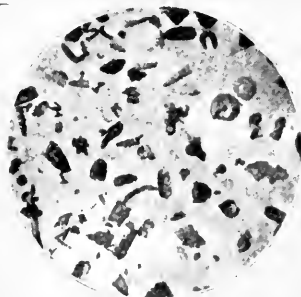

FIG. 74.—Fragments of plants found in soils. (Bulletin 90, Bureau of Soils.)
FIG. 75.—Fragments of insects found in soils.

grow luxuriantly. In the second place, the presence of excessive moisture tends to preserve the plants, which ultimately form soil themselves or become mixed with the mineral matter and aid in forming soil, such as peats, peaty loams, and mucks. Even soil with an ordinary amount of moisture prevents complete oxidation of the roots and other fresh vegetable material that becomes incorporated with it. Soils containing small amounts of water, such as sands provide very favorable conditions for oxidation, and hence the organic-matter content of such soil is low.

Overflow land generally contains more than the adjacent upland because of the greater growth due to a richer soil, the better facilities for its preservation because of greater moisture content, and the deposition of some organic matter along with the sediment during periods of overflow. This deposit may cover leaves and grasses, thus preserving them from complete decay.

Arid soils are naturally low in organic matter because the moisture is not sufficient to produce a large growth of vegetation.

(b) **Vegetation.**—The upland timber soils contain much less organic matter than the adjacent prairies. It is safe to assume that the prairies were much more extensive formerly than now. Newly formed lands were originally treeless and covered by smaller plants, but more especially grasses. This was particularly true in the glaciated area. The prairies were covered with grasses whose network of roots extended to a depth of 8 to 20 inches or more. A sample of virgin blue stem prairie sod on brown silt loam contained roots at the rate of 13½ tons per acre to the depth of 6⅔ inches. Part of these roots died each year, and the partially decayed material accumulated in the soil, forming the black prairie soils of the corn belt. In Illinois the analyses of 302 samples show the surface soil to a depth of 6⅔ inches to contain 4.53 per cent, or about 45 tons of organic matter per acre. This includes the rolling and flat prairie soils, but not the swamps. The subsurface, 6⅔ to 20 inches in depth, showed an organic-matter content of 2.8 per cent.

That this is probably true as to the origin of the black earth soil or chernozem of Russia is well shown by the following table which gives the relative amount of roots and percentage of humus in six-inch depths:

*Roots and Humus in Three Chernozem Soils at Different Depths. The Roots in the Surface Six Inches is Taken as 100 Per cent*¹

Depth	1		2		3	
	Roots	Humus	Roots	Humus	Roots	Humus
0-6 inches . . .	100	5.42	100	8.11	100	9.64
6-12 inches . . .	89.1	4.83	63.9	5.19	80.3	7.77
12-18 inches . . .	66.9	3.62	48.3	3.92	70.0	6.71
18-24 inches . . .	47.3	2.56	35.0	2.84	58.4	5.81
24-30 inches . . .	47.3	2.50	26.0	2.11	38.2	3.57
30-36 inches . . .	34.6	1.88	18.1	1.47	33.0	3.18
36-42 inches . . .	23.9	1.29	6.3	.51	16.2	1.56
42-48 inches . . .	14.4	.7870
48-54 inches . . .	6.7	.36

These determinations are rather typical for semi-arid or rather sub-humid prairie soils where there is a greater tendency for the roots to penetrate deeply. A similar condition exists in humid soils, with this difference, that the great mass of roots is nearer the surface.

The invasion of the prairies by forests has been going on very slowly. The first trees to spread over the prairies were wild cherry,

black walnut, hackberry, elm, ash, and bur-oak. The shade of the trees and the undergrowth that slowly crept in killed the grasses, and the plants that replaced them supplied very little organic matter to the soil. The leaves and twigs accumulated upon the surface and decayed completely or were burned by forest fires. The organic matter that had accumulated was slowly being removed by oxidation of nitrification, with the result that the soils were gradually changed until a light-colored soil resulted. When this change had taken place the trees mentioned above were gradually replaced by white oak, hickory, and others adapted to light-colored soils or soils low in organic matter. Several generations of trees were required to effect this change. So great was the reduction of organic matter that the timber soils contain less than half as much as the prairie. The analyses of 164 samples of timber soil show 1.93 per cent in the surface and 0.77 per cent in the subsurface.

(c) **Limestone.**—Soils rich in limestone are usually well supplied with organic matter, due to the fact that limestone encourages a larger growth of vegetation, especially of legumes, and is very effective in retaining humus in the soil against leaching.

(d) **Latitude and Altitude.**—As a general rule soils of northern latitudes have more organic matter than those of southern. While the conditions for a luxuriant growth of vegetation are not so favorable in the north, yet the conditions for its preservation are so much better that the result is a larger organic content. This is well shown in Illinois. The deposit of loess in the State along the Mississippi River is the same throughout the length of the State. The analyses of eight samples of deep loess from the south end of the State show 1.11 per cent of organic matter, while four samples from the north end show 3.86 per cent. Eighteen samples of timber soil from the south end of the State show 1.5 per cent of organic matter in the surface and 0.58 per cent in the subsurface, while the same general character of soils in the north shows 2.4 and 0.96 per cent respectively. The same is true of the prairie soils. The brown prairie soils from the latitude of the southern part of the early Wisconsin glaciation show 4.5 per cent, while the same type 150 miles to the north contains 6.1 per cent.

Changes of Organic Matter.—When vegetable matter becomes mixed with soil it undergoes a physical change produced by bacterial action in which the plant tissues are destroyed, and it becomes a black or dark brown homogeneous mass. At the same time a chemical change takes place. The process at first is quite rapid, but later

becomes very slow, and still later ceases almost entirely. The supply of oxygen is somewhat low in the soil and the conditions are not favorable for complete oxidation of the vegetable matter. The partial oxidation produces organic matter of varied composition. In this change the hydrogen and oxygen content of the vegetable matter becomes less, while the proportion of carbon and nitrogen increases. The organic matter of the soil under different conditions may contain from three to twenty times as much nitrogen as the original material. This change may be carried so far that ultimately carbonized material may be produced that is similar to coal or char-

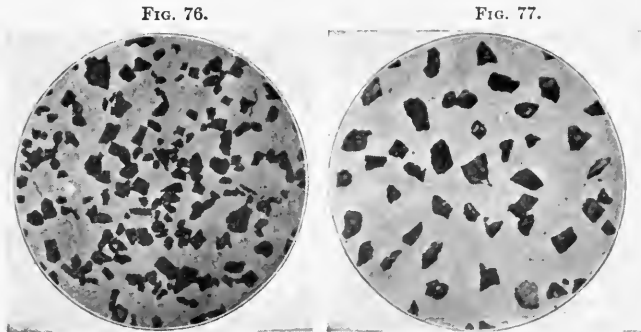

FIG. 76.—Specimens of charcoal and charcoal-like material found in soils.
FIG. 77.—Specimens of coal found in soils. (Bulletin 90, Bureau of Soils.)

coal¹ (Figs. 76 and 77). This does not undergo further change. The humus accumulates more rapidly in very moist soils than in comparatively dry ones.

The following table from Hilgard shows the changes in the formation of coal, probably somewhat similar to those changes of organic matter in soils:

Progress of Humification, and Formation of Coal² (Moisture and Ash Omitted From Calculations)

	Cellulose	Humin and humic acid	Peat			Coals		
			Brown	Black		Lignite brown coal (Bovey)	Scotch splint bituminous	Pennsylvania anthracite
				Surface (Umin)	40 inches			
Carbon.....	44.44	49.4-59.7	57.80	62.00	64.10	69.50	84.20	94.80
Hydrogen.....	6.17	2.5- 4.5	5.40	5.20	5.00	5.90	5.80	2.60
Oxygen.....	49.38	35.8-47.3	36.00	30.70	26.80	24.00	8.80	} 2.60
Nitrogen.....3-18.7	.80	2.10	4.10	.60	1.20	

While this table does not represent exactly the changes that take place in the soil under all conditions, yet Schriner and Brown have shown that many particles of coal and charcoal-like material exist in the soil, indicating that this process probably occurs in soils. Some of this may be the result of fires.

Nitrogen Content of Humus.—Moisture plays a very important part in determining the composition of organic matter of soils, indicating that the process of humification is quite varied under different conditions. This difference is well shown in the nitrogen content of humus from arid and humid regions. Hilgard has shown that soils of California vary in humus content with the rainfall, but their nitrogen appears to be independent of humidity.

*Humus and Nitrogen Content of Humid and Arid Soils of California*³

	Humus	Nitrogen in humus	Nitrogen in soil
	<i>per cent</i>	<i>per cent</i>	<i>per cent</i>
Arid soils, California.....	.91	15.23	.135
Sub-irrigated arid, California.....	1.06	8.38	.099
Humid soils, California.....	2.45	5.29	.135

Later investigations seem to indicate that the nitrogen content of the humus in arid soils is not as high as the above figures show. The organic matter of humid regions contains a somewhat variable amount of nitrogen. One hundred and twenty-six surface samples of prairie soils contained 5.1 per cent of organic matter, the nitrogen of which was approximately 4.88 per cent. The average organic-matter content of 39 surface samples of timber soils was 1.93 per cent, which contained 5.09 per cent of nitrogen. By multiplying the nitrogen content of a humid soil by 20 a fair approximation of the amount of organic matter may be obtained.

The character of soil humus will also depend upon the character of the material from which it is derived. Snyder, of Minnesota, has determined the amount of nitrogen in humus from different sources.

*The Amount of Nitrogen in Humus from Different Materials*⁴

Humus from meat scraps.....	10.96 per cent nitrogen
Humus from green clover.....	8.94 per cent nitrogen
Humus from cow manure.....	6.16 per cent nitrogen
Humus from oat straw.....	2.50 per cent nitrogen
Humus from sawdust.....	.32 per cent nitrogen

Distribution of Organic Matter in the Soil Strata.—The content of organic matter diminishes with depth in all normal soils so that at from three to six feet the amount becomes very low. In arid

soils the content runs more uniform and to greater depth, due to deeper root development. In swamp soils there is frequently a great accumulation in the surface and upper subsurface, with rather a sudden decrease at a distinct line. Timber soils show a greater decrease in the subsurface than prairie soils. The organic matter is usually deeper in alluvial soils than in others. The distribution depends to a large extent upon the depth of root development, the effect of burrowing animals, the accumulations that are taking place as in bottom and swamp lands and the cracks produced by shrinkage, which is especially characteristic of clay and clay loam soils.

Organic Matter in Soil Strata ⁵

Soil types	No. of samples	Surface 0-6 2/3 inches	Subsurface 6 2/3-20 inches	Subsoil 20-40 inches
		<i>per cent</i>	<i>per cent</i>	<i>per cent</i>
Brown silt loam.....	122	5.30	3.10	0.91
Black clay loam.....	29	7.03	3.58	1.02
Yellow-gray silt loam.....	51	2.33	0.89	0.57
Yellow silt loam.....	35	1.76	0.69	0.48
Gray silt loam on tight clay.....	18	2.40	1.31	0.70

Value of Organic Matter to Soils.—It is next to impossible to assign a definite money value to organic matter as in the case of nitrogen, phosphorus, and potassium. The difficulty arises from the fact that when incorporated with the soil it has several different effects, physical, chemical, and biological, any one of which is of sufficient importance to justify its use. The value of organic matter must in the end be determined from the value of the increase in crops produced. This has been worked out for manure and is being determined for other forms of organic matter, such as crop residues and legumes. The things for which it is of value are as follows:

1. **Granulation** is one of the most important properties of heavy and medium soils. This gives permeability for both air and water, and very desirable working qualities that heavy, non-granular soils do not possess. In fact, some of the most intractable soils are clays that are quite low in organic matter. The granular structure lessens the tenacity. This latter is especially noticeable in heavy soils. There is no one constituent so beneficial to such a large class of soils as organic matter. Its removal from a soil destroys its power to granulate almost entirely. When the humus is taken from brown silt

loam and black clay loam by leaching with dilute ammonia, the power to granulate is lost.

Figure 78 shows the effect of removal of humus upon the granulation of black clay loam and drab clay. The silt loams granulated very little even with organic matter. Each soil has been wet and dried several times. Cropping with the continued removal of organic matter will ultimately bring about a condition of poor granulation and consequently poor tilth.

3. **Retaining Moisture.**—There is no better method of increasing the moisture holding capacity of soils than by adding organic



FIG. 78.—The effect of the removal of humus and of wetting and drying upon granulation. Drab clay is the only one that shows any tendency to granulate when humus is removed. (University of Illinois.)

matter. It acts as a sponge itself, and when mixed with the mineral part of the soil gives higher porosity and consequently greater water capacity. It retards capillary movement in soils, as well as aids in the production of a better mulch, both of which help in retaining moisture by reducing evaporation. Sand permits of rapid percolation with comparatively small amounts of water retained. If organic matter is added to sand, the retentive power of sand will be greatly increased. This table shows the effect.

*Effect of Organic Matter on Retention of Moisture in Sand*⁶

Soil material	Grams of water retained by 100 grams	Increase, per cent
Coarse sand.....	13.3
Coarse sand with 5 per cent peat.....	18.6	40.0
Coarse sand with 10 per cent peat.....	24.7	85.7
Coarse sand with 20 per cent peat.....	40.0	200.7
Peat.....	184.0	1283.4

The movement of capillary moisture is principally along the surfaces of mineral soil particles that are in contact, and the more points of contact the larger the amount and the greater the rapidity of movement. Organic matter introduces many very irregular particles which diminish the number in contact. As a result capillary movement is slow in soils rich in organic matter.

3. **Puddling.**—The particles of soils low in organic matter are not cemented together into crumbs and hence are free to move. When these dry soils become wet there is a rearrangement of the particles, due to the drawing force of the surface film, by which they are brought closer together, and the pore space is so diminished that water cannot penetrate the wet stratum very rapidly. This is spoken of as “running together,” but is really one form of puddling. The change is produced by the tension of the film of water drawing the particles together. This action may be seen where drops of water fall in dust during a shower.

Soils low in organic matter are easily puddled if worked when wet, and a longer time is required for the natural agencies to correct this condition than if the soil is well provided with organic matter. Since granules are destroyed by puddling a correction of this condition is produced when by any means granulation is restored.

4. **Prevents Loss by Erosion.**—Erosion causes very serious loss on many soils. A vast amount of the richest soil material is removed annually from the rolling land by the excess of rainfall that runs off as surface drainage. The more the run-off the greater the amount of washing. It is practically impossible to prevent this entirely. The loss may be diminished by methods given in Chapter xxvii.

5. **Increases Temperature.**—Organic matter imparts a darker color to the soil, thus increasing the absorption of heat, and raising the temperature, and, as a general rule for well-drained soils, the darker the soil the higher the temperature. Light-colored soils are cold, while dark ones are warm. This difference in color may increase the temperature from four to ten degrees F. at a depth of four inches during a clear day and give the crop on the dark soil a distinct advantage.

6. **Biological Effects.**—Biological and consequently chemical action is increased by organic matter, not only because it provides a food supply for the organisms, but also because it brings about physical conditions favorable to the action of bacteria which produce chemical action.

7. Furnishes Nitrogen to Crops.—The only source of nitrogen for our non-leguminous crops is organic matter. Nitrogen starvation goes hand in hand with low organic content in soils. This is evidenced by the yellowish-green color of corn, oats, or wheat on eroded land deficient in organic matter in contrast to the dark green color where this constituent is abundant. It supplies nitrogen, the most expensive food element used by plants, one that we cannot afford to buy for ordinary farm crops. A 100-bushel crop of corn per acre requires 150 pounds of nitrogen, the commercial value of which at 15 cents per pound is about \$22.50. Other crops require somewhat similar amounts. Legumes are independent of organic matter, as they obtain their nitrogen from the air.

8. Binds Soil Particles Together.—On sandy soils well-decomposed organic matter binds the sand grains together and reduces movement by wind. It also increases the water-holding capacity, as seen before.

Losses of Organic Matter.—The amount of organic matter in the surface stratum of the ordinary upland soils varies from 15 to 60 tons per acre. This has required thousands of years for its accumulation, but through the systems of cropping generally practiced it is being removed from the soils much more rapidly than it ever accumulated.

(a) **By Cropping.**—The amount of organic matter removed annually from a soil well supplied with it in reasonably active form, such as brown silt loam, is not far from three-fourths to one ton per acre. A large portion of this is used indirectly by the crop, while the remainder is lost by the natural processes described below. In comparing a virgin prairie soil with the same soil after cropping for sixty years, it was found that the organic-matter content of the soil has been reduced approximately fifty tons per acre. Of course, in soils with a smaller amount of organic matter the total removed is necessarily less. The amount removed depends to some extent upon the crop grown. The inter-tilled crops use more nitrogen, and more organic matter would be decomposed to produce it than non-tilled crops. It must be remembered that loss of nitrates either by cropping or leaching means loss of organic matter from the soil.

(b) **By Erosion.**—Organic matter may be removed from the soil by erosion. Very few regions are so flat or have the soil so well protected that there is not more or less erosion taking place, and in the more rolling areas this becomes a very active agent in the removal of the organic matter along with the soil. In this way in

certain regions almost all of the surface soil and its organic matter have been removed, and yellow "clay points" are quite common. These are nothing more than the outcropping of a stratum, either of subsurface or subsoil, which contains little or no organic matter. Even on brown silt loam areas much loss of organic matter takes place through erosion, and this becomes more serious the longer cropping continues.

(c) **By Leaching.**—In the partial decomposition of vegetable matter soluble organic acids are formed. These may be removed in part by the water which percolates through the soil during heavy rains. This is especially true of acid soils. It is not uncommon to see the drainage water of peat bogs of a brownish color, due to the dissolved organic matter. The presence of small amounts of certain alkalies, as ammonia and sodium carbonate, increases the solvent power of water for humus.

(d) **By Fires.**—Fires of even moderate intensity destroy large amounts of organic matter from the immediate surface, and even in the burning of straw, stubble, or corn stalks considerable organic matter is lost from the soil. Snyder⁷ gives the following: "The soil from Hinckley, Minnesota, before the great forest fire of 1893 showed 1.69 per cent humus and 0.12 per cent nitrogen. After the fire there were present 0.41 per cent humus and 0.03 per cent nitrogen. The forest fire had caused a loss of 2500 pounds of nitrogen per acre, or thirteen tons of organic matter." Much organic matter that should be plowed back into the soil is burned.

(e) **By Oxidation or Nitrification.**—The process of oxidation is carried on through the influence of bacteria which are always present in fertile soils. Under favorable conditions of moisture, temperature, and aëration these organisms are very active agents in destroying organic matter. They are especially active in cultivated and well-aërated soils, and while their work means destruction to organic matter, they are at the same time performing a function absolutely necessary for the growth of plants. In the destruction of organic matter they are producing plant food essential for crops. In the growing of crops, one and one-half pounds of nitrogen are required for a bushel of corn, one for oats, and two for a bushel of wheat, and this must be obtained from organic matter through the agency of these bacteria. The greatest loss occurs when no crop is growing, and these soluble plant foods are lost by leaching, although some loss of nitrates is going on whenever drainage takes place.

(f) **By Use of Quicklime.** — A very serious objection to

burned limestone or quicklime is that it tends to destroy the organic matter of the soil, and most soils that need lime have too little organic matter to begin with. At the Pennsylvania Station the plots having burnt lime applied for 25 years showed less nitrogen by 375 pounds than the limestone plot. This difference is equal to 37.5 tons of barnyard manure per acre. At the Virginia Station it has been determined that the applications of quicklime have reduced the amount of nitrogen and organic matter when compared with plots treated the same except that quicklime was omitted.

(g) **By Fallowing.**—Fallowing is leaving the land without a crop for a season during which the soil is cultivated. This has been a very common agricultural practice in European countries, but more especially in England. The objects of the fallow were to destroy weeds, to develop an abundance of nitrates for the succeeding crop, to increase the moisture content of the soil, and to produce good tilth in heavy soils. While all of the objects were accomplished, yet in regions where heavy fall, winter, or spring rains occur much of the soluble plant food which was produced at the expense of organic matter was leached out of the soil and lost. King found that in the spring of 1900 land fallowed the previous season contained 245.7 pounds more of nitrates per acre than the cropped land. The following table from Hall shows the effect of leaching from fallowed land upon the wheat crop:

Yield of Wheat Grown When Percolation was Large and Small⁸

	Percolation through 60-inch gauge	Tile ran days	Bushels per acre		
			Wheat after wheat each year	Wheat after fallow	Gain due to fallow
15 years of percolation, below average	3.99	4	30.1	44.6	14.5
16 years of percolation, above average	8.92	13	27.1	29.3	2.2
Loss due to excess leaching	3.0	15.3

Fallowing should be practiced only where the rainfall is not sufficient to cause any loss by leaching, as in sub-humid and semi-arid regions.

Estimation of Organic Matter.—No very satisfactory method has been devised for determining the organic matter of soils, since it is impossible to determine it directly.

(a) **Loss on Ignition.**⁹—The ignition method is sometimes used, but at the best is only approximate for peats and sands which contain very little water of hydration. Five grams of water-free soil is heated to low redness in a crucible till all organic matter is burned away. Cool and moisten with a few drops of a saturated solution of ammonium carbonate. Dry and heat to 150° C. to expel excess of ammonia. The loss in weight is the organic matter, water of hydration, and volatile substances.

*Loss on Ignition Compared with Organic Matter*¹⁰

[Calculated from organic carbon]				
Kind of soil	Between 100° and ignition	Between 120° and ignition	Between 150° and ignition	Organic matter at 58 per cent carbon
	<i>per cent</i>	<i>per cent</i>	<i>per cent</i>	<i>per cent</i>
Old pasture.....	9.27	9.06	8.50	6.12
New pasture.....	7.07	6.88	6.55	4.16
Arable soil.....	5.95	5.70	5.61	2.44
Clay subsoil.....	5.82	5.39	4.76	0.65

The per cent of loss on ignition is seen to be much higher than that obtained from the actual amount of organic carbon determined, taking the organic matter as containing 58 per cent of carbon or multiplying the per cent of carbon by 1.724.

(b) **Combustion in Oxygen.**¹⁰—The combustion method has been used to some extent. The soil is placed in a porcelain or platinum boat and ignited in a combustion tube partly filled with cupric oxide. The tube is connected with a series of bulbs, those of sulphuric acid for absorbing nitrous fumes and water and a weighed potash bulb for absorbing the carbon dioxide formed during combustion. A current of air from which the carbon dioxide has been removed by passing through a potash bulb is drawn through the tube by means of an aspirator. The amount of carbon dioxide produced is then determined by weighing the bulb, and the organic matter found by multiplying the weight of carbon dioxide by 0.471.

(c) **The Chromic Acid Method.**¹¹—The apparatus consists of a train of flasks and bulbs arranged as shown in figure 79. A current of air is drawn through the apparatus by an aspirator at *I*. The carbon dioxide is removed from the air by a solution of potassium hydroxide in the flask *G*. The combustion takes place in flask *F*, into which about ten grams of soil are placed, together with five to

ten grams of pulverized potassium bichromate. *H* is a condenser. *A* contains a saturated solution of silver sulfate to absorb any hydrochloric acid, sulphur trioxide or dioxide that may be generated. *B* contains concentrated sulfuric acid, *C* potassium hydrate. *D* acid to be weighed with *C* in determining the weight of carbon dioxide. An acid guard bulb completes the train. The air is allowed to pass through the system for about ten minutes. The soil and potassium bichromate are thoroughly mixed in *F* and concentrated sulfuric acid (specific gravity 1.83) slowly admitted through the dropping funnel until the end of the tube from *G* is covered. If no vigorous action takes place the flask may then be slowly heated. The heating should continue from five to ten minutes. The bulbs *C* and *D* are then weighed and the amount of carbon dioxide de-

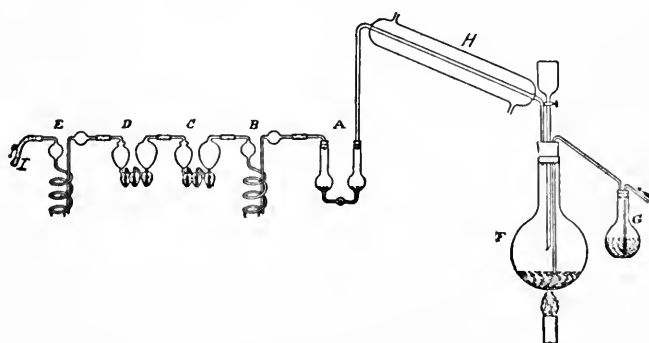

FIG. 79.—Arrangement of apparatus for determining organic matter by chromic acid method. (Bulletin 24, Bureau of Soils.)

termined. The organic matter is found by multiplying this by 0.171. This method does not seem to give complete combustion. A comparison with the dry combustion method shows that the amount of carbon found by oxidation with chromic acid is about 79.9 per cent of that found by the combustion method.

Carbon Found by the Two Methods in Soils Dried at 100° C.¹²

Kind of soil	Combustion method with oxygen	Chromic acid method
Old pasture.....	<i>per cent</i> 3.55	<i>per cent</i> 2.81
New pasture.....	2.41	1.93
Arable soil.....	1.42	1.18
Subsoil.....	0.38	0.28

Determination of Humus.¹³—Ten grams of soil are treated on a filter successively with a one per cent solution of hydrochloric acid until the lime is removed, as shown by testing a few cubic centimeters of the filtrate with ammonium oxalate after neutralizing with ammonia. Wash the soil with distilled water to remove the acid. The filter and soil are placed in a bottle or stoppered cylinder and a definite amount of a four per cent solution of ammonia is added. The amount added should vary from 150 to 500 cubic centimeters, depending upon the organic-matter content of the soil. Digest with frequent shaking for 12 hours and allow to stand for 12 hours. Filter the supernatant liquid and use an aliquot part of the whole for evaporation. Dry at 100° C., weigh, ignite and weigh again. The loss by ignition is the humus. Calculate the amount in the entire sample.

QUESTIONS

1. Define organic matter.
2. Distinguish between humus and organic matter.
3. What is the source of most of the organic matter?
4. Why are upland forest soils low in organic matter?
5. Where are chernozem soils found?
6. What kinds of organic matter in soils?
7. What is a "run-down" farm usually?
8. What amount of organic matter should soils contain?
9. What effect does moisture have on organic-matter content?
10. Are prairies increasing or decreasing in extent?
11. How many tons per acre of organic matter in timber soils to a depth of 6 $\frac{2}{3}$ inches?
12. In the subsurface?
13. Why are soils rich in limestone usually rich in organic matter?
14. Why do soils of northern latitudes have more organic matter?
15. Give the changes that organic matter undergoes in the soil.
16. Which elements increase and which decrease in proportion?
17. What is the origin of the coal-like materials in soils?
18. Compare the humus of arid and humid regions in nitrogen.
19. If the nitrogen content of a surface soil is 0.287 per cent, what per cent of organic matter does the soil contain?
20. How many tons per acre?
21. How is organic matter distributed in the soil strata?
22. How is the money value of organic matter to be determined? What factors are involved?
23. Of what value is granulation?
24. What effect does organic matter have on retention of water? How many tons of water per acre will an addition of 5 per cent of peat enable the surface to hold?
25. How does organic matter prevent puddling?
26. How does it aid in correcting it?
27. What effect does it have on temperature? How?
28. How does it affect biological activity?

29. How much nitrogen is required for a 75-bushel crop of corn? For a 60-bushel crop of oats? For a 40-bushel crop of wheat?
30. What are the evidences of nitrogen starvation?
31. Of what value is organic matter in binding soil particles together?
32. What part does erosion play in loss of organic matter?
33. What are yellow "clay points"?
34. What part does leaching play in loss of organic matter?
35. Give an example of loss by fire.
36. Is nitrification beneficial or detrimental to a soil?
37. What are the objections to quicklime?
38. What is meant by fallowing? Give the objects to be accomplished.
39. What effect does it have on organic matter?
40. What was the loss of organic matter due to forest fires?
41. Where may fallowing be practiced economically? Why?
42. What objection to ignition for determining organic matter of soils?
43. Describe the dry combustion method.
44. How may the carbon of soils be determined?
45. Describe the method for determining the humus.
46. If a soil contains 1.324 per cent of carbon, how many tons per acre of organic matter in the plowed soil?

REFERENCES

- ¹ Hilgard, E. W., *Soils*, 1906, p. 130, quoting Kosticheff.
- ² Schreiner, O., and Brown, B. E., *Bulletin 90, Bureau of Soils, 1912, Occurrence and Nature of Carbonized Material in Soils.*
- ³ Hilgard, E. W., *Soils*, 1906, pp. 136 and 137.
- ⁴ Snyder, Harry, *Soils and Fertilizers*, 1908, p. 105.
- ⁵ *Soil Reports, Illinois Station.*
- ⁶ Unpublished data Soil Physics Division, University of Illinois.
- ⁷ Snyder, Harry, *Soils and Fertilizers*, 1908, p. 111.
- ⁸ Hall, A. D., *The Soil*, 1903, p. 109.
- ⁹ Wiley, H. W., *Principles and Practice of Agricultural Analysis*, 1906, vol. i, p. 337.
- ¹⁰ *Op. Cit.*, p. 352.
- ¹¹ Briggs, L. J., Martin, F. O., and Pearce, J. R., *Bulletin 24, Bureau of Soils*, 1904, p. 34.
- ¹² Wiley, H. W., as above, p. 353.
- ¹³ *Bulletin 46, Bureau of Chemistry, U. S. D. A.*, p. 76.

General Reference.—Alway, F. J., and Bishop, E. S., *Jour. of Agr. Research*, vol. v, No. 20, 1916.

CHAPTER XII

MAINTAINING AND INCREASING THE ORGANIC-MATTER CONTENT OF SOILS

THE maintaining of the organic matter in soils is the most difficult problem on the average farm. It, with the nitrogen it contains, is the limiting factor on most of the farms of the southern and eastern states and is fast becoming of primary importance on corn and wheat belt farms of the middle west.

To maintain the organic matter requires something else than money. It is not to be had for any price, because there is no adequate supply. It must be grown on the farm and put back largely as residues which are of low value for any other purpose or as manure or both. To maintain this constituent requires very careful planning of rotations and the proper handling of the crops grown. A few farmers may buy organic matter as grain or hay from their neighbors, but this is a very short-sighted policy for the latter. The lack of active organic matter is the primary cause of soil exhaustion. Many farmers realize its value, but very few have made any definite plans for its permanent maintenance. To improve a worn-out farm is not an easy task. Since the organic matter for our soils must be grown on our farms, the first requirement is that the soil shall be in condition to grow it. Legumes, and more especially the clovers, are the best crops to grow for soil improvement. They require larger amounts of minerals in the soil, especially calcium and phosphorus, than almost any other crop. One or both must usually be supplied.

1. By Addition of Limestone.—Many soils are so acid or sour that the best soil-renovating crops, the clovers, will not grow successfully. Before these soils can be improved to any extent, unless an unlimited supply of manure is available, limestone must be applied. Many experiments have shown that the best form to use is ordinary ground or crushed limestone. This neutralizes the acid, prevents leaching of organic matter and furnishes the plant with the element calcium.

Limestone is rather readily soluble. In humid regions from 500 to 800 pounds are leached out of the soil each year. In many

soils it has been so completely removed that they are acid and the element calcium is too deficient to produce good crops, especially of legumes. Applications should be made once in every rotation. To maintain the limestone at present prices costs from fifty cents to one dollar per acre per annum plus the cost of applying it. This will make possible the growing of legumes for soil-renovating purposes. On eroded hill land large growths of sweet clover amounting to 2.7 tons per acre for the two years of its growth



FIG. 80.—Clover on gray silt loam on tight clay. (Marion silt loam.) Manure gave 0.6 ton of grass with practically no clover, while manure with rock phosphate and limestone gave 2.65 tons of good clean clover hay. (Illinois Station.)

were made possible by the application of four tons of limestone to acid soil.

2. By Applications of Phosphorus.—Phosphorus should be mentioned in this connection because so many soils are deficient in this element, and its application is very necessary for increasing the growth of legumes. It often more than doubles the growth of clovers and, of course, gives a larger amount of much-needed active material to be turned under. The acids formed in the decay of organic matter aid greatly in the liberation of phosphorus and potassium that are locked up in the minerals in the soil. The average increase of clover at the Illinois Station at Urbana on brown silt loam was 1.05 tons per acre where phosphorus was used, while on another field on the same type the increase was 1.51 tons.

At Fairfield, in southern Illinois, on gray silt loam on tight clay, Marion silt loam, the gain for phosphorus, limestone and manure over manure alone was 2.65 tons per acre of good clover hay. All know that the growing of large legume crops aid the production of large crops of grain (Fig. 80).

3. By Accumulations in Pastures.—The livestock farmer has one decided advantage over the grain farmer in that some of his land must be in pasture and accumulations of organic material are taking place during this period of "rest." A large amount of the organic matter that grows in the pasture will be eaten and destroyed by stock in the process of digestion, but the total result will be beneficial to the soil. From the table on page 162 it will be seen that only 580 pounds of organic matter are recovered in the manure for each ton of pasture grass eaten by stock. For red clover pasture, the amount is 680 pounds, while for alfalfa it is 660 pounds. Pasture grasses develop systems of roots which add quite largely to the organic supply in the soil. If legumes can be grown in connection with these pasture grasses much better results will be secured than from the grass alone. In the case of sweet clover growing with blue grass, it is found that the amount of blue grass will be larger than if grown alone. In pastures there is very little organic matter lost by oxidation, since this process is not very active in sod, there being no more nitrates formed than are used by the grass. In old compacted pastures, nitrification is not sufficiently rapid to maintain a good growth of grass. Farmers speak of such pastures as being "sod bound." Plowing and reseeding or at least a thorough disking may be necessary to completely aerate the soil and bring about larger growth.

Pasture grasses are frequently eaten so closely by stock that very little benefit is derived by the soil. Clover is often pastured so that at the end of the season there is nothing left on the ground to turn under for soil improvement.

4. Green Manures.—One of the very important ways of increasing the organic matter is by the use of green manures. Almost any crop may be used for this purpose, but legumes are much better because of the greater value of the material for soil improvement. The crop selected should depend upon the time of planting, the period available for growth, the character of the soil to be improved, and the system of farming practiced. The legumes best adapted to single summer growth are cowpeas, soybeans, common vetch, field peas, and velvet beans. Red, sweet and mammoth

clovers are biennials and can be seeded one year with a nurse crop and allowed to produce a growth the next spring before turning under. Hairy or winter vetch may be seeded with rye or winter oats for early spring pasture and plowed under for corn, cotton or other crops. It is a common practice in the corn belt to sow clover with wheat, oats or rye and turn it under in the fall or the following spring for corn. Sweet clover is excellent for this purpose in many localities. One to two tons of dry material have been turned under in time for the corn crop without apparent injury. There is danger, however, from plowing under a large amount of green material to be followed by a crop of corn, cotton, or potatoes. During the last few years some complete failures have resulted from this practice. The green crop takes out much of the available plant food and moisture and may leave the soil so deficient in these that the crop which follows may be seriously injured. Besides, the fermentation of the green material may develop heat that will drive off some moisture and leave the soil still drier, although the large amount of water turned under with the green crop would tend to compensate for any lost in this way.

5. **Catch and Cover Crops.**—Many times it is advantageous to use crops for some special purpose in which no attempt is made to grow them to maturity. Legumes, rye, oats or other crops are sometimes sown on land that is to lie idle for a time in order to use the available nitrates and prevent their loss by leaching. This plan is especially advisable on sandy soils, but it may be applied to other soils to good advantage. Wheat on sandy land could be immediately followed by cowpeas, which not only conserve the nitrates but add nitrogen to the soil. Wheat and oats on heavier soils, such as silt and clay loams, are usually followed soon after harvest by a crop of weeds and grass which act as very efficient catch crops. Wherever possible legumes should be grown after oats, wheat, or barley for this purpose because of their double value. Cowpeas, soybeans or clover are sometimes seeded in corn at the last cultivation to be used as a soil-improving catch crop. They may also be seeded in the hill of corn without serious detriment to the corn. Rape, cowhorn turnips, or rye may be used as catch crops. These may be pastured and thus acquire an additional value.

The same crops may be used as cover crops in orchards to hasten the maturity of wood or on hillsides to prevent washing.

6. **Barnyard Manures.**—Manure is one of the most valuable

by-products of the farm; however, sufficient manure cannot be produced from the crops grown on the farm to maintain the supply of organic matter. This is due to the fact that a large amount of the organic matter is destroyed during the process of digestion.

*Average Digestibility of Some Common Feeds*¹

Feeds	Dry matter digested	Dry matter recovered in manure	
	<i>per cent</i>	<i>per cent</i>	<i>pounds per ton</i>
Pasture grasses.....	71	29	580
Red clover, green.....	66	34	680
Alfalfa, green.....	67	33	660
Mixed meadow hay.....	61	39	780
Red clover hay.....	61	39	780
Alfalfa hay.....	60	40	800
Oat straw.....	48	52	1040
Wheat straw.....	43	57	1140
Corn stover.....	60	40	800
Shock corn.....	63	37	740
Corn-and-cob meal.....	79	21	420
Corn ensilage.....	64	36	720
Oats.....	70	30	600
Corn.....	91	9	180
Wheat bran.....	61	39	780

From the above table it is seen that in feeding hay about 40 per cent of the organic matter, or 800 pounds per ton of hay fed, is recovered in the manure, while with pasture grasses an average of 32 per cent, or 640 pounds per ton, is recovered. In the feeding of straw, shock corn or even ensilage, the animals leave a considerable amount, so that somewhat more organic matter is recovered than indicated by the figures.

The amount and composition of manure produced by different animals vary quite widely. The following table gives the amount:

Amount and Value of Manure, Solid and Liquid, Excreted by Various Farm Animals per 1000 Pounds of Live Weight

Animal	Pounds ² per day	Average ² tons per year	Per cent ³ solid	Per cent ³ liquid	Value ²
Horse.....	35-45	7.0	80	20	\$19.88
Cow.....	70-80	12.7	70	30	28.07
Steer.....	40-50	7.5	70	30	21.75
Swine.....	40-50	7.3	60	40	25.48
Sheep.....	30-40	5.5	67	33	32.06

In connection with this, attention is called to the next table, which gives the composition of the manure:

*Composition of Fresh Manure*⁴

Animal	Excrement	Water	Nitrogen	Phosphorus	Potassium
	<i>per cent</i>	<i>per cent</i>	<i>per cent</i>	<i>per cent</i>	<i>per cent</i>
Horse	Solid 80	75	.55	.13	.33
	Liquid 20	90	1.35	Trace	1.03
	Mixed ..	78	.70	.11	.45
Cow	Solid 70	85	.40	.09	.08
	Liquid 30	92	1.00	Trace	1.11
	Mixed ..	86	.60	.07	.37
Swine	Solid 60	80	.55	.22	.33
	Liquid 40	97	.40	.05	.37
	Mixed ..	87	.50	.15	.37
Sheep	Solid 67	60	.75	.22	.37
	Liquid 33	85	1.35	.02	1.74
	Mixed ..	68	.95	.15	.83

7. Loss of Manure and its Prevention.—A source of great loss occurs in the handling of manure after it is produced. In too many cases it is left in the lot or under the eaves of the barn or shed until the organic matter is decomposed and a large amount of the fertility is carried away. In the process of rotting there is a large amount of organic matter lost. To determine the amount of loss the Ontario Station placed four tons of mixed cow and horse manure in equal amounts in a protected shed and a like amount in an open bin exposed to the weather. The four tons contained 1938 pounds of organic matter. The losses are given in the next table.

*Loss of Organic Matter and Fertility in the Rotting of Manure*⁵

Fresh	At the end of three months		At the end of six months		At the end of nine months		At the end of twelve months			
	Pro- ected	Ex- posed	Pro- ected	Ex- posed	Pro- ected	Ex- posed	Pro- ected	Ex- posed		
	<i>pounds</i>		<i>pounds</i>		<i>pounds</i>		<i>pounds</i>			
Weight of manure	8000	8000	2980	3903	2308	4124	2224	4189	2158	3838
Weight of organic matter	1938	1938	880	791	803	652	760	648	770	607
	Loss in per cent									
Organic matter.....		55	60	58	65	60	67	60	69	
Nitrogen.....		17	29	19	30	23	40	23	40	
Phosphorus.....		None	3.5	None	5.2	None	5.7	1.7	7	
Potassium.....		None	16	2	21	2	24	2	25	

It is very important that the manure should be handled in such a way as to lose as little as possible. The best plan is to scatter it on the land as soon as practicable after it is produced. If the fertility is leached out then it goes into the soil, and if the manure becomes dry there is essentially no loss. The farm should be managed, if possible, so there would always be a place to haul manure. If this is not feasible under the system followed or if the fields become too wet to draw the manure upon them, the problem of preventing loss becomes an important one. It is well to remember that the greatest losses are due to fermentation and leaching.

(a) *Fermentation.*—The process of fermentation is largely responsible for loss of nitrogen and organic matter. It is practically impossible to prevent it entirely, but it should be reduced to a minimum. When manure, particularly from horses, is thrown into a pile it soon begins to heat. This indicates that bacterial action or fermentation is taking place. The organic matter of the manure is being decomposed and nitrogen in the form of ammonia is given off, resulting in large losses. In connection with this process, other organisms may work, causing "fire fanging," resulting in a light, powdery form of manure of little value. A process of fermentation takes place in cow manure or compact manures that results in rotting without so much loss. This is known as putrefaction and is due to anaërobic bacteria or those working without oxygen. The fermentation may be largely prevented by excluding the air, since oxygen is necessary for the process. This may be done in two ways, first by allowing stock to trample the manure, thus compacting it so much as to exclude the air, and, second, keeping the manure very wet.

(b) *Leaching.*—The greatest loss of manure is due to leaching, as it affects all constituents and elements alike. The colored liquid draining from the manure heap carries large amounts of valuable material away in the drainage waters. The Ohio Station found that manure from steers exposed for three months, January to April, decreased in plant food value per ton from \$3.01 to \$1.85, or there was a loss of \$1.16, or 38.6 per cent. The loss of organic matter was fully as great. Leaching may be prevented by keeping the manure in a shed to protect it from the rain. If exposed, it should be kept in a concrete pit or tank to prevent loss by leaching and very wet to prevent heating. Horse manure is the most difficult to keep because of its tendency to heat, owing to its looseness

and the free access of air. Where possible it should be mixed with cow manure to render it more compact.

If the animals are being fed in a shed or barn where the manure may be left till it is hauled out there will be less loss than in any other way. If a cement floor is used there will be no loss by leaching and the tramping of stock will exclude the air so that very little

FIG. 81.



FIG. 82.



FIG. 81.—How does this man handle manure? The stains answer the question.

FIG. 82.—When the spreader is filled the manure is hauled to the field. In this way there is very little loss.

fermentation will take place. Various experiment stations have demonstrated the higher value of manure and the lower loss when kept in this way. Compare figures 81 and 82.

(c) *Absorbents*.—Substances that act as absorbents of ammonia and other constituents that would be removed easily are sometimes mixed with the manure. Dry earth or dry peat may be used to

good advantage. Calcium sulfate, land plaster, may be dusted over the manure. The sulfuric acid unites with the ammonia, forming ammonium sulfate, which is comparatively slowly soluble. Common salt is sometimes used, but both it and land plaster are too expensive for general use.

Certain substances may be used as absorbents and also for reinforcing the manure. If the manure is to be used on land deficient in the element potassium, kainit may be used for this purpose and when the manure is scattered over the land will supply the needed element. Finely ground rock phosphate or floats may be used as an absorbent and at the same time supply the element phosphorus, in which most soils are deficient. At the Ohio Station the average annual increase for stall manure and floats over stall manure alone was 7.2 bushels of corn per acre, while the increase for yard manure treated over untreated was 6.4 bushels. The corresponding increases for wheat were 4.1 and 3.4 bushels per acre.

The next table shows the amount of loss from manure with absorbent reinforcement exposed for three months. The experiments were made at the Ohio Station.

Composition of Steer Manure After Exposure for Three Months—Pounds Per Ton⁶

Treatment		Organic matter	Ash	Nitrogen	Phosphorus	Potassium
Floats = Rock phosphate	Pounds at beginning	349.00	120.20	10.70	8.60	7.38
	Pounds at end	310.74	98.95	7.46	7.57	3.52
	Per cent of loss	10.96	17.67	30.28	11.97	52.30
Acid phosphate	Pounds at beginning	357.80	101.40	9.86	5.70	6.88
	Pounds at end	269.89	85.88	7.18	4.79	2.99
	Per cent of loss	24.57	15.30	27.18	15.96	56.54
Kainit	Pounds at beginning	369.00	107.40	9.76	2.88	10.70
	Pounds at end	291.50	83.64	6.68	2.48	4.98
	Per cent of loss	21.00	22.12	31.56	13.89	53.46
Gypsum	Pounds at beginning	375.40	104.60	9.68	2.76	7.86
	Pounds at end	267.35	75.72	7.94	2.66	2.56
	Per cent of loss	28.78	27.61	17.97	3.63	67.42
Untreated	Pounds at beginning	416.00	79.20	10.30	3.24	8.14
	Pounds at end	254.79	65.68	7.18	2.47	3.35
	Per cent of loss	38.75	17.07	30.29	23.76	58.84

The value of manure in a soil depends upon three things: first, the beneficial physical effect produced; second, the plant food supplied, and, third, the stimulus given to bacterial activity. Its

real value to the farmer can be determined only by the money returns secured from increased yields. This depends upon several factors: the soil itself, the crop grown, the price received for the crop, the rate of application and the cost of the manure.

As a general rule the better the soil the less need there is for manure and the smaller the returns per ton from its use. The poorer the soil the greater the need and the larger the returns. Farmers recognize this fact and usually apply manure to the poorer places on their farms.

All crops do not respond equally well to manure. Its value may be increased by applying to the right crop. Timothy, corn and wheat usually give good returns from applications of manure,



FIG. 83.—Manure spreader in action. The manure is torn apart so as to be scattered uniformly. (J. C. Beavers, Cir. 49 Purdue Station.)

yet corn may be a complete failure after manure. This is not usually the fault of the manure, but of the amount applied and subsequent management. Strawy manure plowed under late in the spring without disking is very likely to injure corn because of the effect on moisture movement.

The common impression is that heavy applications of manure are most profitable. The greatest profit per ton of manure is obtained from light applications when well distributed. This may best be accomplished with the manure spreader. At the Ohio Station at Wooster an average of twenty years shows a value of \$3.48 per ton where four tons of manure were applied, \$2.70 with 8 tons and \$2.24 with 16 tons per acre.

The following table gives data from Purdue Station and illustrates the value of different amounts:

Average Value of Increase for Manure Per Crop and Per Ton for Twenty-three Years, 1890-1912¹

Rotations	Average amount in tons per rotation		Value of increase	
	<i>heavy</i>	<i>light</i>	<i>heavy</i>	<i>light</i>
Corn.....	14.24	8.8	\$3.11	\$3.78
Oats.....	4.78	4.03
Wheat.....	5.83	4.52
Clover.....	4.91	3.90
Average per ton of manure.....	1.31	1.84
Corn.....	15.00	9.1	8.55	6.68
Oats.....	4.98	4.28
Wheat.....	7.33	5.53
Average per ton of manure.....	1.39	1.81
Corn.....	10.94	6.72	8.16	6.81
Wheat.....	11.45	9.33
Average per ton of manure.....	1.79	2.40
Corn continuously.....	6.61	3.81	6.79	6.38
Average per ton of manure.....	1.02	1.67
Wheat continuously.....	4.35	2.72	6.17	5.25
Average per ton of manure.....	1.42	1.93
Average per ton of manure for all experiments	1.39	1.93

(d) *Methods of Applying Manure.*—For an application of manure to be most effective it should be evenly distributed and then thoroughly mixed with the soil. It is very difficult to accomplish the first by hand spreading. There will almost certainly be large chunks of manure alternating with bare spots. The manure spreader (Fig. 83) is indispensable for this purpose. It tears the manure to pieces, scatters it evenly and permits of smaller applications. The same amount of manure covers a larger area and, as seen from the above table, gives it a higher value per ton. The mixing of the manure with the soil may be readily accomplished by the disk. This is not so important unless a crop is to follow soon, as in the case of spring plowing for corn or summer plowing for wheat. It is especially desirable for coarse manures which when plowed under interfere with capillary movement.

The manure should be applied as soon as possible after being produced, since there is less loss when in or on the soil than if left in the lot or even the shed (Fig. 82). Some farmers prefer well rotted manure, but there is too much loss in the process of decay to allow this to go on in any other place than in the soil. Weight for

weight, well rotted manure may be more valuable than fresh manure, but the loss of fertility and organic matter involved in the process more than overbalances the benefits. The character of the rotted manure will depend upon the conditions under which the decay took place. There is no question but that twenty tons of fresh manure applied to soil will produce greater increase than the same weight of manure would after it is well rotted. In many cases it is not practical to apply manure as rapidly as produced. Farmers of the corn belt haul out the manure in summer and early spring. That taken out in summer is usually placed on land to be fall plowed. This is without doubt a good practice. The manure becomes decayed sufficiently by spring so that it will not



FIG. 84.—An expensive and wasteful way of handling manure on the farm. Do not put it in piles. (Deere & Co.)

interfere with moisture movement. The fall and winter loss is avoided.

Coarse manure is best applied in the fall, but if the application is made in spring it should be very light. Heavy spring applications may ruin the crop, especially corn. In the dry summer of 1914 corn on some fields that had received heavy applications of manure before being plowed in the spring produced no grain whatever.

Manure is sometimes piled in the field in small heaps and later scattered with the fork. This is not only an expensive but a wasteful process. Much of the fertility is leached into the soil beneath the heaps and a large amount of manure is left at these spots in spreading (Fig. 84). The result is a great many very rich spots upon which small grain lodges badly and is frequently

lost. These spots are still visible in oats after 25 years on a farm in the vicinity of the University of Illinois.

8. **Organic Residues** of the farm are of two kinds, those that form no part of the crop, as weeds, and those that are part of the crop or harvested with the crop, such as corn stalks, straw and stubble. Heretofore it has been believed by many farmers that most crop residues have little or no value and the easiest way of disposing of them was the best; consequently much material was burned and the practice has by no means ceased. It is estimated



FIG. 85.—Burning corn stalks—in addition to the organic matter destroyed in burning the stalks some organic matter in the soil is burned.

that in the western part of the United States the straw from 20,000,000 to 30,000,000 acres of grain is burned every year, while in the corn belt the practice of burning stalks is still somewhat prevalent in certain sections (Fig. 85). This enormous waste of organic matter and nitrogen is to be regretted very much. Crop residues of all kinds have great value. Chemists tell us that straw has a manurial value of \$2 to \$3 per ton, over half of which is due to the plant food which it contains, while the rest is due to the physical effect upon the soil. Corn stalks contain 16 pounds of nitrogen per ton, and even after exposure during the winter the amount is re-

duced only about $1\frac{1}{2}$ pounds, so that the burning of corn stalks results in a loss of $14\frac{1}{2}$ pounds of nitrogen per ton, which at 15 cents a pound would amount to \$2.17. There is little doubt but that the value of the corn stalks for improving the tilth would be equal to one-half of the value of the nitrogen, so that for turning back into the soil the corn stalks are worth fully \$3 per ton. The value of residues is shown in the yields secured where they have been returned to the soil for a number of years.

One of the most valuable crop residues is that from legumes, which are frequently grown for the seed and the straw returned to the soil. It furnishes organic matter in its most active form, rich in nitrogen, and its rapid decomposition makes it one of the best amendments for soils in bad physical condition.

On the experiment field at Bloomington, Illinois, where crop residues had been turned under for five years, the yield of wheat for 1911 was increased 4.4 bushels over that where the crop residues had been removed, and in 1912 the yield of corn was increased 7.9 bushels and in 1913, 5.9 bushels. At the experiment field at Du Bois, Illinois, crop residues turned under gave an increase of \$19.28* for twelve crops, or \$1.61 per acre annually, while with phosphorus applied the increase for residues was \$40 for the twelve crops, or \$3.33 per acre.

The turning under of crop residues on the grain farm in the corn belt is very essential, since it is the only means the grain farmer has of maintaining the organic matter. If he makes use of residues and an occasional crop of clover he has even a better chance of maintaining the organic matter than the stock farmer who loses so much organic matter during the process of feeding. (See the table page 162.)

9. Growing Non-Tilled Crops.—Tillage increases oxidation of organic matter by bringing about favorable conditions of moisture and aëration. The compact condition of the soil where non-tilled crops are grown retards decomposition of organic matter, hence the benefit of such crops as wheat, oats, rye, barley and grasses.

10. Rotation of Crops.—Rotation permits the growing of tilled, non-tilled and soil-renovating crops. Farmers should plan their rotations with the thought of soil maintenance. This is fundamental. The length of the rotation and crops selected should be adapted to the soil and to the system of farming. On soils well

*The price of corn was figured at 35 cents per bushel, oats at 30 cents, wheat at 70 cents, cloverseed at \$6 and soybeans at \$1 per bushel.

supplied with organic matter the rotation should be quite different from that on soils deficient in this constituent. In the former case much of the residues might be sold from the farm, while in the latter much the larger part should be returned to the soil. One essential of a rotation for soil improvement is at least one legume crop during the cycle. Soils deficient in organic matter should have a more frequent recurrence of this crop, as the value of the rotation in improving the soil depends primarily on the use of it. The legume should be turned back into the soil whenever possible. If it is removed and nothing returned in its place very little or nothing is gained for permanent soil improvement and maintenance.



FIG. 86.—Adding organic matter to the soil in the form of sweet clover.

Clover and cowpeas are commonly grown. The best one to grow on the grain farm is that which provides the largest amount of material to turn under. Medium red clover is most common in the northern states, but alsike or sweet clover is better adapted to somewhat poorly drained soils. Mammoth or English and sweet clover probably furnish the largest amount of material to plow under, and both plants will furnish a fair crop of seed, upon which the farmer must depend for his immediate returns. It requires the very best conditions for red clover to produce three tons per acre for both crops, which is at least one ton above the average. Sweet clover is an excellent legume for soil improvement because of its large growth (Fig. 86) and deep rooting characteristics.

The following table gives the amount that has been produced during the two years' growth:

*Investigation of Sweet Clover (Melilotus alba)*⁸

Parts of plant	Depth (inches)	Dry matter per acre		Nitrogen per acre	
		Pounds	Per cent of total	Pounds	Per cent of total
Total tops.....		10367	81	197	86
Total surface roots.....	0 to 7	1809	14	22	10
Subsurface roots.....	7 to 20	601	5	9	4
Total roots.....	0 to 20	2410	19	31	14
Total tops and roots.....		12777	100	228	100

From the above table it will be seen that the sweet clover produced 6.4 tons of total dry matter. Of this 1.2 tons came from the roots. The total weight of sweet clover from a single year's growth in the dry season of 1914 on black clay loam was 4.4 tons per acre.

QUESTIONS

1. Would it be advisable to purchase manure for ordinary crops?
2. What is the first requirement in maintaining organic matter?
3. Why is it necessary to add limestone?
4. What is the cost of maintaining it?
5. What is the effect of phosphorus on growth of clovers?
6. What advantage does the livestock farmer have over the grain farmer?
7. How much organic matter is lost in the process of digestion of pasture grasses? Of alfalfa?
8. What is the remedy for "sod bound" pastures?
9. Why is pasturing often of little benefit to soils?
10. What points should be considered in selecting a crop for green manure?
11. Give danger to crop arising from green manure turned under in spring.
12. What are catch crops? For what used?
13. Explain under what conditions weeds may have some value.
14. What is the use of cover crops?
15. In pasturing red clover what per cent of the organic matter is lost?
16. What proportion of the corn fed is recovered in the manure?
17. If a farmer keeps 10 horses averaging 1400 pounds each, 5 cows of 800 pounds and 10 hogs of 100 pounds each, what is the value of the manure produced in a year?
18. What are the sources of loss of manure?
19. Give the experiment conducted by the Ontario Station.
20. Why is there no loss from dry manure?
21. What is "fire fanging"?
22. What is putrefaction?
23. How may fermentation be prevented?
24. What parts of manure are affected by fermentation?

25. What portions are affected by leaching?
26. What was determined in regard to loss from manure by the Ohio Station?
27. What is the best way to keep manure to prevent loss?
28. What are absorbents? Name some.
29. What are the uses of reënforcing materials?
30. Upon what does the value of manure depend?
31. How may its real value be determined? Upon what does this depend?
32. On what kind of soil should manure be applied?
33. What crops respond best to manure?
34. What amounts of manure are best to apply?
35. Give the results obtained by the Purdue Station.
36. What are the advantages to be gained by the use of the manure spreader?
37. What is the value of corn stalks and straw?
38. What increases have been obtained by the use of crop residues?
39. What is the advantage of growing non-tilled crops?
40. What is essential in a rotation for soil improvement?
41. How should the legume be managed?
42. Which legumes are best for soil improvement?
43. What was the total amount of organic matter produced by a single season's growth of sweet clover?

REFERENCES

- ¹ Hopkins, C. G., Soil Fertility and Permanent Agriculture, 1910, p. 201.
- ² Beavers, J. C., Circular 49, Purdue Station, Farm Manures, 1915, p. 3.
- ³ Van Slyke, L. L., Fertilizers and Soils, 1915, p. 291.
- ⁴ Op. Cit., p. 291.
- ⁵ Ontario Station.
- ⁶ Thorne, C. E., Farm Manures, 1914, p. 148.
- ⁷ Circular 49, Purdue Station, p. 14.
- ⁸ Hopkins, C. G., Soil Fertility and Permanent Agriculture, 1910, p. 220.

CHAPTER XIII

PHYSICAL PROPERTIES OF SOILS

1. **Real or Absolute Specific Gravity.**—The real specific gravity of soils varies with the kind and amount of minerals composing them and the amount of organic matter present. The specific gravity of some of the more important minerals in soils is given in the following table:

Specific Gravity of Soil-Forming Minerals

Quartz.....	2.65	Kaolinite.....	2.50
Albite.....	2.61	Amphibole.....	2.9 to 3.4
Orthoclase.....	2.56	Pyroxene.....	3.2 to 3.5
Oligoclase.....	2.60	Muscovite.....	2.7 to 3.0
Labradorite.....	2.68	Biotite.....	2.7 to 3.1
Anorthite.....	2.72	Calcite.....	2.70
Dolomite.....	2.85	Gypsum.....	2.33
Limonite.....	3.6 to 4.0	Hematite.....	4.5 to 5.3
Magnetite.....	5.0 to 5.1	Epidote.....	3.25 to 3.5
Zeolites.....	2.25		

Organic matter is the lightest soil constituent, its specific gravity being 1.2 to 1.3. The specific gravity of the surface soil of brown silt loam, the common prairie soil of the corn belt, is 2.62, of gray, yellow gray, or yellow silt loam 2.65, while of black clay loam it is 2.57.

2. **Apparent Specific Gravity.**—The real specific gravity is of very little importance in comparison with the apparent specific gravity, which is the ratio between the weight of a unit volume of water-free soil and the same volume of water. The expression, volume weight, is sometimes applied to this and represents the weight of a unit volume of soil. The apparent specific gravity is numerically smaller than the real specific gravity because, in the latter, the pore space is eliminated. The apparent specific gravity varies directly as the kind and amount of minerals and the compactness, and inversely as the amount of organic matter present and the porosity of the soil. It is obtained by dividing the weight of a certain volume of soil by the weight of the same volume of water, or, what amounts to the same thing, the weight of the soil in grams by the volume of the soil in cubic centimeters.

Under different systems of tillage of the same soil type, the apparent specific gravity is an approximate measure of the tilth of the soil when determined under field conditions. In order to do this take a tube with a cutting edge and force it into the soil to a certain depth marked on the tube, thus securing a definite volume of the soil. Dry, weigh, and compare with an equal volume of water, or, in other words, determine its apparent specific gravity. The soil having the lowest apparent specific gravity is in best tilth. As an illustration, the apparent specific gravity of brown silt loam from a heavily cropped field was 1.36, while that of a well treated field was 1.10, indicating that the latter was in much better tilth than the former. The apparent specific gravity of soils varies from 1.7, that of sand, to 0.5, that of peat.

3. Weight of the Soil.—The weight of any quantity of soil may be determined by multiplying the weight of an equal volume of water by the apparent specific gravity of the soil. A cubic foot of soil varies from 106 pounds to 31 pounds per cubic foot, the former being sand, the latter peat. Knowing the weight of an acre-inch of water to be 226,000 pounds, it is easy to obtain the weight of an acre-inch or any number of acre-inches of soil. (See the table page 120 for weight of soil strata.)

4. Color of Soils.—The color of soils is one of the most noticeable or striking characteristics and always appeals to practical farmers as one of the best means for indicating soil differences. Its importance in estimating the character of the soil must depend upon the material producing it. Color is due almost entirely to the presence of two substances, organic matter and iron in some form.

The color imparted by organic matter varies with the amount present, the stage of its humification, the moisture content of the soil, and the amount of limestone present. The color imparted varies from black through brown to gray. The least decomposed imparts a brownish color, while the organic matter that is thoroughly humified gives a very dark brown or black color to the soil.

The presence of limestone imparts a darker color to the organic matter and hence to the soil. It further aids by preventing the leaching out of the black humus by forming insoluble compounds with it. Soils fairly well drained but deficient in limestone are usually light in color. The acid of soils bleaches the organic matter so that its effect in coloring soils is not so striking as in those containing limestone. In areas of acid soils, the presence of lime-

stone outcrops are indicated by dark soils. Coffey¹ speaks of being able to trace an outcropping limestone stratum by the dark color of the soil, and the same thing has been observed in the southern part of Illinois in the acid soils of that region. In soils of arid regions limestone is frequently so abundant as to impart a light color.

Iron oxides give various colors to the soil, depending upon the degree of oxidation. Ferric oxide (Fe_2O_3) imparts a bright reddish color. Due to the presence of this oxide, many of the subsoils of the Piedmont Plateau are decidedly red in color. The hydrated ferric oxide ($2\text{Fe}_2\text{O}_3 \cdot 3\text{H}_2\text{O}$) imparts a dull yellowish color to the soil, but is sometimes mixed with the anhydrous ferric oxide, giving a reddish yellow or yellowish red color, depending upon which predominates. In some cases, deoxidation has occurred through the effect of organic acids, or some other agency, and the higher oxides of iron have been reduced to the lower form. This gives a bluish, grayish or drab color to the soil. This is especially true in acid soils, in poorly drained ones, and in subsoils beneath peat, peaty loam or muck. In the latter case the iron has been deoxidized so completely that the soil usually presents a uniformly light drab color. The most striking effect of deoxidation is seen in the acid soils where drainage is intercepted by an impervious clay stratum. The iron is so completely deoxidized that the subsurface stratum is frequently white.

Soil constituents themselves in some cases may impart color to the soil, as where an abundance of quartz sand is found, giving the soil a grayish or whitish cast. Sometimes mica is sufficiently abundant to produce a glittering appearance in the soil. In some parts of the Piedmont Plateau the mica formerly existed in granitic rocks in large crystals from one-half to one and one-half inches in diameter. When the rock decomposed, the mica remained as large flakes, giving the soil a glittering appearance. The color of soils may undergo some change, usually due to the loss of organic matter through cropping, but mostly because of erosion, producing yellowish brown or yellow color.

5. Odor of Soils.—As a general rule soils possess a distinct but feeble odor, due to a very small amount of an organic compound of the aromatic family and analogous to that of the camphorated bodies. A very minute quantity is present, there being only a few millionths² of a per cent.

6. **Number of Particles.**—From the work preceding, especially the tables giving the different grades of soil material, it will be seen that many soil particles are extremely small, and the number of these in a certain volume or weight of soil is very great. If the largest particles of clay, 0.001 millimeter in diameter, were spherical and could be arranged in columnar form in a cubical box one inch each way, it would contain 15,625,000,000,000 particles. The determination of the number of particles in a definite weight of soil can be made by dividing the weight of soil by the weight of a single average-sized particle, as given in the following formula:

$$N = \frac{\text{Weight of soil (grams)}}{\text{Weight of a single particle}}$$

Weight of one particle = $\frac{1}{6}\pi D^3 \times \text{Sp. gr.}$

N = the number of particles, D = the mean diameter of the soil particle in centimeters and $\frac{1}{6}\pi D^3$ = the volume of a sphere. The specific gravity taken is 2.65.

This, of course, assumes that the soil particles are spheres and are all reduced to the average diameter. The following table gives the number of soil particles per gram of soil:

Number of Particles and Internal Surface of Soil Separates

Bureau of soils groups				
Soil separates	Diameter, mm.	Number of particles in one gram	Surface area per gram, sq. cm.	Internal surface one pound sq. ft.
Fine gravel.....	2.000 -1.000	213	15.1	7.3
Coarse sand.....	1.000 -0.500	1,709	30.2	14.7
Medium sand.....	0.500 -0.250	13,668	60.4	29.5
Fine sand.....	0.250 -0.100	134,480	129.3	63.1
Very fine sand.....	0.100 -0.050	1,709,400	302.1	147.5
Silt.....	0.050 -0.005	34,722,000	824.8	402.7
Clay.....	0.005 -0.0001	46,296,296,000	9,090.2	4,439.4
Illinois experiment station groups				
Coarse sand.....	1.000 -0.320	2,506	34.3	16.7
Medium sand.....	0.320 -0.100	77,821	107.8	52.6
Fine sand.....	0.100 -0.032	2,506,265	343.0	167.5
Coarse silt.....	0.032 -0.010	77,821,000	1,078.2	526.6
Medium silt.....	0.010 -0.0032	2,506,265,000	3,429.8	1,675.0
Fine silt.....	0.0032 -0.0010	77,821,000,000	10,781.6	5,266.4
Clay.....	0.0010 -0.00001	5,596,597,275,000	44,834.8	21,896.1

8. **Shape of Particles.**—Particles of many shapes and sizes exist in all soils. The shape varies with the origin. Soils formed from volcanic ash or dust are most irregular in shape and those of wind origin are more nearly uniform. The former have many

elongated or lath-like particles, while those of wind origin are generally rounded. Figure 87 gives some of these differences, both as to shape and size. The closeness of packing varies with the shape of the soil grains. As a general rule, the more uniform the size and shape the closer the packing under normal conditions.

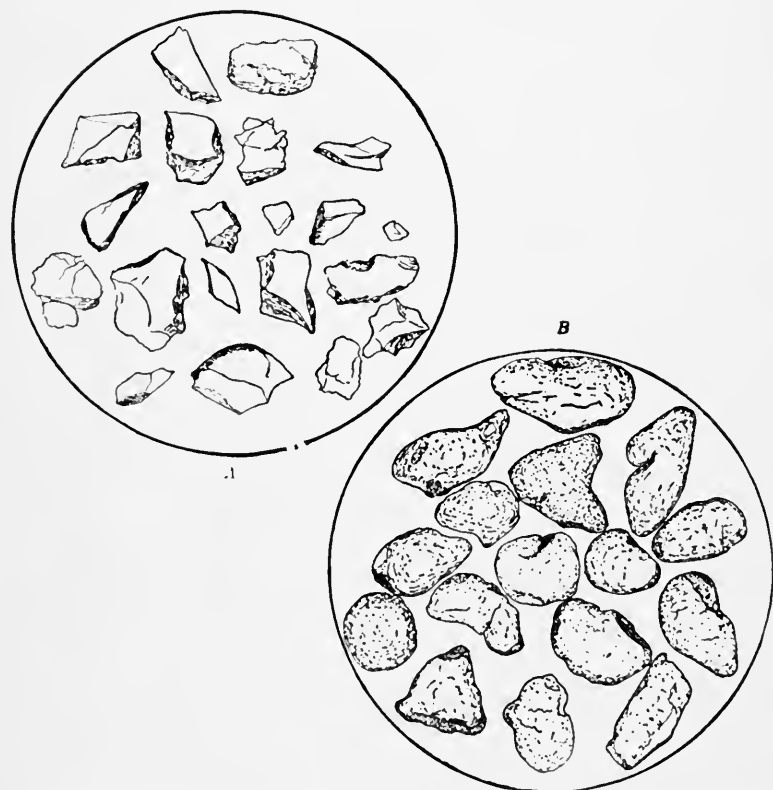

FIG. 87.—(After Merrill) A. Showing angular character of quartz particles in decomposed gneiss. B. Quartz granules from beach sand. C. Showing outlines of shreds of volcanic dust as seen under the microscope. Rocks, Rock-Weathering and Soils, Merrill (Courtesy Macmillan Co.)

9. Arrangement of Particles.—There is no definite arrangement of particles in soils. Coarse sands approach more nearly uniformity than any others. Theoretically, there are two general forms of packing or arrangement, the columnar, figure 88A, and oblique, figure 88B. If the soil particles were spheres and of uniform size, the columnar arrangement would give 47.64 per cent of air space,

while the oblique form would give 25.95 per cent. The air space with columnar arrangement may be calculated very easily by taking a one-inch cubical box and filling it with marbles of different sizes, varying from one inch to one-sixteenth inch in diameter, and con-



FIG. 87.

puting the per cent of air space left in the box. The same calculation may be made for the oblique arrangement, although it is much more difficult because of the mathematics involved.

If instead of having solid particles, as in figures 88A and B,

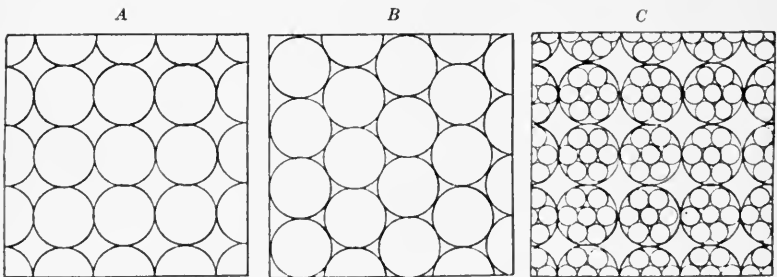

FIG. 88.—Diagram showing the arrangement of soil particles. A, columnar or vertical; B, oblique; C, compound granules.

each of these should be a compound granule (Fig. 88C) made up of many spherical particles with the same arrangement as the larger particles, the air space or porosity would be, for columnar arrangement, (17.64 per cent + 47.64 per cent of 52.36 per cent) = 72.58 per cent, or, for oblique arrangement (25.95 per cent + 25.95 per

cent of 74.05 per cent) = 45.17 per cent. The latter pore space, 45.17 per cent, is approximately that possessed by the medium and fine sandy loams; while the former, 72.58 per cent, is too high for soils unless under exceptional conditions. The coarse sands which approach to theoretical conditions most nearly show 33 to 35 per cent of pore space. The granular condition developed in a soil increases its pore space.

10. Internal Area or Surface.—The total surface of the soil particles in a given volume or weight is called the internal area or surface of the soil, and is usually expressed in square feet, or acres per cubic foot. This is very important because it controls to a large extent the amount of hygroscopic and capillary or film moisture. A system of grades of soil particles based on the internal surface would be of great value. Since the surfaces of spheres vary as the squares of their radii or diameters, the internal surface of a soil varies inversely as these functions. This may be shown by means of marbles as above and calculating the total surface with each diameter for columnar arrangement.

Area of Spheres in a One-inch Cubical Box with Columnar Arrangement

Diameter of spheres	Number of spheres in one cubic inch	Total surface, square inches
1 inch	1	3.1416
½ inch	8	6.2832
¼ inch	64	12.5664
1/8 inch	512	25.1128
1/16 inch	4,096	50.2256
1/1000 inch	1,000,000	3,141.16

The following table gives the internal area of various soils:

Computed Surfaces of Soil Particles in Different Kinds of Soil King³

Kind of soil	Effective diameter of soil grains	Pore space	Surface of soil grains in one cubic foot	Area per cubic foot
	<i>mm.</i>	<i>per cent</i>	<i>square feet</i>	<i>acres</i>
Finest clay soil.....	.004956	52.94	173,700	3.98
Fine clay soil.....	.007657	45.69	129,100	2.96
Fine clay soil.....	.008612	48.00	110,500	2.56
Heavy red clay soil....	.01111	44.15	91,960	2.11
Loamy clay soil.....	.02542	49.19	70,500	1.64
Clayey loam.....	.01810	47.10	53,490	1.23
Loam.....	.02197	44.15	46,510	1.06
Loam.....	.02619	34.49	45,760	1.05
Sandy loam.....	.03035	38.83	36,880	.84
Sandy soil.....	.07555	34.45	15,870	.36
Sandy soil.....	.1119	32.49	11,030	.25
Coarse sandy soil.....	.1432	34.91	8,318	.19

From the preceding table it will be seen that the total surface area of the particles of a cubic foot of very fine soil is about four acres, while a clayey loam contains an area of 1.23 acres per cubic foot and a coarse sandy soil about one-fifth of an acre. Careful calculations show that a silt loam contains from 65,000 to 75,000 square feet per cubic foot. Taking a soil with an internal surface of 70,000 square feet per cubic foot, the area of the particles in an acre to a depth of one foot would be about 109 square miles, or three townships. To a depth of four feet, from which plants take most of their moisture, the total area of the soil particles in the silt loams is not far from 436 square miles per acre, or twelve townships. The capillary water is distributed over this surface. If the roots of a corn plant did not pass beyond the middle of the rows, and no more than four feet deep, each hill would have approximately 51.3 acres of soil particle surface from which to draw its supply of moisture and food.

The following table shows the variations in the internal surface of some of the common soil types in the loessial areas of the middle west:

Internal Area of Soil Types, Calculated from Their Physical Composition ⁴

Soils	Internal area per cubic foot	
	<i>square feet</i>	<i>acres</i>
Dune sand.....	30,310	.696
Brown sandy loam.....	55,380	1.271
Yellow gray silt loam.....	69,780	1.602
Brown silt loam.....	70,900	1.628
Black clay loam.....	81,780	1.877
Drab clay.....	136,700	3.138

11. **Porosity of Soils.**—Porosity is the total amount of air space in soils and is usually expressed in per cent of volume. It depends upon the relation of solid particles to the interstitial space. This is modified to a large extent by the size and shape of the particles, granulation, tillage and amount of organic matter. Porosity or total pore space varies inversely as the size of the soil particles and increases with their irregularity of form. For this reason volcanic ash soils possess great porosity. Granulation and good tilth increase the porosity of soils, and puddling diminishes it. Tillage exerts a favorable influence on porosity, but sometimes increases it to an injurious extent. Porosity varies directly as the amount of organic matter. It is usually lessened by the rearrange-

ment of the soil particles upon wetting, especially in soils low in organic matter.

The porosity may be determined by dividing the difference between the real and the apparent specific gravity by the real, or by the following formula:

$$\text{Porosity} = \frac{\text{Real Sp. gr.} - \text{App. Sp. gr.}}{\text{Real Sp. gr.}}$$

The porosity of different grades of sand has been determined in this way and the results are given in the following table:

*Porosity of Different Grades of Sand*⁴

	Loose	Compact
	<i>per cent</i>	<i>per cent</i>
1. Passes a sieve 20 meshes to the inch; held by a 40-mesh	40.04	36.83
2. Passes 40-mesh; held by 60-mesh.....	42.07	37.69
3. Passes 60-mesh; held by 80-mesh.....	44.64	39.62
4. Passes 80-mesh; held by 100-mesh.....	45.92	41.39
5. Passes 100-mesh. It contains all of the fine particles.....	46.00	40.49

The porosity of the soil under field conditions is of much more importance than that of the laboratory sample, after having been finely ground. The laboratory determination gives comparative results, however, that are of some value. The porosity may best be obtained by taking the apparent specific gravity under field conditions, as given on page 175, and the real specific gravity of the soil and use these in the formula above. Soils in good tilth have high porosity. It is not unusual for the same type of soil from different fields to have a difference of 10 per cent or even more of pore space in favor of the soil of good tilth. The total pore space varies inversely, while the size of the individual pores varies directly as the size of the particles. The total pore space of coarse soils as sands is small but the pores are large. The sectional areas of individual pores vary as the squares of the diameter of the soil particles. In figure 88A there are 16 pores per square inch, while if the particles are one-half as large they number 64. The sectional area can be only one-fourth as large in the latter case as in the former. If coarse sand whose particles have a diameter of one-twenty-fifth of an inch is compared with clay whose particles are one twenty-five-thousandth of an inch it will be seen that for sand

with columnar arrangement there will be 625 pores per square inch and with clay 625,000,000. The former will be one million times as large as the latter. The large size of the pores permits certain physical processes, such as percolation and aëration, to take place so readily that they may be detrimental to the crop. On the other hand, fine-grained soils, as clays and clay loams, with their very minute pores, but large total pore space, may so retard percolation and aëration as to be equally detrimental to the crop. Medium-grained soils, as silt loams or fine sandy loams possessing an intermediate pore space, are best suited to most crops, although both the coarse and very fine soils have their advantages under certain conditions. The size of the pores in fine-grained soils is increased by granulation.

The following table shows the porosity of different types of soils:

Porosity in Soils of Varied Physical Composition ⁴

	Organic-matter content	Loose	Compact
	<i>per cent</i>	<i>per cent</i>	<i>per cent</i>
Sand.....	0.75	44.9	39.7
Brown sandy loam (medium sand).....	2.90	53.7	43.3
Yellow fine sandy loam (loess).....	0.80	59.0	49.9
White silt loam.....	0.79	59.7	50.2
Brown silt loam.....	4.88	60.4	50.4
Black clay loam.....	5.50	61.2	52.7
Drab clay.....	3.60	68.2	58.2
Peat.....	64.48	65.6	60.8

The total pore space of soils is rarely less than 30 per cent. Coarse, clean sand has about this amount. This means that a cubic foot of such soil will contain 70 per cent of solid material. In case of sandy loams and silt loams, the pore space amounts to about 50 per cent, or half of the volume of the soil, or, in a cubic foot, there are approximately 862 cubic inches of air space. The increase in porosity, within certain limits, is beneficial because of the increase in aëration. Extremely large air spaces in soils are detrimental because they permit of excessive evaporation.

QUESTIONS

1. What is specific gravity?
2. Give specific gravity of a few common soil-forming minerals.
3. What is the apparent specific gravity?
4. How is it determined?
5. How does porosity affect it? Tilth?
6. How is the weight of a cubic foot of soil determined?

7. If a soil has an apparent specific gravity of 1.4, what is the weight of the surface soil per acre?
8. Why is color of soils so important?
9. What color is imparted by organic matter?
10. What effect does limestone have on color?
11. What colors are due to iron?
12. Why are subsoils in swamps so frequently gray or drab?
13. The subsoil above the tight clay stratum is usually gray in color. Why is this?
14. What is peculiar of the subsoils of the Piedmont Plateau?
15. What soil constituents impart color?
16. Explain how soils may undergo change in color.
17. What can be said of the odor of soils?
18. If soil particles average 0.02 inch in diameter, how many could be placed in a one-inch cubical box with columnar arrangement? If 0.02 mm.?
19. How many particles in a gram of soil if the particles average 0.005 mm. in diameter?
20. Upon what does the shape of the particles depend?
21. What property does this affect?
22. Define internal surface of a soil.
23. How does the internal surface vary?
24. How do the areas of spheres vary?
25. If a cubic foot of soil has an internal surface of 50,000 square feet and it contains 20.8 pounds of moisture, how thick would the film of water be if uniformly distributed over the surface?
26. What is the internal surface in acres of an acre of coarse sandy soil 4 feet deep? (Table page 181.)
27. Of an acre of the clay soil as given in the table on page 182?
28. What two arrangements for soil particles?
29. If a two-inch cubical box is filled with shot one-sixteenth of an inch in diameter arranged in columnar form, how many will it hold?
30. What per cent of air space will remain?
31. How is the porosity modified?
32. What effect does wetting have on total pore space?
33. How is porosity of a soil determined?
34. How is the porosity of a soil under field conditions determined?
35. What relation between the total pore space and the size of the pores?
36. If soil particles are one-thousandth of an inch in diameter, spherical and arranged vertically in a one-inch cube, what will be the total sectional area of the pores? Of a single pore?
37. In the table on page 183 why is the porosity of the compact in 5 less than in 4?

REFERENCES

- ¹Coffey, G. N., Bull. 85, Bureau of Soils, p. 42.
- ²Wiley, H. W., The Principles and Practice of Agricultural Analyses, 1906, p. 94.
- ³King, F. H., Physics of Agriculture, Mrs. F. H. King, Madison, Wis., 1901, p. 124.
- ⁴Unpublished data Soil Physics Division, University of Illinois.

CHAPTER XIV

WATER OF SOILS

PLANT growth cannot take place without moisture. Plants consist of from 60 to over 90 per cent of water. This represents only a very small part of the water used, since many plants transpire in twenty-four hours an amount equal to their weight. Water is of primary importance in many physical and all chemical changes that take place in the soil.

Some Physical Characteristics of Water.—Water has certain physical characteristics that should be noted here. Its volume changes with temperature. Its maximum density is attained at 4 degrees C., 39.2 F., and expansion takes place either above or below this temperature, and at 15 degrees C., 59 F., the density as compared with water at 4 degrees C. is 0.99. At the freezing point the density of water is 0.99988, while the density of ice at the same temperature is 0.928. In the melting of ice a large amount of heat is used, but it does not raise the temperature. This heat becomes latent or is used in changing the condition of the water from a solid to a liquid. It requires more heat to melt (fuse) ice than to fuse metals. To melt one gram of ice requires 80 calories,* whereas metals require from 5 to 77 calories. Expressed in Fahrenheit-pounds, the English system, the figures are 144 for ice and from 9 to 138.6 heat units for metals.

In the evaporation of water a similar phenomenon is observed. When the boiling point is reached no further change in temperature of water occurs, but the heat is used in changing the water from a liquid to a gas. To effect this change in one gram 537 calories are necessary, or, with the Fahrenheit-pound, 966.6 heat units. It must be remembered that when water evaporates, an amount of heat equivalent to the above is used, regardless of the temperature. In changing from a higher to a lower temperature, or from gaseous to liquid form, or from liquid to solid, equivalent amounts of heat are liberated.

* A calorie, in general, is the amount of heat required to raise the temperature of a gram of water one degree centigrade. A heat unit or a British thermal unit is the heat required to raise one pound of water one degree Fahrenheit.

Specific Heat.—The amount of heat required to raise one unit mass of a substance one degree in temperature as compared to that of the same weight of water is the specific heat of a substance. The specific heat of water exceeds that of every other substance and is used as the standard or 1.0. Substances with low specific heat change temperature rapidly.

Viscosity.—The fluidity or viscosity of water varies with temperature and with substances in solution. If at 0 degrees C., the viscosity is 100; at 50 degrees C. it is 31.

Some substances when dissolved in water increase the viscosity, while others decrease it.

Uses of Water.—Green plants contain a very large percentage of water, as stated above. A constant stream is passing in through the roots and transpired by the leaves. From 300 to 500 pounds of water are required for every pound of dry matter of the plant. The soil then must contain a sufficient amount and must be of such character that it can deliver to the plant this enormous amount. If this is not supplied, the plant is stunted or may wilt and die before maturity. The uses of water in soils are as follows:

(1) Directly as a plant food, taking part in the building up of tissues, either as water or indirectly by being used in combination with other elements.

(2) As a solvent for various substances in the soil that may be used by plants. It was believed by Jethro Tull that plants fed directly upon the very fine soil particles, taking them in through the roots, and that this accounted for the better growth of crops in well pulverized soils.

(3) As a means by which these nutrient solutions are brought to and taken into the plant, either along with the water or by diffusion.

(4) As a regulator of certain physical phenomena.

(5) As an aid to chemical action produced directly or through the agency of bacteria.

The Amount of Water Required by Plants.—Experiments have been carried on in various parts of the world by different investigators to determine the amount of water used in producing a crop. More or less transpiration is going on constantly during growth, and an enormous amount of water passes out through the stomates of the leaves. The following table gives the amount of water required to produce a pound of dry matter, as determined by different investigators.

Water Transpired by Growing Plants for One Part of Dry Matter Produced

Lawes and Gilbert, ¹ England	Hellriegel,* Germany	Wollny,† Germany	King,‡ Wisconsin
Beans..... 214	Beans (horse) 262	Maize..... 233	Corn (maize) 271
Wheat..... 225	Wheat (spring) 359	Millet..... 416	Potatoes... 385
Peas..... 235	Peas..... 292	Peas..... 447	Peas..... 477
Red clover... 249	Red clover... 330	Rape..... 912	Red clover . 577
Barley..... 262	Barley..... 310	Barley..... 774	Barley..... 464
	Oats..... 402	Oats..... 665	Oats..... 504
	Buckwheat.. 371	Buckwheat.. 646	
	Lupine..... 373	Mustard ... 843	
	Rye (spring). 377	Sunflower ... 490	
Average.... 237	Average... 342	Average... 603	Average.. 446

* Hellriegel² used quartz sand in small amounts and supplied the necessary plant food in solution. Figures include some loss of water by evaporation, which was not prevented at first, but later reduced by means of covers.

† Wollny³ used small quantities of sand well supplied with organic matter. Perforated covers materially reduced evaporation; this, however, was checked up on soil growing no crop.

‡ King⁴ used about 400 pounds of normal soils, in cans, some set down in the earth. Some were run in the field, others in greenhouses. Water was added from beneath, so that evaporation was very slight.

We see from the above table that the water required to produce one pound of dry matter varies from 214 pounds in the case of beans, as determined by Lawes and Gilbert, of England, to 912 pounds for rape, as determined by Wollny, of Germany. The average of all determinations shown above is 428 pounds. King's determinations in Wisconsin probably apply better for the humid section of this country than any others that have been made. The number of trials made by King was as follows: Peas, 1; barley, 5; potatoes, 14; oats, 20; clover, 46, and corn (maize), 52. With the water requirements as determined by King, a 100-bushel crop of corn would require approximately 16 inches of water to produce it, or 18 tons per bushel of grain; a 100-bushel crop of oats, about 18 inches, or 20 tons per bushel; a 50-bushel crop of wheat, 12.7 inches, or 28.7 tons per bushel, and a four-ton crop of clover, 20 inches of water.

Briggs and Shantz have made determinations of water requirements of plants in the arid regions of the United States, and their results are given in the table, page 242.

Dependent Upon Transpiration. — The amount of water required by plants is dependent upon the amount of transpiration, which in turn depends upon several factors, as follows:

(1) High temperatures increase and low temperatures retard transpiration.

(2) Movement of the air increases transpiration from the plant,

while the movement of the plant itself aids the circulation of the water within the plant, and so increases transpiration.

(3) Low humidity is favorable to transpiration.

(4) The character of the soil is an important factor. More transpiration takes place from plants on poor soils than on those well supplied with plant food.

(5) Transpiration increases with the brightness of the sunshine.

(6) The more moisture there is in the soil the greater is the transpiration.

The Supply of Moisture in Soils.—1. **Rainfall.**—The supply of moisture in soils depends primarily on the rainfall. The exceptions are where artificial irrigation is practiced or where water is brought to a region through some porous substratum and then reaches the surface by hydrostatic pressure. The following table shows the annual precipitation for different portions of the earth's surface:

*Precipitation on Earth's Surface*⁵

Annual precipitation	Percentage of earth's land surface
Under 10 inches	25.0
From 10 to 20 inches	30.0
From 20 to 40 inches	20.0
From 40 to 60 inches	11.0
From 60 to 80 inches	9.0
From 80 to 120 inches	4.0
From 120 to 160 inches	0.5
Above 160 inches	0.5
	100.0

It is seen from the table that 55 per cent of the land area receives less than 20 inches of rainfall annually, while only 5 per cent receives over 80 inches. In the United States fully 50 per cent of the total area receives less than 20 inches of rainfall, and over a very large part of this the growing of crops is practically impossible except under irrigation. (See Rainfall Map, Fig. 89.) In almost all regions where crops depend upon rainfall, its unequal distribution, or the frequent recurrence of periods of drouth, results in reduced yields.

In almost every season in some parts of even so small an area as a single State crops are injured to a greater or less extent by drouth. In some cases the dry weather occurs early in the spring.

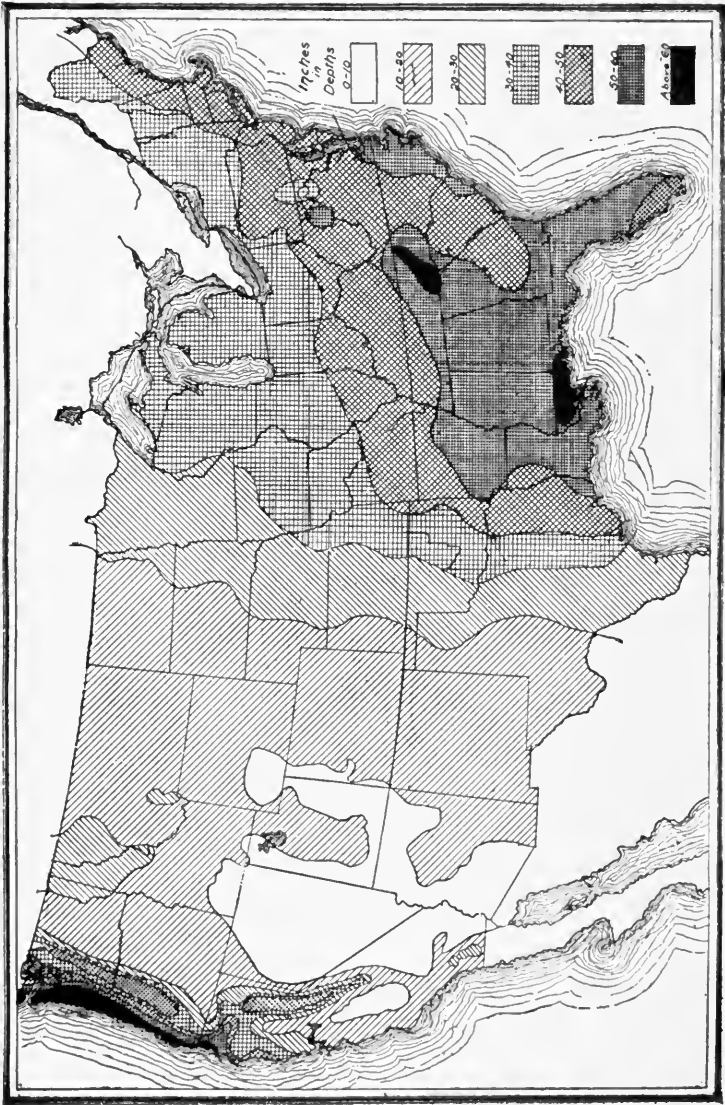

Fig. 89.—The annual rainfall over the United States. Dry Farming, Wiltsoe. (Courtesy Macmillan Company.)

in April or May, but it occurs more often in July or August, at the time when the growing crops are in greatest need of moisture. At the University of Illinois " the distribution of rainfall is so irregular that in the past twenty-five years seven Aprils have been dry or have had less than two inches of rainfall, and during this same time four Mays, eight Junes, five Julys, six Augusts, and eleven Septembers have been dry, or a total of 41 out of 150 growing months for the 25 years. In the southern third of the State the distribution is still more irregular, and drouth is more injurious there, because of the greater evaporation and the character of the soil. This illustrates quite well the conditions generally in the humid area.

2. **Soil.**—The supply of moisture for the crop depends upon the character of the soil itself. An open porous soil, such as a coarse sandy loam or sand, will lose a great deal of moisture by percolation, and hence will not have a large supply for crops. Frequent rains are necessary for such a soil. However, the "firing" of the crop on sandy soil is not always an indication of lack of moisture. On finer grained soils, however, the moisture is retained much better and an abundant supply is usually present for the growing crop. The retentive power of the soil is increased very materially by the presence of organic matter. Probably no one constituent plays a greater part in maintaining the supply of moisture in the soil than that of organic matter.

3. **Loss by Evaporation.**—In a soil deficient in organic matter, consisting of medium-sized soil particles, the movement of moisture to the surface and its evaporation may reduce the supply sufficiently to injure the crop. This factor is of especial importance in semi-arid and arid sections. (See Chapter 18.) Mulches, good filth, and a fair supply of organic matter reduce evaporation to a large extent.

Ways of Expressing Moisture Content.—The moisture content of soils has been expressed in a number of different ways, some of which have been discontinued because of their impracticability. Some of the methods are as follows: (a) per cent based on weight of soil; (b) in cubic inches or per cent of volume, and (c) in acre inches.

(a) **Per Cent of Weight of Soil.**—In expressing the moisture content in per cent various methods have been used. A few investigators have based it on the weight of the wet soil as taken from the field. This is not satisfactory, because the base varies from day to day as the moisture content changes. In some cases the per cent

has been based on the air-dry soil, and while this is somewhat better than the former, yet it is subject to the same objection, since the air-dry soil varies with the temperature and humidity of the air. Without doubt the most satisfactory base for expressing the per cent is the weight of water-free soil obtained by drying in an oven at 100 to 110 degrees C. Hilgard has used the temperature of 200, others 140 degrees C., for obtaining the water-free soil, but in general practice a temperature of 100 degrees C. is easier to maintain and just as satisfactory. Probably none of these is the exact point at which all of the hygroscopic moisture is driven off. The thing desired is a uniform standard.

(b) **Cubic Inches or Per Cent of Volume.**—Expressing the water content in cubic inches or per cent of volume may have its advantage in case of certain soils, such as peats, or mucks, which are very light, or sands which are heavy. A peat soil with 50 per cent of moisture may contain no more than a silt loam with 20 per cent. A cubic foot of peat, water-free, weighs about 30 pounds, and 50 per cent of moisture would mean 15 pounds per cubic foot, while the silt loam, weighing 75 pounds per cubic foot with 20 per cent, would have the same amount. Expressed in per cent of volume, the amount would be 24 in each case. To determine the per cent of volume necessitates the finding of the per cent of moisture based on the water-free soil.

(c) **Acre-inches.**—It is often desirable to express the water content of soils for convenient comparison with the rainfall. This may be done in square-foot-inches or in acre-inches, the depth of water in inches over a square foot or an acre. To do this it is necessary to determine the weight of water in the soil per square foot to the depth desired. The weight of water in a cubic foot in pounds divided by 5.2, the weight of a square-foot-inch of water, will give the depth in inches.

QUESTIONS

1. What amount of water is required by plants?
2. Give the effects of temperature changes on water.
3. What is latent heat?
4. Give comparison of metals and water as to the amount of heat required to change the condition or state.
5. Give differences between the *calorie* and English *heat unit*.
6. Define specific heat.
7. How does water compare with other substances?
8. What factors modify viscosity?
9. Give uses of water in soils.
10. How much water is required for a pound of dry matter?

11. How much for a 50-bushel corn crop? A 60-bushel oat crop?
12. Upon what does the amount of water used by plants depend?
13. How much of the earth's land surface is adapted to ordinary humid agriculture?
14. What part of the United States is humid? (See Rainfall Map, Fig. 86.)
15. How does the rainfall vary during different months?
16. How does soil affect the moisture supply?
17. What part does evaporation play in the storage of water?
18. What are the advantages and disadvantages of expressing moisture content in per cent of weight of soil?
19. What is the best base to use? Why?
20. Give advantages of expressing moisture content in cubic inches or per cent of volume.
21. Why is it well to express the moisture content in acre-inches?

REFERENCES

- ¹Lawes and Gilbert, Jour. Hort. Soc., 1850.
- ²Hellriegel, Experiment Station Record, IV, p. 532.
- ³Wollny, Experiment Station Record, IV, p. 532.
- ⁴King, F. H., Physics of Agriculture, 1907, p. 139, also 11th and 14th Annual Reports Wisconsin Station.
- ⁵Widtsoe, J. A., Dry Farming, 1911, p. 33.
- ⁶Mosier, J. G., Bulletin 208, Illinois Experiment Station, Climate of Illinois, 1917.

CHAPTER XV.

WATER OF SOILS

I. HYGROSCOPIC MOISTURE

WATER is held in soils by the manifestation of attractive force under three forms: (1) hygroscopic, or adhesion; (2) surface tension, and (3) hydrostatic, or gravity. These give rise to the three so-called forms of water—hygroscopic, capillary, or film, and gravitational. It must be remembered that the water of all is the same in chemical composition, the only difference being in the force holding or moving it in the soil.

Hygroscopic Moisture.—All substances have the power of condensing moisture upon their surfaces, hence a very thin film of water exists around all substances exposed to the air. This phenomenon is known as adsorption. The water is held very firmly by adhesion or molecular force, which is estimated as equal to 10,000 atmospheres, and the water may be removed only by a temperature much higher than the ordinary. When normal temperature is restored, the moisture will again be slowly condensed upon the surface. Briggs¹ has calculated the thickness of the hygroscopic film for quartz particles as 2.66×10^{-6} centimeters, or 0.0000266 millimeter. The amount of hygroscopic moisture in a soil depends upon several factors.

*Hygroscopic Capacity of Soils*²

Soil	Amount of clay	Minimum moisture	Maximum moisture	Average
	<i>per cent</i>	<i>per cent</i>	<i>per cent</i>	<i>per cent</i>
Sandy soils.....	Less than 5	0.79	4.18	2.59
Sandy loams.....	5 to 10	1.84	6.12	3.39
Loams.....	10 to 15	2.30	9.18	5.19
Clay loams.....	15 to 20	5.06	10.26	6.49
Clays.....	Over 20	4.20	18.60	10.83

(a) **Size of Particles.**—The amount of hygroscopic moisture in soils varies inversely as the size of the particles and directly as the internal surface of the soil. Since colloids are made up of very minute particles, a small amount present will increase very materially the internal surface and consequently the total amount of

this form of moisture. Sandy soils with a relatively small surface area contain only small amounts of hygroscopic water.

The preceding table shows the amount of hygroscopic moisture as determined by Hilgard. The soils were exposed in saturated atmosphere at 15 degrees C. and dried at 200 degrees C.

This shows the effect of texture and consequently the internal surface upon the amount of hygroscopic moisture. In another case the hygroscopic capacity was determined for the whole soil and then for the separates as follows:

	Per cent
Whole soil	5.24
Clay	17.60
Hydraulic Value less than 0.25 mm. per second....	7.96
Hydraulic Value 0.25 mm.....	2.91
Hydraulic Value 0.50 mm.....	1.73

(b) **Colloids.**—The colloids have a very high adsorptive power for water, and their presence in soils increases very strikingly the hygroscopicity. Nearly all soils, and more particularly the heavy ones, contain considerable amounts of colloids. They may occur as humus, ferric oxide, silicic acid, or hydrous aluminum silicates. Hydrated ferric oxide and some other minerals may unite with water chemically, but the common hygroscopic phenomenon is one of adsorption. This table shows the effect of colloids on the hygroscopic moisture.

*Influence of Silt, Sand, Clay, Ferric Hydrate and Humus on Hygroscopic Capacity*³

	Mississippi pine hills sandy loam	Washington dust soil	Mississippi white pipe clay	Mississippi flat-woods clay soil	Mississippi ferruginous clay soil	Oahu ferruginous laterite	Mississippi marsh muck	Mississippi marsh soil
Hygroscopic moisture	2.48	4.92	9.09	9.33	18.60	19.66	21.00	15.40
Clay.....	2.94	1.27	74.65	25.48	28.15	?	Tr.	Tr.
Ferric hydrate.....	1.6415	12.10	51.00
Humus.....	.55	.44	0.00	.50	little	3.33	66.10	19.83
Finest silts (0.01-0.0250 mm.).....	60.10	45.04	23.15	68.60	40.33	45.66	33.94	8.70
Sands, fine and medium (0.0250-0.50 mm.).....	31.20	42.40	.20	4.70	15.61		70.18

It will be seen from the above table that clay, ferric hydrate and humus have the greatest effect upon hygroscopic capacity.

(c) **Temperature.**—The temperature affects the amount of hygroscopic moisture, since under temperatures higher than normal

a part of the hygroscopic moisture is driven off. Condensation will again take place when the temperature becomes lower. If, however, the air is saturated with moisture an increase in temperature increases the amount of moisture adsorbed.

Hilgard has found that a fine sandy soil that adsorbed two per cent of moisture from a saturated atmosphere at 15 degrees C. adsorbed four per cent when the temperature was raised to 34 degrees C. A heavier soil which adsorbed seven per cent in a saturated atmosphere at 15 degrees C. adsorbed nine per cent at 34 degrees C.

(d) **Organic Matter** has a high adsorptive power for water, especially in the form of colloidal humus. All soils contain this in small amounts, at least, while some have several per cent, which gives them a high hygroscopic capacity.

(e) **Humidity**.—The changes in humidity of the air cause a variation of hygroscopic moisture at the same temperature. If a soil adsorbs one unit of moisture in a saturated atmosphere at a certain temperature, it will adsorb three-fourths⁴ of a unit when the air is three-fourths saturated, and one-half unit at one-half saturation, but at one-fourth saturation will adsorb slightly more than this proportion.

Dobeneck has shown the effect of various relative humidities on the hygroscopic content of quartz and humus after an exposure of 24 hours at 20 degrees C.

*Percentage of Hygroscopic Moisture (Dobeneck)*⁵

Relative humidity per cent.	30	50	70	90	100
Quartz.....	0.045	0.053	0.76	0.119	0.175
Humus.....	4.055	7.765	10.589	15.676	18.014

The Determination of the Hygroscopic Coefficient of Soils.

—The hygroscopic coefficient of a soil is the amount of moisture it will adsorb when exposed to a saturated atmosphere for a definite time at a constant temperature.

The determination of the hygroscopic capacity or hygroscopic coefficient of soils is of considerable importance, since it gives a constant for the soil that depends upon the internal surface, thus giving a means of comparison. One of the best methods for its determination is that of Briggs, which is to place the soil in a saturated atmosphere at 75 degrees F., approximately 24 degrees C., and let it remain until no further increase in weight is shown. It is

then dried at 100 degrees C. The difference gives the hygroscopic coefficient of the soil. Hilgard has used a temperature of 200 degrees C. in the determination of hygroscopic capacity, which comes nearer, probably, reaching the point of absolute dryness of soil. In this determination the soil should be spread out in a very thin layer, so that as large a surface as possible may be exposed directly to the saturated air.

The hygroscopic coefficient of soils may be determined indirectly by using other constants to which the hygroscopic coefficient bears a definite relation. The formulae are as follows:

(a) Hygroscopic coefficient = wilting coefficient \times 0.68.

(b) Hygroscopic coefficient = moisture equivalent \times 0.37.

(c) Hygroscopic coefficient = (moisture holding capacity — 21) \times 0.234.

(d) Hygroscopic coefficient = 0.007 sands + 0.082 silt + 0.39 (clay + organic matter).

For wilting coefficient see page 212; moisture equivalent, page 202, and moisture holding capacity, page 209.

The Use of Hygroscopic Moisture.—It was formerly believed that plants were able to use some hygroscopic moisture, but later investigations seem to show that this is not possible. Permanent wilting has been taken as the point at which plants cease to obtain sufficient water from the soil, and at this point they still contain some capillary moisture, although the film is quite thin.

Determinations of the moisture content of soils at wilting have been made by Briggs and Shantz, and are given in the following table:

Relation of Hygroscopic Coefficient ⁷ to the Wilting Coefficient

	Hygroscopic coefficient	Wilting coefficient	Amount of capillary water remaining
	<i>per cent</i>	<i>per cent</i>	<i>per cent</i>
Coarse sand	0.5	0.9	0.4
Fine sand	1.5	2.6	1.1
Sandy loam	3.5	4.8	1.3
Fine sandy loam	6.5	9.7	3.2
Loam	7.8	10.3	2.5
Clay loam	11.4	16.3	4.9

In the work of Briggs and Shantz the determination of the wilting coefficient of soils always shows the presence of some capillary water. Even at the death point of plants soils show more than the hygroscopic water present.

Hilgard⁸ gives the following uses of hygroscopic moisture in plant growth: “(1) Soils of high hygroscopic power can withdraw from moist air enough moisture to be of material help in sustaining the life of vegetation in rainless summers or in time of drouth. It cannot, however, maintain normal growth save in the case of some desert plants. (2) High moisture absorption prevents the rapid and undue heating of the surface soil to the danger point, and thus often saves crops that are lost in soils of low hygroscopic power.”

QUESTIONS

1. What forces act upon water in soils?
2. What forms of moisture are found in soils as a result of these forces?
3. Define hygroscopic moisture.
4. How does size of particles affect the amount of hygroscopic moisture?
5. What effect do colloids have?
6. What effect does temperature have on hygroscopic moisture in comparatively dry air?
7. What effect if the air is saturated?
8. What effect does organic matter have on hygroscopic moisture?
9. What relation exists between the adsorption of soils from different degrees of saturation?
10. How do the ratios of humidity and adsorption compare in the table on page 196?
11. Define hygroscopic coefficient.
12. How is it determined?
13. Can plants use hygroscopic moisture?
14. Which soil in the table on page 197 has the highest hygroscopic coefficient? Why?
15. Which contains the highest amount of capillary moisture after the wilting coefficient is reached?
16. If a clay loam soil weighs 80 pounds per cubic foot, how many tons of unavailable moisture is in the soil to a depth of two feet per acre? (See table on page 197.)
17. What is the use of hygroscopic moisture?
18. The wilting coefficient of a clay loam is 16.2 per cent, what is the hygroscopic coefficient?
19. If the moisture holding capacity of a soil is 23.2 per cent, what is the hygroscopic coefficient?
20. If a soil contains 83.1 per cent of sand, 8.6 of silt and 7.5 of clay, what is the hygroscopic coefficient?

REFERENCES

- ¹ Briggs, L. J., *Journal of Physical Chemistry*, Vol. 9, 1905, pp. 617-641.
- ² Hilgard, E. W., Report of the California Station, 1892-3-4, p. 70.
- ³ Hilgard, *Soils*, 1906, p. 196.
- ⁴ *Op. Cit.*, p. 198.
- ⁵ Dobeneck, A. F., *Von Untersuchungen über das Absorptionsvermögen und die Hygroskopizität der Bodenkonstituenten*. Forsch. a. d. Gebiete d. Agri-Physik., Band XV, 1892, Seite 163-228.
- ⁶ Briggs, L. J., and Shantz, H. L., Bulletin 230, Bureau of Plant Industry, U. S. D. A., *The Wilting Coefficient for Different Plants and its Indirect Determination*, 1912, p. 73.
- ⁷ *Op. Cit.*, p. 65.
- ⁸ Hilgard, *Soils*, 1906, p. 200.

CHAPTER XVI

WATER OF SOILS

II. CAPILLARY WATER

THE most abundant and by far the most important form of soil moisture is capillary or film moisture. It differs from hygroscopic moisture in that it evaporates at ordinary temperatures, is not condensed again on the soil particles, and may move from one particle to another.

The term capillary as applied to this form of water has arisen from the fact that this movement may be best seen in very small capillary tubes. When tubes are placed in water the height to which it will rise varies with the diameter of the tube.

Height of Capillary Rise in Glass Tubes

Diameter of tubes	Height of water
1.0 mm.	15.336 mm.
.1 mm.	153.36 mm.
.01 mm.	1533.6 mm.

The law expressing this action is as follows: The height to which the water rises varies inversely as the diameter of the tube. The reduction of the diameter one-tenth causes the water to rise ten times as high. The movement of water in soils from a free water surface resembles somewhat the movement of water in a large number of capillary tubes of various sizes. In the case of soils where the water rises from a free water surface the amount in the soil varies inversely as the distance above the free water. This would be exactly true of a large number of various-sized capillary tubes. The explanation for soils is not quite as simple, however, as this would indicate.

Surface Tension.—Whenever an air-water surface exists the molecules of water in the interior are attracted equally in all directions. The molecules on the surface are subjected to a double but unequal attraction of the water on one side and the air on the other, which has the effect of producing a thin film composed of the surface molecules which is under tension. If the film is flat no pres-

sure is exerted in any direction. If curved the tension will cause a pressure in the direction of the center of curvature and in proportion to the radius of curvature. The pressure is equal to two times the tension divided by the radius. The greater the curvature the less will be the radius and consequently the greater the pressure.

If soil particles are in contact the water will be in two forms: (1) as a film around the particles, and (2) as a waist between the particles as shown in figure 90. The pressure is always in the direction of the center of curvature and varies inversely as the radius. The pressure of the film around the soil particle is inward, while that of the waist is outward. The force will then be the difference between these two. As a general rule the waist film exerts the greater force because it has the greater curvature or the lesser radius. The pressure due to difference of curvature is well shown by two soap bubbles a and d that have a free air passage between them as in figure 91. The curvature of the smaller, d , should give

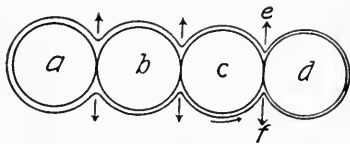

FIG. 90.—Soil particles showing films and waists of capillary water.

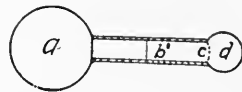

FIG. 91.—Large and small bubble connected by a tube b . The greater curvature of d forces the air into a until the curvature of c is the same as a .

it greater pressure. That this is true is shown by the fact that the air is forced from it into the larger bubble, a , till the film, c , across the end of the tube, has a curvature the same as that of the large bubble.

If soil particles are in contact so that the water films coalesce, the films will adjust themselves so as to be in equilibrium. If, however, water is removed from one of the particles, as at d , the equilibrium will be destroyed, a pull will be set up toward d , and water will move from other particles until equilibrium is restored. In figure 90 the film around d is thinner than at a , and this may make a slight difference in the curvature of the films, but more particularly of the waists, the curvature being much greater between c and d than between a and b . The greater outward force at e and f would draw water from the other films.

If water is added at a the equilibrium will be destroyed and readjustment will take place. The smaller the amount of water present in the soil the greater will be the curvature of the films

Moisture in Soil Columns.—A number of particles are arranged vertically as in figure 92. The film around (1) is held by the attraction of that particle alone. The film around (2) is held by the attraction of the particle, plus the outward pull of the waist at *a*. The water film of (3) is held by its own force, plus those of *a* and *b*. No. (4) is held by its force, plus *a*, *b*, and *c*. The film of the lower soil particle must be held by the greatest force, and as a result this particle would have the thickest film. If the lower end of the soil column contains free water the films may be so thickened by the combined force of the film above that nearly all pore spaces may be filled with water. The pore spaces of the soil column in contact with the free water may act as tubes.

Effect of Size of Soil Particles.—It will be seen from this, then, that the movement of capillary water is due to the difference in curvature of the film, and the greater the curvature the greater will be the capillary pull or pressure. The smaller the amount of water present in the soil, the greater will be the curvature of the film between the soil particles. As a general rule, the larger the number of soil particles the greater the number of films present, and consequently the greater pull will be exerted per unit of volume of the soil. Hence the water in capillary tubes represented by a single film at the top of the water column will not rise as high as in the soil, where the number of films is many times greater than in the tube.

The height to which the water will rise depends upon the difference between the combined force of the films and the force of gravity represented by the weight of the water. In coarse-grained soils, where the total film surface is small, this force representing the upward pull will soon be overcome by the force of gravity or weight of water, and hence water will not rise very high. In finer-grained soils where the total surface of the films is very large it will require the weight of a very high column of water to balance this force, hence in fine-grained soils water will rise much higher than in coarse soils.

In two soils, one fine-grained and the other coarse, having the films of the same thickness and the same curvature, there will be no tendency for water to move from one to the other when brought in

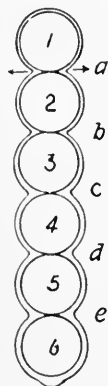

FIG. 92.—Showing theoretically the thickness of films in a vertical soil column.

contact, although the finer-grained soil may have many times the moisture content of the other. On the other hand, a clay soil may extract water from a sand soil when in close contact, even if the clay contains several times the amount of water that the sand soil does. The difference will be due to the fact that in the case of the smaller soil particles in the finer-grained soil the water film will have a greater curvature, and hence will be able to pull water from the sand soil, where the films have less curvature.

Moisture Equivalent.²—Briggs and McLane designed a centrifugal machine by which moist soils could be subjected to a force of 1000 times that of gravity or more. The soils under this condition would lose moisture until the capillary force was in equilibrium with this force of 1000 times gravity, when no further loss would take place. At this point all soils have films of the same thickness, and if the soils are put in close contact there is no tendency for water to move from one soil to the other. The capillary forces are in equilibrium. The per cent of water present at this point is known as the *moisture equivalent* of the soil. It is always higher than the wilting coefficient and lower than the optimum water content. While not representing any critical moisture content, yet it furnishes a very convenient constant for comparison of different soils. The numerical value of the moisture equivalent depends upon the internal surface of the soil. The following table gives the average for some classes of soils:

*Moisture Equivalents of Some Soil Classes*²

	Maximum	Minimum	Average
Sands.....	7.3	3.0	4.9
Fine sands.....	10.0	3.8	5.6
Sandy loams.....	18.6	5.3	10.4
Fine sandy loams.....	21.4	6.8	13.0
Loams.....	20.8	7.7	16.5
Silt loams.....	26.9	8.3	17.1
Clay loams.....	32.4	15.1	21.9
Clays.....	38.4	19.1	32.0

Since the moisture equivalent bears a rather definite ratio to other soil constants these may be used in its indirect determination.

Determination of Moisture Equivalents from Other Soil Constants.—When the other soil constants, as wilting coefficient, hygroscopic coefficient, moisture holding capacity, or mechanical analysis, are known, the moisture equivalents may be determined indirectly by the following formulæ:

- (c) Moisture equivalent = (Moisture holding capacity—21) \times .635
 (b) Moisture equivalent = Hygroscopic coefficient \times 2.71
 (a) Moisture equivalent = Wilting coefficient \times 1.84
 (d) Moisture equivalent = 0.02 sand + 0.22 silt + 1.05 clay.

Movement.—The movement of capillary water may take place in any direction, but with slightly greater facility downward than upward or sidewise, because of the aid of gravity. The rate and height of movement depend upon several factors.

1. **The Thickness of the Film.**—One of the most important factors in capillary movement is the thickness of the film of water on the soil particle. As a general rule, the greater the difference between the moisture content of adjacent soil masses, or the greater the difference in the thickness of films, the stronger will be the pull and the more rapid will be the movement. This is very well shown in soils adjacent to free or gravitational water. The distribution near the free water takes place rapidly through capillary passages, while at some distance the movement is by means of thin films and slow surface distribution. If this movement is upward, it is retarded by gravity, but if downward, as after a rain, the movement becomes somewhat rapid, especially if the films are quite thick.

To determine how rapidly or slowly water moves from a moist soil into a dry one, bury a dry clod two or three inches in diameter, in soil with medium moisture content, and examine every three or four days. The movement is very slow. Two or three weeks will be required for the clod to become moistened. It is without doubt true that the roots of plants go after the moisture rather than wait for the moisture to move to them by capillarity. This fact controls to a large extent the root development of plants. It must be remembered that very little capillary water used by plants is drawn from the water table of the soil, which is usually many feet beneath the surface. Plants sometimes wilt when the free water is not more than three or four feet beneath the surface, which means that the moisture rising by capillarity is not sufficient for the use of the plant. The fact that moisture moves so slowly through a dry soil is what makes dust mulches so effective.

In order to show the rate of movement of water through the soil, after the dry summer of 1889, King, of Wisconsin, collected samples of soil to a depth of five feet, and a portion of the dry area was effectually protected from rain and snow and left in this condition until April the following year. Samples were then collected

from the covered and from the exposed soil and the moisture content determined. The results are given in the table.

*Water Per cent of Dry Soil, Covered and Uncovered, at Different Dates (King),*³

	Original soil	Soil covered	Soil uncovered
	Oct. 28, 1889	April 14, 1890	April 14, 1890
	<i>per cent</i>	<i>per cent</i>	<i>per cent</i>
1st foot, sandy clay	4.03	3.32	20.23
2nd foot, red clay	10.07	6.68	20.01
3rd foot, clay and sand	9.11	6.32	8.32
4th foot, sand and gravel	4.35	3.71	8.63
5th foot, sand and gravel	4.53	5.08	6.07
Mean.....	6.42	5.02	12.65

In the protected soil there was not only no gain by capillarity from the sides or from below, but an actual loss occurred.

2. **Viscosity.**—Viscosity is the resistance that liquids offer to the movement of molecules against each other. This property is well seen in syrups, but we do not ordinarily think of water as possessing any large amount of viscosity or showing any variation in this respect under different conditions. A somewhat higher viscosity increases the surface tension of the film, but at the same time retards the rate of movement by lessening the fluidity and freedom of movement.

(a) *Temperature.* — Variations in the temperature of water change its viscosity, a higher temperature diminishing and a lower increasing it. Increasing viscosity increases surface tension. It has been determined that if the viscosity of water at zero C. is taken as 100, then the viscosity at 25 degrees is 50, at 30 degrees 45, and at 50 degrees 31.⁴ This variation influences the capillary movement of moisture in soils to some extent.

The next table shows that capillary movement is more rapid at higher temperatures, indicating that the greater fluidity produced

Effect of Temperature on Rise of Capillary Moisture,⁶ University of Illinois.—Height in Inches in 24 Hours

Temperature, degrees Fahrenheit	Brown silt loam	White silt loam	Yellow fine sandy loam
32.5	11.9	11.9	19.7
60.5	13.3	14.0	22.9
70.5	13.5	14.5	25.8

is of greater importance than an increased tension, at least within the limits of the experiment. While an increase in viscosity gives greater surface tension, the rate of movement is decreased because of greater resistance. Under higher temperatures the capillary limit would be reached sooner, yet the height attained would be less than at lower temperatures.

Somewhat dry soils frequently become moist in late autumn without rain. This is probably due to two things—less evaporation due to lowering of temperature and increased capillary pull at the surface due to greater surface tension of the water at this temperature.

(b) *Substances in Solution.*—The viscosity and likewise the surface tension of water are affected more or less by substances in solution. Some increase, while others decrease tension. The height to which liquids rise in soils varies with the surface tension, the densities of the liquids being the same. The rapidity of rise of those liquids in the same soil depends upon the viscosity: the more viscid the liquid the slower the movement. Mineral substances added to a soil generally increase the surface tension. If potassium chloride is added to the surface of a soil the capillary pull of the surface moisture will be increased, and more water will be brought up from the subsoil. This is true of most mineral fertilizers.

Organic substances lower the surface tension so that they would not cause so great capillary pull, but would increase the rapidity of movement. Soil solutions have a low surface tension.

Rains wetting a few inches in depth have a tendency to draw water up from the deeper soil, as observed by King.⁵ He found that 3.5 pounds per square foot in one trial and 3.69 in another had been transferred from the lower soil 24 to 48 inches to the upper in 26 hours after wetting. This is due in part to the fact that the surface tension of rain water is greater than that of soil solutions.

From the next table it will be seen that common salt gives the greatest tension and that soil solutions are low. If any of the chemical substances mentioned in the table should be applied to the surface of the soil when it passed into solution, the tension would be increased sufficiently to draw up water from below. Some recent experiments by Karraker⁸ indicate that substances in solution play little part in moisture movement. The strengths of the solutions in the table are much greater than probably ever occur in soils, unless it should be in the immediate surface just after an

*Surface Tension and the Density of Certain Solutions*⁷

Solution	Density	Surface tension, dynes per sq. cm.
Water.....	1.0000	73.9
Common salt (NaCl).....	1.1000	77.6
Muriate potash (KCl).....	1.1000	77.5
Ammonium sulfate ((NH ₄) ₂ SO ₄).....	1.1000	76.8
Sodium sulfate (Na ₂ SO ₄).....	1.1000	75.8
Sodium nitrate (NaNO ₃).....	1.1000	75.8
Potassium hydrate (KOH).....	1.1000	75.1
Potassium sulfate (K ₂ SO ₄).....	1.0830	75.1
Wood ashes.....	1.0038	75.2
Thomas slag.....	1.0012	77.4
Marl.....	1.0013	77.0
Lime.....	1.0020	75.5
Ammonia (NH ₄ OH).....	0.9600	67.5
Urine.....	1.0260	64.9
Stable manure.....	1.0013	73.2
Kentucky blue-grass soil.....	1.0000	71.0
Wheat soil.....	1.0000	69.6
Garden soil.....	1.0000	69.4

application of some mineral fertilizer or in alkali soils. In either of these cases some effect would undoubtedly be produced.

3. **Texture.** — The smaller the soil particles the slower the capillary movement, but theoretically the higher the water will rise. This is true only in theory. The resistance to movement becomes so great in very fine-grained soils that the water will not rise as high as in medium-grained ones. Loughridge found that in an adobe soil with 44.3 per cent of clay, a height of 46 inches was reached in 195 days, while in a fine sandy soil the water attained a height of 47 inches in 125 days. In a sand soil the water reached its limit in six days. The movement of water in clay soils is very slow, not only due to the extreme fineness of the ordinary clay particles, but to the presence of colloids which doubtless hinder the movement.

In experiments with two soils water rose by capillarity 8.5 feet in 90 days in loess (yellow fine sandy loam), while in white silt loam soil with 0.8 per cent of organic matter it rose 9.5 feet in about the same time. The loess contained practically no organic matter.

4. **Organic Matter.**—The presence of organic matter retards capillary movement, due to the colloids present and the greater porosity produced. The next table shows the movement of water in soils by capillarity from a free water surface. The tubes were one and one-half inches in diameter and five feet long.

CAPILLARY WATER

*Rapidity and Height of Rise of Water by Capillarity in Different Soils—Inches **

Time	1	2	3	4	5	6	7	8	9	10	11	12
	Sand soil	Sand soil 90 per cent, peat 10 per cent	Clay loam	Clay 90 per cent, peat 10 per cent	Loess, Yellow fine sandy loam	Loess 90 per cent, peat 10 per cent	White silt loam	White silt loam (90 per cent, peat 10 per cent)	Brown silt loam heavily cropped	Brown silt loam virgin soil*	Peat	Brown silt loam
1 hour.....	7.5	3.9	2.5	2.2	11.2	8.6	4.0	3.2	4.0	4.0	2.6	4.5
3 hours.....	8.5	8.2	3.7	3.2	19.0	13.7	6.2	5.6	6.5	6.0	3.2	6.2
6 hours.....	8.6	8.9	5.2	4.2	25.0	18.5	9.2	7.7	8.9	8.0	3.9	8.7
9 hours.....	8.7	9.5	6.2	5.0	29.0	21.9	11.0	9.5	10.4	9.4	4.2	9.7
12 hours.....	8.8	9.7	6.7	5.5	32.0	24.7	12.2	11.0	11.7	10.2	4.5	10.7
1 day.....	9.2	11.0	9.0	7.5	39.5	32.0	16.7	15.2	16.5	13.5	5.5	13.9
2 days.....	9.5	11.0	11.5	9.2	45.5	39.0	22.5	20.2	19.6	16.2	5.7	17.5
3 days.....	9.7	11.1	13.2	10.2	49.0	42.7	26.5	23.2	22.0	17.7	5.7	19.5
4 days.....	9.8	11.2	14.2	11.0	51.0	45.4	29.5	25.5	24.0	17.9	5.7	21.2
6 days.....	10.2	11.7	16.2	12.2	52.7	49.0	34.5	29.2	26.7	20.1	5.7	24.0
8 days.....	10.7	12.0	17.4	12.9	55.5	51.0	38.4	31.7	28.6	20.9	6.0	26.0
10 days.....	10.7	12.2	18.5	13.4	55.6	52.5	41.6	34.0	30.0	21.6	6.1	27.6
12 days.....	10.7	12.5	19.7	13.9	56.2	53.5	44.4	36.0	31.2	22.4	6.1	29.0
14 days.....	10.7	12.7	20.2	14.4	58.2	54.2	45.7	37.5	32.2	23.0	6.1	30.2

* The virgin soil was collected only a few feet from the heavily cropped one.

By comparing columns 1 and 2, 3 and 4, 5 and 6, 7 and 8, 9 and 10, and then all with 11 in the table, the effect of organic matter may be seen.

In the coarse-grained soils the organic matter which consisted of finely ground well-decomposed peat gives a greater range of

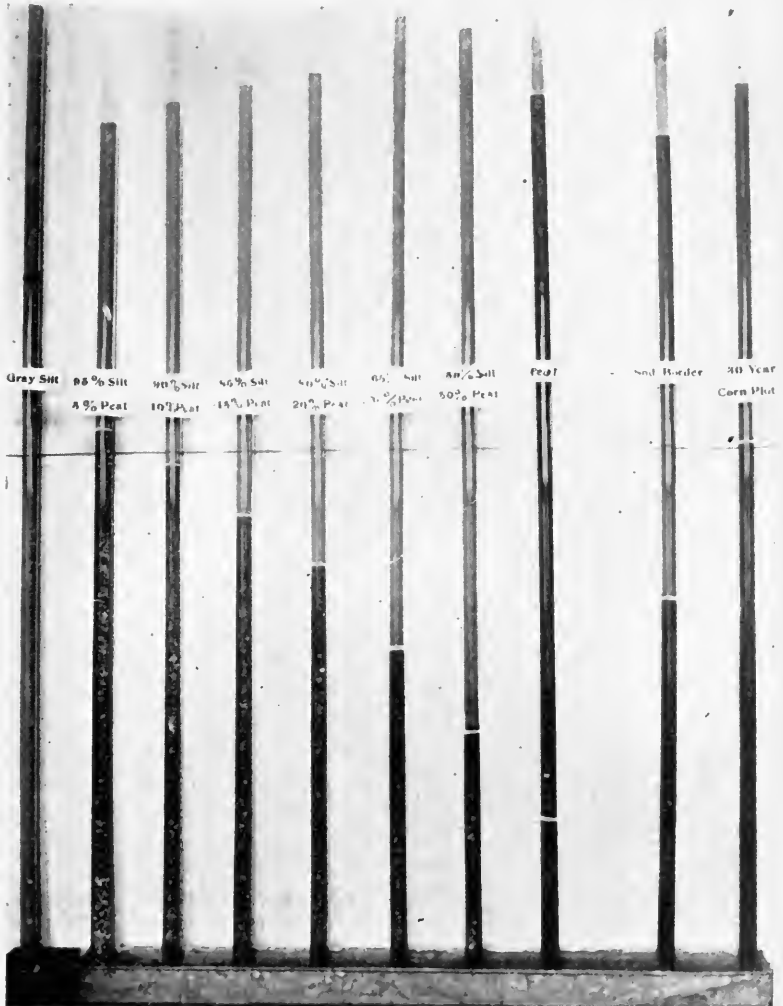

FIG. 93.—Showing the effect of various amounts of organic matter on the rise of capillary water from a free-water surface for a 14-day period.

movement. It reduces the rapidity at first, but the water in the mixture, as shown in column No. 2, passes No. 1 in six hours. In the finer-grained soil the effect of organic matter is to not only retard the movement from the first, but to diminish the height, as shown, by comparing Nos. 3 and 4, 5 and 6, and 7 and 8. A comparison of Nos. 9 and 10 shows the effect of the removal of organic matter by cropping. Slow capillary movement is desirable in surface soils to prevent excessive loss of moisture by evaporation. The subsurface and subsoil are better adapted for more rapid capillary movement which brings the moisture up where roots in the surface soil may obtain their supply. The peat is an excellent example of very slow movement through a very porous soil. The limit was reached in ten days. Figure 93 shows the effect of organic matter on height of rise of water.

Maximum Capillary Capacity or Moisture-holding Capacity of Soils.—Soils possess varying powers of retaining moisture by capillarity due primarily to texture. The method of determining this has been devised by Hilgard and modified by Briggs. A small cup five centimeters in diameter and one in height, with the bottom made of very fine bolting cloth, is used. The soil is settled slightly by jarring and stroked off level with the top of the cup. It is then placed with the bottom in the water, and when the soil has taken up the maximum amount of water, it is allowed to drain for a few minutes, and the weight of the water determined by comparing with the weights of the dry soil. This weight is designated as the water-holding capacity of the soil. This is much higher than will be found under field conditions. The following table shows the percentage of water held by capillarity and the total water at saturation in some soils, all from Illinois except the last.

Maximum Capillary and Maximum Water Capacity ⁹

	Held by capillarity	Total water	Excess of total over capillarity
	<i>per cent</i>	<i>per cent</i>	<i>per cent</i>
Sand.....	27.80	29.23	1.43
Yellow-gray silt loam.....	45.42	48.88	3.46
Yellow silt loam.....	48.31	52.10	3.79
Brown silt loam.....	60.04	64.56	4.52
Black clay loam.....	66.66	69.32	2.66
Palouse volcanic ash soil.....	60.00	64.49	4.49

Amount of Water Moved by Capillarity.—The many experiments made indicate the movement of large amounts of water by surface tension. King used a fine sand taken from the subsoil and a clay loam in cylinders four feet high, each with a section equivalent to one square foot. The soils were completely saturated and the cylinders were placed so that the water level was one foot below the surface. A strong current of air was passed over the surface for eight days and the evaporation determined. The same thing was done with the water level at two, three, and four feet below the surface.

*Water Evaporated Daily Per Square Foot with the Water Level at Different Distances Below the Surface*¹⁰

Kind of soil	One foot	Two feet	Three feet	Four feet
	<i>pounds</i>	<i>pounds</i>	<i>pounds</i>	<i>pounds</i>
Fine sand.....	2.37	2.07	1.23	0.91
Clay loam.....	2.05	1.62	1.00	0.90

These results show that the amount of water raised four feet was equivalent to one inch of rain in five and one-half days. From such experiments the impression is given that capillarity is the great factor in bringing water to the crop. It does play a large part, but the conditions in the above experiment were much more favorable than are ordinarily found in the field. The water rose from a free-water surface and the artificial breeze increased evaporation enormously. Capillary movement is extremely slow through clay loam, and it is very likely that the water evaporated from that soil when the water table was 36 or 48 inches below the surface was not obtained from the water table, but from the reserve in the soil. It takes more than eight days, as seen in the table, page 207, for water to be carried 48 inches or even 36 inches in height. The results are without doubt much higher than would be obtained under normal field conditions. In regard to capillary movement, Rotmistrov,¹¹ of Russia, says, "As regards the mechanical raising of water, however, by capillary action, it may be assumed that the limit from which water can make its way upward lies much higher than the limit accessible to roots. All the data at my command regarding moisture in the soil of the Odessa experimental field point only to one conclusion, namely, that water percolating beyond a depth of 40 to 50 centimeters (16 to 20 inches) does not return to the surface except by way of roots."

The evaporation from the lysimeters or drain gages at Rothamsted, England, from bare soil at depths of 20 inches and 60 inches, shows an excess of 0.11 of an inch per annum for the deeper soil mass as an average for 34 years. This represents the water brought to the surface from the 40 inches of subsoil of the deeper gage, and amounts to only 12 tons per acre per annum, or not sufficient to grow more than one-half bushel of wheat. This indicates that a very small amount of water is brought from a depth greater than 20 inches by capillarity in a clay loam soil.

Rainfall and Evaporation at Rothamsted, England,¹² Average for 34 Years, 1871 to 1904

	Rainfall, inches	Evaporation (or retained by soil)		
		20 inches	40 inches	60 inches
January	2.32	0.50	0.27	0.36
February	1.97	0.55	0.40	0.49
March	1.83	0.96	0.81	0.88
April	1.89	1.39	1.32	1.36
May	2.11	1.62	1.56	1.61
June	2.36	1.73	1.71	1.74
July	2.73	2.04	2.03	2.08
August	2.67	2.05	2.05	2.09
September	2.52	1.64	1.69	1.76
October	3.20	1.35	1.36	1.52
November	2.86	0.75	0.68	0.82
December	2.52	0.50	0.37	0.48
Total per year	28.98	15.08	14.25	15.19

Results for maximum and minimum rainfall

Maximum (1903)	38.69	15.21	15.09	14.46
Minimum (1898)	20.49	13.17	12.59	12.80

The Capillary Pull of Soils.—It is quite important to be able to measure this capillary force for different soils. A method for doing this has been devised by Lynde and Dupré. It consists of placing the soil in a funnel on a cotton cloth filter that is connected with a water column by means of a wick. The water column rests upon a column of mercury, the lower end of which is in a vessel of mercury. As the water evaporates from the surface of the soil the water in the tube rises and with it the mercury. The height of the mercury represents the pull. The capillary lift is quite large

in fine-grained soils, as shown in the next table, and would be sufficient to sustain a column of water of the height given in the third column.

*The Capillary Lift of Soil Constituents*¹³

Soil constituent	Diameter of grains	Height of H ₂ O
	<i>mm.</i>	<i>feet</i>
Medium sand.....	.5 - .25	.98
Fine sand.....	.25 - .1	1.78
Very fine sand.....	.1 - .05	4.05
Silt.....	.05 - .005	9.99
Clay.....	.005	26.80

Osmosis in Soils.—Lynde and Dupré¹⁴ have demonstrated that soils containing fine particles act as semi-permeable membranes, probably producing only a fractional part of the pressure of a membrane. Movement of this kind takes place when a difference in concentration of solutions exists in adjacent soil masses. The direction of movement is toward the point or zone of greatest concentration. The osmosis is increased by a higher temperature, so that the movement is greater in summer than winter.

King¹⁵ has found that manure incorporated with soil caused a rise of water into the upper three feet of soil, due to a stronger solution and greater osmotic pressure. Fertilizers when applied to a soil dissolve and cause a greater concentration of the soil solution as well as a greater surface tension, with the result that water is drawn to the surface. It is probably true that tillage and the application of lime, both of which may aid bacterial action in developing plant food and thus producing stronger soil solutions, may promote better surface moisture conditions.

Use of Capillary Water.—Capillary water is the form used by plants in their growth. Even in the most severe drouths plants cannot extract all of the film moisture. The common crops may use some gravitational water, but only to a very slight extent. Rice and cranberries are naturally adapted to growth in a very wet or even saturated soil. The amount of water in a soil for best growth varies within rather wide limits, but our common crops make best growth when soils contain from 40 to 60 per cent of their total moisture capacity. This is the *optimum water content*.

Wilting Coefficient.¹⁶—The moisture content of the soil at

which the plant wilts permanently or at which it cannot maintain its rigidity is the *wilting coefficient*. This point does not vary a great deal with different plants, not often over three per cent and usually within 1.5 per cent. It, however, varies widely with different soils. The work of Briggs and Shantz shows that it is approximately one and one-half (1.47) times that of the hygroscopic coefficient. It represents the lower limit of available moisture. In sands and light sandy loams in which the hygroscopic coefficient is very low the wilting coefficient is also low. In clay soils whose hygroscopic coefficient varies from 12 to 20 per cent the wilting coefficient is from 18 to 30 per cent, while in muck and peat soils it may run as high as 70 per cent. The wilting coefficient of the same soil is a constant that may be used in the determination of other constants, such as the hygroscopic coefficient and water-holding capacity.

The wilting coefficient is determined experimentally, but may also be found indirectly from other soil constants to which it sustains a definite relation. The following formulae may be used:

- (a) Wilting Coefficient = $\frac{\text{Moisture equivalent}}{1.84}$
- (b) Wilting Coefficient = $\frac{\text{Hygroscopic Coefficient}}{0.68}$
- (c) Wilting Coefficient = $\frac{\text{Moisture holding capacity}}{2.90}$
- (d) Wilting Coefficient = 0.01 sands + 0.12 silt + 0.57 clay

The probable errors have been omitted from these formulae.

*Wilting Coefficients of Various Soils for Different Plants*¹⁷

	Coarse sand	Fine sand	Sandy loam	Loam	Clay loam
Corn.....	1.07	3.4	6.6	10.2	15.5
Sorghum.....	.95	3.3	5.8	9.7	13.9
Wheat (Kubanka).....	.88	3.3	6.3	10.3	14.5
Oats.....	1.01	3.1	6.1	10.5	14.9
Barley.....	1.04	2.9	6.2	10.5	11.2
Rye.....	.91	2.9	5.9	9.6	14.4
Rice (Japan).....	.96	2.7	5.6	10.1	13.1
Squash.....	1.21	2.6	6.4	9.4	15.1
Pea (Canada).....	1.02	3.3	6.9	12.4	16.6
Vetch.....	1.22	2.4	6.1	9.7	14.7
Tomato.....	1.11	3.3	6.9	11.7	15.3
Clover (red).....	1.00	10.7
Moisture equivalent....	1.55	5.5	12.0	18.9	27.4

Available Moisture.—The non-available moisture is that per cent found in soils when permanent wilting occurs. It is possible that a small amount of this may be slowly available but insufficient for rapid or even normal growth. It is supplied to the plant much too slowly. When the capillary force equals the osmotic pressure

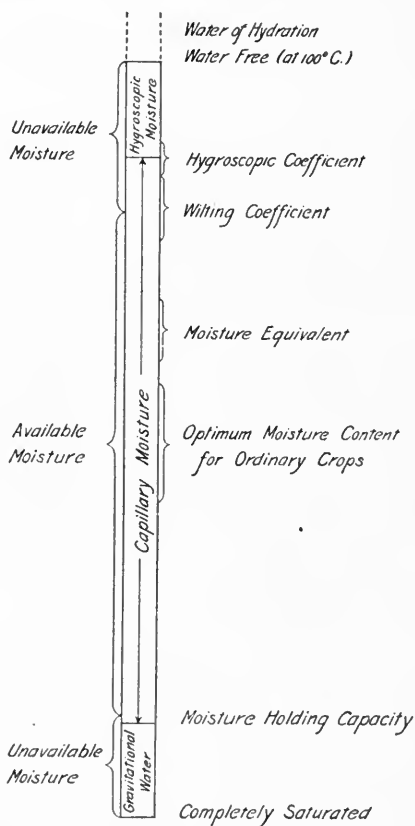

FIG. 94.—Diagram showing the relation of different forms of moisture to the available and unavailable moisture of soils.

or force of the plant the water may be said to be non-available. The difference between the wilting coefficient and the maximum capillary capacity gives the maximum amount of available water. Somewhere between these lies the critical or optimum water content. Under field conditions the difference between the amount of

moisture contained and the wilting coefficient will give the available moisture. A small amount of gravitational moisture may be used by plants. Ordinary plants live but make little growth when the soil is saturated. The diagram (Fig. 94) shows the relation of the soil constants and the different forms of moisture.

QUESTIONS

1. How does capillary moisture differ from hygroscopic?
2. Give law governing height.
3. What causes the film on a water surface?
4. Under what conditions will the film exert pressure?
5. If the tension of water film is 73.9 dynes per square centimeter, what pressure will the film exert if the radius of curvature is 2.5 mm.?
6. Explain the movement of moisture from one soil particle to another. Illustrate.
7. How is moisture held in soil columns? Why is the film thicker on the lower particles?
8. What effect does fineness of particles have on capillary pull?
9. What determines the height to which water will rise in soils?
10. Why should a clay with a higher moisture content than a sand soil extract moisture from the latter when in close contact with it?
11. What is the moisture equivalent of soils?
12. Why should clay have such a high moisture equivalent compared with other soils?
13. Find the moisture equivalent if the hygroscopic coefficient is 6.3 per cent.
14. What determines the rapidity of capillary movement?
15. What is the significance of the experiment with the clod?
16. What effect does capillary movement have on root development?
17. Give King's experiment with the covered soils.
18. Define viscosity. What effect on surface tension does it have? On capillary movement?
19. What effect does temperature have on capillary movement? Why?
20. What effect do mineral substances in solution have upon tension? Organic substances?
21. What effect will an application of manure have on surface tension?
22. Why does water rise faster in medium- than fine-grained soils?
23. Compare columns 1, 3, and 5 in the table on page 207 and explain differences.
24. Compare 9, 10, 11, and 12 and explain differences.
25. From the standpoint of capillary movement, is organic matter desirable in soils?
26. How is the maximum capillary capacity of soils determined?
27. What about the delivery of large amounts of water by capillarity for crops?
28. Give the conclusions reached from the drain gages at Rothamsted.
29. Describe the method of determining capillary pull of soils.
30. Will water rise 26.8 feet high in clay?
31. What part does osmosis play in moisture movement?
32. Give uses of capillary moisture.
33. What is the wilting coefficient?
34. If the hygroscopic coefficient is 6.2 per cent, what is the wilting coefficient?
35. What is meant by available moisture?

36. How do different soils compare in the amount of available moisture?
 37. A soil in the field contains 26.3 per cent of moisture and the hygroscopic coefficient is 6.5 per cent. How much available moisture does the soil contain?

REFERENCES

- ¹ Briggs, L. J., Yearbook, U. S. D. A., 1898, p. 399.
² Briggs, L. J., and McLane, J. W., The Moisture Equivalents of Soils, Bulletin 45, Bureau of Soils, U. S. D. A., 1907.
³ King, F. H., Wisconsin Station, 7th Ann. Report, p. 144.
⁴ Smithsonian Physical Tables, 1896, p. 136.
⁵ King, F. H., Physics of Agriculture, 1901, p. 170.
⁶ Unpublished data, Soil Physics Division, University of Illinois.
⁷ Lyon, T. L., and Fippin, E. O., Soils, 1909, p. 160.
⁸ Karraker, P. E., Journal of Agricultural Research, Vol. 4, No. 2, pp. 187 to 192.
⁹ Unpublished data, Soil Physics Division, University of Illinois.
¹⁰ King, F. H., Wisconsin Station, 7th Ann. Report, p. 151.
¹¹ Rotmistrov, V. G., Nature of Drought According to the Evidence of the Odessa Experiment Station, Russia, English edition, 1913.
¹² Hall, A. D., The Book of the Rothamsted Experiments, 1905, p. 23.
¹³ Lynde, C. J., and Dupré, H. A., Jour. Am. Soc. Agron., Vol. 5, No. 2, 1913, p. 111.
¹⁴ Lynde, C. J., and Bates, F. W., Proceedings Am. Soc. Agron., Vol. 4, pp. 102-122. Lynde, C. J., and Dupré, H. A., Jour. Am. Soc. Agron., Vol. 5, No. 2, Vol. 7, Nos. 1 and 6.
¹⁵ King, F. H., Physics of Agriculture, 1907, p. 172.
¹⁶ Briggs, L. J., and Shantz, H. L., Bulletin 230, Bureau of Plant Industry, U. S. D. A., The Wilting Coefficient for Different Plants and Its Indirect Determination, 1912, p. 72.
¹⁷ Op. Cit., pp. 26-33.

General Reference—Briggs, L. J., Bulletin 10, Division of Soils, U. S. D. A., Mechanics of Soil Moisture, 1897.

CHAPTER XVII

WATER OF SOILS

III. GRAVITATIONAL WATER

GRAVITATIONAL water is that which may be removed from the soil by the force of gravity or drained from the soil under normal conditions. The possible amount of the gravitational water is the difference between the water held by a soil at its maximum capillary capacity and at its maximum water capacity, when completely saturated, or when the air space is completely filled. This amount varies with the type of soil.

The determination of the gravitational water capacity of soils is very unsatisfactory. The amount depends upon the height above the water table. The gravitational water is the difference between the water content, when completely saturated, and when only satisfied with capillary water. This amount will vary, since the same soil will be satisfied by a smaller amount of capillary water the greater the distance above the water table. King shows the amount of water at different heights above the water table with sands of different grades and two soils.

Water at Different Heights Above the Water Table After Being Saturated and Drained¹

Height above water table	Sand No. 20	Sand No. 60	Sand No. 100	Sandy loam	Clay loam
<i>inches</i>	<i>per cent</i>	<i>per cent</i>	<i>per cent</i>	<i>per cent</i>	<i>per cent</i>
84-81	.23	.61	3.93	16.16	21.16
72-69	1.18	1.80	4.94	16.55	31.05
60-57	1.83	2.26	6.77	17.59	31.21
48-45	2.03	2.16	10.50	18.70	31.99
36-33	2.31	4.10	14.95	20.90	32.45
24-21	3.42	13.52	18.92	21.46	34.40
12-9	16.08	22.16	22.68	22.68	35.97
6-3	20.96	22.88	30.28	27.69	37.19

Percolation.—The movement of gravitational water downward through the soil by the force of gravity is called percolation. It depends upon several factors.

1. **Physical Composition or Texture.** The movement of water through the soil by the force of gravity varies directly as the

size of the particles and the pore spaces, but inversely as the total pore space or the porosity. Since these factors depend upon the size of the particles, the physical composition is the controlling factor in percolation. If a fine-grained soil has 50 per cent of pore space and a coarse-grained one has 33, it must follow that the pore spaces in the former must be infinitely more numerous and smaller than in the latter. If the average diameter of the particles of the fine-grained soil is 0.01 mm. and of the other 1 mm., the number of pores for equal areas will be approximately 10,000 times more numerous in the fine than in the coarse, and consequently the resistance to the movement of the water would be much greater in the fine-grained soil or through the smaller pores. The nearer the particles approach uniformity in size the more favorable the conditions for percolation. If various sized particles are present and of similar shapes the smaller ones may tend to clog the interspaces between the larger and may render the soil impervious. If the particles are very irregular in shape, regardless of size, the permeability of the soil may be increased. This is true of volcanic ash soils. The structure of the soil is an important factor in percolation.

2. **Granulation.**—In the case of clays and other fine-grained soils the cementing of the soil particles into granules aids percolation. The large interspaces existing between the granules allow free movement. Even in soils with considerable amounts of sand percolation may be aided by granulation. Heavy soils devoid of granules are almost absolutely impervious. Such soils are puddled. They may be so naturally, or they may become so by some mechanical operation, such as plowing or tramping of stock when wet. This condition may be only temporary.

Any substance that causes or aids granulation will increase permeability and consequently percolation. The application of lime, chalk, marl, or limestone to clay soils is a well-known practice for producing better tilth. Clay soils are readily permeable to water only when their colloids are in a flocculated condition.

3. **Organic Matter.**—A very favorable effect is produced upon the permeability of medium- and fine-grained soils by the incorporation of organic matter, but in coarse-grained, sandy soils the effect of organic matter is to retard percolation, a thing very desirable in such soils. In silt and clay soils the irregular fragments of undecomposed parts of plants impart a porosity helpful to the downward movement of water, while the humified material aids in the pro-

duction of cracks through its property of shrinkage as well as its effect on granulation, both favoring the movement of water.

4. **Viscosity.**—Changes in temperature affect the viscosity or mobility of water to such an extent that it moves more readily under high than low temperatures. The effect of temperature on capillary movement was shown on page 204. King found that the amount of water flowing through soil at 9 degrees C. was 6.15 grams per minute, and at 32.5 degrees it was 10.54 grams. Briggs explained this greater flow on the theory of lessened viscosity, and showed that while the ratio between the flows is 1.71, the ratio between the viscosities is 1.77. These correspond so closely that there is no doubt that his conclusion was right. Water will percolate through soils faster in summer than winter. Water at 32 degrees F. and at 70 degrees F. was allowed to flow from a millimeter opening under the same pressure in each case. Twice as much water flowed out at 70 degrees as at 32 degrees. At 32 degrees the water did not come out in a stream, but dropped rapidly from the tube, while at 70 degrees it flowed in a steady stream.

The viscosity is frequently affected by substances dissolved in the soil water. Some substances increase while others decrease viscosity, as shown on page 206. In the case of organic substances in solution percolation may be aided by the lessened viscosity.

5. **Atmospheric Pressure.**—The changes in pressure of the atmosphere, with its expansion and contraction accompanying the "lows" and "highs," affect percolation to some extent. The decrease of pressure allows the air in the soil to expand, thus forcing out some of the water into the drainage channels. King² found the discharge from a spring to be 8 per cent greater with a falling than a rising barometer and a variation of 15 per cent in the flow of water from a tile under similar conditions.

6. **Shrinkage Cracks.**—The movement of water by percolation is aided greatly by the cracks that are produced in clayey soils by shrinkage during periods of drouth. These cracks do not fully close upon subsequent wetting and may thus leave passageways for water. This is very important in heavy soils. The burrows of animals, especially insects and earthworms, penetrate the soil in all directions and furnish a ready means for movement of water both laterally and vertically. The greatest amount of work done by earthworms is in heavy soils where percolation is naturally slowest. These animals are not abundant in acid soils and those

deficient in organic matter. Crayfish aid the downward movement of water by their burrows.

7. **Roots of plants** penetrate the soil and later decay, leaving passageways through which water may pass quite readily.

Lysimeters or drain gages have been used for determining the amount of percolation and evaporation. The longest and most interesting records have been obtained at Rothamsted, England, where records have been kept for 34 years. The gages consist of masses of undisturbed soil of different depths enclosed in cement tanks with drainage outlets for measuring the percolation. The soil is a flinty clay loam or heavy loam and is kept free from all vegetation.

Rainfall, Percolation and Evaporation³ at Rothamsted, England, Average for 34 Years, 1871 to 1904

Months	Rain-fall	Percolation through soil			Per cent of rainfall percolating through soil		
	inches	20 inches	40 inches	60 inches	20 inches	40 inches	60 inches
January.....	2.32	1.82	2.05	1.96	78.5	88.4	84.5
February.....	1.97	1.42	1.57	1.48	72.2	80.0	75.2
March.....	1.83	0.87	1.02	0.95	47.6	55.6	52.0
April.....	1.89	0.50	0.57	0.53	26.5	30.0	28.0
May.....	2.11	0.49	0.55	0.50	23.2	26.1	23.6
June.....	2.36	0.63	0.65	0.62	24.0	27.6	26.3
July.....	2.73	0.69	0.70	0.65	25.3	25.6	23.8
August.....	2.67	0.62	0.62	0.58	23.2	23.2	21.7
September.....	2.52	0.88	0.83	0.76	35.0	32.8	30.0
October.....	3.20	1.85	1.84	1.68	57.8	57.5	52.5
November.....	2.86	2.11	2.18	2.04	76.7	76.3	72.4
December.....	2.52	2.02	2.15	2.04	80.3	85.4	81.0
Total per year.....	28.98	13.90	14.73	13.79	48.2	51.0	48.0

Results for Years of Maximum and Minimum Rainfall

Maximum (1903).....	38.69	23.48	23.60	24.23	60.7	61.0	63.0
Minimum (1898).....	20.49	7.32	7.90	7.69	35.7	38.5	37.6

It will be noted from the above table that the amount of percolation varies but little for the different depths of soil. The average percolation for the 20-inch depth was 13.90 inches, while for the 60-inch it was 13.79 inches. This shows that only 0.11 inch more water was retained by the deeper soil.

Water Draining from Eight Feet of Saturated Sands. Percentage Based on Dry Soil,¹ King

Time of percolation	Meshes per inch of sieves		
	20-40	60-80	100
1 hour.....	9.6	6.6	1.4
1 day.....	13.8	11.8	6.3
3 days.....	14.5	12.5	7.5
9 days.....	15.3	12.9	8.4
268 days.....	16.4	13.6	9.3

The table shows the amount of water draining from eight feet of saturated sand soil in 268 days. The drainage, of course, was not continuous during this time, but varied with conditions of temperature and atmospheric pressure. During the last 259 days of intermittent drainage the sand lost from 6.56 to 9.15 pounds of water per square foot, or from 1.2 to nearly 1.8 inches of water. Percolation is only possible when the air can enter the soil, hence a slight rain falling on the surface may retard or entirely stop percolation by sealing the surface so that the air cannot get out. This has been observed at the Rothamsted drain gages.

QUESTIONS

1. Define gravitational water.
2. What is the maximum water capacity?
3. Which may have the greater gravitational water capacity, sand or clay?
4. Define water table.
5. How does the movement of water through soil vary?
6. Compare the number of pores in a sand soil, particles 0.05 mm., with a silt soil, particles 0.05 mm.
7. What about the effect of shape and size of particles in the same soil on percolation?
8. What part does granulation play in percolation?
9. Give the effects of organic matter on percolation.
10. Explain the effect of viscosity on percolation.
11. What things affect the viscosity of water?
12. Explain variations caused by changes in atmospheric pressure.
13. What other factors aid percolation?
14. Describe the Rothamsted drain gages.
15. What conclusions may be drawn from the results?
16. Give King's experiment regarding drainage from sands.

REFERENCES

- ¹ King, F. H., *Physics of Agriculture*, 1907, p. 134.
- ² King, F. H., *The Soil*, 1907, p. 180.
- ³ Hall, A. D., *The Book of the Rothamsted Experiments*, 1905, p. 23.
- ⁴ King, F. H., *Wisconsin Station*, 11th Ann. Report, p. 285.

General References King, F. H., *Principles and Conditions of the Movements of Ground Water*. U. S. Geol. Survey, 19th Ann. Report, Part II, 1897-98, pp. 67-206.

CHAPTER XVIII

CONTROL OF MOISTURE

I. DRAINAGE

VERY few places on the earth's surface have ample rainfall so well distributed that no attention need be given to the control of moisture. In many humid and superhumid areas the great problem is disposing of the excess of water, while in semi-arid regions it is to conserve the rainfall for the crop, while in the still drier regions irrigation is the all-absorbing problem. Even in the humid areas some seasons are so dry that the utmost care must be exercised to hold the moisture for the crop.

Removal of Excess of Water.—Drainage.—The average soil has about 50 per cent of pore space. A waterlogged soil is one having the pore space filled with water. It becomes necessary to remove this excess of water so that the food-producing bacteria and the roots of plants may be able to secure oxygen. The water table in the soil must be from three to four feet below the surface, sufficient to give room for the development of large root systems. If it is above this it must be lowered by drainage. Besides the lowering of the water table many other benefits are derived from drainage (Fig. 95).

(a) Drainage gives *stability* to the soil. Ordinarily when a heavy weight is applied to a very wet soil the particles are pushed to one side, the excess of water weakens the cementing material of the granules and acts somewhat as a lubricant to the particles. This movement is very injurious to the tilth of the soil, since it breaks down the granules, producing a puddled condition. This is very likely to occur in any soil, but more particularly in a heavy one. Freezing and thawing or wetting and drying may overcome in time the condition produced if the soil is drained. Great damage is sometimes done by pasturing wet soils during late winter and early spring.

(b) Soils containing an excess of water are rarely in good physical condition. *Granulation* is produced by alternate wetting and drying, and a soil that is saturated practically all of the time cannot be subjected to these beneficial conditions. *Freezing and*

thawing is also another means for producing granulation, if the right amount of water is present. If there is an excess of water the effect of freezing and thawing is to break down the granules. Instead of producing good tilth a "runny," puddled condition results. The soil of a pond where water has stood during the winter will be run together very badly by spring and become quite compact.

(e) It seems almost paradoxical that the removal of the excess of water should *increase the available moisture* for plants, yet it is true. Lowering the water table to a depth of three or four feet enables plant roots to develop in a larger area than is otherwise

A



B



FIG. 95.—The difference in germination and growth on undrained soil (A) and drained (B) soil. Same kind of soil and the same kind and number of seeds were planted. (University of Illinois.)

possible, since plant roots do not penetrate a waterlogged soil. This will give them a chance to secure the water from a depth of three feet or more where otherwise they would be limited to one or two feet. Capillary water, only, is used by plants, and drainage increases the volume of soil that contains this form of moisture.

(d) The removal of the excess of water aids *aëration*, since the water is replaced by air. About 50 per cent of the volume of the soil as it ordinarily exists is pore space, and about one-half of this should be occupied by air under ordinary conditions. This, in a waterlogged soil, would be filled with water. The optimum condition for plant growth is sufficient moisture for the use of the

plant, but not so much as to crowd out the oxygen, which is equally essential.

(c) The *temperature* of the soil will be raised by the removal of the water, since the specific heat of the soil will be lower with less water. If the specific heat of water is 1 and that of soil is 0.2, then a waterlogged soil having an apparent specific gravity of 1.2 and 50 per cent of moisture would have a specific heat of 0.46, or the amount of heat required to raise the temperature of the wet soil one degree would be more than twice as great as for the dry soil. Another factor that affects the temperature is the lowering of evaporation by drainage. Evaporation is a cooling process, and every pound of water evaporated from the surface of the soil requires 966.6 heat units, and this will be taken largely from the soil. Hence wet soils are "late" soils. They may be transformed into "early" ones by drainage (Fig. 95).

Drainage lengthens the growing season of certain soils, and may possibly permit a complete change of crops. Conditions are more favorable for biological activity in the drained soil because of the increase in temperature and of better aëration. King found that well-drained sandy loam had a temperature of 66.5 degrees F., while in an undrained black marsh the temperature was 54 degrees at the same depth.

Experiments conducted with trays filled with the same soil, one of which was drained while the other was not, show differences as given in the table.

Effect of Drainage on Temperature of a Soil¹—Degrees Fahrenheit

Time	Thermometer 1 inch below surface		Thermometer 2 inches below surface		Thermometer 4 inches below surface	
	Drained	Undrained	Drained	Undrained	Drained	Undrained
6 A.M.	46.7	45.0	49.0	47.2	52.5	50.0
8 A.M.	58.0	52.5	53.0	50.5	51.0	49.5
10 A.M.	75.0	67.0	66.5	61.0	57.5	54.0
12 M.	85.5	73.5	77.0	68.5	67.0	62.0
1 P.M.	87.5	73.8	79.4	70.7	70.6	65.1
2 P.M.	84.0	72.0	81.0	72.0	74.2	68.0
3 P.M.	81.0	70.0	80.0	71.0	76.5	70.5
4 P.M.	76.1	65.1	77.0	68.5	76.8	70.8
5 P.M.	71.2	63.8	74.2	66.3	75.4	70.0
6 P.M.	68.0	62.0	72.1	65.0	74.0	69.0

It will be noted that the greatest difference between the drained and undrained soil at one inch in depth was 13.7 degrees, at two inches 9 degrees, and at 4 inches 6.2 degrees.

(f) The removal of the excess of water from the soil increases *decomposition* and *nitrification*, processes necessary for the growth of plants. As a general rule, the mosses and grasses of swamps have decomposed to a very slight extent only, because of the excess of moisture which prevents the access of oxygen. Drainage allows aëration and the process of nitrification may then take place.

(g) "*Heaving*" of soil or crops on medium- to fine-grained soils is diminished or almost entirely prevented by the removal of the water. When a wet soil freezes it expands in the direction of least resistance, which is upward, and the crop, whatever it is,



FIG. 96.—Pipe heaved nearly 6 inches during winter of 1915-1916.

is pushed along with it. This process being repeated over and over may "heave" a crop out of the soil entirely, as in the case of young alfalfa, clover or wheat. If the soil is drained, the expansion of the smaller amount of water in freezing will be taken care of in the pore spaces of the soil without expanding upward to such great extent. Figure 96 shows the heaving of a gas pipe stake during one winter, and figure 97 shows the heaving of alfalfa in a poorly drained soil. Where tight subsoils are present the danger of heaving is very great, so that it is practically impossible to grow alfalfa and clover.

(h) The effectiveness of thorough drainage in *preventing erosion* has been observed in many instances, but this point is discussed under the subject of erosion.

(i) Drainage is one of the most effective means for removing alkali from land under irrigation, and thus preventing its "rise" and consequent injury to crops. It, in conjunction with flooding, is also an effective method for reclaiming land that contains so much alkali as to render it unproductive.

Types of Drainage.—Two general types of drainage have been employed, open and tile drains.

(a) **Open Drains.**—In a great many cases, the open drain is an absolute necessity, because the large amount of water to be carried off precludes the possibility of using covered drains at a reasonable cost. Hence there will always be a large number of



FIG. 97.—Alfalfa that was completely killed by heaving. Note roots lying on surface. (S. V. Holt.)

open drains, such as dredge ditches. In some cases open ditches are necessary because quicksand is present which enters the drains through the openings between the tiles and fills them so as to reduce their efficiency or even clog them entirely. In other places the fall or slope of the land is so slight that tile drains would be of very little use and hence the open ditch becomes a necessity.

A form of open or surface drainage that is effective and adapted to certain types of soil is that practiced on soils with hardpan or tight clay substrata. Such soils occur in various parts of the country and the form of drainage adapted to them is that of dead furrows or shallow ditches about 20 or 25 feet apart. These are employed to a large extent on areas with tight clay subsoils.

There are several serious objections to open drains. They are almost invariably expensive forms, because constant care is needed

to keep the ditches open and in good condition (Figs. 98, 99, 100). In a few years the fall may become very uneven, due to more rapid erosion at one place than at another. Obstructions may get into

FIG. 98

FIG. 99



FIG. 98.—The obstructions interfere with the current and cause deflections. (H. C. Wheeler.)
 FIG. 99.—Ditch gradually being filled by soil due to current being retarded by grass. (C. C. Comstock.)



FIG. 100.—A neglected ditch often seen in heavily wooded areas. (H. C. Wheeler.)

the ditch which will cause deflections of the current and result in wearing away of the bank. There is always a considerable waste of land in connection with open drains even at the very best, and

an open ditch is always in the way. It interferes very seriously in many cases with tillage of land, but one of the most serious objections is the lack of physical benefit to the soil from open ditches in comparison with tile drains. This is principally due to the fact that small open drains are never as deep as the corresponding tile drain and do not remove the water as completely. The growth of weeds and grass clogs the ditch and renders it less effective.

(b) **Tile Drains.**—Since the object of drainage is to lower the water table, the tile should be amply large and the lines sufficiently close together and at such depth that the water may be removed before the crop suffers serious injury. If the tile is laid deep enough to lower the water table to only two feet beneath the surface on an average, a rain of two or three inches will raise it injuriously near the surface, and if frequent rains follow the crop will be damaged in spite of the fact that the land is tilled. If the tile is too small this slow removal may permit very serious

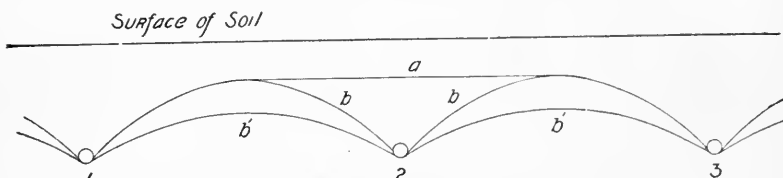

FIG. 101.—Showing the water table at *a*, with lines of tile at 1 and 3, and at *bb*, soon after the insertion of another line at 2 and later at *b'b'*. The slope of the water table between the lines of tile varies with the perviousness of the soil.

injury. If the water table is three feet beneath the surface and the foot of soil above it is two-thirds saturated, a rainfall of two inches will raise the water table a foot at least and damage to the crop may result.

The topography of the water table in tile-drained land consists of a series of ridges, with the crests about midway between the lines of tile. The height of these crests above the tile depends upon the texture and character of the soil strata, the distance between the lines of tile and the amount of rainfall (Fig. 101). In laying tile the character of the soil should be taken into account and the lines placed close enough together so that the water table will be lowered to at least 30 inches beneath the surface at its highest point. It must be remembered that the most of the water does not simply pass downward into the tile, but it must move laterally from two to five rods, depending upon the distance between the lines. The lateral movement is comparatively slow, so much so in

many soils that the crop is frequently damaged before the water table is lowered beyond the point of injury. The lines of tile should be laid closer in somewhat impervious soils than in pervious ones. In tight clay subsoils the tile drains should be not over four rods apart, and no doubt two rods would be better.

Coarse-textured soils generally drain better than fine ones. An occasional tight stratum only a few inches thick may seriously interfere with drainage. In general, limestone soils drain better than strongly acid ones because of the granulation produced by the limestone. Heavy soils are especially aided by shrinkage and the formation of cracks to a depth of several feet which may not completely close. Earthworms, crayfish and other animals do much to open up the soil for free movement of water, both laterally and vertically.

QUESTIONS

1. What problems come up in the control of moisture?
2. Define a waterlogged soil. What objections to it?
3. Explain some of the results of lack of stability in a soil.
4. Why are permanently saturated soils usually in poor tilth?
5. How does drainage affect the available moisture?
6. Explain how aeration is affected by drainage.
7. What is the effect of drainage on the specific heat of a soil? Why?
8. Why does drainage affect evaporation?
9. How may drainage affect crops and the length of growing season?
10. Why are decomposition and nitrification necessary?
11. How does drainage prevent heaving?
12. Why does a tight subsoil cause heaving?
13. Why are open drains necessary?
14. How are tight clay soils usually drained?
15. What are some objections to open ditches?
16. What precautions should be observed in tiling? Why?
17. Upon what does the topography of the water table depend?
18. How low should the water table be?
19. Why is lateral movement of water through soils so slow?
20. What are some of the soil conditions that aid drainage?

REFERENCE

¹Unpublished data, University of Illinois.

General References.—Whitson, A. R., and Jones, E. R., Bulletin 146, Wisconsin Station, Drainage Conditions in Wisconsin, 1907. Fippin, E. O., Bulletin 254, Cornell Station, Drainage in New York, 1908. Jeffery, J. A., Bulletin 56 (special), Michigan Station, Tile Drainage, 1911. Smith, A. G., Farmers' Bulletin 524, U. S. D. A., The Drainage of the Farm, 1913. Yarnell, D. L., Farmers' Bulletin 698, U. S. D. A., Trenching Machinery for Tile Drains, 1915. Hills, J. L., Jones, C. H., Williamson, C. G., and Burdick, R. T., Bulletin 173, Vermont Station, Principles of Land Drainage, 1913. Woodward, S. M., Bulletin 304, U. S. D. A., Land Drainage by Means of Pumps, 1915. Elliot, C. G., Farmers' Bulletin 187, U. S. D. A., Drainage of Farm Lands, 1904. King, F. H., Irrigation and Drainage, Part II, Revised Ed., 1909. Jeffery, J. A., Land Drainage, 1916.

CHAPTER XIX

CONTROL OF MOISTURE

II. TILLAGE

ONE of the means for controlling moisture that is quite universally practiced is that of tillage. It finds application in arid and semi-arid sections at all times and in humid and superhumid regions, more particularly in periods of drouth. Any form of implement that stirs the soil, from the crudest form of hoe to the powerful tractor with its dozen plows and its harrows, will accomplish the same object.

Increasing the Moisture Capacity of Soils.—Probably one of the most important factors in supplying soils with sufficient moisture for crops is by increasing their water holding capacity. This may be accomplished by several methods:

(a) **By Tillage.**—Soils frequently become so compact that they will not absorb water readily, hence there will be a large run-off and a consequent loss not only of water but of soil material due to erosion. Only the water that is absorbed can be of any benefit to crops. Hence it becomes very necessary to put the soil in condition to absorb as much water as possible. This can best be accomplished by stirring the soil to considerable depth with some form of plow. The best implement for this purpose is the common mold board plow. In plowing, the soil is not only inverted, but pulverized, and this is very beneficial if the soil is in proper condition with respect to moisture. To increase the storage capacity to the greatest extent plowing should be as deep as possible. The storage capacity may easily be doubled by this means and the soil put in condition to absorb water readily so that very little runs off. This practice is especially advisable on rolling land and in semi-arid regions.

(b) **Compacting the Soil.**—In the process of plowing the soil is left too loose for retaining moisture to the highest degree, either against percolation or evaporation, and in order to bring about proper conditions a certain amount of compacting is necessary. This may be done by various implements, such as the spike-tooth harrow, the disk harrow, the rotary harrow, the corrugated roller,

or the subsurface packer. The use of these implements closes any large air spaces that exist in the soil that would tend to increase either evaporation or percolation and hence renders the soil much more retentive of moisture than it would be otherwise.

(c) **Organic Matter.**—The water holding capacity of the soil may be largely increased through the addition of organic matter. This constituent acts as a sponge, absorbing large quantities of water which are held against the force of gravity. Capillary movement is retarded, thus decreasing surface evaporation.

(d) **Deep Rooting Crops.**—The effect of deep rooting crops is somewhat similar to deep plowing or subsoiling except that the openings made by the roots become partly filled with organic matter, which in itself is beneficial. The openings furnish a passageway for water and air to greater depths than any practical tillage could do, thus enlarging the water reservoir. The decay of the organic matter produces a somewhat granular condition in the deeper subsoil that aids in the absorption and retention of moisture. Often the subsurface and subsoil become so compact that the water is prevented from percolating through them to any great extent, and this permits the surface stratum to become saturated and then a large amount of run-off and evaporation must necessarily occur.

Removing the Excess of Moisture by Tillage.—The removal of water by tillage is not often practiced and its application is very limited. Yet if a few inches of surface soil contains too much water this may be removed to some extent by tillage, which encourages evaporation from the stirred soil, but the greatest care is necessary. The soil may be plowed or cultivated and left somewhat rough, thus giving it a chance to dry out. This may permit seeding earlier than if left in its original compact condition. In certain soils rolling may be of benefit because of the effect it has in compacting the soil and facilitating capillary movement of moisture to the surface where it is evaporated. Frequent cultivation may also have a similar effect in drying out the cultivated soil, since every cultivation will bring to the surface moist soil that will become dry, and better conditions for seeding may be produced in this way. This should not be practiced with soils that are easily puddled, but may be advisable for sandy soils or those having an abundance of organic matter.

Decreasing Losses from Soils.—Water is lost from soils by percolation to depths below the capillary limit by drainage or

percolation, by transpiration from leaves of plants and by evaporation from the surface of the soil.

(a) **Decreasing Percolation.**—The amount of percolation depends very largely on the texture of the soil itself. As a general rule, the coarser the texture or the larger the air spaces the greater the amount of percolation. This, of course, may be modified by the amount of compaction and also by the organic-matter content. The amount of percolation depends, too, on the openness of the soil produced by tillage as given above. Excessive percolation where it is due to coarseness of soil texture is very difficult to prevent.

The incorporation of some water-retaining material such as clay or any of the finer soil constituents or organic matter with the sand or gravel will aid in accomplishing the results desired. The former is an expensive process, but has been done on a small scale with excellent results. The use of organic matter is a more practical but somewhat slower process unless under conditions where abundant supplies of farm manure are at hand. Compacting is very beneficial in case of sandy soils, but must be carefully done in the case of heavy soils.

(b) **Decreasing Transpiration from Plants.**—All plants in their growth require enormous amounts of water, practically all of which must be secured from the soil. We have seen that from 300 to 500 pounds of water are required for each pound of dry matter produced. This means that crops remove large quantities of water from the soil.

The relative amount of water required may be reduced by an abundance of plant food provided through cultivation, rotation and fertilization. Weeds and other plants foreign to the crop should be destroyed to prevent them from depriving it of the moisture necessary for its growth.

(c) **Preventing Evaporation by Mulches.**—A mulch is any material placed on or produced from the surface soil by tillage. Its object is to prevent evaporation. To be effective a mulch must be dry. Since moisture films pass very slowly into dry, loose soil, practically all of the moisture that is lost is by interstitial evaporation and diffusion through the mulch air to the atmosphere above. This diffusion takes place very slowly.

The following table gives the results obtained by Buckingham

with different depths of air-dry mulches, the soil used being the Leonardtown loam:

*Loss of Water by Interstitial Evaporation and Diffusion Through Mulches of Varied Thickness of Leonardtown Loam*¹

Depth of mulch	Moisture lost per year	Depth of mulch	Moisture lost per year
<i>inches</i>	<i>inches</i>	<i>inches</i>	<i>inches</i>
1	2.71	4	0.95
2	1.60	6	0.69

With a 12-inch mulch of Takoma lawn soil the loss of moisture amounted to one inch in six years. The amounts lost are so small that they need not be taken into account. Under field conditions a mulch is rarely ever perfect. There will be some places where capillarity is at work. Hence under field conditions laboratory results are seldom attained, but they furnish principles to guide in farm practice. All mulches enclose air of high humidity, thus retarding or preventing evaporation from the moist soil beneath. The dry layer prevents capillary movement to the surface and is made much more effective by its looseness.

There are two kinds of mulches, **artificial** and **soil mulches**.

(a) **Artificial** mulches are formed by the application of manure, straw, chaff, peat, leaves, sawdust and other materials to prevent evaporation. This method must necessarily be very limited in its application because of the expense attached and labor involved. Such mulches are, however, very effective. At the same time other objects are accomplished, such as preventing the growth of weeds and adding plant food. Strawberries and bush fruits are sometimes mulched with straw, manure or leaves. "Straw" potatoes are grown quite extensively on the deep loessial soils along the Mississippi river. The potatoes are planted three or four inches deep in the soil. After the soil becomes warm and before the potatoes come up they are covered with straw to a depth of six or eight inches. It keeps down the weeds, conserves moisture and furnishes some plant food which is leached out of the straw into the soil.

In Europe and other countries stones are placed upon the surface of the soil in hillside vineyards to conserve the moisture. Gravel is sometimes applied for the same purpose.

(b) **Soil** mulches are by far the most practical and common means of conserving moisture. They are applicable to all climates

and conditions. The soil mulch consists of a dry layer of soil, either loose or compact. The loose mulch is far more effective and common than the compact (Fig. 102). This latter results only after much moisture has been lost from the soil, and should not be depended upon.

Some soils are self mulching to a certain extent. Sands, peats and highly granular soils are of this character. The best way of producing a soil mulch is by tillage, the kind of implement depending upon the soil, its tilth and moisture content, and the kind and condition of the crop.

Fineness of the Mulch.—Mulches may be made too fine to be of greatest value under all conditions. If fine- or medium-grained



FIG. 102.—A good method of conserving moisture.

soils contain little organic matter, cultivation tends to produce a mulch of individual particles or a dust mulch, which, while it serves very well for preventing evaporation, yet serves equally well for preventing absorption of rainfall. Hence the first dash of a heavy shower causes these particles to run together and produce an almost impervious stratum. If the mulch is not so fine or is somewhat cloddy or granular this running together does not take place so readily and a much larger proportion of the rainfall will be absorbed. This in arid regions becomes a very serious problem where it is desirable that all of the rainfall should be absorbed. Hence a mulch should not be made with an implement that reduces the soil to dust.

The Depth of the Mulch.—The deeper the mulch the more effective it is. King has shown very conclusively that evaporation is prevented to a very large extent by deeper mulches. The following table gives his results:

Effectiveness of Soil Mulches of Different Kinds and Depth²—Water Lost in 100 Days

	No mulch	Mulch 1 inch deep	Mulch 2 inches deep	Mulch 3 inches deep	Mulch 4 inches deep
Black marsh soil:					
Tons per acre	588.0	355.0	270.0	256.4	252.5
Inches of water	5.193	3.12	2.384	2.265	2.230
Per cent saved by mulches		34.54	54.08	56.39	57.06
Sandy loam:					
Tons per acre	741.5	373.7	339.3	287.5	315.4
Inches of water	6.548	3.3	2.996	2.539	2.785
Per cent saved by mulches		49.69	54.24	61.22	57.47
Virgin clay loam.					
Tons per acre	2,414	1,260	979.7	889.2	883.9
Inches of water	21.31	11.13	8.652	7.852	7.805
Per cent saved by mulches		47.76	59.38	63.13	63.34

It will be noted from this table that the four-inch mulch was no more effective than the three-inch.

Deep mulches are very effective in conserving moisture, but there are serious objections to their use where crops are growing. The objections apply more directly to farming in humid than in semi-arid and arid regions. If in humid areas a mulch three or four inches deep is produced on a soil with an intertilled crop, serious root injury will occur which will materially decrease yields. Deep mulches are practical only on bare soils. The effectiveness of a mulch depends upon its looseness and dryness. A three-inch mulch means the loss of a large amount of water if it is to be effective to its full depth. To maintain a mulch of this depth more frequent cultivation is necessary than for shallow ones. Every cultivation turns under dry soil and brings moist soil to the surface, resulting in loss of moisture. Shallow mulches are easily maintained with a minimum of cultivation. In humid climates, if the crop is free from weeds, there is little necessity for cultivation of sands, sandy loams and silt loams.

Besides the moisture lost from the mulch the plant food that

it contains is unavailable for the use of the crop. If the mulch is three inches deep it means that about one-half of the plowed soil, the most fertile part, has little value except for the conservation of moisture, and in humid climates this layer is of much greater value to the crop for the plant food it contains than for the moisture it conserves.

Maintenance of the Mulch.—Under certain conditions the soil mulch may be entirely destroyed or rendered much less effective by a shower, so that it becomes necessary to renew it. Tillage of some kind must be resorted to in order to reproduce it. After a light shower a harrow or weeder may be effective in renewing it.

The ease with which a mulch may be maintained depends to a large extent upon the kind of soil. Sands and sandy loams respond readily to tillage and the mulch is easy to produce. Soils containing large amounts of organic matter are granular, and a loose, mellow surface mulch is maintained without difficulty. Heavy soils, low in organic matter, present the greatest difficulty, since they are likely to be cloddy and deficient in granulation. To produce a good mulch in these soils by mechanical means alone is almost impossible. Anything that encourages flocculation will materially aid in the formation of mulches.

The maintenance of a mulch is especially important in arid and semi-arid sections where so much depends upon the conservation of moisture. Even with small grain the mulch is maintained by means of a light spike-tooth harrow or weeder until the grain by shading the soil prevents excessive evaporation.

QUESTIONS

1. What effect does compacting have?
2. What form of tillage increases the moisture capacity of soils to the greatest degree?
3. How does organic matter affect the water-holding capacity of soils?
4. Explain the effect of deep rooting crops on water capacity of soils.
5. How may water be removed by tillage?
6. How may excessive percolation be overcome or prevented?
7. Explain how transpiration may be reduced.
8. How much moisture is lost by interstitial evaporation and diffusion through the mulch?
9. Why is it impossible to have a perfect mulch under field conditions?
10. How does the humid soil air of the mulch prevent evaporation?
11. Define an artificial mulch.
12. Give advantages and disadvantages of its use.
13. What is a soil mulch?
14. How is it effective in retaining moisture?

15. Give facts regarding fineness of mulches.
16. What conclusion may be drawn from King's work as given in table on page 235?
17. What are some disadvantages of a three-inch mulch?
18. How deep should the mulch be?
19. How does a shower destroy a mulch?
20. What part does texture play in the case with which a mulch may be maintained?
21. How often should cultivation be done to maintain a mulch?

REFERENCES

- ¹Buckingham, E., Bulletin 38, Bureau of Soils, U. S. D. A., Studies in the Movement of Soil Moisture, 1907, p. 17.
- ²King, F. H., Physics of Agriculture, 1907, p. 186.

CHAPTER XX

CONTROL OF MOISTURE

III. DRY-LAND AGRICULTURE

THE distribution of rainfall over the surface of the earth is very irregular, so that extensive areas are deficient in moisture and special cultural methods and special crops must be used. Many regions are so poorly supplied with moisture that crops cannot be grown, even under the best conditions, without irrigation. It will be well to consult the table, page 189, on the annual precipitation on the earth's land surface. The map, figure 89, may be of further help in giving a correct idea as to the location of the humid and dry areas.

From the table, page 189, it is seen that approximately 65 per cent of the land area of the earth receives less than 30 inches of rainfall. About 25 per cent receives less than 10 inches, while 40 per cent has from 10 to 30 inches. In the United States alone the dry-land region covers about one-half the entire area, and 1,135,000 square miles of this is suitable for dry farming. Australia has about the same amount, and extensive areas are found in Africa and Asia and smaller ones in Europe and South America.

Adaptation of a Region to Dry Farming.—In dry-land farming, while the amount of moisture supplied by the rainfall is by far the most important factor, yet there are secondary ones that must be taken into consideration. These are frequently of sufficient importance to bring absolute failure if overlooked or neglected. These include evaporation and the character of the soil, which are of almost equal significance with the rainfall.

(a) **Rainfall.**—The adaptation of a region to dry farming depends upon several factors, one of the principal ones being the amount of rainfall and its distribution through the year (Fig. 103). Dry farming is not practical with less than 10 inches of rainfall annually, but there are modifying factors. With this amount the moisture must be carefully stored and conserved for the crops. The margin is so narrow that a year or two with a

rainfall but slightly below the normal will result in failure. The distribution of this rainfall is quite important, although not so

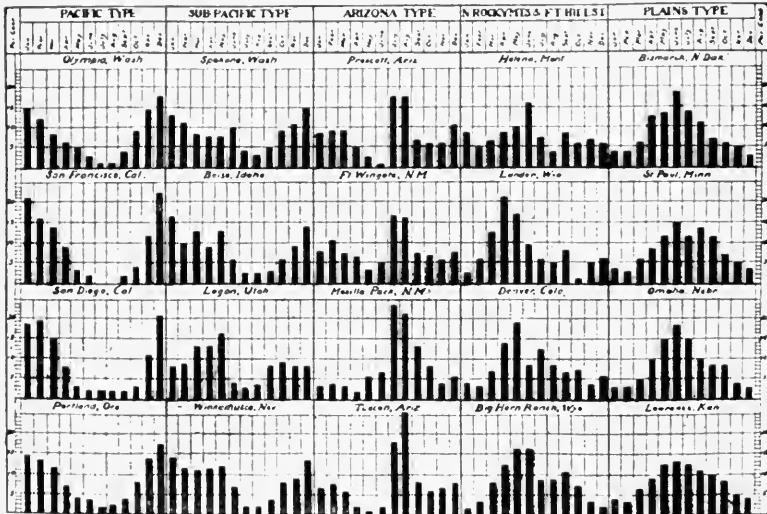

FIG. 103.—Types of rainfall over the dry-farm area of the United States. (After Henry)



FIG. 104.—Sage brush on land well adapted to dry farming. Utah.

much so as in humid regions, since by practicing the best methods of conservation the moisture may be held in the soil. It is, however, desirable to have the rainfall during the growing season.



FIG. 105.—A gravelly soil not well adapted to dry farming (Dry Farming, Wadsworth, Courtesy Macmillan Company.)

(b) **Evaporation.**—The amount of evaporation is one of the factors that determines in a measure the value of a region for dry farming, since, other things being equal, that place is best adapted to this practice which has the least evaporation (Fig. 101). North Dakota with a rainfall of 13 inches has 31 inches of evaporation from a free-water surface during the six summer months, while northern Texas with a like rainfall has 55 inches. It is very evident that the former would be better adapted to dry farming.

Rainfall and Evaporation from a Free-Water Surface¹

Places	Annual precipitation	Annual evaporation
	<i>inches</i>	<i>inches</i>
Lost River, Idaho.....	8.47	70
Laramie, Wyoming.....	9.81	70
Fort Duchesne, Utah.....	6.49	75
St. George, Utah.....	6.46	90
Tucson, Arizona.....	11.74	90
Mohave, California.....	4.97	95
Fort Yuma, Arizona.....	2.84	100

(c) **Soils.**—The character of the soil is of much importance, since many are entirely unfit for dry farming, because of some peculiarity they possess which renders them incapable of retaining the moisture necessary for crops. In selecting land for dry farming, it should not be an acid soil and should neither be too open nor too impervious. Coarse-grained soils (Fig. 105) and very fine-grained ones are equally objectionable for this kind of agriculture. Layers of gravel or coarse sand or hardpan are serious obstacles, since in the one case the water passes beyond the range of capillarity and in the other the storage reservoir is small and the moisture cannot percolate deep enough to be retained against evaporation. Medium-grained soils (Fig. 106) with uniform texture to a depth of eight or ten feet furnish best conditions.

Water Requirements of Plants.—The amount of water used by plants in arid regions is about one-half more than in humid regions. In Utah experiments were carried on for six years on fertile soils, and the conclusion is that an average of 250 pounds of water per pound of dry matter was required.

Briggs and Shantz have made determinations of the moisture re-

quirements of a large number of plants. The results of their investigations are given in the following table:

Water Required to Produce One Pound of Dry Matter at Akron, Col.²

Millet.....	310	Potato.....	636
Sorghum.....	322	Cowpea.....	571
Corn.....	368	Soybean.....	744
Sunflower.....	683	Sugar beet.....	397
Wheat.....	513	Red clover.....	789
Teosinte.....	383	Sweet clover.....	770
Barley.....	534	Alfalfa.....	831
Oats.....	597	Tumble weed.....	287
Flax.....	905	Russian thistle.....	336

It will be seen that the amount of water varies from 287 to 905 pounds per pound of dry matter. The average of the above is 550 pounds of water for each pound of dry matter. Some crops are better adapted to dry land agriculture than others because of the fact that they require less water, while some have habits of growth that enable them to resist drouth. Many plants must be acclimated before best results can be obtained.

The Utah Station found that cultivation lessened the amount of water required.

Pounds of Water Required to Produce a Pound of Dry Matter of Corn³

	Not cultivated	Cultivated
Sandy loam.....	603	252
Clay loam.....	535	428
Clay.....	753	582
Type not given.....	451	265

Loss of Water.—Rainfall is lost from the soil in four different ways, namely: run-off, percolation, evaporation, and transpiration.

(a) **Run-off.**—One of the essentials of dry farming is to prevent loss of water through surface run-off by putting the soil in condition to absorb the rainfall. It is impossible to prevent some loss because of the torrential rains in arid regions. The soil should be kept in a loose condition, so as to absorb water as rapidly as possible.

(b) **Percolation.**—It is rarely the case that there is so much rainfall on soils well adapted to dry farming that water gets beyond

the range of capillary action. Therefore loss by percolation is insignificant. Percolation into the upper soil layers must take place very rapidly to check complete saturation of the surface soil, because this would result in more or less run-off. For this purpose the looser the soil the better.



FIG. 106.—A deep, medium-grained soil well adapted to dry farming. Utah. (Dry Farming, Widtsoe. Courtesy Macmillan Company.)

(c) **Evaporation.**—Arid conditions are very well adapted to evaporation of water from the soil surface, due to the very low relative humidity, the rarity of the atmosphere and the large air movement taking place in arid regions. This is the most serious source of loss. At Salt Lake City the relative humidity in summer is about 35 per cent, while in humid regions the average is from 75 to 80

per cent. As a general rule, the surface soils are dry in arid regions, and this prevents, in a measure at least, a large loss of water, since the movement of water through dry soil is very slow. Very little evaporation takes place within the interstices of the soil itself, as has been shown by the table on page 233. Buckingham has shown that the amount of water lost by transfer upward along with the air in the process of aëration amounts to no more than one inch in six years. It is true, however, that coarse soils lose a larger amount in this way than fine-grained ones, but the loss in either case may be neglected.

(d) **Transpiration.**—All plants take water through the root hairs and a very large part of it is transpired through the leaves. The amount of water used in this way constitutes practically all that is taken up by the plant except that used in building up tissues, which generally amounts to only a small fraction of the total amount. Transpiration varies with certain conditions, both of weather and soil, and in general the factors that affect evaporation from the soil affect transpiration from the plant (see page 188). This applies to plants growing in humid regions as well as under arid conditions. Transpiration varies inversely as the relative humidity, directly with temperature, with wind velocity and direct sunshine; but it is decreased by a large amount of plant food material dissolved in the soil moisture. Arid conditions are especially favorable for transpiration.

It must be remembered also that weeds, like useful plants, transpire large amounts of water and may be one of the greatest sources of loss unless the soil is kept free from them. Weeds have no place on any farm, but more especially on a dry-land farm. Rotmistrov⁴ says, "Weeds are the bitterest enemy of field culture and the best friend of drought."

METHOD OF PREVENTING LOSS OF WATER

In dry-farm practice every means must be used for preventing loss of moisture. Other crop factors sink into insignificance in comparison with this one. The moisture must be sufficient not only to start the crop, but there must be enough stored in the soil to mature it. The farmer knows that every pound of moisture taken from the soil that does not go through the crop will lessen the yield.

The loss of moisture by evaporation is prevented to some extent by the crop itself. After the crop becomes large enough to shade the ground evaporation is greatly retarded. This is especially true

of non-tilled crops. The air enclosed in masses of vegetation, such as wheat, oats, millet, clovers and similar crops, has a comparatively high humidity, so that evaporation from the soil is retarded and probably almost entirely prevented during a large part of the day. It is a matter of common observation that the dew remains in heavy oats or wheat many hours after sun-up and is deposited again several hours before sunset. This will effectively prevent much evaporation from the soil. While the humidity of the air in these crops of semi-arid regions would not be as high as in humid ones, yet the difference would be sufficient to lessen the evaporation.

With tilled crops, shading aids to some extent, but the mulch is the important factor. When the crop has grown to such size that the roots are well distributed through the soil, moisture has very little chance of reaching the surface because of the network of roots which are absorbing all moisture that comes within reach.

Tillage.—The best means for preventing loss of water is by tillage, by which a mulch is maintained. Various experimenters have found that cultivation will save from 22 to 55 per cent of the water that would otherwise evaporate.

(a) **Depth of Tillage.**—Tillage produces conditions in the soil that permit very slow capillary movement by forcing soil particles apart so that the films of water cannot pass freely from one to another. As a general rule, the deeper the mulch the more effective it is in preventing evaporation. In arid regions the plowing is one of the most fundamental operations, since it plays two very important functions, first, in producing a loose mulch for retarding capillary movement, and, second, in forming a deep stratum for absorbing the rainfall and retaining it afterward. The Utah Station has conducted a number of experiments upon depth of plowing and the results show that eight to ten inches is the best depth. When increases for greater depths are obtained they are usually too low to cover the additional expense.

*Yields of Wheat for Different Depths of Plowing. Utah Station.—Bushels Per Acre*⁵

	Juab County	Washington County	Tooele County	Sevier County
Plowing 8 inches deep.....	23.3	11.6	14.7	5.3
Plowing 10 inches deep.....	23.4	12.0	14.9	5.8
Plowing 15 inches deep.....	16.9	15.2	14.8	6.8
Plowing and subsoiling 18-20 inches deep.....	15.4	15.2	16.2	6.4

Moderately deep plowing is very essential, since it prevents loss by surface drainage.

(b) **Fall Plowing.**—Summer or fall plowing is especially advantageous because it permits the absorption of winter rains and snows, and if cultivation is then done as early as possible in the spring a large amount of moisture may be held in the soil for the use of the crop in the fall or the following season. If the plowing must be done in the spring it should be done as early as possible to catch the rains and hold what is already in the soil.

The disk can be used to good advantage on either fall or spring plowing to produce deep mulches. Even on stubble the disk can be used to advantage as soon as the grain is removed. If a crop is seeded in the fall, one of the very necessary things is to produce a mulch as early in the spring as possible with some implement adapted to that purpose.

(c) **Summer Tillage and Cultivation.**—Alternate cropping provides for a crop every other year. To leave the land idle or occupied with weeds would be of no benefit. The object of not cropping during one season is to store moisture for the crop the following year. It is necessary then to put the soil in condition not only to absorb the rain that may fall, but to conserve it afterward. If weeds are allowed to grow the moisture will be lost. To avoid this loss summer tillage or fallowing is practiced. This fits the soil for absorbing water, for conserving it from evaporation by a mulch and kills weeds that use it.

Cultivation of crops is as important as summer tillage and should be done to a greater depth than in humid regions. It may be done without injury to the roots of the crops, because the root systems of plants develop deeper in arid than in humid soils. The mulch produced on the surface should not be too fine, but made up of small clods mixed with fine granular material. If a dust mulch is produced, the first dash of rain causes the soil particles to run together and produces a somewhat impervious stratum which prevents rapid absorption and water is lost through surface run-off. Every effort must be made to maintain a mulch until a network of roots is developed and the crop is large enough to shade the ground. Another objection to the dust mulch is that the fine material is so easily moved by the wind that serious loss of soil may result.

After a shower falls, the mulch should be renewed as soon as possible. Experiments have shown that of the water lost during

the first week after a rain 60 per cent occurred during the first three days, hence the necessity for cultivation as soon as possible.

(d) **Subsurface Packing.**—Newly plowed soil contains many large air spaces and is too open for retaining water against evaporation. Subsurface packing is resorted to for closing these air spaces and preventing excessive loss of water by evaporation. This is accomplished in a variety of ways. Figure 107 shows the subsurface packer which is used for this purpose. The wedge-like wheels, five inches apart, crowd the soil to both sides, thus compacting the subsurface, but leaving a mulch on the surface. This implement was invented by Mr. H. W. Campbell, of Lincoln, Nebraska, one of the pioneers in dry farming.

Other methods are resorted to for compacting the subsurface.

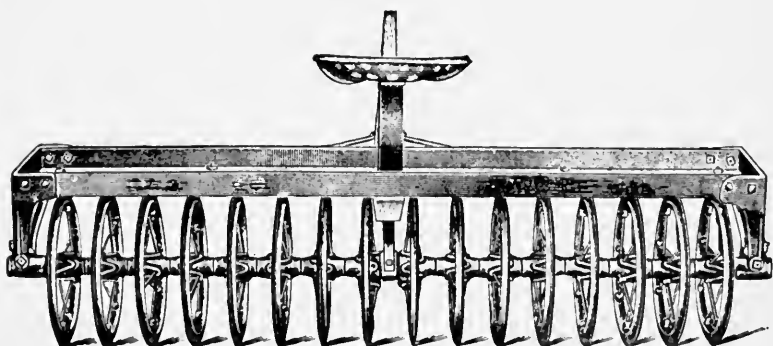

FIG. 107.—Campbell Subsurface Packer.

such as using the disk set straight. The ordinary smooth roller would not be desirable for this purpose, because the compaction that it produces renews capillarity at the surface and would cause a loss of moisture unless a mulch were again produced on the surface. In fact, the smooth roller should never be used on a dry farm, as the flat surface produced encourages the soil to blow. The corrugated roller leaves the soil rough and this prevents or at least greatly lessens blowing. The rolling should not be done parallel to the direction of the prevailing winds, but at right angles to it.

(e) **Storing of Rainfall.**—A very important factor in dry farming is the storing of the rainfall of one year in the soil for the use of the crop the coming season. The major part of the zone in which the water is stored should be sufficiently deep so that it is beyond the depth of ready capillary movement to the surface and

within the limit of the root zone for plants under arid conditions. This varies from eight to ten feet or more in depth. Experiments in Utah showed as much as 95½ per cent of the water which fell as rain and snow during the winter was found stored in the first eight feet of soil in the spring. Atkinson found that at the Montana Station soil which contained 7.7 per cent of moisture in the fall contained 11.5 per cent in the spring and after proper summer tillage contained 11 per cent in the fall. The following table shows the amount of water that may be stored in the soil during the winter:

Percentage of Water in Each Foot of Soil to a Depth of Eight Feet⁶

	First foot	Second foot	Third foot	Fourth foot	Fifth foot	Sixth foot	Seventh foot	Eighth foot	Average
Sept. 8, 1902	6.37	7.32	8.17	8.55	8.26	9.29	10.10	10.38	8.56
April 24, 1903	19.29	19.08	18.83	16.99	13.61	12.62	12.24	12.37	15.63
Increase.....	12.92	11.76	10.66	8.44	5.35	3.33	2.14	1.99	7.07
Aug. 24, 1906	8.33	7.63	8.42	9.66	11.30	10.75	9.59	7.93	9.20
May 1, 1907	18.17	16.73	17.96	16.88	16.59	16.25	14.98	13.48	16.38
Increase.....	9.84	9.10	9.54	7.22	5.29	5.50	5.39	5.55	7.18

It will be noted that the increase of moisture amounted to eight inches for the eight feet of soil. Water storage in a soil is impossible when a crop of weeds is growing.

System of Cropping.—There can be no continuous cropping in dry-land agriculture as in humid regions, because the rainfall is not usually sufficient to grow two crops in succession. However, if the rainfall of two seasons can be used for growing a single crop, profitable results may be obtained. The conservation of this moisture from one season to the next is the most important problem in this kind of agriculture. The possibilities of raising grain under dry farming methods are seen in figures 108, 109 and 110.

Continuous Cropping vs. After Fallow. Average Results for All Years Tested, Montana Station⁷ (Bushels Per Acre)

Sub-station	Kubanka spring wheat		White hulles. barley		Sixty-day oats	
	Con- tinuous	After fallow	Con- tinuous	After fallow	Con- tinuous	After fallow
Dawson County.....	15.18	17.57	15.97	20.90	31.17	51.00
Rosebud County.....	16.98	20.80	15.02	28.31	30.31	40.03
Yellowstone County.....	7.73	19.32	14.90	20.33	13.75	47.94
Chouteau County.....	14.18	17.35	13.29	11.95	28.90	34.56



FIG. 108.—Turkey Red Fall Wheat, without irrigation, yield 58 bushels per acre. (Montana Station, Bul. 74.)

FIG. 109.—White Hulless Barley on land continuously cropped.

FIG. 110.—White Hulless Barley on land fallowed the previous year. (Bul. 74, Montana Station.)

The results show that fallowing gives considerable increase over continuous cropping. The longer this is continued the greater the difference. Whether alternating crops with summer tillage is profitable will be determined largely by local soil and climatic conditions that influence the cost of production.

Summer Tillage With Alternate Cropping vs. Continuous Cropping, North Dakota Station (Bushels Per Acre)*

Station	Treatment	Wheat	Oats	Barley	Corn*
Edgeley.....	{ Continuous.....	13.2	26.8	17.0	3610
	{ Summer tillage....	14.8	42.5	20.0	3400
Dickinson.....	{ Continuous.....	15.6	30.8	25.5	3750
	{ Summer tillage....	27.8	51.1	32.5	2880
Williston.....	{ Continuous.....	14.2	29.5	16.1	6890
	{ Summer tillage....	19.8	46.0	28.8	7370
Hettinger.....	{ Continuous.....	11.2	34.8	23.7	5840
	{ Summer tillage....	21.5	48.6	31.8	5540
Average increase for Summer tillage.....		7.5	16.6	7.7	-225

*Pounds.

It will be seen from this table that summer tillage gave an increase for wheat, oats and barley, but best results were obtained for corn by continuous cropping.

Crops for Dry Farming.—In no kind of agriculture is the adaptation of the crop to the environment of greater consequence than in dry farming. In general, the crops should be such that a maximum growth is secured with minimum water requirements, and the crops that meet this condition will be best adapted to dry-land agriculture. Alfalfa is an exception, but its deep-rooting character has fitted it for securing a large amount of water. Most crops have the power of adapting themselves to some extent to the conditions of climate after a few years, but the dry-land farmer needs a variety of crops that have been tried and developed by selection so that they resist the unusual conditions to which they are subjected. Upon the selection of the crop and seed may depend the success or failure of his efforts.

(a) **Wheat** is the principal crop for the dry-land farmer. All over the arid and semi-arid regions wheat has proved to be one of the best drouth-resistant crops that can be grown. In the dry-land regions of other continents wheat has been grown for many centuries, and certain varieties have been developed which are well

adapted to arid conditions. Both spring and winter wheats are grown, the latter being much more desirable where the climate is suitable. Spring wheats are grown largely from Nebraska north through the Dakotas because of the severe winters. Two varieties of spring wheat are grown, the common spring wheat and the Durum or Macaroni. The latter was introduced from Russia and has proved to be an excellent variety. The semi-hard winter wheats are grown over extensive areas, the most hardy varieties being Turkey Red, Kharkof and Crimean, all originating in semi-arid Russia.

The yield of wheat on the dry farm is of a great deal of consequence because it is the chief money crop. Winter wheat yields better than spring wheat. It usually pays to grow either on summer tilled land. In the dry-farm experiments in Montana the average yield of Turkey Red was 37.7 bushels per acre, while the spring wheat, Kubanka, was 18.4 bushels, or about half as much. In Utah Turkey Red produced 28.1 bushels, while the best spring wheat for the same years produced 14.6 bushels per acre.

(b) **Oats** are beginning to be recognized as a good dry-land crop, either for hay or grain. Of the spring varieties the Sixty Day has proved to be best, principally because it ripens two weeks earlier than other varieties. A winter variety, the Boswell, that has been tried in Utah, promises well. In 1907 and 1908 Sixty Day oats yielded 42.3 bushels per acre, while the Boswell gave 40.1 bushels. At the Montana Station the yield of Sixty Day was 37.6 bushels.

(c) **Rye** is one of the best dry-land grains. It resists drouth better than almost any other cereal. The fall rye at Montana yielded 28.5 bushels per acre. The most serious objection to it is its persistence in the field after once seeded. It may be used to good advantage as a green manure.

(d) **Barley** is one of the cereals well adapted to dry-land if seeded very early in the spring so that it gets a good start before the dry, hot weather begins. The hullless varieties seem to do best. In Montana as an average of all tests on different fields the yield of the White Hullless was 17.8 bushels per acre, while the California yielded one bushel more. In North Dakota an average of 23.8 bushels was obtained. One winter variety has been grown.

(e) **Corn** has not been grown very extensively on dry-land farms because it is not well adapted to the temperature conditions found in arid regions. Corn does best where the nights are warm, and in arid regions the radiation is so great as to lower

the temperature very much during the night. Corn has comparatively low water requirement and produces more dry matter for the water used than almost any other crop. Several strains have been developed that resist drouth well. When acclimated seed is used, seed bed properly prepared and the crop well cultivated, a failure rarely ever occurs. In almost every season sufficient fodder is produced to pay for the crop, and in the more favorable years good yields of grain are obtained. Its principal value lies in the forage it produces. Figure 111 shows corn grown



FIG. 111.—Corn grown on dry-land farm. Note low stalks. Utah.

on a dry-land farm. The stalks are not so coarse as in humid areas and make better feed.

(f) **Spelt and Emmer** have been recommended as crops well adapted to semi-arid conditions. They were imported from Russia, where they have been grown quite extensively as feed for stock. They are very closely related to wheat, but the hull remains attached as with barley.

(g) **Sorghum** is one of the principal drouth-resistant crops and yields as much as seven tons per acre. Its chief use is for forage.

(h) **Kafir and Milo Maize**.—These are well adapted to the Great Plains south of Nebraska and parts of California. The temperature of the higher altitudes is too low for its growth. These

are used both for forage and grain. In the southern part of the Great Plains in Kansas, Oklahoma, Texas and New Mexico these form a very important crop. Jardine⁹ states that the average yield of shelled grain from milo maize was 40 bushels per acre in the Panhandle of Texas.

Where a severe drouth occurs these crops stop growing but remain alive. They start quickly again when rains come.

(i) **Alfalfa**.—No crop has been of greater value on the irrigated land of the West than alfalfa, and it is proving to be a very valuable crop on the dry-land farm as well. It is, however, very difficult to start under arid conditions. The fact that the roots penetrate to such a great depth in these dry-land areas makes it



FIG. 112.—Dry-farm potatoes. Utah.

adapted to using the moisture stored to a great depth in the sub-soil, and no single season's drouth will affect it seriously after it becomes thoroughly established in the soil. Thick seeding must be avoided. It is better adapted to light and medium soils than to heavy clays. Cultivation is as essential in growing alfalfa as for any other crop. The seed crop is one of the most profitable of the alfalfa field. For producing seed it is best to plant the alfalfa in hills or rows so that it may be cultivated. It may be necessary to thin it to one plant every six to twelve inches. The second crop is usually left for seed, the amount of seed produced varying from 150 to 300 pounds per acre.

(j) **Potatoes** (Fig. 112) are coming to be looked upon as one of the staple crops of dry-land agriculture. With a rainfall of 12 inches or more potatoes produce excellent crops, both in yield and

quality. An average yield of 123 bushels per acre was produced on the Montana Experiment stations in the dry-farming areas.

Seeding.—In semi-arid regions seeding must be done more carefully than in humid regions. A deep mellow seed bed must be thoroughly prepared and too much work cannot be expended upon it. The seed bed should be such as to act as a storage reservoir for water and sufficiently compact so that the moisture will be near the surface to germinate the seed. After the seed is planted or during the process of planting the soil should be compacted around the seed. For this reason the press drill should be used quite generally in seeding. It permits uniform distribution and covering of seed. Broadcast seeding invites failure.

*Yields of Lofthouse Wheat With Different Methods of Seeding,¹⁰ Utah Station
(Bushels Per Acre)*

County	Method of seeding	1904	1905	1906	1907	1908	Average
Tooele...	Broadcast.....	12.5	5.5	15.0	16.0	15.3	12.9
	Drilled.....	15.2	13.5	16.4	27.5	24.9	19.9
	Cross drilled..	13.5	13.0	13.3	19.9	19.2	15.9
Juab....	Broadcast.....	16.7	13.9	25.6	8.6	12.9	15.6
	Drilled.....	24.5	16.9	33.5	37.6	33.4	29.2
	Cross drilled..	18.0	8.5	24.4	30.0	11.9	18.6

From the preceding table it will be seen that the drilled wheat gave an increase of 7.0 bushels in one case and 13.6 bushels in another over the broadcasted.

On semi-arid land it might be supposed that deep seeding would be necessary. The depth must depend upon the character of the soil and the amount of moisture it contains. In heavy clay planting should be from one to one and one-half inches, while planting in sandy loams may be as deep as three inches. Where wheat was planted three inches deep in heavy clay the yield for an average of five years was 18.3 bushels, while where the planting was done at one and one-half inches the yield was 26.9 bushels per acre.¹¹

The amount of seed to the acre should be a little more than half that required in humid regions. A heavy seeding results in almost certain failure. It very frequently happens that the moisture in the soil will be sufficient to start the plants of a light seeding in fine shape, while those of a heavy seeding would all be stunted.

The Colorado Station recommends the following amounts, although this may vary with the condition of the soil:

*Pounds of Seed Per Acre for Different Crops*¹²

Crop	Pounds per acre	Crop	Pounds per acre
Wheat.....	30 to 40	Milo maize for grain....	5 to 8
Barley.....	35 to 50	Dwarf Essex rape.....	3 to 5
Flax.....	20	Brome grass.....	20
Spelt and emmer.....	45	Alfalfa for hay.....	12 to 20
Millet.....	10	Alfalfa cultivated for seed	2 to 3
Sorghum for forage.....	25	Sweet clover.....	20 to 25
Kafir corn for forage....	25 to 30		

Corn, single grains, 15 to 18 inches apart.

Merrill of Utah recommends that oats and barley be seeded at the rate of three pecks per acre; rye, two pecks; alfalfa, six pounds, and other crops in proportion.

Acclimated Seed.—The seed to be planted on a dry-land farm should have been grown under semi-arid conditions. Farmers from humid regions frequently take seed with them when they go on the dry farm and crop failure results. Usually several years are required for a crop from humid regions to become thoroughly adapted to its new conditions so that it will produce well. It is far better for the farmer to obtain seed already accustomed to dry conditions.

QUESTIONS

1. Upon what three things does the adaptation of land for dry farming depend?
2. What conditions of soil are best? What are objectionable?
3. From the standpoint of water requirements, what are some of the good crops for dry farming?
4. How does cultivation lessen the water requirement of crops?
5. Why do crops on summer fallow produce more than where cropped continuously?
6. What conditions in arid regions make a large run-off possible?
7. What conditions allow a large evaporation?
8. What is the most desirable depth to plow in dry farming?
9. Why is fall plowing more desirable under dry-farm conditions?
10. Give the advantages in the use of the subsurface packer.
11. To what extent may the fall and winter rain and snowfall be stored in the soil for crops?
12. What about weeds on a dry-land farm?
13. How does transpiration vary?
14. What important points should be observed in selecting crops and seed for the dry farm?

15. Give the advantages of wheat for the dry-land farm.
16. Why is a fall or winter variety more desirable than a spring-sown one?
17. What special advantages has corn for semi-arid regions?
18. Why is alfalfa a good dry-land crop? How is a seed crop produced?
19. What precautions must be taken in seeding the crop in dry-land farming?
20. What is meant by acclimated seed? Why is it important?

REFERENCES

- ¹Widtsoe, J. A., *Dry Farming*, 1911, p. 132.
- ²Briggs, L. J., and Shantz, H. L., *Journal of Agricultural Research*, vol. III, No. 1, 1911, pp. 58-60.
- ³Wiltsoe, J. A., *Dry Farming*, 1911, p. 185. *Principles of Irrigation Practice*, 1914, p. 141.
- ⁴Rotmistrov, V. G., *Nature of Drought*, English edition, 1913.
- ⁵Merrill, L. A., *A Report of Seven Years' Investigation of Dry Farming Methods*, 1910, p. 133.
- ⁶Widtsoe, J. A., *Dry Farming*, 1911, p. 114.
- ⁷Atkinson, A., and Nelson, J. B., *Bulletin 74*, Montana Station, 1908, p. 83.
- ⁸Thysell, J. C., and others, *Bulletin 110*, North Dakota Station, 1915, pp. 183-185.
- ⁹Jardine, W. M., *Circular 12*, Bureau of Plant Industry, U. S. D. A., *Dry-Land Grains*, 1908, p. 6.
- ¹⁰Merrill, L. A., *Bulletin 112*, Utah Station, *A Report of Seven Years' Investigation of Dry Farming Methods*, 1910, p. 139.
- ¹¹Op. Cit., p. 138.
- ¹²Cottrell, H. M., *Bulletin 145*, Colorado Station, *Dry-Land Farming in Eastern Colorado*, 1910, p. 23.

General References.—Olin, W. H., *Bulletin 103*, Colorado Station, *The Thorough Tillage System for the Plains of Colorado*, 1905. Failyer, G. H., *Farmers' Bulletin 266*, U. S. D. A., 1906. Jardine, W. M., *Bulletin 100*, Utah Station, *Arid Farming Investigations*, 1906. Scofield, C. S., *Bulletin 103*, Bureau of Plant Industry, *Dry Farming in the Great Basin*, 1907. Campbell, H. W., *Soil Culture Manual*, 1907, Lincoln, Neb. Nelson, Elias, *Bulletin 62*, Idaho Station, *Dry Farming in Idaho*, 1908. Burr, W. W., *Bulletin 114*, Nebraska Station, *Storing Moisture in the Soil*, 1910.

CHAPTER XXI
 CONTROL OF MOISTURE
 IV. IRRIGATION

IRRIGATION may be practiced in any region where the normal rainfall is not sufficient to grow maximum crops or where the rainfall is deficient during any part of the season. The profit realized will depend upon the crop grown, the increase in yield over no irrigation, the cost of applying water, and the price of the crop. The practice is usually confined to arid regions because irrigation is absolutely necessary under those conditions to produce any crop whatever, or to semi-arid regions where irrigation will give larger yields and in some very dry years would insure a crop where otherwise there would be none. Irrigation is practiced to a very limited extent in humid climates, even in Florida with from fifty to sixty inches of rainfall and in other states with thirty to forty inches. In these regions water is applied in a very intensive form of agriculture or to special crops which command a high price, thus justifying the expense. In some European countries sewage is sometimes applied to soils, thus furnishing both water and plant food. In China and Japan irrigation is an almost universal practice, even where much of the land receives a fair natural supply of water in a well distributed rainfall.

Some Irrigation Projects in Western United States

	Approximate cost	Acres to be irrigated
Salt River, Arizona.....	\$10,000,000	219,000
Yuma, Arizona-California.....	7,000,000	130,000
Uncompahgre, Colorado.....	5,000,000	140,000
Boise, Idaho.....	8,700,000	243,000
Minidoka, Idaho.....	4,400,000	118,000
Flathead, Montana.....	1,250,000	152,000
Milk River, Montana.....	1,060,000	219,000
Sun River, Montana.....	1,000,000	216,000
North Platte, Nebraska-Wyoming.....	16,200,000	129,000
Shoshone, Wyoming.....	3,800,000	164,000

The area of land that may ultimately be brought under irrigation is small in comparison with the total dry-land area, because the total supply of water is not sufficient for more than one-tenth of the dry land. At present only about one per cent of the land in the western states is irrigated. The building of such reservoirs as are given in the preceding table is extending the irrigated area more than was supposed to be possible a few years ago.

Area and Projects.—In 1909, 13,739,499 acres of land were irrigated in the arid states. This was an increase of 82 per cent in ten years. In 1910 the projects, then started, will be capable of irrigating 19,335,711 acres when fully under way. The total area included in the projects is 31,112,110 acres. In addition to the

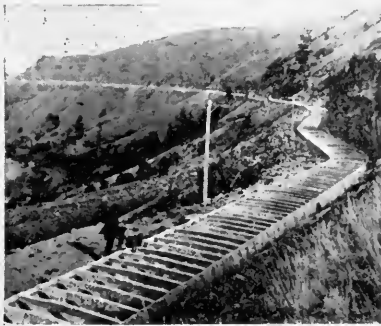

FIG. 113.



FIG. 114.

FIG. 113.—Conduit for conducting water to where it may be used for irrigation. (U. S. Reclamation Service.)
 FIG. 114.—Concrete-lined canal that permits no loss by seepage. (U. S. Reclamation Service.)

above, 724,800 acres of land were irrigated in humid areas, nearly all of which was for the growing of rice.

The United States Reclamation Service, established in 1902, was to use the money from the sale of public lands in the arid states in the construction of irrigation systems. Under the direction of Dr. F. H. Newell immense projects have been started, many of which have been completed, and by which large areas have been reclaimed and added to the country as some of its most valuable assets.

Sources of Water.—(a) **Diversion of Streams.**—The common source of water for irrigation has been the diversion of parts of streams at a height above where it is to be used and conducting it by means of canals, tunnels, conduits and ditches to where it is to be distributed over the land (Figs. 113 and 114).

Water is sometimes conducted for many miles, passing through hills and over valleys and gorges. In the case of the Gunnison tunnel of Colorado, the Gunnison river is diverted from its course and carried through a tunnel almost six miles long, pouring into the Uncompahgre Valley, where it is used to irrigate 140,000 acres.

(b) **Reservoirs.**—In many places in the arid regions of this and other countries dams have been built across gorges or narrow valleys, producing lakes or reservoirs whose water is used in the irrigation of tillable land farther down the valley. In this way the rains and snows of winter, which would otherwise be lost, are held for the use of crops at a time when the water of the stream is entirely insufficient for the purpose. The Roosevelt dam across the Salt River in Arizona is a good illustration (Fig. 115). Here sufficient water is stored for irrigating 219,000 acres. This dam, curved upstream, is 284 feet high and 910 feet long, with a thickness at its base of 168 feet and 20 feet at the top. It forms a lake or reservoir 25 miles long and from one to two miles wide and contains 1,367,000 acre-feet of water. Many similar systems have been constructed by the government, or are under way, that will irrigate from 10,000 to 225,000 acres each, making a total of over 3,000,000 acres irrigated by these projects (Fig. 116).

(c) **Pumping from Some Subterranean Supply.**—In some localities in arid regions extensive underground reservoirs of water occur sufficiently near the surface to be pumped for irrigation purposes. In other regions artesian wells may furnish a bountiful supply. Where irrigation is practiced in humid regions pumping is the usual method. The rice fields of Arkansas and Louisiana are irrigated in this way.

(d) **Pumping from Streams or Canals.**—In Egypt, India, China and Japan much of the water for irrigation is pumped on the land by means of hand or foot power. Sometimes cattle or donkeys are used for this purpose.

Preparation of the Land for Irrigation.—The first step in preparing the land for irrigation is the removal of the vegetation (Fig. 117). The character of this varies with the amount of rainfall from stunted grass, sage brush, greasewood, and mesquite to the remains of heavy forests. The cost of clearing varies from two to five dollars per acre for most lands to as much as one hundred and fifty dollars per acre for forests. After the vegetation is removed the land must be graded so that the water may be uniformly applied. Many tracts are so flat that very little grading is necessary.

FIG. 115.

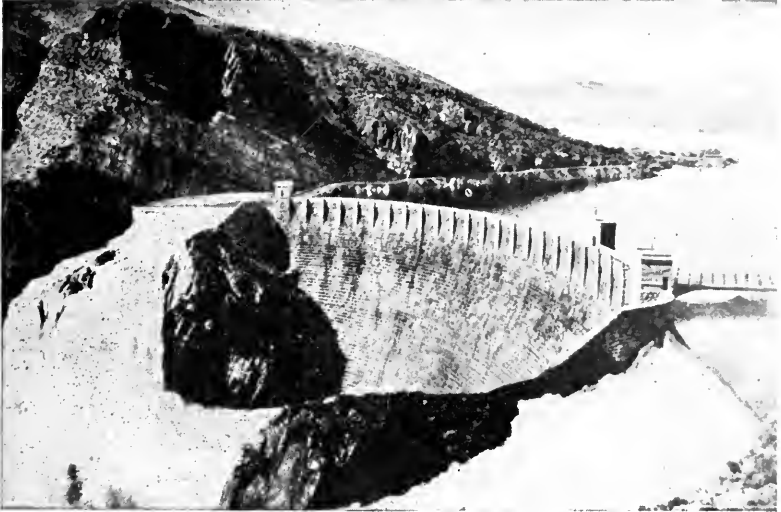

FIG. 116.

FIG. 115.—Roosevelt Dam, Salt River, Arizona. (U. S. Reclamation Service.)

FIG. 116.—Granite Reef Diversion Dam; Salt River Project, Arizona. (U. S. Reclamation Service.)

Usually there are depressions to be filled or slight elevations to be removed. The object is not to level the land, but to reduce

FIG. 117.



FIG. 118.

FIG. 117.—Desert lands and Homestead, Huntley Project, Montana. (U. S. Reclamation Service.)

FIG. 118.—Wheat field, Minidoka Project, Idaho. Yield 60 bushels per acre. (U. S. Reclamation Service.)

it to a uniform slope so that water will spread over it uniformly (Fig. 118).

Character of Water Used for Irrigation.—In humid regions

the water of streams carries but little soluble material, but in arid and semi-arid regions, where the great necessity for irrigation exists, both soil and water may contain alkali in considerable abundance. While the excess of alkali in irrigated lands is due usually to the salts in the soil, yet it is in many cases due in part, and sometimes wholly, to the salinity of the water which is being used for irrigation. The salts thus carried accumulate in the soil, producing very injurious results. Forty grains of salts per gallon is usually assigned as the limit for irrigation waters. This, however, depends upon the character of the substances in solution. In California the limit lies in all cases below 70 grains. The danger of using irrigation water containing considerable salts depends very largely upon the drainage of the land irrigated or the methods of preventing their accumulation.

*Suspended Matter in River Waters*¹

River	Parts per million	
	Minimum	Maximum
Belle Fourche, at Belle Fourche, South Dakota.....	56	7,120
Bighorn, at Fort Custer, Montana.....	18	2,860
Colorado, at Yuma, Arizona.....	741	30,800
Red, at Mangun, Oklahoma.....	0	16,800
Gunnison, at Whitewater, Colorado.....	32	4,090
Pecos, at Carlsbad, New Mexico.....	0	1,480
Pecos, at Dayton, New Mexico.....	44	11,400
Rio Grande, at El Paso, Texas.....	8	83,900
Salt, at Roosevelt, Arizona.....	40	6,940
North Platte, at Laramie, Wyoming.....	62	3,450

Many streams whose waters are used for irrigation carry more or less material in suspension which becomes a very important factor in maintaining the fertility of the soil. The amount of sediment carried in suspension by various streams is given in the above table.

Composition of River Sediments.—Many river sediments have been analyzed in the United States, in Europe, and in Egypt. The results show that river muds are somewhat richer in the essential plant food elements than the ordinary fertile soils from which the water comes. It has been estimated by Forbes that the market value of the fertilizing constituents in three samples of Salt River mud, to the acre-foot of water, varied from \$7.98 to \$25.51.² When the fertilizing value of these sediments is considered in connection

with the value of the dissolved materials, one of the great advantages of irrigation is made evident. By this addition of plant food from year to year cropping may continue indefinitely without depleting the soil. Some streams are exceptions to this rule, however.

Time of Irrigation.—The irrigation of crops may take place at various times, depending upon the crop grown and the object to be accomplished. Theoretically the soil should be supplied with just sufficient water to maintain optimum conditions for growth and maturity. This is a condition to be desired, whether ever attained or not; however, this is rarely possible, since the supply of water frequently runs so low that during part of the growing season it is not adequate for the purpose.

Irrigation may be done either when the crop is not growing, in the fall, winter or early spring, or when the crop is growing during the summer. In the former case the object is to obtain the water when the demand for it is not so great and store it in the soil for use the next season. It may be done immediately after harvest and from then till spring. Winter irrigation is not advisable when the soil is frozen, as much of the water may be lost, but where the winters are mild it may be practiced to good advantage.

Alfalfa and wheat should not be flooded during the winter in cold climates.

Irrigation water may be applied early in the spring to save some of the water of the spring floods caused by the melting snows of the mountains. This would be largely lost unless reservoirs have been built to store it for summer use. The time and frequency of irrigation depend upon the crop. In Arizona orchards receiving fall and winter irrigations have produced well without any further application of water. Alfalfa should be irrigated several times, a few days before cutting and again soon after the crop has been harvested. Wheat and other small grains, beans and peas if planted in a soil well filled with moisture need little or no irrigation till flowering time. This permits a good root system to develop. Early irrigation lessens the proportion of grain to straw.

Amount of Water to Apply.—As a general rule the more water that is applied to a soil, within practical limits, the larger amount of dry matter it produces. The problem is not to go beyond the point of most profitable returns. This point has not yet been determined. It is very difficult of determination, since it varies with the crop, the soil, rainfall and other conditions.

Usually more water is applied than is necessary and certainly

Yields of Dry Matter in Pounds Per Acre with Varying Quantities of Irrigation Water*

Irrigation water applied, inches	5.00	7.50	10.00	15.00	20.00	25.00	30.00	35.00	40.00	50.00
Wheat:										
Rainfall and soil water (inches).....	13.74	13.74	13.74	13.74	13.74	13.74	13.74	13.74	13.74	13.74
Total yield of dry matter.....	4969	5545	5684	6279	6672	6672	7229	7229	7999	7999
Yield per inch of irrigation water.....	994	739	568	419	267	267	207	207	160	160
Yield in bushels per acre.....	37.81	41.54	43.53	45.71	46.46	46.46	48.55	48.55	49.38	49.38
Oats:										
Rainfall and soil water (inches).....	9.66	9.66	9.66	9.66	9.66	9.66	9.66	9.66	9.66*	9.66*
Total yield of dry matter.....	5581	5116	6623	7501	7501	7501	7925	7925	7925	7925
Yield per inch of irrigation water.....	1116	512	442	375	375	375	176	176	176	176
Yield in bushels per acre.....	62.28	54.76	71.54	80.70	80.70	80.70	79.06	79.06	79.06	79.06
Corn:										
Rainfall and soil water (inches).....	5.54	5.54	5.54	5.54	5.54	5.54	5.54	5.54	5.54	5.54†
Total yield of dry matter.....	10757	12762	13092	13856	13856	14606	15294	15294	15294	12637
Yield per inch of irrigation water.....	1434	1276	873	693	693	584	510	510	230	230
Yield in bushels per acre.....	79.14	89.52	93.93	91.58	91.58	99.16	97.12	97.12	96.78	96.78
Alfalfa:										
Rainfall and soil water (inches).....	14.91	14.91	14.91	14.91	14.91	14.91	14.91	14.91	14.91	14.91
Total yield of dry matter (3 crops).....	9094	6942	8369	8006	8006	8006	8133	8133	9949	9949
Yield per inch of irrigation water.....	909	463	418	344	344	344	271	271	199	199
Sugar Beets:										
Rainfall and soil water (inches).....	10.25	10.25	10.25	10.25	10.25	10.25	10.25	10.25	10.25	10.25
Total yield of dry matter.....	6080	8053	8636	10076	10076	10076	10271	10271	11528	11528
Yield per inch of irrigation water.....	1216	805	576	504	504	504	342	342	231	231
Yield in tons per acre.....	13.78	18.63	19.45	21.28	21.28	21.28	20.82	20.82	24.54	24.54
Potatoes:										
Rainfall and soil water (inches).....	6.17	6.17	6.17	6.17	6.17	6.17	6.17	6.17	6.17†	6.17†
Total yield of dry matter.....	2310	2730	2925	3405	4005	4005	3660	3660	3795	3795
Yield per inch of irrigation water.....	462	364	293	227	200	200	122	122	84	84
Yield in bushels per acre.....	154	182	195	227	267	267	244	244	253	253

* In oats was 45 inches.

† In corn was 55 inches.

‡ In potatoes was 45 inches.

more than is economical. In the table the additional amounts of water applied gave an increase in the total dry matter produced, yet the increase of dry matter per acre-inch of water decreased. The increase obtained was not always profitable. It will be noted that the yield of wheat is 37.8 bushels per acre where five inches of water were applied, while 7.5 inches gave a yield of 41.5 bushels, or an increase of 1.5 bushels per acre-inch. When 2.5 inches more were added the increase was 0.8 bushel per acre-inch, and when five inches more were applied the increase was 0.4 bushel per acre-inch. The next ten inches gave less than one-tenth of a bushel increase per acre-inch. It is very evident that the point of profitable application of water has been passed.

The Producing Power of 30 Acre-Inches When Applied to Different Areas of Land¹

30 Acre-inches spread over					
Crop	One acre 30 inches deep	Two acres 15 inches deep	Three acres 10 inches deep	Four acres 7.5 inches deep	Six acres 5 inches deep
Wheat:					
Grain, bushels.....	47.51	91.42	130.59	166.16	226.86
Straw, pounds.....	4533	7908	10356	13204	17916
Corn:					
Grain, bushels.....	97.12	187.86	268.56	316.56
Stover, pounds.....	10390	16558	18021	28756
Timothy:					
Hay, pounds.....	6054	7688	11739	11928
Sugar beets:					
Tons.....	20.82	38.90	55.89	64.84	82.68
Potatoes:					
Bushels.....	195	373	456	544	691
Alfalfa:					
Hay, pounds.....	8840	15093	26653

The one object to be kept in mind in irrigation is to grow the maximum amount of dry matter with an acre-inch of water. Experiments show that 10 to 20 inches is the most practicable amount to apply. Larger amounts lower the quality of the grain and do not give proportionate increases.

The above table shows the value of small applications over more extensive areas in comparison to the same application on smaller areas.

*Returns from Sugar Beets Where 30 Acre-Inches are Distributed Over Different Areas*⁵

30 acre-inches spread over	Inches of water on each acre	Yield of beets per acre (tons)	Total yield of beets (tons)	Price per ton	Gross returns	Total cost	Net returns
1 acre.....	30.0	21.0	21	\$5	\$105	\$ 60	\$ 45
2 acres.....	15.0	19.5	39	5	195	120	75
3 acres.....	10.0	18.6	56	5	280	180	100
4 acres.....	7.5	16.3	65	5	325	240	85

From the above table it will be seen that 30 acre-inches spread over three acres gives the greatest net returns. The results of the Utah Station indicate that where the annual rainfall is 12 to 15 inches an application of 10 to 20 inches is sufficient for ordinary crops, and the best amount lies near the lesser quantity. Dr. F. H. Newell is of the opinion that 12 acre-inches is sufficient to produce good crops of all kinds except alfalfa and a few other similar crops.

Loss of Water from Canals.—It is everywhere agreed that a very large part of the water diverted from streams is lost before it reaches the place where it is to be applied to the land. It is estimated that 5.77 per cent of the water is lost for each mile of canal through which it is carried. This means that all the water would be lost in 17 miles. The loss is caused by evaporation and seepage. The canals pass over all kinds of soil, both porous and impervious. Large amounts are lost where the canal passes over gravelly or sandy soil. This seepage water not only does very little good, but in many cases does much harm by causing the water table to rise injuriously near the surface and also brings up the alkali. Some expedients are used to diminish this loss. The soil is sometimes puddled by dragging chains in the bottom of the canals (Fig. 119), thus rendering the soil less pervious. The bottom and sides of canals are sometimes covered with crude oil to lessen leakage. The large canals are sometimes lined with concrete (Fig. 114), which limits the loss to the evaporation. Even fine soil constituents, such as clay or silt, have been used for lining the canals to render them less pervious. This is accomplished in part by the sediment carried by water.

It is estimated that in India the loss is from 20 to 75 per cent from the canals. The investigations of the Department of Agriculture in this country show that nearly 60 per cent of the water is lost between the head gates and the laterals and a considerable portion of the remaining 40 per cent is lost before it reaches the land

to be irrigated. Fortier says that less than one-third of the water diverted from the streams is actually used by the crops.

The Duty of Water.—"The duty of water," a term long since coined, means the quantity of water needed to mature crops. It may be expressed in various ways. Sometimes the duty of water is expressed as the number of pounds of water required to produce one pound of the dry matter of the crop; under other conditions, as the depth of water over the field required during the growing season to produce the crop.

More commonly, however, the duty of water is expressed as the number of acres that may be irrigated by a definite quantity of water, say a second-foot, flowing continuously through the growing season.⁶ A second-foot of water means that a cubic foot of water is

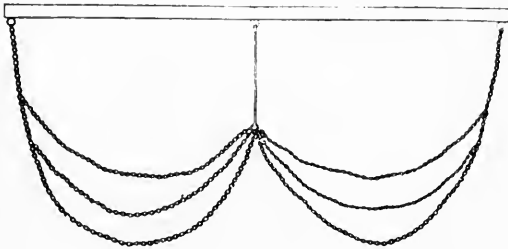

FIG. 119.—Chains for puddling the mud of canals to prevent seepage.

delivered each second and may be easily reduced to acre-feet or acre-inches, since at this rate an acre-inch will be delivered each hour.

The *absolute* duty of water is the total amount that the crop receives by irrigation, by rainfall, and that contained in the soil. It is expressed as acre-inches. The *net* duty of water is the amount actually delivered to the farmer through his head-gate.

One second-foot serves to irrigate from 25 to over 300 acres during the growing season. An average is from 75 to 100 acres. If the acreage irrigated by a second-foot is small, the duty of water is low, while if the acreage is large the duty is high.

The duty of water varies with several factors: (1) The rainfall varies in irrigated regions from almost nothing to 30 or 40 inches. The acreage irrigated by a second-foot will necessarily vary with the rainfall. (2) Soils that are quite porous will require more water for the crop than the less pervious ones, since much will be lost by percolation. Even hardpan soils require more water than

those of uniform texture. (3) Different crops require different amounts of water. Forage crops, especially alfalfa, require more water than cereals. (4) A fertile soil requires less water than a run-down soil. (5) The amount of water required depends to some extent upon the amount of water applied and the means taken to conserve it.

Duty of Water in Different Countries.—Irrigation is practiced on all continents. The duty of water in Egypt is 115 acres for cotton and other dry crops and 60 acres for rice. This is for an irrigation period of 75 days. In southern Africa, where the annual

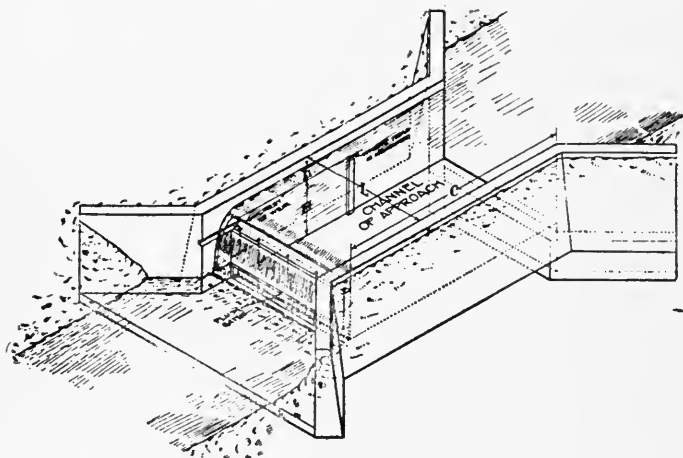

FIG. 120.—Rectangular weir.

rainfall is from 20 to 35 inches, the duty of water is, for vegetables 100 to 180 acres; for cereals 140 to 200 acres; for sugar cane 50 to 75 acres. In India the duty from June to October is 80 to 170 acres, while from November to March it is 90 to 200 acres. Under some canals 160 acres have been adopted as the normal duty.

In Europe the duty is somewhat higher than in most countries, because of higher rainfall. The average for Spain is 172 acres, while that for France, Spain and Italy is 239 acres. Investigations in North America show that the duty of water is about 100 acres for an irrigation season of 90 days.

Measurement and Distribution of Water.—Since water is a thing of such great value in irrigation, its measurement becomes a

necessity to protect the farmer who is the purchaser or consumer and the company that furnishes the water. Many devices have been used, but the most common and most satisfactory is the weir or overfall (Fig. 120). The weir should be installed where the canal is long, straight and level. A box is placed in the canal so that all water must flow through it. A board with a notch is placed in the box and across the stream. This notch may be several inches or even

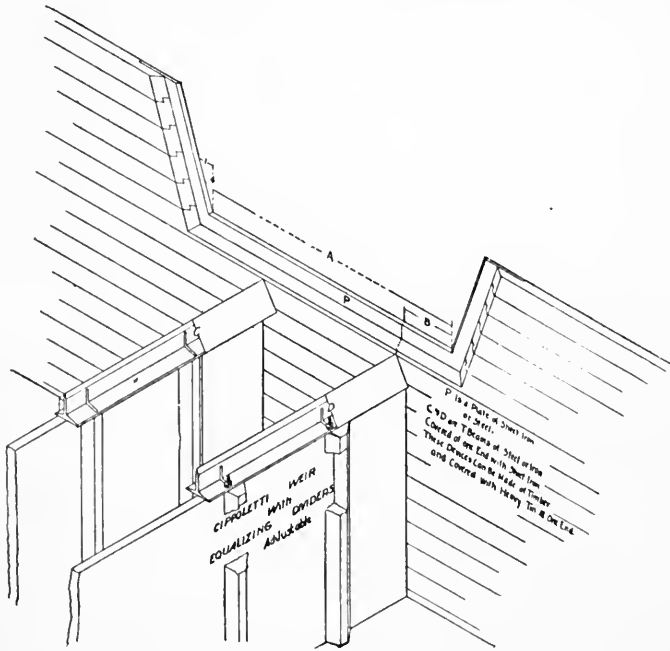

FIG. 121.—Trapezoidal or Cippoletti weir, showing method of dividing the stream. (Utah Agricultural Experiment Station.)

several feet long and the depth of water flowing through this may be easily measured and the total amount determined from a table. These notches may be either rectangular, trapezoidal, or triangular. The trapezoidal is coming into most general use.

For purposes of distribution to different laterals the streams are frequently divided at the overfall by placing a board with a sharp edge so as to separate the stream into two or more parts (Fig. 121). Each part is then conducted off in a separate lateral to the region desired.

Methods of Irrigation.—The manner of applying water to soils determines to a large extent the influence it has both upon the plant and soil as well as the effectiveness of the water itself.

In arid regions two general systems of irrigation are followed, flooding and furrowing, each of which has its advantages under certain conditions. The determining factors are (1) the character of the soil, (2) the amount of water per-unit of time or "head," (3) the contour or lay of the land, and (4) the kind of crop.

(a) **Flooding.**—A common method for applying water is by



FIG. 122.—Basin or check system of irrigating orchards. Principles of Irrigation Practice, Wiltsoe. (Courtesy Macmillan Company.)

flooding the entire area. This requires that the land shall be practically flat and the soil one that does not erode badly nor bake upon drying. Heavy soils are best adapted to this method, so that when the large volume of water is turned on the soil will not wash. If the volume of water is too small it will sink into the soil before it reaches the other side of the field. Alfalfa, pasture and meadow land and wheat and other small grains may be successfully irrigated in this way. Three principal modifications of this method are flooding closed fields, flooding open fields and basin flooding. The *closed-field flooding* or check flooding, as it is sometimes called, is

where a levee or dike is built around the field and into which the water is turned and left till it is all absorbed. This is a common practice in China and Japan. In *open field flooding* a canvas dam is placed in the ditch and the water forced to run over the banks of the ditch into the field. A moderate slope permits it to run slowly over the field where the surplus water runs into another ditch at the lower side.

Basin flooding is practiced in orchards, the levee being thrown up so as to occupy the space allotted to each tree. The water is allowed to enter the enclosure and left till it is absorbed (Fig. 122). Dirt is piled around the base of the tree so the bark will not get wet. This method is gradually passing out of use.



FIG. 123.—Irrigating potatoes by furrows. U. S. Reclamation Service.

(b) **Furrow Irrigation.**—The furrow method of irrigation is one of the most common and for most conditions one of the best methods practiced. Small furrows lead from the supply ditch and the water is absorbed by the soil (Fig. 123). The furrows are from five to ten inches deep and from three to eight feet apart, the distance depending upon the soil and the crop. By this method the irrigator may control the quantity of water and a comparatively small amount may be spread over a large area of land. Only a small amount of the soil becomes wet, so that injury from puddling is not imminent. The furrows may soon be covered and thus reduce evaporation, preventing or retarding the rise of alkali. It is very difficult to obtain uniform distribution, due to the difference in the absorbing power of the soil or length of furrow or both. This

method is specially adapted to inter-tilled crops, such as corn and potatoes, and is used extensively for cereals, alfalfa, and orchards.

(c) **Sub-Irrigation.**—The method of sub-irrigation is practiced only to a very limited extent because of the great initial cost making it almost prohibitive. Iron, concrete or wooden pipes may be used, but digging the trenches for placing these is expensive. The roots clog the openings and in time impair the usefulness of the system.

A form of natural sub-irrigation is practiced in the West where

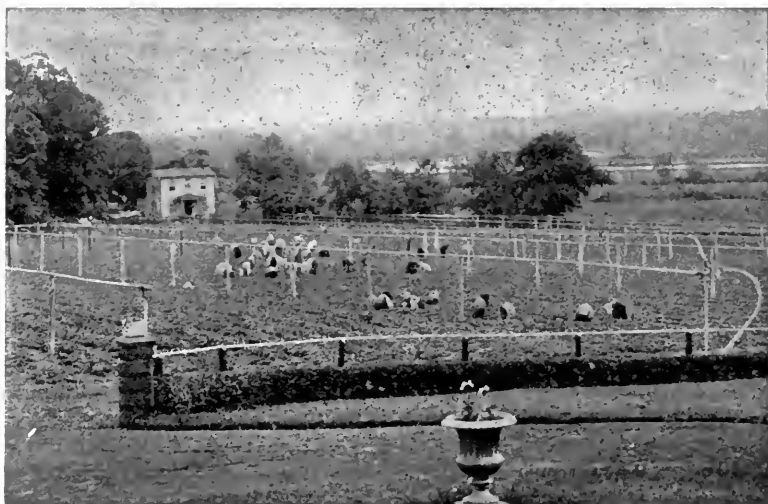

FIG. 124.—Method of irrigating by overhead sprays. Adapted to small fruits and vegetables in humid areas. (Fortier's Use of Water in Irrigation.) (Courtesy McGraw-Hill Book Company.)

the soil is sufficiently porous so that no underground pipes are necessary. Former irrigation has brought the water table near the surface, and now the object to be accomplished is to keep the water table sufficiently near the surface so that capillary water from it will supply the crops. An impervious stratum is necessary at a depth of a few feet. A tract of 60,000 acres is irrigated in this way in the upper Snake River Valley, Idaho. Parts of the San Luis Valley, Colorado, are irrigated in the same manner. The ditches are from 50 to 250 feet apart.

(d) **Surface Sprinkling and Overhead Sprays.**—This method is adapted only to small areas and is one of the most expensive as

well as ineffective ways of applying water. It is distributed under pressure through pipes, the water escaping by means of nozzles or by small openings. It is used principally to supplement the rainfall (Fig. 124) in humid regions where crops of high value, such as vegetables and small fruits, are grown. Usually the application is sufficient to penetrate only to a slight depth, hence it soon evaporates. It has a tendency to produce shallow rooting of the plants. The method has the advantage of easy control, little waste land, and may be used on very uneven land.

Cultivation After Irrigation.—Where possible the irrigated land should be cultivated as soon as the soil is in proper condition. The loss by evaporation following irrigation is enormous, especially where no crop is on the land large enough to shade it. The Utah Station found that where land was not cultivated till seven days after irrigation the loss of water by evaporation was 1.15 inches or 164 tons per acre, while 14 days gave a loss of 1.93 inches or 249 tons per acre, and 24 days gave a loss of 2.7 inches or 307 tons. The cultivation should be as deep as possible under the circumstances. As the result of an experiment a loss of 1.75 inches occurred in 28 days where there was no mulch. When a layer of dry granular soil three inches thick was placed upon the surface the evaporation was reduced to 0.78 of an inch or 57.7 per cent, while a ten-inch mulch practically stopped evaporation.

Crops for Irrigated Lands.—Practically all crops adapted to the climate will grow under irrigation. Some require more water than others, but this is easily adjusted by the applications of water. (Fig. 125.)

Cereals.—*Wheat.*—The best cereal under irrigation is wheat. While it is primarily a crop for dry-land agriculture, yet it yields well when irrigated and is a good crop to fit in with rotations used on irrigated lands, and is grown quite extensively. The amount of water required by wheat depends upon the perviousness of the soil, but in a deep, fertile, well-tilled soil 12 inches will be sufficient. The Utah Station found that an application of 7.5 inches of water gave 11.5 bushels, 10 inches gave 13.5 bushels, and 15 inches gave 15.7 bushels per acre.

Oats.—The growing of oats on irrigated land probably will never become very extensive, although it will be used to some extent to give variety in rotations. It produces well and requires about the same amount of water as wheat.

Barley.—The barley crop is a valuable one under irrigation.

producing well and requiring a less amount of water than other cereals. After an application of 7.5 inches of water little increase was obtained with more. The barley produced under irrigation is of better quality than that produced on dry land.

FIG. 125.

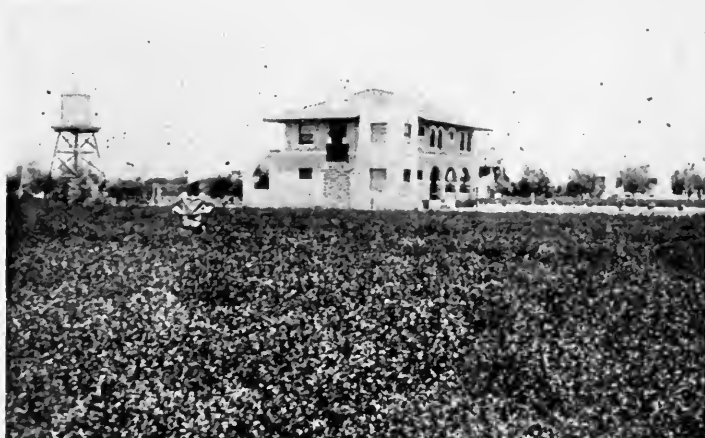

FIG. 126.

FIG. 125.—Mallin Ranch, Salt River Project, Arizona. } U. S. Reclamation
 FIG. 126.—Alfalfa field. Yuma Project, Arizona. } Service

Corn produces more dry matter in proportion to the water applied than almost any other crop. It is not yet grown extensively under irrigation, but its area is increasing, especially in regions where stock raising is a prominent industry. It has a

longer irrigation period than small grains, therefore requires more water. Cultivation after each irrigation is very essential. An application of 25 inches gave 99.1 bushels per acre at the Utah Station.

Rice is a crop that is grown under humid, semi-tropical conditions, but irrigation or flooding is necessary. The check system is used. Levees are thrown up sufficiently high to retain a layer of water to a depth of three to ten inches. The water is nearly always applied by pumping from wells or canals.

Forage Crops.—*Alfalfa* is not only the most important crop for forage purposes, but it is the most valuable of all crops grown under irrigation (Fig. 126). Its value is enhanced by the fact that it is a nitrogen gatherer and actually builds up the soil during its growth.

Water may be applied by furrows, flooding, or by checking. When water is abundant flooding is the method used. If the soil bakes or tends to run together, the furrow method is preferable. In this case the land is marked off or furrowed immediately after seeding and the furrows become permanent. Alfalfa requires somewhat more water than cereals, and 18 to 24 inches should be applied. Fortier found that 30 acre-inches applied to one acre produced 14,400 pounds of hay, while when the same amount of water was applied to five acres 64,100 pounds were produced.

If seed is to be produced but little water should be applied to the growth that is to produce the seed.

Other Forage Crops.—*Timothy*, *orchard grass* and *brome grass* are crops that thrive under irrigation, but are very inferior to alfalfa in this respect. Clover does well under irrigation, but produces much less hay than alfalfa.

The sugar beet is one of the most profitable of irrigated crops. It prefers a deep clay loam soil and dry summers. Three to five irrigations are sufficient and on some soils only two are deemed necessary. From four to six inches are applied at each irrigation.

Potatoes are a very important crop on irrigated land. Their water requirements are somewhat like sugar beets. The furrow method is practiced. Fifteen to twenty-four inches of water should be sufficient.

Peas, beans, melons, tomatoes, onions, cotton, and many other crops may be grown very successfully under irrigation.

Fruits of nearly all kinds may be grown where climatic conditions are right.

Irrigation in Humid Climates.—An annual precipitation of

30 inches or more gives sufficient moisture for producing fair crops of nearly all kinds if the rainfall is distributed properly. Drouthy periods are quite common. At Columbia, S. C., 62 fifteen-day periods with less than one inch of rainfall during the growing season, April to October, occurred from 1900-1909. At Vineland, N. J., 46 periods, at Oshkosh, Wis., 27 periods, and at Ames, Iowa, 23 similar periods occurred during the same time. At the Illinois Station from 1906-1915 there were 49 periods of drouth 15 days long, while 16 were more than 25 days and six more than 30 days in length.

While this uneven distribution indicates that irrigation might be practiced during some years with profit, it is very doubtful, however, whether it will ever be profitable for the ordinary cereals. A four-year rotation⁷ of corn, oats, and clover was followed on brown silt loam, the common prairie soil of the corn belt, for 10 years. Without irrigation a ten-year average yield was 43.5 bushels, while adjoining plots, irrigated when necessary, gave a yield of 49.9 bushels per acre, an increase of 6.4 bushels. During the dry seasons of 1911, 1913 and 1914 the yield of corn averaged 32.3 bushels without and 50.8 bushels with irrigation, an increase of 18.5 bushels. Even with this large increase for dry seasons the average increase is insufficient to pay for irrigation.

Irrigation of truck and some fruit crops, without doubt, could be practiced profitably, and in general the more valuable the crop the more profitable irrigation becomes. Strawberries and bush fruits respond well to irrigation, both with a finer quality of fruit and a longer fruiting period.

QUESTIONS

1. Upon what factors does the profit from irrigation depend?
2. Why is the irrigable area so limited?
3. Look up some of the projects given in the table on page 257.
4. What are the sources of irrigation water?
5. What preparation is necessary before the land can be irrigated?
6. Why should not saline water be used for irrigation?
7. Is the sediment carried in suspension detrimental or not? If beneficial, why?
8. What are the advantages and disadvantages of irrigation when the crop is not growing?
9. May too much water be used in irrigation?
10. What is meant by the "duty of water"?
11. What is a second-foot of water?
12. What is the absolute duty of water? How is it expressed?
13. How much will a second-foot irrigate?
14. What causes this variation?

15. How much water should be applied to a crop?
16. Study carefully the proportionate increase of yield for increased application of water in the table on page 264.
17. Compare the yield per acre where 7.5 inches were applied with that for 30 inches. Did the large application pay?
18. How is water lost from the irrigation canals?
19. What is the significance of this loss?
20. How is this loss prevented?
21. How is the water measured?
22. What are the advantages and objections to surface sprinkling?
23. What is check-flooding?
24. Give advantages of furrow irrigation.
25. Why should the irrigated land be cultivated soon after irrigation?
26. Under what conditions is irrigation in humid climates profitable?

REFERENCES

- ¹Widtsøe, J. A., Principles of Irrigation Practice, 1911, p. 96.
- ²Forbes, R. H., Bulletin 44, Arizona Station, The River Irrigating Waters of Arizona, 1902, p. 160.
- ³Widtsøe, J. A., Bulletin 116, Utah Station, The Production of Dry Matter with Different Quantities of Irrigation Water, 1912. Widtsøe, J. A., and Merrill, L. A., Bulletin 117, Utah Station, The Yields of Crops with Different Quantities of Irrigation Water, 1912.
- ⁴Bulletin 117, Utah, Op. Cit., p. 115.
- ⁵Widtsøe, J. A., Principles of Irrigation Practice, 1911, p. 337.
- ⁶Widtsøe, J. A., Principles of Irrigation Practice, 1911, p. 331.
- ⁷Mosier, J. G., and Gustafson, A. F., Bulletin 181, Illinois Station, Soil Moisture and Tillage for Corn, 1915.

General References.—Fortier, Samuel, Yearbook U. S. D. A., Methods of Applying Water, 1909, p. 293. McLaughlin, W. W., Farmers' Bulletin 399, U. S. D. A., Irrigation of Grain, 1910. Welsh, J. S., Bulletin 74, Idaho Station, Irrigation Practice, 1914. Roeding, F. W., Farmers' Bulletin 392, U. S. D. A., Irrigation of Sugar Beets, 1910. Newell, F. H., Irrigation, 1906.

CHAPTER XXII

ALKALI LANDS AND THEIR RECLAMATION

ALKALI lands are found in all regions of deficient rainfall. They usually occur where the rainfall is less than 20 inches, but in India alkali lands exist even with a rainfall of 28 inches. The effectiveness of rainfall in removing alkali depends upon its character. If the rainfall comes in very heavy showers, as is the case in India, much will run off the surface without entering the soil, and hence will do little toward removing the alkali. A small rainfall coming as gentle showers so that it will enter the soil will be more effective.

The effect, too, of the rainfall depends somewhat upon the character of the soil. Rainfall will penetrate a loose, sandy loam soil much more readily than a clay. Hence, under the same rainfall a clay soil or a clay loam soil may contain alkali, while the sandy loam or sand would be free from it. The amount of evaporation, too, plays a somewhat important part in the amount present. Under conditions of great evaporation the alkali may be brought to the surface, while with less evaporation, as in a more northern climate, the alkali would not be troublesome at all.

Alkali does not usually occur in hill lands, although in small level valleys among hills alkali may be found in considerable amounts. It occurs abundantly in level uplands if the drainage is in any way interfered with. Alluvial lands frequently contain alkali, due to seepage from the upland and also from the water of the stream.

The Origin of Alkali.—In the decomposition of rocks and the further decomposition of soil material, many soluble substances are formed which may not be leached out by the small rainfall of the region but may be brought to the surface by capillary movement. Many of the stratified rocks contained much salt, due to the fact that they were formed in salt or brackish waters. When these became dry land the salt was leached out later and carried into temporary lakes. This accumulation continued and ultimately the lake became dry and a deposit of alkali was left (Fig. 127). Salt springs sometimes occur, the waters of which carry considerable amounts of alkali into depressions, where they may accumulate in large quantities. Whatever the source of the alkali, its existence

is usually due to climatic conditions. It naturally results from a rainfall insufficient to carry soluble material out of the soil, which ultimately becomes so impregnated with it as to be unproductive (Fig. 128).



FIG. 127.—Beginning of an alkali spot (U. S. Dept. of Agriculture.)



FIG. 128.—Alkali area showing the absence of vegetation. (U. S. Dept. of Agriculture)

Kinds of Alkali.—The alkalies of arid regions are commonly classified as black, white, and brown. The black consists of forms of sodium carbonate, which owe their name to the color produced by the solution of organic matter and its deposition on soil particles during evaporation. There are at least two forms of sodium carbonate included in the black alkali, the bicarbonate (HNaCO_3) and the normal carbonate (Na_2CO_3).

The white alkalies are composed mainly of common salt (NaCl) and sodium sulfate (Na_2SO_4), together with some magnesium sulfate (MgSO_4), potassium chloride (KCl), magnesium chloride (MgCl_2) and small amounts of many others. The brown alkali consists of nitrates, which are found only occasionally in damaging quantities. Different alkalies usually occur as mixtures in various and indefinite proportions. A careful study of the following table shows this fact. That from Kern county, number one, contains sodium sulfate principally, but with some potassium sulfate; number two, sodium sulfate and chloride with some nitrate; number three contains sodium and potassium carbonate or black alkali largely; while four is a mixture of sodium sulfate, chloride, carbonate, and nitrate.

Percentage Composition of Some Typical Alkali Salts¹ (Hilgard)

	Kern County, California	Meagher County, Montana	Kittitas County, Washing- ton	Tulare County, California
Potash.....	5.14	1.18	9.58	1.76
Soda.....	36.99	39.56	45.59	38.39
Lime.....	0.15	2.86	0.03
Magnesia.....	0.23	1.31	0.07
Ferric oxide and alumina.....	0.30	0.04
Sulfuric acid.....	51.23	34.97	0.09	13.20
Chlorine.....	0.29	15.40	0.99	7.40
Carbonic acid.....	0.23	1.19	34.93	11.62
Nitric acid.....	5.37	10.50
Phosphoric acid.....	0.09	1.05	1.05
Silica.....	1.34	0.05	0.82
Organic matter and water.....	4.07	1.29	7.03	17.32

The amount of the different kinds of alkali is not constant, but changes from week to week.

Effect on Physical Condition of the Soil.—The black alkali deflocculates the soil, producing a puddled condition due to the solution of the organic matter. A very close rearrangement of the particles occurs by which the soil becomes impervious to water and practically untillable. This closer arrangement of particles de-

creases the volume, producing a slight depression in which water is likely to stand. It also tends to form tough and impervious strata at different depths in the soil.

The white alkalis have no injurious effect on the soil, but, on the other hand, tend to produce a granular character that is very favorable to tilth.

Vertical and Horizontal Distribution.—The distribution of alkali salts is very irregular, both in amount and kind. The following table gives the vertical distribution in one place, which may be somewhat representative of most alkali areas. There is a zone of greatest concentration at about the depth of annual percolation. This zone is moved downward slightly by the winter and spring rains and is brought upward by summer evaporation. In heavy soils it will be nearer the surface than in permeable ones.

Vertical Distribution of Alkali Before and After Irrigation at Various Depths, Tulare, California. Pounds per Acre (Hilgard.²)

	Natural soil, unirrigated		Bare land, irrigated four years
	May 3, 1895	September, 1895	May, 1895
0 to 6 inches.....	350	420	12220
6 to 12 inches.....	460	440	7540
12 to 18 inches.....	1350	1710	6180
18 to 24 inches.....	3160	4450	3320
24 to 30 inches.....	7530	7810	1380
30 to 36 inches.....	9550	8120	760
36 to 42 inches.....	3380	1780	530
42 to 48 inches.....	1300	690	500

The amount of alkali in an area or even in a small field varies almost infinitely. It seems to move from place to place, so that an area with abundant alkali may in short time, perhaps not over a week or two, have much less. The kind of alkali varies even more than the quantity. A spot of black alkali may change to white, and *vice versa*. Low places in irrigated land will usually contain most alkali, and are frequently called alkali marshes.

Effect of Irrigation on Rise of Alkali.—The tendency of irrigation is to increase the amount of evaporation from the surface of the soil. The water applied enters the soil, dissolves the salts and carries them downward. When evaporation begins the water moves upward, carrying the salts with it and depositing them at the surface. The effect of successive irrigations and the excessive evaporation that follows is to transfer large quantities of salts to the sur-

face foot of soil. This is spoken of as the "rise of alkali" and the effect is to ruin the land for ordinary crops. The result is well shown in the table on page 281, where the surface foot contained 19,760 pounds, while the same depth under natural conditions contained 860 pounds.

Amount and Composition of Salts in Alkali Spot from Center to Circumference, 4 Feet Apart and 1 Foot Deep³

Mineral salts	Center of spot	Four feet	Eight feet	Twelve feet	Outer margin
Potassium sulfate.....	6.70	9.55	11.92	19.26	13.95
Sodium sulfate.....	19.84	12.85	23.72	23.97	16.96
Magnesium sulfate.....	3.07	.07	.95	2.05	8.29
Sodium chlorid.....	13.80	23.73	24.12	24.23	29.69
Sodium carbonate.....	50.72	50.96	37.55	35.49	29.94
Sodium phosphate.....	5.57	2.88	.87	1.04
Sodium nitrate.....	.308713

The irrigation canals and ditches sometimes pass through a rather open soil that permits considerable seepage. It is estimated that 30 per cent of the water taken in at the headgates is lost by seepage from the canals themselves and another third is gone before it is used for irrigation.

This seepage water passes through the soil, dissolving the alkali, and finally both water and alkali come to the surface in some slightly lower place in the field. This alkaline water gives rise to alkali marshes which, although very small at first, gradually increase in size until much of the land is affected. The "rise of alkali" has ruined large amounts of land because of the excessive use of irrigation water. The desire of farmers to get their "money's worth" of water has hastened their ruin.

Effect of Alkali on Plants.—A few plants have become adapted to growing where large amounts of alkali are present and are injured only when the soil becomes very strongly alkaline. There are small local areas where the alkali is sufficient to kill all vegetation. As a general rule, these alkali-resistant plants are not of much economic importance.

As a result of this poisoning, cultivated plants are injured to varying degrees (Fig. 129). Where the alkali is very strong the plants show a sickly growth and finally die without fruiting. If less in amount they may become dwarfed and produce rather scantily. Affected trees show a scanty leafage with small fruiting.

The external injury done to plants is confined to a narrow zone

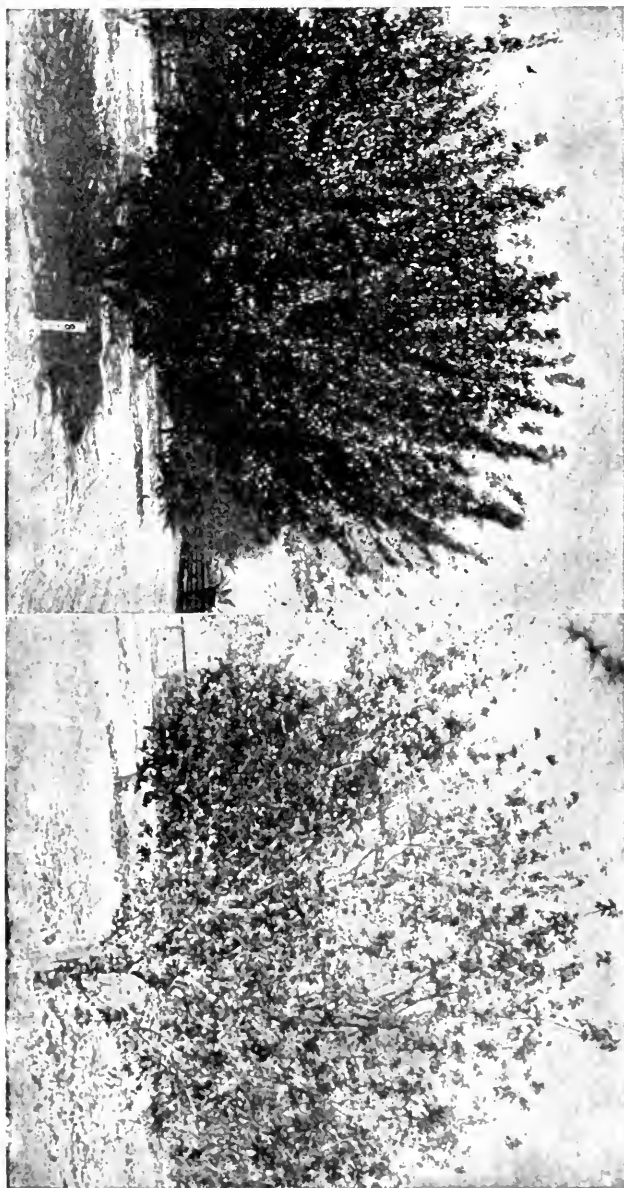

FIG. 129.—Apricot trees. The scanty foliage shows the effect of alkali. Hilgard's Soils, (Courtesy Macmillan Co.)

at the surface of the soil or near the root crown. The bark is turned to a brown or black color for about a half inch and may easily be peeled off. In other words, the plant has been "girdled." If the plant does not die it becomes unprofitable.

The roots are not injured perceptibly to any depth, as a general rule, but it is very likely that the entire plant is poisoned more or less. It is only where common salt is very abundant in the subsoil that the deeper roots are injured.

Limit for Germination and Growth.—Germinating plants are most sensitive to alkali, hence a comparatively small amount in the

Highest Amount of Alkali in Which Plants Were Found Unaffected^a—Arranged from Highest to Lowest. Pounds Per Acre Four Feet Deep

	Sulfates (Glauber's salt)	Carbonate (sal soda)	Chloride (common salt)	Total alkali
Saltgrass.....	44,000	136,270	70,360	381,110
Saltbush.....	125,640	18,560	12,520	156,720
Alfalfa, old.....	102,480	2,360	110,320
Sorghum.....	61,840	9,840	9,680	81,360
Radish.....	51,880	8,720	2,240	62,840
Sugar beet.....	52,640	4,000	10,240	59,840
Grapes.....	40,800	7,550	9,640	45,760
Onions.....	5,810	38,480
Potatoes.....	5,810	38,480
Barley.....	12,020	12,170	5,100	25,520
Gluten wheat.....	20,960	3,000	1,480	24,320
Oranges.....	18,600	3,840	3,360	21,840
Wheat.....	15,120	1,480	1,160	17,280
Apples.....	14,240	640	1,240	16,120
Celery.....	4,080	9,600	13,680
Alfalfa, young.....	11,120	13,120
Rye.....	9,800	960	1,720	12,480
Date palm.....	5,500	2,800	8,328

surface soil at that period may produce very serious results. As an illustration, young alfalfa will not stand more than 13,000 pounds of alkali in the soil to a depth of four feet, while old alfalfa will flourish where nearly ten times that amount exists, and this is true more or less of all plants.

In the growing of certain crops special methods are employed for reducing the amount of alkali in the surface soil until the plant becomes old enough to resist its effect. All plants are not equally injured by the same amount of alkali. Some will grow and flourish where others will die. In the case of the tussock grass, it will grow where the soil to a depth of four feet contains 499,000 pounds of

alkali, while 7000 or 8000 pounds will injure the lemon tree. The preceding table gives the highest amount of alkali in which plants were found unaffected.

As a general rule plants cannot withstand more than 0.1 per cent of sodium carbonate or 16,000 pounds in a depth of 4 feet, 0.25 per cent or 40,000 pounds of sodium chloride or common salt, nor more than 0.5 per cent or 80,000 pounds of sodium sulfate. If the amounts increase to any extent beyond these, the plants are very seriously injured.

Utilization and Reclamation of Alkali Lands.—The large extent and great value of alkali lands make their utilization and reclamation some of the most important problems in irrigated regions. While a great many methods have been tried with partial success, yet the removal of the alkali is the only remedy that will permanently reclaim the land. It may be well to notice some of the more or less temporary expedients for utilizing these soils.

1. Growing Alkali-Resistant Crops.—All plants are not equally sensitive to alkali, and the problem here is to find the crop of highest value that will be affected least by the salts. The salt grass and salt bushes grow under extreme conditions and they are of considerable value for forage. Sweet clover (*Melilot*) grows well where alkali is quite abundant and furnishes very good pasture and forage when cut early. In some places it is crowding out other plants. For gaining the requisite knowledge, the kinds and amounts of each alkali must be determined and different crops grown to learn the effects of varying quantities of salts upon them. After getting this information the determination of the alkali of new lands will give a very good idea of the crops to grow. Many plants are most sensitive to alkali when young and some special precautions must be taken in starting them. As a general rule shallow rooting crops are more sensitive than the deeper rooting ones, such as alfalfa and melilot, whose roots extend beyond the zone of greatest concentration.

2. Retarding Evaporation.—Alkali salts do most of their injury when near the surface. They are brought there by the upward movement and evaporation of water, and anything that will prevent this will retard the accumulation of salts in the zone of greatest injury. This may be done in two ways—by mulching and shading. The efficiency of a layer of soil in fine tilth to prevent evaporation has already been discussed. This should be three or four inches

deep to be most effective (Fig. 130). This mulch if maintained will prevent excessive capillary movement until the crop is sufficiently large to shade the ground. The maintenance of the mulch then becomes of less importance. Alfalfa during three-fourths of the time of its growth furnishes a very effective shade. Evaporation from soil of orchards is prevented very materially by the shading of the trees. Artificial mulches, as straw, leaves, sawdust, and manure, may be used, but are too expensive for large areas and only possible for high-priced crops under a very intensive system of agriculture.

3. **Deep Plowing and Turning Under Alkali.**—The practice of encouraging evaporation is sometimes resorted to for bringing the alkali to the surface and then turning under so deeply that it



FIG. 130.—An orchard well cultivated prevents the rise of alkali. (U. S. Reclamation Service.)

will not rise to the surface until after the young crop has passed through its most sensitive stage. By this means alfalfa and other crops may be started. When the crop attains such size that it shades the soil and the roots take up the water from beneath, comparatively little moisture evaporates from the surface and the alkali is not carried up to any extent.

4. **Neutralizing Black Alkali.**—The black alkali when present in amounts of one-tenth of a per cent prevents the growing of most crops. Sodium sulfate may be present in amounts five times as great before it becomes injurious. By treating the black alkali spots with gypsum (land plaster) a chemical reaction takes place when moisture is present, producing sodium sulfate and calcium carbonate. The former is not sufficiently soluble to be injurious,

while the latter is very beneficial to the soil in its puddled condition. The reaction is as follows:



The amount to be applied depends upon the amount of alkali present. Twice as much gypsum as black alkali is needed, but it is best to apply 200 to 400 pounds per acre annually. Moisture is necessary for the reaction to take place. The change in the physical condition of the soil is as important as the chemical effect. The impervious soil begins to swell up, becomes porous and soon the depressed spot is brought to the general level.

5. Removing the Salts from the Soil.—The removal of the salts is the only permanent remedy for reclaiming alkali lands. This is accomplished in several ways.

(a) *By Scraping.*—When excessive evaporation has brought large quantities of alkali to the surface it may be scraped off with two or three inches of soil and thrown into drainage systems that will carry them off the land. Large amounts of alkali may be removed in this way, but this applies to small areas only.

(b) *Flooding.*—The alkali may be *leached downward* into the soil to a depth of three or four feet by flooding so that the crop may be temporarily relieved from any danger of injury. Attempts have been made to wash the salts off the land, but since they soak into the soil as soon as dissolved this is impossible.

(c) *By Cropping.*—This method is to produce crops that take up large amounts of alkali in their growth which will be removed with the crop. The Australian salt bush when mature contains 20 per cent of ash and yields as much as five tons per acre. A single crop will remove approximately a ton of alkali.

(d) *Underdrainage.*—Leaching out the salts through underdrainage is the most practical and permanent remedy that has been devised. This, of course, requires a thorough drainage system as complete as for draining the swamps of humid regions. After the drainage system is installed, the soil must be flooded to leach out a large per cent of the salts, so that there will be little danger from alkali later. This requires a large amount of water, as the flooding must continue for several months (Fig. 131). With every irrigation system a corresponding underdrainage system should be installed to carry off the water from excessive irrigation and seepage, which is largely responsible for the rise of alkali.

To give an idea of the way reclamation is accomplished by

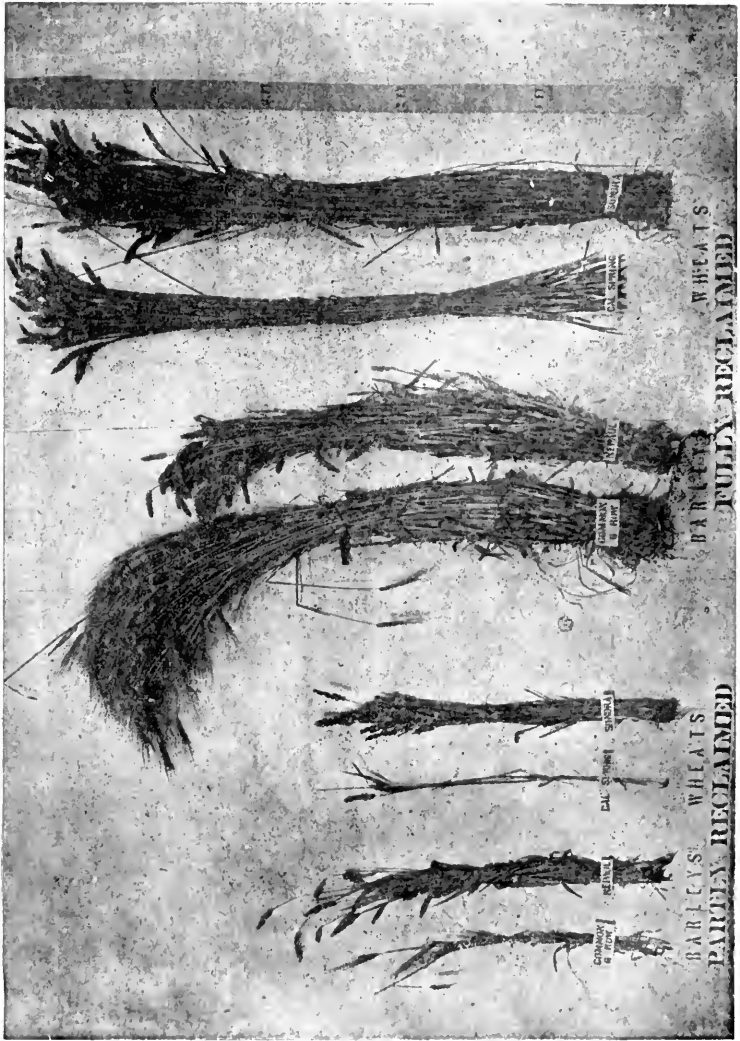

FIG. 131.—Growth of barley on partly and fully reclaimed alkali land. (Soils, Hilgard, Courtesy Macmillan Co.)

leaching let us consider briefly the work on a 40-acre tract reclaimed near Salt Lake City. The soil was badly affected by alkali, there being from 2.5 to 5 per cent to a depth of four feet. The salts were principally sodium chlorid and sodium sulfate, and since 0.25 per cent of the former and 0.5 per cent of the latter represent the upper limit of resistance of most farm crops it will be seen that the land was worthless.

The work began in 1902, the Bureau of Soils and Utah Station coöperating.⁵ A system of underdrainage was installed, the laterals being three-inch and four-inch tiles, 150 feet apart and placed four feet deep. The soil was a sandy and silty loam from 12 to 18



FIG. 132.—Wheat on reclaimed alkali land near Fresno, Cal. Reclaimed by one year of flooding with underdrainage. (U. S. Dept. Agr.)

inches deep; the underlying material varied from heavy loam to clay. The total volume of water used in flooding was 17,896,866 cubic feet or 10.2 feet deep over the 40 acres. The total salts removed in the 8,775,910 cubic feet of drainage water was 10,631,000 pounds of 5317 tons, or about one and one-fourth pounds per cubic foot of water. The amount of alkali in the soil at the beginning was 6651 tons. About 80 per cent was removed.

The cost of installing the drainage system was \$16.50 per acre.

A 20-acre tract at Fresno, California, was reclaimed in a similar way, the cost of installing the drainage system being the same as for the Utah area (Fig. 132). This land had been purchased for \$350 per acre and was abandoned 10 years after its purchase.

Flooding was begun on March 1, 1903, and in November, 1903, alfalfa was seeded on three acres, which was cut six times the next year, producing a total of 25,000 pounds of alfalfa hay.

Other tracts, North Yakima, Washington, Billings, Montana, and Tempe, Arizona, were reclaimed. The cost of installing the drainage system varied from \$21 to \$35 per acre.

Hardpan.—Where hardpan occurs in the subsoil reclamation is a much more difficult process. This layer usually varies in depth from one to four feet or even more. The cementing material may be calcium carbonate, iron compounds or other substances and may be from a few inches to several feet in thickness. In some instances the action of the water is to disintegrate the hardpan, and where this occurs little difficulty is caused by it. Calcium carbonate sometimes acts in this way. Usually this does not occur and it becomes practically impossible to leach out the alkali because the hardpan will not permit the water to pass downward. The alkali may be leached to the depth of the hardpan, but much of it remains in this stratum and soon rises. If the hardpan is due to black alkali it is necessary to neutralize this with gypsum before flooding.

Most soils, especially silt loams, clay loams, and clays, are injured more or less by flooding. The granules are destroyed, so that when the water is removed the soil bakes or is partly puddled, and it becomes necessary to use some means for restoring the tilth. This may be accomplished by turning under a green manure crop or by an application of farmyard manure.

Value of Alkali Land.—Alkali lands include some of the most valuable lands in the West, but more especially those that are capable of being irrigated. They are worthless as they are, but after the alkali is removed they have a very high value. Where water may be had in abundance the cost of reclaiming is not excessive. In doing this reclamation work drainage districts should be organized similar to those in humid regions for draining swamp land. The expense would in this way be reduced to a reasonable amount per acre.

Alkali Soils of Humid Regions.—In areas where the rainfall would seem to preclude the possibility of alkali, soils are sometimes found to contain considerable amounts of soluble material.

Dorsey⁶ speaks of the patches of alkali at the Maryland Station, where a thin layer of soil showed 1.83 per cent of water-soluble salts, such as nitrates of calcium, magnesium, sodium, and potassium, together with some chlorides and sulfates.

Small spots a few rods in diameter occur in southern Illinois in which the soluble salts form a deposit that looks like a heavy white frost or light snow. Analysis shows this to be sodium sulfate. It has been brought to the surface by seepage from higher land.

In the glaciated area of the Middle West alkali soils occur in many low, swampy places, usually in small patches of a few square rods, but in some cases extend over many acres. During dry spells whitish incrustations appear on the surface of the soil that disappear with rains (Fig. 133). These alkali areas almost always con-



FIG. 133.—A dwarfed bushy or leafy corn plant growing on alkali soil of humid area. Shells are nearly always indications of alkali.

tain large quantities of magnesium carbonate, and when this compound amounts to more than one per cent crops such as corn and oats are badly affected. The corn does not grow well, and where strongly impregnated with the carbonate is bushy and the blades turn brown or reddish. If a smaller amount is present the blades are striped with yellow. Very little grain is produced. Oats make a rank growth, but almost invariably lodge.

Drainage is the ultimate remedy, but the process is slow when only the natural rainfall is depended upon.

However, for immediately correcting the effect of the alkali applications of from 75 to 200 pounds of potassium salts may be used when they can be obtained at reasonable prices (Fig. 194). Coarse stable manure is as efficient as potassium salts, and even straw or green manure turned under has a very beneficial effect.

QUESTIONS

1. What conditions give rise to alkali soils?
2. On what kind of lands as to topography is alkali most abundant?
3. What is the source of the alkali salts?
4. What is the composition of black alkali?
5. What salts constitute the white alkali?
6. Note effects of black alkali upon the soil and organic matter.
7. How many pounds of alkali in the surface foot of soil in each column in the table of page 282?
8. How does irrigation cause a rise of alkali?
9. What are "alkali marshes"?
10. What is the first effect of alkali on plants?
11. What is the nature of the effect of alkali upon trees?
12. Is the effect of alkali the same on all plants?
13. What effect does alkali have on germination?
14. Why are shallow rooted crops more affected by alkali?
15. What methods are adopted for preventing evaporation?
16. What means are taken to start crops whose young plants are very sensitive to alkali?
17. How is black alkali neutralized?
18. What objections to removal of alkali by scraping?
19. Why cannot alkali be washed off of land?
20. How may the Australian salt bush be used to remove alkali? Does this plant have any value?
21. Describe the reclamation of the Utah tract.
22. What percentage of the water applied was carried off by drainage?
23. Why is a hardpan detrimental in removing alkali?
24. What is the effect of flooding on tilth? How may the condition be corrected?
25. What is the importance of reclamation of alkali lands from an economic standpoint?
26. Why do alkali soils occur in humid regions? How does the alkali differ from that of arid regions?
27. What is the substance that does the injury?
28. How is corn affected by magnesium carbonate?
29. What are the remedies to be used?

REFERENCES

- ¹ Hilgard, E. W., Soils, 1906, pp. 442-43.
- ² Hilgard, E. W., Report of California Station, 1894-95.
- ³ Op. Cit., p. 449.
- ⁴ Op. Cit., p. 467.
- ⁵ Dorsey, C. W., Bulletin 35, Bureau of Plant Industry, U. S. D. A., Alkali Soils of the United States, 1906, pp. 174-194.
- ⁶ Op. Cit., p. 157.

CHAPTER XXIII

TEMPERATURE

THE vital functions of plants require a certain temperature for their best performance. Plants may grow at other temperatures, but they grow most vigorously at the optimum temperature, which for different plants varies from 80 to 100 degrees F. Below this growth diminishes till at about 40 degrees F. it ceases for most plants. At temperatures higher than the optimum growth is less vigorous till a point is reached at from 99 to 115 degrees F., where it practically ceases. A knowledge of the functions of heat in relation to germination, growth, physical phenomena, and bacterial activity, and the means of its control, is of considerable practical importance to the agriculturist.

The Sources of Soil Heat.—1. Direct Radiation from the Sun.—The sun gives off both light and heat rays, and some of the latter, striking the earth, are absorbed. This is the chief source of heat. The amount received from the sun is enormous. Langley gives it as equal to 1,000,000 calories per hour per square meter of surface from a vertical sun in a clear sky. If all of this energy were absorbed by the plowed six inches of soil on a square foot its temperature would be raised by 24.5 degrees in an hour. The soil is always radiating heat, consisting of waves of lower pitch. These are easily held by glass or water vapor, which is transparent to waves of higher pitch or refrangibility. Hence the excessive heat of the glass house and the oppressive heat when the air is laden with moisture in the summer.

The heat received by any part of the earth's surface from the sun depends upon the transparency of the atmosphere to heat. Dust particles and water vapor in the atmosphere intercept some, while dry air, free from dust, absorbs very little.

Comparing the highest temperature reached by a blackened thermometer in vacuo at Greenwich, England, near sea level, and at Davos, Switzerland, 5400 feet above sea level, the temperature at the latter place was 20.1 degrees F. higher in November, 36.2 degrees in December, 37.2 degrees in January, and 24.2 degrees in February. The ground was continuously covered with snow at Davos. While more heat is received from the sun at high altitude per unit

area, it is radiated into space much more rapidly because of the small amount of vapor in the air to hold it.

2. **Precipitation.**—When warm rain falls upon and penetrates the cold soil it carries with it large amounts of heat. This may account for the rapid growth of plants after a shower in spring. An inch of rain 10 degrees warmer than the soil would raise the temperature of the surface six inches of soil 4.6 degrees if 10 per cent of moisture existed in the soil to begin with.

3. **Chemical changes** in the soil result in the production of heat. This is especially true of all chemical changes in organic matter, but particularly so of green crops and fresh farmyard manure. The results of some experiments at the Imperial College, Tokio, Japan, with different amounts of manure applied and thoroughly mixed with the soil, are given for five-day intervals in the accompanying table:

Influence of Farmyard Manure on Temperature of Soil.¹ Degrees Fahrenheit

Tons per acre.....	None	10	20	40	80
Temperature, October 27-31.....	60.5	62.5	63.8	63.1	65.1
Excess over unmanured.....	2.0	3.3	2.6	4.6
Temperature, November 1-5.....	58.5	59.5	60.2	61.3	62.2
Excess over unmanured.....	1.0	1.7	2.8	3.7
Temperature, November 6-10.....	57.2	57.8	58.4	59.3	60.4
Excess over unmanured.....	0.6	1.2	2.1	3.2
Temperature, November 11-15.....	54.7	54.8	55.3	56.2	56.8
Excess over unmanured.....	0.1	0.6	1.5	2.1
Average excess with manure in first twenty days.....	0.93	1.70	2.25	3.40

It will be noted that the heavier the application the greater the increase in temperature.

4. **Physical Changes.**—When a soil absorbs water its temperature is increased. This is true for both water vapor and liquid water, the former producing the highest temperature because of the

Increase in Temperature by Absorption of Water Vapor at 86 Degrees F. (30 Degrees C.)²

Quartz sand.....	1.58° F. (0.88° C.)
Calcium carbonate (precipitated).....	2.64° F. (1.47° C.)
Kaolin.....	4.73° F. (2.63° C.)
Hydrated ferric oxide.....	16.74° F. (9.30° C.)
Peat.....	22.05° F. (12.25° C.)

latent heat given off during condensation. The greater the hygroscopic capacity of the soil the higher is the temperature produced.

From the preceding table on page 294 it will be seen that peat and ferric oxide gave the highest temperature, while quartz sand, with its low hygroscopic capacity, gave the least increase. In the next table the increases are not so large.

*Increase of Temperature by the Application of Liquid Water at 50 Degrees F.
(10 Degrees C.)²*

Quartz sand.....	.18° F. (.10° C.)
Calcium carbonate (precipitated).....	.50° F. (.28° C.)
Kaolin.....	1.49° F. (.83° C.)
Hydrated ferric oxide.....	11.88° F. (6.60° C.)

Loss of Heat.—While the soil is receiving heat through these various sources it is losing it in several different ways.

1. **By Radiation.**—The amount of heat radiated from soils is not directly affected by their color. The statement is made in physics that good absorbers are good radiators. This is also true that the heat lost by radiation and convection by one body to another surrounding it is proportional to the temperature difference between the two. Dark soils are good absorbers of the sun's heat, but they have no tendency to lose it more rapidly because of their color, but because they are warmer than poor absorbers or light colored soils, and at night they all tend to cool to the temperature of the surrounding atmosphere. Black soils having absorbed more heat will have more to radiate, but there is no tendency for dark soils to become lower in temperature at night than light-colored ones under the same conditions.

In order to determine the effect of color on radiation Bouyoucos colored white sand and determined the radiation ratio as given in the following table:

The Radiation Ratio of Different Colored Sands

Colored sand	Radiation ratio
White.....	1.060
Black.....	1.051
Blue.....	1.015
Green.....	1.040
Red.....	1.050
Yellow.....	1.048

The results seem to indicate that radiation is slightly better from white sand, but the differences are so small that they come within the experimental error, and so the conclusion is reached by the experimenter that color does not affect radiation. A large amount of the heat radiated from the soil is brought to the surface by conduction. It is absorbed during the day and is conducted downward to a depth of from one to twelve inches. As the temperature of the air becomes lower at night the heat in part is conducted back to the surface and is radiated into the air. From February to August more heat is received by the soil than is radiated from it, but during the rest of the year radiation is greater than absorption, and as a result the temperature of the soil is becoming lower. (See the table, page 307.)

2. By Conduction Downward Into the Soil.—The process of conduction is a very slow one, so slow that the soil at a depth of 36 inches has an average annual range of only 28.7 degrees F. for a ten-year average, while at a depth of one inch the average range was 45.8 degrees. Some of the heat is conducted to such a depth that it cannot influence the growth of plants in any way and may be considered lost.

3. By Evaporation of Water.—When water is evaporated large amounts of heat are carried away as latent heat in the vapor.

4. By Convection Currents of Air.—The heated soil warms the adjacent air, causing it to expand and rise. These currents of warm air are constantly carrying large amounts of heat upward. The effect of this in comparison to radiation may be seen by placing thermometers at equal distances above and on the side of a heated object.

Soil Temperature for Vital Functions of Plants.—**1. Temperature for Germination.**—The temperature at which germination takes place varies with different classes of plants. Slow germination in a cold soil brings about favorable conditions for the action of fungi and bacteria upon the seed which may cause decay. Some of our cultivated crops, as corn and beans, are especially susceptible to injury in this way. This may bring about a low percentage of germination and a poor stand results. Uloth⁴ found that certain seeds, one of which was wheat, would germinate in a dark cellar on a cake of ice, the rootlets descending into the ice to a slight depth by melting cylindrical cavities. The rootlets of Norway maple descended into the ice to a depth of 7.5 centimeters. The next table gives the minimum, optimum, and maximum temperature at which germination takes place.

Minimum, Optimum, and Maximum Temperatures for Germination of Various Seeds as Determined by Different Investigators (Degrees Fahrenheit)

Investigator	Minimum			Optimum			Maximum		
	Sachs	Van Tiegham	Haberlandt	Sachs	Van Tiegham	Haberlandt	Sachs	Van Tiegham	Haberlandt
Wheat	41	41	32-40	84	84	77-88	104	99	100
Barley	41	41	32-40	84	83	77-88	104	100	100
Peas	44.5	44	32-40	84	80	77-88	102	...	100
Corn (maize)	48	49	40-51	93	93	88-100	115	115	111-122
Red clover	42	32-40	..	70	77-100	...	82	100-111
Turnip	32-40	..	89	77-88	...	108	88-100
Mustard	32	32-40	..	81	61-88	...	99	88-100
Melon	60-65	..	99	88-100	111-122
Pumpkin	51-60	100	111-122
Oats	32-40	77	88-100

By consulting the following table it will be seen that we long ago adapted our agricultural practices to conform in a measure to the temperature requirements of plants for germination. The temperatures for growth are very similar to those for germination.

*Time Required for Appearance of Radicle at Different Temperatures*⁵

Temperatures	40° F.	51° F.	60° F.	65° F.
Rye	4	2.5	1	1
Wheat and barley	6	3	2	1.75
Oats	7	3.75	2.75	2
Vetches	6	5	2	2
Alfalfa	6	3.75	2.75	2
Red clover	7.5	3	1.75	1
Beans	7	6.5	4.75	4.25
Mustard	2	1.5	1	0.75
Peas	5	3	1.75	1.75
Rape	6	2	1	1
Turnip	8	4	2	1.75
Sugar beet	22	9	3.75	3.75
Flax	8	4.5	2	2
Corn (maize)	11.25	3.25	3
Pumpkin	10.75	4

It will be seen from the preceding table that the time for germination is controlled largely by the temperature and emphasizes the necessity of not seeding until the temperature is high enough.

2. **Temperature for Growth.**—With most plants, and especially with our cultivated ones, growth does not begin until a tem-

perature of 40 to 50 degrees F., the zero point of growth, is reached by the soil. Growth is most vigorous at from 80 to 90 degrees F. This means that the temperature must reach that point during the day, even if it does fall below this during the night. The amount of growth depends upon the proportion of the day that is above the zero point of growth or the heat hours. It will be seen from the following table that corn requires a medium high temperature before growth begins, while melons require a still higher one.

Temperature of Soil for Growth ⁶

Crops	Minimum	Optimum	Maximum
Mustard.....	32° F.	81 ° F.	99 ° F.
Barley.....	41° F.	83.6° F.	99.8° F.
Wheat.....	41° F.	83.6° F.	108.5° F.
Maize.....	49° F.	93.6° F.	115 ° F.
Kidney bean.....	49° F.	92.6° F.	115 ° F.
Melon.....	65° F.	91.4° F.	111 ° F.

3. Temperatures Favorable for Osmosis and Diffusion.—Osmosis is a process upon which germination of seeds and the growth of plants depend. The seed coat is the osmotic membrane, and the rapidity with which water passes through this depends upon the temperature. Osmotic pressure is the power that sends the soil moisture into the roots of plants. At low temperatures plants may wilt, and Sachs found that at 55 degrees F. pumpkin and tobacco plants did not receive sufficient moisture to compensate for even slow transpiration.

Diffusion of substances in solution is influenced by temperature in the same way, being much more rapid at high than low temperatures.

4. Temperatures for Nitrification.—Our ordinary crops depend to a large extent upon the activity of bacteria in the soil, which by means of the process of nitrification use the nitrogen in the organic matter to produce soluble nitrates. The soil bacteria do not work to any large extent if the temperature of the soil is below 41 degrees F., nor above 130 degrees F. They are most active at temperatures between 60 and 85 degrees F.

Conditions Affecting Soil Temperature.—1. **Specific Heat.**—It is a very interesting as well as an important fact that the same amount of heat applied to different substances raises the temperature

unequally. Of all substances, solid or liquid, water requires the greatest amount of heat to change its temperature one degree. The quantity of heat required to change the temperature of a unit mass of any substance one degree is the specific heat of the substance. Water is taken as unity.

Specific Heats of Some Common Substances⁷

Aluminum.....	0.219	Lead.....	0.305
Brass.....	0.09	Quartz.....	0.174
Copper.....	0.0936	Silver.....	0.0559
Glass.....	0.117	Tin.....	0.0552
Granite.....	0.19 to 0.20	Zinc.....	0.0935
Iron.....	0.119	Mereury.....	0.0333

This means that one pound of iron requires 0.119 as much heat to change its temperature one degree as is required by a pound of water, or that the heat necessary to effect a change of one degree in a pound of water would raise 8.4 pounds of iron one degree, or one pound 8.4 degrees.

Dry soils generally possess a low specific heat, varying from 0.15 to 0.3, with an average of 0.215, or, in other words, it requires from one-seventh to one-third as much heat to raise the temperature of dry soil one degree as of water.

Specific Heat of Soil Constituents

	Lang		Bouyoucos *	
	Equal weights	Equal volumes	Equal weights	Equal volumes
Sand.....	0.189	0.499	0.1929	0.509
Clay.....	0.233	0.568	0.206	0.569
Loam.....	0.214	0.215	0.551
Peat.....	0.477	0.587	0.253	0.440
Ferrie oxide.....	0.163	0.831
Calcium carbonate.....	0.206	0.561
Gravel.....	0.2045	0.554

The figures for peat vary a great deal, because in some cases no allowance was made for the heat of wetting. The specific heat of equal volumes may be obtained by multiplying the specific heat of equal weight by the specific gravity.

Patten has made determinations of the specific heat of soil types of various classes as given in the following table:

*Specific Heat of Soils (Equal Weights) **

Norfolk sand	0.1848
Hudson River sand.....	0.1769
Fine sand (soil separate).....	0.1799
Fine quartz flour.....	0.1900
Coarse sand (quartz).....	0.1900
Podunk fine sandy loam.....	0.1828
Leonardtown silt loam.....	0.1944
Hagerstown loam	0.1914
Galveston clay	0.2097
Muck soil, 25 per cent of organic matter.....	0.1566

Humus has the highest and sand the lowest specific heat of soil constituents. Wet soils require much more heat to raise their temperature than dry ones. In case of a dry silt loam whose specific heat is 0.23 if 20 per cent of moisture is added, its specific heat will be raised to 0.36. One hundred pounds of dry soil would require the application of 23 heat units to raise its temperature one degree, while the same weight of the wet soil would require 36 heat units. The latter would warm up much more slowly than the former. The effect of varying amounts of moisture on the specific heat is here shown:

Effect of Moisture on Specific Heat, Podunk Fine Sandy Loam ¹⁰

Moisture content, per cent of dry weight	Specific heat	Moisture content, per cent of dry weight	Specific heat
0.268	.1850	6.60	.2334
1.33	.1935	10.08	.2575
2.14	.2000	20.25	.3204
2.83	.2053	26.93	.3562

2. **Evaporation of Water.**—The temperature of soils is lowered by the evaporation of water from them. In the change from a solid to a liquid or from a liquid to a vapor heat is required to effect the change. When the opposite change takes place heat is liberated. When ice melts 80 calories (centimeter-gram system), or 144 heat units (English system), are used in producing the changes in a unit weight. When water passes into vapor, 537 calories or 966.6 heat units are required, and when condensation takes place this heat is

liberated. When water evaporates from a soil, the larger part of the heat used in the process is taken from the soil. This has a tendency to lower the temperature, and hence wet soils do not warm up rapidly in the spring and are spoken of as "late" soils. They become warm only when the greater part of the water has evaporated or when properly drained.

If one-half pound of water is evaporated daily from a square foot of soil, 483.3 heat units or 121,790 calories are required, the larger part of which would be taken from the soil. If all of the heat necessary for this were taken from a cubic foot of loam soil having an apparent specific gravity of 1.25 and containing 20 per cent of moisture it would lower the temperature 15.5 degrees F.

Clays, peats, and undrained soils are cold and late partly because of this evaporation.

Anything that diminishes evaporation aids in increasing the temperature of soils. Mulches, windbreaks, and drainage decrease evaporation, and hence increase temperature. The strong winds of spring increase evaporation, hence tend to keep the soil cooler until it becomes fairly dry, when it warms up rapidly.

The effect of the wind upon evaporation has been well shown by King, who determined the evaporation at 20, 150, and 300 feet to the leeward of a hedgerow. The amount was 24 and 33 per cent greater for 150 and 300 feet respectively than at 20 feet. When the air came across a field of standing clover 780 feet wide the evaporation was 30.1 per cent greater at 150 feet, and 40 per cent greater at 300 feet than at 20 feet from the field.

3. **Drainage.**—The effect of drainage on temperature at different depths is shown in the table. The soils are the same. Drainage

The Effect of Drainage on Temperature ¹¹

Time	Thermometer 1 inch below surface		Thermometer 2 inches below surface		Thermometer 4 inches below surface	
	Drained	Undrained	Drained	Undrained	Drained	Undrained
6 A.M.	48.0° F.	49.0° F.	48.0° F.	49.0° F.	49.5° F.	49.0° F.
Maximum	82.5° F.	70.0° F.	80.0° F.	69.0° F.	75.0° F.	68.4° F.
6 P.M.	71.0° F.	63.0° F.	73.0° F.	65.0° F.	74.5° F.	67.5° F.

removes the gravitational or free water, thus lowering the specific heat so that the same amount of heat applied will raise the temperature more than if the soil contained much moisture.

It is very interesting to note the effect of drainage in the above experiment upon the germination of seeds and early growth of plants in the drained and undrained soil (Fig. 95).

4. **Presence of Water.**—Aside from the lowering of temperature by evaporation of water from soils, the presence of water keeps the temperature down because of the slowness with which it changes or because of its high specific heat. This is partly the cause of peats, clays, and undrained land being cold and late. If a cubic foot of dry soil having a specific heat of 0.2, weighing 100 pounds, should have 100 heat units applied to it, its temperature would be increased five degrees Fahrenheit. If a cubic foot should contain 20 pounds of water, its temperature would be increased two and one-half degrees, or the specific heat of the soil would be doubled. Sand soils are "early" because of the small amount of moisture which they contain and their low specific heat.

5. **Absorption and Radiation of Heat.**—The absorption of heat by soils and consequently their temperature depends largely upon their color. The dark colors absorb more heat than light ones. Black, blue, brown, and red absorb heat in the order given, while green, yellow, gray, and white absorb less, white being the slowest absorber of all. Bouyoucos colored white sand with dyes and determined the comparative absorbing power as measured by the temperature obtained. This table gives the results:

Effect of Color on Temperature of Sands ¹²

Color of sand	July 27-28		August 5-6	
	Maximum 2 P.M.	Minimum 4 A.M.	Maximum 2:30 P.M.	Minimum 4:30 A.M.
Black.....	40.9 ° C.	16.7 ° C.	37.6 ° C.	12.45° C.
Blue.....	40.0 ° C.	16.65° C.	36.7 ° C.	12.4 ° C.
Red.....	38.55° C.	16.65° C.	35.9 ° C.	12.4 ° C.
Green.....	37.10° C.	16.60° C.	34.7 ° C.	12.3 ° C.
Yellow.....	35.8 ° C.	16.60° C.	32.65° C.	12.25° C.
White.....	34.6 ° C.	16.44° C.	31.7 ° C.	12.2 ° C.

A very interesting demonstration is to fill a tray three by six feet with soil, plant an equal number of seeds in each half of the tray, and cover one-half with very dark soil and the other half with white soil and place in the sunshine (Fig. 134). For best results this should be carried on in spring or fall. Plants come up from 24

to 72 hours sooner in the part of the tray covered with dark soil. The table following gives the temperature in the two parts of the tray :

Effect of Color on Soil Temperature ¹¹

Time	Thermometer bulb 1 inch below surface		Thermometer bulb 2 inches below surface		Thermometer bulb 4 inches below surface	
	Light	Dark	Light	Dark	Light	Dark
6 A.M.	48.8° F.	50.0° F.	47.5° F.	49.0° F.	48.5° F.	50.5° F.
Maximum	71.5° F.	82 ° F.	70.8° F.	78.5° F.	78.4° F.	71.3° F.
6 P.M.	71.5° F.	66.5° F.	74.5° F.	70 ° F.	77 ° F.	71 ° F.
Increase	10.5° F.		8.8° F.		7.1° F.	



FIG. 134.—Difference in growth on light and dark colored soils. A, corn, B, wheat; C, watermelon.

The time and the number of plants coming through the soil are governed to some extent by the color of the soil, as is shown in the following table.

*Time Required and the Number of Plants that Came Up in the Soils of Different Colors. One Hundred Seeds Were Planted in Each*¹¹

Days after planting	Wheat		Oats		Corn		Melons	
	Light	Dark	Light	Dark	Light	Dark	Light	Dark
7.....	..	4	..	6
8.....	8	75	..	80
9.....	29	86	27	100	..	6
10.....	51	86	70	100	1	84	..	21
11.....	58	86	75	100	66	95	4	60
12.....	62	86	75	100	72	95	32	85
13.....	65	86	75	100	72	95	57	86

With black the absorption is almost complete. The soils of whatever color tend to cool to the temperature of the surrounding atmosphere during the night or in cloudy weather. The table on page 302 shows that the lowest temperatures of the dark-colored sands were not as low as the light-colored ones. Color has little influence in very wet soils since evaporation is a greater factor in lowering temperature than color is in raising it.

6. **Latitude or Angle of the Sun's Rays.**—All flat areas of the earth's surface have the same number of hours of possible sunshine annually without regard to location on the earth. The effect

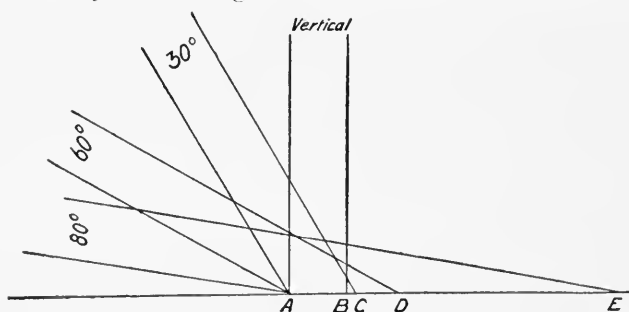

FIG. 135.—Showing the comparative areas covered by the sun's rays when vertical, 30, 60, and 80 degrees from the vertical. Compare AB, AC, AD, and AE.

of the rays in warming the soil depends upon the angle at which they strike (Fig. 135). If a sunbeam striking the earth's surface perpendicularly covers an area of 1, when this same beam strikes at an angle of 30 degrees from the vertical, it will cover an area of 1.175; at 60 degrees it will cover an area of 2, and at 80 degrees an area of 6. The heat will be spread over a larger area the greater the distance from the vertical, and the effect on temperature would be inversely as the angle. The atmosphere absorbs some heat. The

vertical rays pass through a thinner stratum of air than the other, and more heat will reach the surface from a vertical sun. The effect of greater inclination is compensated for in summer to some extent by the longer sunshine period in twenty-four hours for high latitudes.

7. **Slope.**—The slope of land has somewhat the same effect as latitude on the concentration and distribution of heat. The effect is to cause the rays from the sun to strike the south slope at a less and the north at a greater angle from the perpendicular (Fig. 136). With the sun 45 degrees above the horizon and the hill having the two slopes of 20 degrees of equal length, the south one would receive twice as much heat from the sun as the north one.

Wollny found that the average temperature of the south slope of a 15-degree hill was 1.5 degrees F. higher than the north slope.

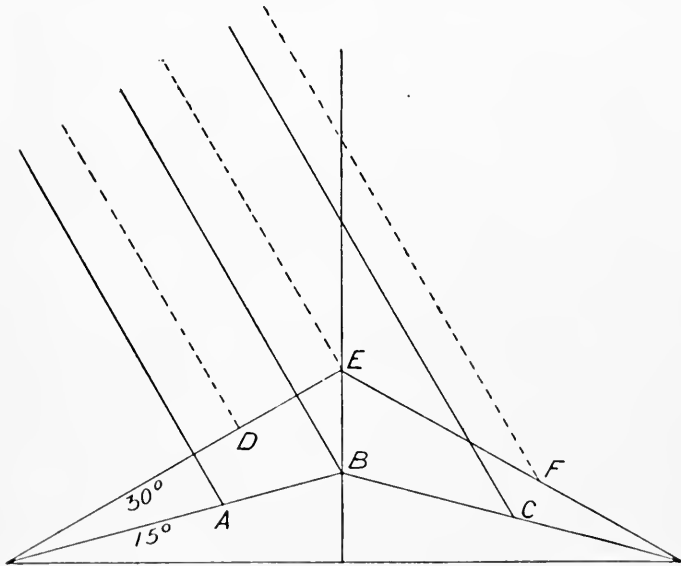

FIG. 136.—Effect of slope on the area covered by the sun's rays. Angle of sun's rays 30 degrees from vertical. EF is 100 per cent greater than DE. BC is 40 per cent greater than AB.

King found that on July 31 a south slope of 18 degrees had a temperature 3.1 degrees F. higher than the level at a depth of one foot; 2.7 degrees at two feet, and 2.8 degrees at three feet. For early crops a south slope is desirable. Plants that are liable to injury from spring frosts should be placed on north slopes so that growth will be retarded as much as possible.

8. **Conductivity of Soil Material and Soils.**—Wet soils are better conductors of heat than dry ones and compact ones better than loose ones. These differences are due to the fact that air is a very poor conductor, even poorer than water. Soils should not conduct heat downward very rapidly in spring, but should cause concentration of heat in the surface two to four inches to hasten germination and aid the growth of the young plant. Of all soil materials quartz shows the highest rate of conductivity, while dry powdered chalk shows the lowest.

In the following table it will be well to note the difference between loose and compact, wet and dry, and fine and coarse.

*Relative Conductivity of Soil Material*¹³

Soil material	Dry		Wet
	Loose	Compact	
Quartz powder.....	100.0	106.7	201.7
Peat.....	90.7	90.7	94.3
Kaolin.....	90.7	96.4	155.6
Chalk.....	85.2	92.6	153.2
Clay with limestone stones.....	112.1
Clay with quartz stones.....	115.6
Quartz sand, fine.....	100.0
Quartz sand, medium.....	103.6
Quartz sand, coarse.....	105.3	moist
Quartz sand.....	100.0	174	189.0

The next table shows the length of time required after the air temperature had begun to rise for the heat to penetrate the soil to the depths given in the table. The conductivity of soils does not play a great part in practical agriculture except early in the spring when the greater conductivity of sand soils permits them to warm up earlier and to a greater depth, thus giving the crops grown upon them the advantage of several hours of warmer soils each day.

*Relative Time for Heat to Penetrate the Soil Under Field Conditions*¹⁴

Date	Depth inches	Gravel		Sand		Loam		Clay		Peat	
		hrs.	min.	hrs.	min.	hrs.	min.	hrs.	min.	hrs.	min.
July 27.....	6	4		4		6	30	6		9	
	12	7		7		9	30	9	30	
August 5.....	6	4		4		6		5	30	8	30
	12	7		7		10		9	30	
August 26.....	6	4	30	4	30	7		6		9	
	12	7		7		10	30	10		
August 27.....	6	4		4		6		5	30	9	
	12	6		6		10	30	10	30	
September.....	6	5		4		6	30	6		9	30
	12	5	30	5	30	9		9		

The following table gives the average soil temperature at varying depths for ten years:

*Average Soil Temperature, 1905-1914 10-Year Average in Bluegrass Sod*¹¹

Depth—Inches	Jan.	Feb.	Mar.	Apr.	May	June	July	Aug.	Sept.	Oct.	Nov.	Dec.
1.....	31.3	30.9	40.0	50.9	62.8	72.7	76.7	76.4	68.6	55.1	42.4	35.6
3.....	31.5	30.6	39.6	50.7	62.2	72.0	75.8	75.8	68.2	54.8	42.8	34.9
6.....	32.5	31.5	38.9	49.6	60.4	69.8	74.2	74.0	68.2	54.9	43.4	35.3
9.....	33.2	32.1	38.3	49.2	59.8	68.5	73.5	73.3	67.9	55.8	44.3	36.2
12.....	34.4	32.7	38.0	48.7	58.8	68.2	72.8	72.9	67.6	56.9	45.4	37.8
24.....	39.4	37.2	38.0	47.2	55.3	62.7	68.3	69.5	66.7	59.5	49.9	43.5
36.....	41.4	38.8	40.2	46.1	53.1	60.5	65.7	67.5	65.9	60.4	52.1	45.8

It will be noted that the highest average temperature to a depth of nine inches is reached in July, while for greater depths the highest is reached in August. This is due to the slow conductivity of the soil.

9. **Tillage.**—In general, tillage has two effects upon soils as regards temperature. It increases evaporation at first, but when the surface becomes dry this layer acts as a mulch, preventing the moisture from coming to the surface when the heat is used in evaporating it. Tillage loosens the soil, making it a poor conductor of heat. This concentrates the heat in the surface two or three inches of soil, and gives better conditions for germination early in the spring. Later in the season, when the untilled soil has become somewhat dry, the conditions are reversed, and the tilled soil is cooler than the untilled.

QUESTIONS

1. Why is a knowledge of the functions of heat and its control important?
2. Illustrate the amount of heat received from the sun.
3. Why do high altitudes receive more heat from the sun than low ones?
Why are high altitudes colder?
4. After the manure becomes thoroughly decomposed and mixed with the soil, what effect will it have on temperature?
5. Why should water vapor raise the temperature of soil material more than liquid water?
6. What effect does color have on radiation of heat?
7. Why is conduction of heat downward into soil so slow?
8. Why is slow germination of seeds undesirable?
9. Is the temperature of the soil usually at the optimum, as shown in the table on page 298, when the seeds are planted?
10. What part does osmosis play in germination?
11. How does temperature affect it?
12. What effect does color of soil have on a cloudy day?
13. How does the specific heat of soils compare with other substances?
(See tables, page 299.)

14. How does the specific heat of humus compare with other substances found in soils?
15. What is the effect of evaporation on temperature of soils?
16. Explain the effect of moisture on specific heat of soils.
17. Give the figures in regard to the effects of windbreaks.
18. How many heat units would be required to raise the temperature of a cubic foot of soil five degrees if it weighs 80 pounds, water-free, and contained 20 per cent of water? Specific heat of soil, 0.21.
19. Give conclusion of experiments of Bouyoucos in table on page 302 with colored sands.
20. Try the experiment with seeds planted in different colored soils.
21. What effect did color have on different seeds? Why did melons show lower germination?
22. What influence does color have on very wet soils?
23. Explain effect of latitude on temperature of soils.
24. Explain action of atmosphere in absorption of heat.
25. What is the effect of slope on temperature?
26. What part does conductivity play in temperature?
27. Which will warm up quicker in spring, a cultivated soil or a compact soil? Why?
28. Why is dry, loose chalk a poorer conductor of heat than quartz powder?
29. Why is fine sand a poorer conductor than coarse sand?
30. Why is wet soil a better conductor than dry?
31. For truck crops do we need good or poor conductors?

REFERENCES

- ¹ Georgeson, Agricultural Science I. p. 251.
- ² Stellwaag, Wollny, Forsch. der Agricultur Physik, Vol. 5, p. 210.
- ³ Bouyoucos, George J., Technical Bulletin 17, Michigan Station, 1913. An Investigation of Soil Temperature and Some of the Most Important Factors Influencing It, p. 30.
- ⁴ Uloth, Flora, 1871, p. 185.
- ⁵ Haberlandt, F. Landw. Versuchs-Stationen. xvii, p. 104.
- ⁶ Hall, A. D., The Soil, 1912, p. 123.
- ⁷ Duff, A. Wilmer, A Textbook of Physics, 1912, p. 232.
- ⁸ Bouyoucos, G. J., (see above), p. 12.
- ⁹ Patten, H. E. Bulletin 59, Bureau of Soils, U. S. D. A., Heat Transference in Soils, 1909, p. 34.
- ¹⁰ Patten, H. E., (see above), p. 27.
- ¹¹ Unpublished Data, University of Illinois.
- ¹² Bouyoucos, G. J., (see above), p. 31.
- ¹³ Pott, H. E., Landw. Versuchs-Stationen, xx, p. 288.
- ¹⁴ Bouyoucos, G. J., (see above), p. 19.

CHAPTER XXIV

SOIL AIR AND AERATION

EVERY individual who has grown crops knows that a soil must contain air as well as water, and the amount of one will vary with that of the other. In other words, the air of a soil occupies that space not occupied by water, and when the proportion of the two is about equal optimum conditions prevail.

Use of Air in Soils.—The most important element in soil air is oxygen. It is necessary for the vital functions that take place in plants, and in the case of water-logged soils, in which the oxygen is reduced to a minimum, the effect can readily be seen. Oxygen is necessary for root respiration. We find that there is an interchange in the roots, the carbon dioxide being given off and the oxygen taken in. Oxidation, with or without the agency of bacteria, is necessary for furnishing available plant food for the crop. The process that supplies available nitrates is known as nitrification, and takes place through the agency of organisms. This is absolutely necessary in soils, and if for any reason oxygen is prevented from entering the soil, or if the supply becomes low, the lack of nitrates is shown by the yellowish-green color that the plant soon assumes.

A supply of oxygen is necessary in the soil for germination also. Certain chemical processes take place in the seed for which oxygen is necessary. In extremely wet soils seeds germinate very poorly. Air is necessary in the soil for supplying nitrogen to the nitrogen-fixing bacteria, both symbiotic and non-symbiotic. The carbon dioxide of the soil air is of importance because of its effect on minerals. These are slowly decomposed by the carbonic acid that is formed, and plant food is liberated.

Amount of Air in Soils.—The amount of air in soil depends upon the porosity, and this upon the texture. It would naturally be supposed that the greatest amount of air would be in the soil having the highest porosity. This may not always be true, since soils with high porosity have also a high retentive capacity for moisture, and it would not be an unusual thing for a soil to retain so much water that it would reduce the actual amount of air present to a point less than that held by sand. (See the table on composition of soil air, page 310.)

The structure of the soil plays some part in the amount of air. This is especially true of fine-grained soils. If granulation exists the space between the granules will be largely occupied by air, even when the soil is well supplied with water. This may increase the amount of air so that it will compare very favorably with that in sand. The amount of organic matter present influences both the water retained and the porosity, but as a general rule it will increase the amount of air in soils, since it also increases the granulation. The most important factor in determining the amount of air in soil is moisture, which varies from week to week. After a heavy rain air may occupy only a small fraction of the total pore space. With the removal of the water by percolation, evaporation, and by roots the amount of air increases.

Composition of Soil Air.—While the soil air contains substances that are not found to any extent in the air above, yet in general the same elements and constituents are found in it as in the atmosphere. Thus we find the atmosphere composed of oxygen, nitrogen, and carbon dioxide, with a few other elements or compounds. In the soil air we find the same elements present, but not in the same proportion. The carbon dioxide is much more abundant

Composition of Soil Air as Determined by Boussingault and Lewy¹

Character of soil	Volume in one acre of soil to depth of 14 inches		Composition of 100 parts of soil air by volume		
	Air (cu. ft.)	Carbon dioxide (cu. ft.)	Carbon dioxide	Oxygen	Nitrogen
Sandy subsoil of forest...	4,416	14	0.24
Loamy subsoil of forest...	3,530	28	0.79	19.66	79.55
Surface soil of forest.....	5,891	57	0.87	19.61	79.52
Clay soil.....	10,310	71	0.66	19.99	79.35
Soil of asparagus bed not manured for one year..	11,182	86	0.74	19.02	80.24
Soil of asparagus bed freshly manured.....	11,182	172	1.54	18.80	79.66
Sandy soil, six days after manuring.....	11,783	257	2.21
Sandy soil, ten days after manuring (three days of rain).....	11,783	1,144	9.74	10.35	79.91
Vegetable mold compost..	21,049	772	3.64	16.45	79.91

Per cent by volume		
Ordinary air (above the surface).....	03	20.93 79.04

in soil air than in the atmosphere, while the oxygen varies inversely with the amount of carbon dioxide, the nitrogen remaining practically the same.

The above table shows the amount of carbon dioxide in soils under different conditions with the comparative amount of oxygen.

Aëration or Soil Ventilation.—Aëration as spoken of in connection with soils is an interchange between the atmosphere and the soil air. It is necessary, first, to supply the oxygen needed by roots and soil organisms; second, to supply the nitrogen needed by nitrogen-fixing bacteria, and, third, to remove the carbon dioxide, an excess of which becomes injurious because of the fact that it excludes oxygen. Soil ventilation may be accomplished in a variety of ways.

(a) **Diffusion** is the mixing of gases of different composition due to molecular movement. It may be well illustrated by filling a bottle with carbon dioxide, and although this gas is heavier than ordinary air, yet if the bottle is left unstoppered for a short time it will gradually diffuse into the surrounding atmosphere. As seen in the preceding table, soil air contains a larger amount of carbon dioxide than the atmosphere and it is constantly, but slowly, being removed by diffusion. This process takes place more rapidly in soils of large total pore space than in those with large individual pores, so that for heavier soils with a high porosity and a high air content, diffusion will take place more rapidly than in sandy soils with larger pores and a smaller total pore space. This seems contrary to the fact that sandy soils are better aërated than clay soils, but it must be remembered that other agencies are at work that bring about better aëration in sandy soils. Compacting a soil, by any means, tends to lessen diffusion because it lessens the total pore space. For this reason a soil in good tilth permits more rapid diffusion than one in poor tilth. Temperature affects diffusion in that a higher temperature produces greater molecular activity, which results in more rapid interchange of the gases.

(b) **Removal of Water.**—The removal of water from the soil by any process permits air to enter, thus bringing into the soil a new supply of pure air. As the water is carried out by drainage the air follows downward from the surface. The removal of water by the roots of plants has the same effect, but the change is very slow.

(c) **Changes in Atmospheric Pressure.** Barometric pressure is not constant. Regular changes take place in the region of the

prevailing westerlies every three or four days, corresponding to the movement of "highs" and "lows." These variations amount to an average of about one-half inch in the height of the mercury. At the Illinois Station the average weekly change for five years has been 0.45 inch. The minimum during this time was 0.20 inch, while the maximum was 1.45 inches. According to Boyle's law, a decrease in pressure increases the volume of a gas, while an increase in pressure diminishes it and in proportion to the increase or decrease. A difference of 0.5 inch in pressure is equivalent to 1/60 of an atmosphere. If a cubic foot of soil with 50 per cent of pore space has one-half of this occupied by air, it will contain 432 cubic inches of air. An increase in pressure of 1/60 of an atmosphere will force seven cubic inches of air into the soil. With a corresponding decrease in pressure the soil air expands, forcing out the same amount.

(d) **Temperature Changes.**—When gases are heated they expand, and when cooled they contract. The amount of expansion or contraction is a definite quantity. Air changes in volume 1/491 for each change of one degree Fahrenheit, or 1/273 for each degree Centigrade. If a cubic foot of soil contains 432 cubic inches of air, a change of one degree will result in a change of approximately one cubic inch in volume. During the growing season the average daily range for soils to a depth of four inches is about twelve degrees, as shown in the table below.

Range of Temperature of Plowed and Unplowed Land at Different Depths (Degrees Fahrenheit)—Average 1912-1915²

Depth	Two inches deep		Four inches deep	
	Plowed	Not plowed	Plowed	Not plowed
May *	12.8	11.2	10.3	9.8
June	13.6	13.8	13.1	15.7
July	16.0	17.7	13.2	15.6
August	14.1	13.6	11.5	11.1

* Average of 2 years.

This would give a change in volume of about 12 cubic inches in a cubic foot of soil, and this amount would be expelled during the day and taken in at night. The aëration brought about by changes in pressure and temperature produces almost a complete change of the air in the surface few inches of soil each week.

(e) **Tillage** is the most effective method for producing a change of soil air. The best implement for accomplishing this purpose is the plow. When the furrow slice is turned over the shearing produced pulverizes the soil and brings about a complete change of air in all except the granules, and breaking the soil up brings about a much better chance for a change in these. Any form of tillage, however, will materially aid aération. Plowing cloddy ground accomplishes the least. When these clods are thoroughly pulverized much better interchange takes place, and this is one of the great advantages of thorough pulverization of the soil.

(f) **Wind Movement.**—The wind as a general rule moves in gusts, and these passing over a field have a tendency to draw out the air from the soil and aid aération to some extent in this way. Any exact determination of this effect of wind would be very difficult, yet it is probable that on soils having large air spaces, such as cloddy or sandy ones, this plays quite an important part in aération.

Water-logged Soil.—Many soils which have imperfect drainage due to a high water table or an impervious stratum may contain such a large amount of water as to exclude the air, resulting in a very serious condition, so far as the vital soil activities are concerned. The remedy, of course, is drainage, and the drainage should be sufficiently complete so that a heavy rainfall will not saturate the soil for any length of time. If the water table is two or three feet from the surface, a heavy rain may raise this sufficiently to injure the crop unless the soil is thoroughly drained. Many systems of drainage have not been sufficient to lower the water table rapidly and the result is that in wet seasons the crop is badly damaged. Even in moderately wet seasons the crop in the lower places where the water table is near the surface will assume a yellowish-green color, indicating that injury is being done by lack of aération.

Running Together.—Soils that are deficient in organic matter are in condition to be easily puddled, especially the fine and medium grained ones. A heavy rain may be sufficient to do this. The beating of the rain drops breaks the granules into individual particles that render the surface impervious both to air and water, thus cutting off the supply of air. If this condition continues for any length of time, the crop may be retarded in its growth and become of a greenish-yellow color, indicating nitrogen starvation. The remedy, of course, is tillage for breaking the crust and aërating

the soil. If a heavy soil or a soil rich in organic matter should become puddled in this way by a shower, upon drying, shrinkage cracks will be formed through which air may enter. Tillage would not be so necessary in that case. In light sandy soils this puddling will not take place.

QUESTIONS

1. Give uses of air in soils.
2. What are some indications by the plant that oxygen is deficient?
3. Upon what does the amount of air that the soil will contain depend?
4. What causes variations in the composition of soil air?
5. In table on page 310 what is the average amount of nitrogen?
6. How does this compare with the normal amount in air?
7. Define aëration.
8. Why is it necessary?
9. What is diffusion? Illustrate.
10. What effect does porosity have on diffusion?
11. How does temperature affect it?
12. How does removal of water aid diffusion?
13. How much change in atmospheric pressure in a week?
14. What is Boyle's law?
15. What part of an atmosphere is represented by a change of 0.45 inch of pressure?
16. How does atmospheric change effect aëration?
17. Explain the effect of temperature changes on aëration?
18. Give average change for the four months for each depth and for each treatment.
19. How much of a change in volume would occur for each if the soil volume were one-fourth air?
20. Explain the effect of tillage on aëration.
21. Give effect of wind movement.
22. What is a water-logged soil?
23. How may it be avoided?
24. Why is it detrimental to the crop?
25. What effect does running together have on aëration?

REFERENCES

- ¹ Johnson, S. W., How Crops Feed, 1891, p. 219.
- ² Unpublished Data, University of Illinois.

CHAPTER XXV

SOIL ORGANISMS

THE soil contains large numbers of organisms, both plants and animals of various kinds, that act upon both the organic and mineral constituents of the soil. They produce changes, many of which are highly beneficial, while others are detrimental. For convenience they may be divided into macro-organisms, such as rodents and insects, and micro-organisms, those of microscopic size, such as fungi and bacteria.

MACRO-ORGANISMS

1. **Rodents.**—Large numbers of rodents, such as squirrels, rats, mice, prairie dogs and gophers, have the habit of burrowing in the soil, thus facilitating the action of certain agencies. These carry soil upward and a more thorough mixing of the surface and sub-soil is thus brought about. Later these openings are filled with surface soil. Much vegetable matter also is carried into these burrows, which helps in decomposition of the minerals with which it comes in contact. Aëration and percolation are aided by the work of these animals. It is interesting to note that very few burrowing rodents are found in regions of tight clay subsoils.

2. **Insects.**—A great many insects live in the earth during their larval state or even the whole of their lives. The larval stage of insects is their most active period. They are constantly working their way through the soil and in this way aid aëration and drainage. Seventeen-year locusts are very abundant in soils in some local areas. Over 500 exuviae, or cast-off shells, of these insects were counted upon a hawthorn bush not over three feet high. Ants work up their hills, filling them with vegetable matter, and when they are abandoned form very rich spots of soil.

3. **Worms.**—Earthworms are most common organisms and are found in medium and heavy soils of humid areas that are well supplied with organic matter. They do not seem to be so abundant in acid soils, evidently preferring those containing some limestone. They do not live in sands, light sandy loams, arid or semi-arid soils. They aid in aëration and their burrows improve drainage. They pass large quantities of soil through their bodies. The min-

erals are acted upon by the acids of the alimentary canal, producing chemical changes resulting in the liberation of plant food. They carry large amounts of soil from the subsurface and subsoil and deposit it on the surface of the ground, where it may be seen as casts, especially in the morning after a rain. Darwin states that where earthworms abound the amount brought by them forms a layer from 0.1 to 0.2 inch in thickness each year. This amounts to from 15 to 30 tons per acre. Some comparative experiments have been conducted which show that earthworms increase the yield of crops.

4. **Plants.**—The soil is modified to a large extent by the roots of all plants, whether large or small. The short-lived annuals and biennials have the greater effect, because new roots are formed every one or two years. The roots of perennial prairie grasses are great factors in modifying soil because of their great abundance and deep penetration. While most of the roots of trees and shrubs live for years, yet many die every season. Roots of all plants add some organic matter to the soil, but they have another important effect. They make the soil more porous after they decay and thus improve aëration and drainage. Frequently when timber spreads over a prairie area having a tight clay subsoil the ultimate effect of the roots is to lessen the impervious character of the subsoil so that drainage takes place with much less difficulty.

Many fungi live on and in the soil and affect it to some extent. Some aid in the early decomposition of vegetable matter. Others are diseases, such as some smut and scab. Others live in symbiotic relation to certain higher plants. These through the agency of large numbers of hyphæ or fungi rootlets, called *micorhiza*, transfer the food to the companion plant.

MICRO-ORGANISMS

The group of micro-organisms, consisting of bacteria, fungi, protozoa, algæ and yeasts, is of special importance in soils. They aid in the transformation of the vegetable and animal remains into the humus-like residue, which really constitutes part of the soil. They carry on many other operations that benefit soils chemically and to some extent physically. However, the physical condition of soils and the phenomena that occur in them which influence the work and development of these micro-organisms are so important that they merit considerable attention. How the farmer may in-

fluence the work of these organisms is a question that every one interested in agriculture should know. The micro-organisms in the soil are of two general kinds, injurious and beneficial.

1. **Injurious Organisms.**—After a soil has been cropped for a number of years it is frequently found to contain numbers of organisms of various kinds, some of which are not only of no benefit to the crop, but are actually injurious. The number and character of these depend largely upon the crops grown and the rotation practiced. A single crop system is likely to encourage the development of organisms injurious to that crop. Hence a rotation is advisable.

Some of these are the wilt of cotton, flax, cowpeas, probably clover sickness, the scab of potatoes, the rots of many plants. These perish when by rotation they are deprived of their host plants for a few years.

2. **Beneficial Organisms.**—The beneficial organisms comprise a considerable number of forms, but the group of bacteria is of special importance. It would be impossible to grow crops without these. They are the farmer's best friends. They aid him in getting plant food into the soil in the process of nitrogen fixation and are of vital importance in making plant food available, as in the process of nitrification.

(a) **Fixation of Nitrogen.**—Some bacteria in the soil live in symbiotic relation with legumes, producing nodules or tubercles upon the roots. Their function as they grow in this connection is to take nitrogen from the soil air and put it into the plant, in this way storing up or fixing nitrogen. These organisms live in this relationship with legumes and this explains the importance of this class of plants to the farmer. Turning under the legumes enables the farmer to get a supply of nitrogen into the soil with little expense and in a form that is readily available to other plants which can use only soil nitrogen. In general each legume has its own special bacteria.

Another class of bacteria known as *Azotobacter* have the power of fixing nitrogen in the soil directly or independent of any other plant. To what extent this is done is not definitely known, but no doubt it is of sufficient consequence to justify careful consideration in producing favorable conditions for their activity.

(b) **Nitrification.**—The nitrogen of soil organic matter cannot be used directly by our crops. It must first be changed into some readily soluble form, usually nitrates. Some crops, such as rice and

potatoes and possibly others, may use more or less of it in the form of ammonium compounds. By far the larger part is taken up by plants as nitrates. The soil nitrogen must be changed to this form. The process of nitrification is the changing of the nitrogen of soil organic matter into nitrates, and is accomplished through the action of certain classes of bacteria. The steps in the process are as follows:

(1) *Ammonification*, in which the organic matter is decomposed by bacteria and the nitrogen changed into ammonia or compounds of ammonia.

(2) *Nitrification* proper, which consists of the formation of nitrous acid or nitrites from the ammonia or ammonium compounds and the subsequent change to nitric acid or nitrates. This is essentially oxidation. The nitrous and nitric acids unite with a base of the soil. As calcium is one of the most common and readily available bases, calcium nitrate is usually formed.

DISTRIBUTION AND CONDITIONS

1. **Distribution.**—The bacteria concerned in nitrification are very widely distributed in all kinds of soil, with the possible exception of swamp or long flooded soils. They are much more abundant in soils containing limestone than in strongly acid ones. The symbiotic bacteria for legumes are found practically everywhere, but not the specific forms for all legumes. The bacteria for alfalfa are very widely distributed over western regions of the United States, but in the eastern region inoculation, which is the process of supplying the proper bacteria, is necessary. The same is true of many other legumes. Wild legumes sometimes carry the same bacteria as our cultivated ones.

The number of bacteria changes with the type of soil. On the same kind of soil the number of bacteria varies with the degree of fertility, the tilth, and the rotation practiced.

In vertical distribution the bacteria increase in number from the surface downward for four to six inches and then decrease rapidly with depth and are found several feet below the surface only as they are carried downward by percolating water. The zone of greatest number of bacteria is from five to six inches beneath the surface, but it will vary somewhat with the soil type, being a little deeper in well-aërated soils. The optimum conditions of temperature, moisture and aëration are found at this depth. The following

table gives the number of bacteria at various depths under different systems of cropping at the Iowa Station:

Bacteria per Gram of Air-Dry Soil¹—Rotations

Depth of sampling	Continuous corn	Corn, corn, oats, and clover	Corn, oats, clover turned under first season	Corn, oats, clover
4 inches	1,752,000	2,912,000	4,148,250	4,164,000
8 inches	1,248,250	2,027,000	3,591,000	2,943,750
12 inches	546,000	560,500	1,167,750	907,500
16 inches	298,250	316,000	348,250	315,000
20 inches	153,500	256,000	223,000	155,750
24 inches	93,850	89,225	108,750	91,825
30 inches	48,500	49,025	60,125	53,775
36 inches	31,600	32,475	37,625	34,800

It will be noted that the number of bacteria at four inches in depth is greatest in the rotation which brings the clover crop on the land more frequently. The difference is very striking when compared with continuous corn.

The Kansas Station found that the number varied directly with the fertility of the soil.

2. **Conditions for Development.**—It is generally known that most plants require very favorable conditions for their growth, such as food, moisture, heat, air, light, and the physical condition of the soil. The same conditions that are favorable to higher plants are favorable for the activity of bacteria, with the exception of light.

(a) **Moisture.**—Bacterial activity involving chemical change ceases in dry soil. The other extreme, a water-logged soil, is almost equally inhibitive of the action of bacteria. When a soil has approximately half of its air space filled with moisture the conditions are most favorable for bacterial activity and their growth is most rapid.

(b) **Food.**—Organic matter is a very important food for most bacteria, but some of the beneficial organisms obtain their supply of carbon from carbon dioxide. They develop in great numbers in drained soils having an abundance of organic matter. Small amounts of mineral food are required, but soils usually contain sufficient quantities for the use of these organisms. Soluble organic matter in considerable quantities tends to inhibit nitrification. Normal soils contain very little. Large amounts of sewage are not desirable on land because it furnishes soluble organic matter.

(c) **Temperature.**—The optimum temperature for bacterial activity lies between 65 and 95 degrees F. (18 and 35 degrees C.). It diminishes as the temperature increases, and at 130 to 140 degrees F. action ceases and many are killed. Below 65 degrees F. the bacteria become less active and cease at 32 degrees F., although they are not killed. Early tillage, drainage and a dark color raise temperature and encourage bacterial action.

(d) **Aëration.**—Bacteria are divided into two general classes, aërobic, those requiring oxygen for their growth and activity or work, and the anaërobic, which require no oxygen. Aëration is very essential to the first group. Since nitrification is the most important work of bacteria in soils the amount of nitrates produced may be taken as a measure of their activity. Experiments show that in the absence of oxygen not only were no nitrates formed, but the nitrates present were reduced with evolution of free nitrogen. When six per cent of oxygen was present the amount of nitrates formed was double what it was with 1.5 per cent.²

(e) **Reaction.**—Soils giving acid reactions are not very favorable to the work of bacteria. They are more active in soils that are neutral or slightly alkaline. The nitrifying bacteria produce nitrous and nitric acids, which tend to inhibit their action. If bases are present in the soil these will unite with the acids produced, thus keeping the soil neutral or alkaline, and in good condition for their work. Limestone should be applied to the soil to neutralize the acidity.

Crops growing on water-logged soils are usually yellow. This is due to a lack of available nitrates. The water excludes the air and the bacteria cannot do their work. The same conditions exist when a soil in poor tilth runs together and bakes, forming a crust impervious to air. When aëration is produced by cultivation nitrates are formed and a crop such as corn resumes its normal dark green color.

Another important function of aëration is to remove the carbon dioxide of the soil air. This is necessary because it excludes oxygen. In the process of nitrification carbon dioxide is formed. Tillage is the best means of bringing about aëration. Deherain³ conducted an experiment which shows the effect of tillage on aëration and consequently upon the action of nitrifying bacteria. A quantity of soil was thrown upon the floor and worked daily for six weeks. At the end of this time the stirred soil contained 23.7 times as much nitric nitrogen as the soil not disturbed. "Nitrate farming" as

formerly practiced is an application of this principle. The soil rich in organic matter was stirred and moistened to develop a large amount of nitrates, which were then leached out and used for commercial purposes, principally in the manufacture of gunpowder.

*Effect of Different Amounts of Lime Upon the Number of Bacteria per Gram of Dry Soil*⁴

Treatment	Number of bacteria at beginning of experiment	Number of bacteria after 7 weeks
None	504,000	417,000
1000 pounds lime per acre	718,000	1,551,000
2000 pounds lime per acre	657,000	1,322,000
4000 pounds lime per acre	480,000	5,571,000

This table shows the effect of lime carbonate upon the number of bacteria and indicates a much greater development for the higher lime content. An excess of lime is not injurious, as in the case of some other alkaline carbonates as shown in the next table.

*Effect of Alkaline Carbonate Upon Amount of Nitrates Produced*⁵—
1,000 Grams of Acid Soil

Treatment	Nitrates formed
None	70 milligrams
1 gram K_2CO_3	160 milligrams
2 gram K_2CO_3	230 milligrams
3 gram K_2CO_3	250 milligrams
4 gram K_2CO_3	130 milligrams
5 gram K_2CO_3	73 milligrams

(f) **Physical Composition.**—Certain physical phenomena upon which bacteria depend for their greatest activity and development take place better in the medium-grained soils than in very fine ones. Very sandy soils are well aerated, but usually do not contain sufficient moisture and food. Granulation overcomes this in the heavier soils to some extent. Even with this aid aeration and the moisture conditions are not so favorable and nitrification is usually slower. Tillage is more essential for these soils. Where limestone is absent heavy soils may be unfavorable for bacterial activity. Limestone aids in granulation and thus indirectly in aeration.

(g) **Light.**—Direct sunlight greatly weakens or even kills bacteria. The zone of greatest numbers is sufficiently deep so that

sunlight does not penetrate to it. All inoculating material and inoculated seed should be kept from direct sunlight, because of its drying effect.

Loss of Nitrates.—Soils lose nitrates in three ways: by leaching, denitrification and by the growth of weeds or other plants foreign to the crop.

1. **Leaching.**—The greatest loss of nitrates is through leaching. Nitrates are very readily soluble in water. During rains those formed in manure heaps or soil may be carried into drainage systems and lost. That this does occur to a considerable extent is shown by analysis of drainage waters.

Deherain collected drainage waters from cement tanks with results as given in the following table. The tanks had been filled several years before.

*Loss of Nitrates by Leaching*⁶

Cropping	Drainage, inches	Nitrogen as nitric nitrogen, pounds per acre in drainage
Fallow, no cultivation.....	11.2	186.7
Rye grass.....	7.8	2.28
Oats.....	7.3	7.37
Maize.....	6.9	21.60
Wheat followed by vetches.....	6.6	12.60
Wheat.....	7.5	28.70
Fallow, hoed.....	11.5	196.56
Fallow, no cultivation.....	11.2	158.00
Fallow, hoed and rolled.....	11.2	183.20
Vine.....	7.5	36.20
Sugar beet.....	7.2	0.27

The rainfall during the season was 28.8 inches. It is very interesting to note the effect of the crop on the amount of drainage and also on the nitrogen removed with the water. Catch crops are of value in preventing loss of nitrogen in this way. Even weeds may serve as a catch crop after the main crop is removed.

Fallowing (leaving land without a crop and cultivating during summer) in humid areas is a very expensive operation and should never be practiced. It will not be necessary if the organic matter is properly maintained. Fallowing is resorted to when the active organic matter has been largely removed by cropping and some special means must be taken to render the less active form available. This is accompanied with too much loss of the most expensive plant food, nitrates in soils, to be profitable. In the above table

the loss of nitrates by leaching from fallowed land is 181.1 pounds per acre, while the cropped land shows an average loss of 15.6 pounds, or only one-tenth the amount of the fallowed.

2. **Denitrification.**—Nitrification is an oxidation process, while denitrification is one of reduction or deoxidation by which nitrates are broken down and free nitrogen given off. In other cases the change may be such as to form nitrites or ammonia. In the latter the nitrogen may not be lost from the soil by it. It takes place in soils when poor aëration results in a deficiency of oxygen, as in heavy, compact, puddled, or water-logged soils. Manure contains large numbers of denitrifying bacteria and extremely heavy applications of coarse manure may result in some loss through the action of these organisms.

QUESTIONS

1. What kinds of organisms are found in the soil?
2. What are macro-organisms? Micro-organisms?
3. Give the effects of rodents on the soil.
4. Give the work of insects in soils.
5. Where are worms most abundant?
6. What work do they perform in soils?
7. Give Darwin's statements of the amount of material brought to the surface.
8. Give the effects of plants on soils.
9. What is the work of micro-organisms in soils?
10. What part do fungi play?
11. Tell about the injurious forms.
12. Give the two methods of fixation of nitrogen.
13. What is nitrification?
14. Tell about the steps in the process.
15. Where are soil bacteria most abundant?
16. What about the distribution of bacteria?
17. How do the number of bacteria vary?
18. How are they distributed vertically?
19. What effect do different systems of cropping have?
20. What two general classes of bacteria?
21. Give the characteristics of each.
22. Of what use is aëration to bacteria?
23. Give the experiment by Hall.
24. What was "nitre farming"?
25. Why should bacterial activity almost cease in soils of extreme moisture content?
26. What temperatures are best for the work of bacteria? What are detrimental?
27. What are the foods of bacteria?
28. What part does the reaction of the soil play in bacterial activity?
29. What conclusion do you reach from tables on page 321?
30. Why should the physical composition of the soil affect bacterial activity?
31. Give the effect of sunlight on bacteria.
32. How are nitrates lost from soils?

33. Give conclusions from table on page 322.
34. What effect did cropping have on drainage?
35. What is fallowing?
36. Why should there be such a large loss of nitrates from the fallowed land?
37. What is denitrification?
38. Under what conditions does it occur?

REFERENCES

- ¹ Brown, P. E., Research Bulletin 8, Iowa Station, Bacteria at Different Depths in Some Typical Iowa Soils, p. 289.
- ² Schlösing, Compt. Rend. Academy of Science, Paris, vol. lxxvii, pp. 203-253.
- ³ Deherain, Compt. Rend. Academy of Science, Paris, vol. cvi, 1893, pp. 1091-97.
- ⁴ Chester, Frederick E., Bulletin 98, Department of Agriculture, Pennsylvania, 1902, p. 25.
- ⁵ Dumont, Compt. Rend. Academy of Science, Paris, vol. cxxv, 1897, pp. 469-72.
- ⁶ Deherain, Noted by Hall, A. D., The Soil, 1912, p. 228.

CHAPTER XXVI

TILLAGE

IN the time of Jethro Tull (1674-1741) the present theory of plant nutrition had not been advanced, and this well-known husbandman frequently made the statement that "tillage is manure." While his theory was wrong, yet his practice was right. He believed that the object of fining the soil was to enable the plant to take up the small particles for growth. The practice resulting from this belief was as good as would have been brought about had the real theory of plant nutrition been known. We know now that the purpose of tillage is not to furnish fine particles of soil for the plant. However, tillage accomplishes a number of objects, many of which are closely related to the production of plant food for the crop.

Tillage is the practice of working the soil for the purpose of bringing about more favorable conditions for germination and plant growth. All operations that affect the soil by stirring, inverting, fining, or firming are included in tillage. The most common are plowing, harrowing, rolling, and cultivating.

THE OBJECTS OF TILLAGE

1. **Pulverizing and Loosening the Soil.** — The natural tendency of soils is to become compact, principally through the action of rain, and in spite of the influence of the roots of plants and the organisms in the soil whose tendency is to keep the soil loose and in good tilth. It is necessary, then, to stir the soil to allow the fundamental processes that are vital to crops to take place. On the brown silt loam of the corn belt a rotation of corn, corn, oats, and clover was practiced. The soil was plowed preceding the oat crop and at no other time. The two crops of corn were planted in the unplowed soil, and a yield of 35.2 bushels per acre was produced as a nine-year average. The plowed land produced 13.7 bushels more.¹

2. **Turning under vegetable matter and incorporating it and other fertilizers with the soil.** In our farm practice it is necessary to maintain the supply of organic matter, and this can be done only by incorporating large quantities of vegetable material in the soil. When plants die and fall to the surface of the ground, unless some

means is taken for mixing them with the soil they decompose almost entirely, leaving little more than the ash of the plant to mix with the soil. Even if this mixing were not necessary the vegetable material would interfere with cultivation if left on the surface. The plow is the best implement for covering all organic material, such as crop residues, weeds, and farmyard manure.

3. **Killing Weeds.**—A most important object of tillage is killing weeds. We see demonstrations everywhere of the fact that ordinary crops amount to very little when in competition with weeds. A weed is a better forager than a cultivated plant, and hence will deprive it of both moisture and food, and it is necessary for successful crop production that the weeds be destroyed. Tillage is the best means so far devised for accomplishing this purpose. In some cases, however, sprays have been used successfully, and if sprays could be found which would not injure the crop, but would kill the weeds, there is no question but that much of our tillage could be dispensed with.

4. **Storing and Conserving Moisture.**—Plants require an abundant supply of moisture for their germination and growth. In nearly all climates through uneven distribution of rainfall the necessity exists for storing moisture in the soil when it can be obtained and for conserving this for the use of the crop later. The early preparation of the soil by loosening and compacting slightly is the best means for storing the supply of this for future use. Loosening the soil allows rapid absorption with little run-off, while stirring the surface soil later prevents any excessive loss through evaporation. Of these two under ordinary humid conditions, the preparation of the soil for storing the moisture is of much more importance than subsequent tillage for retaining it when a crop is growing. Previous to the planting of the crop the soil should be kept stirred.

5. **Compacting the Soil.**—It frequently becomes necessary after a soil has been plowed to compact it in order to close any large air spaces that may exist in the plowed soil and also bring the furrow-slice in close contact with the soil beneath it so that capillary action may not be cut off. At the same time that the compacting is done the soil should be pulverized, thus making a better seed bed for the crop.

6. **Planting the Seed.**—While there is not much of what we usually call tillage in the ordinary seeding of crops, yet all seeding is accompanied by more or less working of the soil.

IMPLEMENTS OF TILLAGE

Tillage implements are divided into five classes—plows, harrows, compacters, seeders, and cultivators.

1. **Plows.**—The mold-board plow is one of the most common as well as one of the best implements for loosening the soil and

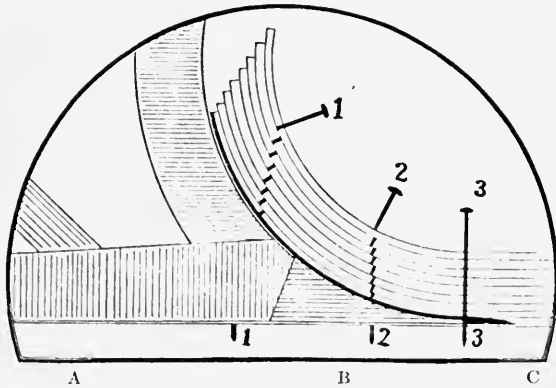

FIG. 137.—Diagram showing the theoretical action of the plow. The sliding or shearing is accompanied by more or less of a rolling action, all of which pulverizes the soil. (King.)

turning under vegetable material. It brings about almost a complete inversion of the furrow-slice, and in doing this pulverizes the soil. The mold-board is of such a curvature that when the soil passes over it, it produces a shearing force in the soil as if made up of different layers somewhat similar to the effect of bending several leaves of a book and brings about pulverization (Fig. 137) if the

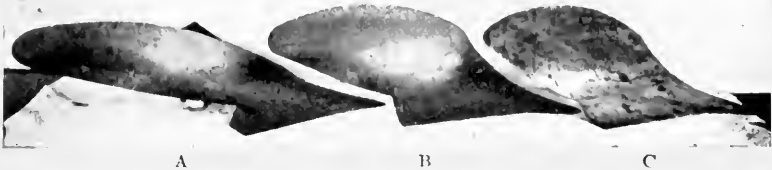

FIG. 138.—Showing the three types of mold-boards. A-Sod. B-General purpose. C-Stubble.

soil is in good condition for plowing. If too dry so that the soil is cloddy little pulverization is accomplished. If the soil is too wet for plowing this shearing breaks down the granules, producing partial puddling, very injurious to the soil. The plow should be set so that the furrow-slice will be cut free from the soil beneath and practically all inverted. Mold-board plows are divided into stubble, general purpose, and sod plows.

The stubble plow (Fig. 138C) has a short, strongly curved mold-board and is probably the best form to use in old land. In general the more curvature or twist there is to the mold-board the greater the pulverization, the better is the condition of the soil after plowing, provided it has the proper moisture content. This plow is not desirable to use in breaking sod, because of the rough condition in which it leaves the surface. The jointer is sometimes used

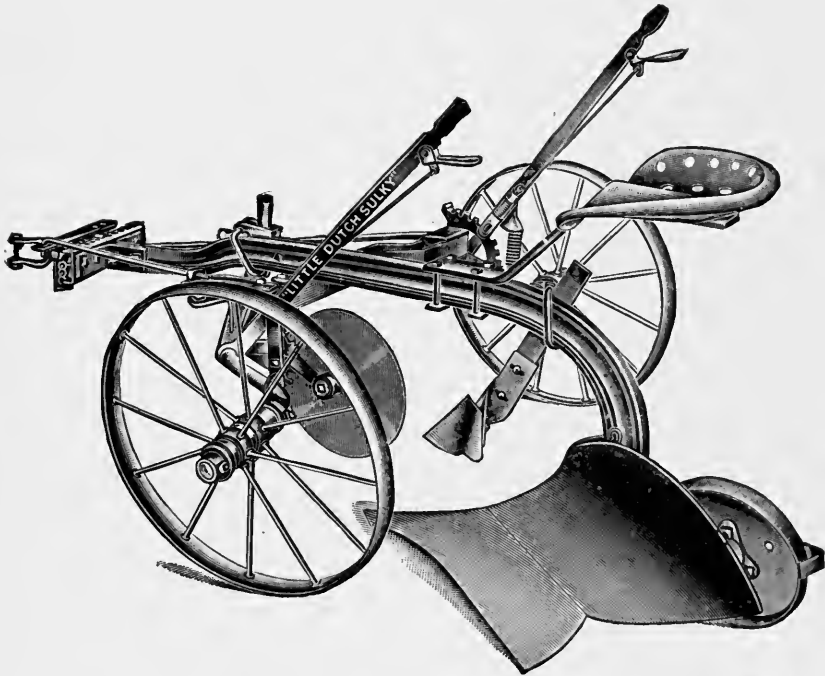

FIG. 139.—Plow with separate jointer and rolling coulter attached ready for use. (Moline Plow Company.)

in the plowing of light sods, as it materially aids in turning under and preventing the further growth of grass (Figs. 139 and 140).

The general purpose plow (Fig. 138B) is a form intermediate between the stubble and sod plows in length and curvature of mold-board. It may be used for either stubble or sod. It does not pulverize the soil so thoroughly as the stubble mold-board, and as a consequence it leaves sod in much better condition for working into a good seed bed. For all uses it is probably the best.

Sod plows (Fig. 138A) have long, slightly curving mold-boards that do the minimum amount of pulverization in turning the furrow-slice. They are used principally in the plowing of tough grass sods, since they turn the furrow-slice without breaking it very much, thus leaving a comparatively smooth plowed surface. This has some advantages in the production of a seed bed.

A form of the mold-board plow known as the *hillside* or *swivel plow* may be reversed so that the soil may all be thrown in one direction.

The disk plow (Fig. 141) may be used under some conditions to good advantage. If the soil is quite compact and dry it may be used where it would not be possible for the mold-board to do any work at all. It has this other advantage, that it does not tend to produce a plowpan, because the furrow-slice is

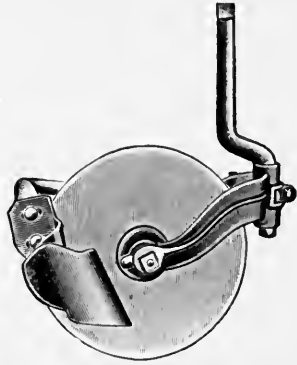

FIG. 140.—The combined jointer and rolling coulter is a good attachment for all plows. (Moline Plow Company.)

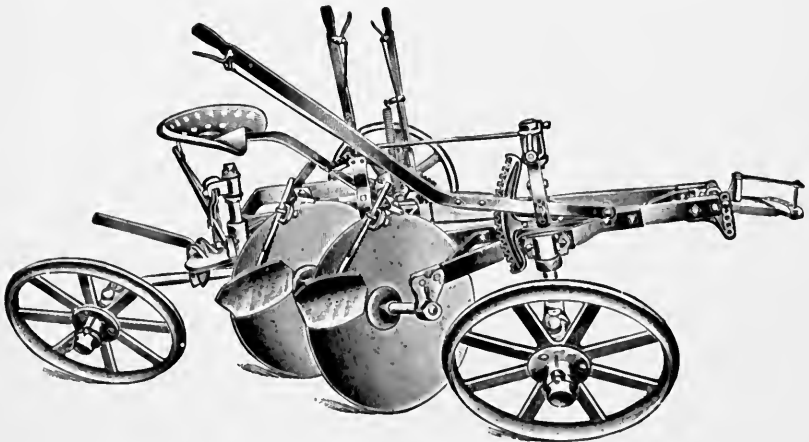

FIG. 141.—Disk plow. (Moline Plow Company.)

broken off rather than cut off. Under some conditions it turns rubbish under better. Disk plows are extensively used in arid and semi-arid regions, but may be used successfully on almost any soil.

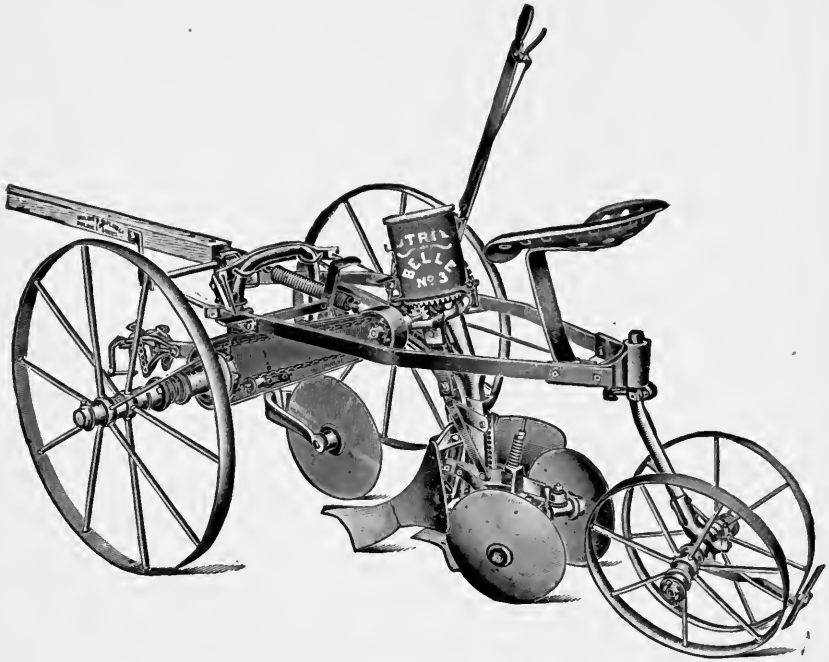

FIG. 142.—Lister for preparing the ground and planting corn. Used chiefly in the semi-arid regions. (Moline Plow Company.)

A *reversible disk* for hillside plowing has some advantages over the ordinary reversible mold-board plow.

A **deep tilling, double disk plow** for stirring the ground to a depth of 16 to 18 inches is used in some sections. This does not, however, bury the surface soil to so great a depth as would be indicated, but mixes this deeper soil with the surface to a greater or less extent. The disk plow cannot be used in stony land successfully, particularly where the stones are firmly set in the soil.

The lister (Fig. 142) is a plow used particularly in semi-arid regions for the preparation of the ground for corn planting, and even for other crops. It is a double mold-board plow, and when used opens a furrow in which the corn is planted. It ridges the land and gives the soil an excellent chance to weather (Fig. 143).

The subsoil plow (Fig. 144) is used to loosen the soil in the bottom of a furrow made by the ordinary plow. It consists of a shoe which merely raises the soil, but does not throw it out.



FIG. 143.—Work done by lister. (Kansas Station)



FIG. 144.—Subsoil plow.

2. **Harrows.**—The spike-tooth harrow is the form commonly used and is very effective in pulverizing and slightly compacting freshly plowed land. In some places the "A" harrow, with square teeth, is still extensively used, and is especially desirable in stumpy land. The lever harrow (Fig. 145) of two to four sections is very commonly used, sometimes with a riding attachment. The levers permit the slanting of the teeth so that any rubbish will easily pass out of the harrow.



FIG. 145.—Spike-tooth harrow



FIG. 146.—Spring-tooth harrow.

The spring-tooth harrow (Fig. 146) is used quite extensively in regions where the soil is in rather poor physical condition and where it is necessary to cultivate as well as harrow. After a rain

this harrow will do more efficient work in loosening the soil than the ordinary spike-tooth harrow, and for that reason is used mostly

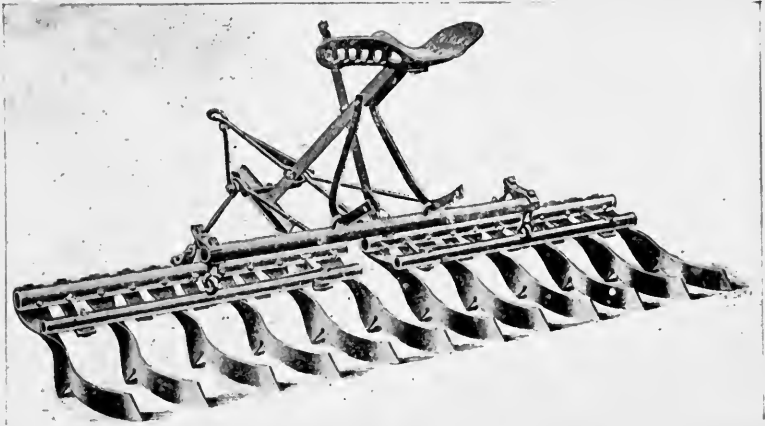

FIG. 147 —Acme blade harrow.

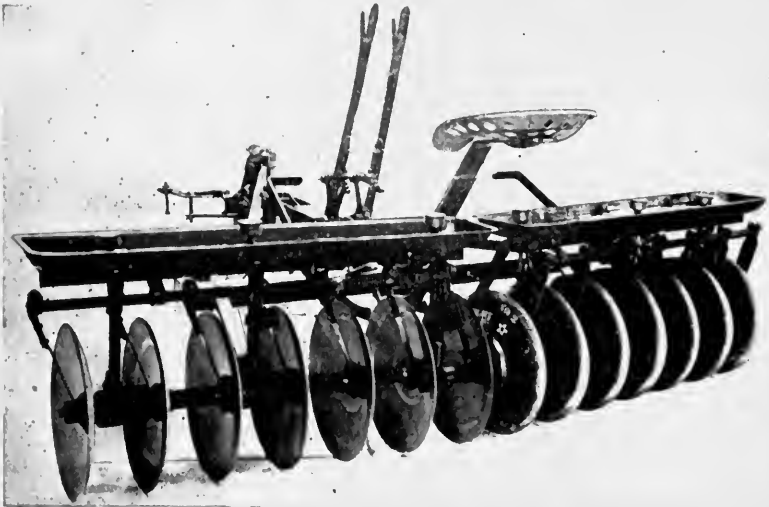

FIG. 148.—The solid disk.

on soils that are deficient in organic matter. It is a very good implement to use in the cultivation of alfalfa.

The **Acme or blade harrow** (Fig. 147) is used to some extent, and is an excellent implement to pulverize and compact the soil.

The bar in front, if properly adjusted, crushes clods, while the twisted blades stir the soil and destroy any weeds that may have started. For this purpose it is better than the spike-tooth harrow.



FIG. 149.—The cut away disk.

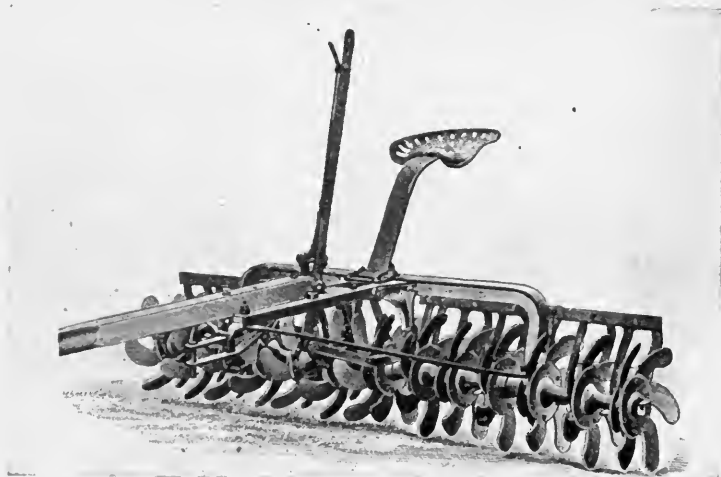

FIG. 150.—The spading disk harrow.

The disk harrow (Figs. 148, 149 and 150) is made in three forms—the solid disk, the cut-away, and the spading disk. The first two act somewhat the same as the disk plow, but do not turn the dirt so thoroughly, yet are very effective in stirring the soil. The

degree of effectiveness, however, may be increased or diminished by adjusting the angle of the disk with the direction of movement. Next to the plow the disk is one of the most important and useful implements. It may be used very effectively before the plowing is done, and is one of the best tools for the preparation of a seed bed. Either the solid disk or the cut-away may be used to excellent advantage in cutting up corn-stalks and other vegetable material and mixing them with the soil before plowing. This insures the close contact of the furrow-slice with the soil beneath. A small rotary spading harrow is sometimes attached to the plow.

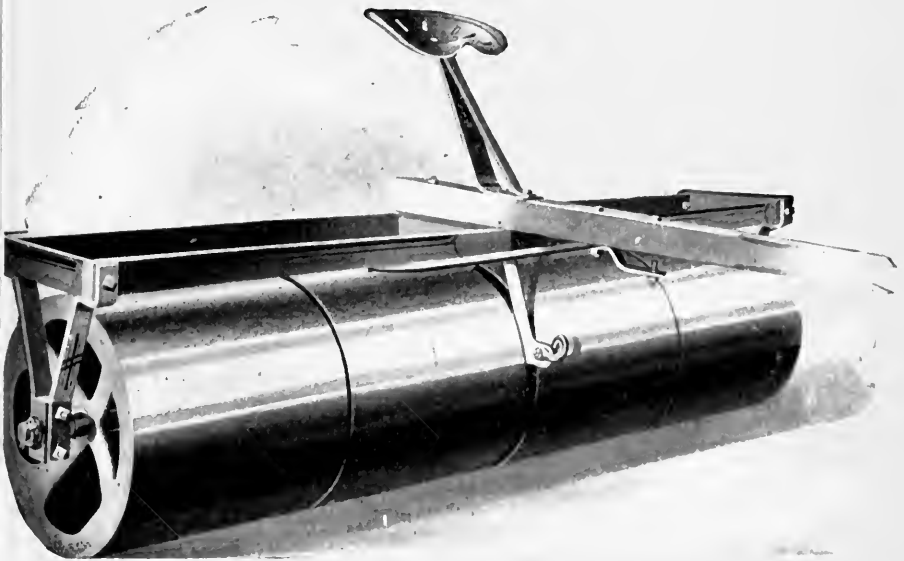

FIG. 151.—Smooth or drum roller.

3. **Compacters.**—Compacting is necessary because most of our crops require a firm but mellow seed bed. In many cases in our heavier soils clods are formed which require the use of the roller to crush, while in the case of sands, sandy loams, and many silt loams the soils are so loose that root development and moisture retention are interfered with. In arid and semi-arid regions the subsurface compacter is used to prevent the excessive loss of moisture through any large air spaces that may exist in the soil. The packing also increases upward capillary movement of soil moisture, and consequently less water is lost by the downward movement.

The smooth or drum roller (Fig. 151) is used quite exten-

sively, but is not as effective as some other forms and is gradually being replaced. When used for crushing clods these are frequently pressed into the soil without being affected to any extent, and a subsequent harrowing before a rain usually brings them to the surface again. Its use greatly increases evaporation of moisture.



FIG. 152.—The culti-packer, a form of corrugated roller, showing the work done.

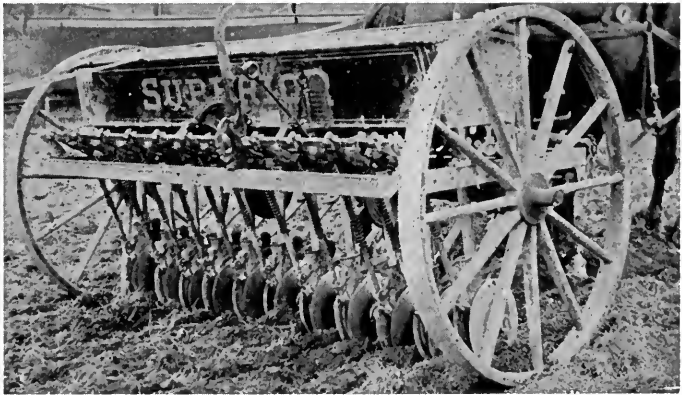

FIG. 153.—Disk drill and its work.

Corrugated Roller.—The smooth form of roller is gradually being displaced in the corn belt by the culti-packer or *corrugated roller* (Fig. 152), which consists of a series of wheels with a sharp ridge about two to two and one-half inches in height. This implement is much more effective in crushing clods and leaves the ground covered with a thin mulch.

The **bar roller** is another form, made up of a series of bars running lengthwise of the roller. This implement is better than the ordinary drum roller, but is not as effective as the corrugated roller or culti-packer.

Plankers made by bolting together two or three two-inch boards so that they lap about half may be used to good advantage for crushing clods and levelling without compacting to any extent.

The **Campbell subsurface packer** (Fig. 107, page 247) is used in arid and semi-arid regions. Its special advantage is that it compacts deep, freshly plowed soil, leaving a mulch on the surface. It consists of a number of wheels with a wedge-shaped edge. These are about five inches apart and revolve independently of each other. As this wheel presses in, the soil is pushed to both sides,

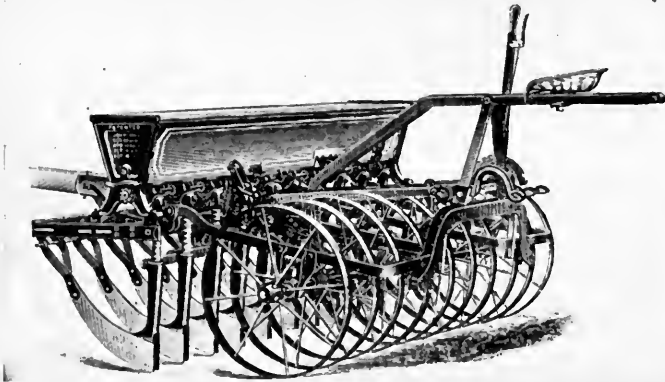

FIG. 151.—Press drill

thus closing the air spaces, leaving a loose mulch on the surface. This may be used in sandy soils in humid regions to very good advantage.

4. **Seeders** (Figs. 153, 154, 155).—The tillage done by seeders is purely incidental, yet in many cases very essential. Drills almost invariably till the soil to a considerable extent in opening a furrow every six to eight inches in which to deposit the seed. Where press drills are used the soil is compacted upon the seed. In the planting of corn with the ordinary planter the tillage is similar to that of the press drill, but not so extensive. Many broadcast seeders, however, accomplish no cultivation.

5. **Cultivators**.—Cultivators are for use in intertilled crops. Some stir the soil to a depth of one inch or less, while others work

to a depth of four inches or more. They may be divided into shovel, disk, blade cultivators, and weeders.

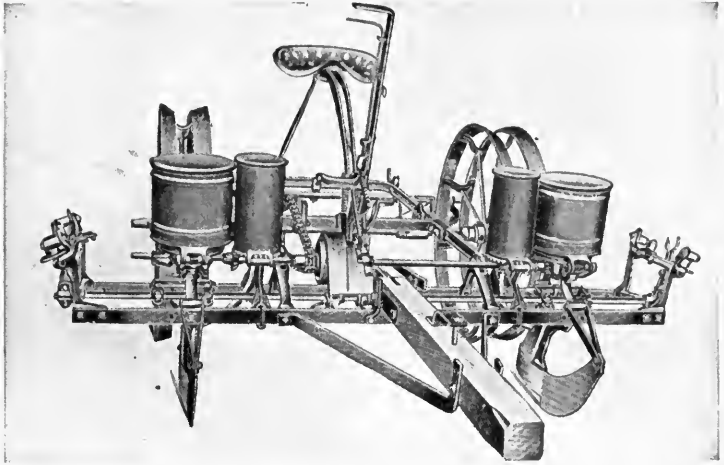

FIG. 155.—Ordinary corn planter with attachment for planting cowpeas in hill or row with corn.



FIG. 156.—Three-shovel cultivator.

The shovel cultivators (Fig. 156) vary in the number and size of the shovels used. There may be two large shovels on each gang, three medium, or four small ones. The depth to which they go varies directly with the size of the shovels. It is not unusual to

see cultivation done over four inches deep with the large or medium shovel. There are two types of cultivators with four or five small shovels in each gang—the eagle claw and the spring-tooth. These penetrate the soil to a depth slightly more than two inches. A form of the shovel plow is made by replacing the inside shovel with a little diamond or bar share plow by which the soil is thrown up into a high ridge along the corn row.

The disk cultivators (Fig. 157) consist of three disks on each side and may be used to good advantage where the bind weed or wild morning glory abounds. As these cultivators are commonly used the disks are set to run deep and corn-row ridges result. They

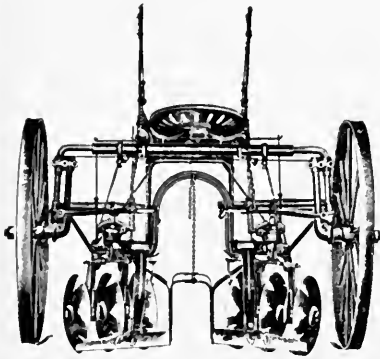

FIG. 157.—Disk cultivator.

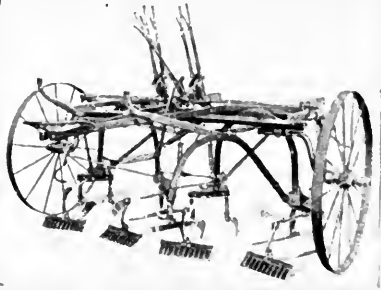

FIG. 158.—Surface or blade cultivator with leveler.

may, however, be adjusted to run shallow and leave the soil comparatively level.

Blade cultivators (Fig. 158) consist of four blades, two to each gang, from 12 to 18 inches long and two to three inches wide. These are placed at an angle such that there is a slight tendency to move some soil toward the row, but most of it falls over the blade, leaving a loose mulch. This implement is very satisfactory for shallow cultivation, and may be so adjusted as to stir the soil to a depth of three inches or more. Cultivation to this depth, however, is seldom advisable because of the injury to the roots. The blades cover the entire space between the rows, so there is very little chance for weeds to escape. "A"-shaped blades are being used to some extent. The sweep is a modification of the blade cultivator. Each of the above is made in both one- and two-row forms. Various implements for use with one horse are found, such as the double-shovel, the five-shovel, and fourteen-tooth cultivators.

The **weeder** (Fig. 159) consists of a large number of narrow spring teeth well adapted for shallow cultivation of such crops as corn, cowpeas and beans in humid sections and for most of the crops in semi-arid regions. For this implement to do its best work

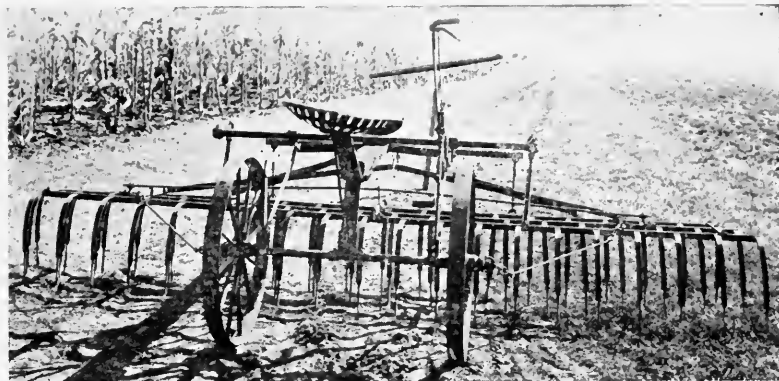

FIG. 159.—Weeder.

the soil should be mellow and in good tilth and the weeds small, but if the soil is compact or the weeds quite large it is of little value.

PLOWING

Plowing is an art. It is one of the most important as well as the most common methods of preparing the soil for the crop. From



FIG. 160.—An early form of plow.

the beginning of agriculture some form of plow has been in use. Even at the present time in some countries the plow is a very primitive implement, as shown in Fig. 160, and does very inefficient work. In North America we find the two extremes. In parts of Mexico the people are still using the most primitive form of plows. In the

wheat region of the northwest the powerful tractor, with its six to ten plows and accompanying disks and harrows, may be seen preparing the soil for the crop. These improvements have materially reduced the cost of raising a bushel of wheat. In the southern part of the United States many one-horse plows are used. Plowing, when well done, accomplishes more of the objects desired in tillage than any other operation. The plowing done by the crude implements of primitive peoples falls far short of good results. It enables them, however, to put their soil in somewhat better condition, and without doubt they grow larger crops than without even this simple operation.



FIG. 161.—The soil is well turned and represents good work.

Good plowing saves labor in the preparation of a seed bed. It gives all plants of the crop an equal chance and all a much greater advantage than on poor plowing. For good plowing the following things are essential:

1. The entire furrow-slice should be cut loose from the soil beneath and all turned. In other words, "cutting and covering" is not good plowing.

2. The plowing should be done to a certain depth to produce pulverization. In most cases the soil is not pulverized to any extent when the furrow-slice is only three or four inches thick. For best pulverization plowing should be done five to seven inches deep.

3. The turning under of rubbish is essential to good plowing. To do this properly the furrow-slice must be five or six inches thick, and in some cases chains or weed hooks are necessary.

4. The furrow should be kept straight or at least parallel with the middle ridge, as a crooked furrow almost always indicates "cutting and covering" at some points.

1. **Time of Plowing.**—The time when plowing should be done varies with climatic, crop, and soil conditions. In semi-arid regions



FIG. 162.—Good plowing in stubble land. (Janesville Machine Company.)



FIG. 163.—A crooked furrow does not look well, even if the plowing is good.

plowing should follow the preceding crop as soon as possible. The primary object to be accomplished is conservation of moisture. In humid regions the time of plowing depends upon the crop to some extent: The plowing for wheat and rye must be done in summer, while for corn, cotton, oats, barley, cowpeas, and soybeans it may be done either in fall or spring.

(a) **Fall Plowing.**—If the plowing is done in the fall the ground should be plowed as late as possible unless a catch crop is planted to conserve the available nitrates. When the ground is stirred by the plow it produces conditions very favorable for nitrification, which takes place at the expense of the organic matter in the soil, resulting in the production of soluble plant food that may be leached out of the soil during the winter and spring. If a catch crop is grown the plants take up the soluble plant food and preserve it. In the case of very late fall plowing the conditions are usually not favorable for any large amount of nitrification, and the result is that little soluble plant food will be formed before winter.

The soil never becomes too dry to be plowed in the fall when looked at from the standpoint of benefit to the soil. It may become so dry, however, that it will be impossible from a power standpoint to do the work with horses. The tractor may be used to good advantage under these conditions.

There are several important advantages in fall plowing: first, the work may be done at the time of the year when other work is less pressing; second, the organic matter turned under during the fall has sufficient time to partly decay before the crop is put in, thus liberating the plant food and giving the soil time to settle and re-establish capillary connection; third, many insects and their eggs are destroyed by disturbing them late in the fall, which is especially true of the ant hills containing the eggs of the corn root aphid; fourth, the improvement of the tilth of the soil by exposing it to freezing and thawing and wetting and drying during winter and spring, producing a granular condition that is very desirable. This is especially true of heavy soils containing a fair supply of organic matter.

As a general rule, soils deficient in organic matter do not receive as much benefit from fall plowing as soils well supplied with this constituent. If deficient in organic matter, freezing and thawing cause the soil to run together instead of producing granulation. Timber soils generally are not as well adapted to fall plow-

ing as prairie soils because of the lack of organic matter. Even the lighter colored phase of brown silt loam packs badly during winter. If fall plowed, sandy loams are liable to be damaged by blowing. Heavy soils are especially benefited by fall plowing.

(b) **Spring Plowing.**—A very large amount of plowing must necessarily be done in the spring because the crop of the preceding year was not taken off in time for fall plowing. It is very essential that some preparatory work be done previous to the plowing. This should usually consist of thoroughly disking (Fig. 164) the ground to cut up the vegetable material and mix it with the soil so that, when the furrow-slice is turned and compacted slightly, close capillary connection may be established at once. Where corn-stalks are to be turned under, as is frequently done in the corn belt, the cutting



FIG. 164.—Previous to plowing, disking should be done to cut up the corn-stalks or other vegetable matter and produce a deep mulch.

up of the stalks by the disk is a very important process, since when plowed the fine soil filters in around the stalks and does not permit the formation of large air spaces that aid in drying the soil. This disking will also prevent evaporation, so that if plowed later it will be comparatively free from clods.

2. **Depth of Plowing.**—Poor and badly-worn soils should be plowed deeper than rich, productive ones. Our cereals and grasses are shallow rooting plants, the major part of the roots developing in the plowed soil. This forms their natural and most accessible feeding area. Within certain limits the deeper the plowing the better the chance of the crop for getting an abundance of food. If the plowing is done too deep the surface soil with its swarms of bacteria will be buried below the zone of most favorable action and a smaller amount of available food will be developed for the

crop. Experience indicates that eight or nine inches is about the limit. For rich, deep soils six to seven inches is sufficient. This gives a deep reservoir for water storage and an abundance of soil for root development.

Deep Tilling.—Deep tilling plows have been put on the market, by which plowing may be done to a depth of twelve to eighteen inches. As a result of nine tests for corn, the yield was 2.7 bushels higher for ordinary plowing than where plowed twelve to fourteen inches deep. This may have some advantages for alfalfa and other deep-rooting crops. The Kentucky Station found an increase of 416 pounds of alfalfa hay in two cuttings in favor of deep tilling.

Subsoiling.—Subsoil plows have been used for loosening the soil to a greater depth than is possible with the ordinary plow. This practice was more common a few years ago than at present. The results do not indicate that the operation in humid soils is of very much value. As a result of 40 tests in southern Illinois the subsoiled land gave an average of 2.7 bushels less than the land not subsoiled.¹ This practice may have some value in semi-arid regions and for certain crops, but it is certain that it has very little value for the principal cereal crops in humid regions.

Dynamiting.—The use of dynamite for breaking up the impervious or hardpan subsoils has been resorted to in some cases. This is a good practice where trees are to be planted. A charge of dynamite is exploded and the tree is planted in the loose soil thus produced. The expense involved in breaking up the subsoil in this way makes the practice almost prohibitive for ordinary crops, unless the increase in yield is much greater than the experiments up to the present would indicate.

Effect of Deep-Rooting Crops.—Without much doubt nature has provided the best method of deep tillage. This is by means of deep-rooting plants, and more especially legumes. A crop of red, mammoth, sweet clover or alfalfa fills the soil with roots and leaves it open and readily permeable to water and air. These roots extend to a depth of several feet and render heavy clays pervious, bring plant food from the subsoil to the surface, and benefit such soils in various other ways. The crop should be seeded much thicker than is done ordinarily. There should be from six to twelve or more plants to the square foot, as one plant to the square foot is of comparatively little benefit.

Preparation of the Seed Bed.—The ordinary farm crops require better conditions for their growth than the wild plants with

which we are familiar. The soil in which they grow must be sufficiently loose so the roots have little difficulty in penetrating it. The growth they make depends to a large extent on the area over which the roots spread. Hence the necessity of producing a deep, mellow seed bed that will allow free root development.

Clods are of no value in a field, but are always a source of annoyance. They are generally the products of shiftless and unscientific methods of farming rather than of some inherent fault or bad quality of the soil. Soils if worked at the proper time and after proper preparation respond to good tillage. The disk is one of the best implements for preventing the formation of clods and, together with the culti-packer, for destroying them if they once form.



FIG. 165.—Grain produced from five tenth-acre plots prepared in different ways for winter wheat. (L. E. Call.) Kansas Station.

Clods are of no use to a growing crop, but on the contrary lock up large quantities of food and become prisons for millions of bacteria that would otherwise be working for the farmer. Fields are sometimes seen in which at least one-third of the plant food of the plowed soil is locked up in clods. Even if the clods are turned under and covered by mellow, moist soil, weeks are required before they become thoroughly moistened unless rain falls.

1. **Wheat.**—Plowing for wheat should be done as soon as possible after the removal of the preceding crop and from five to seven

inches deep. If the ground is dry or liable to become dry before plowing can be done clods may be prevented from forming by thorough disking. This kills weeds and produces a mulch which conserves moisture and later plowing may be done very satisfactorily without any great amount of clods. The impression prevails that since wheat is a very shallow rooting plant the plowing should be done somewhat shallow, but experiments show that a depth of seven inches is not too deep (Fig. 165). Immediately after the plowing is done it is necessary to work the soil by means of a disk and harrow

Methods of Preparing Land for Wheat² (Continuous Wheat)

Method of preparation	Average of 3 years, 1911-1913		
	Yield per acre, bushels	Cost per acre for preparation	Value of crop less cost of preparation*
Disked, not plowed.....	6.63	\$2.07	\$3.64
Plowed, Sept. 15, 3 inches deep.	13.24	2.83	8.35
Plowed, Sept. 15, 7 inches deep.	14.15	3.33	8.60
Plowed, Aug. 15, 7 inches deep (worked).....	22.19	4.00	16.34
Plowed, Aug. 15, 7 inches deep, not worked till Sept. 15.....	20.48	3.33	13.65
Plowed, July 15, 3 inches deep (worked).....	20.77	4.85	12.25
Plowed, July 15, 7 inches deep (worked).....	27.11	5.35	16.87
Double disked July 15, plowed Sept. 15.....	19.71	3.93	12.37
Double disked July 15, plowed Aug. 15 7 inches deep.....	23.40	4.93	14.30
Listed July 15, 5 inches deep, ridges split Aug. 15.....	22.90	3.92	14.73
Listed July 15, 5 inches deep; worked down.....	22.77	4.05	14.53

*Wheat market value when threshed.

to conserve moisture, develop plant food, and, most important of all, prevent the growth of weeds. The seed bed for wheat must be firm. If the soil is very open at seeding time the freezing in winter will have a greater tendency to heave the soil and kill the wheat, especially if the land is not well drained. The roller or culti-packer can be used to excellent advantage in the preparation of the seed bed for this crop.

In seeding wheat in corn ground after the corn has been taken off the field for the silo, or placed in the shock, a sufficiently good seed bed may be produced with the disk. The settling of the soil

during the summer will make it sufficiently compact and a thin stratum of two to four inches in depth mellowed somewhat by the disk will provide an excellent seed bed. Wheat is sometimes seeded in the standing corn and in such case no preparation is necessary. The crop is handicapped, however, because the corn has left the soil in poor condition in regard to moisture and plant food.

The preceding table shows that deep, early plowing with working till seeding time has given the greatest profit.

The soil for wheat should be well drained. This is very essential, especially in temperate regions where freezing and thawing occur. The great objection to growing wheat formerly was the winter killing caused by a poorly drained seed bed.

2. **Corn.**—The plowing for corn may be done either in fall or spring and the production of the seed bed is somewhat different in



FIG. 166.—A good seed bed on stalk ground.

the two cases. With fall plowing the ground should be disked or worked in some way as early as possible in the spring to a depth of three to five inches. This conserves moisture, raises the temperature of the soil and destroys any weeds that may have started. This disking should be continued at intervals of ten days or two weeks until the time for planting. The object is to destroy as many weeds as possible before the crop is planted, as cultivation for this purpose is much more effective at this time. The disking should be done deep to thoroughly aerate the soil and encourage the development of plant food. Corn on fall-plowed land is said by some farmers to “fire” easily. This “firing” may be due to two causes: first, to lack of moisture, and, second, to lack of available nitrates. Fall plowing, unless the soil is in good tilth, tends to dry out early

and rapidly. The rains have compacted it, the ground is bare, and with the strong winds of March and April there is nothing to prevent rapid loss of water. Deep, early disking in the preparation of the seed bed will conserve moisture and in this way tend to eliminate this danger from "firing." Thorough and deep disking also encourages the formation of large quantities of available nitrates. In the case of shallow and insufficient disking the fall-plowed land is left compact and somewhat cloddy, with conditions for nitrification and conservation of moisture very unfavorable. Such preparation has a tendency to encourage "firing."

The preparation of the seed bed from spring-plowed land does not require so much working during the average season as for fall-plowed land. The ground should be thoroughly worked with disk or harrow immediately after plowing. A rotary harrow attached to the plow does good work. This working should be continued at intervals the same as for fall plowing. When ready to plant, the harrow may be sufficient to put the soil in fine condition (Fig. 166). All weeds should be killed. If very few rains occur in the spring after plowing is done it may be necessary to use the roller, since corn, like wheat, requires a firm seed bed with a mellow surface. Too much work can never be done in the preparation of the seed bed. The best time to destroy weeds in corn is before the crop is planted. The cultivation at that time is much more efficient than at any time thereafter.

3. **Oats.**—The almost universal practice in the corn belt is to sow oats where corn grew the preceding year. It was an early practice in some regions to sow the oats in February or March without preparing any seed bed whatever. Sometimes fairly satisfactory results were obtained. But as the physical condition of the soil became poorer the necessity for a better seed bed for the oat crop has become more imperative. A very good way for preparing the ground for oats is to plow it in the fall and then disk thoroughly in the spring. In the corn belt, however, the apparent necessity for pasturing the corn-stalks does not favor this practice. Oats do not require a deep seed bed, but it should be well prepared. The common practice in the corn belt is to disk the ground from one to three times and give it a final harrowing. The oats may be seeded at any time, either before the first disking or between the two diskings. Even in the best of soils one disking is not sufficient, although this is not an uncommon practice. The stalks to a certain extent prevent the full efficiency of the disk and in

many cases a considerable portion of the oats are not covered, being in some cases by actual count one-eighth of the amount seeded.

Plowing the ground before seeding aids in producing an excellent seed bed; however, it will be too loose unless thoroughly firmed. The harrow and compacter should be used, and if the soil is well supplied with organic matter so it will not bake it should be rolled after the seeding is done. The disk drill has some advantage over the broadcast seeder for seeding oats, and the fact that it covers practically all the seed is a decided advantage. Only about two-thirds as much seed will be required as when seeded broadcast.

Cultivation.—Object.—The objects to be accomplished in the cultivation of a crop are: first, and primarily, the killing of weeds; second, the conservation of moisture; and, third, aëration. While the conservation of moisture has usually been placed first, recent experiments show that cultivation for the killing of weeds in humid regions is of vastly more importance to the crop than for the conservation of moisture. It is a question whether this may not be true in semi-arid regions as well. Weeds require both moisture and plant food for their growth and are much better foragers than the cultivated crop. At the Illinois Station (table, page 352), as a result of nine years' investigation, corn with weeds destroyed by a hoe without producing a mulch gave a yield of 48.9 bushels per acre for a nine-year average, while for the same time corn in which weeds were allowed to grow produced 7.5 bushels per acre, or 41.4 bushels in favor of preventing the growth of weeds (Figs. 167, 168, 169). In order to determine whether it was the lack of the plant food or the moisture that caused the greater loss, part of each plot in which the weeds were allowed to grow was supplied with all the moisture the crop and weeds needed, and as a five-year average the yield was increased 2.5 bushels over the plots where no water was applied. This shows rather conclusively that the greatest loss was caused by depriving the corn of food.

Value of the Mulch.—In this same experiment the plots mentioned above in which the weeds were kept down with a hoe without producing a mulch gave a yield of 48.9 bushels, while the corresponding plots which were cultivated gave a yield of 43.3 bushels, or 5.6 bushels were lost due to damage by cultivation. Moisture determinations in each of these three plots were made and it was found that the amount of moisture in the uncultivated plot actually exceeded that of the cultivated by 0.3 per cent for an eight-year



FIG. 167.—Nine-year average yield 43.3 bushels per acre.



FIG. 168.—Nine-year average yield 48.9 bushels per acre.

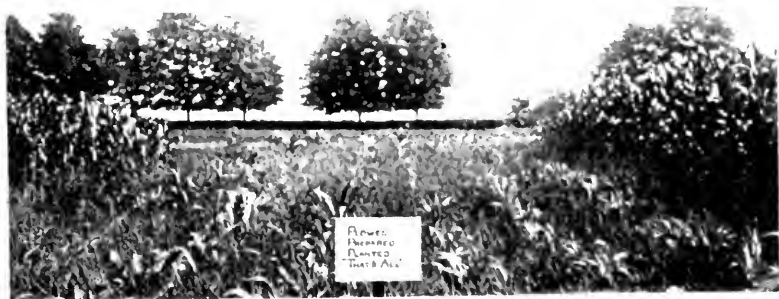

FIG. 169.—Nine-year average yield 7.1 bushels per acre.

average. It is without doubt true that if the ground is plowed to a depth of six or seven inches, and a good seed bed produced, there is very little necessity for cultivation of corn on silt loams and sandy loams to conserve moisture. It will be seen from the following table that during the dry years of 1911, 1913, and 1914 the yield of corn on the uncultivated plots was 5 to 10 bushels more than on the corresponding cultivated ones. The mulch should have had its greatest effect during these seasons if it was of much use in conserving moisture for the crop.

*Results of Cultivation of Corn*³—*Each is an Average of Two Plots (Bushels Per Acre)*

Treatment	1906	1907	1908	1909	1910	1911	1912	1913	1914	1915	9-year average	Average* per cent of No. 5
1. Not plowed nor cultivated, weeds kept down by scraping with hoe	38.3	25.0	28.6	33.1	25.5	46.1	16.5	38.5	64.9	35.2	81.3
2. Plowed, seed bed prepared, no cultivation, weeds kept down by scraping with hoe	44.0	33.0	50.7	40.5	39.8	75.5	34.0	50.0	72.9	48.9	112.9
3. Plowed, seed bed prepared, weeds allowed to grow	0.0	16.0	10.2	.4	.9	7.9	10.4	12.3	8.6	7.4	17.1
4. Plowed, seed bed prepared, weeds allowed to grow, irrigated	2.6	11.5	12.3	20.4	5.9	10.5†	22.8
5. Plowed, seed bed prepared, cultivated 3 times	44.7	49.6	25.0	31.4	45.7	34.5	65.2	21.9	40.5	76.0	43.4‡	100.0
6. Plowed, seed bed prepared, cultivated 3 times, irrigated	46.2	49.8	28.2	40.0	50.3	55.0	61.2	41.2	56.2	70.4	50.2‡	115.5
7. Plowed, seed bed prepared, cultivated 3 times, irrigated, fertilized	69.7	102.2	78.3	77.3	93.0	50.6	56.1	72.0	74.9s	158.4

* Based on all comparable yields.

† Five-year average.

‡ Ten-year average.

s Eight-year average.

The cultivation was done so as to produce a mulch from 2½ to 3½ inches in depth. (See Figs. 170 and 171.) During the years mentioned the mulch was so dry and loose that the roots of the corn did not penetrate it, so that if it had any value at all it was in conserving moisture. The corn roots generally develop most abundantly in the plowed soil. By cultivating three inches deep the crop was enabled to use only one-half of the plowed soil, and there was no doubt that the stirred soil was worth more to the crop for the

plant food it contained than for the moisture it conserved. The experiment was conducted on the brown silt loam, the common corn-belt soil of Illinois. The same experiment was tried on the gray silt loam on tight clay with somewhat similar results, as shown in this table:

Results of Cultivation of Corn on Gray Silt Loam on Tight Clay at Fairfield, Wayne County,⁴ Illinois (Yields in Bushels Per Acre)

Treatment	1908	1911	1912	1913	1914	3-year average	5-year average	Average percent of No. 4*
1. Not plowed, not cultivated, weeds kept down by scraping with hoe	4.0	3.2	22.8	0.0	0	10.0	6.0	31.4
2. Plowed, seed bed prepared, weeds kept down by scraping with hoe	16.7	22.1	55.6	0.0	0	31.5	18.9	98.9
3. Plowed, seed bed prepared, weeds allowed to grow	8.1	8.7	14.6	0.0	0	10.5	6.3	33.0
4. Plowed, seed bed prepared, cultivated 3 times	23.8	24.0	45.8	2.1	0	31.2	19.1	100.0
5. Plowed, seed bed prepared, cultivated 3 times, manure, rock phosphate, limestone	41.5	32.6	62.1	14.6	0	45.4	30.2	158.1

* Computed from 5-year average.

The Department of Agriculture⁵ reports a number of experiments somewhat similar to this, and the average yield of corn on the uncultivated plots was 52.6 bushels, while that of the cultivated was 52.5 bushels per acre. These were conducted on various kinds of soils in 28 different states. The necessity for cultivation is greater on heavy soils than on light ones. This is shown by the fact that uncultivated sandy loams and silt loams produced 105.7 per cent and 102.1 per cent of the cultivated, while the clay loams and clays produced, respectively, 94.5 per cent and 92.6 per cent as much as the cultivated. When the crop becomes large enough to partly shade the soil, and the roots become thoroughly distributed through the soil, there is very little necessity for cultivating to conserve moisture. The water that moves upward is captured by the roots before it reaches the surface and evaporates.

Root Injury.—Most of the crops grown in humid regions that require cultivation are shallow rooting. A large supply of moisture and plant food is in the surface soil. The roots naturally develop

there in larger numbers, attracted by the favorable conditions for obtaining food and moisture. An examination will show many of the roots of cultivated plants within the surface three inches of



FIG. 170.—Yields of corn (field weight) with different methods of tillage. (1911)

soil under favorable conditions and probably three-fourths of the roots of the plants within the surface or plowed soil.

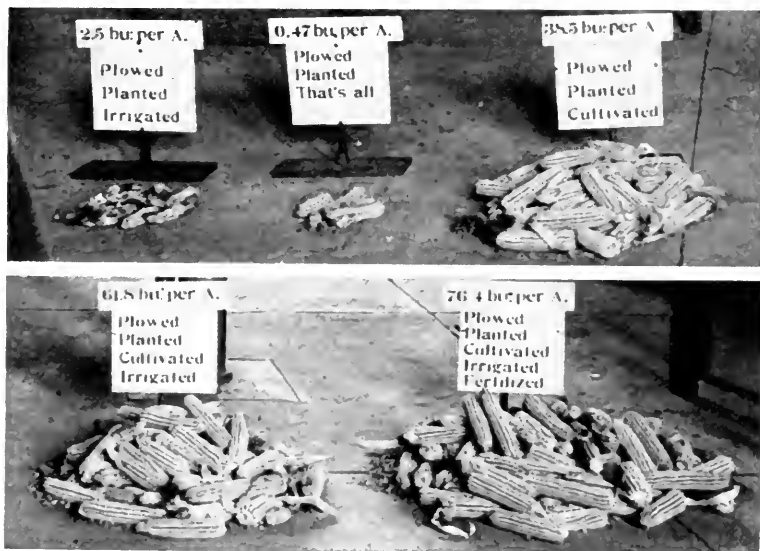

FIG. 171.—Yield of corn (field weight) with different methods of tillage.

To preserve these roots from injury very shallow cultivation must be practiced. Roots take nourishment from the soil for the plant and if roots are cut off it lessens the food supply. Not only this, but it takes energy from the plant to reproduce the roots de-

stroyed. Experiments have been made with corn to show the effect of cutting the roots similar to what is done in cultivation to a depth of four inches. The following table gives the results obtained:

Results of Shallow and Deep Cultivation and Root Pruning of Corn⁶ (Yields in Bushels Per Acre)

Kind of cultivation	1888	1889	1890	1891	1892	1893	1896	Average for years given
1. None—weeds kept down by scraping with a hoe *	90.0	77.1	69.1	55.3	76.8	28.7	87.0	67.7
2. Shallow—4 or 5 times	93.8	84.6	66.8	58.4	70.1	36.3	85.5	70.8
3. Deep—4 or 5 times	84.9	74.2	60.8	63.4	80.1	33.6	83.4	68.6
4. Shallow—roots unpruned . . .	97.0	90.9	78.7	70.0	78.9	33.4	74.8
5. Shallow—roots pruned † . . .	91.0	78.3	55.0	48.7	70.7	26.2	61.6
6. Scraped with hoe *	94.0	85.8	76.7	66.3	80.7
7. Scraped with hoe,* roots pruned †	85.5	68.4	61.5	39.7	68.3

* No mulch produced.

† A frame one foot square was placed over the hill of corn and a knife was run around the outside 4 inches deep.

The effect of cutting the corn roots is shown by comparing plots 4 and 5, where a difference of 13.2 bushels per acre is shown in favor of no root injury, and the difference is about the same when plots 6 and 7 are compared.

Level Cultivation.—Under practically all conditions of rainfall and soils almost level cultivation is most desirable. Ridged cultiva-



FIG. 172.—Level cultivation.

tion must necessarily be deep, and is always accompanied by root injury. In some alluvial bottom land ridging may be necessary. Where the annual morning glory or other troublesome weeds are thick deep cultivation may be advisable to cover them, especially



FIG. 173.—Ridged cultivation with drilled corn. A very undesirable method with nearly all soils.

if the corn is drilled and not checked. This forms a very strong objection to drilling corn. The ridge formed is sometimes six to eight inches high. The disk cultivator or the little diamond plow are both used for ridging. The ideal cultivation is not absolutely level, but such as to have a slope of one to two inches between rows. Compare figure 172 and figure 173.

QUESTIONS

1. What was Jethro Tull's theory of plant nutrition?
2. Define tillage.
3. Why is loosening the soil necessary?
4. Give results obtained for plowing and not plowing.
5. What are the advantages of turning under vegetable matter?
6. Give advantages of killing weeds.
7. Give tillage for storing and conserving moisture.
8. Why is compacting necessary?
9. Give action of mold-board plow in turning soil.
10. What conditions are necessary for best pulverization?
11. What is the advantage of the stubble plow?
12. What is the objection to using it in plowing sod?
13. Describe the general purpose plow.
14. Describe the sod plow and its work.

15. What is the hillside plow?
16. What are the advantages of the disk plow?
17. What is the use of the lister?
18. Describe the subsoil plow and give its use.
19. Give points of difference in the kinds of harrows.
20. What are the advantages of the disk harrow that make it so universally used?
21. Why is it necessary to use compacters?
22. What are the objections to the drum roller?
23. Give advantages of other forms of roller.
24. What is a planker and for what used?
25. Describe the Campbell subsurface packer.
26. What are its advantages?
27. Give three classes of cultivators.
28. Give advantages and disadvantages of each.
29. Which is best adapted to shallow cultivation?
30. Give value of different seeders as tillage implements.
31. Give four points in good plowing.
32. What determines the time of plowing?
33. What can you say about fall plowing?
34. May the soil become too dry to plow in the fall?
35. Give advantages of fall plowing.
36. What soils are most benefited by fall plowing?
37. What are some advantages of spring plowing?
38. What preparation should be made for spring plowing?
39. How deep should plowing be done?
40. What can be said of extremely deep plowing in humid regions?
41. Tell about the results from subsoiling.
42. What may be said in favor of dynamiting?
43. What is the effect of deep rooting crops?
44. What are the advantages of a good seed bed?
45. What are the objections to clods?
46. Give the facts in regard to a good seed bed for wheat.
47. What are the conclusions from the table page 347?
48. How should the seed bed be prepared for corn from fall-plowed land?
49. Give method of preparing seed from spring-plowed land.
50. Tell about seed bed for oats.
51. What are the objects to be attained in the cultivation of a crop?
52. Give results of weeds on yield of corn at the Illinois Station.
53. What is the value of the mulch in growing corn as shown by crop yields?
54. Give results of the Department of Agriculture on cultivation of corn.
55. What effect does root injury by cultivators have on yield of corn?

REFERENCES

- ¹Mosier, J. G., and Gustafson, A. F., Bulletin 181, Illinois Station, Soil Moisture and Tillage for Corn, 1915, p. 585.
- ²Call, L. E., Bulletin 185, Kansas Station, Preparing Land for Wheat, 1913, p. 6.
- ³Illinois Bulletin 181 (as above), p. 570.
- ⁴Illinois Bulletin 181 (as above), p. 582.
- ⁵Cates, J. S., and Cox, H. R., Bulletin 257, Bureau of Plant Industry, U. S. D. A., The Weed Factor in the Cultivation of Corn, 1912.
- ⁶Morrow, G. W., Results given in Illinois Bulletin 181 (as above) p. 568.

CHAPTER XXVII

SOIL EROSION

EROSION is the removal of soil material by air or water in motion. The work of water alone will be considered in this chapter. The National Conservation Commission¹ states that "on the basis of estimates received from 30,000 farmers, representing every county in the United States, 10,622,000 acres of farm land have been abandoned, and that 3,888,000 acres, or 0.2 per cent, have been devastated by soil erosion." Large areas in the states from Pennsylvania to Georgia and westward, including Kentucky, Tennessee, Alabama, Missouri, Arkansas, Louisiana, and Mississippi, are subject to serious damage by erosion. Even such prairie states as Illinois and Iowa suffer loss in this way. As an average of the sixty-one counties of Illinois, of which a detailed soil survey has been made, it has been found by actual measurement of the soil areas that about 17 per cent is hilly and subject to serious erosion.

Cause of Erosion.—Erosion occurs whenever rain falls on unprotected sloping land so rapidly or in such quantities that the soil cannot absorb the water as fast as it falls. The same is true of the melting snow. Only that water lost from the surface—the run-off—causes erosion. The run-off depends on (1) the slope or topography of the land, (2) the texture and structure of the soil, (3) the vegetative covering, and (4) the character of the precipitation.

1. Effect of Topography.—The run-off from mountain topography is from one-third to three-fourths of the total annual rainfall when it varies from 15 to 40 inches. Newell estimates the run-off from the basin of the Savannah river to be 48.9 per cent (eight-year average) of the annual rainfall; 56.5 per cent from the Connecticut valley (13-year average), and 53 per cent (six-year average) from the Potomac basin. Greenleaf places the loss from the broad level to undulating basin of the Illinois river at 24 per cent, and Leverett² gives 21 per cent as the amount of run-off from Illinois as a whole. The run-off of the United States as a whole is estimated at one-third of the annual rainfall.

2. Texture and Structure of the Soil.—Coarse soils absorb a much larger proportion of the rainfall than do the fine-grained ones. The rate of absorption depends on the size of pores, not on

the total pore space in the soil. This fact explains the rapid absorption by the coarse-grained soils and the slow action of the fine-grained ones. However, if the latter are loose and open from recent tillage their absorption compares favorably with that of coarser soils. Unless the finest-grained soils (clay loams and clays) are exceptionally well supplied with organic matter and limestone the beating of raindrops breaks down the granules, diminishing the size of the pores, thus rendering the soil less absorbent. As a result a large amount of water is lost from even moderate slopes.

3. Vegetative Covering.—The surface soil of a natural forest is usually covered with leaves and twigs, which protect it from



FIG. 174.—Two hundred square miles of once forested mountains in China, which a century ago paid rich revenues on their lumber product. (Bailey Willis.)

erosion. It suffers little so long as this natural protection remains undisturbed (Fig. 174). Natural prairies are usually protected in this way by a good sod of native grass. The rain drops do not usually strike the soil direct and thus destroy the granules, as they tend to do in cultivated fields. When this covering which nature provided is removed or destroyed erosion takes place.

1. Character of the Rainfall.—A gentle rain will be absorbed entirely by almost all soils, since it does not come more rapidly than the water can percolate through the soil, thus preventing complete saturation of the surface. A heavy rain falling on medium- or fine-grained soils soon saturates the surface and then absorption by the soil cannot take place any faster than percolation from the surface into the lower strata.

Results of Erosion.—It is quite impossible to determine with

any degree of accuracy the total quantity of material moved by water, but it must be many times as much as is deposited from suspension in lakes and the seas.

Some geologists hold that the land surface of the earth as a whole is being lowered by erosion one foot in six thousand years. The combined loss from surface erosion and from solution by ground waters amounts to one foot in about 4100 years.

When a stream emerging from a narrow valley spreads out over the bottom land, the velocity of the water is checked and its load of stones, gravel and sand is deposited on the rich alluvial land. In this way much valuable soil is buried completely by material of little immediate use to plants. The finer material, if unweathered and deficient in organic matter, may be almost equally worthless until acted upon by the regular soil-forming agencies. If the deposition is rapid there is little chance for soil to form, but if deposition is prevented for a time this almost worthless material becomes a valuable soil.

1. Removal of Organic Matter and Nitrogen.—The surface soil contains the greater part of the organic matter, and so is the richest, most productive part of the soil. The removal of any appreciable amount of this stratum reduces the amount of plant food, especially the nitrogen, rendering the soil less productive than formerly. The following results from pot culture tests in the greenhouse show their great need of nitrogen:

Yields from Eroded Hill Lands³ (Bushels per Acre)

Treatment	Pulaski county wheat	Henry county oats
None	8	21
Potassium	9	23
Phosphorus	9	31
Nitrogen	69	225

2. Changes Physical Character of Soil.—The removal of the surface soil exposes the yellowish or reddish subsoil, which is heavier and more difficult to work than the original surface soil. These exposures of subsoil are locally known as “clay points.” They are less productive than the original land. In some residual and glacial soils with a wide range in size of particles the texture of the surface may be changed from a fairly heavy to a sandy or gravelly soil by the removal of the silt and clay, leaving only the coarse material which was too large to be carried away by the water.

3. **Changes of Color.**—Erosion almost invariably results in a change of color of the soil. If the soil is brown, yellow or grayish yellow, erosion produces a yellow or reddish color, depending wholly on the color of the subsoil. On the Piedmont Plateau and some other residual soil areas the color becomes very red, due to exposure of the subsoil.

KINDS OF EROSION

Two somewhat distinct types of erosion are recognized, sheet erosion and gulying.

I. Sheet Erosion

Water flowing over a uniform slope removes approximately the same amount of soil material from all parts. Sheet erosion is the source of far greater loss than gulying. The latter quickly and completely ruins small areas, but the former reduces the productiveness over large areas to the point of unprofitable returns.

Methods of Prevention and Reclamation.—1. **Application of Limestone.**—Limestone in time renders the soil more porous



FIG. 175.—Sweet clover on badly eroded land. Sowed in March, photographed in September.

by producing granules. This lessens erosion, because the soil is more absorbent and the heavier compound granules are more diffi-

cult to move than the individual particles. The more important effect of limestone, however, lies in its power of correcting acidity, rendering the soil more favorable for the growth of legumes which furnish organic matter and nitrogen (Fig. 175), also for soil-binding crops, such as timothy and bluegrass.

2. **Protection by Crops.**—The surface of rolling land should be kept covered with soil-binding crops as much of the time as possible. For this purpose meadows, pastures and catch and cover crops are indispensable in the farming of rolling lands.

(a) *Meadows and Pastures.*—The perennial grasses, timothy in the northern states and red top and Bermuda grass further south, on acid soils are good meadow grasses. Bermuda grass makes good pasture and, if cut early enough, fairly good hay. Its growth is such as to stop washing very well. It is more profitable to grow one or more legumes with the grasses, as the latter use nitrogen fixed by the legume. This is particularly desirable on those soils deficient in nitrogen. Together these plants form a good sod, which protects the surface and holds the soil together.

Much of these hilly lands should never be plowed, but kept in pasture. Blue grass, timothy, red top and other grasses, together with red, alsike and white clover, sweet clover (*Melilotus alba*), and Japan clover (*Lespedeza striata*), may be seeded in addition to native grasses that follow upon the removal of the forest. One or more of these should be able to get a good foothold regardless of whether the soil is acid or contains limestone. These legumes enable the grasses to make a much better sod. As already pointed out, legumes in general require a soil containing limestone for good growth. Japan clover, however, seems to be indifferent. Sweet clover is more successful than any of the other clovers under very unfavorable conditions if its two requirements—thorough inoculation and abundance of limestone—are satisfied. It makes a strong growth and may be pastured or grown for hay and seed. Blue grass soon starts in it, living in part on nitrogen fixed by the legumes. This increases the amount of pasture afforded and forms a better protection for the soil.

(b) *Catch and Cover Crops.*—Cultivated land should not be left unprotected throughout the winter and spring months, especially in those sections where the soil is not frozen during any considerable part of the winter. Cowpeas or soybeans may be seeded between the rows of corn at the last cultivation or between the trees in orchards. Hairy or winter vetch and Japan clover are more

desirable in some places, especially the vetch, as it lives through the winter and begins growth early in the spring. With fall sown cereals sweet clover may be used to good advantage when the soil is well supplied with plant food. Wheat, rye and winter oats cover the ground well and the roots are a very effective soil binder. Vetch and Japan clover are probably most desirable when sufficient growth is made, because of their ability to gather nitrogen, the increase of which is most essential in the improvement of these soils. Crab grass is a natural cover in seasons of normal rainfall, as it makes sufficient growth to serve well as a surface protection, especially in corn and old wheat fields.

3. **Residues.**—Stalks of corn or cotton may be harrowed or rolled down after the crop is harvested. In this way they help to protect the soil from the beating of rain drops and reduce somewhat the amount of thawing in winter and early spring. When the surface soil is thawed for an inch or two, it is easily eroded.

It is desirable, also, to cover badly eroded areas, or areas where erosion is especially rapid, with straw of grain or clover, manure, or other coarse material. These areas are unusually low in organic matter, as more or less of the surface soil has been removed. The coarse organic matter will not only hold the soil in place, but supply plant food to succeeding crops.

4. **Increasing the Organic Matter.**—Most lands subject to serious erosion have been timbered and are naturally low in organic matter and nitrogen. The hilly timber lands of Illinois contain an average of 1.5 per cent or 15 tons of organic matter in the surface soil (two million pounds per acre). The yellow silt loam—hilly timber land—of Hardin County,⁴ Illinois, which represents the unglaciated loess-covered section of the states adjoining the lower Ohio and the middle section of the Mississippi river, contains as an average of 15 analyses 1.1 per cent or 11 tons of organic matter in the surface soil. The hill soils of the Piedmont Plateau, Appalachian Mountain Plateau, and Limestone Valleys and Upland Provinces contain from one-half to two and one-half per cent of organic matter.⁵ The average organic-matter content is about 1.1 per cent.⁵ Profitable crops cannot be produced without adding considerable organic matter or nitrogen.

Besides furnishing nitrogen, organic matter aids granulation and cements the finer particles together into compound granules, as discussed under organic matter. These soils need the addition of large quantities of organic matter to enable the surface to absorb

and retain more of the rainfall. Owing to its granulating effect organic matter reduces the tendency to run together and keeps the soil open, so there is less run-off and less erosion.

Legumes must have a large place in the agriculture of these lands. It is advisable to feed most crops to stock on the farm. All the manure produced should be carefully preserved and returned to the soil. All stalks, straw, stubble or other residues not fed should be plowed under. Plowing under the entire crop of cowpeas, or at least the straw, is a practice to be recommended.

5. **Deep Contour Plowing.**—A loose soil has more pore space than a compact one, consequently it will absorb more water.



FIG. 176.—Cultivated terraces in China. (Bailey Willis.)

silt loam in loose open condition will absorb 10 to 15 per cent more water than when compact. The pores in a compact soil are so small that it absorbs rain very slowly and much of the water is lost as run-off. The surface soil may be kept loose by plowing to a depth of eight to ten inches. Eight inches of loose silt loam fairly well supplied with organic matter is capable of absorbing two inches of water. While a greater depth of plowing would increase the storage capacity, experiments show such to be unprofitable. The Georgia Station⁶ reports results which indicate that plowing more than eight inches deep lessens the yield of cotton. It is believed, however, that loessial soils may be plowed to a greater depth with profit.

Plowing on sloping land is best done across the slope with a

reversible or hillside plow, by which all of the soil may be turned in the same direction. In ordinary plowing up and down the hill the small depressions, nearly always found between furrows, and especially the dead furrows, serve as places where the water collects and erosion begins. In contour plowing these ordinary depressions are at right angles to the slope and retard rather than encourage erosion. When the reversible plow is used there are no dead furrows except on the crest of ridges where there is but little danger of erosion.

6. **Contour Seeding.**—Corn and cotton should be planted on contour lines or nearly so. This reduces the danger of erosion in planter tracks, and the cultivation will be across the slope, which will avoid the formation of small gullies between the rows. For this reason the seeding of oats, wheat and cowpeas should be across the slope, particularly when the drill is used.

7. **Terraces.**—In those sections where intensive farming is practiced and in fruit districts where the rain falls in heavy showers and the soil does not absorb water readily, terracing is practiced to good advantage (Fig. 176). Three types of terraces are in common use—the guide row, the level bench and the Mangum.

(a) *The Guide Row* (Fig. 177) is made by throwing four furrows together on contour lines, with an interval of approximately



FIG. 177.—Guide-row terraces. There is no slope from one end of a terrace to the other, but there is a slight slope from the back of a terrace to the front (Pearce, R. B.)

three feet in altitude between the rows. This makes a low flat ridge, and in order to avoid any waste of land a row of the crop may be planted on it. This method of terracing is employed on slopes that do not exceed 10 per cent, or one foot in ten, and where the soil is open, absorbing the rainfall readily.

(b) *The Level Bench* (Fig. 178) is employed on steeper slopes. These may be developed from the guide-row or laid out on contours by using a reversible plow. By plowing down hill a level bench is developed in a few years. When the desired form of the terrace has been produced it is well to throw the soil up the slope as often as down in order to avoid exposing too much unproductive subsoil at the upper side of the terrace. Each bench must be cultivated as a separate unit, and driving over the bank or outer edge must be avoided lest depressions be made which result in gullies. The growth of weeds on the edge of the bench should be prevented and

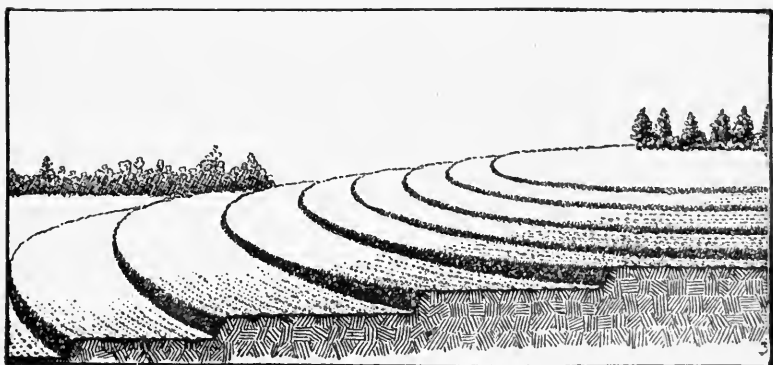

FIG. 178.—Level-bench terrace. (Bul. 236, North Carolina Station.) (F. R. Baker.)

a good grass covering encouraged to prevent erosion. Crops may be grown in straight rows or on contours following the terrace lines. Most farmers object to the short rows, which are necessary if the rows are to be kept straight, because of the loss of time and the tramping out of part of the crop in turning during cultivation. Undoubtedly the best way to prevent erosion while farming these lands is to plant and cultivate across the slope or parallel to the terrace. The uncultivated bank growing weeds or grass is a serious objection to this form, as it is a breeding place for injurious insects and a home for moles, mice and other animals. Very often the water from the slope above finds its way into one of their burrows and a considerable gully forms in a short time. A terraced park is shown in figure-179.

(c) *The Mangum Terrace* (Fig. 180) is a very desirable form, because it eliminates the uncultivated spaces of the level bench. It



FIG. 179.—A terraced park in Mississippi. While the natural slope was stable under the protection of the virgin forest, it was necessary to terrace to prevent devastating erosion when the land was cleared. (Bureau of Soils, U. S. D. A., Bul. 71.)



FIG. 180.—The Mangum terrace. With this form there is no waste land. (U. S. Dept. of Agr.)

differs from the guide row and level bench in that the lines are not level, but are run across the slope with a grade of six to ten inches in 100 feet towards some natural outlet into which the water may drain. The terrace is made by plowing several furrows along the



FIG. 181.—Locusts growing on gullied land. The gullies have been almost completely filled. (Heaton.)

surveyed line and pulling the soil to the lower side so as to form a low dyke or ridge with a shallow depression just above it. The crop is planted obliquely over the dyke and terrace, so that water may collect along the rows and be conducted into this depression,

or wide bottomed ditch, which has but slight fall, so there will be little or no erosion. The Mangum terrace can be used to good advantage on heavy soils which absorb water very slowly. This form provides very effective protection against erosion and eliminates waste land.

8. **Reforestation.**—As already pointed out, the soil of virgin forests is protected by leaves and twigs. On cleared areas where the surface soil has been removed to such an extent that it does not produce profitable crops and especially where gullied it may be advisable to imitate nature by planting trees. The black locust is excellent for this purpose. Being a legume it is capable of good growth on soils very low in organic matter. The leaves and twigs protect the soil and, through the aid of nitrogen fixed by the legume, grasses soon start among the trees (Fig. 181). By this time there is little movement of soil material. When abandoned, such areas are reforested naturally, but the process is very slow and much additional erosion may take place before there has been sufficient growth to hold the soil. The natural growth in most cases will be of far less value than the black locust or other trees which might be selected for this purpose.

9. **Tiling.**—In rolling sections, "seepy" or "springy" spots are common. On these, crops do poorly, wheat often "heaves" and may be killed completely. In wet seasons these spots are much larger than normal, so the damage is much greater. In many of these places and on much rolling land which does not have an especially pervious subsoil, tile will produce all its ordinary benefits, including warmer, drier surface soil in the spring when early tillage and planting are desirable. The most beneficial effect of tiling is the increase in perviousness of the soil, so that the rains are absorbed more readily, thus decreasing the run-off. This is a very effective method of preventing erosion, but the expense is almost prohibitive when that is the only purpose to be accomplished.

II. Gullying

In any depression extending up and down a slope water collects. Its velocity is increased with its volume, as is also its transporting and eroding power. For this reason depressions extending down the slope, such as a furrow, wagon or planter track, a sheep or cow path, or even a mole tunnel, may soon result in a small gully. These should be filled with some coarse organic matter or

obliterated in other ways. Otherwise, each rain will increase their size and they will become a permanent source of trouble. In a few years considerable areas will be ruined. Gullying in different degrees is seen in figures 182, 183, and 184.

Methods of Prevention and Filling.—1. Straw-brush.—

FIG. 182.



FIG. 183.

FIG. 182.—Erosion in pasture near crest of slope.

FIG. 183.—Old field erosion in Mississippi.

Gullies should be filled with a durable material sufficiently open to allow the water to pass through it and yet reduce the velocity of the current so as to cause deposition. The material best suited depends on conditions. If the slope is gentle and the quantity of water small, straw, weeds, or anything of that nature holds the soil, that would otherwise be lost, partially filling the gully. Where the

slope is steeper or the amount of water greater, steps must be taken to prevent the rapidly flowing water from washing away the material used. For this purpose stakes slanting up hill, driven through the straw are used successfully. Hedge or other brush (Fig. 185) placed on the straw help to hold it. Stones may well be used for this purpose, especially if they occur on adjoining slopes.

Stock frequently make paths up and down steep slopes to such an extent that the grass is killed and a slight depression produced. Water collects in this during rains and a gully is started.

In pasture lands, waterfalls sometimes occur that move up the



FIG. 184.—Old erosion.

slope by means of headwater erosion (Fig. 186). As water goes over the fall it undermines the sod surface, which then caves in, making a gully which is especially difficult to fill. In such places it is necessary to protect the face of the bank from the undermining action of the water. This may be done by filling the gully at the fall with brush or straw or both, which must be held in place by stakes or heavy material, such as stones. Since the water from pasture land contains but little sediment, filling of gullies under these conditions is a very slow process. For completely filling the gully, dams of some kind must be used below the fall.

2. **Dams.**—In cultivated fields earth and concrete dams are used for filling large gullies. The *earth dam* is built over a large tile

Fig. 185.



Fig. 186.

Fig. 185.—Brush checking erosion.

Fig. 186.—Headwater erosion.

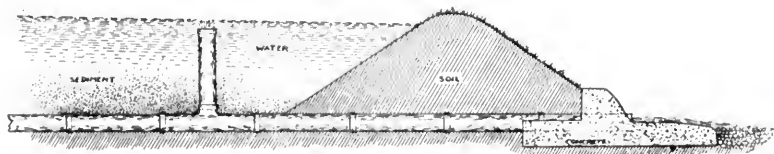

Fig. 187.—Earth dam for checking erosion.

laid in the gully to be filled. A vertical tile connects with the horizontal one a few feet above the dam. This form of dam is adapted to comparatively small gullies of slight fall which do not carry large amounts of water.

The dam holds the soil material carried down by the stream and the water which would otherwise overflow the dam and ruin it passes down through the vertical tile and out through the horizontal one. The arrangement of the tile is shown in figure 187.

Concrete dams are better adapted to large gullies carrying a



FIG. 188.—Filling a gully by means of a concrete dam.

large volume of water. They should be placed well into the bed of the gully and extended into the bank well back from the gully (Fig. 188). The concrete should be thoroughly reinforced. A spillway with an ample concrete floor below the dam is absolutely necessary to prevent the water which passes over from undermining it. The vertical tile is sometimes used as with the earth dam, but it is not so essential, but the horizontal tile should be used for draining the temporary pond above the dam.

3. **Vegetation.**—Among the many plants that may be used to excellent advantage in checking the deepening and widening of gullies, the black locust is probably the most valuable tree. Gullied soils are always low in nitrogen, yet the locust thrives in spite of this fact. The roots help to hold the soil and the leaves and twigs also offer some protection. The locust adds some nitrogen to the soil and grasses soon get a footing, which then catches the finer material. The gully may be almost entirely filled in this way. Locust trees are valuable for posts if not attacked by borers. Willows and cottonwoods and a few other trees may be used in the same way, but their wood is of less value and few, if any, of them possess the advantages of the locust. (See Fig. 181, page 368.)

Timothy, blue-grass, redtop, sweet clover, Japan and other clovers are very useful in all gullies, but more especially in wide, flat-bottomed ones where erosion is not so severe as to prevent them from getting a good start.

In many localities the sod of blue-grass or timothy in draws is not disturbed when the field is plowed for corn. Where limestone is applied or where its roots can reach carbonates in the subsoil sweet clover is exceptionally valuable because of its strong, rapid growth. On the steep limestone slopes of Kentucky sweet clover has reclaimed large areas of abandoned land which now produce excellent pasture and large crops of seed.

4. **Filling with Soil.**—On more gently sloping land gullies may be filled with soil by means of plows and scrapers. This method can be employed with profit only on those areas where more or less intensive agriculture is to be practiced or where filling a few small gullies in this way will reclaim considerable areas. Much subsoil will be on the surface which will be very unproductive. Legumes must be grown for supplying organic matter and nitrogen, thus restoring fertility. If the soil is acid cowpeas is the best crop to grow. If the soil contains limestone or if limestone is applied sweet clover is one of the best legumes for the soil, as it grows under very adverse conditions. Whichever crop is grown should be returned to the soil. Figure 175, page 362, shows sweet clover grown under the above conditions.

QUESTIONS

1. How much land has been abandoned in the United States?
2. What percentage in Illinois is hilly?
3. How do other states compare with Illinois in this respect?
4. Upon what does run-off depend?

5. Give effects of topography.
6. What part does texture of soil play in erosion?
7. How does the vegetative covering affect erosion?
8. Why should the character of rainfall affect erosion?
9. Give some idea of the amount of material moved by running water.
10. What is the effect of this deposit in many instances?
11. Give effects of removal of surface soil.
12. What results are obtained from applying plant food to eroded soil?
13. What effect does erosion have on the physical character of the soil?
14. Define sheet erosion.
15. How does it reduce productiveness?
16. What benefits are derived from limestone on eroded land?
17. What are good meadow- and pasture-grasses?
18. What are good legumes for hill land pastures?
19. What are the uses of catch crops?
20. What use may be made of crop residues?
21. Tell about the amount of organic matter in eroded soils.
22. What effect does it have that causes less erosion?
23. What are the advantages of deep plowing?
24. What are the advantages of contour plowing and seeding?
25. What is the guide-row terrace and what are its advantages?
26. Give advantages of the level bench terrace.
27. Describe the Mangum terrace.
28. Give its advantages.
29. Discuss reforestation of eroded lands.
30. What about tile as a method for preventing erosion?
31. What are the sources of gullies?
32. Give methods of preventing gullies.
33. Discuss waterfalls. Why are they so difficult to check?
34. How may dams be used to fill gullies?
35. Give use of black locust on gullied land.
36. What other ways of filling gullies?

REFERENCES

- ¹ Report of the National Conservation Commission (60th Congress, Second Session, Senate Document 676), 1909, vol. 1, p. 79.
- ² Leverett, F., Monograph XXXVIII, U. S. Geol. Survey.
- ³ Mosier, J. G., Circular 119, Illinois Station, Washing of Soils and Methods of Prevention (Second Edition), 1912, p. 7.
- ⁴ Soil Report No. 3, Illinois Station, 1912, p. 3.
- ⁵ These figures are drawn from Field Operations of the Bureau of Soils, U. S. D. A., 5th Report, 1903. The average figure is based on reported analyses of 63 samples of the clay, clay loams, silt loams and loams of the Cecil, DeKalb, Hagerstown, and Norfolk Series.
- ⁶ Redding, R. J., Cotton Culture, Bulletin 63, Georgia Station, 1903, p. 124.

General References.—McGee, W. J., Bulletin 71, Bureau of Soils, U. S. D. A., 1911. Ames, C. T., Bulletins 108 and 165, Mississippi Station, Report of Work at the Holly Springs Branch Station, 1907-1914. Illinois Soil Reports, No. 3, 1912, and No. 11, 1915. Davis, R. O. E., Bulletin 180, U. S. Department of Agriculture, Soil Erosion in the South, 1915. Calhoun, F. H. H., Circular 20, South Carolina Station, Gullying and its Prevention, 1913.

CHAPTER XXVIII

ROTATION

A CROP rotation is the growing of two or more crops in regular sequence on the same land. Scientific rotation is the systematic growing of crops on the same soil in regular succession such that each crop bears a useful and somewhat vital relation to some or all of the others grown. Rotation is very closely related to and becomes the basis of soil improvement. The object of a rotation is to utilize, to the very best advantage in the production of maximum crops, the favorable conditions of soil with respect to tilth, moisture, temperature and food, produced by other crops, and to eliminate any unfavorable conditions produced by any crop. A legume should form one of the crops of the rotation because of its value in bringing about these favorable soil conditions.

Major crops in rotations are the main crops grown. *Minor* crops are those grown for catch, cover, or green manure purposes.

In nature no very distinct rotation of plants occurs because the same thing is accomplished in a measure by the growing together of different plants on the same land. Yet we see that nature has its own system of rotation. Certain plants may grow luxuriantly for a few years and then be almost entirely replaced by some more favored one. Sweet clover has been observed growing along ditch banks for several years and then has been crowded out by some other plant without any apparent cause. As a result of weather conditions some weeds are very abundant for a year or two and then almost entirely disappear. Fires sometimes aid nature in bringing about a rotation of plants, as do also birds and other animals. Any natural agency of seed distribution lends its assistance in accomplishing this purpose.

In agricultural practice it has been found very essential to rotate crops. The object of farming is to grow crops and it has been found in general farm practice and determined through numerous experiments that more grain and other crops may be produced in a regular rotation than by growing any one crop year after year on the same land.

ADVANTAGES OF ROTATION

1. **Better Distribution of Work.**—The one-crop system throws a large amount of work at about the same time so that a large force of men and horses are necessary to plant, cultivate or harvest the crop. The most economical use of time and labor is accomplished when it is more uniformly distributed throughout the year. In a rotation the several crops are planted at different times. They mature so as to distribute the work of harvesting over a considerable period. This helps solve the farmer's labor problems by furnishing more permanent employment to the laborer.

2. **Control of Insects and Plant Diseases.**—A very serious objection to any one-crop system is the encouragement it gives to injurious insects that prey upon the crop. This is especially true of corn. The corn root aphid and the corn root worm become very serious pests where this crop is grown very long in succession. Growing some other crop for several years destroys many of these. The same is true of plant diseases such as flax wilt, cowpea wilt, clover sickness, potato scab, dry rot of corn, etc. These are worse than the insects. They may be completely controlled by rotation, since in this case the particular host plant upon which each lives will not be present every year, thus creating conditions very unfavorable for their survival.

3. **Control of Weeds.**—Many crops have their particular weed or weeds that are in some way favored by them. Many weeds favored by one crop will be smothered by another. Cultivation of one crop may be the means of destroying some, while others may be killed by pasturing or by a tough, heavy sod.

One-crop systems tend to encourage many kinds of weeds. At Rothamsted, England, on the plots where wheat had been grown continuously for many years the ground became so foul that fallowing had to be practiced occasionally to eradicate the weeds. Corn cockle and chess growing with wheat are familiar examples in this country. Remove these from their association with wheat and they are easily killed. Old pastures sometimes become so full of weeds that the grass amounts to little. Ox-eye daisy, yarrow, verbena, and iron weed sometimes take pastures. Hence it becomes as necessary to rotate pastures as any other crop unless great care is taken to keep these enemies out. Pastures and meadows may be kept clean, as seen in England, where the grass fields are several decades old.

These are the exceptions. England's farms are models of scientific rotation.

4. Variation in Depth of Root Systems.—By rotation different crops with root systems varying in depth are brought successively upon the land. Some especially deep-rooting crops, such as clovers and alfalfa, should be grown. These obtain much of their food below the zone from which the ordinary shallow-rooting crops take their food. More than this, they bring much plant food to where it may be reached by other crops. In this way the plant food from a deeper zone is utilized and soil exhaustion will not occur so soon. These deep-rooting crops have a very favorable effect in opening up the subsoil for better aëration and drainage.

5. Helps Maintain Good Tilth.—At the University of Illinois one plot has been growing corn for thirty-seven years; another has had a two-crop system of corn and oats; a third has had a three-crop system of corn, oats, and clover for the same time. The soil of the first is compact, "runs together" badly, and erodes considerably. A heavy rain packs it and forms a smooth, solid surface. The second acts somewhat similarly to the first but is not so bad. The third is mellow, granular, and even heavy rains do not cause the surface to run together. This difference is due to the legume crop grown. No crop is of more benefit to the tilth of a soil than a deep-rooting legume.

6. Helps to Maintain the Organic Matter.—The part rotation plays in maintaining organic matter has been discussed in Chapter XI. As previously shown, a legume crop is essential in every scientific rotation. The manner in which the legume is disposed of is of the utmost importance. Very little in the way of permanent improvement is accomplished unless the legume is turned back into the soil either directly or as manure.

7. Rendering Toxic Substances Less Harmful.—Soils sometimes contain organic substances that are harmful to plants. The same substance is not equally injurious to all crops, but is especially detrimental to the growth of the kind of plants that gave rise to the toxic material. Changing the crop renders this less harmful.

8. Produces Larger Yields.—From what has been said it will be seen that rotated crops have a decided advantage over those of the single-crop system.

Many experiments have been carried on at different stations that prove definitely the great value of rotation in increased yields.

Iowa gives results that show a nine-year average for continuous

corn of 51 bushels per acre and 64 bushels for corn grown in a rotation of corn, corn, oats, and clover.

Rotation Compared with Continuous Corn. Ames, Iowa

	1904	1905	1906	1907	1908	1909	1910	1911	1912	Average
Corn in rotation of corn, corn, oats and clover	75	87	69	57	70	54	60	44	60	64
Continuous corn	74	73	53	47	53	31	46	32	47	51

It will be observed that the yield at the beginning was about the same for each.

At the Illinois Station corn has been grown for thirty-seven years in comparison with a corn and oats and a corn, oats, and clover rotation. The last four crops of corresponding years average: Continuous corn 26.4 bushels per acre, corn and oats rotation 34.6 bushels, and the corn, oats, and clover rotation 57.1 bushels.

Yields of Corn, Wheat and Hay Under Different Systems of Cropping. Minnesota Station¹

Year	Corn			Wheat			Hay	
	Contin-uous	3-year rota-tion	5-year rota-tion	Contin-uous	3-year rota-tion	5-year rota-tion	3-year rota-tion	5-year rota-tion
	<i>Bushels</i>	<i>Bushels</i>	<i>Bushels</i>	<i>Bushels</i>	<i>Bushels</i>	<i>Bushels</i>	<i>Tons</i>	<i>Tons</i>
1899	20.8	51.1	31.3	22.5	25.3	27.3
1900	37.5	42.6	58.0	14.5	27.3	25.6
1901	13.9	42.0	42.8	16.0	13.5	15.2	1.58	2.36
1902	*	62.0	78.6	17.0	18.1	25.1	2.25	1.95
1903	23.6	51.7	85.3	16.3	24.1	30.8	3.86	6.10
1904	11.1	45.4	37.1	20.8	27.3	32.0	4.26	5.77
1905	25.1	64.1	64.1	20.8	20.6	30.9	4.86	5.81
1906	27.6	36.1	60.5	14.1	13.3	22.6	1.91	3.18
1907	23.6	35.2	52.2	24.5	19.1	23.9	1.25	1.42
Average, 9 years	22.9†	48.1	56.7	18.5	21.0	25.9	2.85‡	3.80‡
Increase	25.2	33.8	2.4	7.195

* Record lost.

† 8 years.

‡ 7 years.

From the results given in the above table it will be seen that continuous cropping has a greater effect on corn than upon wheat. The 3-year rotation increased corn 25.2 bushels, while the increase for wheat was only 2.4 bushels per acre.

Ohio has been carrying on some experiments for about 19 years that prove the value of rotations.

Average Annual Yields for 16 to 19 Years When Grown Continuously and Under Three- and Five-year Rotations. Ohio Station ²

Rotation	Corn	Wheat	Oats	Clover
	<i>Bushels</i>	<i>Bushels</i>	<i>Bushels</i>	<i>Pounds</i>
Continuous.....	15.88	7.52	22.92
3-year rotation.....	34.39	10.63	2,697
5-year rotation.....	29.74	10.21	31.00	2,267
Increase for 3-year rotation.....	18.51	3.11	8.08

Rotation gave an increase of 18.5 bushels per acre of corn and for wheat 3.1 bushels, showing again that corn responds to rotation better than wheat.

PLANNING A ROTATION

Planning a rotation requires a great deal of care and thought. It should be made not for the present alone but for many years in the future. The probable effect of the rotation adopted should be studied from several standpoints. The effect on the fertility and tilth of the soil should receive careful attention. Will it decrease or increase the organic matter of the soil is a question that should be worked out. If this rotation is practiced, what will be the condition of my farm after fifty years? If you cannot answer this, get the knowledge or the help that will enable you to do so. The rotation would depend on the size of the farm to some extent. That for one of sixty acres would not apply to a four hundred-acre farm. The rotation should vary with the character of the soil. A rotation for a heavy, rich, black soil certainly would not be fitted for a sandy soil, or *vice versa*. Soils low in organic matter should have a system of rotation whose object is to build up the soil in this particular. Acid soils will grow different crops than soils containing limestone. The maintenance of the fertility and tilth of the soil should be a very important factor in determining the rotation.

The system of farming to be practiced should be one of the controlling factors in determining the crops grown. A fruit-grower, a dairyman, a grain farmer, or a stock-raiser would each follow different systems. In any system the value of the crops, both those to be used on the farm and those to be sold, must be considered in their selection, since the returns from the crop and its relation to other crops is the thing that should determine its use in the rotation. The most profitable crop should have the most favorable place in the rotation. In the corn and wheat belt these should have this place,

and likewise of the other great money crops, such as cotton, tobacco, potatoes and others.

As a general rule a rotation of three to five years is more desirable than a longer one. The short cycle requires less trouble and time to get it started and is easier to maintain when once under way. If a crop fails in a three- or four-year cycle it is not difficult to maintain the rotation, while if a failure occurs in a longer cycle it may disarrange the system to a greater or less extent.

Because of the rearrangement of fields and the adjustment of crops, it is rather difficult to get a rotation under way, usually requiring several years, and it is almost equally difficult to change it after once it is started. The rotation should be maintained even if a crop does fail. A substitute crop should be planned to take the place of those crops that are liable to fail. This will not be needed very often.

The farm should be divided into as many fields as there are years in the rotation and the crops grown in regular succession on these fields. On large farms the rotation may be duplicated. There should be at least one legume crop, preferably a biennial or perennial, and not more than two tilled crops, during the cycle, the number depending upon the soil, as these cause considerable loss of organic matter.

Places in Rotations for Crops.—Corn succeeds well after clovers, alfalfa and pasture and does fairly well after wheat and oats, especially for fall plowing. In sod ground two or three crops of corn may be grown successfully, but more than two in succession on ordinary soil are not deemed best.

Wheat does not follow corn well even if the latter matures several weeks before seeding time. Wheat does well after potatoes, clover, alfalfa, pasture or soybeans, the only danger being its liability to lodge caused by the excess of available plant food, especially nitrogen. Oats is a good crop to precede wheat if the plowing is done early. Wheat follows wheat very well, but there is too much danger from Hessian fly in some latitudes.

Oats is a crop that is adapted to the cooler part of the temperate zone. South of this the ordinary spring-sown oats encounter the hot weather at filling time, so that a partial failure may result. In the South winter oats are grown to some extent with fair success. There is a belt between these where neither fall nor spring oats do well. The summers are too hot for the spring seeding and the winters too cold for the fall oats.

In the corn and wheat belt and corresponding latitudes oats are almost universally seeded after corn. Even in the southern states this is practiced. If they should follow clover or potatoes, lodging of the crop would almost certainly occur, with consequent loss. They will follow wheat, millet or cotton well.

Barley does well in the southern oats belt and under practically the same conditions. It may follow wheat, oats or corn.

Rye may be grown under practically the same climatic conditions as wheat, but it is a better forager and produces more on poorer soils. In the middle west it is a common crop for very sandy lands.

The clovers are almost universally seeded with wheat, oats or barley as nurse crops. Occasionally they may be seeded in corn or cotton after the last cultivation, but the catch is uncertain.

Soybeans and cowpeas follow almost any crop, but there is nothing gained by having these succeed other legume crops. A non-leguminous crop should intervene or at least be grown in conjunction with one of the legumes.

SOME PRACTICAL ROTATIONS

1. For the Corn and Winter Wheat Belt.—In this belt corn and wheat are the money crops, and they should be given the most favorable places in the rotation. If any crop is grown that is of special benefit to the soil, these should have the advantage of its effect. The best place for corn is following the legume. If two important money crops are placed in the rotation, each should be given the best place possible. This belt is characterized by hot summers and cold winters, with the annual rainfall varying from 20 to 48 inches. Corn, wheat, oats, and rye are the principal cereals (Fig. 189).

A short-cycle rotation that is sometimes practiced is: first year, corn; second year, oats, seeded to clover; and third year, clover. This is a good rotation to maintain organic matter, but it is not as profitable as some others.

An excellent four-year rotation is made by adding another year of corn to the former, making (1) corn; (2) corn; (3) oats (clover); and (4) clover. This exhausts the soil more rapidly than the former and is best adapted to fertile soils well supplied with organic matter. If it is desired to grow wheat, a four-year rotation is as follows: (1) corn, (2) oats, (3) wheat (clover), (4) clover. This is well adapted to a rich soil such as black clay loam or a

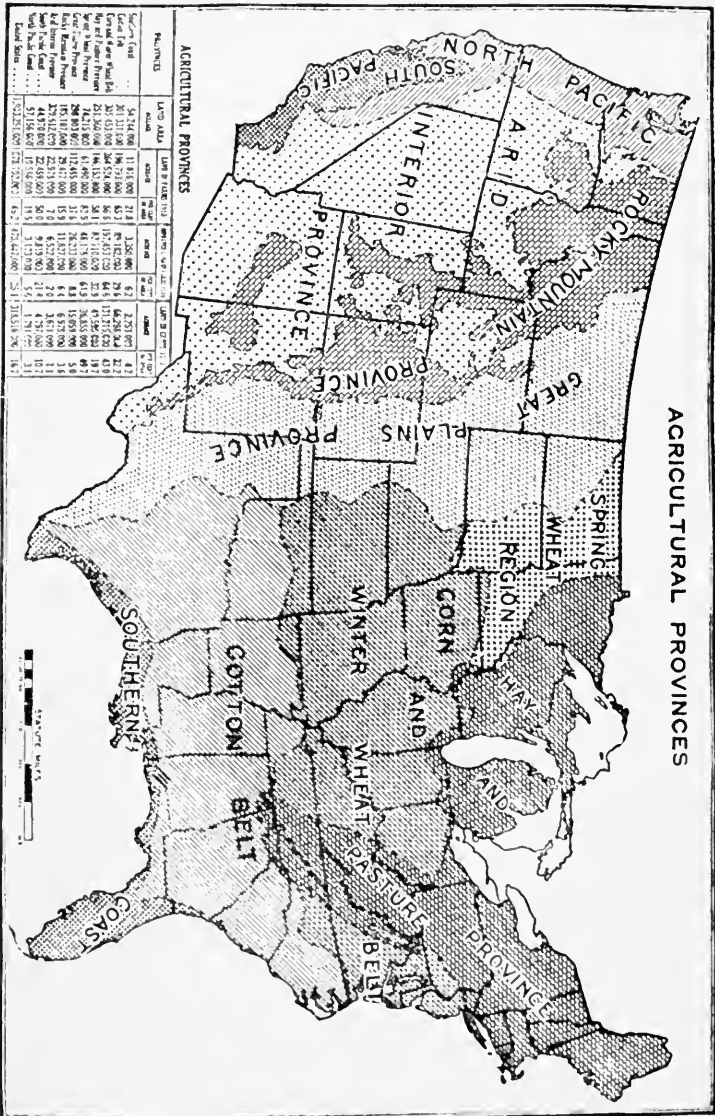

Fig. 189—Agricultural Provinces (U. S. D. A. Yearbook, 1915).

heavy phase of brown silt loam. If two crops of wheat are desired in the rotation, the extra one may follow the clover, seeded again to a different kind of clover to be plowed under for corn. This changes it to a five-year cycle. Another practical one where wheat is the leading crop is (1) wheat; (2) wheat (clover); and (3) clover.

Probably one of the best four-year rotations for the corn belt and one which gives two good money crops advantageously located in the cycle is (1) corn, (2) oats (clover), (3) clover; (4) wheat (clover). This gives three years during which the legume crops are growing and the rotation is adapted to soils deficient in nitrogen and low in organic matter. On the grain farm practically all of the clover crop should be turned back into the soil in any of these rotations. The clover may be clipped and left on the land and the second crop may be harvested for seed and the straw returned to the soil. All crop residues not fed should be turned back into the soil. If more corn is desired this may be changed to a five-year rotation by adding another year of corn, making (1) corn, (2) corn, (3) oats (clover), (4) clover, and (5) wheat (clover).

These rotations are well adapted to either grain or mixed farming, since the clover may be pastured to good advantage. Another year of pasture or hay may be easily added by seeding clover and timothy instead of clover alone. The first year of these the crop will be largely clover, while the second will be mostly timothy. If the clover should fail, soybeans may be substituted to be cut for hay or seed. Soybean straw is eaten very readily by stock.

If soybeans or cowpeas can be used to good advantage, a rotation containing one of the crops may well be practiced. The rotation might be (1) corn, (2) cowpeas or soybeans, (3) wheat (clover), (4) clover. The cowpea or soybean hay may be fed to stock and the manure returned to the soil.

Alfalfa may be included in the rotation by adding another field and growing it while the other crops are going the rounds of the regular rotation. At the end of this cycle, the alfalfa field is then put into corn and the clover field is seeded to alfalfa.

In these rotations alsike, mammoth, medium red, or sweet clover may be used. Where conditions are very favorable for getting a catch of alfalfa, this crop may be substituted for clover, but as a general rule it is a wise plan to leave a good stand of alfalfa for several years when once obtained.

2. For the Cotton Belt.—This region possesses many advantages in climate over the corn belt. It has a larger and better dis-

tributed rainfall with a longer growing season and mild winters. The unusual facilities for growing a money and a soil renovating crop during the same season give this section decided advantages over the corn belt. Winter cover crops on rolling land for preventing erosion, as well as green manure crops for increasing the scanty supply of organic matter, should be grown more extensively.

The principal money crop is cotton, yet a great many special crops are grown in different states. Mixed farming predominates in many places. In Kentucky, Tennessee, and Oklahoma livestock farming prevails, with the growing of grains next in importance. In Texas and Arkansas livestock is first, with cotton production second. Cotton is the leading crop in Alabama, Mississippi, Georgia, South Carolina, and Louisiana. In the latter, sugar cane is next in importance. This is also grown in North and South Carolina. Tobacco is grown extensively in Maryland, Virginia, Kentucky and North Carolina. Truck crops and fruits are extensively grown in Florida and near the Gulf in other states. Corn, rice, wheat, oats, kafir corn, milo maize, rye and buckwheat are grown in different parts of the region.

The forage crops are varied and comprise alfalfa, cowpeas, soybeans, red, alsike, crimson, Japan, and sweet clovers, vetches, timothy, blue, Johnson, brome, and Bermuda grasses, and millet. Peanuts, hemp, Irish and sweet potatoes are special crops in some sections.

This shows the large number of crops that are grown in this belt and the great opportunity for rotation. Much of the soil is acid and deficient in organic matter and nitrogen, and the rotation should be planned to maintain or increase the nitrogen rather than attempt to supply it from commercial fertilizers. Legumes must be grown that are not affected by acid unless limestone or lime has been applied to the soil. Japan clover, cowpeas, and soybeans fill these conditions, since they do very well on acid soils.

The cotton belt includes a very extensive area, large numbers of widely different soils, and considerable variation in altitude. These tend to give variety to the crops grown. The rotation for this belt should have one or more money crops, such as potatoes, cotton, tobacco, sugar cane, wheat, rice, one or more for feed and a crop for soil improvement. A very good rotation is (1) corn (cowpeas), (2) winter oats (cowpeas), (3) cotton (clover).

Where tobacco is grown, the following may be practiced: (1) tobacco, (2) wheat (clover), and (3) clover; or (1) corn (cowpeas),

(2) tobacco, (3) wheat (clover) and (4) clover. In the rice district the following is recommended: (1) rice, (2) rice, (3) corn (cowpeas), (4) winter oats (cowpeas), or (4) winter oats and vetch (cowpeas).

If one of the money crops is potatoes, then (1) corn (cowpeas), (2) potatoes (soybeans), and (3) cotton (crimson clover) may form the rotation. The legumes in corn and cotton should be used primarily for soil improvement, while those following other crops may be used for hay or soil improvement. These rotations are only suggestive. For the stock farm, almost any of the above rotations may be extended two or three years for hay or pasture, or both, with whatever meadow or pasture grass does best in the locality, whether it is redtop, timothy, brome, blue, or Bermuda grass.

3. For Hay and Pasture Province.—The hay and pasture province (Fig. 189) occupies the northeastern part of the United States in the cooler temperate zone with a southward extension in the Appalachian Mountains to northern Georgia. Grass for hay and pasture is the principal crop grown, yet corn, potatoes, rye, oats, wheat, clover, and barley are somewhat extensively produced in many areas.

The short seasons do not permit the growing of two crops and hence the greater difficulty of raising soil-renovating crops. There is, however, this advantage, that oxidation of organic matter does not take place so rapidly as in warmer climates and the supply is therefore easier to maintain.

The following rotations are recommended: (1) Potatoes, (2) rye (clover), (3) clover; or (1) corn, (2) potatoes, (3) rye (clover), (4) clover. For pasture or hay timothy may be seeded with the clover and left for two or three years. If desirable, oats may be substituted for rye. If potatoes are omitted, a good rotation is as follows: (1) corn, (2) oats, (3) wheat (clover), (4) clover and timothy, (5) timothy. This rotation may be shortened by leaving out wheat, making a very desirable rotation for some localities.

4. The spring wheat region and the great plains province occur east of the Rocky Mountains, and wheat is the principal crop of both. In the former (1) corn, (2) wheat, (3) wheat, and (4) legume may be practiced. In some localities potatoes may be substituted for corn. In a live stock system, clover and timothy may be sown and used for hay and pasture.

The crops of the *great plains province* vary extensively. Besides wheat, the sorghums form a very valuable crop in the southern third. To the north of this, wheat, together with some corn and alfalfa, is the principal crop. No definite rotation has been worked out for this area.

The principal farm crops in the provinces west of the Rocky Mountains are wheat and alfalfa, with some corn, oats, barley, rye, and sugar beets. The need of soil improvement is not so evident here as in humid regions, because of a much greater original supply of plant food. The extensive growth of alfalfa furnishes a ready and effective means for building up the soil.

QUESTIONS

1. Define a rotation of crops.
2. How does a scientific rotation differ from the above?
3. Give the objects of a rotation.
4. What are major crops?
5. What are minor crops?
6. How are crops rotated in nature?
7. What is the primary object of farming?
8. How does rotation affect the distribution of work?
9. Why is a one-crop system favorable to the development of insects?
10. Can you give an instance of disease caused by continuous cropping?
11. How does rotation prevent disease?
12. How are weeds kept down by rotation?
13. Give some examples of troublesome weeds in your locality that may be kept down by rotation.
14. Why is it a good practice to grow crops that root at different depths?
15. What part does rotation play in maintaining tilth?
16. What are toxic substances and how does rotation affect these?
17. Give the results obtained at the Iowa Station for continuous corn and rotation.
18. What results were obtained at the Illinois Station?
19. What do the Minnesota experiments show in regard to corn? Wheat? Hay?
20. Which cereal responds best to rotation?
21. If corn is worth 50 cents and wheat \$1.05 per bushel and hay \$8 per ton, what is the total value of the average crops in a three-year rotation? In a five-year rotation?
22. Which rotation gave the greatest acre value for the crop? (Assume that in a five-year rotation, three crops of hay were grown.)
23. Give a synopsis of the Ohio results.
24. What things are to be considered in planning a rotation?
25. What importance should be placed on the soil in these plans?
26. What consideration should guide in the selection of crops?
27. What determines the succession of crops?
28. What about the length of the rotation?
29. Why is it difficult to get a rotation under way?
30. Why is it advisable to divide the farm into as many fields as there are crops in the rotation?

31. Where should corn be placed in the rotation?
32. Where is the best place for wheat?
33. Where are oats grown best?
34. Where are winter oats grown?
35. What crops may well be followed by oats?
36. Where may rye be seeded?
37. What is a nurse crop and why necessary?
38. What do cowpeas and soybeans follow?
39. Locate the corn and winter wheat belt.
40. What are the principal crops there?
41. Give a good short-cycle rotation.
42. Give a good four-year rotation.
43. What is the rotation if two crops of wheat are desired?
44. Give a four-year rotation in which legumes are grown three out of four years.
45. How may these be adapted to mixed farming?
46. What is to be done if clover should fail?
47. What is the place of soybeans or cowpeas in the rotation?
48. How may alfalfa be included in the rotation?
49. Locate the cotton belt.
50. What advantages over the corn and winter wheat belt does it possess?
51. What are the principal money crops?
52. Name some other crops grown in this belt.
53. Give the forage crops grown.
54. Give a practical rotation with tobacco, cotton, rice and potatoes.
55. What should be done with the legumes?
56. How may these be adapted to livestock farming?
57. Where is the hay and pasture province?
58. What are its advantages and disadvantages?
59. Give rotations that may be practiced.
60. Locate the spring wheat region.
61. Name the crops and give a rotation.
62. What are the crops of the great plains region?
63. What are the important crops of the province west of the Rocky Mountains?

REFERENCES

- ¹ Hays, W. M., Boss, Andrew, Wilson, A. D., and Cooper, Thomas P., Bulletin 125, Minnesota Station, 1912, p. 36.
- ² Circular 131, Ohio Station.

General References.—Carleton, M. A., *Small Grains*, 1916. Livingston, George, *Field Crop Production*, 1915. Montgomery, E. G., *Productive Farm Crops*, 1915. Piper, C. V., *Forage Plants*, 1914. Duggar, J. F., *Southern Field Crops*, 1915. Parker, E. C., *Field Management and Crop Rotation*, 1915.

APPENDIX I

SOIL FERTILITY

WITHOUT attempting to go into the subject of soil fertility to any great extent, the authors have thought that a brief discussion of the subject, giving some of the underlying principles, would be helpful to the farmer. The field is such a large one, and the theories advanced are so varied and conflicting, that the practical farmer is at a loss to know what to do, and as a consequence does nothing. The fertility needs of soils may be determined in three ways: (1) by chemical analysis, by which the amount of plant food may be determined, (2) by pot culture experiments in greenhouses under almost perfect conditions, and (3) by actual field tests, where plant foods of different kinds may be applied and the results compared with those of an equal area of the untreated soil growing the same crop.

Permanent Agriculture.—Agriculture is usually considered a permanent industry, but it is no more permanent than the natural soil itself. If the fertility of the natural soil is inexhaustible, then agriculture is a fixed industry and likewise those industries, commerce, manufacturing, and mining, which depend so largely upon agriculture. If history tells us anything about agriculture it is this: that it is not permanent, that nations have fallen because the agriculture upon which their civilization depended had failed.

Are Soils Inexhaustible?—The productiveness of soils depends upon the amounts and kinds of plant food elements they contain, the favorable conditions for plant growth that they offer, and the friendly bacteria present. Chemical analyses show that plants contain certain mineral elements which they obtain from the soil. Analyses show further that soils contain these elements in limited quantities, and it requires no great amount of mathematical knowledge to see that if plants take even small amounts of these elements from this limited supply, reduction and final exhaustion are sure to follow unless the necessary elements are added by the farmer.

Complete exhaustion of plant food is not necessary to render a soil unproductive. If the soil presents adverse conditions to the plant, either through lack or excess of water, poor aëration, or bad physical condition, or if the proper bacteria are not present, or,

being present, are not under favorable conditions for carrying on their work, the plant suffers and the soil appears as if exhausted.

Plant Food Elements.—Ten elements are essential to the growth of plants. (See the table on page 2.) Of these, sulphur, calcium, magnesium, iron, nitrogen, phosphorus, and potassium are furnished by the soil. The last three are the ones most liable to be

*Plant Food in Crops **

Crop		Nitro- gen	Phos- phorus	Potas- sium	Mag- nesium	Cal- cium
Kind	Amount					
		<i>Pounds</i>	<i>Pounds</i>	<i>Pounds</i>	<i>Pounds</i>	<i>Pounds</i>
Wheat.....	{ grain 50 bushels	71	12	13	4	1
	{ straw 2½ tons	25	4	45	4	10
Corn.....	{ grain 100 bushels	100	17	19	7	1
	{ stover 3 tons	48	6	52	10	21
	{ cobs ½ ton	2	2
Rye.....	{ grain 40 bushels	38.1	8.3	11.2	2.6	0.9
	{ straw 2½ tons	25	6.5	35	3.5	11.0
Oats.....	{ grain 100 bushels	66	11	16	4	2
	{ straw 2½ tons	31	5	52	7	15
Barley.....	{ grain 50 bushels	42	7.9	10.1	2.9	1.0
	{ straw 2600 pounds	15.6	2.3	23.7	1.8	6.0
Clover.....	{ seed 4 bushels	7	2	3	1	1
	{ hay 4 tons	160	20	120	31	117
Cotton.....	{ lint 1000 pounds	3	0.4	4
	{ seed 2000 pounds	63	11	19
	{ stalk 4000 pounds	102	18	59
Soy beans.....	{ seed 25 bushels	80	13	24	2.1	1.7
	{ straw 2.25 tons	79	8	49
Cowpea hay.....	3 tons	130	14	98
Tobacco.....	{ leaf 1800 pounds	72	3.5	90	11.7	67.5
	{ stalk 3200 pounds	118.4	3.5	118.4	0.9	28.4
Timothy hay.....	3 tons	72	9	71	2.4	7.2
Alfalfa hay.....	6 tons	300	27	144	22.8	218.4
Sugar beets.....	20 tons	100	18	157	72	64
Potatoes.....	300 bushels	63	13	90	5.4	3.6
Turnip-roots.....	15 tons	75.1	12	111	54	183
Turnip-leaves.....	2 tons	16	2	18.4	11.2	109.2
Fat cattle.....	1000 pounds	25	7	1
Milk.....	10000 pounds	57	7	12

* Compiled from various sources.

deficient in soils. There are many indications, however, that calcium may become so low that legumes, which require large amounts of it, may suffer in their growth because of an insufficient supply.

Removal of Plant Food.—Crop Requirements.—Removal of plant food from the soil by the crop is one of the common causes

of lessened production. From the table on page 390, which gives the amount of plant food used by some common crops, it will be seen that a fifty-bushel crop of wheat requires ninety-six pounds of nitrogen, sixteen of phosphorus, fifty-eight of potassium, eight of magnesium, and eleven of calcium, a total of only one hundred and seventy-nine pounds. This is only two and one-fourth per cent of the weight of grain and straw produced. The percentage of plant food taken from the soil is the same for corn, while for oats it is slightly more than two and one-half per cent. For the crop to obtain even this small amount, it is necessary that much larger amounts be present in the soil, since only a small proportion is available each season. The yields given in the preceding table are high, but no larger than rich soils will produce under favorable conditions.

The legumes take most of their nitrogen from the air, but the other elements given in the table are taken from the soil. Other crops take all of their supply of these elements from the soil. Besides the elements given in the preceding table, iron is taken from the soil. However, there is such an abundance of iron in the soil and plants require so little that soils probably will never become deficient. In the case of sulphur, the amount needed is small and the soil receives some from the air during rains.

Supply of Plant Food in Soils.—The supply of plant food depends upon several factors. Probably the most important is the rock from which the soil was derived. A soil derived from a sandstone may contain very little plant food of any kind. A granitic soil will probably contain large amounts of calcium, potassium, some magnesium, and phosphorus. A limestone soil would contain considerable amounts of each element. Soils formed by mixtures of various rocks usually contain the largest supply.

Nitrogen is nearly always a later acquisition. Very few rocks, as that term is commonly used, contain nitrogen.

Leaching removes large amounts of plant food, and for this reason the soils of humid regions contain less than those of arid ones. Some exceptions occur in swamps, where the mineral plant food has been carried in by washing and leaching from the higher areas. Conditions are favorable for the accumulation of nitrogen through the more luxuriant growth and less rapid oxidation of vegetation. The physical composition of the soil plays a very important part in leaching, since the smaller the soil particles the less the leaching.

The cropping to which the soil has been subjected determines to a large extent the plant-food content. Every crop removed from the land takes away a certain amount of food, thus slowly reducing the supply.

The next table gives the amount of plant food in soils from various countries.

Total Plant Food in Some Residual Soils.—Pounds in Two Million Pounds of Soil*

	Sulphur	Phosphorus	Potassium	Calcium	Magnesium
Maryland barrens.....	180	2000	580	840
Adobe soil, New Mexico.....	5200	8200	28600	198800	35600
Coral limestone, Bermuda Islands.....	5400	2000	50200	5800
Soil from gneiss.....	1380	740	22200	5600	7000
Soil from gabbro.....	740	720	15400	7800	10600
Serpentine soil.....	560	1140	27600	8200	39000
Cambrian sandstone soil.....	800	1240	57400	9000	14800
Trenton limestone soil.....	820	1340	51600	8200	10400

* Compiled from various sources.

Fertility in Russian Steppe or Tchernozem Soils.¹—Pounds in Two Million Pounds of Soil

	Nitrogen	Sulphur	Phosphorus	Potassium	Calcium	Magnesium
Virgin.....	5400	560	1220	11950	21562	8800
Cultivated.....	4800	640	1133	8630	18700	9000

Plant Food in Missouri Soils.²—Pounds in Two Million Pounds of Soil

Soil	Total nitrogen	Acid soluble phosphorus	Acid soluble potassium
The standard of a very fertile soil.....	6000	2000	5300
Northeast Missouri level prairie (Vandalia)...	3640	1918	6175
Northeast Missouri level prairie (High Hill)...	2700	1608	4714
Northeast Missouri rolling prairie (Hurdland)...	3760	1978	6089
Northeast Missouri rolling prairie (Fulton)...	3640	1751	7188
North Missouri timber soil (Laclede).....	3000	1221	5362
Ozark upland (Climax Springs).....	1180	800	2889
Ozark upland (Oterville).....	1820	1350	4117
Ozark upland (Stonehill).....	1620	740	2623
Ozark border (New Haven).....	1460	740	5495
Ozark border (Wittenberg).....	1500	1660	5429
West Missouri rolling prairie (Garden City)...	3560	1445	5262
Southeast Missouri lowland silt (Hayti).....	5320	4584	17785
Southeast Missouri lowland sandy soil (Campbell).....	1700	1711	3566

*Plant Food in Soil Areas of Kentucky.*³—Pounds in Surface, 0 to 7 Inches,
Two Million Pounds

Formation	Total nitrogen	Total phosphorus	Total potassium
Trenton.....	3780	9416	26278
Cincinnati.....	3180	1924	31960
Silurian and Devonian.....	2480	1100	23940
Waverly.....	1960	650	19600
St. Louis.....	2106	890	28220
Chester.....	1700	702	26560
Western coal field.....	1980	766	29290
Eastern coal field (western part).....	2140	630	18180
Eastern coal field (central and eastern part)...	2980	1260	34213
Quaternary.....	1940	980	30926
River alluvium.....	3300	1910	34430

By taking the figures of crop requirements given in the tables, pages 390 and 398, it will be easy to calculate the length of time necessary to completely exhaust the soils by growing maximum crops. This will give a fair idea of the deficiency of certain plant foods in the soil.

Nitrogen.—Nitrogen is one of the most limited of the plant food elements in soils. It occurs in organic matter in combination with hydrogen, oxygen, carbon, sulphur, and other elements, and all non-leguminous plants are indirectly dependent upon this form. Legumes also use the nitrogen of the organic matter. Free nitrogen occurs in the soil air in large quantities, but this can be used only by legumes. One hundred corn crops of fifty bushels each would use all the nitrogen in the surface soil of the average brown silt loam, provided the stalks were turned back, while if the stalks and grain were both removed the nitrogen would all be used in a little more than sixty-five years.

Through the activity of soil organisms the soil nitrogen of the organic matter is slowly made available. The process takes place principally in the plowed soil and the amount of nitrogen made available each season is approximately two per cent of the total nitrogen in this stratum. If there are four thousand pounds in the plowed soil, about eighty pounds will become available, or an amount sufficient to produce a fifty-bushel crop of corn.

Nitrogen is the limiting element over large areas of soil, and its increase and maintenance becomes one of the most important as

Fertility in Soils of Illinois.* Average Pounds Per Acre in Two Million Pounds of Surface, 6% Inches. Total.

Type of soil	Organic carbon	Organic matter †	Nitrogen	Phosphorus	Potassium	Magnesium	Calcium
Upland prairie soils							
Brown silt loam.....	59,723	102,962	5,010	1,168	36,185	9,069	10,424
Black clay loam.....	84,581	145,817	7,073	1,738	33,136	13,637	21,427
Brown-gray silt loam on tight clay.....	42,551	73,357	3,745	1,033	33,055	6,492	17,870
Brown sandy loam.....	38,551	66,461	3,198	961	30,264	5,676	7,846
Gray silt loam on tight clay.....	27,432	47,292	2,777	812	25,664	4,597	4,157
Upland timber soils							
Yellow-gray silt loam.....	27,411	47,256	2,426	861	35,432	6,256	7,036
Yellow silt loam.....	19,126	32,973	1,750	733	38,175	7,043	6,086
Light gray silt loam on tight clay.....	20,893	36,019	1,850	802	31,973	5,393	6,651
Yellow-gray fine sandy loam.....	16,305	28,039	1,530	755	39,510	5,395	6,485
Yellow-gray sandy loam.....	20,216	34,852	1,742	708	30,920	5,293	7,355
Terrace soils							
Brown silt loam over gravel.....	62,097	107,055	5,411	1,334	32,051	8,557	10,117
Brown silt loam on gravel.....	47,237	81,436	4,167	1,504	34,507	8,112	8,470
Yellow-gray silt loam over gravel.....	29,800	51,375	2,908	1,124	37,264	6,522	9,776
Yellow-gray silt loam on gravel.....	30,613	52,776	3,266	1,193	36,453	6,687	8,647
Swamp and bottom land soils							
Deep brown silt loam.....	50,746	87,486	4,333	1,670	37,134	12,071	19,513
Deep gray silt loam.....	26,222	45,206	2,520	1,234	34,758	7,068	6,554
Drab clay.....	46,230	79,700	4,253	1,273	33,997	12,265	11,950
Mixed loam.....	63,756	109,915	5,757	1,444	36,225	17,119	28,968
Deep peat ‡	308,344	531,585	24,748	1,770	5,563	6,087	61,863

* Figures obtained from Illinois Soil Reports 1 to 18.

† Organic matter determined by multiplying organic carbon by factor 1.734.

‡ Peat, surface 1,000,000 pounds, subsurface 2,000,000 pounds, subsoil 3,000,000 pounds.

Fertility in Soils of Illinois.* Average Pounds Per Acre in Four Million Pounds of Subsurface, 6½ to 20 Inches. Total.

Type of soil	Organic carbon	Organic matter †	Nitrogen	Phosphorus	Potassium	Magnesium	Calcium
Upland prairie soils							
Brown silt loam.....	68,816	118,638	5,999	1,863	74,647	21,646	18,111
Black clay loam.....	76,288	131,520	6,593	2,562	68,744	28,267	34,449
Brown-gray silt loam on tight clay.....	36,268	62,526	3,134	1,528	69,184	14,766	14,156
Brown sandy loam.....	38,031	65,565	3,404	1,443	63,723	17,156	15,035
Gray silt loam on tight clay.....	28,505	48,688	3,042	1,370	53,722	13,242	7,970
Upland timber soils							
Yellow-gray silt loam.....	20,236	34,886	2,300	1,513	75,144	19,055	15,869
Yellow silt loam.....	12,182	21,001	2,067	1,538	77,261	22,696	12,266
Light gray silt loam on tight clay.....	15,726	27,111	1,909	1,420	65,880	15,962	11,555
Yellow-gray fine sandy loam.....	14,970	25,808	1,845	1,885	72,105	16,435	11,380
Yellow-gray sandy loam.....	17,302	29,828	1,783	1,407	64,423	13,068	12,915
Terrace soils							
Brown silt loam over gravel.....	57,829	99,697	5,211	2,017	73,520	19,686	16,200
Brown silt loam on gravel.....	44,340	76,442	4,370	1,840	69,880	21,120	16,270
Yellow-gray silt loam over gravel.....	21,496	37,059	2,600	1,792	76,848	20,024	15,424
Yellow-gray silt loam on gravel.....	27,600	47,582	3,000	2,280	73,827	19,340	16,813
Swamp and bottom land soils							
Deep brown silt loam.....	78,201	134,818	6,783	2,797	74,109	23,373	38,174
Deep gray silt loam.....	20,494	35,331	2,292	1,875	65,270	13,878	10,754
Drab clay.....	49,307	85,005	4,500	1,920	68,960	24,757	22,480
Mixed loam.....	81,196	139,981	7,569	2,491	67,700	35,160	57,258
Deep peat ‡.....	619,163	1,067,437	49,598	2,512	10,853	11,902	116,626

* Figures obtained from Illinois Soil Reports 1 to 18.

† Organic matter determined by multiplying organic carbon by factor 1.724.

‡ Peat, surface 1,000,000 pounds, subsurface 2,000,000 pounds, subsoil 3,000,000 pounds.

Fertility in Soils of Illinois. Average Pounds Per Acre in Six Million Pounds of Subsoil, 20 to 40 Inches. Total.*

Type of soil	Organic carbon	Organic matter †	Nitrogen	Phosphorus	Potassium	Magnesium	Calcium
Upland prairie soils							
Brown silt loam.....	32,139	55,407	3,519	2,429	116,631	60,838	59,972
Black clay loam.....	35,575	61,331	3,357	3,373	108,316	53,140	66,623
Brown-gray silt loam on tight clay.....	27,066	46,661	3,089	2,625	103,293	41,190	29,298
Brown sandy loam.....	26,391	45,498	2,657	2,071	10,301	33,877	41,973
Gray silt loam on tight clay.....	22,782	39,276	2,952	2,135	90,207	32,207	23,477
Upland timber soils							
Yellow-gray silt loam.....	18,640	32,135	2,442	2,545	116,576	52,741	58,778
Yellow silt loam.....	16,575	28,575	2,841	2,664	123,399	58,007	52,444
Light gray silt loam on tight clay.....	18,842	32,483	2,512	2,610	99,683	37,137	21,757
Yellow-gray fine sandy loam.....	13,405	23,110	2,050	3,265	110,320	35,775	28,025
Yellow-gray sandy loam.....	14,440	24,894	1,786	2,284	106,702	39,540	41,934
Terrace soils							
Brown silt loam over gravel.....	37,009	63,803	3,489	2,803	110,091	40,131	27,120
Brown silt loam on gravel.....	42,610	73,459	4,490	2,750	102,160	42,600	30,720
Yellow-gray silt loam over gravel.....	22,176	38,231	3,204	3,492	110,580	52,848	49,956
Yellow-gray silt loam on gravel.....	28,800	49,651	3,180	2,700	103,620	30,360	27,180
Swamp and bottom land soils							
Deep brown silt loam.....	60,834	104,878	5,434	3,583	111,577	41,474	54,760
Deep gray silt loam.....	16,576	28,577	2,280	2,546	97,204	23,164	15,290
Drab clay.....	52,420	90,372	3,840	2,130	103,150	43,550	39,290
Mixed loam.....	66,406	114,484	5,937	2,970	104,212	63,662	105,662
Deep peat ‡.....	809,839	1,396,162	58,251	3,127	23,013	18,924	166,850

* Figures obtained from Illinois Soil Reports 1 to 18.

† Organic matter determined by multiplying organic carbon by factor 1.724.

‡ Peat, surface 1,000,000 pounds, subsurface 2,000,000 pounds, subsoil 3,000,000 pounds.

well as one of the most difficult problems for the farmer (Figs. 190 and 191). The methods that have been recommended for maintaining the organic matter will usually maintain the nitrogen. It is the most expensive plant food element, and more of it is required by crops than of the other elements. When the market price is eighteen cents per pound the cost of the nitrogen for a bushel of corn is twenty-seven cents, for wheat thirty-six cents, and for oats



FIG. 190.—Wheat growing on a soil very deficient in nitrogen. Note the effect of the addition of nitrogen (N). Average yield for nitrogen, 32 grams per pot, without nitrogen 3 grams. (Illinois Soil Report.)



FIG. 191.—Legumes turned under have the same effect as the addition of nitrogen. Yields for a four-year average were as follows: No nitrogen, 4 grams per pot, legumes 18 grams, and for nitrogen 20 grams. (Illinois Soil Report.)

about eighteen cents. This price makes its purchase almost, if not entirely, prohibitive for ordinary grain crops.

Nitrogen can be readily incorporated with the soil by turning under a *crop of inoculated legumes*. These may be grown in connection with some of the money crops, such as corn, cotton, wheat, rye, oats, and others, and turned under for soil enrichment. The cotton belt and the southern part of the corn and wheat belt are

especially well adapted to this method. It must be remembered that nitrogen is readily lost by leaching, especially after it becomes available.

It would be well to emphasize the necessity of turning the legumes under instead of removing them. In many places the legumes are made into hay and sold from the farm, or fed without returning the manure. Under these circumstances very little is accomplished toward permanent soil improvement by growing legumes.

Composition of Tops and Roots. Crops Seeded July 22 (Delaware Station)

Crop and date of harvest	Air-dry matter	Pounds per acre and per cent in roots		
		Nitrogen	Phosphorus	Potassium
Cowpeas, tops.....	3718	65.2	7.2	39.2
Nov. 7, Roots 0 to 8 inches.....	301	4.2	1.0	1.9
Roots 8 to 12 inches.....	9	.1	.1	.1
Per cent in roots.....	8	6.0	13.0	8.0
Soybeans, tops.....	6790	130.9	16.5	38.3
Nov. 11, Roots 0 to 8 inches.....	717	8.8	1.0	1.4
Roots 8 to 12 inches.....	39	.5	.0	.1
Per cent in roots.....	10	6.5	5.5	4.0
Vetch, tops.....	3064	108.0	9.8	65.1
Roots 0 to 8 inches.....	584	12.8	2.0	5.7
Roots 8 to 12 inches.....	16	.4	.1	.2
Per cent in roots.....	17	11.0	18.0	8.0
Crimson clover, tops.....	5372	128.2	25.9	69.7
Nov. 20, Roots 0 to 8 inches.....	381	5.7	.8	3.2
Roots 8 to 12 inches.....	32	.5	.1	.3
Per cent of roots.....	7	6.0	3.5	5.0
Alfalfa, tops.....	2267	54.8	5.7	26.7
[#] Roots 0 to 8 inches.....	1962	40.2	3.7	7.9
Roots 8 to 12 inches.....	8	.2	.0	.0
Per cent in roots.....	47	42.0	39.0	23.0
Red clover, tops.....	2819	69.8	8.3	38.6
Nov. 22, Roots 0 to 8 inches.....	1185	32.5	4.3	8.0
Roots 8 to 12 inches.....	27	.7	.1	.2
Per cent in roots.....	30	32.0	35.0	18.0

From the preceding table it will be seen that of the legumes given, alfalfa adds the largest amount of nitrogen to the soil, forty-seven per cent in its roots, and red clover second with thirty-two per cent. When the two crops of red clover are removed from the land, the nitrogen left in the soil in roots and stubble is on an average probably no more than equal to that taken from the soil by the crop, so there is no addition of this element under such a practice. The table shows that the roots of cowpeas, soybeans, and crimson clover contain a very low per cent of the total nitrogen. These crops if harvested from the land probably not only add no nitrogen but actually remove some from the soil.

Fresh farmyard manure contains about ten pounds of nitrogen per ton, and the futility of trying to maintain this element with manure on the average grain farm is readily seen. All manure should be used to the best advantage, but where fifty bushels of corn per acre, and other crops that remove equivalent amounts of nitrogen, are grown it would require about twenty tons of average farmyard manure per acre every four years to maintain it, even if there were no other source of loss.

Commercial Forms of Nitrogen.—The forms in which nitrogen may be obtained commercially for use as a fertilizer are as follows:

1. **Sodium nitrate** constitutes the principal form in which the element nitrogen is obtained for use in commercial fertilizers. The salt occurs in northern Chili and after being purified by crystallization contains 15 to 16 per cent of the element. Chlorides and sulfates are present in small quantities. It is very readily soluble and should be applied only when the crop is growing to prevent loss by leaching, since it is not absorbed to a very great extent by the soil. It is used by market gardeners and may be applied to timothy meadow and small grains. Its continued use deflocculates the soil, producing a puddled condition.

2. **Ammonium Sulphate.**—Ammonia is a by-product in the distillation of coal and the sulfate is produced by passing the ammonia through sulfuric acid. It contains about 20 per cent of nitrogen. This salt is readily absorbed and because of this is not so readily leached from the soil. It should not be applied in the fall, because it will be changed to nitrates and leached out and lost. Its continued use tends to deflocculate the soil somewhat as sodium nitrate does.

3. **Cyanamid or Calcium Cyanamid.**—This is an artificial product made by passing nitrogen into retorts containing highly-heated calcium carbide. It is a heavy, black, granular powder, and should be incorporated with the soil for some days before planting to avoid any toxic effect that might be injurious to the seeds and young plants. It contains about 16 per cent of nitrogen.

4. **Organic Substances.**—Certain materials that were formerly waste products are valuable for their nitrogen. Among these are cottonseed meal, containing 7 or 8 per cent of nitrogen; linseed meal, with about 5.5 per cent; dried blood, containing from 13 to 15 per cent, and tankage, which has from 4 to 10 per cent of nitrogen and 1 to 8 per cent of phosphorus.

Phosphorus.—Large areas of land all over the world are deficient in the element phosphorus to such an extent that it becomes the limiting factor. It is especially important in the production of grain and in the growth of legumes. Its addition helps to make possible the building up of soil by larger growth of nitrogenous soil-renovating crops. In addition to this it improves the quality and increases the weight of the grain (Figs. 192 and 193).

The needs of a soil for phosphorus may be determined by applying two hundred and fifty pounds of steamed bone meal per acre to wheat or corn by sowing broadcast before the seed bed is prepared and securing accurate yields of equal areas of the treated and untreated land. Definite conclusions, however, should not be based upon a single year's results.

Phosphorus may be purchased in several forms: (1) raw bone meal, (2) steamed bone meal, (3) raw rock phosphate or floats, (4) acid phosphate, and (5) basic or Thomas slag.

Bone meal is made from the bones of animals slaughtered at the packing houses. The bones are a by-product and their high content of phosphorus makes them valuable. The raw bones may be ground up into meal, but this contains three to five per cent of nitrogen and large amounts of fat and oil. The nitrogen is very expensive, while the fat is of no value to the soil. The bones may be steamed under high pressure, thus removing the fats and oils and gelatin. The bones are then ground into meal that is placed on the market as *steamed bone meal*. This contains less nitrogen and more phosphorus than the raw bone.

Rock Phosphate.—Phosphorus has been deposited in large quantities as a mineral combined with other elements forming the tri-calcium phosphate, practically the same as bone in composi-



FIG. 192.—Wheat, 1911, Urbana field. Cover crops and farm manure plowed under. Average yield, 34.2 bushels per acre. (Illinois Soil Reports.)



FIG. 193.—Wheat, 1911, Urbana field. Cover crops and farm manure plowed under. Finely ground rock phosphate applied. Average yield, 51.8 bushels per acre. (Illinois Soil Reports.)

tion. Large deposits are found in South Carolina, Florida, Tennessee, Utah, and other states. This is mined and, when finely ground, constitutes the *raw rock phosphate* of commerce. When this phosphate is treated with an equal weight of sulfuric acid, the resulting product is *acid phosphate*. This treatment renders most of the phosphorus available. It contains from six to eight per cent of the element phosphorus.

Basic slag, a by-product formed in the manufacture of steel from iron ores containing considerable phosphorus, has been extensively used in Europe as a source of phosphorus, but to no large extent in this country.

Forms Compared.—Of these different sources, steamed bone meal, acid and raw rock phosphate are most commonly used.

Without entering into a lengthy discussion of the merits of each of these, it may be said in general that upon soils low in organic matter acid phosphate or steamed bone meal may be used to good advantage. If the soil is well supplied with organic matter, finely ground rock phosphate will be preferable, since the acids produced by the decay of the organic matter render the phosphorus available. Any form of quickly decaying organic matter, such as legumes, green or barnyard manure, will aid in liberating the phosphorus. For immediate results the rock phosphate should be applied before the material is turned under. It may be added to the soil for the purpose of helping to obtain a catch of clover. For best results with any form of phosphate, limestone should be present in the soil.

In the use of phosphorus on soils deficient in this element the one purpose should be to increase the amount by applying more than is used by the crops. A naturally fertile soil rarely contains less than fourteen hundred to sixteen hundred pounds of the element per acre in the plowed soil.

Most upland soils, as shown by the tables on pages 392, 393, and 394, actually contain from eight hundred to twelve hundred pounds. In the building up of these soils an excellent plan is to add a ton of finely ground rock phosphate per acre every four to six years until the amount has reached that of a normal fertile soil, or about eighteen hundred to two thousand pounds in the surface seven inches of an acre. After this is reached a sufficient amount should be applied to replace that removed by the crops.

The cost of a pound of the element phosphorus is a thing that is frequently overlooked. In bone meal and acid phosphate the cost of a pound of phosphorus was about twelve and one-half cents per

pound in 1916, while in the rock phosphate the phosphorus cost from two and one-half to three cents per pound, depending upon the distance from the mines, in material containing fourteen per cent of the element phosphorus or 32 per cent of phosphoric acid.

If rock phosphate of the same money value as acid phosphate or bone meal were applied and the conditions were at all favorable, the results obtained would compare well with those from the other forms and the phosphorus content of the soil would be increased, as so much more of the element would be added.

Potassium.—As may be seen from the tables, pages 392, 393, and 394, soils vary a great deal in their content of potassium. Clay and silt soils contain the most, while peats and sands have least. Many peat soils are so deficient in this element that applications of potassium are necessary. Notwithstanding the large amount in soils, it is sometimes so unavailable that crops fail to obtain the amount necessary for good yields. Potassium is usually locked up in silicate minerals and the action of acids of some kind is necessary to liberate it. This may be accomplished by the acids of decaying organic matter which attack the minerals and free the potassium.

In soils such as peat the potassium may be supplied by applications of potassium sulfate or chloride, each containing about eight hundred fifty pounds of the element per ton, or kainit, containing two hundred pounds (Fig. 194). Wood ashes contain five per cent of potassium. Annual applications of one hundred to two hundred pounds of the sulfate or chloride per acre are sufficient for most crops. Manure may be used, but a ton contains only eight pounds, and the nitrogen of manure has a much greater value upon other types of soil.

Other Elements.—While several other elements are required for crops, the supply in the soil is so large, or the amount used by crops is so small, that there is little danger of a deficiency. Sulfur is required in small amounts, and probably will need to be applied only in the case of crops such as turnips, cabbage, etc., which require large amounts. Iron is used only in small amounts and the soil contains an abundance. Calcium and magnesium are low in some soils, especially acid ones, and may be easily supplied in limestone, which has been discussed in Chapter XII.

Lime, Limestone.—All soils should contain some carbonate, but more especially calcium carbonate or limestone. Its presence is very important in the functioning of nitrifying bacteria and the production of available nitrogen. A base must be present to unite with the nitrous and nitric acids formed, or the presence of these

free acids will inhibit the action. Chemical combination takes place and calcium nitrites and nitrates are formed, the latter of which are available for the use of plants.



FIG. 194.—Corn on peaty swamp land, 1903. Lime and phosphorus at top, yield 0. Lime and potassium at bottom, yield 72.5 bushels per acre. (Bulletin 157, Illinois Agricultural Experiment Station.)

The element calcium is used by plants as food, as shown by the table on page 390, and there is little doubt but that it may be limiting the size of the crops on some soils.

Soils frequently are acid or become so after long cropping, bringing about conditions unfavorable for the growth of many legumes. This acidity may be removed by the use of lime, limestone, or some other carbonate. Many bacteria cannot develop in an acid soil.

Lime and limestone have a beneficial effect upon the physical condition of the soil, since it produces flocculation or granulation. This process is especially important upon heavy soils and those deficient in organic matter, and for this reason is more beneficial when applied to such soils. Quicklime is more effective in this way than calcium carbonate.

Nitrogen, Phosphorus and Potassium in Fertilizing Materials, Pounds Per Ton of 2000 Pounds

Material	Nitrogen	Phosphorus *	Potassium †
Acid phosphate.....	114 to 160
Ammonium sulfate.....	400
Apatite.....	300 to 400
Ashes, wood, leached.....	8 to 14	16 to 50
Ashes, wood, unleached.....	8 to 18	66 to 132
Basic slag.....	88 to 160
Blood, dried.....	260 to 300
Bone meal, raw.....	60 to 80	180 to 220
Bone meal, steamed.....	40 to 60	200 to 220
Cottonseed meal.....	140 to 160	18 to 26	25 to 33
Kainit.....	200 to 220
Linseed meal.....	110	15.6	22.6
Manure, barnyard, fresh....	10	2	8
Nitrate of soda.....	300 to 320
Phosphate:			
Tennessee rock.....	240 to 300
Florida hard rock.....	320
Potassium chloride.....	820 to 880
Potassium nitrate.....	260	730
Potassium sulfate.....	800 to 840
Tankage, general range.....	80 to 200	20 to 160
Tobacco waste.....	40 to 80	4 to 8	80 to 160

* To find the weight of phosphoric acid (P_2O_5) per ton multiply the weight of phosphorus by 2.3.

† To find the weight of potash (K_2O) multiply the weight of potassium by 1.2.

Forms in Which Lime May Be Applied.—Lime may be applied to soils in several different forms. Quick or caustic lime may be used, but it is now generally believed that it is not the best form to apply because of its tendency to encourage the decomposition of organic matter.

Air-slaked lime is a form that may be used, but its extreme fineness invites active solution and loss by leaching.

Marl is formed by chemical precipitation in small lakes in glacial regions, and consists of a more or less impure calcium carbonate, usually somewhat loose and fine. It is only of local significance.

Limestone when ground so that it will pass through a screen of ten meshes to the inch makes an excellent material for applying to the soil. The dust or finely ground limestone is ready for immediate use, while the coarser part gives durability so that applications will not need to be made so often.

The Best Form to Apply.—Experiments have been carried on at some experiment stations to test the value of different forms. At the Pennsylvania Station two tons of slaked lime once in four years and of ground limestone every two years were used on different plots and the total yields were greater for ground limestone. Analyses of samples from each plot showed 375 pounds less of nitrogen for the plot receiving air-slaked lime. Experiments at the Maryland Station gave larger yields for ground limestone.

REFERENCES

- ¹ Hilgard, E. W., *Soils*, 1906, p. 364.
- ² Miller, M. F., Circular 69, Missouri Station, *The Fertility of the Soil*, 1914, p. 6.
- ³ Averitt, A. D., Bulletin 193, *Soils of Kentucky*, Kentucky Station, 1915, p. 141.

General References.—Hopkins, Cyril G., *Soil Fertility and Permanent Agriculture*, 1910. Van Slyke, Lucius L., *Fertilizers and Crops*, 1915. Hall, A. D., *The Soil*, 1912. Whitson, A. R., and Walster, H. L., *Soils and Soil Fertility*, 1912.

APPENDIX II

TABLES

Average Yield of Crops Per Acre by States in United States.* Ten-year Average (1906-1915)

States	Corn		Wheat		Oats		Rye		Barley		Potatoes		Cotton		Flax		Buck-wheat		Rice	
	Bushels	Bushels	Bushels	Bushels	Bushels	Bushels	Bushels	Bushels	Bushels	Bushels	Bushels	Bushels	Pounds	Bushels	Bushels	Bushels	Bushels	Bushels	Bushels	Bushels
Maine.....	40.8	25.5	38.0	28.6	204	29.3
New Hampshire.....	41.2	35.6	26.2	125	26.3
Vermont.....	40.3	25.9	38.1	18.0	32.2	123	24.5
Massachusetts.....	42.3	34.6	17.3	118	19.4
Rhode Island.....	38.8	29.4
Connecticut.....	44.2	31.8	18.8	104	18.5
New York.....	36.2	20.2	32.2	17.3	26.8	97	20.6
New Jersey.....	36.5	18.2	29.6	17.6	102	20.4
Pennsylvania.....	39.2	17.5	30.6	16.9	26.1	85	20.1
Delaware.....	31.9	16.7	29.5	15.2	90	20.1
Maryland.....	34.9	16.5	28.0	15.4	30.3	86	18.3
Virginia.....	24.7	12.6	20.2	13.0	27.2	85	228	19.2
West Virginia.....	30.0	13.2	22.9	13.0	86	21.3
North Carolina.....	18.3	10.4	17.8	10.1	76	244	17.7	25.6
South Carolina.....	16.7	10.3	20.5	9.9	80	224	23.7
Georgia.....	14.0	10.5	19.0	9.2	76	194	27.4
Florida.....	13.2	16.2	85	123	26.1
Ohio.....	39.1	16.6	33.0	16.9	27.8	86	20.2
Indiana.....	36.8	15.8	29.4	15.7	25.7	81	17.1
Illinois.....	34.4	16.3	32.2	17.2	29.4	79	18.4

Average Yield of Crops Per Acre by States in United States.* Ten-year Average (1906-1915)

States	Corn	Wheat	Oats	Rye	Barley	Potatoes	Cotton	Flax	Buck- wheat	Rice
	Bushels	Bushels	Bushels	Bushels	Bushels	Bushels	Pounds	Bushels	Bushels	Bushels
Michigan.....	33.5	16.7	31.5	14.9	25.5	94	15.5	...
Wisconsin.....	34.8	18.3	33.2	17.4	28.0	102	...	13.4	15.4	...
Minnesota.....	32.3	13.9	31.4	19.1	24.5	102	...	9.9	16.8	...
Iowa.....	34.4	18.0	32.4	18.5	26.7	84	...	10.3	15.4	...
Missouri.....	27.7	14.1	24.1	14.5	23.8	71	288	7.1	15.8	...
North Dakota.....	23.9	11.9	27.8	16.1	21.1	96	...	8.2
South Dakota.....	27.8	11.8	27.4	16.7	22.0	86	...	8.5
Nebraska.....	25.0	17.8	25.4	16.4	21.6	74	...	8.6	17.6	...
Kansas.....	20.2	13.9	24.9	14.6	18.1	65	...	6.7	14.5	...
Kentucky.....	27.6	12.6	21.5	13.1	26.4	77
Tennessee.....	25.2	11.4	21.6	11.6	24.5	72	197	16.6
Alabama.....	16.4	11.4	18.8	11.2	82	174	27.8
Mississippi.....	18.3	13.2	18.9	86	193	28.7
Louisiana.....	19.9	20.5	67	173	31.8
Texas.....	20.2	22.4	13.6	23.9	62	170	33.6
Oklahoma.....	19.4	12.5	24.6	12.5	21.5	65	175
Arkansas.....	20.4	11.5	22.9	10.7	73	191	39.0
Montana.....	26.7	25.3	45.1	22.2	33.8	149	10.3
Wyoming.....	23.5	26.5	37.1	20.2	32.7	131	10.4
Colorado.....	21.2	24.6	38.7	17.6	35.7	116	7.4
New Mexico.....	25.9	22.8	35.2	31.9	90
Arizona.....	32.1	27.3	38.5	38.0	112
Utah.....	31.7	25.4	46.1	18.0	41.8	152
Nevada.....	32.6	29.3	43.6	40.2	162
Idaho.....	31.1	26.9	44.9	21.8	40.6	161
Washington.....	27.1	22.4	47.9	20.3	37.7	141
Oregon.....	29.3	21.6	36.9	17.0	34.0	122
California.....	35.6	16.1	34.0	15.5	28.0	129	442	48.5
Average of United States.....	26.6	15.0	30.0	16.4	25.6	97.5	186	8.6	20.0	36.1

Average Yield of Wheat Per Acre for Ten Years (1905 to 1914), Bushels*

United States	Russia (European)	Germany	Austria	Hungary proper	France	United Kingdom
14.8	9.9	30.7	20.0	18.1	20.1	33.4

* Yearbook U. S. D. A., 1915.

APPENDIX III

THE following maps are taken from the Yearbook of the United States Department of Agriculture for 1915:

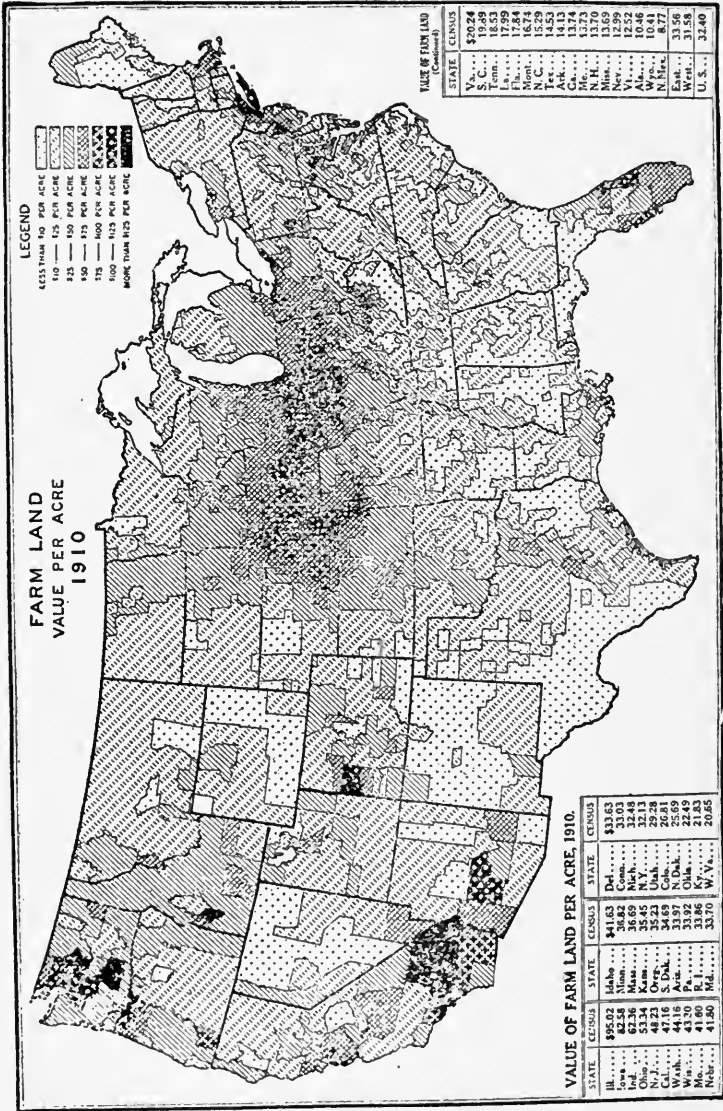

FIG. 195.—Farm land, value per acre, 1910.

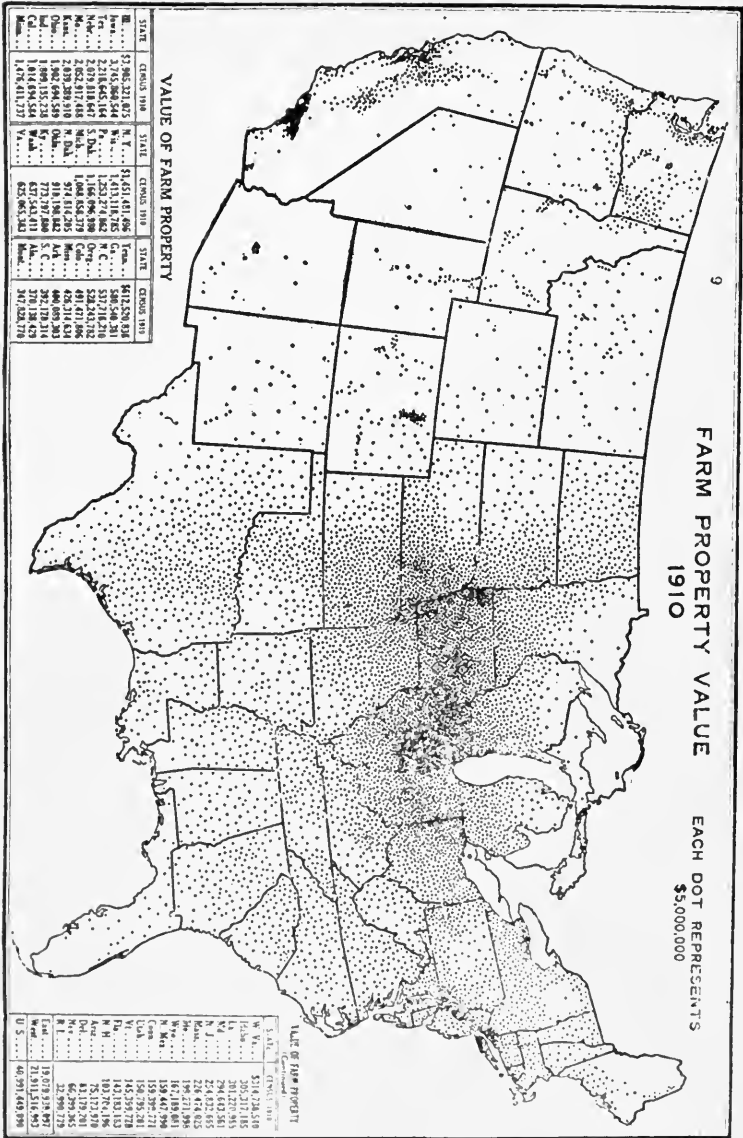

FIG. 106.—Farm property, value, 1910.

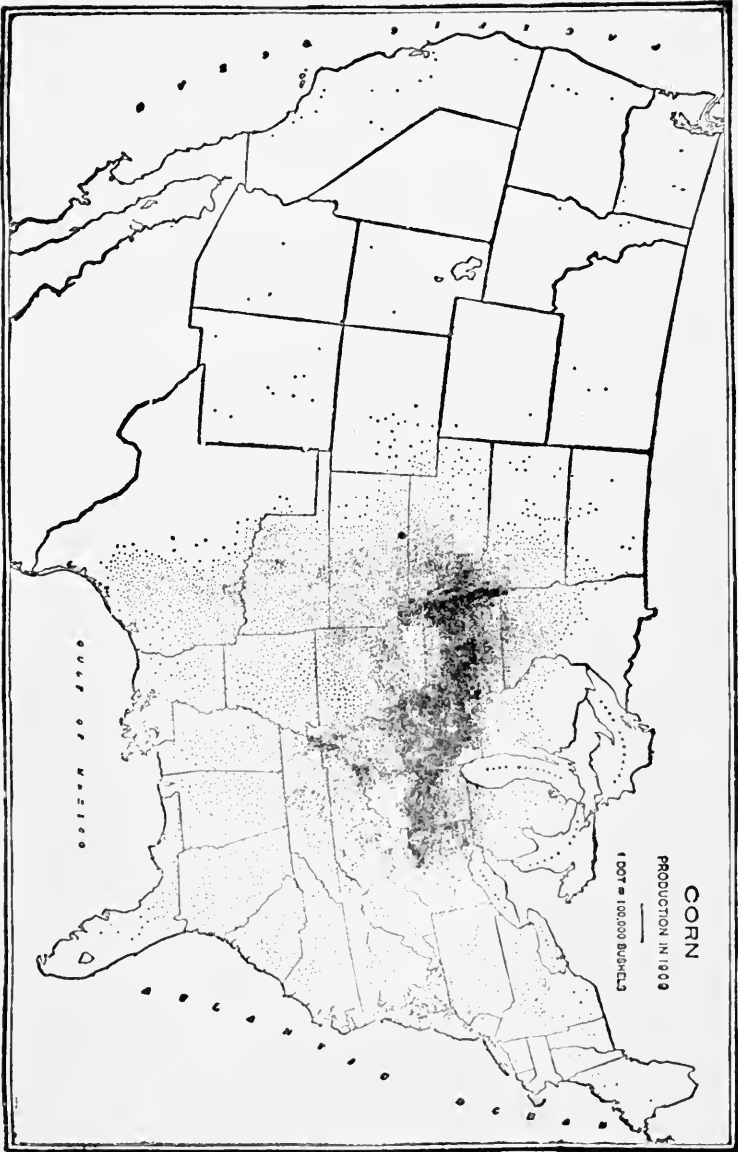

Fig. 198.—Corn production, 1909.

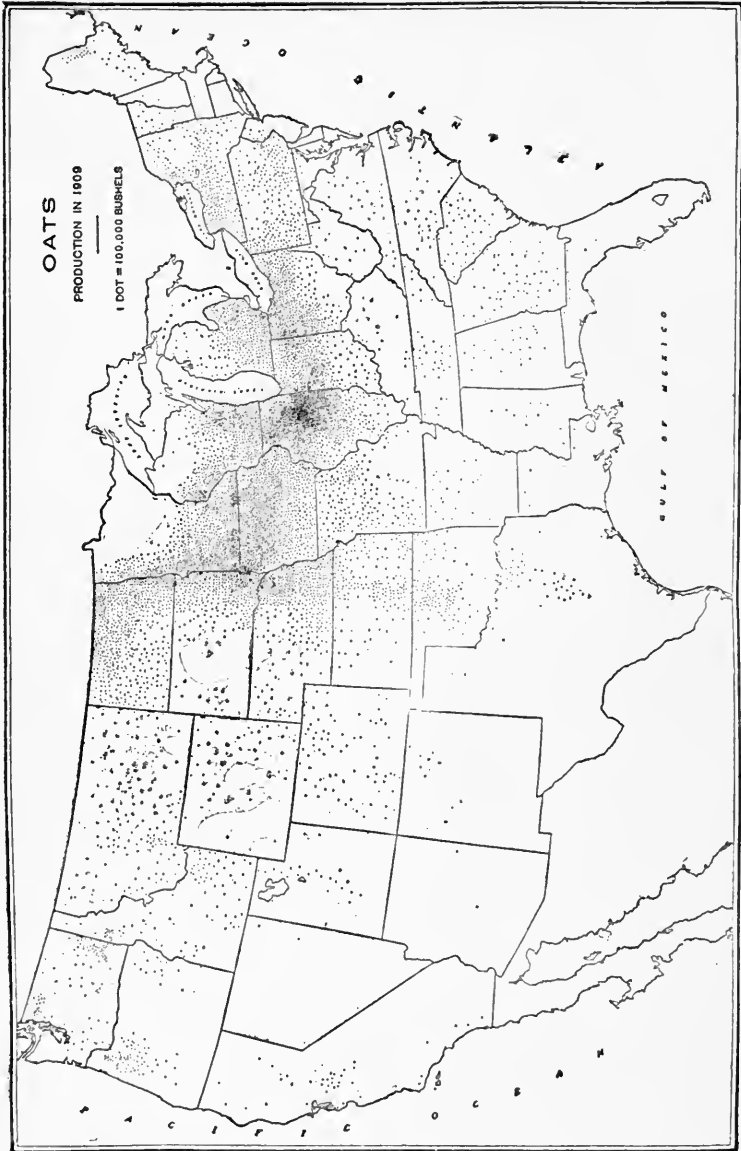

Fig. 199.—Oats production, 1909.

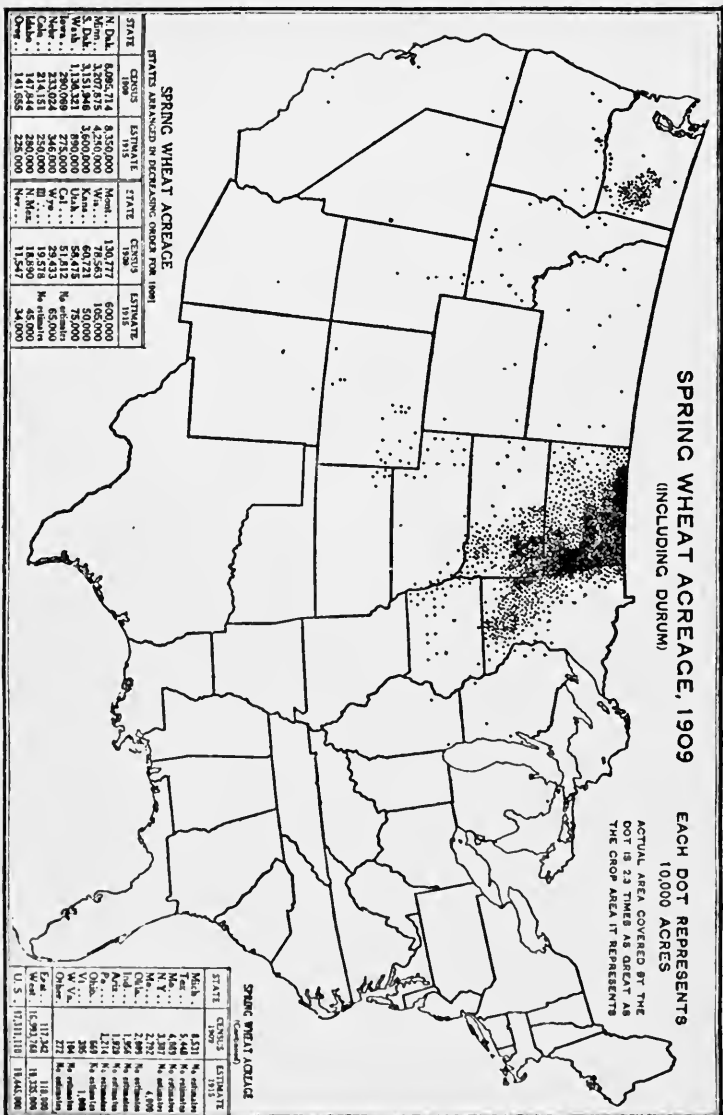

Fig. 200.—Spring wheat acreage, 1909.

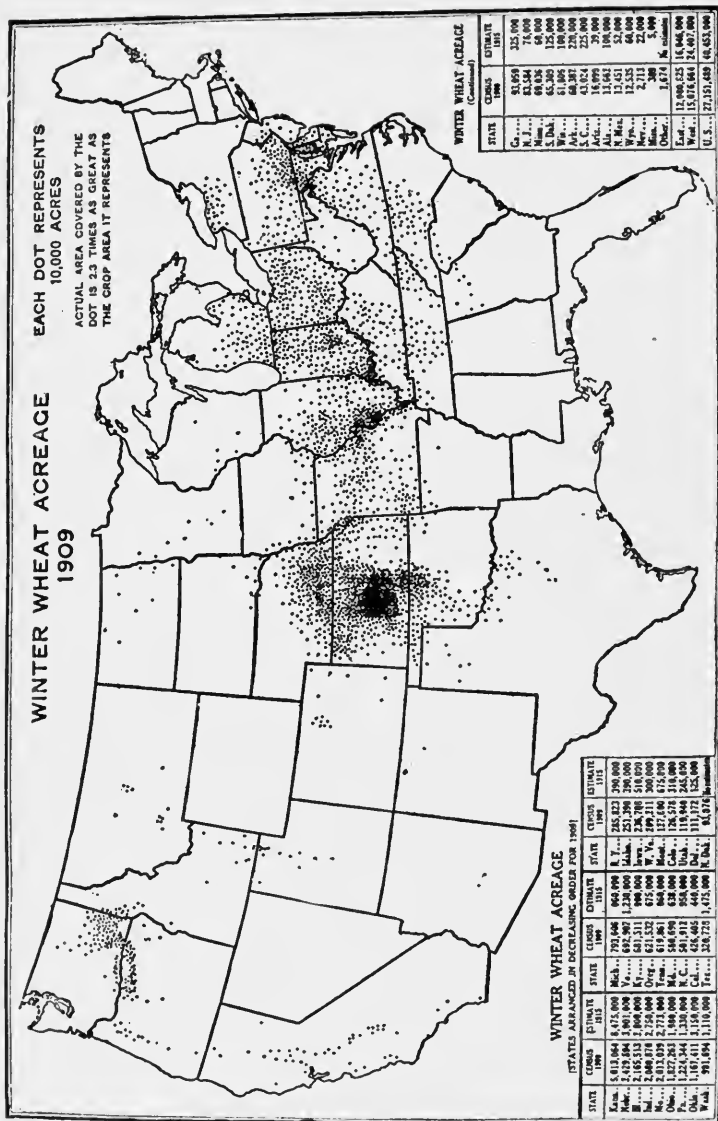

Fig. 201.—Winter wheat acreage, 1909.

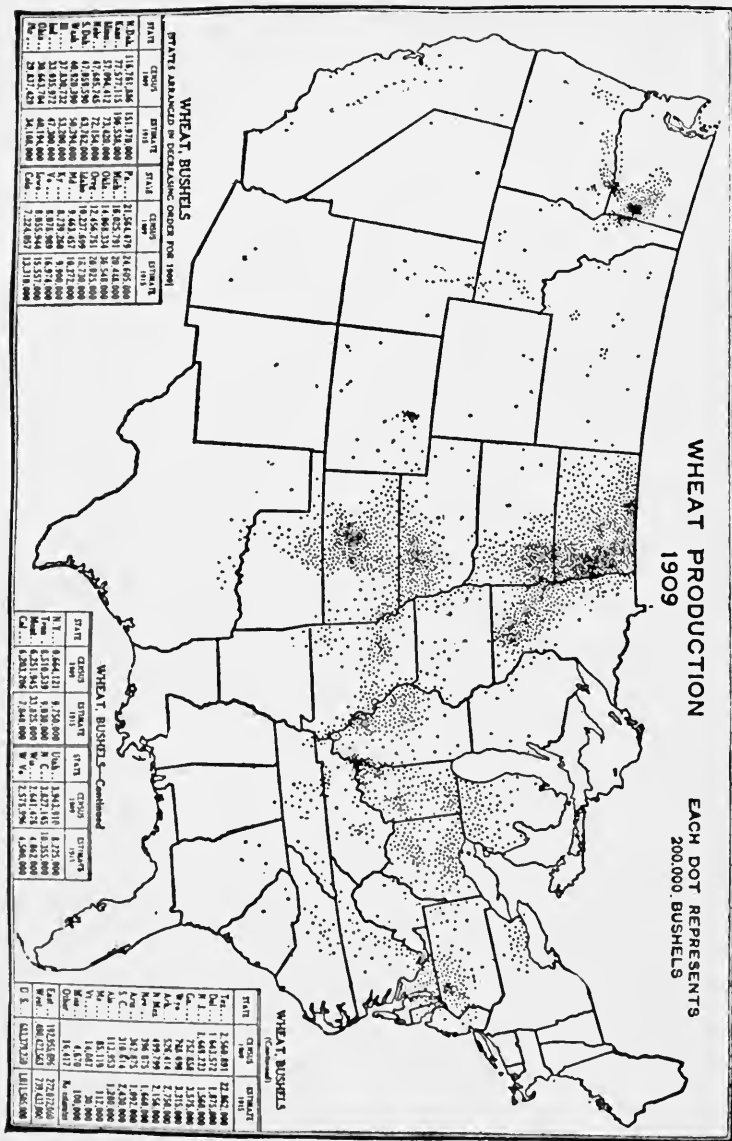

Fig. 202.—Wheat production, 1909.

INDEX

- Ablation swamp, 30
Absolute specific gravity, 175
Absorbents, factor in conserving manure, 165
Absorption and radiation of heat, effect of, on soil temperature, 302
Acclimated seed, desirable on dry land, 255
Accumulations in pastures, aid in maintaining organic-matter content, 160
Acid, chromic, method of determination of organic matter, 154 phosphate, 402
Acids, decomposition of rocks by, 19 carbonic, hydrochloric, nitric, sulfuric, 20
Acre-inches, 192
Adaptation of region to dry farming, factors in, 238 evaporation, 241 rainfall, 238 soils, 241
Adobe, 65
Adsorption by colloids, 132
Aëration and soil air, chapter on, 309 affecting bacteria, 320 aided by drainage, 223 or soil ventilation, 311 accomplished by atmospheric pressure, changes in, 311 diffusion, 311 removal of water, 311 temperature changes, 312 tillage, 313 wind movement, 313
Aftonian Inter-glacial Stage, 46
Agassiz, Lake, 38 extent of, 46
Agencies of weathering, chemical, 19 physical, 12
Agricultural provinces, 383
Agriculture, dry-land, chapter on, 238 permanent, 389
Air in soils, amount of, 309 convection currents of, source of loss of heat, 296
Air in soils, composition of, 310 use of, 309
Alfalfa, completely killed by heaving, 226 crop for dry land, 253
Alkali, area, absence of vegetation on, 286 black, neutralization of, 281 effect of irrigation on rise of, 281 on foliage of apricot trees, 283 on plants, 282 kinds of, 280 land, growth of barley on, partly and fully reclaimed, 288 reclaimed, wheat on, 289 lands, and their reclamation, chapter on, 278 utilization and reclamation of, by removal of alkali salts, 285 growing alkali-resistant crops, 285 neutralizing black alkali, 286 plowing deep and turning alkali under, 286 retarding evaporation, 285 limit for germination and growth, 284 origin of, 278 resistant crops, growing of, 285 rise of, prevented by cultivation, 286 drainage, 226 salts, removal of, by cropping, draining, flooding, leaching, scraping, 287 soils of humid regions, reclamation of, 290 spot, beginning of, 279 turning under of, 286
Alluvial soils, 38
Alluviation by glacial stream, 62
Altitude, affecting organic content of soils, 145
Ammonia, effect on flocculation, 137
Ammonification, 318

- Ammonium sulfate, 399
 Amphibole, 3
 Analyses, chemical, of adobe, 65
 Analysis, mechanical or physical, 123
 physical, systems of, 124
 Andesite, 7
 Animals, decomposition by, 25
 Apatite, calcium phosphate, 5
 Appalachian Mountain and Plateau Province, 81
 Apparent specific gravity, 175
 Aqueous rocks, 7
 Area, and projects, irrigation, 258
 internal, of soil types calculated from physical composition, 182
 of soil surveyed in the United States by Bureau of Soils to 1915, 78
 of spheres, columnar arrangement, 181
 or internal surface, 181
 Arid soils, 74
 nitrogen in humus of, 147
 subsoils, and humid, 70
 Arrangement of particles, 179
 columnar, area of spheres, 181
 or vertical, 180
 oblique, 180
 Artificial mulch, defined, 233
 Aspirator, King's, 128
 Atkinson, A., and Nelson, J. B., storing rainfall, Montana, 248
 Atlantic and Gulf Coastal Plains Province, 91
 Atmosphere, carbon dioxide in, 20
 Atmospheric pressure, changes in, factor in aëration, 311
 effect on percolation, 219
 Auger, soil, 119
 Available moisture, 214
 increased by drainage, 223
 Averitt, A. D., plant food in soil areas of Kentucky, 393
 Babb, table, sediment carried by streams, 35
 Bacteria, conditions for development, 319-321
 aëration, 320
 food, 319
 light, 321
 moisture, 319
 Bacteria, conditions for development, physical composition of soil, 321
 reaction, 320
 temperature, 320
 distribution of, 318
 number of, effect of lime upon, 321
 per gram of air-dry soil, 319
 Bacterial action, effect of potassium carbonate upon, 321
 Barley, yield of, continuous cropped *vs.* after fallow, 249
 Barnyard manures, 161
 Barometric pressure, changes in, factor in aëration, 311
 Bartlett, W. H., expansion of rocks on heating, 13
 Basalt, 7
 Basic slag, 402
 Bates, with Lynde, osmosis in soils, 212
 Beach or Marram grass, transplanting, 56
 Beavers, J. C., manure excreted by farm animals, 162
 value of increase for manure, heavy and light applications, 168
 Bennett, H. H., Bureau of Soils, soil survey, 78-111
 Biological effects of organic matter, 150
 Biotite, black mica, 4
 Black alkali, neutralization of, 286
 Black locusts, hold sand, 59
 prevent washing, 368
 "Blowout," in sand dune, 59
 Bog, climbing, 28
 quaking, 28
 Bogs, *see* hummocks, 30
 Boiling and freezing points, colloids, effect on, 131
 Bone meal, 400
 Boulder, granite, 51
 limestone, showing glacial scratches, 42
 Boulders, from moraine, 51
 Bouyoucos, G. J., effect of color on radiation, 295
 on temperature of sands, 302
 specific heat of soil constituents, 299

- Bouyoucos, G. J., time for heat to penetrate soil, 306
- Briggs, L. J., ratio between viscosity and flow of water, 219
thickness of hygroscopic film, 194
- Briggs, Martin, and Pearce, Bureau of Soils, sizes of particles, 124
chromic acid method of determining organic matter, 154
- Briggs and McLane, moisture equivalent centrifuge, 202
- Briggs and Shantz, water requirement of plants, Akron, Colorado, 242
wilting coefficient, 212
determination of, 197
- Brown, E. E., with Schreiner, O., progress of humification, 146
- Brown, P. E., bacteria per gram of air-dry soil, 319
- Brownian movement, 130
- Buckingham, little loss of water by interstitial evaporation, 232
- Bureau of Soils
centrifugal method of physical analysis, 127
classification of soils, chapter on, 78
grades of soil particles, 124
provinces, soil
 Appalachian Mountain and Plateau, 81
 Atlantic and Gulf Coastal Plains, 91
 Glacial and Loessial, 84
 Glacial Lake and River Terrace, 89
 Limestone Valleys and Uplands, 83
 Piedmont Plateau, 79
 River Flood Plains, 97
regions, soil
 Arid Southwest, 106
 Great Basin, 106
 Great Plains, 100
 Northwest Intermountain, 105
 Pacific Coast, 107
 Rocky Mountains, 104
series, soil
 Acadia, 92
 Alamance, 79
 Altamont, 107
- Bureau of Soils,
series, soil
 Amarillo, 103
 Arkansas, 104
 Bangor, 84
 Bates, 100
 Benton, 101
 Berks, 81
 Bibb, 97
 Billings, 105
 Bingham, 106
 Blanco, 97
 Boise, 105
 Boone, 101
 Brennan, 92
 Brooks, 83
 Caddo, 92
 Cahaba, 97
 Caldwell, 106
 Cameron, 97
 Canyon, 102
 Caribon, 84
 Carrington, 84
 Cazenovia, 85
 Cecil, 79
 Chehalis, 110
 Chemango, 89
 Chester, 80
 Cheyenne, 104
 Clark, 101
 Clarksville, 83
 Clyde, 89
 Colbert, 83
 Colby, 102
 Coloma, 85
 Colorado, 103
 Comasauga, 81
 Conestoga, 83
 Congaree, 97
 Corning, 107
 Cossayma, 85
 Coxville, 92
 Crawford, 101
 Crowley, 93
 Dawes, 103
 Decatur, 83
 DeKalb, 81
 Dunkirk, 90
 Durham, 80
 Dutchess, 85
 Duval, 93
 Durant, 93
 Edna, 93
 Elkton, 93

Bureau of Soils,
series, soil
Englewood, 101
Ephrata, 105
Epping, 101
Everett, 108
Fargo, 90
Fayetteville, 82
Flushing, 85
Fox, 90
Fresno, 108
Frio, 98
Ganett, 103
Genesee, 98
Gila, 107
Glendale, 107
Gloucester, 85
Goliad, 93
Greensburg, 103
Greenville, 93
Hagerstown, 83
Halston, 98
Hanceville, 82
Hanford, 108
Hesson, 108
Holyoke, 86
Houston, 93
Huntington, 98
Imperial, 107
Indio, 107
Iredell, 80
Jordan, 106
Kalmia, 98
Kewaunee, 86
Knox, 86
Lackawanna, 86
Lake Charles, 94
Lansdale, 80
Laramie, 105
Laredo, 98
Laurel, 104
Leonardtown, 94
Lexington, 86
Lincoln, 104
Lintonia, 98
Louisa, 80
Lufkin, 94
Lynden, 109
Manchester, 90
Manor, 80
Maracopa, 109
Marion, 86
Marshall, 86
Maverick, 94
Meigs, 82
Melbourne, 108

Bureau of Soils,
series, soil
Memphis, 87
Merrimac, 90
Mesa, 105
Miami, 87
Miller, 98
Mohawk, 87
Monroe, 94
Morton, 101
Myatt, 99
Nueces, 94
Oekloeknee, 99
Oktibbeha, 95
Olympic, 109
O'Neill, 102
Ontario, 87
Orangeburg, 95
Orono, 90
Osage, 99
Oswego, 101
Oxnard, 109
Penn, 80
Pierre, 101
Placentia, 109
Plainfield, 90
Plymouth, 87
Podunk, 99
Porters, 82
Portsmouth, 95
Pratt, 103
Puget, 111
Putnam, 87
Quiney, 105
Redding, 110
Richfield, 103
Richland, 87
Rosebud, 103
Ruston, 95
Sacramento, 111
Salem, 111
San Antonio, 95
San Joaquin, 109
San Luis, 104
Sarpy, 99
Sassafras, 95
Scranton, 96
Sharkey, 99
Shelby, 88
Sidney, 101
Sioux, 91
Stockton, 110
Summit, 102
Superior, 91
Susquehanna, 96
Talladega, 82

- Bureau of Soils,
series, soil
- Tifton, 96
 - Trinity, 99
 - Tripp, 104
 - Trumbull, 88
 - Union, 88
 - Upshur, 82
 - Uvalde, 99
 - Valentine, 102
 - Vergennes, 91
 - Vernon, 102
 - Victoria, 96
 - Volusia, 88
 - Wabash, 99
 - Wade, 104
 - Walla Walla, 105
 - Waukesha, 91
 - Waverly, 100
 - Webb, 96
 - Westmoreland, 82
 - Whatcom, 110
 - Wheeling, 100
 - Williams, 88
 - Willows, 110
 - Wilson, 96
 - Winchester, 105
 - Wooster, 88
 - Yakima, 106
 - Yazoo, 100
 - Yolo, 110
 - York, 81
 - Yuma, 107
 - Zapata, 103
- Calcareous rocks, chalk, marl, 8
- Calcite, calcium carbonate, 5
- Calcium carbonate, calcite, 5
- carried by Thames River, 23
 - concretions, 62
 - cyanamid, 400
 - magnesium carbonate, dolomite, 5
 - sulfate, gypsum, 5
- Call, L. E., methods of preparing land for wheat, 347
- Campbell, H. W., pioneer in dry farming, 247
- subsurface packer, 247, 337
- Canals, loss of water from, 266
- Capillarity, amount of water moved by, 210
- Capillary lift of soil constituents, 212
- pull of soils, 211
- Capillary capacity or moisture-holding capacity of soils, 209
- rise of water in glass tubes, height of, 199
 - rapidity and height in different soils, 207
 - water as films or waists about particles, 200
 - in covered and uncovered soil, 204
 - of soils, chapter on, 199
 - movement, affected by organic matter, 206-208
 - substances in solution, 205
 - temperature, 204
 - texture, 206
 - thickness of film, 203
 - viscosity, 204
 - use of, 212
- Carbonated water, almost universal solvent, 20
- Carbon dioxide
- aid in solution, 22
 - brought to earth in precipitation, 20
 - decomposition by, 20
 - in rain and snow water, 20
 - soil air and atmosphere, 20
- Catch and cover crops, 161
- aid in preventing erosion, 362
- Cates, J. S., and Cox, H. R., results of corn cultivation, 28 states, 353
- Caves, due to action of carbonated water, 22
- Centers of accumulation, Cordilleran, Keewatin, Labradorian, 45
- map of, 47
- Centrifugal elutriator, Yoder's, 128
- method of physical analysis, Bureau of Soils, 127
- Chains, for puddling mud of canals to prevent seepage, 267
- Chalk, 8
- Characteristics of water, physical, 186
- Chemical agencies of weathering, 19
- changes in soil, source of heat, 294
 - precipitates, 8
- Chernozem soils, roots and humus in, 144
- Chester, F. E., effect of lime upon number of bacteria, 321
- Chicago, Lake, 38

- Chromic acid, and combustion methods, comparison, organic matter, 155
method of determination of organic matter, 154
- Churn elutriator, physical analysis, Hilgard, 126
- Cippoletti or trapezoidal weir, 269
- Classes, types and phases, in Illinois, 114
- Clay, defined, 134
dunes, 53
effect of, on shrinkage, 133-135
loams, 115
tight, 68
- Clays, 114
and clay loams, properties of coagulation or flocculation, 137
plasticity, 135
puddling, 136
shrinkage, 135
tenacity, 134
- Clark, F. W., composition of known earth, 2
- Classification of soils, by Bureau of Soils, chapter on, 78
based on color, 77
geology, 72
lithology, the parent rock, 73
moisture, 73
temperature, 73
texture, 77
vegetation, 75
need of, 72
- Cleavage, vertical, characteristic of deep loess, 63, 64
- Coagulation or flocculation of clays, 137
- Coal, formation of, from organic matter, 146
- Coffey, G. N., dark color indicating outcrop of limestone, 177
lime and magnesia in soils, 75
mineral content of soils, 74
reports clay dunes in Texas, 53
soluble salts in soils, 74
- Colloids, affecting hygroscopic moisture, 195
dialysis and diffusion of, 131
examples of, 129
in soils, 132
organic and mineral, 132
properties of, 130
adsorption, 132
- Colloids, properties of, boiling point, effect on, 131
Brownian movement, 130
dialysis, 130
diffusion, 130
electrical behavior, 131
freezing point, effect on, 131
shrinkage, 132
size of particles, 130
- Colluvial soils, 30
- Color of soils, 176
changed by erosion, 361
effect of deoxidation on, 21
on temperature, 303
of sands, 302
factor in classification, 77
- Colorado mud-flow, 34
river, work of, 17
Grand Cañon, 17
- Columbia glacier, over-riding forest, Alaska, 14
front of, 15
- Columnar arrangement of particles, 180
- Combustion and chromic acid methods, comparison, organic matter, 155
in oxygen determination of organic matter, 154
- Compacters, bar roller, 337
corrugated roller, 336
cultipacker, 336
drum roller, 335
plankers, 337
subsurface packer, 337
- Compacting the soil, a part of tillage, 326
increases moisture capacity, 230
- Composition of feldspars, 3
fresh manure, 163
known earth, 2
river sediments, 262
- Concrete dams for filling gullies, 373
- Concretions, calcium carbonate, 63
iron, 64
- Conductivity of soil, effect of, on temperature, 306
material, 306
- Constituents of soils, mineral, chapter on, 123
organic, chapter on, 142
- Contour plowing, deep, aid in checking erosion, 364
seeding, aid in checking erosion, 365

- Control of moisture, chapter on, 222
- Cordilleran center of accumulation, 45
- Corn, acreage, 1909, 412
- belt rotations, 382
- comparison, cultivated, scraped, weeds allowed to grow, 351
- cultivation, 353
- effect on yield of root pruning and deep and shallow cultivation, 355
- grown on dry land, 252
- on swamp land, effect of potassium on, 404
- method of preparing seed bed for, 348
- planter, 338
- production, 1909, 413
- results of cultivation, 352
- yields of, different methods of tillage, 354
- Cotton belt, rotation for, 384
- Cottrell, H. M., pounds seed per acre for different crops, 255
- Cover and catch crops, 161
- Cox, H. R., with Cates, J. S., results corn cultivation, 28 states, 353
- Cracks, in black clay loam, 136
- shrinkage, effect of, on percolation, 219
- Cropping, alternate *vs.* continuous, yields, 250
- continuous *vs.* after fallow, wheat yields, Montana, 248
- loss of organic matter, due to, 151
- systems of, 248
- Crop requirements, plant food, 390
- Crops, alkali-resistant, growing of, on alkali land, 285
- catch and cover, 161
- deep rooting, effect of, 345
- on moisture capacity, 174
- for dry farming, see dry farming crops
- for irrigated land, see irrigated land, crops for
- non-tilled, factor in maintaining organic matter, 171
- plant food in, 390
- Crops, protection from erosion by catch and cover, 362
- meadows and pastures, 361
- rotation of, aid in maintaining organic matter, 171
- ten-year average yield of, by states in United States, 407, 408
- Crystalloids, dialysis and diffusion of, 131
- Cultivation after irrigation, 273
- and summer tillage in dry farming, 246
- level, 355
- object of, 350
- of corn on gray silt loam on tight clay, yields, 353
- of corn, Illinois yields, 352
- results of deep and shallow, with and without root pruning, corn, 355
- ridged, 356
- Cultivators, 337
- blade, 339
- disk, 339
- shovel, 338
- weeder, 340
- Cumulose soils, 27
- Currents of air, convection, source of loss of soil heat, 296
- Cyanamid, calcium, 400
- Dams, for filling gullies, concrete, 273
- earth, 271, 272
- Deacon, G. F., relation between velocity and amount of material carried by streams, 33
- Débris cliff, 30
- Decomposition, effect of, on loss of constituents of rock, 22
- of organic matter by drainage, 225
- of rocks, 11
- by acids, 19
- by animals, 25
- by plants, 25
- through solution, 22
- Deep-rooting crops, effect of, 345
- on water capacity of soil, 231
- Deherain, effect of aëration on nitrifying bacteria, 320
- loss of nitrates by leaching, 322
- Denitrification, nitrates lost by, 323

- Density, with surface tension of solutions, 206
- Deoxidation, 21
- Deposits, eöliäl, 53
glacial or ice-laid, chapter on, 41
- Determination of humus, 156
- Diabase, 7
- Dialysis and diffusion, colloids, crystalloids, 131
of colloids, 130
- Diffusion, factor in aëration, 311
temperature for, 298
- Digestibility of feeds, 162
- Diorite, 7
- Disintegration by plants, 19
by waves, 18
by wind, 18
of rocks, 11, 32
- Distribution of alkali, vertical and horizontal, 281
of irrigation water, 268
- Ditches, open drains, 226
- Dobeneck, hygroscopic moisture in relation to relative humidity, 196
- Dolomite, calcium magnesium carbonate, 5
- Dorsey, C. W., reclamation of alkali land by underdrainage, 289
alkali at Maryland station, 290
- Drain gages, 220
- Drainage, chapter on, 222
benefits of, aëration improved, 223
alkali, rise of, prevented, 226
decomposition and nitrification increased, 225
erosion decreased, 226
granulation improved, 222
heaving reduced, 225
moisture, available, increased, 222
stability increased, 222
temperature raised, 225
effect of, on germination and growth, 223
on soil temperature, 301
from 8 feet of saturated sand, 221
types of, open or ditches, 226
tile, 228
- Drains, see Drainage
- Drills, seeders, 337
- Drumlins, 44
formation of, 45
- Dry-farming, crops for alfalfa, 253
barley, 251
corn, 251
emmer, 252
kafir, 252
milo maize, 252
oats, 251
potatoes, 253
rye, 251
sorghum, 252
spelt, 252
wheat, 250
deep, medium-grained soil well adapted to, 243
- Dry-land agriculture, chapter on, 238
- Dumont, effect alkaline carbonate on nitrate production, 321
- Dunes, clay, sand, silt, 53
permanent or fixed, 55
wandering, migatory, 54
- Dupré, with Lynde, capillary pull, 211
osmosis in soils, 212
- Dust and loess, physical analysis of, 64
storm, 54
volcanic, 65
- Dynamiting of soils, 345
- Earth, composition of, 2
dam for filling gullies, 371, 372
- Earth's crust, elements of, 1
- Earthworms, aid in soil formation, 315
effect of, on soil, 25
- Eel-grass, 37
- Elements of earth's crust, 1
plant food, 390
- Electrical behavior of colloids, 133
- Elutriator, method of physical analysis, Schöne, 124
churn, Hilgard's 126
centrifugal, Yoder's, 128
- Eöliäl deposits, or wind-laid soils, 53
adobe, in part, 64, 65
loess, 60-64
sand, 53-64
volcanic dust, 65
- Eroded hill lands, yield from, 360
soil once forested, China, 359
- Erosion, chapter on, 357
cause of,
rainfall, character of, 359
texture and structure of soil, 358

- Erosion, cause of, topography, effect of, 358
 vegetative covering, 359
 checked by brush, 372
 decreased by drainage, 226
 by organic matter, 150
 headwater, 372
 in pasture, 370
 kinds of, sheet, 361
 gullying, 369
 of streams, 16
 old-field in Mississippi, 370
 organic matter lost by, 151
 results of, color of soil changed, 361
 organic matter and nitrogen removed, 360
 physical character of soil changed, 360
 sheet, methods of prevention and reclamation, contour seeding, 365
 crops, protection by, 361
 deep contour plowing, 364
 limestone, application of, 361
 organic matter, increasing, 363
 reforestation, 369
 residues, 363
 terracing, 365
 tiling, 369
- Eruptive rocks, 6
- Esker, Adeline, 44
 material composing it, 45
 formation of, 45
- Evaporation, effect of, on soil temperature, 300
 factor in adaptability of a region to dry farming, 241
 from a free-water surface and rainfall, 241
 large loss from, in dry farming, 243
 loss by, effect on transpiration, 191
 of water, cools soil, 296
 prevented by mulches, 232
 rainfall and, Rothamsted, 211
 rainfall and percolation, Rothamsted, 220
 retarding of, factor in cropping alkali land, 285
- Everglades, Florida, 29
- Exfoliated granite in California, 13
- Expansion, enormous, due to hydration, 21
 due to oxidation, 21
 of rocks, 13
- Expressing moisture content, ways of, 191
- Fall plowing, 342
- Fallow, continuous *vs.* after, wheat yields, Montana, 248
- Fallowing, loss of organic matter by, 153
- Farm land, value per acre, 410
 property, value per acre, 411
- Feeds, digestibility of, 162
- Feldspars, 3
 composition of, 3
- Fermentation in manure, factor in loss of organic matter, 164
- Fertility in Illinois soils, 394-396
- Films and waists of water about particles, 200
 thickness of, in soil column, 201
- Fine sandy loams, 116
- Fippin, E. O., with Lyon, T. L., surface tension and density of certain solutions, 206
- Fires, organic matter lost by, 152
- Fischer, carbon dioxide in rain and snow water, 20
- Flocculation, effect of ammonia, lime, gypsum, sodium carbonate on, 137
 or coagulation of clays, 137
- Flooding orchards, basin system, 270
- Florida everglades, 29
- Flow of water, comparison between computed and observed, 129
- Food for bacteria, 319
- Forbes, R. H., value of material carried by Salt River, 262
- Forest, being buried by sand dune, 55
 resurrected, 55
- Fragmental deposits, 8
- Freezing and boiling points, colloids, effect on, 131
 and thawing, 14
 effect on water-logged soil, 223
- Furrow irrigation of potatoes, 271
- Geological classification of soils, 72
- Georgeson, influence of manure on soil temperature, 294
- Germination and growth, effect of drainage on, 223
 limit of alkali for, 284
 temperature for, 296

- Gilbert with Lawes, transpiration, 188
- Glacial and loessial province, 84
 drift, gravelly phase, 41
 grooves, striae, 43
 lake and river terrace province, 89
 lakes, 50, 51
 extent of, 46
 or ice-laid deposits, chapter on, 41
 period, 45
 scratches on boulder, 42
 stream, alluviation by, 62
- Glaciation, extent of, in North America, map of, 46
 in Europe, map of, 48
- Glaciations, Illinoisan, 47
 Iowan, 48
 Jerseyan or Nebraskan, 46
 Kansan, 46
 Wisconsin, Early, 50
 Late, 50
- Glacier, Chenega, 41
 Columbia, front, 15
 over-riding forest, Alaska, 14
 defined, 16
 factor in weathering, 15
 incidental features, 50
 pressure of ice, 16
- Grand Cañon, Colorado River, 17
- Granite, 7
 exfoliated, California, 13
 wind-carved, 18
- Granulation, effect of drainage on, 222
 of organic matter on, 148
 of, on percolation, 218
- Grass, beach or Marram, transplanting, 56
 bunch, holds sand, 60
- Gravel and gravelly loams, 139
- Gravelly loams, 116
- Gravels, 116
- Gravitational water, chapter on, 217
- Gravity-laid soils, 30
- Great Basin region, 106
 Plains region, 100
- Green manures, 160
- Growth and germination, effect of drainage on, 223
 color of soils on, 303
 of plants, limit of alkali for, 284
 temperature for, 297
- Guide-row terrace, 365
- Gulf Coastal Plains, and Atlantic, 91
- Gullying, methods of prevention and filling, dams, 371
 soil, 374
 straw and brush, 370
 vegetation, 374
- Gypsum, 5
- Haberlandt, time required for germination at different temperatures, 297
- Hall, A. D., rainfall and evaporation, Rothamsted, 211
 table, rainfall, percolation, evaporation, Rothamsted, 220
 temperature of soil for growth, 298
 yield of wheat with percolation large and small, 153
- Hardness of minerals, 2
- Hardpan, 69
 effect of, in alkali lands, 290
- Harrows, acme or blade, 333
 disk, 334
 spike-tooth, 331
 spring-tooth, 332
- Hay and pasture province, rotation for, 386
- Heat, absorption and radiation of, effect on soil temperature, 302
 and cold, factor in disintegration, 12
 conduction downward into soil, source of loss, 296
 soil, sources of, 293
 specific, affecting soil temperature, 298
 effect of moisture on, 300
 of common substances, 299
 of soil constituents, 299
 of soils, 300
 to penetrate soil, time for, 306
- Heaving, due to lack of drainage, 225
 of alfalfa, 226
- "Heavy" soil, defined, 134
- Hellriegel, water transpired per pound of dry matter, 188
- Hematite, 5
- Hilgard, E. W., changes in organic matter, 146
 churn elutriator, 126
 composition of salts in alkali spot, 282
 of typical alkali salts, 280
 effect of various substances on hygroscopic capacity, 195

- Hilgard, E. W., fertility in Russian soils, 392
 force exerted by roots in penetrating soil, 19
 grades of soil particles, system of, 124
 highest amount of alkali with plants unaffected, 284
 hygroscopic capacity of soils, 194
 nitrogen content of humus, 191
 on use of hygroscopic moisture, 198
 roots and humus in Russian soils, 144
 vertical distribution of alkali, 281
- Hopkins, C. G., grades of particles, system of, 124
 production of sweet clover per acre, 173
- Humid and arid subsoils, 70
 regions, alkali of, 290
 soils, 75
 nitrogen in humus of, 147
- Humidity, affecting hygroscopic moisture, 196
- Humification, progress of, 146
- Hummocks, called bogs, 30
- Humus, defined, 142
 determination of, 156
 in Chernozem soils, 144
 nitrogen content of, 147
- Hydration, 21
- Hydrochloric acid, decomposition by, 20
- Hygroscopic capacity of soils, 194
 coefficient from other constants, formula, 197
 of soils, 196
 relation to wilting coefficient, 197
 moisture, affected by colloids, 195
 by humidity, 196
 by organic matter, 196
 by size of particles, 194
 by temperature, 195
 chapter on, 194
 use of, 197
- Ice-laid deposits, chapter on, 41
- Igneous rocks, 6
- Ignition, loss on, 154
- Implements of tillage, compacters, 335
- Implements of tillage, cultivators, 337
 harrows, 332
 listers, 332
 plows, 327
 seeders, 337
- Insects, controlled by rotation, 377
 mix soil, 315
- Interglacial stages, Aftonian, 46
 Peorian, 48
 Sangamon, 47
 Yarmouth, 46
- Internal area or surface, 181
- Intrusive rocks, 6
- Lowland glaciation, 48
 important loess deposit connected with, 62
- Irrigated land, crops for, alfalfa, 275
 cereals, 273
 forage crops, 275
 fruits, 275
 sugar beets, 275
 vegetables, 275
- Irrigation, chapter on, 257
 by overhead spray or sprinkling, 272
 canals lined with concrete, 258
 cultivation after, 273
 effect of, on rise of alkali, 281
 in humid climates, 275
 methods of, flooding, 270
 furrow, 271
 sprinkling or overhead sprays, 272
 sub-irrigation, 272
 potatoes by furrows, 271
 preparation of land for, 259
 projects in United States, 257
 in varied quantities, yield of dry matter, 264
 sources of, diversion of streams, 258
 pumping from streams or canals, 259
 reservoirs, 259
 subterranean supply, 259
 water, character of, 261
 time of, 263
- Illinois soil survey, 112
- Illinoian glaciation, 47
- Jardine, W. M., yield of milo maize, Texas, 253
- Jerseyan or Nebraskan glaciation, 46
- Johnson, S. W., carbon dioxide in soil air, 20

- Kames, formation of, 45
 Kansan glaciation, 46
 Karraker, substances in solution
 play little part in capillary move-
 ment, 205
 Keewatin center of accumulation, 45
 King, F. H., amount of soil carried,
 Mississippi River, 35
 aspirator, 128
 computed surfaces of soil par-
 ticles of different kinds of
 soil, 181
 depth of mulches, 235
 difference in temperature due to
 slope, 305
 effect of drainage on tempera-
 ture, 224
 effect of windbreak on evapora-
 tion, 301
 manure in surface causes rise
 of water into upper three feet,
 212
 movement of moisture from wet
 to dry soil slow, 203, 204
 rain caused rise of water from
 subsoil, 205
 sampling tube, 119
 spring discharge greater with
 falling barometer, 219
 water evaporated with water
 table at varied depths below
 surface, 210
 water used per pound of dry
 matter, 188
 weight of particles with film of
 water, 33
- Labradorean center of accumula-
 tion, 45
 Lacustrine soils, 37
 Lake Agassiz, 38
 beds, 37
 Chicago, 38
 level floor with distinct shore
 line, 37
 filling with peat, method of, 29
 Maunee, 38
 terraces and beaches, 37
 Lakes, ox-bow, 28
 Lands, alkali, 278
 value of, 290
 preparation of, for irrigation,
 259
 surface lowered through solu-
 tion of limestone, 24
- Lang, specific heat of soil consti-
 tuents, 299
 Lapham, J. E. and M. H., Bureau of
 Soils, soil survey, 78-111
 Latitude, affecting organic content
 of soils, 145
 or angle of sun's rays affecting
 soil temperature, 304
 Lawes and Gilbert, water trans-
 pired by growing plants per pound
 of dry matter, 188
 Leaching of manure, factor in loss
 of organic matter, 164
 of soil, organic matter lost by,
 152
 nitrates lost by, 322
 Legumes, composition of tops and
 roots, 398
 Level bench terrace, 366
 Leverett, F., connects loess with
 Iowan glaciation, 62
 depth of drift, Illinois, 42
 run-off for Illinois river basin,
 358
 Light, effect of, upon soil bacteria,
 321
 "Light" soil, defined, 134
 Liquid manure, value of, excreted
 by farm animals, 162
 Lime, 403
 and magnesia in soils, 75
 carbonate carried by Thames
 River, 23
 effect of, on number of bac-
 teria, 321
 on flocculation, 137
 forms of, air-slaked lime, lime-
 stone, marl, quicklime, 405
 in prairie compared with tim-
 ber soils, 75
 quick-, loss of organic matter
 due to use of, 152
 Limestone, 403
 addition of, aid in producing or-
 ganic matter, 158
 and rock phosphate, effect of, on
 growth of clover, 159
 application of, aid in preventing
 erosion, 361
 best form to apply, 406
 boulder with glacial scratches,
 42
 calcite, 5
 composed chiefly of shells, 9
 containing crinoid stems, 9

- Limestone, effect of carbonated water on, 22
 factor in maintaining organic content of soil, 145
 Valleys and Uplands province, 83
- Lister, work of, 331
- Lithological factor in classification of soils, 73
- Loams, 115
 clay, 115
 gravelly, 116
 peaty, 114
 sandy, 116
 fine, 116
 silt, 115
 stony, 116
- Locust, black, holds sand, 59
 growing on gullied land prevents erosion, 368
- Loess and dust, physical analyses, 64
 chemical analyses of, 65
 defined, 61
 deposit, connected with Iowan glaciation, 62
 deposits, 48
 formation of, 62
 "kindchen," lime concretions, 62
 occurrence of, 61
 origin of, 61
 texture uniform, 64
 ertical walls or cleavage, characteristic of deep, 63
- Loosening soil, an object of tillage, 325
- Loss by evaporation, effect of, on transpiration, 191
 of manure and its prevention, 163
 on ignition, 154
 compared with organic matter, 154
- Losses of organic matter, 151
- Loughridge, rise of water in clay, 206
- Lyon, T. L., and Fippin, E. O., surface tension and density of certain solutions, 206
- Lynde and Dupré, capillary pull, 211
 osmosis in soils, 212
- Lysimeters or drain gages, 220
- Macro-organisms, insects, 315
 plants, 316
 rodents, 315
 worms, 315
- Magnesia in prairie compared with timber soils, 75
 and lime in soils, 75
- Magnesium carbonate, dolomite, 5
- Magnetite, 6
- Maintaining and increasing organic matter in soils, chapter on, 158
- Major crops, defined, 376
- Mangrove marsh, Florida, 37
- Mangum terrace, 366, 367
- Manure, barnyard, 161
 conserved by use of absorbents, 165
 farmyard, influence of, on soil temperature, 294
 nitrogen content of, 399
 fresh, composition of, 163
 green, 160
 loss of, and its prevention, 163
 by fermentation, 164
 by leaching, 164
 organic matter, in rotting of, 163
 methods of applying, 168
 of handling, 165
 solid and liquid, value of, excreted by farm animals, 162
 spreader in action, 167
 steer, composition of, after exposure, 166
 value of increase due to, per ton, 168
- Marbut, C. F., and others, area residual soils in United States, mapped, 27
 Bureau of Soils, soil survey, 78
- Marine soils, 36
- Marl, 8
- Marram, or beach grass, transplanting, 56
- Marsh, marine, section of, 36
 mangrove, Florida, 37
- Marshes, early stages of formation, map, 36
 defined, 27
- Martin, F. O., and others, chromic acid method, 154
- Material in solution in streams, 24
- Maumee, Lake, 38
- Maximum water capacity of soils, 209
- McLane, with Briggs, moisture equivalent centrifuge, 202
- Meadows, hold soil against erosion, 361
- Measurement of irrigation water, 268

- Mechanical analysis, methods of, 124-128
 or physical analysis, 123
- Merrill, G. P., composition of feldspars, 3
 expansion of granite by hydration, 21
 glass ground by wind-borne sand, 19
 table, chemical analyses of loess, 65
 on loss of constituents of rocks, 25
 physical analysis of dust, 64
- Merrill, L. A., yield of wheat for different depths of plowing, 245
 methods of seeding, 254
- Metamorphic rocks, 10
- Methods of soil survey, 118
- Mica, black, biotite, 4
 white, muscovite, 4
- Micro-organisms, injurious, 317
 beneficial, 317
- Migratory sand dunes, 58
- Miller, M. F., plant food in Missouri soils, 392
- Mineral colloids, 132
 constituents of soils, chapter on, 123
 content of soils, 74
 phosphorus-bearing, apatite, 5
 soil constituents and their properties, 129
- Minerals, dissolved by carbonated water, 22
 hardness of, 2
 iron-bearing, hematite, magnetite, limonite, 5, 6
 soil forming, 1
 specific gravity of, 175
- Minor crops, 376
- Mississippi River, soil material delivered at mouth, 35
- Moisture, available, 214
 increased by drainage, 223
 capacity of soil, methods of increasing, compacting soil, 230
 deep rooting crops, 231
 organic matter, 231
 tillage, 230
 control of, chapter on, 222
 by tillage, chapter on, 230
 content, ways of expressing, 191
- Moisture content, ways of expressing, acre-inches, 192
 cubic inches, or per cent of volume, 192
 per cent of weight of soil, 191
 decreasing, losses from soils, 232
 effect of, on specific heat, 300
 equivalent, defined, 202
 determination of, from other constants, formula for, 203
 equivalents of some soil classes, 202
 excess of, removed by tillage, 231
 factor in amount of organic matter in soils, 143
 soil classification, 73
 for bacteria, 319
 -holding capacity of soils, 209
 hygroscopic, chapter on, 194
 in soil columns, 201
 retained by organic matter, 149
 storing and conserving by tillage, 326
 supply in soils, 189
- Moraine, terminal, 43
- Morrow, G. W., results of root pruning in shallow and deep cultivation of corn, 355
- Moss, sphagnum, 28
- Mucks, 114
 specific heat of, 300
- Mud flow, Colorado, 34
- Müller, Richard, solution of minerals, 22
- Mulch, defined, 233
 depth of, 235
 fineness of, 234
 maintenance of, 236
 soil effectiveness of, 235
 value of, for corn, humid regions, 350
- Mulches, permit little loss of water by interstitial evaporation, 233
- Muscovite, white mica, 4
- Nebraskan glaciation, or Jerseyan, 46
- Nelson, J. B., with Atkinson, storing rainfall, Montana, 248
- Newell, Dr. F. H., directed large irrigation projects, 258
- Nitrates lost from soil by leaching, 322
 by denitrification, 323

- Nitrate production, effect of potassium carbonate upon, 321
- Nitric acid, amount brought to earth, Rothamsted, 20
decomposition by, 20
- Nitrification, 317
increased by drainage, 225
loss of organic matter by, 152
temperature for, 298
- Nitrogen, 393
commercial forms of, ammonium sulphate, 399
calcium cyanamid, 400
organic substances, 400
sodium nitrate, 399
content of humus, 147
fixation, 317
furnished to crops by organic matter, 151
in fertilizing materials, 405
in humus from different materials, 147
lost by erosion, 360
- Non-tilled crops, factor in maintaining organic matter, 171
- Northwestern International Region, 105
- Number of particles, 178
- Oats production, 1909, 414
seed bed for, 349
- Objects of a soil survey, 117
- Oblique arrangement of particles, 180
- Odor of soils, 177
- Optimum water content, defined, 212
- Organic colloids, 132
constituents of soils, chapter on, 142
matter, addition of, as sweet clover, 172
affecting capillary movement, 206-208
hygroscopic moisture, 196
and fertility, loss of, in rotting of manure, 163
and nitrogen, lost by erosion, 360
changes of, 145
comparison, chromic acid and combustion methods, 155
defined, 142
distribution of, in soil strata, 147
effect of, on percolation, 218
on shrinkage, 130, 135
in sweet clover, 173
- Organic matter increased by plowing under legumes, 172
increases moisture - holding capacity, 231
increasing amount of, aid in checking erosion, 363
in soils, amount of, depends on altitude, 145
on latitude, 145
on limestone, 145
on moisture, 143
on vegetation, 144
kinds of, active, coal-like, inert, 142
loss on ignition compared with, 154
losses of, by cropping, 151
by erosion, 151
by fallowing, 153
by fires, 152
by leaching, 152
by quicklime, 152
methods of estimation of, 153
chromic acid method, 154
combustion in oxygen, 154
loss on ignition, 154
maintaining, accumulations in pastures, 160
barnyard manures, 161
catch and cover crops, 161
green manures, 160
limestone, addition of, 158
non-tilled crops, growing of, 171
organic residues, use of, 170
phosphorus, application of, 159
rotation of crops, 171
of soils, maintaining and increasing, chapter on, 158
turning under and incorporating with soil, object of tillage, 325
residues, 170
substances lower surface tension, 205
source of nitrogen, 400
- Organisms, soil, chapter on, 315
beneficial, 317
injurious, as plant diseases, 317
- Origin of alkali, 278
of soil material, 1

- Osborne, grades of particles, 124
 Osmosis, temperature for, 298
 Osmotic pressure, sugar solution, 131
 Ox-bow lakes, 28
 Oxidation, 20
 expansion caused by, 21
 loss of organic matter by, 152
 Oxygen, combustion in, determination of organic matter, 154
- Packing, subsurface in dry farming, 247
- Pacific Coast Region, 107
- Particles, colloid, size of, 130
 soil, and their separation, 123
 arrangement of, 179
 number of, 178
 shape of, 178
 size of, affecting hygroscopic moisture, 194
- Pastures, accumulations in, aid in maintaining organic-matter content, 160
 hold soil against erosion, 361
- Patten, H. E., specific heat of soils, 300
 effect of moisture on specific heat, 300
- Pearce, J. R., size of particles, 124
 chromic acid method, 154
- Peat, filling lake, 29
 method of formation, 28
- Peats, 114
- Peaty loams, 114
- Peorian interglacial stage, 48
- Percolation, affected by atmospheric pressure, 219
 by granulation, 218
 by organic matter, 218
 by physical composition of soil, 217
 by roots of plants, 219
 by shrinkage cracks, 219
 by viscosity of water, 219
 defined, 217
 evaporation, rainfall, Rothamsted, 220
 large and small, effect of, on yield of wheat, 153
 loss of, by water, in dry farming, 242
 source of loss of water, 232
- Pfeffer, osmotic pressure, sugar solution, 131
- Phosphate, rock, and limestone, effect on growth of clover, 159
 on wheat, 401
- Phosphorus, application of, aid in producing organic matter, 159
 forms of, acid phosphate, 402
 basic slag, 402
 bone meal, 400
 compared, 402
 rock phosphate, 400
 in fertilizing materials, 405
- Physical agencies of weathering, 12
 analyses of loess and dust, 64
 analysis, methods of, 124
 aspirator, King's, 128
 centrifugal, Bureau of Soils, 127
 elutriator, Yoder's, 128
 churn elutriator, Hilgard's, 126
 elutriator, Schöne, 124
 sieve, 124
 subsidence, 124
 systems of, 124
 changes, source of soil heat, 294
 character of soil changed by erosion, 360
 of water, 186
 composition of soil in relation to bacteria, 321
 affecting percolation, 217
 of soils, varied, effect of, on porosity, 184
 condition of soil, effect of alkali on, 280
 or mechanical analysis, 123
 properties of soils, chapter on, 175
 apparent specific gravity, 175
 arrangement of particles, 179
 color, 176
 internal area or surface, 181
 odor, 177
 number of particles, 178
 porosity, 182
 real specific gravity, 175
 shape of particles, 178
 weight, 176
- Pines growing on sand, 60
- Placing of soil material, chapter on, 27

- Plant diseases controlled by rotation, 377
 food, crop requirements, 390
 elements of, 390
 in crops, 390
 in Illinois soils, surface, 394
 subsoil, 396
 subsurface, 395
 in Missouri soils, 392
 in residual soils, 392
 in Russian soils, 392
 locked up in mulches, 236
 supply in soils, 391
- Planting seed accompanied by some tillage, 326
- Plants, amount of water required by, 187
 disintegration by, 19
 effect of alkali on, 282
 on rocks, 24
 remains benefit soil, 316
 water requirements, 241
- Plasticity of clays, 135
- Plow, an early form of, 340
 pan or sole, 70
 theoretical action of, 327
- Plowing, 340
 deep, and turning under alkali, 286
 contour, aid in checking erosion, 364
 tilling, 345
 depth of, 344
 fall, desirable in dry farming, 246
 good, essentials of, 341
 sod well turned, 341
 poor, crooked furrow, 342
 subsoiling, 345
 time of, 342
 fall, 343
 spring, 344
 yields of wheat for different depths of, in dry farming, 245
- Plows, deep tilling double disk, 331
 disk, 329
 general purpose, 328
 lister, 332
 sod, 329
 stubble, 328
 subsoil, 332
- Plutonic rocks, 6
- Pore space, amount of in soils, 180
- Porosity, different grades of sand, 183
 of soils, 182
- Porosity of soils, of varied physical composition, 184
- Potassium, 403
 effect of, on corn on swamp land, 404
 in fertilizing materials, 405
- Potatoes, on dry farm, 253
- Pott, H. E., relative conductivity of soil material, 306
- Prairie areas of United States, 76
 soils, 76
- Precipitates, chemical, 8
- Precipitation, map of United States, 190
 on earth's surface, 189
 source of soil heat, 294
- Preparation of seed bed, 345
- Press drill, 337
- Pressure, atmospheric, changes in, factor in aëration, 311
 of waves, 18
- Prestwich, lime carbonate carried by Thames River, 23
- Prevention of loss of manure, 163
- Properties, physical, of soils, chapter on, 175
- Puddling of clays, 136
 prevented by organic matter, 150
- Pulverizing and loosening soil, an object of tillage, 325
- Pumping water for irrigation, 259
- Pyroxene, 3
- Quaking bog, 28
- Quartz, 2
- Radiation, factor in loss of soil heat, 295
 from sun, source of soil heat, 293
 of heat, effect of, on soil temperature, 302
 ratio, different colored soils, 295
- Rainfall, affecting transpiration, 189
 and evaporation from free-water surface, 241
 Rothamsted, 211
 and snow, precipitation on earth's surface, 189
 character of, effect on erosion, 359
 factor in value of region for dry farming, 238
 map of United States, 190
 percolation, evaporation, Rothamsted, 220

- Rainfall, storing of, in dry farming, 247
 types of, over dry-land area of United States, 239
- Reaction, alkaline, of soil desirable for bacteria, 320
- Reade, rate of lowering of land surface by solution, 24
- Real or absolute specific gravity, 175
- Reclamation of alkali lands, chapter on, 278
- Redding, R. J., depth of plowing for cotton on eroded land, 364
- Reforestation stops erosion, 369
- Reservoirs, storing water for irrigation, 259
- Residual soils, 27
- Residues, organic, 170
 return of, aid in preventing erosion, 363
- Resurrected forest, 55
- Rhyolite, 7
- River Flood Plains province, 97
 sediments, composition of, 262
 swamps, 28
 water, suspended matter in, 262
- Rock disintegration and talus slope, 32
 outerop, 116
 phosphate, 400
 split by tree, 19
 weathering of jointed, 31
- Rocks, 6
 aqueous, 7
 decomposition and disintegration of, 11
 eruptive, 6
 expansion of, on heating, 13
 igneous, 6
 intrusive, 6
 loss of constituents through decomposition, 22
 metamorphic, 10
 plutonic, 6
 volcanic, 6
 weathering of, chapter on, 11
- Rocky Mountain and Plateau Region, 104
- Rodents, mix surface and subsoil, 315
- Rogers Brothers, dissolved minerals in carbonated water, 22
- Rollers, 335 to 337
- Roosevelt dam, 260
- Root injury, 353
 pruning of corn, results, 355
- Root systems, depth of, varied in rotations, 378
- Roots and tops, legumes, composition of, 398
 force exerted by, 19
 in Chernozem soils, 144
 of plants aid percolation, 220
 tree prying rock apart, 19
- Rotation, chapter on, 376
 advantages of, better distribution of work, 377
 control of insects and plant diseases, 377
 of weeds, 377
 compared with continuous corn, Iowa, 379
 effect of, on crop yields, Illinois, Ohio, Minnesota, 379, 380
 for corn and winter wheat belt, 382
 cotton belt, 384
 spring wheat belt, 386
 helps maintain good tilth, 378
 organic matter, 378
 produces larger yields, 378
 renders toxic substances less harmful, 378
 variation in depth of root systems, 378
 of crops, aid in maintaining organic matter, 171
 place for crops in, 381
 planning of, 380
- Rotmistrov, weeds enemy of culture, friends of drought, 244
 water not raised far by capillarity at Odessa, 210
- Run-off, cause of loss in dry farming, 242
- Russell, origin of adobe, 65
- Sage brush on land well adapted to dry farming, 239
- Salts, soluble, in soils, 74
- Sampling of soils, 120
 tube, King's, 119
- Sand dune, burying forest, 55
 wind ripples on, 56
 dunes, migratory or wandering, 54, 58
 permanent or fixed, 54, 55
 held by, black locusts, 59
 bunch grass, 60
 partridge pea, 59
 pines, 60
 sensitive plant, 59

- Sand dunes, held by trailing wild
bean, 60
vegetation, 57
movement checked by fences, 58
porosity of different grades, 183
- Sands, 116
and sandy loams, properties
of, 139
radiation ratio of different
colors of, 295
temperature of, effect of color
on, 302
- Sandstones, 8
- Sandy loams, 116
- Sangamon interglacial stage, 47
soil, 49
- Schlösing, relation, nitrates formed
to oxygen, 320
- Schöne's elutriator method, physical
analysis, 124
- Schreiner, O., and Brown, E. E.,
progress of humification, 146
- Sedentary formations, 27
- Sediment carried in suspension by
rivers, 35
- Sedimental soils, 33
classes of, 36
- Sedimentary, fragmental, 8
- Seed, acclimated, necessary in dry
farming, 255
bed, preparation of, for corn,
348
for oats, 349
for wheat, 346
- Seeders, 337
- Seeding, different methods of, yield
wheat on dry land, 254
on dry land, 254
rate per acre, Colorado, 255
- Shaler, wave action, Cape Ann,
Massachusetts, 18
- Shales, 8
- Shantz, H. L., see Briggs
- Shape of particles, 178
- Shrinkage, affected by colloids, 132
cracks, 136
effect of, on percolation, 219
physical composition of,
135
of soils, 135
different types of soil, 133
- Sieve method, physical analysis, 124
- Silica, 2
- Silt and silt loams, properties of,
138
dunes, 53
- Silt loams, 115
- Sink holes, 22
in cave region, 24
ponds, produced when outlet
is clogged, 24
- Size of soil particles, effect of, on
capillarity, 201
- Slope of land, effect of, on soil tem-
peratures, 305
- Snyder, loss of organic matter in
forest fires, 152
nitrogen in humus from vari-
ous materials, 147
- Sodium nitrate, 399
- Soil—soils
air and aëration, chapter on,
309
carbon dioxide in, 20
composition of, 310
alluvial, 38
amount of air in, 309
of organic matter in, 142
and subsoil, chapter on, 67
are they inexhaustible? 289
arid, 74
auger, 119
Bureau of, classification, chap-
ter on, 78
carried in suspension by rivers,
35
capillary or moisture-holding
capacity of, 209
pull of, 211
character of, factor in its adapt-
ability to dry farming, 241
Chernozem, roots and humus in,
144
class, defined, 79
classes in Illinois, 112
clay loams, 115
clays, 114
gravels, 116
gravelly loams, 116
loams, 115
mucks, 114
peats, 116
peaty loams, 116
sands, 116
sandy loams, 116
fine, 116
silt loams, 115
classification of, chapter on, 72
colloids in, 132
colluvial, 30
color of, 176
effect on time of germination,
304

- Soils, compacted by tillage, 326
 conductivity of, effect on temperature, 305
 constituents, capillary lift of, 212
 specific heat of, 299
 cumulose, 27
 deep, medium-grained, well adapted to dry farming, 243
 definition of, 1
 effect of alkali on physical condition of, 280
 of color of, on growth, 303
 on transpiration, 191
 eöüal, 53
 erosion, chapter on, 358
 fertility, appendix 1, 389
 -forming minerals, 1
 glacial, 41
 gravelly, not well adapted to dry farming, 240
 gravity-laid, 30
 gullies filled with, 374
 heat, loss of, by conduction downward into soil, 296
 by convection currents of air, 296
 by evaporation of water, 296
 by radiation, 295
 sources of, 293
 chemical changes, 294
 physical changes, 294
 precipitation, 294
 radiation, direct from sun, 293
 "heavy," "light," defined, 134
 humid, 75
 hygroscopic capacity of, 194
 coefficient of, 196
 Illinois, fertility in, 394
 Kentucky, 393
 lacustrine, 37
 lime and magnesia in, 75
 marine deposits, 36
 material and its origin, chapter on, 1
 placing of, 27
 relative conductivity of, 306
 methods of increasing moisture capacity of, 230
 mineral constituents of, chapter on, 123
 content of, 74
 Missouri, 392
 mulch, defined, 233
 mulches, effectiveness of, 235
- Soils, odor of, 177
 organic constituents of, chapter on, 142
 organisms, chapter on, 315
 particles and their separation, 123
 held together by organic matter, 151
 surfaces of, in different soils, 181
 physical character of, changed by erosion, 360
 properties of, chapter on, 175
 plant food, supply in, 391
 porosity of, 182-184
 prairie, 75
 provinces, area surveyed to 1915, 78
 regions, area surveyed to 1915, 78
 residual, 27
 plant food in, 392
 running together hinders aëration, 313
 samplers, 119
 sampling of, 120
 Sangamon, 49
 sedimental, 33
 classes of, 36
 series, Bureau of Soils, 79-111
 shrinkage of, 133, 135
 soluble salts in, 74
 specific heat of, 300
 strata, distribution of organic matter in, 147
 thickness of, 120
 weight of, 120
 stream-laid, 38
 subsurface, 67
 surface, 67
 survey by Bureau of Soils, chapter on, 78
 by Illinois Experiment Station, chapter on, 112
 methods of, 118
 objects of, 117
 surveys, 116
 temperature, chapter on, 293
 conditions affecting, 298
 absorption and radiation, 302
 color, 303
 conductivity, 306
 drainage, 301
 evaporation, 300

- Soils, temperature, conditions affecting, latitude or angle of sun's rays, 304
 slope, 304
 specific heat, 298
 tillage, 307
 water, presence of, 302
 for growth, 298
 for vital functions of plants, germination, 296
 growth, 297, 298
 nitrification, 298
 osmosis and diffusion, 298
 influenced by liquid water, 295
 by manure, 294
 raised by absorption of water vapor, 294
 ten-year average, 307
 texture and structure of, effect on erosion, 358
 timber, 76
 time for heat to penetrate, 306
 top, 67
 type, defined, 79
 types, classes and phases in Illinois, 114
 defined, Illinois, 112
 internal area of, 182
 naming of, 113
 ventilation, see aeration, 311
 water of, 186-222
 water-laid, 33
 water-logged, 313
 weight of, 176
- Sole, plow, 70
- Solid manure, value of, excreted by farm animals, 162
- Solution, decomposition by, 22
- Specific heat of water, 187
 gravity, apparent, 175
 of soil-forming minerals, 175
 real or absolute, 175
- Sphagnum moss, 27, 28
- Spring plowing, 344
 wheat, acreage, 1909, 415
 region, rotation for, 386
- Stability of soil increased by drainage, 222
- Stalactites, stalagmites, in cavern, 23
- Stones, 139
- Stony loams, 116
- Storm, dust, 54
- Straw, used in filling gullies, 370
- Streams, diversion of, for irrigation, 258
 erosion of, 16
 -laid soils, 38
 material carried and rolled by, 16
 work of, affected by velocity of current, 16
- Striae, glacial, on rock surface, 43
- Structure of soil, effect on erosion, 358
- Sub-provinces, classes, types, surveys, chapter on, 112
- Subsidence method, physical analysis, 124
- Subsoil, 68
 plow, 330
 soil and, chapter on, 67
- Subsoiling, 345
- Subsoils, arid and humid compared, 70
- Substances in solution, effect on viscosity, 205
- Subsurface packing, 247
 soil, 67
- Sugar beets, returns from thirty inches of water, 266
- Sulfuric acid, decomposition by, 20
- Surface, internal, 181
 soil, 67
 tension, affecting capillarity, 199
 and density of solutions, 206
- Survey, soil, by Bureau of Soils, chapter on, 78
 by Illinois Experiment Station, chapter on, 112
 methods of, 118
 objects of, 117
- Surveys, soil, 116
 in different states, 117
- Swamp, ablation, 30
 land, typical Eastern, 29
 wet woods, 30
- Swamps, defined, 27
 river, 28
- Sweet clover on badly eroded land, 361
 plowed under, 172
 quantity grown per acre, 173
- Syenite, 7
- Systems of physical analysis, 124
- Talus, 30
 slope, 32
- Temperature, chapter on, 293

- Temperature, affecting hygroscopic moisture, 195
viscosity, 204
changes, factor in aëration, 312
climate, factor in soil classification, 73
effect of, on capillary rise of water, 204
for bacterial development, 320
germination, 296
table of, 297
growth, 297
nitrication, 298
osmosis and diffusion, 298
of plowed and unplowed land, 312
sands, effect of color on, 302
soil, conditions affecting, 298
influenced by manure, 294
raised by drainage, 224
by organic matter, 150
soil, ten-year average, 307
time required for radicle to appear at different, 297
- Tenacity of soils, 134
- Terminal moraine, formation of, 45
topography of, 134
- Terrace, glacial lake and river province, 89
near Rockford, Illinois, 38
- Terraced park, Mississippi, 367
- Terraces in China, 364
kinds of, guide-row, 365
level beach, 366
Mangum, 366, 367
method of formation, 39
of Frazier River, 38
- Texture of soil, affecting capillary movement, 206
percolation, 217
effect of, on erosion, 358
factor in soil classification, 77
in relation to bacteria, 321
- Thawing and freezing, 14
- Thickness of film affecting capillary movement, 203
- Thorne, C. E., composition of steer manure after three months' exposure, 166
- Thysell, J. C., summer tillage with alternate cropping *vs.* continuous cropping, 250
- Tight clay, 68
- Tile drainage, effect of, on topography of water table, 228
- Tile drains, 228
- Tiling, aid in checking erosion, 369
- Tillage, chapter on, 325
control of moisture by, 230
deep, in dry farming, 245
effect of, on soil temperature, 307
factor in aëration, 313
increases moisture capacity, 230
objects of, compacting soil, 326
killing weeds, 326
planting seed, 326
pulverizing and loosening soil, 325
storing and conserving moisture, 326
turning under vegetable matter, 325
removal of excess of moisture by, 231
summer, in dry farming, 246
with alternate cropping, compared with continuous cropping yields, 250
- Tilling, deep, 345
- Tilth, rotation helps maintain, 378
- Timber areas of United States, 76
soils, 76
- Time for germination affected by color of soil, 304
at different temperatures, 297
- Top soil, 67
- Topography, effect of, on erosion, 358
- Toxic substances less harmful in rotations, 378
- Trachyte, 7
- Transpiration, dependent upon evaporation, 191
soil, 191
supply of moisture, 189
from plants, large loss of water, 232
of water per pound, dry matter produced, 188
source of loss in dry farming, 244
- Transported formations, 30
- Tull, Jethro, "tillage is manure," 325
- Type, soil, defined, 79
Illinois, defined, 112
- Udden, J. A., estimate, dust carried in air, 53
- Uloth, plants germinated on ice, 296

- Value of increase for manure per
crop and ton, 168
organic matter to soils, 148
binds soil particles to-
gether, 151
biological effects, 150
erosion, loss by, pre-
vented, 150
furnishes nitrogen, 151
granulation affected, 148
moisture retained, 149
puddling prevented, 150
temperature raised, 150
- Van Slyke, L. L., per cent of liquid
and solid excrement, 162
composition of fresh manure,
163
- Vegetation, aid in filling gullies, 374
factor in soil classification, 75
source of soil organic matter,
144
- Vegetative covering, effect on ero-
sion, 359
- Velocity of current, effect of, on
size of material carried,
33
on work of streams, 16
- Ventilation of soils, 311
- Vertical cleavage or wall, character-
istic of deep loess, 63
- Viscosity of water, 187
affecting capillary movement,
204
effect of, on percolation, 219
- Volcanic dust, 6
rocks, 6
- Wandering sand dunes, 54, 58
- Water, amount of, to apply in irri-
gation, 363
required by plants, 187
at different heights above water
table, drained, 217
available, 213, 214
capacity of soils, maximum, 209
capillary rise of, affected by
temperature, 204
in glass tubes, 199
use of, 212
comparison between computed
and observed flow of, 129
draining from eight feet of satu-
rated sand, 221
duty of, 267, 268
- Water evaporated daily per square
foot of soil, 210
evaporation of, effect on soil
temperature, 296, 300
for irrigation, character of, 261
gravitational, chapter on, 217
height and rapidity of capillary
rise in different soils, 207
in soil in one-foot strata to 8
feet deep, 248
irrigation in varied quantities,
yield of dry matter, 264
-laid soils, 33
liquid, effect on soil tempera-
ture, 295
-logged soil prevents aëration,
313
loss of, by interstitial evapora-
tion, slight, 233
from canals, 266
in dry farming by evapora-
tion, 243
by percolation, 242
by run-off, 242
by transpiration, 244
methods of preventing, 244
deep tillage, 245
fall plowing, 246
storing rainfall, 247
subsurface packing, 247
summer tillage, 246
material carried by, 33
measurement and distribution
of, in irrigation, 268
moved by capillarity, amount
of, 210
of soils, chapter on, 186
capillary, chapter on, 199
physical characteristics, 186
presence of, effect on soil tem-
perature, 302
producing power of, in varied
application, 265
removal of excess of, 222
factor in aëration, 311
required for corn, Utah, 242
to produce one pound dry
matter, 242
requirement of plants, 241
river, suspended matter in, 262
table, topography of, in tiled
land, 228
transpired, for one part of dry
matter produced, 188
uses of, enumerated, 187

- Water vapor, increase in temperature by absorption of, 294
viscosity of, 187
- Waves, disintegration by, pressure of, 18
- Weathering, advanced, 12
chemical agencies of, 19
of rock, irregular due to joints and stratification, 11
jointed, 31
of rocks, chapter on, 11
physical agencies, 12
- Weeder, 340
- Weeds, controlled by rotation, 378
killing of, object of tillage, 326
- Weight of soil, 176
strata, 120
- Wheat belt, winter, rotations for, 382
effect of rock phosphate on, 401
methods of preparing land for, 347
Minidoka project, Idaho, 261
production, United States, 1909, 417
seed bed for, 346
yield, different methods of seeding, 254
of under varied percolation, 153
ten-year average, 409
without irrigation, Montana, 249
yields for different depths of plowing, 245
- Widtsoe, J. A., dry matter per acre from varied amounts of irrigation water, 264
precipitation on earth's surface, 189
- Water, producing power of 30 acre-inches of water applied to varied areas, 265, 266
rainfall and evaporation from free-water surface, 241
suspended matter in river waters, 262
water in one-foot strata to eight feet, 248
- Weir, rectangular, for measuring irrigation water, 268
trapezoidal or Cippoletti, 269
- Wild bean, trailing, holds sand, 60
- Wiley, H. W., odor of soils, 177
- Wilting coefficient, defined, 212
from other constants, formula, 213
of soils for different plants, 213
relation of hygroscopic coefficient to, 197
- Wind-carved granite, 18
disintegration by, 18
movement, factor in aëration, 313
ripples on sand, 56
- Winter wheat acreage, 1909, 416
- Wisconsin glaciations, 50
- Wolny, difference in temperature due to slope, 304
water transpired per pound of dry matter, 188
- Woods, swamp, wet, 30
- Work, better distributed by rotation, 377
- Yarmouth interglacial stage, 46
- Yields increased by rotations, 378
- Yoder, P. A., centrifugal elutriator, 128
- Zeolites, 4

75

UNIVERSITY of CALIFORNIA
AT
LOS ANGELES
LIBRARY

SCOTTISH RECORDS BOARD



A 001 096 049 0

