

1960-Dec.

1423

Report No. 1423

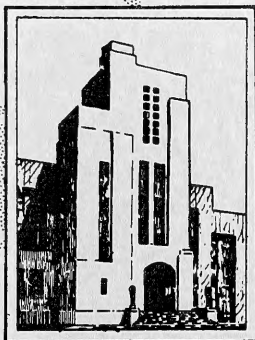

DEPARTMENT OF THE NAVY  
 DAVID TAYLOR MODEL BASIN

"SPLASHNIK"

THE DAVID TAYLOR MODEL BASIN

DISPOSABLE WAVE BUOY

by

Wilbur Marks and Robert G. Tuckerman

HYDROMECHANICS

○

AERODYNAMICS

○

STRUCTURAL  
MECHANICS

○

APPLIED  
MATHEMATICS

HYDROMECHANICS LABORATORY

RESEARCH AND DEVELOPMENT REPORT

December 1960

Report 1423

GC  
 1  
 .D3  
 no. 1423

RECEIVED

1961 MAR 20 AM 11:02

ONR, BOSTON

FILE NO. - \_\_\_\_\_

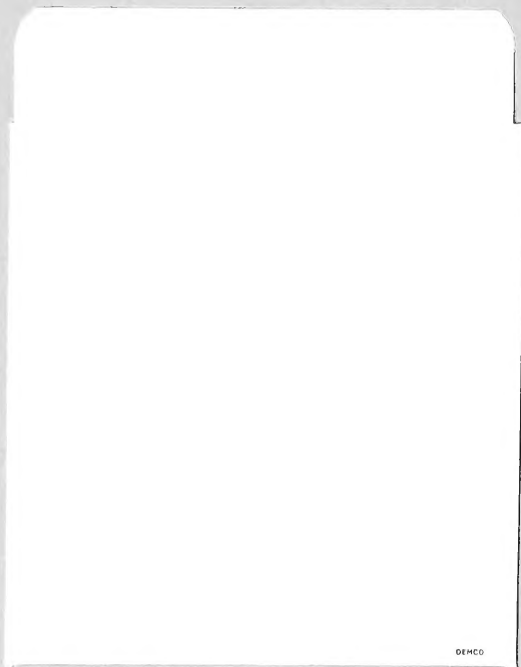

GENCO

MBL/WHOI



0 0301 0037244 7

"SPLASHNIK"  
THE DAVID TAYLOR MODEL BASIN  
DISPOSABLE WAVE BUOY

by  
Wilbur Marks and Robert G. Tuckerman

Presented at the VIIth Conference on Coastal Engineering,  
sponsored by the Council on Wave Research  
The Hague, Netherlands  
August 1960

December 1960

Report 1423

## TABLE OF CONTENTS

	Page
ABSTRACT.....	1
INTRODUCTION.....	2
OPERATING PRINCIPLES.....	3
DETAILED DESCRIPTION OF COMPONENTS.....	4
BUOY ASSEMBLY.....	4
ACCELEROMETER.....	5
TRANSMITTER.....	5
BATTERY PACK.....	6
RECEIVING ANTENNA.....	6
RECEIVER.....	7
LOW-PASS FILTER.....	7
RECORDING.....	7
SOME REMARKS ON THE ACCELERATION RECORD.....	8
CALCULATION OF THE WAVE SPECTRUM.....	9
EXPERIMENTAL VERIFICATION.....	11
PROPOSED IMPROVEMENTS.....	14
REFERENCES.....	16

## ABSTRACT

A disposable telemetering wave buoy is described. Its operating principles, based on measurement of the apparent vertical acceleration of surface water particles, are discussed. The method of reduction of acceleration records to wave height spectra is given. Experiments made in the model tank and at sea, for the purpose of comparing the SPLASHNIK with fairly reliable systems of wave measurement, are described in detail. The results are shown to indicate good agreement between the measurements of the SPLASHNIK and two other instruments. The SPLASHNIK is judged to be acceptable as a wave measurement device, within the scope of its intended use. Future plans for refining the system's accuracy and extending its potential to measurement of other variables are discussed.

## INTRODUCTION

In connection with full-scale ship trials, it is often necessary to have a description of the state of the sea which may be used as a scale against which to measure ship performance. Visual observations of waves have proven to be unreliable in the past and are, in any event, not sufficiently detailed to be adequately descriptive, for many problems. Hindcasting\* the state of the sea depends on wind information (speed, duration, area of sea covered, and rate of growth and/or decay) obtained from weather maps covering a six-hour period. The wind data is used in conjunction with certain empirical-theoretical formulations to produce an energy spectrum of waves at the place and time of interest. The energy spectrum is a good descriptive tool, because it gives information on the

---

\*Hindcasting is the prediction of an event after it has occurred but has not been observed.

energy content of the wave frequencies present and provides an estimate of the height distribution of the waves as well as certain other statistical quantities. However, hindcasting the wave spectrum is unsatisfactory for two reasons: 1) Estimation of the wind field from sparse observations spaced six hours apart is highly subjective; and 2) No specific energy spectrum formulation has as yet been verified.

There is still another method for description of the seaway. If the waves at a fixed point can be measured for a sufficient length of time, then this sample record can be converted into a wave (energy) spectrum that will adequately characterize the state of the sea.

There are many systems that will measure waves, but the requirement that wave measurements complement simultaneous ship motion measurements in all states of sea eliminates most of the known instruments. In particular, it is required that the waves be observed at a fixed point for a period of hours, while the ship conducts certain maneuvers which may remove it several miles from the point of observation. This means that the wave measurement system must be physically divorced from the ship.\* Furthermore, many tests will be made in heavy seas, so that it will not be practical to seek out the instrument and recover it. As a consequence of the conditions imposed by the particular problem stated here, the wave measuring system must be able to:

1. Telemeter information to the ship for at least 7 hours at a distance of at least 8 nautical miles;
2. Be launched from the deck of a ship in waves perhaps 25 feet high; and
3. Be inexpensively constructed (\$125.00 - \$150.00) so as to be expendable.

---

\*The wave measurement system may be integral with the ship if measurements are made at zero forward speed.

Since investigation revealed that no known instrument had embodied in it all three of these features, it was decided to design and build an appropriate system at the David Taylor Model Basin. After some consideration of the imposed conditions, it was decided that a small floating buoy (SPLASHNIK) which measures apparent vertical acceleration and telemeters the information back to the ship could be designed to fulfill the requirements.

The intent of this paper is to describe the SPLASHNIK system, the data reduction method, some experimental verification of the method, and some proposed improvements. It should be noted that this technique of wave measurement (recording of vertical acceleration) is not new. In fact, one instrument described by Dorrestein<sup>1</sup> is somewhat similar to the SPLASHNIK and has been in operation for several years. Other institutions are also known to be experimenting with accelerometer wave buoys. However, several basic design differences make the SPLASHNIK especially useful as a tool in the study of ship behavior. A drawing of the SPLASHNIK appears in Figure 1.

#### OPERATING PRINCIPLES

The general operation of the complete system of sensing and recording is shown in Figure 2. An accelerometer consisting of a mass and a flexible arm is attached to the base of the float unit. Part of the mass is an eddy current damper attached near the outer end of the accelerometer arm. As the float moves up and down on the waves, the displacement of the mass in reference to the base causes a radio transmitter to change frequency. The change in frequency is proportional to the acceleration being experienced by the buoy. The output of the transmitter is fed to an antenna mounted on the wave-height buoy float. The signal transmitted

---

<sup>1</sup>References are listed on page 16

from the wave-height buoy is received at the ship with a wide band receiver which converts the frequency changes of the transmitter into a varying d-c voltage. The varying d-c voltage is proportional to the acceleration being sensed by the accelerometer. The received signal contains high-frequency components which are caused by the very short waves (which contribute little to the ship motions being studied) as well as by mechanical noise of the transmitter unit. These signals are of such a magnitude that if they were allowed to appear on the recording, they would completely mask the desired signal. That is, the gain of the recording system would have to be set so low that the desired signal (associated with frequencies below  $1/3$  cps) would be too small to read accurately. For this reason, the output of the receiver is applied to a low-pass filter which removes the undesirable high frequencies but allows the desired information to pass through unaltered, except for some phase distortion which is not considered significant for the intended application. The output of the filter is then recorded by whatever means are available, i.e., tape recorder, direct writing recorder, etc.

Calibration of the system is accomplished by establishing a zero reference with the wave-height buoy level and then tilting the buoy through 60-degrees. The tilt will produce a frequency change in the transmitter which represents the  $1/2$ -g change which the accelerometer senses due to the 60 degree tilt. When the signal is received, the receiver will produce a steady d-c voltage output proportional to the transmitter change in frequency and therefore proportional to acceleration. This d-c voltage and the zero obtained when the buoy is level are recorded. The difference between the zero and the voltage produced due to the 60-degree tilt is the calibration for  $1/2$ -g, and all records from that particular wave-height buoy may be referred to this calibration.

#### DETAILED DESCRIPTION OF COMPONENTS

##### BUOY ASSEMBLY

The buoy assembly of the SPLASHNIK is composed of a buoyancy unit



(float), an equipment box, and an antenna. The buoyancy unit is made of styrofoam covered with fiberglass cloth impregnated with epoxy resin to give it strength. The float is 3 feet by 3 feet by 3 inches with a 1-foot by 1-foot hole through the center. (See Figure 1.) The equipment box is mounted through the hole and held fast to the float by sheet aluminum angles. Two eyebolts are mounted through the float to be used when it is necessary to lower the assembly over the side of a ship into the water.

The equipment box is made of plywood and is coated inside and out with epoxy resin to assure its watertightness for the period of operation. The top of the box is held in place with machine screws and has a rubber gasket between it and the lip of the box to make a watertight closure. The antenna mast is mounted through the top of the box. A ground plane antenna, cut to operating frequency, is mounted on the top of the mast with its feed line running down through the mast into the box. The transmitter unit is attached to one side of the box and the batteries that provide its power are located in the bottom of the box (Figure 3). A bar switch is located on the outside of the box and is used to turn on the equipment.

#### ACCELEROMETER

The accelerometer is composed of a beryllium copper cantilever arm mounted on a pedestal. The pedestal is attached to the transmitter unit chassis (Figure 4). An aluminum cup is mounted on the lever arm near its free end. When the accelerometer arm moves, the aluminum cup moves in a magnetic field created by a magnet from a dynamic speaker. The motion creates eddy currents in the aluminum cup which are proportional to the relative velocities of the arm and the base, thereby providing a damping force.

#### TRANSMITTER

The SPLASHNIK transmitter appears at the top in Figure 4. The transmitter uses a single tube which operates as a self-controlled oscillator

on approximately 69 megacycles. The tube also operates as a frequency doubler and amplifier with an output at 138 megacycles. The lever arm of the accelerometer forms one plate of a variable capacitor which is in the oscillator frequency-determining circuit. When the accelerometer arm moves, it changes the value of this capacitance, which results in a frequency change of the oscillator. The change in frequency due to the movement of the accelerometer arm is very nearly proportional to the acceleration that the accelerometer senses. The capacitance change is adjusted so that a 1/2-g acceleration results in a frequency change of approximately 50 kc. The output of the transmitter is fed through a coaxial cable to the ground plane antenna. It should be noted that the transmitter was designed with low cost in mind, and because of its simplicity, the frequency of its output drifts with temperature and other changes. This effect will be noticeable in operation and will require the user to occasionally retune the receiver during operation.

#### BATTERY PACK

The battery pack used to power the transmitter is composed of six 45-volt dry batteries that furnish plate and screen voltage for the tube and one 3-volt battery for the tube filament. The batteries are wedged into the bottom of the instrument box and are held in place by wooden braces to prevent them from shifting in a rough sea. The batteries are of sufficient capacity to operate the transmitter for a period of more than 8 hours.

#### RECEIVING ANTENNA

The receiving antenna is of the stacked coaxial type with a ground plane and has a gain of 6 db over a simple dipole. This antenna was used because it provides uniform reception from all directions and has a low angle of radiation. Also, temporary installation aboard ship is quite simple. It should always be installed as high as practicable above the water, and clear of obstructions in all directions, to provide the greatest line of sight path from the transmitting antenna. The antenna is

specifically cut to operate on the frequency of the transmitter (138 megacycles, in this case).

#### RECEIVER

The receiver is tunable from 55 to 260 megacycles and was chosen for its excellent sensitivity, stability, and low noise figure which permits the system to receive signals from the buoy over the greatest possible range. The receiver also has a type of discriminator which produces a d-c output voltage that is quite linear for input frequency change. It has been modified to bring the output of the discriminator out to the back panel.

#### LOW-PASS FILTER

The output from the wave-height buoy contains acceleration information caused by the high-frequency short waves which contribute little energy to the wave spectrum in the frequency range of interest. This information will, in fact, mask the desired lower frequency accelerations of the important gravity wave range. To eliminate the undesired information, an electronic low-pass filter is used. The output of the receiver is fed into the low-pass filter which has adjustable cutoffs at a number of frequencies (Figure 5). This filter eliminates the higher frequency signals while passing the desired signals. The filter was specifically designed to drive the record amplifiers of an FM tape recorder. However, it may be used with direct writing recorders as well. The filter system was developed at the David Taylor Model Basin.<sup>2,3</sup>

#### RECORDING

The data received from the wave-height buoy system can be recorded on any one of several types of recorder. It is usually recorded on a magnetic tape using FM electronics because this permits the information to be played directly into the Taylor Model Basin spectrum analyzer. The data could also be recorded on a strip chart recorder using the proper driving amplifiers. This would allow immediate access to the raw data.

## SOME REMARKS ON THE ACCELERATION RECORD

The output of the SPLASHNIK is recorded as a filtered variable d-c voltage proportional to the acceleration experienced by the system. Several aspects of the SPLASHNIK output must be discussed before one can safely proceed to computation of the end product, the wave height spectrum.

The low-pass filter has already been mentioned. High-frequency wave information above 1 cps cannot be recorded accurately because it is distorted by the frequency response of the 3-foot float. In addition, wave frequencies above 0.5 cps are usually of little concern to ship motion studies but do contribute rather large accelerations. If the sensitivity of a recording channel is adjusted to accept the highest signal, then the contributions in the important lower frequency range will be considerably smaller and may even be hardly discernible. Elimination of the higher frequency content serves to emphasize the important wave components. The adjustable frequency cutoff in the low-pass filter provides a choice for elimination of undesired information.

Dorrestein<sup>1</sup> points out that an error in the acceleration signal results from the tilt of the raft on the side of a wave. He concludes that the error is small, but being proportional to the square of the slope of the raft, it has a d-c component which must be removed before double integration. The SPLASHNIK is, of course, subject to the same error. Even if the accelerometer were satisfactorily stabilized, the low quality electronics (designed to keep cost down) still produces a d-c drift in the acceleration record. However, our method of analysis requires computation of the acceleration spectrum and algebraic operation on this function to obtain the wave spectrum. Consequently, double integration is not necessary and the need for a high-pass filter is eliminated. The result of this is an acceleration spectrum showing energy out to zero frequency, which is known not to exist. A "human filter" is applied at this stage by arbitrarily cutting off the acceleration spectrum where it

approaches zero and at the frequency below which wave energy is known not to be present. This will be discussed further in the next section.

The error due to tilt of the accelerometer, mentioned by Dorrestein,<sup>1</sup> has been examined theoretically by Tucker.<sup>4</sup> Computations were made of the magnitude of the errors introduced into wave measurement by using an accelerometer which sets itself in the "apparent vertical," that is, perpendicular to the local water surface, instead of being stabilized to measure the true vertical acceleration. This applies directly to the SPLASHNIK. Tucker found that the spectrum of the error signal rises steeply at low frequencies but does not seriously affect the main wave components. Figure 6, from Tucker's paper, shows several error spectra superposed on hypothetical wave spectra for three sea states. From these graphs, the following computations were made by Tucker:

Sea State	5	7	9
Error in spectral density at frequency of maximum energy	0.9%	1.3%	2.8%
Error in rms wave height with high-pass filter	3.9%	1.6%	1.1%

The errors are seen to be relatively small, about 4 percent in rms wave height in State 5 sea and decreasing for higher sea states.

#### CALCULATION OF THE WAVE SPECTRUM

The SPLASHNIK will measure the apparent vertical acceleration of the environmental water particles such that a particular record may be represented by an integral of the form

$$a(t) = \int_0^{\infty} \cos [\omega t + \epsilon(\omega)] \sqrt{a(\omega)} d\omega \quad [1]$$

That is, it is supposed that the instantaneous apparent vertical acceleration  $a(t)$  is given by an infinite sum of sinusoids of all frequencies  $\omega$  combined in random phase  $\epsilon$ . The amplitude of each sinusoid is assigned by the acceleration spectrum ordinate  $a(\omega)$ . The integral in Equation [1] is not an ordinary integral in the Riemann sense; it cannot be formally integrated. It represents a mathematical abstraction which responds to the basic rules of the calculus and that will suffice for this discussion.

Using the form of Equation [1], a record of vertical displacement  $[z(t)]$  may be represented by

$$z(t) = \int_0^{\infty} \cos [\omega t + \epsilon(\omega)] \sqrt{z(\omega)} d\omega \quad [2]$$

If Equation [2] is twice differentiated with respect to time, the result is

$$\frac{d^2 z}{dt^2} = \int_0^{\infty} -\omega^2 \cos [\omega t + \epsilon(\omega)] \sqrt{z(\omega)} d\omega \quad [3]$$

Equations [1] and [3] may now be equated to each other, the result being

$$z(\omega) = \frac{1}{\omega^4} a(\omega) \quad [4]$$

Equation [4] states that the energy spectrum of the waves  $z(\omega)$ , may be derived from the energy spectrum of acceleration by an algebraic operation.

The errors that exist in  $a(\omega)$  due to improper measurement of the true vertical acceleration are communicated to  $z(\omega)$ . In addition, there are errors in  $a(\omega)$  due to the finite length of record and to the analysis technique. Failure to measure true vertical acceleration, plus drift in the electronics, results in an acceleration spectrum  $a(\omega)$  which shows finite energy at  $\omega = 0$  (Figure 8a) which by Equation [4] would propagate to  $z(\omega)$  by indicating infinite energy at  $\omega = 0$ . This is overcome by arbitrarily cutting off  $a(\omega)$  at a low frequency where the spectral

density appears to go to zero. The chance of cutting off a low frequency band of swell which might actually be present cannot be ignored, nor can much be done about it since it is inherent in the system to propagate large errors at low frequencies.

Aside from the protective measures taken to prevent erroneous information from appearing at  $\omega = 0$ , and assuring maximum measurement accuracy with the low-pass filter, there is little that can be done to establish confidence in the estimated spectrum of the wave except to compare results obtained from the SPLASHNIK with those obtained by a "reliable standard."

Accordingly, a series of experiments was made in which the output of the SPLASHNIK was converted into a wave spectrum by Equation [4], and this spectrum was compared with the wave spectrum resulting from measurements made by other transducers (at the same time and physically close by) which are considered to be fairly reliable standards. The philosophy of this approach is simply that good agreement in spectral shape and area will produce good agreement in prediction of the statistical characteristics of the waves. Such a result would obviate the necessity for further investigation of errors in the SPLASHNIK measurement system. On the other hand, poor agreement would certainly indicate that further study of the system is required.

#### EXPERIMENTAL VERIFICATION

Initial tests were made in the TMB deep basin where irregular long-crested waves were generated with spectral peaks appropriate to wave lengths of 15 and 20 feet respectively. The waves were measured directly by a fixed capacitance probe and by the SPLASHNIK. The SPLASHNIK acceleration spectra were transformed according to Equation [4] and superimposed on the wave spectra measured by the capacitance probe. The results are shown in Figure 7. Although the individual spectral densities differ somewhat, the areas are almost identical as evidenced by the rms values. The spectral peaks are well identified in both cases.

The model tank tests were quite successful but they were made in long-crested waves of relatively high frequency. It was necessary to test under actual sea conditions, in order to establish any real confidence in the system.

Preliminary tests in Chesapeake Bay indicated that the SPLASHNIK had a life in excess of 8 hours and a range of about 11 miles over flat water. Since transmission of the signal is on a line-of-sight basis, one expects trouble in high seas as separation of SPLASHNIK and ship increases.

In a recent full-scale trial, the SPLASHNIK system was tested in conjunction with a shipborne wave recorder<sup>5</sup> in moderate states of sea (4-5). Several buoys were used in this experiment with varying degrees of success. One SPLASHNIK turned over, which was quite unexpected. A few SPLASHNIKS ceased transmitting after 5 or 10 minutes because their batteries were shaken loose. (Batteries are now firmly secured.) Several, however, transmitted successfully for periods ranging from half an hour to in excess of 3 hours. It is believed that lengthening the transmitting antenna by 1 foot and the SPLASHNIK float by 1 foot on each side will increase chances of successful transmission and reception of the signal.

Several simultaneous wave recordings were made with SPLASHNIKS and the shipborne wave recorder. Two of these events, each 20 minutes long, have been selected for analysis. Case I is depicted in Figure 8. The acceleration spectrum is computed on the Taylor Model Basin analog spectrum analyzer.<sup>6</sup> As expected, energy appears at the low frequencies where it is known not to exist. The arbitrary cutoff is made at  $\omega = 0.342$  and then the wave spectrum is computed by Equation [4] (Figure 8b). In order to compare the SPLASHNIK with the shipborne wave recorder, it must be recalled that the ship was advancing into the waves at about 3.5 knots (to maintain heading) while the SPLASHNIK drifted in the opposite direction at about



1 knot; this Doppler effect must be taken into account. Since only a comparison of wave spectra is desired, in this case, it is only necessary to impose the same experimental conditions on the two systems. This was accomplished by a frequency transformation on the SPLASHNIK wave spectrum for a speed of 4.5 knots into the waves. The transformation is given by

$$\omega_e = \omega + \omega^2 \frac{v}{g} \cos \chi \quad [5]$$

where the Jacobian

$$J = \frac{\partial \omega}{\partial \omega_e} \quad [6]$$

is incorporated to conserve the energy in the transformed spectrum.

The transformation of the spectrum given by Equations [5] and [6] results in an estimate of the spectrum which would have been measured if the SPLASHNIK had traveled into the waves ( $\chi = 0$ ) at a speed ( $v$ ) of 4.5 knots. Of course, the drift of the SPLASHNIK is a guess and the transformation assumes that the waves were all traveling in one direction; nevertheless at low speeds, the estimate should be fairly reliable. Figure 8b shows the computed and transformed SPLASHNIK wave spectra, and Figure 8c shows the shipborne wave recorder (SBWR) spectrum superimposed on the transformed SPLASHNIK spectrum. The SPLASHNIK peak is somewhat lower than the SBWR peak and is located at a slightly higher frequency, but shows more energy at higher frequencies than the shipborne wave recorder. In any case, the two spectra have the same general form and the rms wave heights as shown in Figure 8c are fairly close. A second case (Figure 9), shows even better agreement in spectral shape and a remarkable agreement in rms wave height.

It has been noted that the SPLASHNIK drifts. It is, of course, desirable to measure the waves at a fixed point and consequently a transformation is suggested to account for the drift. In view of Figure 8b,

it may be inferred that a drift of 1 knot will not change the shape of the spectrum materially nor will it shift the frequency of maximum energy very much. However, a drift of several knots could make a significant difference, and this problem should be looked into.

In view of this evidence, there is some basis for confidence in the SPLASHNIK as a wave measuring device. It is, however, desirable to secure further verification under better controlled experimental conditions. To this end, the U.S. Navy Hydrographic Office is conducting an independent investigation of the SPLASHNIK, with a probe fixed to a platform in the open ocean as a standard.

#### PROPOSED IMPROVEMENTS

Plans are being made to replace some of the electronics of the SPLASHNIK with parts of better quality so that it may be used as a more accurate research tool. This will probably necessitate cost changes that may remove the "improved" SPLASHNIK from the category of "disposable item."

It is intended to replace the present transmitting system with a conventional type FM telemetering transmitter which is capable of carrying several channels of sea state information by FM subcarriers. The transducers will be a precision accelerometer and a vertical gyro which measures the tilt of the raft (equivalent to measuring roll and pitch on a ship). The vertical gyro will be used to correct for the tilt of the SPLASHNIK, by eliminating the horizontal and gravitational components in the apparent vertical acceleration measurement. The final recording will be a true vertical acceleration. All such information would be received, demodulated, and recorded on tape. The anticipated accuracy of such a system (exclusive of the tape recorder) is expected to be within 1 percent of full-scale signal.

The SPLASHNIK will be further outfitted with a fin that orients

the system with the wind. Wind direction will be recorded aboard ship and when correlated with information from the gyro on the resultant tilt direction, the dominant wave direction can be estimated. It is believed that the directional wave spectrum may be resolved from the data of vertical acceleration and "tilt."

## REFERENCES

1. Dorrestein, R., "A Wave Recorder for Use on a Ship in the Open Sea," Proceedings Symposium on the Behaviour of Ships in a Seaway, Wageningen, Netherlands (Sep 1957), pp. 408-417.
2. Frillman, F. E., "The DTMB Type 337-1A Electronic Low-Pass Filter Instruction Manual," David Taylor Model Basin Report 1337 (Dec 1959).
3. Campbell, W. S., "On the Design of a Resistance Capacitance Filter for Use at Very Low Frequencies," David Taylor Model Basin Report 1307 (Mar 1959).
4. Tucker, M. J., "The Accuracy of Wave Measurements Made with Vertical Accelerometers," Deep Sea Research, Vol. 5 (1959), pp. 185-192.
5. Tucker, M. J., "A Ship-borne Wave Recorder," Proceedings of First Conference on Coastal Engineering Instruments, Berkeley, California (1955), pp. 112-118.
6. Marks, Wilbur and Strausser, P. E., "SEADAC - The Taylor Model Basin Seakeeping Data Analysis Center," David Taylor Model Basin Report 1353, (Jul 1960).

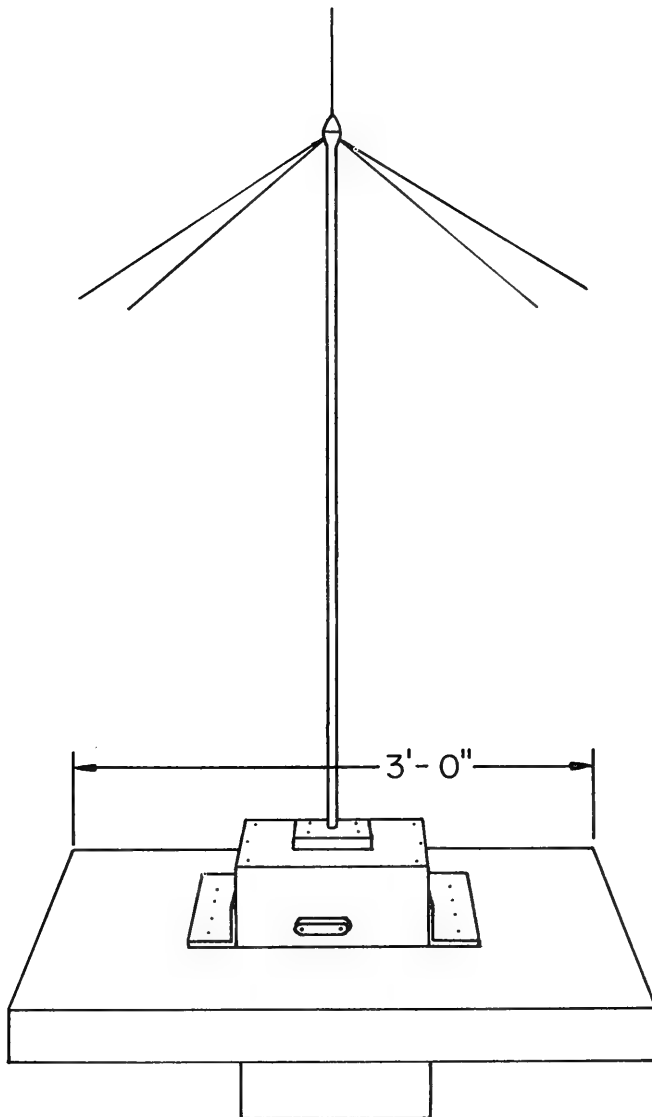

Figure 1 - The "SPLASHNIK"

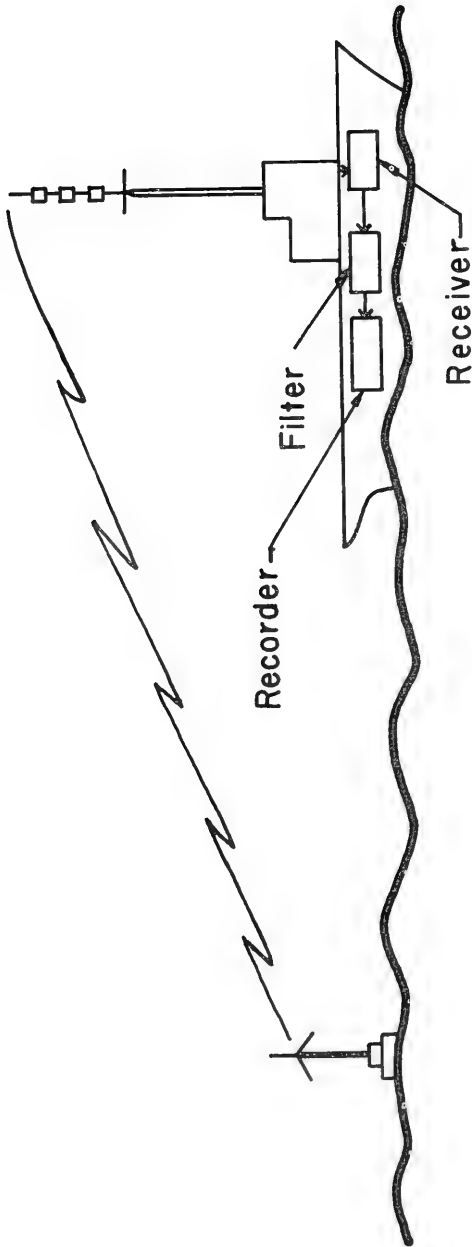

Figure 2 - Wave Buoy Sensing and Recording System

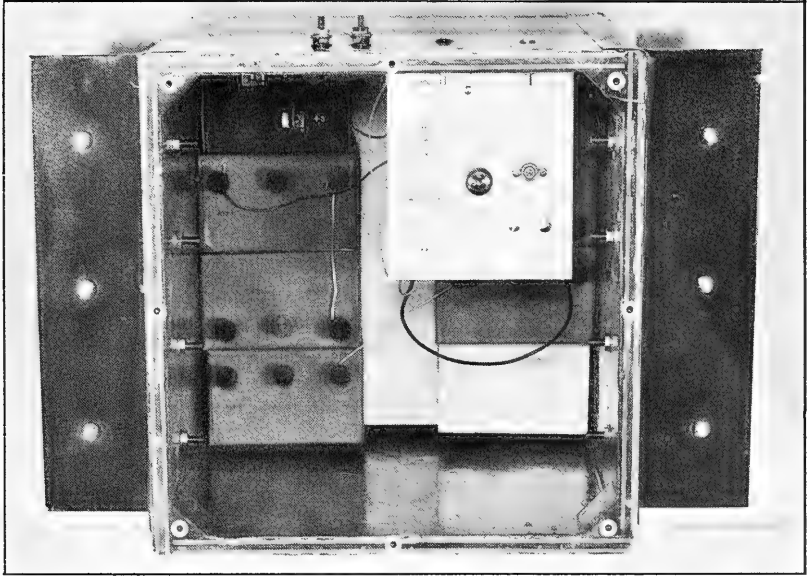

Figure 3 - Top View of SPLASHNIK Instrument Box

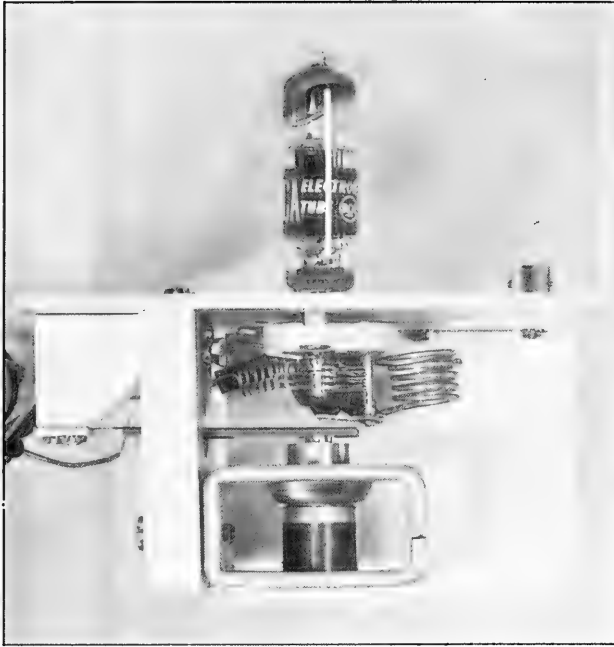

Figure 4 - Electronic Unit of SPLASHNIK

Transmitter appears in upper portion; accelerometer and damper in lower portion.



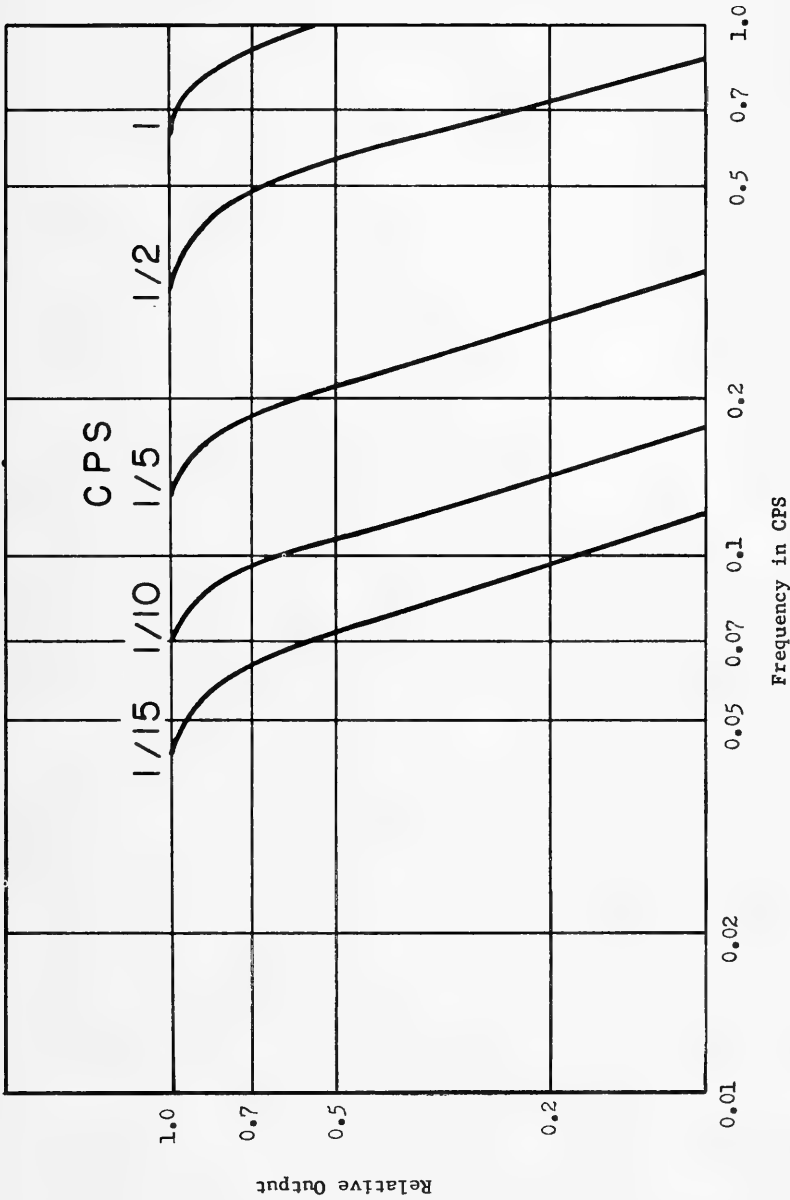

Figure 5 - Typical Frequency Response Curves for TMB Low-pass Filter Type 137-1A

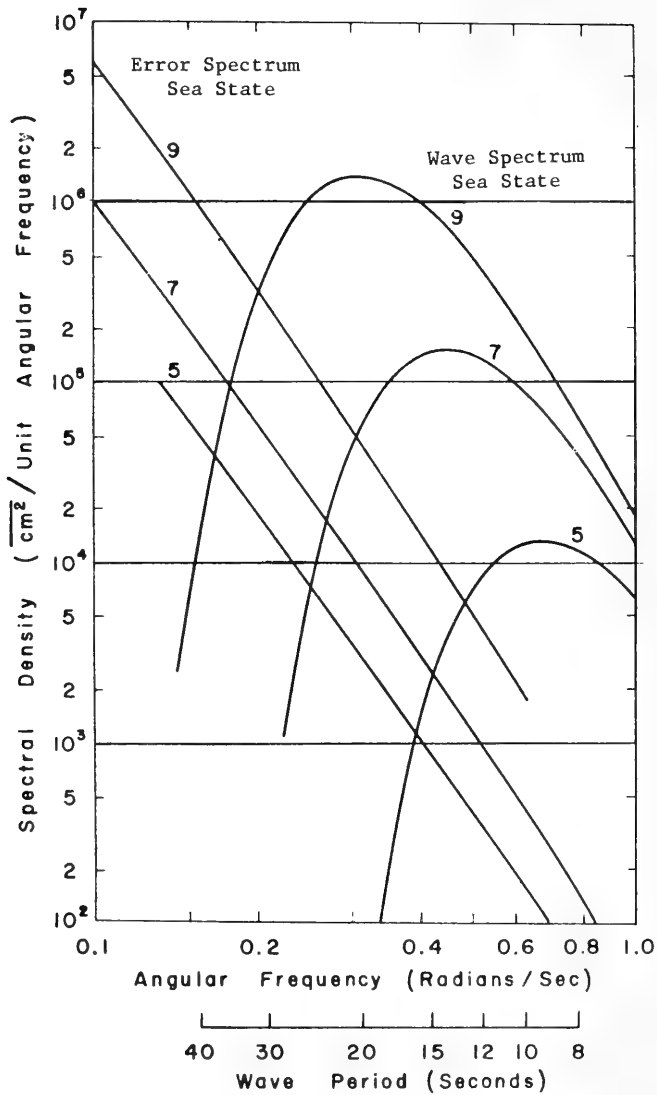

Figure 6 - Neumann Wave Spectra and Corresponding Error Spectra for Buoy with Unstabilized Accelerometer

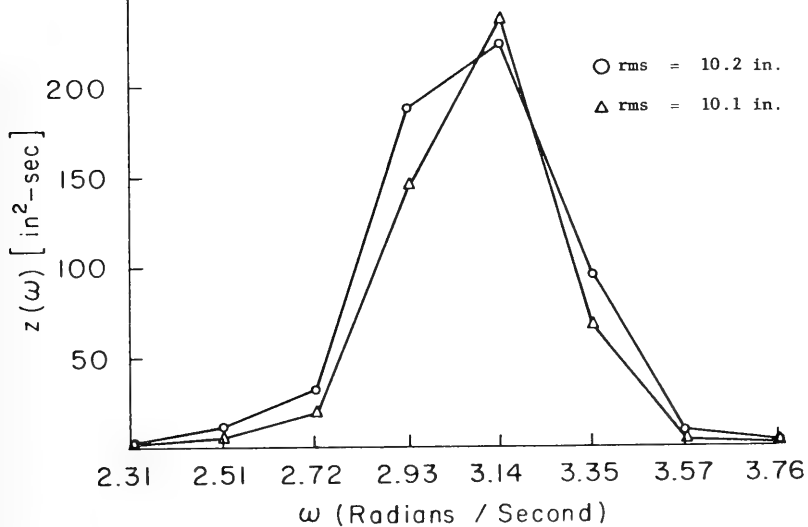
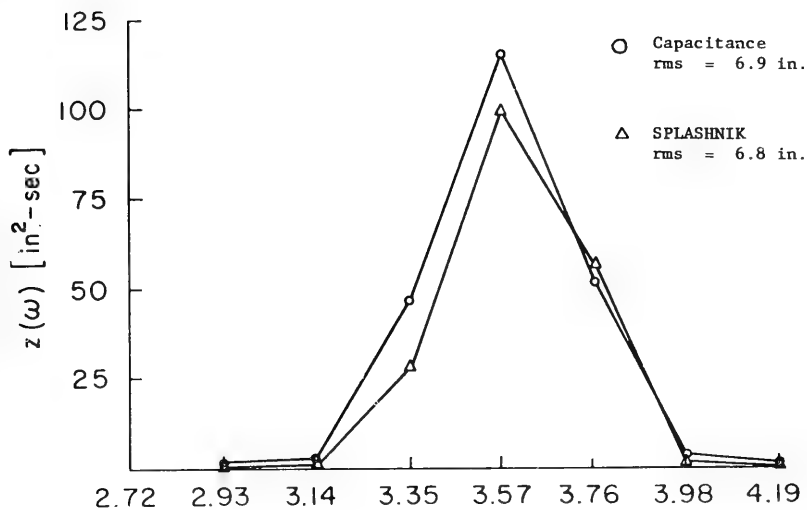

Figure 7 - Comparison of Wave Spectra Measured in Irregular Long-crested Waves in the TMB Deep Water Basin

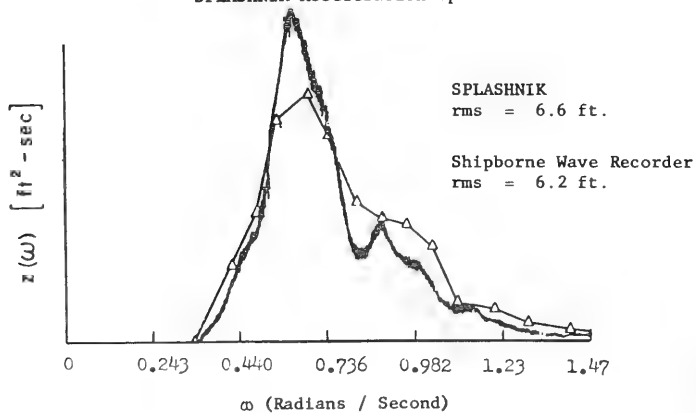
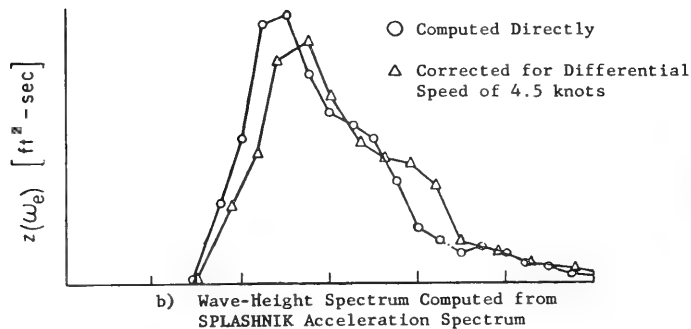
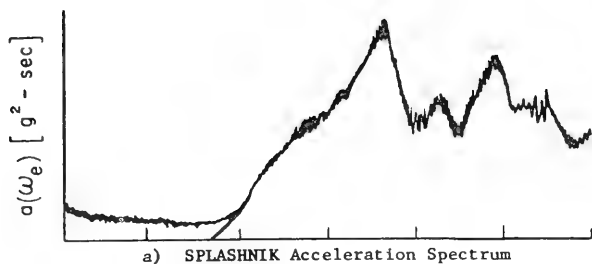

Figure 8 - Comparison of Wave-Height Spectra Computed from Records Obtained by the SPLASHNIK and by a Shipborne Wave Recorder - Case I

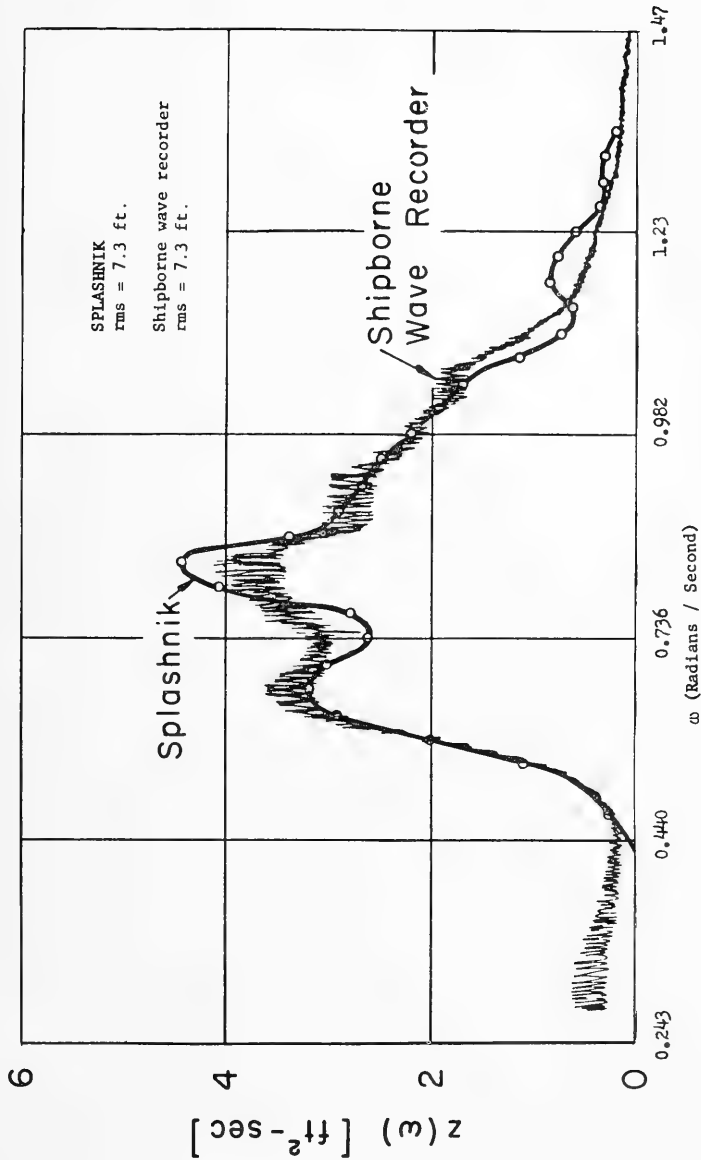

Figure 9 - Comparison of Wave-Height Spectra Computed from Records Obtained by the SPLASHNIK and by a Shipborne Wave Recorder - Case II



# INITIAL DISTRIBUTION

Copies	Copies	Copies
10 CHBUSHIPS 3 Tech Info Br (Code 335) 1 Tech Asst (Code 106) 1 Appl Sci (Code 340) 1 Ship Des (Code 410) 1 Prelim Des Br (Code 420) 1 Submarine Br (Code 525) 1 Minesweeping (Code 631) 1 Torpedo Countermeas (Code 631M)	3 Dir, DL, SIT, Hoboken 1 Mr. E.V. Lewis 1 Mr. W. Marks, Head Ship Hydro Div 1 Dir, Exp Nav Tank, Univ of Michigan 1 Dir, Inst for Fluid Dyn & Appl Math, Univ of Maryland 1 Dir, Hydras Lab, Univ of Colorado 1 Dir, Hydras Res Lab, Univ of Connecticut 1 Lib, Scripps Inst of Oceanography, Univ of California, LaJolla 1 Dir, Fluid Mech Lab, Dept of Engin Mech, New York Univ 1 Dir, Robinson Hydras Lab, Ohio St Univ 1 Dir, Hydras Lab, Penn St Univ 1 Dir ORL, Penn St Univ 1 Dir, WHOI, Woods Hole 1 Dir, Hydras Lab, Univ of Wisconsin 1 Dir, Hydras Lab, Univ of Washington 1 Admin, Webb Inst of Nav Arch 2 Dir, Iowa Inst of Hydras Res, St Univ of Iowa, 1 Dr. L. Landweber 1 Dir, St Anthony Falls Hydras Lab, Univ of Minnesota 1 Dir of Res, Tech Inst, Northwestern Univ 1 Head, Dept NAME, MIT 1 SUPSHIP, Quincy 1 SUPSHIP, Camden 1 New York Shipbldg Corp Attn: Mr. J.W. Thompson, Nav Arch 3 NNS & DD Co. 1 Asst Nav Arch 2 Dir, Hydras Lab 1 James Forrestal Res Ctr, Princeton Univ Attn: Mr. M.H. Smith, Asst to Dir 1 Tech Dir, Ship Struc Com, NRC 2 Tech Products Co, Los Angeles 1 Mr. R.C. Moody, Chief Engr 1 Dr. M.L. Alberston, Head, Fluid Mech Res, Dept of Civil Engin, Colorado St Univ, Fort Collins 1 Prof. B.V. Korvin-Kroukovsky, E. Randolph, VT. 1 Prof. M.A. Abkowitz, Dept of NAME, MIT, Cambridge 1 Dr. George C. Manning, Prof, Nav Arch, MIT, Cambridge 1 Prof. F.M. Lewis, Dept NAME, MIT, Cambridge 1 Dr. V.G. Szebehely, Aero Sci Lab, General Electric Co, Philadelphia 8 ALUSNA, London 1 Dir, Hydro Lab, NRC, Ottawa 2, Canada	1 Dr. Georg Weinblum, Universitaet Hamburg, Berliner Tor 21, Germany 1 RADN R. Brard, Dir, Bassin d'Essais des Carenes, 6 Blvd Victor, Paris (15e), France 1 Dr. L. Malavard, Office Natl d'Etudes et de Recherches Aeronautiques, 25 Ave de la Division, LeClerc, Chatillon, Paris, France 1 Gen Ing. U. Pugliese, Pres, Istituto Nazionale per Studi ed Esperienze di Arch Nav via della Vasca Navale 89, Rome, Italy 1 Senor Manuel Lopez-Acevedo, Dir, Canal de Experiencias Hidrodinamicas, El Pardo, Madrid, Spain 2 Dir, Nederlands Scheepsbouwkundig-Proefstation, Haagsteeg 2, Wageningen, The Netherlands 1 Dr. G. Vossers 1 Mr. Otto Bussemaker, Hoofd. V.H. Bureau Scheepsbouw Ministerie, Van Defensie (Marine), Torenstraat 172, The Hague, Netherlands 1 Prof. J.K. Lunde, Dir, Statens Skipsmodelltanken, Trondheim, Norway 1 Dr. Hans Edstrand, Dir, Statens Skeppsprovninganstalt, Gateborg C, Sweden 1 Dir of Res, BSRA, Curzon St, London, W.1, England 1 Supt, Ship Div, NPL, Teddington, Middlesex, England 1 Dr. J. Okabe, Res Inst for Appl Mech, Kyushu Univ, Hakozaki-Machi, Fukuoka-shi, Japan 1 Chief Supt, Nav Res Estab, Halifax, Nova Scotia, Canada 1 Prof. L. Howarth, Dept of Math, Univ of Bristol, Bristol, England 1 Ir. J. Gerritsma, Delft Shipbldg Lab, Prof. Mekelweg 2, Delft, The Netherlands 1 Dr. Siegfried Schuster, Head, Berlin Model Basin, Berlin 87, Germany 1 Dr. H.W. Lerbs, Dir, Hamburg Model Basin, Hamburg 33, Germany 2 Dir, AEW, Gosport, Hants, England 1 Mr. E.C. Tupper 1 Prof C.W. Prohaska, Hydro-Og Aerodynamisk Laboratorium, Hjortekaersveg 99, Lyngby, Denmark 1 Prof. Dr. Aldo Andreoni, Instituto de Pesquisas, Technico-cologica, Caixa Postal 7141, Sao Paulo, Brazil 1 Dr. J. Diederonne, Dir, General Inst de Recherches de la Construc Navale, 47 Rue de Monceau, Paris (8e) France
5 CHBUWEPS (R) 1 SP-22 2 Aero & Hydro Br (RAAD-3)		
6 CHONR 1 Systems Analysis (Code 406) 1 Geophys Br (Code 416) 1 Math Br (Code 432) 2 Fluid Dynamics (Code 438) 1 Undersea Programs (Code 466)		
1 ONR, New York		
1 ONR, Pasadena		
1 ONR, Chicago		
1 ONR, Boston		
1 ONR, London		
1 NAVSHIPYD NORVA		
1 NAVSHIPYD BSN		
1 NAVSHIPYD PTSMH		
1 NAVSHIPYD PUG		
1 COMWESTEVDET		
1 CDR, USNOL		
1 DIR, USNRL		
1 CDR, USNOTS, Pasadena		
1 CDR, USNOTS, China Lake		
1 CO & DIR, USNMDL		
1 CO, USNUOS		
1 DIR, Langley RESCENHYDRODIV		
1 CDR, USNAVMISCEN, Point Mugu		
1 CO, Frankford Arsenal Off Air Res, Appl Mech Gr, Dayton		
1 DIR, Natl BuStand		
1 BUWEPS REP, Teterboro		
1 OTS, Dept Com, Attn: Tech Rpts Sec		
10 CDR, ASTIA, Attn: TIPDR		
1 Dir of Def R & E		
1 Dir, Alden Hydras Lab, Worcester Polytech Inst		
1 Dir, APL, Johns Hopkins Univ, Silver Spring		
1 Dir, Fluid Mech Lab, Columbia Univ		
1 Dir, Fluid Mech Lab, Univ of Calif, Berkeley		









**David Taylor Model Basin, Report 1423.**

"SPLASHNIK"—THE DAVID TAYLOR MODEL BASIN DISPOSABLE WAVE BUOY, by Wilbur Marks and Robert G. Tuckerman, December 1960. 27p. illus., photos., graphs, refs. (Presented at the VIlth Conference on Coastal Engineering, sponsored by the Council on Wave Research, The Hague, Netherlands, August 1960)  
UNCLASSIFIED

A disposable telemetering wave buoy is described. Its operating principles, based on measurement of the apparent vertical acceleration of surface water particles, are discussed. The method of reduction of acceleration records to wave height spectra is given. Experiments made in the model tank and at sea, for the purpose of comparing the SPLASHNIK with fairly reliable systems of wave measurement, are described in detail. The results are shown to indicate good agreement between the measurements of the SPLASHNIK and two other instruments. The

1. Water waves--Measurement--Instrumentation
2. Water waves--Recording devices
3. Buoy--Telemeter systems
4. Telemetering--Equipment
5. SPLASHNIK (Telemetering wave buoy)
6. Buoy--TMB
7. Marks, Wilbur
8. Tuckerman, Robert G.

**David Taylor Model Basin, Report 1423.**

"SPLASHNIK"—THE DAVID TAYLOR MODEL BASIN DISPOSABLE WAVE BUOY, by Wilbur Marks and Robert G. Tuckerman, December 1960. 27p. illus., photos., graphs, refs. (Presented at the VIlth Conference on Coastal Engineering, sponsored by the Council on Wave Research, The Hague, Netherlands, August 1960)  
UNCLASSIFIED

A disposable telemetering wave buoy is described. Its operating principles, based on measurement of the apparent vertical acceleration of surface water particles, are discussed. The method of reduction of acceleration records to wave height spectra is given. Experiments made in the model tank and at sea, for the purpose of comparing the SPLASHNIK with fairly reliable systems of wave measurement, are described in detail. The results are shown to indicate good agreement between the measurements of the SPLASHNIK and two other instruments. The

1. Water waves--Measurement--Instrumentation
2. Water waves--Recording devices
3. Buoy--Telemeter systems
4. Telemetering--Equipment
5. SPLASHNIK (Telemetering wave buoy)
6. Buoy--TMB
7. Marks, Wilbur
8. Tuckerman, Robert G.

**David Taylor Model Basin, Report 1423.**

"SPLASHNIK"—THE DAVID TAYLOR MODEL BASIN DISPOSABLE WAVE BUOY, by Wilbur Marks and Robert G. Tuckerman, December 1960. 27p. illus., photos., graphs, refs. (Presented at the VIlth Conference on Coastal Engineering, sponsored by the Council on Wave Research, The Hague, Netherlands, August 1960)  
UNCLASSIFIED

A disposable telemetering wave buoy is described. Its operating principles, based on measurement of the apparent vertical acceleration of surface water particles, are discussed. The method of reduction of acceleration records to wave height spectra is given. Experiments made in the model tank and at sea, for the purpose of comparing the SPLASHNIK with fairly reliable systems of wave measurement, are described in detail. The results are shown to indicate good agreement between the measurements of the SPLASHNIK and two other instruments. The

1. Water waves--Measurement--Instrumentation
2. Water waves--Recording devices
3. Buoy--Telemeter systems
4. Telemetering--Equipment
5. SPLASHNIK (Telemetering wave buoy)
6. Buoy--TMB
7. Marks, Wilbur
8. Tuckerman, Robert G.

**David Taylor Model Basin, Report 1423.**

"SPLASHNIK"—THE DAVID TAYLOR MODEL BASIN DISPOSABLE WAVE BUOY, by Wilbur Marks and Robert G. Tuckerman, December 1960. 27p. illus., photos., graphs, refs. (Presented at the VIlth Conference on Coastal Engineering, sponsored by the Council on Wave Research, The Hague, Netherlands, August 1960)  
UNCLASSIFIED

A disposable telemetering wave buoy is described. Its operating principles, based on measurement of the apparent vertical acceleration of surface water particles, are discussed. The method of reduction of acceleration records to wave height spectra is given. Experiments made in the model tank and at sea, for the purpose of comparing the SPLASHNIK with fairly reliable systems of wave measurement, are described in detail. The results are shown to indicate good agreement between the measurements of the SPLASHNIK and two other instruments. The

1. Water waves--Measurement--Instrumentation
2. Water waves--Recording devices
3. Buoy--Telemeter system
4. Telemetering--Equipment
5. SPLASHNIK (Telemetering wave buoy)
6. Buoy--TMB
7. Marks, Wilbur
8. Tuckerman, Robert G.

SPLASHNIK is judged to be acceptable as a wave measurement device, within the scope of its intended use. Future plans for refining the system's accuracy and extending its potential to measurement of other variables are discussed.

SPLASHNIK is judged to be acceptable as a wave measurement device, within the scope of its intended use. Future plans for refining the system's accuracy and extending its potential to measurement of other variables are discussed.

SPLASHNIK is judged to be acceptable as a wave measurement device, within the scope of its intended use. Future plans for refining the system's accuracy and extending its potential to measurement of other variables are discussed.

SPLASHNIK is judged to be acceptable as a wave measurement device, within the scope of its intended use. Future plans for refining the system's accuracy and extending its potential to measurement of other variables are discussed.

**David Taylor Model Basin, Report 1423.**

"SPLASHNIK"--THE DAVID TAYLOR MODEL BASIN DISPOSABLE WAVE BUOY, by Wilbur Marks and Robert G. Tuckerman, December 1960. 27p. illus., photos., graphs, refs. (Presented at the Vth Conference on Coastal Engineering, sponsored by the Council on Wave Research, The Hague, Netherlands, August 1960)

A disposable telemetering wave buoy is described. Its operating principles, based on measurement of the apparent vertical acceleration of surface water particles, are discussed. The method of reduction of acceleration records to wave height spectra is given. Experiments made in the model tank and at sea, for the purpose of comparing the SPLASHNIK with fairly reliable systems of wave measurement, are described in detail. The results are shown to indicate good agreement between the measurements of the SPLASHNIK and two other instruments. The

1. Water waves--Measurement--Instrumentation
  2. Water waves--Recording devices
  3. Buoys--Telemeter systems
  4. Telemetering--Equipment
  5. SPLASHNIK (Telemetering wave buoy)
  6. Buoys--TMB
- I. Marks, Wilbur  
II. Tuckerman, Robert G.

**David Taylor Model Basin, Report 1423.**

"SPLASHNIK"--THE DAVID TAYLOR MODEL BASIN DISPOSABLE WAVE BUOY, by Wilbur Marks and Robert G. Tuckerman, December 1960. 27p. illus., photos., graphs, refs. (Presented at the Vth Conference on Coastal Engineering, sponsored by the Council on Wave Research, The Hague, Netherlands, August 1960)

A disposable telemetering wave buoy is described. Its operating principles, based on measurement of the apparent vertical acceleration of surface water particles, are discussed. The method of reduction of acceleration records to wave height spectra is given. Experiments made in the model tank and at sea, for the purpose of comparing the SPLASHNIK with fairly reliable systems of wave measurement, are described in detail. The results are shown to indicate good agreement between the measurements of the SPLASHNIK and two other instruments. The

1. Water waves--Measurement--Instrumentation
  2. Water waves--Recording devices
  3. Buoys--Telemeter systems
  4. Telemetering--Equipment
  5. SPLASHNIK (Telemetering wave buoy)
  6. Buoys--TMB
- I. Marks, Wilbur  
II. Tuckerman, Robert G.

**David Taylor Model Basin, Report 1423.**

"SPLASHNIK"--THE DAVID TAYLOR MODEL BASIN DISPOSABLE WAVE BUOY, by Wilbur Marks and Robert G. Tuckerman, December 1960. 27p. illus., photos., graphs, refs. (Presented at the Vth Conference on Coastal Engineering, sponsored by the Council on Wave Research, The Hague, Netherlands, August 1960)

A disposable telemetering wave buoy is described. Its operating principles, based on measurement of the apparent vertical acceleration of surface water particles, are discussed. The method of reduction of acceleration records to wave height spectra is given. Experiments made in the model tank and at sea, for the purpose of comparing the SPLASHNIK with fairly reliable systems of wave measurement, are described in detail. The results are shown to indicate good agreement between the measurements of the SPLASHNIK and two other instruments. The

1. Water waves--Measurement--Instrumentation
  2. Water waves--Recording devices
  3. Buoys--Telemeter systems
  4. Telemetering--Equipment
  5. SPLASHNIK (Telemetering wave buoy)
  6. Buoys--TMB
- I. Marks, Wilbur  
II. Tuckerman, Robert G.

**David Taylor Model Basin, Report 1423.**

"SPLASHNIK"--THE DAVID TAYLOR MODEL BASIN DISPOSABLE WAVE BUOY, by Wilbur Marks and Robert G. Tuckerman, December 1960. 27p. illus., photos., graphs, refs. (Presented at the Vth Conference on Coastal Engineering, sponsored by the Council on Wave Research, The Hague, Netherlands, August 1960)

A disposable telemetering wave buoy is described. Its operating principles, based on measurement of the apparent vertical acceleration of surface water particles, are discussed. The method of reduction of acceleration records to wave height spectra is given. Experiments made in the model tank and at sea, for the purpose of comparing the SPLASHNIK with fairly reliable systems of wave measurement, are described in detail. The results are shown to indicate good agreement between the measurements of the SPLASHNIK and two other instruments. The

1. Water waves--Measurement--Instrumentation
  2. Water waves--Recording devices
  3. Buoys--Telemeter system
  4. Telemetering--Equipment
  5. SPLASHNIK (Telemetering wave buoy)
  6. Buoys--TMB
- I. Marks, Wilbur  
II. Tuckerman, Robert G.

SPLASHNIK is judged to be acceptable as a wave measurement device, within the scope of its intended use. Future plans for refining the system's accuracy and extending its potential to measurement of other variables are discussed.

SPLASHNIK is judged to be acceptable as a wave measurement device, within the scope of its intended use. Future plans for refining the system's accuracy and extending its potential to measurement of other variables are discussed.

SPLASHNIK is judged to be acceptable as a wave measurement device, within the scope of its intended use. Future plans for refining the system's accuracy and extending its potential to measurement of other variables are discussed.

SPLASHNIK is judged to be acceptable as a wave measurement device, within the scope of its intended use. Future plans for refining the system's accuracy and extending its potential to measurement of other variables are discussed.

**David Taylor Model Basin, Report 1423.**

"SPLASHNIK"--THE DAVID TAYLOR MODEL BASIN DISPOSABLE WAVE BUOY, by Wilbur Marks and Robert G. Tuckerman, December 1960. 37p. illus., photos., graphs, refs. (Presented at the VIlth Conference on Coastal Engineering, sponsored by the Council on Wave Research, The Hague, Netherlands, August 1960)

A disposable telemetering wave buoy is described. Its operating principles, based on measurement of the apparent vertical acceleration of surface water particles, are discussed. The method of reduction of acceleration records to wave height spectra is given. Experiments made in the model tank and at sea, for the purpose of comparing the SPLASHNIK with fairly reliable systems of wave measurement, are described in detail. The results are shown to indicate good agreement between the measurements of the SPLASHNIK and two other instruments. The

1. Water waves--Measurement--Instrumentation
2. Water waves--Recording devices
3. Buoys--Telemeter systems
4. Telemetering--Equipment
5. SPLASHNIK (Telemetering wave buoy)
6. Buoys--TMB

I. Marks, Wilbur  
II. Tuckerman, Robert G.

**David Taylor Model Basin, Report 1423.**

"SPLASHNIK"--THE DAVID TAYLOR MODEL BASIN DISPOSABLE WAVE BUOY, by Wilbur Marks and Robert G. Tuckerman, December 1960. 37p. illus., photos., graphs, refs. (Presented at the VIlth Conference on Coastal Engineering, sponsored by the Council on Wave Research, The Hague, Netherlands, August 1960)

A disposable telemetering wave buoy is described. Its operating principles, based on measurement of the apparent vertical acceleration of surface water particles, are discussed. The method of reduction of acceleration records to wave height spectra is given. Experiments made in the model tank and at sea, for the purpose of comparing the SPLASHNIK with fairly reliable systems of wave measurement, are described in detail. The results are shown to indicate good agreement between the measurements of the SPLASHNIK and two other instruments. The

1. Water waves--Measurement--Instrumentation
2. Water waves--Recording devices
3. Buoys--Telemeter systems
4. Telemetering--Equipment
5. SPLASHNIK (Telemetering wave buoy)
6. Buoys--TMB

I. Marks, Wilbur  
II. Tuckerman, Robert G.

**David Taylor Model Basin, Report 1423.**

"SPLASHNIK"--THE DAVID TAYLOR MODEL BASIN DISPOSABLE WAVE BUOY, by Wilbur Marks and Robert G. Tuckerman, December 1960. 37p. illus., photos., graphs, refs. (Presented at the VIlth Conference on Coastal Engineering, sponsored by the Council on Wave Research, The Hague, Netherlands, August 1960)

A disposable telemetering wave buoy is described. Its operating principles, based on measurement of the apparent vertical acceleration of surface water particles, are discussed. The method of reduction of acceleration records to wave height spectra is given. Experiments made in the model tank and at sea, for the purpose of comparing the SPLASHNIK with fairly reliable systems of wave measurement, are described in detail. The results are shown to indicate good agreement between the measurements of the SPLASHNIK and two other instruments. The

1. Water waves--Measurement--Instrumentation
2. Water waves--Recording devices
3. Buoys--Telemeter systems
4. Telemetering--Equipment
5. SPLASHNIK (Telemetering wave buoy)
6. Buoys--TMB

I. Marks, Wilbur  
II. Tuckerman, Robert G.

**David Taylor Model Basin, Report 1423.**

"SPLASHNIK"--THE DAVID TAYLOR MODEL BASIN DISPOSABLE WAVE BUOY, by Wilbur Marks and Robert G. Tuckerman, December 1960. 37p. illus., photos., graphs, refs. (Presented at the VIlth Conference on Coastal Engineering, sponsored by the Council on Wave Research, The Hague, Netherlands, August 1960)

A disposable telemetering wave buoy is described. Its operating principles, based on measurement of the apparent vertical acceleration of surface water particles, are discussed. The method of reduction of acceleration records to wave height spectra is given. Experiments made in the model tank and at sea, for the purpose of comparing the SPLASHNIK with fairly reliable systems of wave measurement, are described in detail. The results are shown to indicate good agreement between the measurements of the SPLASHNIK and two other instruments. The

1. Water waves--Measurement--Instrumentation
2. Water waves--Recording devices
3. Buoys--Telemeter system
4. Telemetering--Equipment
5. SPLASHNIK (Telemetering wave buoy)
6. Buoys--TMB

I. Marks, Wilbur  
II. Tuckerman, Robert G.

SPLASHNIK is judged to be acceptable as a wave measurement device, within the scope of its intended use. Future plans for refining the system's accuracy and extending its potential to measurement of other variables are discussed.

SPLASHNIK is judged to be acceptable as a wave measurement device, within the scope of its intended use. Future plans for refining the system's accuracy and extending its potential to measurement of other variables are discussed.

SPLASHNIK is judged to be acceptable as a wave measurement device, within the scope of its intended use. Future plans for refining the system's accuracy and extending its potential to measurement of other variables are discussed.

SPLASHNIK is judged to be acceptable as a wave measurement device, within the scope of its intended use. Future plans for refining the system's accuracy and extending its potential to measurement of other variables are discussed.



**David Taylor Model Basin, Report 1423.**

"SPLASHNIK"--THE DAVID TAYLOR MODEL BASIN DISPOSABLE WAVE BUOY, by Wilbur Marks and Robert G. Tuckerman, December 1960. 27p. illus., photos., graphs, refs. (Presented at the VIlth Conference on Coastal Engineering, sponsored by the Council on Wave Research, The Hague, Netherlands, August 1960)

A disposable telemetering wave buoy is described. Its operating principles, based on measurement of the apparent vertical acceleration of surface water particles, are discussed. The method of reduction of acceleration records to wave height spectra is given. Experiments made in the model tank and at sea, for the purpose of comparing the SPLASHNIK with fairly reliable systems of wave measurement, are described in detail. The results are shown to indicate good agreement between the measurements of the SPLASHNIK and two other instruments. The

1. Water waves--Measurement--Instrumentation
2. Water waves--Recording devices
3. Buoy--Telemeter systems
4. Telemetering--Equipment
5. SPLASHNIK (Telemetering wave buoy)
6. Buoy--TMB

I. Marks, Wilbur  
II. Tuckerman, Robert G.

**David Taylor Model Basin, Report 1423.**

"SPLASHNIK"--THE DAVID TAYLOR MODEL BASIN DISPOSABLE WAVE BUOY, by Wilbur Marks and Robert G. Tuckerman, December 1960. 27p. illus., photos., graphs, refs. (Presented at the VIlth Conference on Coastal Engineering, sponsored by the Council on Wave Research, The Hague, Netherlands, August 1960)

A disposable telemetering wave buoy is described. Its operating principles, based on measurement of the apparent vertical acceleration of surface water particles, are discussed. The method of reduction of acceleration records to wave height spectra is given. Experiments made in the model tank and at sea, for the purpose of comparing the SPLASHNIK with fairly reliable systems of wave measurement, are described in detail. The results are shown to indicate good agreement between the measurements of the SPLASHNIK and two other instruments. The

1. Water waves--Measurement--Instrumentation
2. Water waves--Recording devices
3. Buoy--Telemeter systems
4. Telemetering--Equipment
5. SPLASHNIK (Telemetering wave buoy)
6. Buoy--TMB

I. Marks, Wilbur  
II. Tuckerman, Robert G.

**David Taylor Model Basin, Report 1423.**

"SPLASHNIK"--THE DAVID TAYLOR MODEL BASIN DISPOSABLE WAVE BUOY, by Wilbur Marks and Robert G. Tuckerman, December 1960. 27p. illus., photos., graphs, refs. (Presented at the VIlth Conference on Coastal Engineering, sponsored by the Council on Wave Research, The Hague, Netherlands, August 1960)

A disposable telemetering wave buoy is described. Its operating principles, based on measurement of the apparent vertical acceleration of surface water particles, are discussed. The method of reduction of acceleration records to wave height spectra is given. Experiments made in the model tank and at sea, for the purpose of comparing the SPLASHNIK with fairly reliable systems of wave measurement, are described in detail. The results are shown to indicate good agreement between the measurements of the SPLASHNIK and two other instruments. The

1. Water waves--Measurement--Instrumentation
2. Water waves--Recording devices
3. Buoy--Telemeter systems
4. Telemetering--Equipment
5. SPLASHNIK (Telemetering wave buoy)
6. Buoy--TMB

I. Marks, Wilbur  
II. Tuckerman, Robert G.

**David Taylor Model Basin, Report 1423.**

"SPLASHNIK"--THE DAVID TAYLOR MODEL BASIN DISPOSABLE WAVE BUOY, by Wilbur Marks and Robert G. Tuckerman, December 1960. 27p. illus., photos., graphs, refs. (Presented at the VIlth Conference on Coastal Engineering, sponsored by the Council on Wave Research, The Hague, Netherlands, August 1960)

A disposable telemetering wave buoy is described. Its operating principles, based on measurement of the apparent vertical acceleration of surface water particles, are discussed. The method of reduction of acceleration records to wave height spectra is given. Experiments made in the model tank and at sea, for the purpose of comparing the SPLASHNIK with fairly reliable systems of wave measurement, are described in detail. The results are shown to indicate good agreement between the measurements of the SPLASHNIK and two other instruments. The

1. Water waves--Measurement--Instrumentation
2. Water waves--Recording devices
3. Buoy--Telemeter system
4. Telemetering--Equipment
5. SPLASHNIK (Telemetering wave buoy)
6. Buoy--TMB

I. Marks, Wilbur  
II. Tuckerman, Robert G.

SPLASHNIK is judged to be acceptable as a wave measurement device, within the scope of its intended use. Future plans for refining the system's accuracy and extending its potential to measurement of other variables are discussed.

SPLASHNIK is judged to be acceptable as a wave measurement device, within the scope of its intended use. Future plans for refining the system's accuracy and extending its potential to measurement of other variables are discussed.

SPLASHNIK is judged to be acceptable as a wave measurement device, within the scope of its intended use. Future plans for refining the system's accuracy and extending its potential to measurement of other variables are discussed.

SPLASHNIK is judged to be acceptable as a wave measurement device, within the scope of its intended use. Future plans for refining the system's accuracy and extending its potential to measurement of other variables are discussed.



