

UC-NRLF



D 2 573 091



BERKELEY
LIBRARY
UNIVERSITY OF
CALIFORNIA

2 Vrs

Digitized by the Internet Archive
in 2007 with funding from
Microsoft Corporation

<http://www.archive.org/details/steamengineitsin01tredrich>





Thomas Tredgott

A. 10

Royal Engineer Library

Woolwich.

THE

STEAM ENGINE:

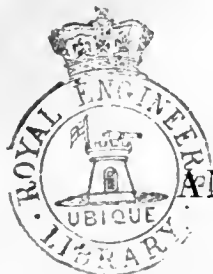

ITS INVENTION AND PROGRESSIVE IMPROVEMENT,

AN INVESTIGATION OF ITS PRINCIPLES,

LONDON

AND ITS APPLICATION TO

NAVIGATION, MANUFACTURES, AND RAILWAYS.

BY THOMAS TREDGOLD, CIVIL ENGINEER,

MEMBER OF THE INSTITUTION OF CIVIL ENGINEERS; AUTHOR OF ELEMENTARY PRINCIPLES OF CARPENTRY;
A PRACTICAL TRÉATISE ON THE STRENGTH OF IRON, &c.

A NEW EDITION,

ENLARGED BY THE CONTRIBUTIONS OF EMINENT SCIENTIFIC MEN, AND EXTENDED
TO THE SCIENCE OF

Steam Naval Architecture.

REVISED AND EDITED

BY W. S. B. WOOLHOUSE, F.R.A.S., &c.,

ACTUARY TO THE NATIONAL LOAN FUND LIFE ASSURANCE SOCIETY.

IN TWO VOLUMES,

WITH ONE HUNDRED AND TWENTY-FIVE ENGRAVINGS AND NUMEROUS WOOD-CUTS.

VOL. I.

369.

LONDON: JOHN WEALE.

MDCCCXXXVIII.

LONDON:

PRINTED BY W. HUGHES, (SUCCESSOR TO MR. VALPY,)

KING'S HEAD COURT, GOUGH SQUARE.

TJ 464
T 72
1838
v.1

TO HER MOST GRACIOUS MAJESTY

V I C T O R I A,

QUEEN OF GREAT BRITAIN AND IRELAND,

&c. &c. &c.

THESE VOLUMES

ON THE PRINCIPLES AND CONSTRUCTION OF THE

STEAM ENGINE,

INVENTED AND PERFECTED BY THE TALENT AND ENTERPRISE OF BRITISH SUBJECTS,

AND ESSENTIAL TO THE PROGRESS OF CIVILISATION IN EVERY NATION,

ARE (BY HER MAJESTY'S GRACIOUS PERMISSION) INSCRIBED,

BY HER MAJESTY'S DEVOTED SUBJECTS,

W. S. B. WOOLHOUSE, EDITOR.
JOHN WEALE, PUBLISHER.

ADVERTISEMENT.

THE work of Tredgold on the Steam Engine, from its first appearance in the year 1827 up to the present time, has maintained the highest reputation, both in this country and on the continent. Since the publication of the first edition, the boundless resources of steam power have been directed, on the most enlarged scale, to almost every important purpose of mankind, and the steam engine has achieved the greatest triumphs of human ingenuity. The present edition contains several valuable contributions from professional gentlemen of acknowledged ability and experience; and, with these and the many revisions and additions which the work has undergone, it is hoped that it will be found suited to the present advanced state of the science, and that it may continue to occupy the same favorable position which it has hitherto enjoyed. A considerable number of errors have been corrected which appeared in the first edition; and, amongst many other improvements, the principles of parallel motion, so important to the manufacturer, have been put in a complete form.

The Appendix consists of the following original papers :

I. On the practical nature and general management of marine boilers, by Mr. DINNEN.

II. A form of steam journal for keeping a proper record of the operations of the engines in all steam vessels, by Lieut. BALDOCK, R.N.

III. On the motion of steam vessels and the principles of paddle wheels, by Mr. P. W. BARLOW.

IV. Time and traverse table for ascertaining the effects obtained with a steam vessel upon an oblique course assisted with canvas, compared with the same vessel upon a direct course without canvas, and with a diminished velocity, by Captain OLIVER, R.N.

V. Memoir of Her Majesty's steam ship the 'Medea,' by Lieutenant BALDOCK, R.N.

VI. On the present state of steam navigation in the United States, by Professor RENWICK, of Columbia College, New York.

VII. Theory of the motion and action of paddle wheels, with a comparison of the principal inventions that have appeared for the propelling of steam vessels, by Mr. MORNAY.

VIII. On the indicator, with practical illustrations of its nature and use, by Mr. GLYNN.

IX. Account of Mr. HOWARD'S new principle of vaporization.

X. On the general theory of the steam engine, in which the theory of the crank, the transmission of effect through the boiler and cylinder, the general principles of action, the theory of paddle wheels, and the nature of the resistance of fluids, are succinctly treated.

The scientific and practical paper by Mr. Barlow, the ingenious theoretical investigations of Mr. Mornay, together with the article contained in this last paper, constitute a very extended, and, perhaps, complete discussion of the interesting subject of paddle wheels.

XI. Practical rules for calculating the steam engine, illustrated by numerous examples. To a person engaged in actual practice, even though he be a first-rate mathematician, a rule and example put down exactly in the order of work is much superior, in every respect, to any mathematical formulæ that can be set before him; and this becomes a matter of indispensable necessity and importance to such as are, exclusively, practical men. It is hoped that these rules and examples, and the copious index, prepared by Mr. Hann, a gentleman intimately acquainted, both theoretically and practically, with the principles of the steam engine, will add greatly to the utility of the edition now offered to the public.

In the explanation of the plates will be found a very lucid and elaborate description, still further illustrated by the aid of numerous wood-cuts in the text, of Stephenson's newest patented locomotive engine; and for this very able, complete, and popular account, we are indebted to the liberality of Mr. Stephenson, engineer of the London and Birmingham and other Railways:—also, an account of Mr. Samuel Hall's condenser, now much used in sea-bound vessels.

To render the work of still greater utility, the Publisher has, after much painful opposition, succeeded in producing examples of the best sea and river vessels, practically illustrating the application of steam-machinery to the purposes of navigation, in reference to the principles of naval architecture; and the Editor is indebted to Mr.

Oliver Lang, of Her Majesty's Dock-yard, Woolwich; Mr. Fincham, of Her Majesty's Dock-yard, Sheerness; and Mr. Ditchburn, of Limehouse; for the able scientific descriptions which accompany these subjects.

It is due to the eminent individuals who have mainly assisted the undertaking, to state that the Publisher and Editor are most grateful to those whose names appear in the work as contributors, as well as to others for many valuable communications and services.

Mr. Weale, the Publisher and Proprietor of the work, has, for nearly two years, held in communication some of the most scientific men in this and other countries, for the purpose of obtaining the most extensive and valuable information; and it will at once be observed, that no expense has been spared, and that neither taste nor skill has been wanting in the getting up of the volumes, to make the present a splendid national work. The Editor, however, cannot presume to suppose that he has similarly succeeded in the execution of his task; and he will, at all times, through the Publisher, be most thankful to receive and acknowledge any suggestion or amendment.

P R E F A C E.

OF the various books published on that important and national subject the Steam Engine, there is not one in our own or any foreign language, which I consider as a fully satisfactory illustration of its principles ; it is therefore only requisite for me to state this fact to render any apology unnecessary for the work I now offer to the notice of the Public. I have frequently and successfully claimed attention as an author ; and in this case I hope to meet with equal success, and to show by the labour and attention I have bestowed on this important subject, how highly I value the ostensible character I have acquired, and the extensive encouragement I have received.

It has been too common of late for mathematicians to complain of want of patronage, and to censure official authorities for not encouraging science, forgetting that research will always be estimated by its intermediate utility ; and while they continue to confine their attention to abstract knowledge, while they do not devote a greater part of their time to its application to the wants and the welfare of society, they must be contented with a small share of those advantages, which result from combining with practical skill the power afforded by abstract reasoning. They should recollect that a Watt could have earned no fame, in an age or in a country where the value of mechanical power was unknown. In following the application of science to art, I have not, however, I hope, been unsuccessful in adding also to the stores of pure science ; and, so far from being insensible to the value of abstract research, I wish it to be pursued with redoubled vigour by those who have spirit to break through the prejudices of existing systems, and study from nature : but it should be cultivated with a desire to promote the great end of human research, that is, the improvement of the condition of man ; otherwise the fantasies of the Greek philosophers might with equal force claim the student's regard.

I hope these remarks will tend to encourage those who pursue knowledge, whether with the energy of youth or the more steady enthusiasm of riper years ; and as all nature, so all art, must ever be the result of those immutable proportions and laws of action which it has pleased our Creator to impress on matter, its objects are truly boundless. Our imperfection consists generally in not being able to foresee all the circumstances which have an influence on the effects of causes ; but in proportion as we proceed in knowledge, we also acquire greater powers of perception : that which was at first difficult becomes easy, and the mind is often roused by the bright gleam of truth, breaking as it were accidentally upon a mass of obscure ideas, and rendering the true solution of the difficulty at once obvious ; and as my gifted countryman Emerson has remarked, “the labour and fatigue of seeking after it instantly vanishes.”

I proceed now to give some idea of this work. It appears to be large for its object ; but, though confined to a single source of power, that power is gigantic, and involves so many new and important doctrines in mechanical science and practice, that it was impossible in justice to comprise it in less space. The work is in Ten Sections.

In the *First*, the history of the progressive improvement of the steam engine is traced, from the period of its first suggestion by the Marquis of Worcester, to its present state of high perfection.

The *Second Section* presents an analysis of the nature of steam and of other species of vapour ; the laws of their combination with heat, and of their elastic force, density, and comparative power ; with the principles of calculating their velocity when in motion, loss of force by cooling, &c. In this section it is shown that water is of all other known fluids that best adapted for producing steam.

The *Third Section* treats of the laws of combustion, and of the effect of different species of fuel in producing steam ; the proportions of fire places and chimneys of boilers, and the precautions necessary for their security and effect : the nature and application of safety apparatus is fully discussed. The section closes with a developement of the principles of condensing steam.

In the *Fourth Section*, the power afforded by a given quantity of steam, and all the methods of developing it, are illustrated both in a popular and scientific manner ; and the theoretical defect of the rotary action of steam is investigated.

The various modes of applying the power of steam are shown, with a classification of engines ; and the velocity and proportions which give a maximum of effect in engines, as well as the nature and office, and the power lost in working the air pumps of engines, are investigated.

The *Fifth Section* treats of the construction of the essentially different varieties of noncondensing steam engines : these engines are all of the high pressure kind ; and the causes of loss of power, and means of employing steam to the best advantage, and the mode of calculating the power and proportion of the parts, are given in detail for each species.

The *Sixth Section* treats, in like manner, of the construction, proportions, power, and economy of condensing engines : in these sections, for the first time, those minute causes which affect the action of steam are not only stated, but are reduced to measure ; and I trust in such a manner as to be most useful, both to those who wish to apply, and to those who wish to improve, the steam engine.

In the *Seventh Section* the proportions and construction of the parts of steam engines are considered, as of cocks, valves, slides, pistons, stuffing boxes, &c. ; also the modes of opening and closing valves, and the like ; followed by a description of the different kinds of piston-rod guides, and an investigation of crank motions, and of the combinations for producing parallel motion : also practical rules for the strength of the various parts of steam engines are added, and especially for boilers of different kinds.

The *Eighth Section* treats,—first, of the modes of equalizing the action of the steam engine, as by fly wheels, or counter weights ; secondly, of regulating the power of engines, as by valves, governors, regulators, &c. ; thirdly, the method of ascertaining the state and intensity of the forces in engines, and the means of measuring their effective power ; and, fourthly, of the mode of working a steam engine.

The *Ninth Section* illustrates the application of steam power to raising water, to the drainage and business of mining, to impelling machinery for manufacturing and for agricultural purposes, and its application to land carriage by means of railways.

The *Tenth Section* is on steam navigation ; and the stability of vessels, their resistance to motion in fluids, the means of propelling them, and the modes of

proportioning the power to the effect, are investigations altogether new ; and of necessity so, for the theory of the resistance of fluids hitherto taught in schools is erroneous and cannot be applied. I have therefore endeavoured to explain the methods of my own researches in popular rather than strictly scientific discussions, reserving for a separate work the full developement of my views on this important branch of science.

The tables will be useful in practice ; and the plates are accompanied by descriptions, so as to render them of easy reference, and also to enable me to refer to the parts of the work which they tend to illustrate.

I am indebted to the friendly assistance of some of my professional brethren for access to information, which otherwise I could not have obtained : in a few instances their favours arrived too late, except for my own satisfaction in finding that they conformed to the principles laid down in this treatise. Of Mr. Bevan's interesting experiments on the resistance of boats I have given only part, because the others were evidently affected by the limited section of the canal. One of the plates (XIII.) was furnished by Mr. White, engineer ; and a few of the others are selected from the very accurate plates drawn by Clement, and published in Partington's 'History of the Steam Engine : ' the rest are engraved from my own drawings, and are aided by a great number of wood engravings on the pages.

My great object has been to lead the reader to study the principles of the steam engine, and to furnish him not only with materials for study, but also with methods of reasoning, and in sufficient variety to enable him to examine any new case likely to occur ; and in proportion to the care and pains he bestows on the inquiry, he will feel the advantage of the few steps I have taken in this interesting and important subject.

I shall conclude in the language of Sir Isaac Newton on a greater occasion :—
“ I heartily beg that what I have here done may be read with candour, and that the defects I have been guilty of upon this difficult subject may not be so much reprehended as kindly supplied and investigated by new endeavours of my readers.”

THOMAS TREDGOLD.

16, GROVE PLACE,

LISSEN GROVE, LONDON.

August 13, 1827.

CONTENTS.

	PAGE
SECTION I.	
AN ACCOUNT OF THE INVENTION AND PROGRESSIVE IMPROVEMENT OF THE STEAM ENGINE	1
SECTION II.	
OF THE NATURE AND PROPERTIES OF STEAM, ITS ELASTIC FORCE, EXPANSIVE FORCE, AND POWER OF MOTION	47
SECTION III.	
OF THE GENERATION AND CONDENSATION OF STEAM, AND THE APPARATUS FOR THOSE PURPOSES	105
SECTION IV.	
OF THE MECHANICAL POWER OF STEAM, AND THE NATURE, GENERAL PROPOR- TIONS, AND CLASSIFICATION OF STEAM ENGINES	150
SECTION V.	
OF THE CONSTRUCTION OF NONCONDENSING ENGINES	173
SECTION VI.	
OF THE CONSTRUCTION OF CONDENSING ENGINES	184

	PAGE
SECTION VII.	
OF THE PROPORTIONS, AND THE CONSTRUCTION, OF THE PARTS OF STEAM ENGINES	203
SECTION VIII.	
OF EQUALIZING THE ACTION, REGULATING THE POWER, MEASURING THE USEFUL EFFECT, AND MANAGING THE STEAM ENGINE	256
SECTION IX.	
OF THE APPLICATION OF STEAM ENGINES TO DIFFERENT PURPOSES	274
SECTION X.	
OF STEAM NAVIGATION	288
TABLES.	
TABLE I. OF THE PROPERTIES OF THE STEAM OF WATER OF DIFFERENT DEGREES OF ELASTIC FORCE	322
TABLE II. OF THE PROPORTIONS OF SINGLE ACTING STEAM ENGINES	323
TABLE III. OF THE PROPORTIONS OF DOUBLE ACTING STEAM ENGINES	324—325
EXPLANATION OF THE PLATES	327

CONTENTS.

xv

APPENDIX.

SECTION	PAGE
I. On Marine Boilers.—By J. DINNEN, Esq., Assistant Engineer, Her Majesty's Dock-yard, Woolwich	1
II. A Form of Steam Journal, with remarks on the necessity of keeping a proper record of the operations of the engines in all steam vessels, and directions for marking the Steam Journal, &c.—By T. BALDOCK, Lieut. R.N., K.T.S.	31
III. On the Motion of Steam Vessels.—By P. W. BARLOW, Esq., Civil Engineer	40
IV. Time and Traverse Table.—By Captain ROBERT OLIVER, R.N.	78
V. Memoir of Her Majesty's steam ship MEDEA, during a service of nearly four years.—By T. BALDOCK, Lieut. R.N., K.T.S.	80
VI. On the Steam Boats of the United States of America.—By JAMES RENWICK, L.L.D., Professor of Natural Experimental Philosophy and Chemistry in Columbia College, New York	101
VII. On Paddle Wheels.—By ARISTIDES A. MORNAY, Esq.	117
VIII. On the Indicator.—By JOSEPH GLYNN, Esq., C.E., F.R.S.	167
IX. HOWARD'S Method of Vaporisation	171
X. On the General Theory of the Steam Engine.—By the EDITOR	173
XI. Practical Rules for calculating the Steam Engine.—Do.	205
XII. INDEX. By JAMES HANN, Esq., of King's College	233

LIST OF PLATES.

PLATE	EXPLANATION.	PAGE
I.	Isometrical projection of a rectangular steam boiler	328
II.	Two sections of a cylindrical steam boiler	329
III.	Brunton's apparatus for feeding furnaces by machinery	330
IV.	High pressure engine with four-passaged cock	331
V.	Section of a double acting condensing engine for working expansively	332
VI.	Section of a common atmospheric engine	333
VII.	Represents the construction of pistons	334
VIII.	Parts of Fenton and Murray's double engine	335
IX.	Apparatus for opening and closing steam passages	337
X. (A). x. (B).	Parallel motions or combinations used to produce rectilinear motion from motion in a circular arc	338
XI.	Plan and elevation of an atmospheric pumping engine for raising water from a mine	339
XII.	Boulton and Watt's single acting engine	340
XIII.	Double acting engine for raising water	341
XIV.	————— for impelling machinery, by Fenton, Murray & Co.	342
XV.	Maudslay's portable engine	343
XVI.	Indicator for measuring the force of steam in the cylinder	345
—	Diagrams to illustrate the comparative stability of opposite classes of vessels	<i>ibid</i>
XVII.	Section of a steam vessel with its boiler in two parts	346

LIST OF PLATES.

xvii

PLATE	EXPLANATION.	PAGE
xviii.	Isometrical projection of a steam boat engine as first arranged by Boulton and Watt	347
xix.	Section and plan of steam boat engine	349
xx.	Side elevation and cross section of a steam carriage	350
xxi.	Kingston's valves	353
—	blow off valves	<i>ibid</i>
—	injection valves	<i>ibid</i>
—	hand pump valves	354
xxii.	Boilers of H. M. steam vessel African	355
xxiii.	Boilers of H. M. steam frigate Medea	<i>ibid</i>
xxiv.	Paddle wheels of Morgan and Seaward	357
xxv.	Positions of a float of a radiating wheel, and also of a vertical acting wheel, in a vessel in motion	<i>ibid</i>
xxvi.	Cycloidal paddle wheel fitted to the Great Western	<i>ibid</i>
xxvii., xxviii.	Illustrate Capt. Oliver's paper	358
xxix.	Exhibits the various situations of a trial at sailing of the Medea, with the Caledonia, Vanguard, and Asia	<i>Appendix</i> 100
xxx.	Side view of the engines of the Red Rover, and City of Canterbury, steam vessels	358
xxxi.	Longitudinal section of ditto	359
xxxii.	Cross section of engines of ditto	360
xxxiii.	Side elevation of the engine of the Nile steam ship	361
xxxiv.	Plan of the engine of the Nile	<i>ibid</i>
xxxv., xxxvi.	Cross sections of engines of the Nile	362
xxxvii., xxxviii., xxxix.	Engines of H. M. steam frigate Phœnix	363
xl.	Engines of the Ruby Gravesend packet	364
xli.	Section of one of the engines of the Don Juan Peninsula Company's packet	368
xlvi.	Boilers of H. M. ships Hermes, Spitfire, and Firefly	<i>ibid</i>

PLATE	EXPLANATION.	PAGE
XLIII., XLIV., XLV., XLVI.	Elevation, plan, and two sections of the engines of the armed Russian steam ships Jason and Colchis	369
XLVII., XLVIII.	Hall's improvements on steam engines	370
XLIX., L.	Engines of H. M. steam ship Megæra	378
LI., LII., LIII., LIV.	Engines of the Hull and London packet William Wilberforce	382
LV. (A).	Longitudinal section of Humphrys's patent marine engine	390
LV. (B).	Longitudinal elevation of Humphrys's marine engine	391
LVI. (A).	Midship section of the steam packet Dartford, showing a front elevation of a pair of Humphrys's engines	<i>ibid</i>
LVI. (B).	Plan of the engines of the Dartford	392
LVII., LVIII., LIX.	Forty-five-horse power engine, constructed by W. Fairbairn and Co.	<i>ibid</i>
LX., LXI., LXII., LXIII.	Ten-horse power engine, constructed by W. Fairbairn and Co.	393
LXIV.	Elevation of a locomotive engine, Stanhope and Tyne Railway ; constructed by Messrs. R. Stephenson and Co., of Newcastle-upon-Tyne	394
LXV.	Section of ditto	396
LXVI.	Safety valves of ditto	<i>ibid</i>
LXVII. (A).	Cylinder cover and connecting rods of ditto	397
LXVII. (B).	Cylinder and piston at large of ditto	398
LXVIII.	Plan and section of boiler seating for a twenty-horse engine, at the manufactory of Messrs. Whitworth and Co., Manchester	399
LXIX.	Messrs. Hague's double acting cylinder, with slides, &c.	<i>ibid</i>
LXX. (A). LXX. (B).	Sections of the engines of the Berenice steam vessel	400
LXXI., LXXII.	Beale's patent rotatory engine	401
LXXIII.	Mr. Ayre's contrivance for preventing a locomotive engine from running off a railway	403
LXXIV. to LXXXIII.	Relate to Mr. Mornay's paper on paddle wheels	<i>Appendix</i> 117
LXXXIV. to LXXXVIII.	Sixty-five inch cylinder engine, erected by Messrs. Maudslay, Sons and Field, at Chelsea water-works	404

LIST OF PLATES.

xix

PLATE	EXPLANATION.	PAGE
LXXXIX. to XCII.	Patent locomotive engine, made by Messrs. R. Stephenson and	
	Co. for the London and Birmingham Railway	407
XCIII.	Drawings of the Comet, the first steam boat in Europe	470
XCIV.	The Pacha's steam vessel of war, the Nile	471
XCv., xcvi.	The Hon. East India Company's steam vessel Berenice	<i>ibid</i>
xcvii.	Draught of the Forbes steamer, Chinese rigged	473
xcviii.	Herne Bay steam packet Red Rover	474
xcix.	Diamond Company's steam packet Ruby	475
c. to ciii.	Her Majesty's steam vessel of war Medea	477
civ. to cvii.	Construction of the Nile steam ship, built for the Pacha of Egypt	483
cviii., cix., cx.	His Imperial Majesty's armed steam vessel Colchis	492
cxl., cxl. (A).	Engines of the steam ship Tiger	497
cxlii.	The Admiralty yacht Firebrand	498
cxliii.	Portrait of the late Mr. Watt	500
cxliv.	Portrait of the late Mr. Tredgold	<i>ibid</i>
cxv., cxvii., cxviii.	Illustrate the state of steam navigation in America	<i>ibid</i>

cxliii

cxliii
not published



MEASURES, WEIGHTS, &c. USED IN THIS WORK.

Temperature is measured by degrees of Fahrenheit's scale, of which the freezing point is 32°, and the boiling point 212°.

Heat is commonly measured by the number of degrees it would increase the temperature of a given quantity of water at 60°, with the barometer at 30 inches.¹

Mechanical power is measured by the elementary horse power, as settled by Watt. A horse power is = 33,000 lbs. raised one foot high per minute, or = 550 lbs. raised one foot high per second ; and a day's work of a horse is this power acting 8 hours.

This horse power is, in French measures, 4661 kilogrammes raised one metre high per minute.

The pound is the avoirdupois pound, = 7000 troy grains, = .4535 French kilogrammes.

The foot is = .3048 French metre.

An atmosphere is = $\left\{ \begin{array}{l} 30 \text{ inches} \\ .762 \text{ metre} \end{array} \right\}$ of mercury.
= 14.70 lbs. per square inch.
= 11.55 „ circular „

¹ It is more properly measured by the volume of water at 60°, which it would raise exactly one degree ; this measurement being strictly proportional to the absolute quantity of heat.—Ed.

THE STEAM ENGINE.

SECTION I.

AN ACCOUNT OF THE INVENTION AND PROGRESSIVE IMPROVEMENT OF THE STEAM ENGINE.

ART. 1. WHEN an efficient mechanical power is produced by the generation, or generation and condensation, of the steam or vapour of any liquid, the combination of vessels and machinery for that purpose is called a Steam Engine. This engine was for a considerable time after its invention called a Fire Engine, and not improperly, for the active agent is heat or fire. The liquid almost universally employed for obtaining steam is water, but it may be obtained from alcohol, ether, and other fluids; fortunately, however, water, the most easily procured, is equal if not superior to any other.

2. That the application of heat would generate steam from water, and that the steam so generated would issue with much force from a small aperture in the vessel employed to generate it in, must have been known at a very early period. The eolipile, and some other similar instruments for illustrating natural phenomena, were well known among the Egyptians, Greeks, and Romans. Vitruvius, who wrote during the reign of Augustus Cæsar, refers to the eolipile as an illustration of the effect of heat in producing winds;¹ but he clearly had no idea of steam being rendered useful as a mechanical power. Philibert de l'Orme proposed placing an eolipile over a fire as a means of impelling smoke up a chimney,² and several applications of this instrument are described in the works of Solomon de Caus, Brancas, Van Drebbel, and various other writers, the greater part of whom are mentioned by M. Montgéry,³ an author who has been at considerable trouble to show that the invention of the steam engine is not of English origin.

3. But unless it be shown that an engine had been actually invented, and was undoubtedly applicable to some of the purposes for which the steam engine is now

¹ Vitruvius, lib. i. cap. vi.

² Traité d'Architecture, folio, Paris, 1567.

³ Notice Historique sur l'Invention des Machines à Vapeur.

employed, and for which alone it has become valuable, it appears to be mere trifling to search for authorities, and absolutely unworthy of occupying the time or attention of a man of real science. The blast of an eolipile is certainly not a mode of employing steam capable of producing the species of useful effect which is obtained by a steam engine, and, as a proof of its inefficiency, the same principle of action (that is, by impulse) has never been rendered applicable to produce mechanical power for useful purposes in a steam engine.

It is not my object, therefore, to inquire when it was first ascertained that steam has force; but, to endeavour to trace the history of its suggestion in a practical form, and of its employment in the arts and manufactures; to develop the various changes and improvements the steam engine has received; and to exhibit, among the host of projectors, those who have really advanced our knowledge, either regarding the principles, the construction, or the arrangement of this powerful prime mover.

It is easy to perceive that I have assigned myself a difficult task, but it is equally evident that if it be accomplished in a judicious and candid manner, it will form a valuable addition to an interesting and useful branch of mechanical science; hence, I am encouraged to proceed, and trust to leave my reader with an impression, that I have been just in deciding between the claimants of the invention of each of the parts of the steam engine.

1663. MARQUIS of WORCESTER, died 1667.

4. The idea of employing the impulsive force of the eolipile seems to be the only one which had been formed for using steam as a source of motion before the time of the Marquis of Worcester; and he, in a little work entitled ‘A Century of the Names and Scantlings of Inventions,’ undoubtedly describes a method of employing the pressure of steam for raising water to great heights.¹ His work was first published in 1663, and under the sixty-eighth invention we have the following name and scantling:—

“LXVIII. *A Fire Water Work.*—An admirable and most forcible way to drive up water by fire, not by drawing or sucking it upwards; for that must be, as the philosopher calleth it, *infra sphaeram activitatis*, which is but at such a distance. But this way hath no bounder if the vessels be strong enough; for I have taken a piece of a whole cannon, whereof the end was burst, and filled it three-quarters full of water, stopping and screwing up the broken end, as also the touchhole, and,

¹ Another engine, which the marquis terms a “Water-commanding Engine,” seems to have been the one for which he obtained an act of parliament, allowing him the monopoly of the profits arising from its use.

making a constant fire under it; within twenty-four hours it burst and made a great crack; so that having a way to make my vessels so that they are strengthened by the force within them, and the one to fill after the other, I have seen the water run like a constant fountain stream forty feet high. One vessel of water rarefied by fire driveth up forty of cold water. And a man that tends the work is but to turn two cocks, that, one vessel of water being consumed, another begins to force and refill with cold water, and so successively, the fire being tended and kept constant; which the selfsame person may likewise abundantly perform in the interim between the necessity of turning the said cocks."

This description puts it beyond a doubt that the Marquis of Worcester knew that steam, heated in a close vessel, acquires an immense degree of force, and that this force could be effectivly applied to raise water. The effect of condensation he does not appear to have been at all acquainted with, and therefore his mode of operation must have been exceedingly simple, and probably, of the nature exhibited in the annexed figure:—where B is the boiler; C, one of the vessels with a pipe to deliver the water to an elevated cistern D.

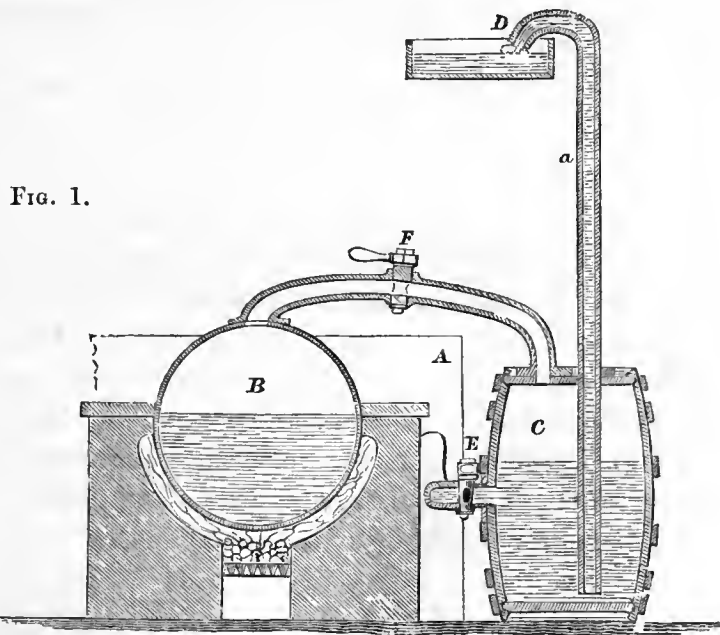

Now suppose the vessel C to be supplied from a cistern of cold water A by a pipe, so that it would be filled on opening the cock E, and afterwards closing it; if, when the steam in the boiler is of sufficient strength, the cock F be opened, the pressure of the steam on the water in C would cause it to ascend from C, through the pipe *a* into the cistern D. The vessel C being emptied, and the cock F being shut, it would refill with water on again opening the cock E. Another vessel C, and its cocks and

pipes, are necessary to complete the species of water engine indicated by the description, and these may be on the other side of the boiler.

Such a mode of raising water would be most expensive from the quantity of condensation when the steam came in contact with cold water, but it was fully capable of producing the quantity of effect mentioned, for it is only equivalent to raising 20 cubic feet of water or 1250 lbs. one foot high by one pound of coal, or about the 200th part of the effect of a good steam engine. Hence, it appears, that to the Marquis of Worcester must be ascribed the first invention and trial of a practical mode of applying steam as a prime mover, and of applying it to one of those great purposes for which it has been so useful to society.

1683. SIR SAMUEL MORLAND, died 1695.

5. From a part of a manuscript in the Harleian collection in the British Museum, it appears that a mode of raising water by steam, similar to that of the Marquis of Worcester's, was proposed, among other methods, to Louis XIV. of France, by Sir Samuel Morland. It contains no description of the method he intended to employ, but there is sufficient to indicate that its author was not without knowledge of his subject.

The title of the part which treats of the power of steam is, 'The Principles of the New Force of Fire, invented by Chev. Morland in 1682, and presented to his most Christian Majesty in 1683;' and these principles are explained as follows:— "Water being converted into vapour by the force of fire, these vapours shortly require a greater space (about 2000 times) than the water before occupied, and, sooner than be constantly confined, would split a piece of cannon. But being duly regulated according to the rules of statics, and by science reduced to measure, weight, and balance, then they bear their load peaceably (like good horses) and thus become of great use to mankind, particularly for raising water, according to the following table, which shews the number of pounds that may be raised 1800 times per hour, to a height of six inches, by cylinders half filled with water, as well as the different diameters and depths of the said cylinders."

Cylinders.		Weight of the Load to be raised, in pounds.
Diam. in feet.	Depth in feet.	
1	2	15
2	4	120
3	6	405
4	8	960
5	10	1875
6	12	3240

These numbers are obviously proportional to the capacity of the cylinders.

The table is continued in the original to show the effect of a number of cylinders of the largest of the above sizes, each one being capable of raising 3240 lbs.

Morland has given the increase of volume, which water occupies in the state of vapour, at common pressures, so nearly, that we may suppose it to be the result of experiment; while his allusion to the force of steam being sufficient to burst a cannon, and his proposal of the method to a foreign prince, render it probable that he was not a stranger to the volume the Marquis of Worcester had published twenty years before.

Morland's researches seem to have had little influence on the progress of the practical application of steam.

6. In 1695, Dr. Papin suggested the idea of employing the expansion and contraction of steam to form a partial vacuum under a piston for raising water, and making the pressure of the atmosphere on the upper side of the piston the moving power.¹ The real authors of the atmospheric engine were very likely indebted to this suggestion; but neither Papin himself, nor his rival Savery, discovered how to turn this suggestion to advantage. Indeed, it was proposed in a form which was not practicable: the fire was to be alternately applied to, and removed from, the cylinder, and the expansion of the water in it, by heat, was to raise the piston, and its contraction, by cooling, when the fire was removed, was to cause a partial vacuum, and, consequently, the descent of the piston was to be produced by the pressure of the atmosphere. If such a scheme was ever tried, the result must have been sufficiently discouraging for Papin to abandon it, and adopt a new one, which it will be found he actually did, after seeing an engraving of Savery's engine.

1698. THOMAS SAVERY.

7. These projects were speedily followed by a direct practical application of the steam engine to raising water, for which "letters patent" were granted to Captain Thomas Savery, in July, 1698, (these being the first on record granted for a steam engine); and, Dr. Robison says, it was "after having actually erected several machines," of which Savery gave a description in a pamphlet he published in 1699,² called 'The Miner's Friend,' which was republished with additions in 1702.

In June, 1699, Captain Savery exhibited a model of his engine before the Royal Society; and the experiments he made with it succeeded to their satisfaction.³ It

¹ Phil. Trans. Abridg. iv. 155. 1697.

² Robison makes it 1696, but this does not appear to be correct. Switzen's date, 1699, is taken as likely to be the right one, from his System of Hydrostatics, ii. 326.

³ Phil. Trans. Abridg. iv. 198. 1699.

consisted of a furnace and boiler B ; from the latter two pipes, provided with cocks C, proceeded to two steam vessels S, which had branch pipes from a descending

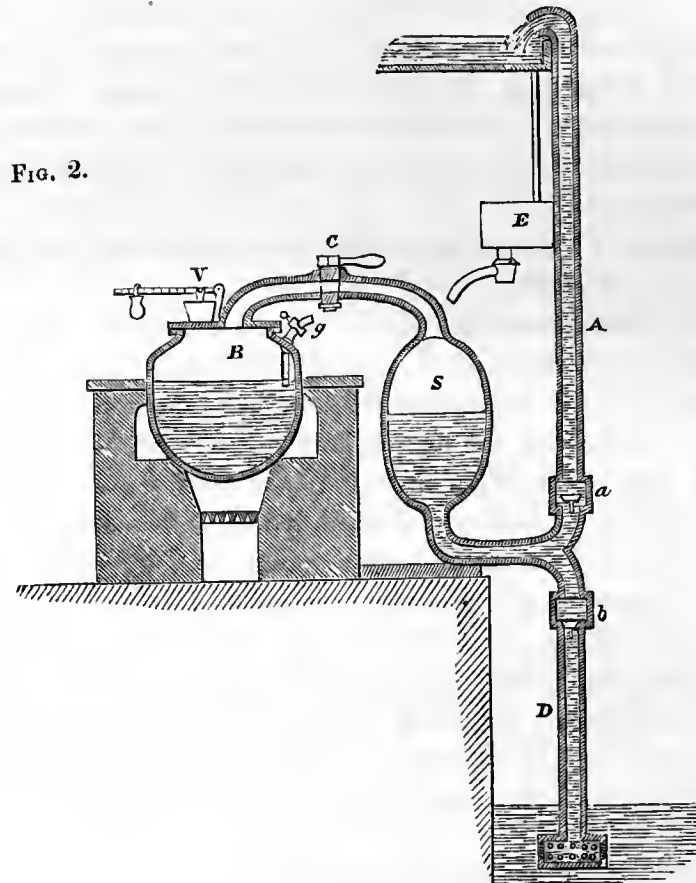

main D, and also to a rising main pipe A ; each pair of branch pipes had valves *a*, *b*, to prevent the descent of the water raised by the condensation or by the force of steam. Only one vessel, S, is shown, the other being immediately behind it. One of the steam vessels being filled with steam, condensation was produced by projecting cold water, from a small cistern E, against the vessel ; and into the partial vacuum made by that means, the water, by the pressure of the atmosphere, was forced up the descending main D, from a depth of about twenty feet ; and, on the steam being let into the vessels again, the valve *b* closed, and prevented the descent of the water, while the steam having acquired force in the boiler, its pressure caused the water to raise the valve *a*, and ascend to a height proportional to the excess of the elastic force of the steam above the pressure of the air.

Captain Savery afterwards simplified this engine considerably, by using only one

steam vessel. To prevent the risk of bursting the boiler, he applied the steelyard safety valve *V*; invented by Papin for his digester. The cocks were managed by hand; and, to supply the boiler with water, he had a small boiler adjoining to heat water for the use of the large one, and thus prevent the loss of time which must have occurred on refilling it with cold water.

Several engines for raising water appear to have been erected according to Savery's plan, and to have succeeded tolerably where the water had not to be raised more than forty feet; but this was not sufficient for mines, where a new and powerful machine was most wanted.

The new principles, introduced into the steam engine by Savery, consist of the use of condensation in the steam vessel by cold applied externally. He also used a method of supplying the boiler with hot water, contrived a mode of ascertaining the quantity of water in the boiler, by inserting the cock *g*, called a gauge cock, and applied the safety valve of Papin's digester as a means of preventing accidents.

The defects of his engine are obvious. A cold vessel and cold fluid must at each operation condense, and therefore waste a great quantity of steam; and the height to which water could be raised, unless by the use of such powerful steam as to render it dangerous, was too limited to be applicable to mining purposes. Its effect would however be vastly superior to that of the Marquis of Worcester's. Whether Captain Savery did or did not know of the previous schemes, his claims to original invention are certainly considerable; and to his enthusiasm and talent we undoubtedly owe the first effective steam engine.

1698. DR. DENNIS PAPIN.

8. Dr. Papin, professor of mathematics at Marbourg, whose former project I have noticed (art. 6), is said to have made many experiments on raising water by the force of fire, in 1698, by the order of Charles, Landgrave of Hesse; and in 1707 he published a small treatise on the subject, in which he ascribes to the landgrave the whole merit of the first idea of a steam engine. Papin's trials in 1698, whatever they were, did not end in producing any thing in a useful shape; and, while he candidly acknowledges that Savery's scheme was not borrowed from any thing done in Germany, it appears that he did not follow up his experiments till after he had seen an engraving of Savery's engine, in June, 1705; a pretty conclusive argument, that no satisfactory results had been arrived at in these experiments; and there is a wide distinction between unsuccessful experiments and invention.

To do justice to the claims of Papin, it will be sufficient to describe his engine in its most improved state, and as he gives it after knowing what Savery had

effected. It consisted of a boiler B, provided with a safety valve V; and a cylinder G H, connected to the boiler by a steam pipe S. The cylinder was closed at the

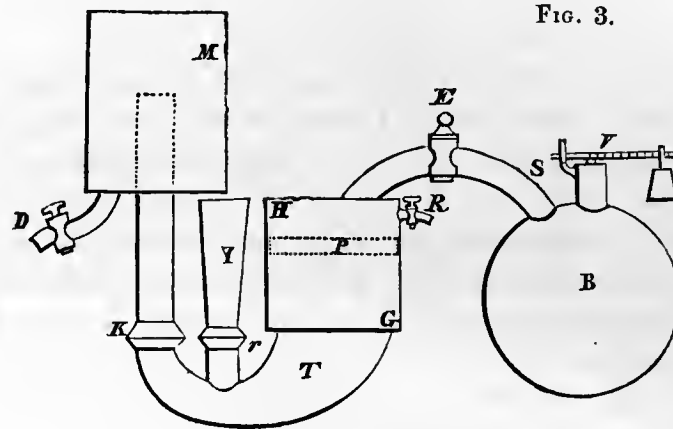

top, and contained a floating piston P; and the base of the cylinder terminated in a curved tube T, which ascended into a cylinder M; the bent tube had a pipe Y, from a reservoir of water communicating with it, and it was provided with a valve at *r*. Now suppose the cylinder G H, to be filled with cold water by the pipe Y, from the reservoir, and the boiler to contain strong steam; by opening the cock E, the steam would be admitted, and, pressing on the floating piston P, cause the water to ascend into the cylinder M: its return is prevented by the valve K, and the steam cock E being shut, and the cock R opened, to let the condensed steam escape at the pipe R, the water from the reservoir refills the steam cylinder through the pipe Y, and it is ready for repeating the operation. The water raised to be directed to any useful object by the pipe D.¹

A reference to the Marquis of Worcester's plan will show, that Papin did no more than repeat his experiments. The scheme of adding to the effect by the introduction of red hot irons into the cylinder G H, is too absurd to insert; but it is in some measure redeemed by the suggestion, that the water raised by the engine might be applied to drive a water wheel; thus giving the idea of a steam engine being applicable to impel machinery.

9. In 1699, Mr. Amontons published a description of a machine, designed to be moved by the spring of air when expanded by heat, and afterwards condensed by contact with cold water.² The continual access of heated air to water would

¹ Belidor's *Archi. Hydraul.* ii. p. 328.

² Prony's *Nouvelle Archi. Hydraul.* ii. p. 89 (note), where it is described.

ultimately render the air saturated with vapour; but even then it would not be more than an air engine, and a very indifferent one, being exceedingly complex.

1705. THOMAS NEWCOMEN.

10. The trials of Savery's engines made known their defects, yet evidently strengthened the idea that steam could be effectively applied to raise water; and the immense expense of raising water from deep mines so embarrassed their proprietors, that there were most powerful incentives at that period to engage in further researches on the subject. To this stimulus we are indebted for another construction of the steam engine, by Thomas Newcomen, a smith, of Dartmouth, who, in conjunction with John Cawley, a plumber of the same place, and Captain Savery, obtained letters patent for the invention in 1705.¹ The novelty of this construction consists entirely in condensing the steam below an air-tight piston, in a cylindrical vessel having an open top; and the idea was very probably taken from the project of Papin in 1695 (see art. 6); for it appears that Newcomen was in correspondence with Dr. Hook on the subject, to whom the speculations of Papin were well known; but the mode of effecting the object was entirely different from Papin's. It consists in admitting steam below a piston; and, at first, the steam was condensed by applying cold water to the outside of the cylinder; but injection of cold water by a jet into the interior was soon found to be a more effective method, and is said to have been discovered by accident.² The following is a description of the engine, as far as it was improved by Newcomen. B represents the boiler with its furnace for producing steam; and at a small height above the boiler is a steam cylinder, C, of metal, bored to a regular diameter, and closed at the bottom, the top remaining open. A communication is formed between the boiler and the bottom of the cylinder, by means of a short steam pipe, S. The lower aperture of this pipe is shut by the plate *p*, which is ground flat, so as to apply very accurately to the whole circumference of the orifice. This plate is called the regulator, or steam cock, and it turns horizontally on an axis *a*, which passes through the top of the boiler, and is fitted steam-tight; and has a handle to open and shut it.

¹ Switzer says, on report, that Newcomen was as early in his invention as Savery. *Sys. of Hydros.* ii. 342.

² Desaguliers' *Experimental Philosophy*, ii. p. 533. The piston was kept tight by a quantity of water on the top of it; and as they were working by condensing from the outside, they were surprised to see the engine make several strokes very quickly, and found that it was owing to a hole in the piston letting down water to condense the steam. This suggested the idea of injection.

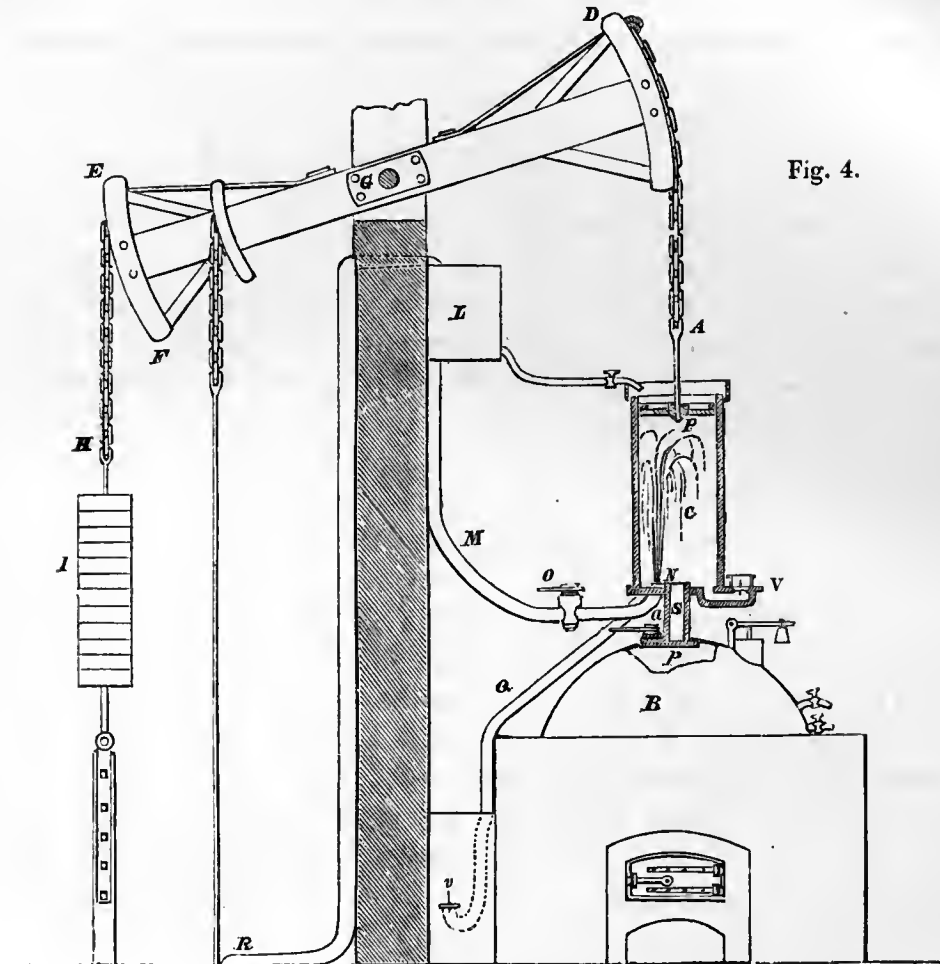

Fig. 4.

A piston P is fitted to the cylinder, and rendered air-tight by a packing, round its edge, of soft rope well filled with tallow to reduce the friction, and its upper surface is kept covered with water to render it steam-tight. The piston is connected to a rod P A, which is suspended by a chain from the upper extremity D of the arched head of the lever, or working beam, which turns on the gudgeon G. This beam has a similar arched head E F, at its other end, for the pump rod H, which receives the water from the mine. The end of the beam to which the pump rod is attached, is made to exceed the weight and friction of the piston in the steam cylinder; and when the water is drawn from such a depth, that the steam piston is too heavy for this purpose, counterpoise weights must be added at I, till the piston will rise in the steam cylinder at the proper speed. At some height above the top of the cylinder is a cistern L, called the injection cistern, supplied with water from

the forcing pump R. From this descends the injection pipe M, which enters the cylinder through its bottom, and terminates in one or more small holes at N. This pipe has at O a cock, called the injection cock, fitted with a handle. At the opposite side of the cylinder, a little above its bottom, there is a lateral pipe, turning upwards at the extremity, and provided with a valve at V, called the snifting valve, which has a little dish round it to hold water for keeping it air-tight.

There proceeds also from the bottom of the cylinder a pipe Q, of which the lower end is turned upwards, and is covered with a valve *v*: this part is immersed in a cistern of water called the hot well, and the pipe itself is called the eduction pipe. To regulate the strength of the steam in the boiler, it is furnished with a safety valve, constructed and used in the same manner as that of Savery's engine, but not loaded with more than one or two pounds on the square inch.

The mode of operation remains to be described. Let the piston be pulled down to the bottom of the steam cylinder, and shut the regulator or steam valve *p*. Then the piston will be kept at the bottom by the pressure of the atmosphere. Apply the fire to the boiler till the steam escapes from the safety valve, and then, on opening the steam regulator, the piston will rise by the joint effect of the strength of the steam, and action of the excess of weight on the other end of the beam. When it arrives at the top of the cylinder, close the regulator *p*, and, by turning the injection cock O, admit a jet of cold water, which condenses the steam in the cylinder, forming a partial vacuum, and the piston descends by the pressure of the atmosphere, raising water by the pump rod H from the mine. The air which the steam and the injection water contain, is impelled out of the snifting valve V, by the force of descent, and the injection water flows out at the eduction pipe Q; and by repetition of the operations of alternately admitting steam and injecting water, the work of raising water is effected.

These operations were done by hand, till a boy, named Humphrey Potter, contrived to attach strings and catches to the working beam, for opening and shutting them while he was at play;¹ after which, more permanent appendages were added to answer the purpose, and the engine became a step nearer to a self-regulating machine.

The engine in this simple and efficient state was termed the Atmospheric Engine. It was brought to this degree of perfection about 1712; and such engines were erected in various places.

The novelty of this engine is chiefly in its mechanism; but as this mechanism produces all the difference between an efficient and an inefficient engine, I am

¹ Desaguliers' *Experimental Philosophy*, ii. 533.

inclined to set a higher value upon it than on the fortuitous discovery of a new principle. To point out what is actually due to Newcomen would be difficult, and for want of evidence we must be content with examining the state of the engine. The admission of steam below an air-tight piston, attached to the impelled point of a lever properly counterpoised; its rapid condensation by injection of water, which is essential to gain effect; and the mode of clearing the cylinder of air and water after the stroke, are all additional to the principles and mechanism before in use; and these are wholly due to Newcomen, or those connected with him.

1718. HENRY BEIGHTON, F.R.S.;¹ died 1743.

11. The arrangement of the parts of the atmospheric engine, the mode of fixing, and the mechanism for opening and shutting the valves, were greatly improved by Mr. Henry Beighton, an engineer, of Newcastle-upon-Tyne. He also seems to have been the first to reduce the calculation of the powers of engines to a regular system, and published a 'Table of the Dimensions and Power of the Steam Engine,' in 1717, which has been found to accord with practice;² and he directed the construction of several large engines. He also remarked the fact of steam heating a very large proportion of water in condensing, and communicated to Dr. Desaguliers some experiments on the bulk of steam formed by a given quantity of water, the result of which was erroneously stated, in consequence of a singular mistake in the calculation; and it is also obvious, that the mere quantity of water, and bulk of the cylinder, could not possibly give the result he expected, even on the supposition that the cylinder was maintained at 212° during the experiment.³ I cannot leave the memory of Beighton without the remark, that

¹ Dr. Hutton remarks, it is probable that Mr. Beighton died in 1743 or 1744, as it appears that he conducted the Ladies' Diary for the Stationers' Company, from 1714 to 1744 inclusively; discharging that trust with such satisfaction to the Company, that they permitted his widow to enjoy it for many years afterward, by employing a deputy to compile that very useful annual little book. In that almanack, for the year 1721, Mr. Beighton inserted a curious table of calculations on the steam engine. Phil. Trans. Abrid. vii. p. 442.

² Desaguliers' Course of Experimental Philosophy, ii. 534.

³ In Mr. Beighton's experiment (Desaguliers' Ex. Phil. ii. 533.) made on the steam engine, to know what quantity of steam a given quantity of water produces, he found by several trials with a divided steelyard on the safety valve on the top of the boilers at Griff and Wasington, that when the elasticity of the steam was just one pound on a square inch, it was sufficient to work the engine; and that about 5 pints in a minute would feed the boiler, as fast as it was consumed in producing steam for the cylinder at 16 strokes per minute. Griff's cylinder held 113 gallons of steam every stroke; hence $113 \times 16 = 1808$ gallons = 14464 pints; therefore 5 pints of water produced 14464 pints of steam; consequently, 1 pint would produce 2893 pints of steam of that

though he was not distinguished by the novelty of his views, yet the sound knowledge he had of science seems to have been of more real advantage to those who sought benefit from the steam engine, than the undirected efforts of his predecessors.

1720. LEUPOLD.

12. About this period various writers gave notices of the different engines that had appeared; but those who added nothing, either in theory, experiment, or construction, it would be as tedious as useless to notice. But in this class, Leupold, the industrious German collector of mechanical inventions, ought not to be placed, he having given the first sketch for a high-pressure engine with a piston; it is further remarkable as having a four-passage cock for the admission and emission of steam.

The scheme of Leupold is simple: over a boiler *B*, he placed two cylinders *C C*, fitted with steam-tight pistons, *p p*. A four-way steam-cock, *S*, is placed between

FIG. 5.

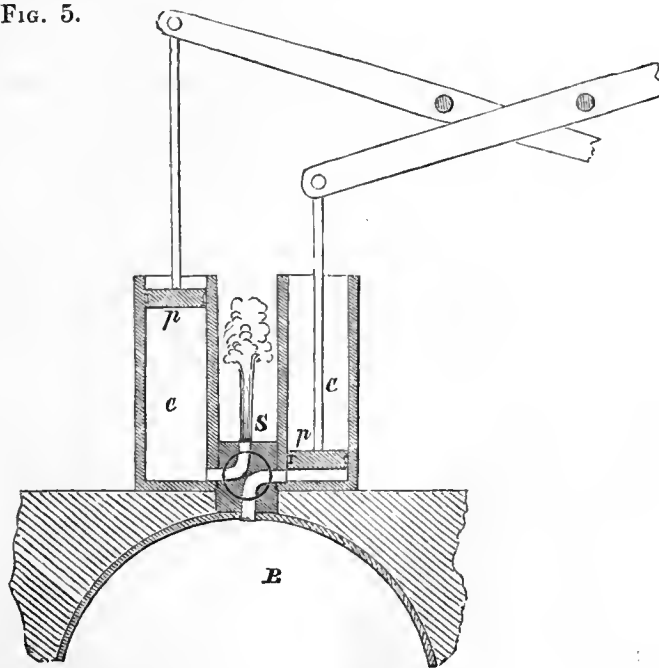

the boiler and cylinders, so as to alternately admit steam into one cylinder, and let it out from the other. The piston, by the admission of strong steam from the

density and temperature which it had in the cylinder at the termination of the stroke; but this temperature and density not being ascertained, the experiment does not show the bulk corresponding to the atmospheric pressure; for the elastic force in the boiler differs considerably from that in the cylinder.

boiler below it, is raised, and depresses the other end of a lever connected to the rod of a plunger of a pump, which causes the water to rise through the pipe, and by the alternate action of the steam in the two cylinders a continual stream of water is raised. Thus the first rude notice of the principle of employing high-pressure steam under a piston was given.

13. It does not appear that any thing was added to the existing knowledge of the steam engine by Dr. Desaguliers, though, from his fondness for experimental philosophy, we are led to expect he would have taken an important place in reducing to fixed principles the phenomena he was daily called upon to witness and make known to the world. This was not the case; and, for historical information, he was evidently too prejudiced in favour of particular individuals to allow him to detail facts with candour and fairness; therefore, the matter he collected, in his 'Experimental Philosophy,' is no further valuable, than by making the state of the engine at that period, and part of the researches of Beighton, known.

1736. JONATHAN HULLS.

14. The atmospherical steam engine, as improved by Beighton, began to be very generally adopted in the coal works and copper mines; and it does not seem to have required any great stretch of invention to direct such an efficient power to other purposes, besides that of raising water.

The first attempt, however, on record, was one to apply steam to navigation, and was made by Jonathan Hulls, who, on the 21st of December, 1736, obtained a patent, for what may strictly be considered a steam boat.

The letters patent, and a description of this boat, illustrated by a plate, was published in a tract, by Hulls, in 1737, under the following title:—'A Description and Draught of a new-invented Machine for carrying Vessels or Ships out of or into any Harbour, Port, or River, against Wind or Tide, or in a Calm.' As the origin of the invention of steam boats has been strongly contested, this pamphlet, which it is now very difficult to obtain on account of its rarity, has been brought forward to prove that Jonathan Hulls was the first person who suggested the power of steam as a means of propelling paddle wheels. His mode of converting the reciprocating motion of the engine into a rotatory one, is less simple than the crank, but it appears to have been the first attempt, and was done in the following manner: Let *a, b, c*, be three wheels on one axis, and *d, e*, two wheels loose on another axis *A*, with ratchets, so as to move the axis only when they move forward; *f, g, h*, are three ropes, and *P* is the piston of the engine. When the

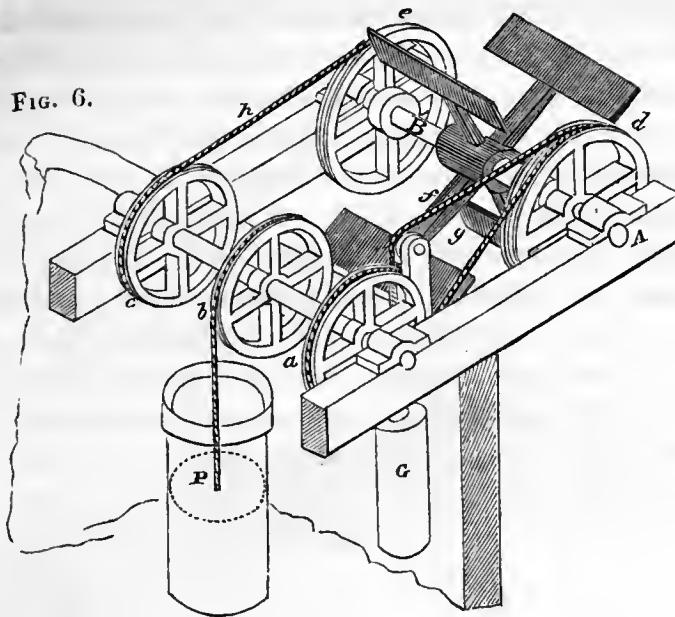

piston descends, the wheels *a*, *b*, *c*, move forward, and the ropes *g*, *h*, cause the wheels *e*, *d*, to move, the wheel *e* forward, and the wheel *d* backward, and the latter raises the weight *G*, which moves the wheel *d* forward during the ascent of the piston; consequently, the axis *A B*, with the paddle wheels, would be constantly moved round in the same direction and by an equable force. This is certainly a beautiful contrivance for rendering so irregular a first mover equable; and, considering the object it was intended for, it is not a complex arrangement; for besides equalizing the power, it gives a means of increasing or diminishing the velocity in the ratios of the diameters of the wheels. The pamphlet of Hulls bears evidence of being the work of an ingenious and well-informed mind; and we must regret the causes which prevented his views meeting the encouragement they merited.¹

1739. BERNARD BELIDOR; born 1698, died 1761.

15. Belidor, so eminently distinguished as a writer on the theory and practice both of civil and military engineering, treated of the steam engine in 1739, and undoubtedly presented the most accurate information then existing in France on the subject.² He gives a slight sketch of its history; and infers, from his inquiries, that the three nations of Europe most advanced in the pursuit of know-

¹ Hulls's pamphlet may be seen at the British Museum or the London Institution; and many civil engineers have succeeded in adding it to their own collections.

² *Architecture Hydraulique*, tom. ii. p. 300—331.

ledge, each furnished a man of science to participate in the glory of the important discovery: that Papin in Germany, Savery in England, and Amontons in France, were each occupied in studying the means of making use of the action of *fire* for moving machines; but the first suggestion of the idea, in an intelligible form, he acknowledges to be due to the Marquis of Worcester. Belidor closes his historical notice, by remarking, that all the fire engines that had been constructed out of Great Britain, had been executed by English workmen; and then proceeds to describe the atmospheric engine at Fresnes, near Condé, in that minute, clear, and practical manner, which renders his writings so valuable. To the theory of the action of steam Belidor added nothing; and the formulæ he has given for calculating the load to be lifted by an engine are neither very simple nor accurate: like those of Beighton, they apply only to the statical equilibrium of the machine.

1741. JOHN PAYNE.

16. The first direct experiment to determine the density of steam was made by John Payne.¹ His process was well devised, but wanted the addition of a thermometer. He took a copper globe twelve inches in diameter, having two cocks fitted to it, and a small valve. The vessel thus prepared was hung over a large vessel, in which water was rarefied into steam, and by a pipe the steam was admitted at one of the cocks into the globe, and the other being also open, the steam being allowed to blow through, forced out the air that was in the globe, and supplied its place; when both cocks were suddenly shut, and the globe taken down and hung over a vessel of cold water with the lower cock immersed in water. The cock was opened under water, on which the water rushed violently into the globe till it had supplied the vacuum, when the cock was again shut, and the globe, with the water, was put in the scales, and found to weigh 713 oz., which taken from 727 oz. the whole weight before, there remains only 14 oz. for the difference; from which he inferred that all the air was nearly excluded out of the globe by the steam. He again excluded the air out of the globe with steam as before, and both the cocks being closed, with the globe full of steam, he put the globe in the scales, and it weighed 202·5 oz. He then opened one of the cocks and let in the air, and by adding weight in the other scale it was found to weigh 203 oz., which showed that the weight of the air the globe contained was ·5 oz. or 218·75 grains. The globe being filled with steam as before, and condensed with cold water on the outside of the globe, and the metal again made very dry, and the air let into the globe, the water from the condensed steam was found to weigh 96 grains. It is worthy of remark here, that this gives the density

¹ Phil. Trans. vol. xli. p. 821. or Ab. vol. viii. p. 518.

of steam at 212° to that of air at 60° , as 96 : 218.75, or as 0.44 : 1. The true density of steam at 212° is nearly as 0.48 : 1.

The globe was filled with steam as before ; only, not knowing the effect of temperature, he continued the globe longer with the steam passing through it, by which it acquired a greater degree of heat ; for he found by these experiments, that the least degree of cold less than the steam would condense a part of it again into water, and hence the quantity could not be ascertained which would exclude the air out of a given space, which was the chief end of the experiment. In this experiment he succeeded in excluding the air with less steam ; for, on weighing the globe, when the steam was condensed, the air let in, and all cold, it was found that the weight of the water condensed from the steam was only about forty-eight grains, which filled, when converted into steam, 925 cubic inches of space, so as to exclude nearly all the air. From which he concluded that one cubic inch of water will form 4000 inches of steam. To admit of comparison, the temperature should have been observed, as I have little doubt that the steam was so rarefied by heat as to cause this result.

17. Mr. Payne also attempted to introduce a new mode of generating steam ; his apparatus consisted of a cast iron vessel of the figure of a frustrum of a cone, its diameter at the bottom being four feet, with a semi-globular end of copper of about five feet and a half diameter. In the inside a small vessel was inserted, which Payne calls a *dispenser*, which vessel had pipes round the sides fixed to it ; the bottom rested on a central pin, on which it revolved, so as to spread the water it received from above, through an iron pipe. The end of this pipe passed up through the head, and was enclosed very tightly, but so as to be easily moved with a circular motion, so that the water might be dispersed or showered round on the sides of the red hot cone, or ignited vessel, in a very exact manner. From experiment he states that a pot or vessel, of the size and shape here mentioned, will, being kept to a dark red heat and the water regularly dispersed, convert 6.5 cubic feet of water into steam in an hour. And that, by experiments made at Wednesbury and Newcastle-upon-Tyne, 112 lbs. of pit coal will by this method convert twelve cubic feet of water into steam. This is near the truth of what may be done ; but the method has no advantages, and the apparatus soon fails. It is a duty, however, to an ingenious man to record his attempts to establish useful truths, even when he fails in his object : it shows the state of knowledge at the time on these subjects ; and it saves others from repeating useless experiments. The mode of generating steam, just described, has been more than once revived lately.¹

18. The engine of Savery had hitherto required the attendance of a person

¹ [This is the recorded opinion of Tredgold. Since his time, however, Mr. Howard has adopted a similar principle with success, an account of which is given in the Appendix.—ED.]

to open and shut the cocks. This defect appears to have been first removed by Gensanne, a Frenchman, who contrived a self-acting apparatus for the purpose in 1744; and afterwards De Moura, a Portuguese, sent a model of another method to the Royal Society, which is ably described by Smeaton, in the Transactions for 1751.¹ His general description is sufficient for the purpose of showing how the action is obtained. The engine consists of a receiver with a steam and an injection cock. It has a suction and a forcing pipe, each furnished with a valve, and a boiler, which may be of the common globular shape. Having nothing particular in its construction, a description of it will not be necessary: also the rest of the parts already mentioned being essential to every machine of this kind, a further account of them may be dispensed with. What is peculiar to this engine is a float within the receiver, composed of a light ball of copper, which is not loose in it, but fastened to the end of an arm made to rise and fall by the float, while the other end of the arm is fastened to an axis; and, consequently, as the float moves up and down, the axis is turned round one way or the other. The axis is made conical, and passes through a conical socket, which last is fixed to the side of the receiver. On one of the ends of the axis, which projects beyond the socket, is fitted a second arm, which is also moved backwards and forwards by the axis as the float rises or falls. By these means, the rising or falling of the surface of the water within the receiver communicates a corresponding motion to the outside, in order to give the proper motions to the rest of the apparatus which regulates the opening and shutting of the steam and injection cocks, and serves the same purpose as the plug frames, &c. in Newcomen's engine.

1751. FRANCIS BLAKE, F.R.S.

19. A paper on the best proportions for steam engine cylinders, by Mr. Francis Blake, was published in 1751;² which merits attention both as one of the first steps in theoretical inquiry respecting the proportions of engines, and on account of the result he obtained. It is evident, he remarks, from the principles of mechanics, that the contents of the cylinder remaining the same, the quantity of water discharged at each lift will in all cases be equal; and this equality is obtained by only adjusting the distance of the centre of the piston from the fulcrum of the beam. It will be granted also, that the excess of the column of atmosphere above that of water, is equivalent to a weight on the piston, driving it to a depth of about five feet within the cylinder with an accelerated motion, till friction and resistance from the uncondensed steam which remains in the cylinder even after the injection, and which is increased in elasticity while its bounds are dimi-

¹ Phil. Trans. vol. xlvii. p. 436. or Abridg. vol. x. p. 252.

² Phil. Trans. vol. xlvii. p. 197. or Abridg. vol. x. p. 187.

nished, shall equal the accelerative force; and that then again the piston may be retarded the rest of the way. But, independent of friction, we can, notwithstanding this diminution of force by the remainder of steam within the cavity of the cylinder, demonstrate the ratio of the velocities, and the times of descent of the pistons in cylinders of unequal altitudes, to be exactly the same as if the resistance were nothing; whence we shall without difficulty arrive at some conclusion in this matter. Let $M N$ be the working part of a steam engine cylinder of the usual height, equal in diameter to a shorter one $m n$ and the rarefaction in both of them being supposed the same, $A Q = a q$ may represent the excess of the atmosphere's weight above the column of water; $R Q = r q$, the resistances to the pistons from the remainder of the steam, and $A R = a r$ the effective forces. Make $a k : A K ::$

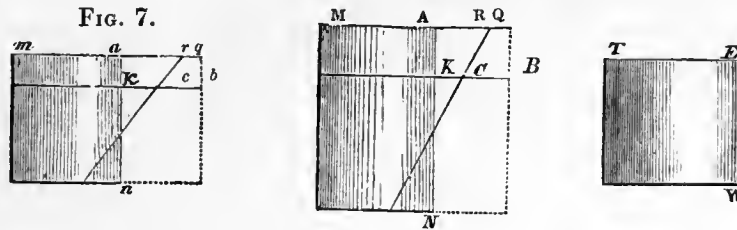

$a n : A N$, and at all similar positions, the resistance $b c$ of $m n$, and force $k c$ on its piston, will be equal to the resistance $B C$ of $M N$, and force $K C$ on its piston; and (by Newton's Princip. prop. 39.) in the descent of bodies, we have $\sqrt{a k c r} : \sqrt{A K C R} ::$ celerity in k : celerity in K . But these areas being evidently as the corresponding parallelograms $k q$ and $K Q$, and these again as their heights, the celerities generated are in the subduplicate ratio of $a k$ to $A K$, as if the resistance had been invariable.

To apply this to steam engines, if $T W$ be a cylinder of equal content with the cylinder $M N$, the quantity of water delivered by both will, as observed above, be the same at each lift; but the cylinder $T W$ is no higher than $m n$, and their rarefactions are supposed equal; therefore, by what has been proved with regard to the times, the time of the piston's descent in $T W$ will be to that of the piston's descent in $m n :: \sqrt{E W} : \sqrt{A N}$; whence, in any given time, the short cylinder $T W$ will perform more than the longer one $M N$ of equal content, and that in the ratio of their diameters; for as $T E^2 \times E W = M A^2 \times A N$; and $E W : A N :: M A^2 : T E^2$; therefore, $\sqrt{E W} : \sqrt{A N} :: M A : T E$. And he further remarks, the friction is diminished with the slowness of the motion, because the periphery of the piston increases in a less ratio than its area.

The result of his whole reasoning is in favour of a short cylinder, and it must be allowed to be ingenious; but the proper question is, What form of the cylinder

will enable us to do the most work with the least steam, and not the most work in the least time with a cylinder of a given capacity? (Sect. iv.)

Mr. Blake also investigated the relation between the power and resistance which gives a maximum effect in a given time when the motion accelerates from rest, both when the force is uniform, and when variable, increasing as the distance.¹ (See Sect. iv.)

1757. KEANE FITZGERALD, F.R.S.

20. It was natural to expect that the atmospheric engine being now in considerable use, the means of saving fuel would be considered, in places where it was expensive. Mr. Keane Fitzgerald, in 1757,² proposed, with this object, to agitate the water in the boiler by a stream of air, on Dr. Hales' plan for evaporating; not perceiving the difference between forming steam and accelerating evaporation. But in consequence, Dr. Hales applied to him respecting working ventilators for mines by steam engines; and a rotary motion being necessary to that end, Fitzgerald contrived one to render the steam engine applicable to the purpose. The method he adopted nearly resembled, in principle, that before contrived by Halls for his steam boat, (art. 14.); but instead of regulating it by a weight, Fitzgerald proposed to use a *fly wheel*; and remarks, that the steam engine by such means may be applied to corn mills, raising coals, &c. Fitzgerald also showed the impropriety of the then usual mode of constructing the working beam with its axis below its centre of gravity, and altered the place of the axis of the engine beam of the York water-works engine, with much advantage to its effect.

1758. WILLIAM EMERSON; born 1701, died 1782.

21. A brief but clear description of the atmospheric engine was published by Emerson in his 'Mechanics,' with the mode of computing its power, as far as statical equilibrium between the power and resistance is concerned. He also, in his 'Miscellanies,' gives a solution of a problem, which has for its object to determine the relation between the power and resistance when the effect is greatest. It may be stated as follows:—In a steam engine there is given the effective pressure of the atmosphere upon the piston, and the length of the stroke, to find the water to be drawn at a stroke, so that the greatest quantity shall be drawn in a given time, supposing the force uniform, and the arms of the beam of equal length. Emerson's solution differs from Blake's (art 19.), in taking the whole time of the

¹ Phil. Trans. vol. li. p. i. or Abridg. vol. xi. p. 317.

² Phil. Trans. vol. l. p. 53 and 157.

ascending and descending strokes into the account; and in not considering the moving power as a gravitating mass of matter. It is, therefore, more strictly applicable to the question, though still not perfectly so, as the space, not the time, should be given. (See Sect. iv.)

22. The celebrated practical engineer, James Brindley, attempted to improve the construction of the steam engine boiler by forming it of wood and stone, and inserting a fire place and chimney of cast iron in the internal part of the boiler, so as to surround both as far as possible, on all sides, by the water of the boiler. This plan he expected would render more of the heat of the fuel effective; and therefore obtained a patent, in 1759, for the arrangement. That it was founded on mistaken views of the nature of combustion, and of the quantity of the loss of heat, would not be difficult to prove, (see art. 190.); and, accordingly, it never was adopted in general practice.

1762. DR. JOSEPH BLACK; born 1723, died 1799.

23. The relation between the quantity of fuel and the effect of steam in an engine became now an important subject; but the different quantities of heat combined with the same body according as it was in a solid, a liquid, or gaseous state, or with different bodies at the same temperatures, had not yet been determined, or rather the fact was not distinctly known; and therefore crude opinion must have directed the wisest, as it now directs the ignorant man, in his attempts to improve the steam engine. To Dr. Black we owe the first investigation of the combination of heat with bodies in the solid, liquid, and gaseous state, which he began to teach publicly in 1762: the heat so combining with them, he showed was insensible to the thermometer, and hence he called it *latent heat*.

The quantity of heat required to convert boiling hot water into steam, he found exceeded five times the quantity which made water boil. Dr. Black also showed that different bodies required different quantities of heat to produce the same change of temperature, and denoted the property by the phrase, capacity for heat; the term now usually employed is specific heat. (See Sect. II. art. 70.)

The principles of managing confined fires, and the nature and effect of fuel, were also taught by Dr. Black.

In the inquiries respecting heat he was followed by Dr. Irvine and Dr. Crawford, who made experiments to determine the specific heat and latent heat of various substances.

1765. JOHN SMEATON, F.R.S.; born 1724, died 1792.

24. Smeaton was not of a cast of mind likely to seize the views of Dr. Black,

and turn them to account in managing the action of steam ; his talent was chiefly confined to improving the construction and proportions of existing machines, by selecting the best methods known, and making experiments : accordingly, we find he designed a portable atmospheric engine to make trials upon, in 1765 ; and these experiments he was preparing for in 1769.¹ Smeaton afterwards directed the erection of several large atmospheric engines, and brought them to a degree of perfection which has not been exceeded in later times. I propose briefly to follow through the most interesting of his inquiries ; commencing with his portable engine. This seems to have been the first attempt to make an engine capable of being removed from place to place. The fire place was formed entirely within the boiler ; and in the place of an ordinary beam, a wheel 6·2 feet in diameter, with a chain, communicated the motion from the piston to the pump rod.

The diameter of the cylinder was eighteen inches, its area, in circular inches, 324 inches ; and allowing seven pounds to the inch, which such a cylinder, he remarks, would very well carry, we have 2268 lbs. The number of strokes per minute is stated to be ten of six feet each ; hence the effect is $2268 \times 10 \times 6 = 136080$ lbs. raised one foot, or four horses' power : he reckoned it equivalent to six horses ; and therefore his value of the horse power is 22680 lbs. raised one foot high per minute, instead of the usual standard of 33000 lbs.

Respecting fuel, he remarks, it has been found by experience that a two feet cylinder requires 174 lbs. of Newcastle coal per hour ; which, reduced in the ratio of the capacity, gives ninety-seven pounds and a half per hour for the eighteen inch cylinder, or a four horse engine, according to the common application of fire ; but he had reason to think an engine constructed like his would not require above sixty-five pounds per hour for a four horse engine.

The fire place was of a spherical figure, of cast iron, and entirely within the boiler ; the coals were introduced by a large pipe from the outside of the boiler to the fire place, and the smoke passed off by a curved pipe with an iron funnel to promote a sufficient draught. The ashes fell through a pipe covered by a grate eighteen inches diameter, the whole being joined to the boiler by proper flanches, and always covered with water. In so short a flue the force of the fire cannot be wholly exhausted within the compass of the boiler, therefore the curved pipe was surrounded by a copper vessel adapted to its shape, into which was brought the feeding water, that it might be raised to a greater degree of heat than if brought immediately from the hot well into the boiler. It is also obvious, that by this arrangement the coolest part of the water comes in contact with the flue, to take the heat from the smoke before it ascends the chimney. The bars of the grate

¹ Reports, vol. i. p. 223. and ii. 338.

were cast into a loose ring capable of being taken out, and replaced when occasion required. On the large scale also, Smeaton's boilers were admirably adapted for generating steam, little inferior to any that have since been contrived.

In a report to the London bridge water works, in 1771, Smeaton proposed to regulate the power of the engine by the injection, whereby the engine-keeper would be enabled, while the engine was working, to vary the quantity in proportion to the column to be lifted, and avoid the ill effects arising from a variation of the column, and save fuel.

Smeaton's first effective introduction of the improvements resulting from his experiments on the engine seems to have been in the early part of 1774;¹ and by these improvements he appears to have reduced the expenditure of fuel about one-third. In 1775, he designed the Chase Water Engine, the cylinder of which was seventy-two inches in diameter, and the stroke nine feet. Its power was equivalent to the exertion of 108 horses, and its consumption of fuel was estimated at 1136 lbs. of Newcastle coal per hour. At its full power it was proposed to make nine strokes per minute, but to be regulated by the cataract to four strokes and a half per minute. The construction of the beam, and other parts of the engine, are sufficiently curious to entitle it to the strict attention of the student.²

There seemed to be few practical circumstances that escaped Smeaton's inquiry respecting the atmospheric engine; and he drew up for his own use a table of the proportions of the parts for different sized engines, which still exists in the collection of his papers, purchased by Sir Joseph Banks. But the most important of his researches relate to the load upon the piston, on which he remarks he had found engines calculated to carry a load, varying from under five pounds to upwards of ten pounds to the square inch, those lightly loaded being expected to go with the greatest velocity, so that an engine carrying five pounds to the inch must go with double the velocity of one loaded to ten pounds, the cylinders being of equal area, in order that the effects of the power might be equal. He further adds, that in engines, however, as in other machines, there is a maximum, which, without new principles of power, cannot be exceeded: bad proportions of the parts, and bad workmanship, may make an engine fall short, in any degree, of what it should do, but its maximum cannot be exceeded by the most accomplished artists.

Experience had, however, suggested the idea of a mean burden. The original patentees (Newcomen and Co.), from some of their first performances, laid it down as a rule to load the piston, so as but little to exceed eight pounds to the inch; but, on more experience, they diminished that load, and amongst the best engines previous to Smeaton's time the load was made about seven pounds to the square inch.

¹ Reports, vol. ii. p. 337.

² Smeaton's Reports, vol. ii. p. 350.

He further states, that any load will do if the parts be properly proportioned ; but, from a long course of very laborious experiments, he had fixed his scale near upon, but somewhat under, eight pounds to the inch, including raising the injection water.

The labours of Smeaton show the imperfect state of mechanical science, as applied to practice, in a remarkable degree. He actually designed an engine, to be erected at Long Benton, to raise water for turning a water wheel to draw coals from a pit ;¹ and in 1781 proposed one of Boulton and Watt's engines to be erected for raising water for driving a corn mill ;² using such arguments as these in support of his opinion. " It is to be apprehended that no motion communicated from the reciprocating beam of an engine can ever act with perfect equality and steadiness in producing a circular motion like the regular efflux of water in turning a water wheel ; and much of the good effect of a water mill is well known to depend upon the motion communicated to the millstones being perfectly equable and smooth : the least tremor or agitation takes off from the complete performance. Secondly, all the engines he had seen were liable to stoppages, and so suddenly, that in making a single stroke the machine is capable of passing from nearly its full power and motion to rest ; for whenever the steam gets lowered in its heat below a certain degree, for want of renewing of the fire in due time or otherwise, the engine is then incapable of performing its functions. In the raising of water, (a business for which the fire engine seems peculiarly adapted,) the stoppage of the engine is of no other ill consequence than the loss of so much time ; but in the motion of millstones grinding corn, such stoppages would have had a particularly bad effect."

It was certainly not a gratifying circumstance to Smeaton to find that his tedious inquiries had been rendered nearly useless by a new mode of operation ;—to find that his cautious system of analysis was not in all cases the best mode of rendering the powers of nature useful to man. Yet if it were his labours on the steam engine alone on which his fame rested, there would be sufficient to command our esteem and respect : its further improvements, its close cylinder, its double action, undoubtedly owed much of their perfection to the use of the modes of construction applied by Smeaton to the air pump.

1766. JOHN BLAKEY.

25. Though there are so many circumstances in the mode of action which reduce the effect of an engine of Savery's construction, these defects seem only to

¹ Smeaton's Reports, vol. ii. p. 435.

² Reports, vol. ii. p. 378.

hold out an inducement to speculative men to attempt to remove them, and among these Blakey was one of the most sanguine. He obtained, in 1766, a patent for a new mode of constructing Savery's engine, by using two receivers, one placed over the other, with a pipe of communication between them. The contact of the steam and water was to be prevented by a stratum of oil, forming a species of fluid floating piston. He further proposed to admit air to occupy the place between the steam and water, so as to prevent condensation during the process of forcing: both methods inferior to the floating piston of Papin. Blakey had, however, sufficient art to persuade the public that he had made a valuable discovery, and to get Ferguson, the lecturer, to show off its advantages by a steam fountain.¹ In practice his method was found to be worthless.

In generating steam, Blakey seems to have first proposed cylindrical tubes for boilers, the description of which he published in 1774. He was also the author of a pamphlet entitled, 'A Short Historical Account of the Invention, Theory, and Practice of Fire Machinery,' printed in London in 1793, which was chiefly filled with short notices of his own labours on the subject, now of no interest.

1769. JAMES WATT, LL.D. F.R.S.; born 1735, died 1819.

26. The commencement of the researches of Mr. Watt appears to have been in 1764, two years after Dr. Black began to teach his doctrines regarding heat. Mr. Watt began by making experiments on the elastic force and bulk of steam, and gradually developed those principles which form the basis of his valuable improvements on the steam engine; but he did not so far mature his plans as to apply for a patent till 1768, which was enrolled in 1769. The specification is brief, and not illustrated by figures; hence I will give it entire, and then distinguish the principles and methods of construction which had not been anticipated.

Mr. Watt's patent of 1769 was for his 'Methods of Lessening the Consumption of Steam, and consequently of Fuel in Fire Engines;' and his specification is as follows:—"First; that vessel in which the powers of steam are to be employed to work the engine, which is called the cylinder in common fire engines, and which I call the steam vessel, must, during the whole time the engine is at work, be kept as hot as the steam that enters it; first, by enclosing it in a case of wood, or any other materials that transmit heat slowly; secondly, by surrounding it with steam, or other heated bodies; and, thirdly, by suffering neither water, nor any other substance colder than the steam, to enter or touch it during that time. Secondly; in engines that are to be worked wholly or partially by condensation of steam, the

¹ Ferguson's Lectures, vol. i. p. 312.

steam is to be condensed in vessels distinct from the steam vessels or cylinders, although occasionally communicating with them: these vessels I call condensers; and, whilst the engines are working, these condensers ought at least to be kept as cold as the air in the neighbourhood of the engines, by application of water or other cold bodies. Thirdly; whatever air or other elastic vapour is not condensed by the cold of the condenser, and may impede the working of the engine, is to be drawn out of the steam vessels or condensers by means of pumps wrought by the engines themselves or otherwise. Fourthly; I intend in many cases to employ the expansive force (pressure) of steam to press on the pistons, or whatever may be used instead of them, in the same manner as the pressure of the atmosphere is now employed in common fire engines. In cases where cold water cannot be had in plenty, the engines may be wrought by this force of steam only, by discharging the steam into the open air after it has done its office. Fifthly; where motions round an axis are required, I make the steam vessels in form of hollow rings or circular channels, with proper inlets and outlets for the steam, mounted on horizontal axles like the wheels of a water mill; within them are placed a number of valves that suffer any body to go round the channel in one direction only: in these steam vessels are placed weights so fitted to them, as entirely to fill up a part or portion of their channels, yet rendered capable of moving freely in them by the means hereinafter mentioned or specified. When the steam is admitted in these engines between these weights and the valves, it acts equally on both, so as to raise the weight to one side of the wheel, and by the re-action on the valves successively, to give a circular motion to the wheel, the valves opening in the direction in which the weights are pressed, but not in the contrary; as the steam vessel moves round, it is supplied with steam from the boiler; and that which has performed its office may either be discharged by means of condensers, or into the open air. Sixthly, I intend in some cases to apply a degree of cold not capable of reducing the steam to water, but of contracting it considerably, so that the engines shall be worked by the alternate expansion and contraction of the steam. Lastly; instead of using water to render the piston or other parts of the engines air and steam-tight, I employ oils, wax, resinous bodies, fat of animals, quicksilver, and other metals, in their fluid state.

“Be it remembered, that the said James Watt doth not intend that any thing in the fourth article shall be understood to extend to any engine where the water to be raised enters the steam vessel itself, or any vessel having an open communication with it.”¹

The great and valuable improvement described in this specification is that of

¹ Robison's Mech. Phil. vol. ii. p. 119. Repertory of Arts, i. 217. 1794.

condensing in a separate vessel ; and it necessarily involved a method of clearing the condenser of air and water. The application of the principle could be rendered perfect only by keeping the cylinder as hot as the steam, and the condenser as cold as it could be done with economy ; and the methods proposed by Mr. Watt for accomplishing these objects are at once novel and efficient.

The idea of using steam pressure was not new, not even when applied to a piston, (see art. 12.) but the application of it in a close cylinder by means of a stuffing box, such as Smeaton had applied to the air pump, was a new mode of construction, which, it may be inferred, was intended in the engine specified, though it is not described. The scheme of a rotary steam vessel, or steam wheel, was also first made public in this specification, though in a very imperfect manner.

27. Mr. Watt's steam wheel not answering on trial, his next object seems to have been to convert the reciprocating motion of the piston rod into a rotary one. Methods for this purpose had been contrived by Hulls and Fitzgerald ; and patents had been obtained for similar ones by Stewart in 1769, and by Washborough in 1778, also by Steed in 1781, for the simple crank motion.

Notwithstanding the existence of these methods, Mr. Watt obtained a patent for five others in 1781, one of which was the sun and planet wheel motion, which he used for some time on account of the crank being Steed's patent.

In 1782 Mr. Watt obtained another patent, embracing various methods of applying steam. First, for an expansive steam engine, with six different contrivances for equalizing the power ; secondly, the double power steam engine, in which the steam is alternately applied to press on each side of the piston, while a vacuum is formed on the other ; thirdly, a new compound engine, or method of connecting together the cylinders and condensers of two or more distinct engines, so as to make the steam which has been employed to press on the piston of the first, act expansively upon the piston of the second, &c. ; and thus derive an additional power to act either alternately or conjointly with that of the first cylinder ; fourthly, the application of toothed racks and sectors to the end of the piston or pump rods, and to the arches of the working beams, instead of chains ; fifthly, a new reciprocating semirotative engine, and a new rotative engine or steam wheel.

By the double engine the same cylinder was rendered capable of doing double the quantity of work in the same time, the steam pressure acting, and condensation taking place, both during the ascent and descent of the piston. Simple as this change appears, after being made, it is attended with many striking advantages ; it renders the power nearly uniform, diminishes the proportion of cooling surface, a less boiler is necessary, and it reduces the bulk and weight of the engine.

Of the modes of regulating the power of steam engines, the most effective were,

first, by limiting the opening of the regulating valves which admit the steam to act on the piston, and letting it continue so open during the whole length of the stroke; secondly, by letting them open fully at first, and shutting them completely when the piston has proceeded only part of its stroke; or, thirdly, by the use of a throttle valve placed in the steam pipe, which, acting in the same manner as the floodgate of a mill, admits no more steam than gives the desired power.

The second of these methods of regulating the power of the engine is the best, and forms the basis of Watt's Expansive Engine; which renders available more of the power of the steam than when the piston is acted upon by the whole force of the steam through the entire length of the cylinder. This principle was adopted in an engine erected at Soho manufactory, and some others, in 1776, and at Shadwell water works in 1778; the same principle was publicly made known in 1781 by Hornblower, though applied in a different manner.

28. There yet remained another step to complete the mechanism of the double engine, viz. a guide for the piston rod; and this appears to have been first accomplished, in 1784, by the invention of the parallel motion. This is an ingenious combination of levers, one point of which describes a line nearly straight, and to this point the piston rod is connected, so that its rectilinear movement causes the beam to vibrate. This Mr. Watt secured by patent in 1784, together with a new rotative engine, in which the steam vessel was to turn upon a pivot, and be placed in a dense fluid, the resistance of which to the action of the steam was to cause the rotative motion; an improved method of applying the steam engine to work pumps or other alternating machinery, by making the rods balance each other; a new method of applying the power of steam engines to move mills which have many wheels required to move round in concert; a simplified method of applying the power of steam engines to the working of heavy hammers or stampers; a new construction and mode of opening the valves, with an improved working gear; and a portable steam engine and machinery for moving wheel carriages.

Mr. Watt obtained a patent, in 1785, for a method of constructing furnaces, in which the best principles the philosophy of the period could furnish, are applied to elicit the heat and consume the smoke of the fuel. He also applied to the steam engine the conical pendulum as a governor, the steam gauge, condenser gauge, and a useful little instrument for ascertaining the state of the steam in the cylinder, called an indicator.

29. The principal part of the theory of the action of steam, which Mr. Watt has investigated on scientific principles, is the power it affords by expansion; and this is done with great clearness. He devoted a considerable portion of the latter part of his life to chemical philosophy, and particularly its application to the arts. As an author, he has also contributed some historical notices of his own inventions,

a few corrections of Dr. Robison's article in his 'Mechanical Philosophy,' and several notes to it, containing his experiments on the latent heat and elastic force of steam.

30. The share which Boulton had in the improvement and introduction of the steam engine must not be forgotten; for as it has been remarked by Baron Dupin, "Watt's engine was, when invented by him, but an ingenious speculation, when Boulton, with as much courage as foresight, dedicated his whole fortune to its success." He did not hesitate even when Smeaton declared his conviction that it could never be generally applied as a useful agent. Besides, Boulton rendered no small service to Watt and to Great Britain, when, by his extraordinary talents in manufactures and commerce, he exempted his partner from all the cares of life, from all commercial speculations, and from all those difficulties which are the inevitable consequences of great enterprise in trade. Boulton did still more; he triumphed over all those interests and prejudices which necessarily arose in the beginning to retard the success of the new steam engines and their application. "Men," continues Dupin, "who devote themselves entirely to the improvement of industry, will feel in all their force the services that Boulton has rendered to the arts and mechanical sciences, by freeing the genius of Watt from a crowd of extraneous difficulties, which would have consumed those days that were far better dedicated to the improvement of the useful arts."

31. A curious apparatus for trying the elastic force of different vapours was invented by T. H. Zeigler, which he describes in a memoir published at Basle in 1769, with tables of the results of his experiments; but it appears he had not taken care to free his apparatus from air before the trials; they are therefore useless.

1781. JONATHAN HORNBLOWER.

32. In 1781, a patent was obtained by Mr. Hornblower, for a mode of applying the expanding power of steam. For when steam is confined on one side of a piston, and a partial vacuum is formed on the other, the steam will move the piston till its force be in equilibrium with the friction and uncondensed steam; and as much power as is communicated during this motion is in addition to the ordinary effect of steam pressure. To gain power in this manner, Mr. Hornblower used two vessels in which the steam was to act, and which, in other steam engines, are called cylinders, employing the steam after it had acted in the first vessel to operate a second time in the other, by permitting it to expand itself, which he did by connecting the vessels together, and forming proper passages and apertures, whereby the steam might at proper times go into and out of the said vessels.¹

¹ Repertory of Arts, vol. iv. p. 361. 1796.

The effect would be nearly the same as that derived from cutting off the steam before the piston arrives at the end of its stroke, as was afterwards done by Mr. Watt, (art. 28.) but has the decided advantage of being a more equable method of employing steam power; and in large engines the construction of Hornblower's is also superior, because strong steam can be used in a small cylinder with less risk: he however does not appear to have intended to use powerful steam; and he could not use his invention, because the improved mode of condensation remained the right of Boulton and Watt.

Like Watt, many other engineers imagined that a rotary motion might be communicated with advantage by the direct action of steam; and two combinations for that purpose were made by Hornblower. His first was an ingenious but complicated machine, for which he had a patent in 1798.¹ The second was more simple; it was secured by a patent in 1805. It consists of four vanes revolving in a cylinder round its axis. The vanes are like those of a smoke jack, but of thickness sufficient to form a groove in their edges, to hold stuffing for the purpose of making them steam-tight in their action. They are mounted on an arbor, which has a hollow nave in the middle. Into this nave the tails of the vanes are inserted, and each opposite vane affected alike by having a firm connexion with one another; so that if the angle of one of the vanes with the arbor be altered, the opposite one will be altered also, and the opposite ones are set at right angles to each other; so that when a vane is flatly opposed to the steam, the opposite vane will present its edge to it, and thus they are constantly doing in their rotation on their common arbor; so that the steam acts against the vane on its face for about a quarter of a circle, or ninety degrees, in the cylinder where it is destined to act; and as soon as it has gone through the quarter of the circle, it instantly turns its edge to the steam, while at the same instant another vane has entered the working part of the revolution, and the rotation proceeds without interruption. This engine was to be furnished with the condenser and discharging pump of Watt, but Hornblower added what he considered an improved method of discharging the air from the condenser.

It is easy to show that the friction, and other sources of loss of power, are much greater in the rotary than in the rectilinear action of steam, while the loss by rendering a reciprocating motion rotary is very small (Sect. iv. and vii.); but I notice this as one of the most simple combinations proposed for a rotary engine.

33. A series of experiments on the elastic force of steam from 32° to 212° was published by Mr. Achard in 1782. He also examined the elastic force of the vapour of alcohol; and observed, that when steam and alcohol vapour were of

¹ Repertory of Arts, vol. ix. p. 289. Old Series.

equal elastic force, the temperature of the latter was about thirty-five degrees lower, but that the difference of temperature was not constant; it seemed to be greater or less as the elastic force was greater or less.

1782. MARQUIS DE JOUFFROY.

34. The idea of employing the steam engine to propel vessels, which had been suggested by Hulls, (art. 14.) was first tried in practice by the Marquis De Jouffroy, who, in 1782, constructed a steam boat to ply on the Saône, at Lyons; it was 140 feet long and 15 feet wide, and drew 3·2 feet of water. He made several experiments with it, and it was in use fifteen months on the Saône.¹

35. In 1785 M. Perronet gave a very full description, in the French Encyclopædia, of an atmospheric engine erected near Saint Guilain, in Hainault: this description is remarkable for its clearness and practical details, and not less so from its being introduced by stating Papin to be the inventor of the steam engine in a most unqualified manner; though admitting the first to have been constructed in England.

1788. PATRICK MILLER.

36. About this time various competitors for the application of steam to navigation appeared, (1785-88.); in America, two rivals, James Rumsey of Virginia, and John Fitch of Philadelphia. In Italy the application of steam power to vessels was proposed by D. S. Serratti, and in Scotland by Mr. Miller of Dalswinton, who afterwards, on the sight of a model of a steam carriage invented by Mr. William Symington of Falkirk, was so much pleased with the model, that he desired Mr. Symington to make him a small steam engine, to work a twin or double boat on Dalswinton Loch. The engine having been accordingly executed, and put on board the boat, the experiment was made at Dalswinton in the autumn of 1788, and it succeeded so well, that Mr. Miller commissioned Mr. Symington to purchase a gabert, or large boat, at Carron, and to fit up a steam engine on board of it, to make a trial on a larger scale. Every thing being completed, the trial was made on the Forth and Clyde canal, in the summer of 1789, Messrs. Miller, Stainton, Taylor, &c. being on board; and the result answered their most sanguine expectations; but most unaccountably, after having thus established, at a considerable expense, the practicability of employing the power of steam in navigation, Mr. Miller seems to have neglected it entirely.²

¹ Dictionnaire de Physique, art. Chaloupe à Vapeur.

² 'Short Narrative of Facts relative to Steam Navigation,' Edinb. Phil. Journal.

37. The theory of the steam engine still made small progress, though it excited some degree of attention.

Bossut had described an atmospheric engine in the first edition of his 'Hydrodynamique,' in 1771, with some formula for its statical equilibrium; in the edition of 1786, he investigated the proportion of counterweight, but for a particular case, and not including the actual circumstances of the moving forces.

38. A rotary engine was proposed in 1789 by Cooke,¹ and a patent was obtained for one in 1790 by Bramah and Dickinson,² and for another in 1791 by Sadler.³ The peculiar construction of all these engines I need not describe, as the principle of a rotary engine will be shown to be attended by a loss of effect, which mechanical combinations cannot remove. (See Sect. iv.)

39. Bramah and Dickinson's patent included three varieties; the most simple of which is designed with pistons sliding in an eccentric wheel, the steam to enter at *s*; and the opening to the condenser being at *c*, the pressure causes the smaller wheel to revolve, and the pistons to slide in it. All the varieties are specimens of

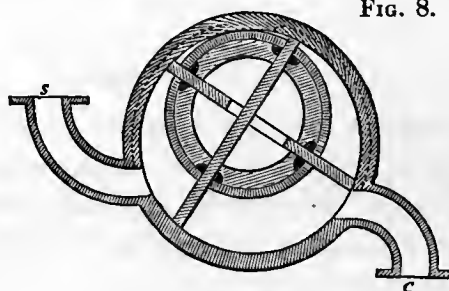

that beautiful style of executing machinery, which Bramah contributed so much to introduce in this country, and which has been carried to such high perfection by his pupil, the celebrated Maudslay.

1790. BETTANCOURT.

40. Chev. Bettancourt, who was employed by the Spanish government to collect models of hydraulic machines, made a series of experiments on the force of vapour of water and of alcohol, at different temperatures. They are more accurate than those which were at that time before the public, but still had not that precision which is necessary to develop the laws of the force of vapour. He made a

¹ Repertory of Arts, vol. iii. p. 401. 1795.

² Idem, vol. ii. p. 73.

³ Idem, vol. vii. p. 170.

model of the double acting engine, with a new mode of forming the valves ; and, Prony says, from merely seeing the exterior of a double acting engine when at work.¹

1790. R. PRONY.

41. M. Prony is the author of one of the most extensive of the French works on the steam engine : it forms a part of his 'Architecture Hydraulique,' which commences in the first volume, and occupies nearly the whole of the second.

M. Prony begins with the properties of caloric, and the tables of Bettancourt on the force of vapour ; and from the latter constructs an empirical formula for calculating the force of vapour at different temperatures. These are not a little complex, considering their want of conformity with experiment. He then proceeds to the description of engines as then constructed, and their parts ; which are illustrated by plates having figures on a large scale. When he arrives at the parallel motion, the nature of the curve described by the extremity of the piston rod is very fully investigated, with tables to show its variation from a straight line for a given range in the curve. It is followed by the proposal of a method for determining the diameter of the steam cylinder, which is little better than telling the artist to guess at it, and correct his guess by an intricate formula. The part on the steam engine terminates with a calculation of the effect produced by a given quantity of fuel, where the time of combustion is certainly erroneously introduced.

The rest of the volume is occupied by an analytical investigation of empirical formulæ for the expansive forces of elastic fluids and vapours at different temperatures ; which has been rendered wholly useless by later researches having shown the experiments to be inaccurate.

It is remarkable that Prony had not acquired a knowledge of the advantage of steam acting expansively ; though, when his second volume appeared, it had been fifteen years a contested discovery in England. Of his labours it may be said, that they afford the strongest evidence that mere mathematical talent is not sufficient for the promotion of mechanical science, otherwise the principles of the steam engine would not have remained to be investigated.

1795. JOHN BANKS.

42. Mr. Banks, in a work on mills published in 1795, has treated of the maximum of useful effect in atmospheric steam engines. He considers the space, or length of the stroke, the given quantity ; in which his investigation differs from

¹ Archit. Hydraulique, vol. i. p. 574.

those of Blake and Emerson. He has, however, by considering the atmospheric pressure as a gravitating weight, failed in giving a correct solution.

One of his problems includes the weight of the moving parts of the engine ; and he adds some useful practical formulæ for the statical equilibrium of engines for raising water, with examples.

In 1803, Mr. Banks gave some rules for the strength of engine beams, both for wood and cast iron ; and also a description of a gauge for determining the state of rarefaction in the cylinders and condensers of steam engines, in principle the same as the common barometer, and differing from the ordinary condenser gauge by having a cistern instead of a syphon for the mercury. His rules for the strength of beams are, to find the relation between the pressure and breaking weight, and to let the breaking weight exceed the pressure by six, eight, or ten times.¹

1797. DR. EDMUND CARTWRIGHT ; born 1742, died 1823.

43. The simple and neat combination of Cartwright next claims attention, and on more grounds than one. He attempted to condense the steam by means of cold applied externally to the condenser ; it consisting of two metal cylinders lying one within the other, and having cold water flowing through the inner one and enclosing the outer one. By this construction, a very thin body of steam is exposed to a very great quantity of cooling surface ; and, by placing the valve to change the steam in the piston, a constant communication is at all times open between the condenser and the cylinder, so that, whether the piston ascends or descends, the condensation is always taking place.

One of the chief objects of this arrangement was the opportunity it afforded of substituting ardent spirit or alcohol, either wholly or in part, in the place of water, for working the engine ; for as the fluid with which it is worked is intended to circulate through the engine without mixture and very little loss, the using alcohol, after the first supply, it was expected, would be attended with little or no expense. The power obtained from alcohol, it was then imagined, would require only half the fuel which was necessary to obtain the same power from water (see Sect. iv.) ; and Cartwright proposed, in some cases, to apply this engine to a still, to obtain mechanical power by the distillation of ardent spirit, so as to save the whole of the fuel.² How he was to keep the engine in a workable state, and yet obtain a pure spirit, neither he nor his friends seem to have considered.

In order to reduce the friction of the piston, which, when fresh packed in the common way, lays a very heavy load upon the engine, Cartwright made his solely

¹ Power of Machines, p. 103.

² Phil. Mag. vol. i. p. 3.

of metal, and expansive: by this method he further expected some advantage from saving of time and expense in the packing, and from the piston fitting more accurately, if possible, the more it was worked. (See Sect. vii.) Cartwright was very desirous of simplifying all the other parts of his engine, having only two valves, and those are as nearly self-acting as may be. Cartwright's engine is represented in the annexed figure. It is a single acting engine, and A is the cylinder; B, the piston; I, the pipe which conducts the steam to C, the condenser, which is a double cylinder; the steam passes between the inner and outer one into the pump D, which returns the condensed fluid back into the boiler, through E, the air box, with *e* its valve.

As the pipe from the pump, through which the condensed fluid is returned into the boiler, passes through the air box, what air or elastic vapour may be mixed with the fluid rises in the box, till the ball which keeps the valve *e* shut, falls and suffers it to escape.

FIG. 9.

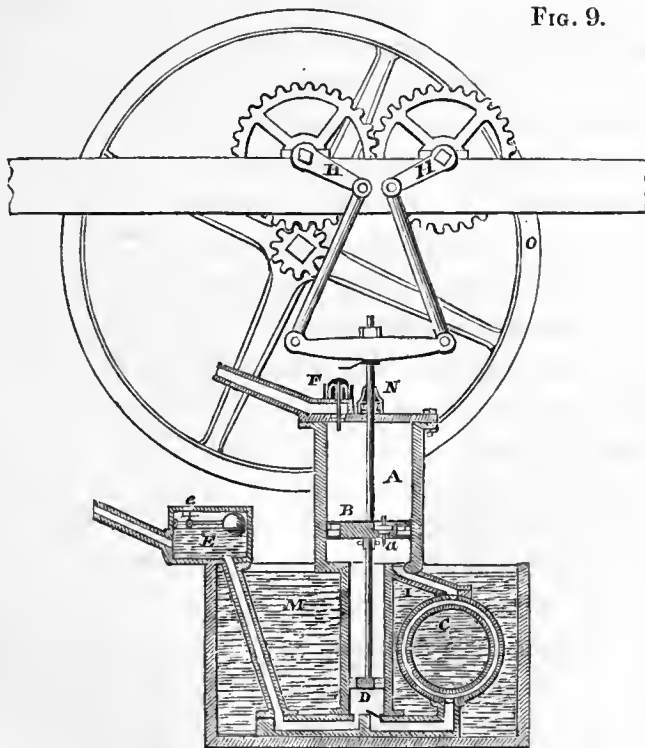

F is the steam valve; *a* the piston valve; H, H, two cranks, upon whose axles are two equal wheels working in each other, for the purpose of giving a rectilinear direction to the piston rod; and M is the cistern that contains the condensing water. The metallic pistons he formed of metal rings, as shown by the section of

the piston, which by springs are forced outwardly against the surface of the cylinder, so that the piston may adapt itself to any inequality in its form. The piston rod is also made steam-tight by a metallic box, constructed in the same manner as shown at N. O is the fly wheel for regulating the motion of the engine.

The metallic piston is the only part of the engine which was really new in principle, and for its invention we are undoubtedly indebted to Cartwright; and though we cannot say any other part is new except in arrangement, we admire the appearance of simplicity and originality which distinguish his design, even knowing that both theory and practice forbid us attempting to use the methods he proposed.

Cartwright included in his patent a rotary engine, which is simple in appearance, but in reality involves many difficulties in construction, besides the loss of effect which must necessarily follow from steam acting on a rotary piston.

1797. JOHN CURR.

44. A work containing the proportions of the parts of atmospheric engines, as they were executed in 1797, with brief technical directions for constructing them, illustrated by plates showing the parts on a large scale, was published at Sheffield, by John Curr.¹ It contains no general description of the engine, and he assigns no reasons for any of the proportions he has given, except when speaking of the pressure on the piston, he says, that when the pressure was increased from seven to eight pounds and a half per square inch, the engine did less, and also when reduced to 6·1 lbs. it did somewhat less; and he does not recommend a greater load than six and a quarter or six and a half pounds.² The engine had a sixty-one inch cylinder, and made twelve strokes, of eight feet and a half each, per minute. The consumption of coals was ten hundred weight of small coal, or sleck, per hour. The power of the engine would be nearly equal to fifty-four horses' power; and as the ratio of coal to sleck is about as three is to four, it is equivalent to about 840 lbs. of coal per hour: and at this ratio, one pound of sleck raises 97,600 lbs. of water one foot high, and one pound of coals 130,000 lbs. one foot high.

45. In 1797 an engine on Savery's principle was described by William Nicholson in his 'Philosophical Journal,' which Mr. Kier had erected in 1793. It acted wholly by condensation; the steam vessel being raised somewhat above the height to which the water was to be raised. It had a provision for letting in a small portion of air between the steam and the water, and the construction was extremely simple and judicious. The boiler was seven feet long, five feet deep, and five feet wide; and it consumed six bushels (522 lbs.) of good coal in twelve

¹ The Coal Viewer and Engine Builder's Practical Companion.

² Idem, p. 40.

hours in its best state, and seven in its worst state. Under these circumstances it made ten strokes per minute, and raised seventy cubic feet of water twenty feet high in a minute.

According to this statement, in the best state of the engine, 87 lbs. of coal were consumed in 2 hours or 120 minutes, and 1400 cubic feet of water raised one foot high per minute; or $1400 \times 120 = 168,000$ cubic feet by 87 lbs. of coal, which multiplied by $62\frac{1}{2}$ lbs., the weight of a cubic foot of water, and divided by 87, gives 120,000 lbs. for the load raised one foot by one pound of coal; which is about one half the effect produced by an engine with a piston and Watt's condenser, and less than the effect of the common atmospheric engine as used for the coal mines.

An attempt was also made by John Nancarrow, to improve Savery's engine, by condensing in a separate vessel; but the nature of the engine does not permit of this being applied with much effect.

1799. MATTHEW MURRAY; died 1826.

46. In the construction and improvement of some of the parts of engines, much was done by Mr. Murray, of the firm of Fenton, Murray, and Wood, of Leeds. These improvements were made the subjects of patents; and though it appeared that some of them had been before used by Boulton and Watt, they did not become publicly recorded till Mr. Murray obtained patents for them.

In his patent of 1799, in order to save fuel, Murray proposed to place a small cylinder with a piston on the top of the boiler, connected to a rack, by means of which the force of the steam within the boiler opens or closes the damper fixed on an axis in the chimney, thus increasing or decreasing the draught of the fires, so as to keep up a regular degree of elastic force in the steam. Mr. Murray also thought some advantage would be gained by placing the steam cylinder in a horizontal instead of a vertical position, with a view of rendering the engine more compact than the usual construction; he also adopted a new method of converting the reciprocating motion of the piston rod to a rotary one of equal power, by means of a property of the rolling circle, and showed how to fix the wheels for producing motion alternately in perpendicular and horizontal directions.¹

47. Mr. Murray's patent of 1801 was for six different objects:—First, for a method of constructing the air pump. Second, for a method of packing stuffing boxes, &c. by bringing the moveable parts of each in immediate contact, which prevents the piston rod receiving any oblique pressure, by the lid being screwed down more upon one side than the other. The third and fourth methods relate to

¹ Repertory of Arts, vol. xi. p. 311. Old Series.

the construction and motion of the valves. The fifth was a method of connecting the piston rod to the parallel motion. And the last, for the construction of fire places, by which the smoke arising from the fire was to be consumed. In most of these, however, he had been anticipated in practice.

48. Another patent was obtained by Mr. Murray, in 1802, for a portable engine; but as it included some of the methods for which Messrs. Boulton and Watt had patents, it was at their instance repealed in the following year. Boulton, Watt and Co.'s portable engine was first constructed in 1806.

1799. WILLIAM MURDOCH.

49. Mr. Murdoch, a partner in the firm of Boulton, Watt and Co., obtained in 1799 a patent for some new methods of construction, which consist of a mode of boring the metallic cylinders and pumps more equably by means of an endless screw, worked by a toothed wheel; and a method of simplifying the construction of the steam vessel and steam case, in engines formed on Mr. Watt's plan, by casting the steam case of one entire piece, to which the cover and bottom of the working cylinder are to be attached. He also proposed to cast the cylinder and steam case in one piece of considerable thickness, and bore a cylindric interstice between the steam case and steam vessel, leaving the two cylinders attached at one end, and to close the other by a ring of metal. Another improvement included in the patent was, a plan for simplifying the construction of the steam valves or regulators of the double engine, by connecting together the upper and lower valves, so as to work with one rod or spindle. The tube which connects them being hollow serves as an eduction pipe to the upper end of the cylinder, and a saving of two valves is effected; and lastly, he adds a scheme for a rotary engine consisting of two toothed wheels working in an air-tight vessel, which he imagined would work with considerable power. Mr. Murdoch's modes of moving the valves have added much to the simplicity and neatness of the double engine, and to his skilful superintendence the steam engine owes many of its perfections; and its success in Cornwall was greatly aided by his activity, integrity, and resources for overcoming the difficulties which the drainage of the mines presented.

1801. DR. JOHN ROBISON; born 1739, died 1805.

50. Dr. Robison, to whom the mixed mechanical sciences are so much indebted for a more judicious combination of theory with practice than is to be found in any preceding author, and for treating them in a more popular style, seems to have bestowed much attention on the principles and construction of the

steam engine. His analytical knowledge was ample for the purpose, and the access of the friend of Watt to practical data must have been easy in proportion as Watt was the liberal friend of science; therefore, much is expected when we take up the volume which contains the articles of Dr. Robison on the steam engine.

The first article contains a rather diffuse statement of the physical properties of steam. The phenomena of boiling, and the effect of pressure in altering the temperature necessary for ebullition, and the popular doctrines of latent heat, are fully stated. It also contains a series of experiments on the elastic force of the steam of water, and of alcohol (see art. 95 and 104); and we have only here to remark on them, that they were not made with sufficient accuracy, even to establish the justness of some of his own views on the subject; also, the rule for the elastic force of steam derived from these experiments, and stated to be "sufficiently exact for practical purposes," is very far from being so, and has had a little effect in misleading some of the engineers who have ventured to speculate on the improvement of steam engines. But, on the whole, Dr. Robison's is the best article on steam I have seen.

The article on the steam engine consists of the history, mixed with detailed descriptions, of the engines of Savery, Newcomen, Watt, &c.; and such theoretical discussion as he has given is also blended in the same mass. In the historical portion the memory of Papin is not quite so respectfully treated as we could have wished; and the circumstance of Watt being the private friend and countryman of the author has not been without its effect on the historian. In other respects Dr. Robison has been impartial. In description there is a want of system, but he is full and particular; and he has been of unknown value in giving information to the competitors of Boulton and Watt, and in furnishing matter for minor writers. In theory he has reprinted the speculations of Bossut respecting the best velocity for atmospheric engines, with some additions, and Watt's mode of computing the pressure on the piston of the expansive engine; but neither of these inquiries are conducted in such a manner as to be of use to engine makers.

The reputation of Dr. Robison has given much additional value to his articles on the steam engine: hence their effect has been unparalleled; and if we find little of novelty in his labours, it was no small favour to have the scattered knowledge on the subject collected with so much skill, and treated with so much clearness and good taste.

51. A modification of Watt's manner of constructing boiler fire places was contrived in 1800 by Messrs. Roberton, of Glasgow, which is more convenient in practice, though the same in principle. (See Sect. III.) They also attempted to make the steam which escapes by the sides of pistons useful in adding to the

effective power of engines. But the complexity and expense of apparatus to obtain so small an increase of power, renders this and some other expedients of that time of little if any value.

1801. JOSEPH BRAMAH; born 1749, died 1814.

52. The rotary engine, the joint product of Messrs. Bramah and Dickinson, has already been noticed. (Art. 39.) In 1801 Mr. Bramah obtained a patent for a new mode of applying the four-passaged cock to steam engines, with some other variations in their construction.

The four-passaged cock he made to turn continually in the same direction, and yet produce the same effect as by turning it backwards and forwards; but by turning constantly the same way, the wear is rendered more equable, and consequently the combination is more durable.

He also adjusted the movements so as to give, at the proper time, as instantaneous and free a passage to the cylinder and condenser as possible; and formed the apertures so that the cone might be pressed equally into its seat by the force of the steam.

53. A series of tables for the proportions of the cylinders of atmospheric engines, to produce a given effect, were published in 1801 by Mr. Thomas Fenwick, whose employment in the management of coal works near Newcastle gave him a good opportunity of knowing what would answer best in practice.

He infers from some experiments, that the whole friction of the atmospheric engine is about four pounds per square inch, on the area of the piston; and on account of the frequent bad effects attending designing an engine with too small an allowance for excess above its ordinary work, he makes his computations at five pounds and a half effective power for each square inch of piston.

In a later edition of his work he gives tables for an improved atmospheric engine with a separate condenser, in which the ratio of the effect is as 17 : 10, when the same sized cylinder is used. The saving of fuel he does not mention, as at coal works it is not considered of much importance; for if the first expense of an engine be small, and its operation simple and efficient, it is of more value to a coal owner than a finer piece of machinery.

1801. JOHN DALTON.

54. At this period a knowledge of the nature and properties of vapours began to become important in chemical science, in meteorology, and in other branches of natural philosophy; and therefore a wholly different class of writers engaged in the

investigation, which had made so little progress in the hands of mechanical people. The first chemist who distinguished himself by attempting a full investigation of the theory of vapour, was Mr. John Dalton. He made an accurate series of experiments on the expansive force of steam at temperatures lower than 212° ,—made experiments and ascertained various phenomena relative to the expansion of gases, the mixture of air and vapour, the nature of evaporation and of combustion. And though he failed in his attempt to reduce any of these to general laws, yet he gave such an impulse to the inquiry, as rendered it one of universal research among chemical philosophers. The importance of Dalton's inquiries, and even their connexion with the theory of the steam engine, did not appear, at first, to be much noticed. The idea that Watt had done every thing possible to be done respecting the power of steam had stopped inquiry among men of science, and left the manufacturers and capitalists of the country, who were wishful to encourage improvement, to be guided by vain and ignorant projectors, or ruined by pretending knavery.

1802. WILLIAM SYMINGTON.

55. In 1801, Mr. Symington was encouraged to proceed with a steam boat, by Thomas, Lord Dundas, of Kerse, who wished that one might be applied to drag vessels on the Forth and Clyde Canal in place of horses; and accordingly a series of experiments on a large scale, which cost nearly £3000, were set on foot in the year 1801, and completed in 1802. The boat Mr. Symington made was for towing, and it had a steam cylinder twenty-two inches in diameter, and four feet stroke. A complete model of it, with a set of ice-breakers attached, may be seen at the rooms of the Royal Institution in London. This tow-boat proved to be very much adapted for the intended purpose, but no direct practical application of steam power to this object resulted from it.

1802. TREVITHICK and VIVIAN.

56. The idea of a high pressure engine had occurred to Leupold, (art. 12.) and to Watt,¹ (art. 26.) but neither of them had reduced their notions to practice; and it was not till 1802 that this simple mode of applying steam was brought into use by Messrs. Trevithick and Vivian.² Their object seems to have been to form

¹ It was generally understood, that, although Mr. Watt patented the high pressure engine, it was not his intention that it should be employed, except in situations where condensing water could not be had. He considered the risk too great, and life too valuable, to be endangered for a saving in the mere original cost of the engine, there being none in respect of the consumption of fuel.

² Repertory of Arts, vol. iv. p. 241. New Series.

a simple and portable engine for cases where water was scarce, or where gaining the whole effect of the fuel was of less consequence than moving a cumbrous load.

Indeed their high pressure engines were intended chiefly for propelling carriages upon rail-roads; and when used for this purpose the boiler was composed of cast iron, of a cylindrical form, mounted horizontally upon a frame with four wheels, the cylinder of the engine being placed vertically within the boiler near to one end. The piston rod moved a cross head, between two guides; and by a connecting rod descending from each end of the cross head to two cranks, the motion was communicated to the wheels of a carriage: a fly wheel in this case is not required, because the momentum of the carriage supplies its place.¹

The first trial of this species of moving power for carriages took place on a railway at Merthyr Tidvil in 1805. Its use was not at that period followed up, but it is now with some slight modifications extensively employed on rail-roads.

Several projects for trifling variations in the construction of engines, and for methods of applying fuel, appeared about this time, but none of either sufficient novelty or importance to claim particular attention.

The nature and application of heat had been so well illustrated by Rumford, and many of its more recondite properties so ably developed by Leslie, that there seemed to be little reason to expect any material improvement beyond the best mode then in practice. The cylindrical boilers which Blakey projected, and Rumford had tried, were again remodelled by Woolf; but in his practice we find he has reverted to methods nearly like those of Rumford, instead of continuing to follow his own. The steam engine itself had also apparently obtained its most simple and efficient form, except in the eyes of those who expected to use its direct rotary action. The fact however was otherwise, for by a most simple change of a previous combination it had to be materially improved.

1804. AUTHUR WOOLF.

57. The mode of condensation invented by Watt being now public property, and the term of Hornblower's patent having expired, Mr. Woolf adopted the arrangement of the latter, with the alteration of using high pressure steam in the small cylinder, and employing the condensing apparatus of Watt. But a change of the working force of the steam would have been too slight a ground to have claimed a patent upon, and therefore he commences his specification with a claim of the

¹ It is but justice to observe, that Mr. Murdock made his working model of a locomotive engine in 1782, and that, as Mr. Trevithick was a pupil of Murdock's, then in Cornwall, it is natural to suppose that he received many of his ideas of locomotion from that gentleman.

discovery of a new law of the expansibility of steam. This law of expansibility he stated, with much confidence, as the result of experiment; but no doubt he had deceived himself. His assumed law of expansion is, that steam generated at any number of pounds above the pressure of the atmosphere will expand to an equal number of times its volume, and still be equal in elastic force to the pressure of the atmosphere, the temperature being unaltered: hence steam generated at forty pounds on the square inch was expected to expand to forty times its bulk, and yet be equal to the elastic force of the atmosphere. But it is a well-known law of the expansion of fluids, that the temperature being constant, the bulk is inversely as the pressure; and calling the pressure of the atmosphere fourteen pounds, we have $14 : 14 + 40 :: 1 : 4$, nearly. Therefore steam generated at fifty-four pounds on the square inch, or forty pounds above the pressure of the atmosphere, would expand only to four instead of forty times its volume. (See art. 120.) And though Woolf's assertions were so directly opposed to the laws of the constitution of elastic fluids, they have found their way as undoubted experimental truths into works which ought to have high claims to respectability.

The employment of high pressure steam to act expansively by means of a double cylinder, gives the utmost degree of power in the most equable manner and with the most safety: hence either for machinery engines, or mine engines, it seems the most economical mode of obtaining power. I object to strong steam on account of its danger; but my readers may not have like apprehensions. Woolf's other patents are for projects of little if any value.

58. It would be an omission to pass without notice the exertions made by Oliver Evans about this period to get into use the high pressure steam engine. His scheme for employing it had not at first many supporters, and he had some rivals. His engine differs little from that of Trevithick and Vivian in construction, but from a work called 'The Abortion of the Young Steam Engineer's Guide,' it appears, that the expansive force of the steam was to be employed. The 'Abortion' is a curious work; it betrays that strange mixture of absurd speculation and indistinct perception of truth, which distinguishes the generality of enthusiastic projectors, and is valuable only to those who can select by means of previous knowledge or experience. A volcanic steam engine, and the idea of employing the force of solar heat by means of a burning glass to work an engine, are among his projects.

59. The claims of our American brethren to improvement, and to judicious construction and application, are however much stronger than those of our continental neighbours; and of American claims we have reason to speak with pride rather than with other feeling. British genius and industry have not been extinguished by transplanting to another climate. It is true that many of the

projects they have yet formed are rather extravagant than novel, being seldom founded on the sober reasoning of science. Time will, however, check this evil, and we may expect them to hold that rank in the New World which Britain has held with such honour for some centuries in the older portion. The chief object of their engineers has been to render steam useful in navigation; and considering the importance to America of navigating her immense rivers, it is not surprising that the application of the power of steam to propelling vessels should by persevering efforts have been first carried into successful practice in that continent. This was achieved through the activity and zeal of Mr. Fulton, who appears evidently, however, to have derived much of his knowledge of the subject from what was done in Scotland. The first American steam boat that completely succeeded was launched at New York on the 3rd of October, 1807, fitted with a steam engine made by Boulton and Watt for Mr. Fulton in 1804;¹ and soon afterwards this vessel plied between that city and Albany, a distance of 160 miles.

60. The successful introduction of steam navigation in Britain we owe to Mr. Henry Bell, who in 1811 built a steam vessel according to his own plans, with a forty feet keel, and ten feet six inch beam, fitted it up with an engine and paddles, and called it the Comet, because it was built and finished the same year that a large comet appeared.

Since that time the progress of steam navigation has been exceedingly rapid, and has had a most beneficial influence on the trade of the country.

61. An almost innumerable quantity of schemes for improvements on the steam engine have been crowded on the public eye within the last ten years; but except a few for improvements in construction, of small importance, there has been nothing done that is worthy of detaining the reader to notice, towards either the improvement of the engine, or of the mode of generating steam, so as to increase the power of a given quantity of fuel.

62. Some valuable experiments on the elastic force, bulk, and latent heat of steam, made by Mr. John Southern in 1803, were published by Mr. Watt; and the experiments of Dr. Ure and Mr. P. Taylor on the elastic force of steam have led to a considerable advance in theoretical investigation. The improvements in the manufacture of steam engines have also been important, but we have no reason to expect any material increase of its power; it seems to have reached its limit, and we might equally hope to add strength to a man or a horse. New modes of applying the power of steam may be devised, and new objects may be found to which it may be applied with advantage; and its theoretical principles will become more generally and more perfectly known.

¹ Fifth Report on Holyhead Roads' Steam Boats. Mr. Watt's letter, p. 210.

It may also be found that the vapour of some other substance may be used with advantage, in certain cases, instead of that of water; of this, however, there is not much hope; and my reasons for this opinion will be shown in treating of the properties of vapour, (art. 115.) Probably some other source of power will be discovered which will divert the attention of projectors, and the only one in nature which appears unemployed by man seems to be that of the electric fluid; how far it may be rendered useful is a matter of curious inquiry, and dangerous in proportion to its power and our ignorance of its nature.

63. Some idea of the rapid progress of the application of steam power may be formed from the circumstance, that, in the year 1789, the first steam engine was erected in the town of Manchester: before that time the manufactories were dispersed throughout the remotest districts, as they depended chiefly upon falls of water for power, the more expensive one of animal force being the only remaining expedient. The engines of Watt produced the most complete revolution in this respect. The factories were transported from the most wild and inaccessible places to towns and cities, and furnished with the means of uniting, under the same roof, the various branches of manufacture; so that the raw material is now, with astonishing rapidity, converted into the most perfect cloth.

In Glasgow, the first steam engine erected for spinning cotton was put up in January, 1792, by Mr. Robert Muir, at Scott, Stevenson and Co.'s cotton mill, near Springfield. This was seven years after Boulton and Watt put up their first steam engine for spinning cotton in Messrs. Robinsons' mills, at Papplewick, in Nottinghamshire.

In the year 1812 (January 18) Mr. Henry Bell, of Helensburgh, completed his vessel, the Comet, of thirty tons' burthen, with a steam engine of three horse power, and launched her on the Clyde, at Glasgow. This was the first vessel successfully propelled by steam in Europe.

The number of steam engines in Glasgow and its neighbourhood in 1825, as collected by Dr. Cleland, is

	Number of Engines.		Horse power.			
In manufactories	-	-	176	-	-	2970
In collieries	-	-	58	-	-	1411
In stone quarries	-	-	7	-	-	39
In steam boats	-	-	68	-	-	1926
In Clyde iron works	-	-	1	-	-	60
			310			6406
			Total			310

The average horses' power of the engines is 20½.

The steam engines in Great Britain and Ireland, employed in the year 1817 in the manufacture of cotton yarn, amounted to more than 20,000 horses' power; and such has been the advantages resulting from the application of machinery, that one person can produce more yarn in a given time, than 200 could have produced about sixty years ago.

In the iron, woollen, and flax manufactures, the beneficial effects from employing the steam engine have been equally important.

The total extent to which steam power is applied in Great Britain was estimated by Baron Dupin, in 1825, to be equivalent to the power of 320,000 horses in constant action; and up to the present time it has prodigiously increased, independently of our rapidly extending railways. To this immense command of power our country owes much of its commercial prosperity, besides a vast addition to the comforts and conveniences of life.

The increased employment of steam has however in no instance been so great as in its application to navigation in Britain. A solitary steam boat navigated the Clyde in 1812; in 1825, fifty-one steam boats plyed on that river: and from the first successful trial in 1812, up to 1822, the number of steam vessels in Britain increased to about 140, with a power equivalent to the exertion of 4700 horses, and a tonnage of 16,000 tons.¹

64. In concluding this historical sketch, it is of some importance to remark, that the whole tends to prove that the steam engine, in the highest state of perfection it has yet attained, is entirely of British origin. The remark extends to the discovery of physical principles, as well as of mechanical combinations. No new principle, no new combination of principles, has yet been derived from a foreign source; the most perfect of foreign steam engines being professedly copied from British ones, and not unfrequently manufactured by British workmen.

¹ From the establishment of Boulton and Watt alone, since 1814, a power has been sent forth for propelling steam vessels amounting to 9143 horses, and employing a tonnage of 27,406 tons. This, and the streams of power emanating from other factories, for the same exclusive purpose, is immense. It cannot be doubted that steam navigation will be highly productive of benefit to all civilized countries, and will contribute even to the cultivation and advancement of civilization itself: there is no portion of the habitable globe, however remote, which may not in the course of time derive advantage from the creations of Watt's genius.

SECTION II.

OF THE NATURE AND PROPERTIES OF STEAM, ITS ELASTIC FORCE, EXPANSIVE FORCE, AND POWER OF MOTION.

ART. 65. NATURAL bodies exist in three states; the solid, the liquid, and the gaseous. The state of many of them may be changed: thus, water may be in the solid state as ice, in the liquid as water, in the gaseous as steam, and these changes take place only under particular degrees of heat and pressure; but there are some gaseous bodies which cannot be reduced to the liquid form by the means we at this time are acquainted with; though there has been so much accomplished as to render it tolerably certain, that all the gases known would be reduced to liquids, were they exposed to sufficient pressure and reduction of temperature.

66. Those gases which are not changed into liquids by the ordinary changes of temperature and pressure, are called PERMANENT GASES.

The gases which condense into liquids by the common changes of temperature and pressure, are called VAPOURS, or STEAMS: we shall use the term 'steam' in preference to 'vapour.'

67. Heat, free and uncombined, is diffused through all bodies in nature, whether they be in the state of solids, liquids, or gases; and it constantly tends to an equilibrium; so that, when by any means it is accumulated in particular substances, a portion is quickly given off to the surrounding bodies, so as to bring the whole to one common temperature. On the other hand, where bodies have been deprived of a portion of it, heat is given off to them by, or heat passes to them from, the surrounding bodies, to restore the equilibrium.

68. When there is an equilibrium of heat, or the adjoining bodies are of the same temperature, if it be destroyed by the introduction of a fresh quantity of heat, different bodies will be found to absorb different quantities of the new portion of heat in restoring the equilibrium. The peculiar quantity which each body absorbs under the same circumstances, is denominated the SPECIFIC HEAT of that body. In

comparing the specific heats of bodies, that of water at 60° is considered to be unity, and therefore becomes a measure of all the rest.¹

69. The property of bodies to hold different quantities of heat at the same temperature, is sometimes called *CAPACITY FOR HEAT*; but this term should be applied only to the whole quantity of heat in a body, otherwise it becomes the same as specific heat. Hence, when I speak of the capacity of a body for heat, it must be understood as applied to the whole quantity of heat the body contains.

70. The dimensions of bodies are enlarged when heat is poured into them, and they contract when it is taken from them: and the natural consequence of bodies absorbing different quantities of heat to cause an equal change of temperature, is, that they do not all expand nor contract alike by the change.

The incontrovertible fact, that different substances have different capacities for heat, being established, another necessarily presents itself, which, though it could not possibly escape observation, has seldom been properly applied: it is, that in every chemical change we effect, we are altering the capacities of bodies for heat, and, consequently, deranging the equilibrium of heat; for the products differ in their capacity from the ingredients.

71. By the mere addition of heat many solids assume the form of liquids, and liquids the gaseous state. On the other hand, gases, by an abstraction of heat, become liquids, and liquids solids. But even this change of state is accompanied by a change of capacity. The capacity of steam for heat is greater than that of water; for steam requires an additional quantity of heat; and that heat which is required to expand the particles of a liquid to the distance they are apart in the state of steam, does not affect the thermometer; that is, when a given quantity of water, after being heated to 212°, is converted into steam of the same temperature, the heat necessary to produce the entire change, from water to steam, would raise the temperature of nearly six times as much water from the mean temperature to 212°.

72. The heat absorbed by steam or vapour during its formation, is called *LATENT HEAT*: it is, however, a term which conveys a false notion of the state of heat in bodies; for the heat is not latent, it is simply a difference of quantity, and not of quality; and some term that would convey a more accurate idea of the phenomena would be better.

¹ The specific heat of a body is the quantity of heat requisite to change its temperature any stated number of degrees, compared with that which would produce the same effect on water at 60°; and it is therefore expressed by the fraction

$$\frac{\text{quantity of heat to change the temperature by any given amount, say } 1^{\circ}}{\text{quantity of heat to change an equal weight of water at } 60^{\circ} \text{ by the same amount.}}$$

An equal volume of water may be taken instead of an equal weight. In any case, therefore, it is necessary to understand whether the term 'specific heat' is applied to volumes or weights.

73. The heat combined or disengaged by a change of the state of a body, called latent heat, is measured in the same manner as specific heat; that is, by means of the quantity of heat necessary to raise the temperature of water one degree at 60°.

It was the eminent Dr. Black who first discovered (in 1762) that a change of state in natural bodies requires a certain addition or diminution of heat; and that the quantity is different for different bodies, and also different according to the nature of the change. The importance of this discovery to general science is great, and its finest practical application is to the principles of the steam engine.

74. The additional heat in the vapour or steam of any liquid is not very easily determined; but since the discovery of Dr. Black, experiments have been made by several philosophers, distinguished for their accuracy and skill in such delicate researches. The method adopted by Dr. Black is simple and easily tried, but not accurate. When a vessel containing water is placed on a fire, the water gradually becomes hotter till its temperature reaches 212°, but after that its temperature does not increase. The water is flying off in steam, and the heat not raising the temperature higher, as we know it would do if the vessel were closed, we must conclude, that the heat which would be communicated to the water in a close vessel combines with the steam in an open one, and yet does not increase the temperature of that steam to more than that of boiling water. To ascertain the quantity of heat which is combined with steam, Dr. Black put some water in a tin plate vessel upon a red hot iron. The water was of the temperature 50°; in four minutes it began to boil, and in twenty minutes it was all boiled off. During the first four minutes it had received 162° or $40\frac{1}{2}$ ° per minute. If we suppose that it received as much per minute during the whole process of boiling, the heat which entered into the water and converted it into steam would amount to $40\frac{1}{2}$ ° \times 20 = 810°. This 810 degrees of heat is not indicated by the thermometer, for the temperature of steam is only 212°; therefore Dr. Black called it latent heat.¹ But the result is obviously inaccurate, because steam is formed during the heating of the water to the boiling point, and the vessel is losing heat from its surfaces in unequal quantities; and the effect of the fire is also unequal, being less as the heat of the water increases.

75. The heat required to form steam may be more accurately determined by condensing the steam by a cold fluid, and the heat communicated to the fluid by a given weight of steam gives the additional quantity of heat contained in the steam. Mr. Watt made various trials in this manner in 1781, and those on which he placed the most reliance gave 950° for the additional heat in the steam of

¹ Dr. Thomson's System of Chemistry, vol. i. p. 101.

water.¹ Count Rumford, Mr. Southern, and Dr. Ure also made experiments on this principle.²

Also water may be heated in Papin's digester to 400° without boiling; because the steam is forcibly compressed, and prevented from making its escape. If when heated to 400° the mouth of the vessel be suddenly opened, part of the water rushes out in the form of steam, but the greater part still remains in the form of water, and its temperature instantly sinks to 212°; consequently, 188° of heat have suddenly disappeared. This heat must have been carried off by the steam. Now as about one-fifth of the water is converted into steam, that steam must con-

¹ Watt's Notes on Robison's Mech. Phil. vol. ii. p. 7.

² This mode of conducting the experiment has sometimes led to erroneous results, through a want of attention to the mode of calculation. The quantity of heat being measured by the specific heat of water, let

W be the weight of water used to condense the steam;
t, its temperature after the steam has been condensed in it;
t', the quantity its temperature is raised;
w, the weight of steam;
s, its specific heat when condensed;
 and *x* the whole heat required for its formation into steam.

Then the heat communicated to the water by the steam, is as its weight multiplied by the rise of temperature, or $W t'$.

The condensed steam has the temperature *t* after the operation; and as its whole heat was *x w* before condensation, it must be *t s w* after. Therefore

$$W t' = x w - t s w,$$

or $\frac{W t'}{w} + t s = x =$ the measure of the heat that will form the weight of steam *w*.

If *T* be the temperature of the steam before condensation, and *s'* its specific heat; then

$$\frac{W t'}{w} + t s - T s' = \text{the heat of conversion into steam};$$

and it appears from experiment to be nearly a constant quantity for the same liquid.

But it is usual to suppose the specific heat of equal weights of the steam and the liquid which forms it to be the same, and then

$$\frac{W t'}{w} - s (T - t) = \text{the heat of conversion.}$$

And for water where $s=1$, it becomes

$$\frac{W t'}{w} + t - T = \text{the heat of conversion.}$$

Hence we have this RULE: Multiply the weight of the water used to condense the steam by the increase of its temperature, and divide the product by the weight of the condensed steam. The quotient will express the quantity of heat evolved from the steam, and by adding to it the temperature after condensation, the sum will express the total amount of heat; from which, deducting the temperature of the steam before condensation, there will remain the quantity of heat due to the conversion into steam.

tain not only its own 188°, but also the 188° lost by each of the other four parts; that is to say, it must contain $188^\circ \times 5$, or about 940° of heat.

76. The experiments of Dr. Black are not greatly different from the result obtained by Schmidt, for the latter found the heat of steam to be 5.33 times the heat which is required to boil water of the temperature 32°, the barometer being at 29.84 inches.¹ This is the best mode of expressing the heat, for there is reason to believe that the specific heat of water is not the same for every rise of temperature. But to reduce it to the usual measure in degrees, there are 180° between the boiling and freezing point, hence $180 \times 5.33 = 959.4$ for the additional heat of steam.

77. Mr. Southern, and Mr. W. Creighton in 1803, made some experiments by condensing steam with a considerable degree of care; the steam being generated at different temperatures and pressures. The pressure, temperature, heat of formation, and bulk of the steam, from a cubic inch of water, are shown in the following table:

Pressure in inches of mercury.	Temperature.	Heat required to form the steam.	Bulk of steam from one cubic inch of water at 60°.	Bulk calculated from the first experiment.
40	229°	1157°	208	1208
80	270	1244	588	635
120	295	1256	404	427

If from the whole heat we deduct the difference of temperature, we have 1157°, 1203°, and 1190°; whence it appears that the heat to form steam is nearly a constant quantity when the temperature is the same, being independent of the density.

Therefore the most convenient mode of expressing the quantity of heat is that adopted by Mr. Southern, which consists in ascertaining the constant quantity of heat required to be added to the actual temperature of the steam to give the whole heat necessary to form it. This quantity is

$1157 - 229 = 928^\circ$; $1244 - 270 = 974^\circ$; and $1256 - 295 = 961^\circ$; and the mean is 954°.

In another set of experiments, made under the same pressures and temperatures, the quantities of heat required in addition to the temperature were 942°, 942° and 950°,² the mean being nearly 945°, and the mean of both sets 949°. In this set of experiments an allowance was made for the heat communicated to the vessel; in the former set none was made.

¹ Nicholson's Philosophical Journal, vol. v. p. 208. octavo series.

² Robison's Mechan. Phil. vol. ii. p. 160—166.

These experiments are valuable, because they afford a proof that the additional heat required for steam is either accurately or nearly a *constant quantity*.¹

78. And they also show that the *bulk* or volume of steam is *inversely as the pressure*, when the temperature is not altered. For as 80 : 40 :: 1208 : 604, which added to the expansion would be 635, nearly; and 120 : 40 :: 1208 : 402, and adding the expansion it is 427, nearly; and conversely the *density* is *directly as the pressure*; the experiments being quite as near as could be expected in so extremely delicate an operation.

79. Count Rumford obtained a higher result; and from his known skill in such inquiries, much confidence may be placed in his experiments. The heat was measured by means of the temperature communicated to a copper vessel filled with water, which he called his calorimeter. Within this calorimeter a thin serpentine pipe of copper contained the steam to be condensed; hence the fluids did not mix together, and loss by the escape of vapour was prevented.

The water which the calorimeter contained was of a lower temperature than that of the room by 5° or 6°; and when the thermometer of the calorimeter announced an augmentation of temperature of 10° or 12°, an end was put to the experiment.

The water produced by the condensation of the vapour in the serpentine was carefully weighed, and from its quantity, as well as from the heat communicated to the calorimeter, the heat developed by the vapour in its condensation was determined.

As a small part of the heat communicated to the calorimeter was produced from the cooling of the water, condensed in the serpentine pipe after the vapour had been changed into water, an account was kept of this heat. It was supposed that the water at the moment of condensation was at the temperature of 212°, being that of boiling water; and it was determined by calculation, what part of the heat communicated to the calorimeter must have been owing to the boiling water.

In making this calculation, Count Rumford remarks, no “account was taken of the difference in the capacity of water for heat, which depends on its temperature: this is but imperfectly known; and besides, the correction which would have been the result could not but have been very small.”

The following are the details and results of two experiments made on the 21st of January, 1812. The duration of each of the two experiments was from ten to eleven minutes. The water had been boiled for some time to drive out the air which it contained, before the steam was directed into the serpentine pipe of the calorimeter.

¹ M. Despretz, *Ann. de Chim. et de Phys.* xxiv. 329. makes it 955°·8.

Temperature of the room.	State of the calorimeter, equal in specific heat to 42909 grains of water.			Quantity of vapour condensed into water.	Heat of conversion of the water into vapour in degrees.
	Temperature at the beginning.	Temperature at the end.	Elevation of its temperature.		
61°	55½°	67½°	12¼°	Grains. 457	1029°·3
62¼	57	67½	10½	377	1052·3
				Mean - -	1040·8 ¹

The result of the second experiment being compared by our formula, (note to art. 75,) we have

$$\frac{42909 \times 10\frac{1}{2}}{377} + 67\frac{1}{2} = 1262^{\circ}\cdot 5,$$

from whence, deducting 212° on the supposition that the specific heat of steam is equal to that of water, we have 1050°·5 for the constant quantity of heat for conversion into steam. The very small difference between this and Count Rumford's result, arises from the fractions neglected in reducing the French to English weights.

80. Count Rumford also made experiments on the quantity of heat developed in the condensation of the vapour of alcohol: the results of these experiments were less regular than those of the experiments made with water, as might have been expected, but they were nevertheless sufficiently uniform to give the quantity of heat with considerable certainty.

The vapour which is extricated from spirit of wine, when boiled, varies a little with the intensity of the fire used in boiling it; he took care therefore to note the time which was taken in every experiment, in order to be able to judge, by comparing the quantity of vapour condensed with the time employed to form it, of the intensity of the heat employed to boil the liquid. In the following table will be found the details and results of five experiments made on the same day, (January 21, 1812,) with alcohol of different degrees of strength. The specific heat of the calorimeter and the water it contained, was always equal to that of 42909 grains of water; and the thermometer employed was that of Fahrenheit.

Specific gravity of the alcohol employed.	Time employed in the experiment.	Temperature of the apartment.	State of the calorimeter.			Quantity of alcohol condensed in the calorimeter.	Heat of conversion of the liquid into vapour.
			Temperature at the beginning.	Temperature at the end.	Elevation of its temperature.		
81763	4¼ min.	61°	56°	66½°	10½°	Grains 875	479°·92
84714	8 —	60½	55½	65½	10	755	500·03
85342	7 —	61	54¼	68½	14¼	1079	499·54
85342	5 —	61	56	66¼	10¼	805	476·83
85342	6½ —	64	57	71½	14½	1102	499·65
						Mean - -	491·13

¹ Philosophical Mag. vol. xliii. p. 65.

On determining, by calculation, the quantity of water which may be heated *one degree*, by the heat developed in the condensation of the vapour, he took care to keep an account of the difference of the capacity of water for heat from that of alcohol.¹

The result of Count Rumford's calculation is nearly the same as by the formula, (art. 75, note,) when we assume the specific heat of the alcohol vapour and liquid to be the same, and equal to 58. Thus from the second experiment

$$\frac{42909 \times 10}{755} + (.58 \times 65.5) = 606^{\circ}3,$$

from whence, deducting $173 \times .58$ for the heat due to the temperature of the vapour, we have 506° nearly, for the heat of conversion from liquid to vapour. The Count's number is 500.03.

Count Rumford also ascertained that the vapour of sulphuric ether afforded only about half the heat in condensation that alcohol afforded, or one-fourth of the heat furnished by condensing the steam of water.

81. Important as a knowledge of the heat of conversion into vapour is, it was not further investigated till 1817, when Dr. Ure made a few experiments on different bodies.² His mode of experiment was exceedingly simple. The apparatus consisted of a glass retort of very small dimensions, with a short neck, inserted into a globular receiver, of very thin glass, about three inches in diameter. The glass was fixed steadily in the centre of 32340 grains of water, at a known temperature, contained in a glass basin. Of the liquid, whose vapour was to be examined, 200 grains were introduced into the retort, and rapidly distilled into the globe by the heat of an Argand lamp. The temperature of the air was 45° , that of the water in the basin from 42° to 43° ; and the rise of temperature occasioned by the condensation of the vapour never exceeded that of the air by four degrees. As the communication of heat is very slow between bodies which differ little in temperature, the air could exercise no perceptible influence on the water in the basin during the experiment, which was always completed in five or six minutes. A thermometer of great delicacy was continually moved through the water, and its indications were read off, by the aid of a lens, to small fractions of a degree.

The distillation was rapidly performed; and we are assured by Dr. Ure, that in the numerous repetitions of the same experiment, the accordances were excellent. The following table gives the mean result, the last column being calculated by the formula, (of note to art. 75.)

¹ Philosophical Mag. vol. xliii. p. 67.

² Philosophical Transactions for 1818.

Liquid.	Specific gravity.	Temperature of the water in the basin.			Boiling point.	Heat of conversion into vapour.
		At the beginning.	At the end.	Difference.		
Water	1·000	42°·5	49°.	6°·5	212°	942°.
Alcohol	0·825	42·	45·	3·	175	425·5
Sulphuric ether	0·7	42·	44·	2·	112	302·6
Oil of turpentine	0·888	42·	43·5	1·5	316	146·0
Petroleum	0·75	42·5	44·	1·5	306	150·0
Nitric acid	1·494	42·	45·5	3·5	165	517·0
Ammonia	0·978	42·	47·5	5·5	140	840·0
Vinegar	1·007	42·5	48·5	6·		870·0

The quantity of water of which the specific heat would be equivalent to the heat absorbed by the vessels, Dr. Ure has not given; but in assuming it to be about 1660 grains, we shall be not far distant from the truth. Hence we have $32340 + 1660 = 34000$ for the water equivalent to the specific heat of the cooling apparatus; and by the formula, (art. 75, note)

$$\frac{34000 \times 6\cdot5}{200} + 49 - 212 = 942^\circ, \text{ for water.}$$

$$\text{And } \frac{34000 \times 3}{200} + \cdot65 (175 - 45) = 425^\circ\cdot5, \text{ for alcohol.}$$

The others being calculated in the same manner, afford the results in the last column, taking the specific heat from the usual tables. Through an oversight in calculation, Dr. Ure's numbers in the 'Philosophical Transactions' are erroneous.

82. A further correction might be applied for the quantity of steam remaining in the retort, and the loss of heat in the operation. Dr. Ure has, in a recent correction for loss of heat, made the heat of conversion of water into steam 1000; and under the impression that Count Rumford's are the most accurate experiments on the subject, I am inclined to think this number about right. If for these sources of loss we make a further allowance in Dr. Ure's experiments of the specific heat of 2000 grains of water, we shall have

$$\frac{36000 \times 6\cdot5}{200} + 49 - 212 = 1007^\circ;$$

and correcting the rest of the numbers in this manner, the following are obtained.¹

Liquid.	Equal weights.	Equal volumes.	Liquid.	Equal weights.	Equal volumes.
Water into steam	1007°	1007°	Petroleum into vapour	165°	124°
Alcohol into vapour	455·5	375	Nitric acid into vapour	552	830
Sulphuric ether into vapour	322·6	227	Ammonia into vapour	895	875
Oil of turpentine into vapour	161·0	143	Vinegar into vapour	930	936

¹ Ure's Dictionary of Chemistry, art. Caloric.

Having followed through the best information hitherto laid before the public, on the heat required to produce steam, our next object must be to convert it into a form more directly useful for our purpose; for the quantity of heat which converts a liquid into vapour, requires the additional facts of the volume of the vapour, and its elastic force, to render it valuable.

OF THE ELASTIC FORCE OF STEAM.

83. To obtain a rule for determining the force of steam at any temperature, or the temperature corresponding to any given force, we must have recourse to a rule found by trial from the best experiments: it is not a satisfactory method, but we have no other means of arriving at a rule in a case where the real causes of variation are not understood. We still, however, may gain some assistance, from previous reasoning, in forming our conclusions. In the first place, the index of the power representing the law of variation must be of such a simple kind as to render it probable that it is the true one. Hence the index 5.13 employed by Mr. Southern¹ is not likely to represent the law of nature: Mr. Creighton's index 6,² or Dr. Young's, which is 7,³ are either of them more likely to be accurate. The true equation may be very complex, but this is not probable, and while we are ignorant of its nature, and can represent the results sufficiently near for practical use, by one index, it is best to adopt the simplest form, and particularly when it is equally as likely to be the true one as one of a more complex kind. In any attempt to find the index by the usual method of differences, the errors of experiment will have too great an influence.

84. Secondly. It appears probable that there is a degree of cold at which steam cannot exist;⁴ and this must be the case when it is condensed by cold, till the cohesive attraction of the particles exceeds the repellent force of the caloric interposed between them; and the change from an elastic fluid to a solid may then take place without the intermediate stage of liquidity. This physical circumstance enables us to fix another element in the calculation; for there must be a temperature when the force is nothing.

85. Thirdly. The greatest possible force of steam must next be considered; for we are certain that our formula must be in error if it exceeds that limit. Suppose a given quantity of water, a cubic inch for example, to be confined in a

¹ Robison's *Mechanical Phil.* vol. ii. p. 172.

² *Phil. Mag.* vol. liii. p. 266.

³ *Natural Phil.* vol. ii. p. 400.

⁴ An interesting paper on this subject by Mr. Faraday renders it equally so, and shows that the limit is different for different vapours: my formula had led me to the same conclusion; hence it has another property, justified by experience. See *Phil. Mag.* vol. lxxviii. p. 344.

close vessel which it exactly fills; and that in this state it is exposed to a high temperature. Then, as the bulk when expanded is to the quantity the bulk is increased by expansion, without change of state, so is the modulus of elasticity of water of that temperature to the force of steam of the same density as water. If our rule therefore gives steam a greater force than this at the same density and temperature, it must be erroneous. With these limitations we must in a considerable degree be guarded against error, and the method followed is next to be explained.

86. Let f be the elastic force of steam, in inches of mercury, and t the corresponding temperature; and let a be the temperature at which the expansive force is 0. Consider f the abscissa, and $t-a$ the ordinate of a curve, of which the equation is $Af = (t-a)^n$, whence the coefficient

$$A = \frac{(t-a)^n}{f}.$$

Let the abscissa increase to f' , and the ordinate to $t'-a$; then

$$\frac{(t-a)^n}{f} = \frac{(t'-a)^n}{f'}; \text{ or } \frac{\log. f' - \log. f}{\log. (t'-a) - \log. (t-a)} = n.$$

Now, if these points be near one extremity of the range of experiment, and two other points be taken near the other extremity, then

$$\frac{\log. f''' - \log. f''}{\log. (t'''-a) - \log. (t''-a)} = n, \text{ and consequently}$$

$$\frac{\log. f''' - \log. f''}{\log. f' - \log. f} = \frac{\log. (t'''-a) - \log. (t''-a)}{\log. (t'-a) - \log. (t-a)}.$$

From four results of Mr. Southern's experiments on steam from water, we find that $a = -100$ very nearly satisfies the conditions; and this value of a being inserted, we find $n=6$ and $A=177$, or its logarithm $=2.24797$.

Therefore, for water,

$$f = \left(\frac{t+100}{177}\right)^6; \text{ or } t = 177 (f)^{\frac{1}{6}} - 100.$$

In logarithms,

$$\log. f = 6 \left\{ \log. (t+100) - 2.24797 \right\}.$$

87. If the expansion of confined water, when its temperature is raised to 1150 degrees of heat, be 0.9693 of its bulk, the force necessary to confine it to its bulk at 60°, when exposed to a heat of 1150°, the modulus of water being 22100 atmospheres at 60°, would be about 6925 atmospheres.¹ Our rule gives for the force of

¹ The expanding power of heat, and the decrease of the modulus of elasticity, must be in the same ratio; and most probably both vary as the square of the central distances of the atoms, and

steam at that temperature and density 4137 atmospheres; and in the uncertainty both as to what the actual expansion of water would be in such high temperatures, and the decrease of its modulus, it is more prudent to be within than beyond the limit. But at or near the temperature 1150°, the rule will cease to be of any use, because then it is simply the expansive power of compressed water; and it varies as the quantity of water expands by a given change of temperature.

Having thus far explained the methods by which the rules have been obtained, it only remains to give them the most simple form for use, with illustrative examples.

88. RULE I. To find the force of steam from water in inches of mercury, the temperature being given.¹

consequently as the $\frac{2}{3}$ power of the volume. Hence, if e be the expansion, the original bulk being unity, and m the modulus, it must be

$$\frac{m}{(1+e)^{\frac{2}{3}}} = \text{the modulus at any expansion } e;$$

and consequently (by art. 85.)

$$1+e : e :: \frac{m}{(1+e)^{\frac{2}{3}}} : \frac{m e}{(1+e)^{\frac{2}{3}}} =$$

the force of compression capable of retaining the fluid in its original state of density.

The expansion varies as the expanding power of heat, and as the temperature; hence it will be as the $\frac{5}{3}$ power of the temperature; and it must be 0 at 40°: consequently, $A(t-40)^{\frac{5}{3}}=e$, and as from 40° to 212° it is found to be .04333, we have $\frac{5}{3} \log. (t-40) - 5.08909=e$; which suggests the following Rule:—Subtract 40 from the temperature; under the logarithm of the difference, write its one-third part twice over, and add all three up; from the sum subtract 5.08909, and the remainder will be the logarithm of the expansion.

The agreement of this formula and rule with experiment is shown in the following table:—

Temperature.	Expansion by formula.	Expansion by experiment.	Temperature.	Expansion by formula.	Expansion by experiment.
40°	0.00	0.00	400°	0.1484	
64	0.00159	0.00133	800	0.5155	
102	0.00791	0.0076	1150	0.9693	
212	0.0433	0.04333	1171	1.0000	

In the equation for the force at 1150 degrees of temperature, we have

$$\frac{m e}{(1+e)^{\frac{2}{3}}} = \frac{22100 \times .9693}{(1.9693)^{\frac{2}{3}}} = 6925 \text{ atmospheres.}$$

¹ Mr. Southern's Rule, which applies with considerable accuracy up to very high temperatures and pressures, is in substance as follows:—

Add 51°·3 to the temperature, and multiply the logarithm of the sum by 5·13; from the product deduct 10·94123; then, finding the natural number answering to the remainder, and increasing it by one tenth, the result will express the required pressure in inches of mercury.

Add 100 to the temperature, and divide the sum by 177 ; the sixth power of the quotient is the force in inches required.

Example. To find the force of steam for the temperature 312°.

$$\frac{312+100}{177} = 2.3277.$$

Raise this to the sixth power, and it gives 159 inches for the force of the steam in inches of mercury.

Or by logarithms. Add 100 to the temperature, and from the logarithm of this sum subtract 2.24797 ; and six times the difference is the logarithm of the force in inches of mercury.

Example. To find the force of steam for the temperature 250°.

Log. (250+100=350) is	-	2.54407
Subtract constant log.	-	2.24797

Difference	-	0.29610
		6

$$\text{Log. of force in inches of mercury} = \text{log. } 59.79 = 1.77660$$

89. RULE II. The force of the steam of water being given to determine its temperature.

Multiply the sixth root of the force in inches by 177, and subtract 100 from the product, which gives the temperature required.

Example. Let the force of steam be eight atmospheres, or 240 inches of mercury, to find its temperature.

The sixth root of 240 may be easily found by a table of squares and cubes, by first finding its square root, and then the cube root of the square root. Thus the square root of 240 is 15.492, and the cube root of 15.492 is 2.493 ; hence, $(2.493 \times 177) - 100 = 341.20$. Mr. Southern's experiment gives 343.6.

Or by logarithms. To one-sixth of the logarithm of the force in inches add 2.24797 : the sum is the logarithm of a number, from which 100 being subtracted the remainder will be the temperature required.

Example. Let the force of steam be equal to sixty inches of mercury, which is nearly fifteen pounds on the square inch above the pressure of the atmosphere, to find its temperature.

Log. 60 is	-	-	1·77815
and one sixth is	-		0·29636
constant log.	-		2·24797
Log. 350·2	-	-	2·54433

from which subtract 100, and it gives $250^{\circ}·2$ for the temperature. Mr. Southern's experiment gives $250^{\circ}·3$.

90. When sea water is employed, as it boils at a different temperature, the force of the steam is different. The correction in the rules is easily made by finding the constant number which corresponds to a force of thirty inches of mercury, at the boiling point, with different degrees of saturation with salt. Many of the people employed about boat engines are not yet aware that there is a difference between the temperature of steam from common water, and that from salt water, when the force is the same. I will show in another place (Sect. IV.) the effect this has on the power of the steam engine, but at present our object is to determine the force of the steam. Mr. James Watt was the only person who had made experiments on the steam of salt water; they were made in 1774.¹ He does not give them as being very accurate ones, but they are sufficient to establish the fact that there is a difference; and Mr. Faraday has lately had occasion to satisfy himself on the same point, by various experiments.²

91. The following table gives the boiling points of solutions of different salts in water.

Name of salt.	Dry salt in 100 parts by weight of the solution.	Boiling point.	Authority.
Acetate of soda	60	256°	Griffiths. ³
Nitrate of soda	60	246	_____
Common salt	37	226	My trials.
Muriate of soda	30	224	Griffiths.
Ditto		222·35	Achard. ⁴
Sulphate of magnesia	57·5	222	Griffiths.
Sulphate of lime	45	220	_____
Alum	52	220	_____
Sulphate of iron	64	216	_____
Sulphate of soda	31·5	213	_____
Ditto		217·6	Achard.

¹ Robison's Mechanical Phil. vol. ii. p. 34. ² Quarterly Journal of Science, vol. xiv. p. 440.

³ Quarterly Journal of Science, vol. xviii. p. 90. ⁴ Thomson's Chemistry, vol. ii. p. 14.

92. According to the analysis of Dr. John Murray, 10,000 parts of sea water, of the specific gravity 1.029,¹ contain

Muriate of soda	-	-	220.01	=	$\frac{1}{46}$	
Sulphate of soda	-	-	33.16	=	$\frac{1}{302}$	
Muriate of magnesia	-	-	42.08	=	$\frac{1}{238}$	
Muriate of lime	-	-	7.84	=	$\frac{1}{1276}$	

				303.09	=	$\frac{1}{32}$

Or 1 part of sea water contains .030309 parts of salts = $\frac{1}{33}$ of its weight.

93. Now as the salts do not rise with the steam, the water in a boiler supplied with sea water becomes gradually more saturated, and after a certain time begins to deposit salt, if the means that have been invented for that purpose be not employed to prevent it.² (See Sect. III.) And even then a certain degree of saturation must be allowed to take place. The following table, with the constant numbers for different degrees of saturation, will serve to illustrate this matter. The boiling point of water appears to be increased one degree by each addition of 2.6 parts to the proportion of common salt in 100 parts of water; at least, so nearly, that this regular law does not materially differ from the mean results of my experiments, which were made with a considerable degree of care; but it is difficult to make them, on account of the degree of saturation constantly varying during the experiment.

Proportion of salt in 100 parts by weight.		Boiling point.	Constant number.	Constant log.
Saturated solution	36.37 = $\frac{12}{33}$	226°	185.0	2.26703
	33.34 = $\frac{11}{33}$	224.9	184.3	2.26556
	30.30 = $\frac{10}{33}$	223.7	183.6	2.26396
	27.28 = $\frac{9}{33}$	222.5	183.0	2.26234
	24.25 = $\frac{8}{33}$	221.4	182.3	2.26086
	21.22 = $\frac{7}{33}$	220.2	181.6	2.25923
	18.18 = $\frac{6}{33}$	219.0	181.0	2.25760
	15.15 = $\frac{5}{33}$	217.9	180.4	2.25610
	12.12 = $\frac{4}{33}$	216.7	179.7	2.25446
	9.09 = $\frac{3}{33}$	215.5	179.0	2.25281
	6.06 = $\frac{2}{33}$	214.4	178.3	2.25130
	Sea water 3.03 = $\frac{1}{33}$	213.2	177.6	2.24950
Common water 0	212.	177.0	2.24797	

¹ Philosophical Magazine.

² On the first trip of the City of Edinburgh steam ship to Leith, in 1821, this was found to take place to the detriment of the boiler; and the deposit was so considerable as to require its being cleared out during the passage, while the vessel proceeded under her canvas. This circumstance led Boulton and Watt, who manufactured the engines, to adopt a method of extracting the satu-

94. The next point is to compare the formula with experiment; and we shall commence with Mr. Watt's experiments on salt water. The water was nearly saturated with salt: it was more free from air than common water, but it parted with difficulty from that which it contained. The results compared with the formula for saturated salt are shown in the following table.

WATT'S EXPERIMENTS ON THE STEAM FROM SALT WATER.

Temperature.	Force in inches of mercury.		Temperature.	Force in inches of mercury.	
	Watt's observations.	Formula for saturated solution. ¹		Watt's observations.	Formula for saturated solution. ¹
46 ^o	0·01	0·24	195 ^o ·5	15·34	16·64
85	0·58	1·00	201·5	17·16	18·77
113	1·72	2·33	207	19·34	20·92
139	3·54	4·66	210	21·8	22·18
160	6·27	7·72	212	22·74	23·05
169	8·12	9·47	216	24·6	24·87
180	10·85	12·04	218	25·52	25·84
187	12·67	13·01	220	26·5	26·84

In these, as in all the early experiments on the force of steam, the force is less than it ought to be at low temperatures.

Mr. Watt's experiments on pure water afford a like discrepancy, as will be found by comparing the following table of results taken at random out of his series.²

WATT'S EXPERIMENTS ON PURE WATER.

Temperature.	Force in inches of mercury.	
	Watt's observations.	By our Rule, page 59.
55 ^o	0·15	0·45
118	2·68	3·59
180	14·73	15·67
225	37	38·32
240	49	50·24
261	68	72·00
272·5	82	86·89

rated water from the bottom, or lower part of the boiler, by means of a pump, and subsequently by means of their blow-off pipes and cocks, now generally followed: the operation of blowing off is usually attended to every three or four hours.

¹ The results in this column are calculated by the Rule 1, by *logarithms*, given at page 59, with this difference, that instead of subtracting 2·24797 as for common water, the number 2·26703, as given in the preceding table, is used for saturated solution.

² Robison's *Mechan. Phil.* vol. ii. p. 32—34.

The explanation offered by Mr. Watt himself is not sufficient to account for the difference, except in the lower temperatures. He supposes the stationary barometer must have had its scale placed $\cdot 2$ of an inch too low; and if so, the same addition would be required to the forces in the preceding table on salt water. These tables, however, are not selected for minute accuracy, but to show the important fact, that the force of the steam of water depends on the temperature of the liquid which produces it, or which is in contact with it. For this they are sufficiently correct; and it is a circumstance which affects its elastic force both in the boiler and in the condenser, and is peculiarly interesting to those concerned in steam vessel engines. The temperatures not being the same, the comparison is not so easy; but at 180° the force of salt water is 10.85; that of pure water 14.73 inches: at 212° salt water has a force of 22.74; pure water 29.56.

95. The experiments made by Professor Robison were tried in a similar manner; and as a method the same in effect was used by Bettancourt, whose results agree extremely well with Robison's, the description of it may be useful.

Professor Robison's apparatus for determining the force of steam.—This apparatus, in the first trials, consisted of a small digester of copper, A B C D, in the figure: the top had a thermometer inserted through the centre, and a loaded valve at V; and a third hole for inserting a barometer tube S G F, to ascertain the force at lower temperatures than 212° . The force at the higher temperatures than 212° was measured by the steelyard on the valve, a plug being inserted in the place of the tube S G F; but the results with the valve were irregular and unsatisfactory. Hence, the glass tube M N K, having a cistern L for mercury, was adapted to the hole in the digester; and instead of measuring the force by the valve, it was measured by the ascent of the mercury in the tube M N. The digester was heated by a lamp.

To determine the pressure at temperatures below 212° , the tube S G F was inserted as in the figure, and a basin of mercury provided at F. The lamp being applied, the water in the digester produced steam till it issued at both the valve and the pipe F, so as to expel the air: the lamp being removed, and both the valve and tube being closed, the latter by immersing it in the mercury, the mercury rose in the tube F G as the apparatus cooled, and the heights corresponding to different temperatures were noted: like observations were made as it re-heated.

FIG. 10.

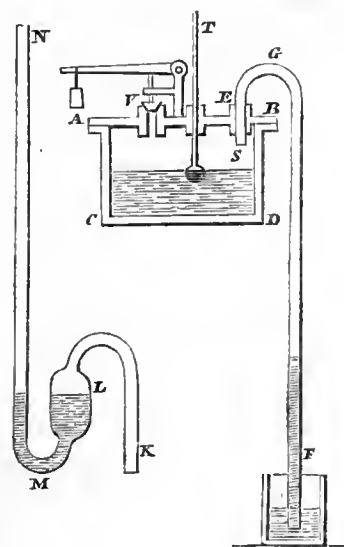

To determine the pressure at higher temperatures with the apparatus, the end K of the tube M N K was inserted at E; and as the temperature increased, the pressure of the steam in the cistern L caused the mercury to ascend, and consequently afforded a means of measuring the amount of expansive force.

The objection to this mode of trial is, that the temperature of the mercury must be continually changing during the trial, and steam must be either condensing or generating on its surface during the time of observation. At each observation the temperature of the whole of the apparatus ought to be the same, and then the column exhibiting the pressure ought to be reduced to its equivalent at the mean temperature. The only observation where these circumstances would have place was that which appears to have been made when the thermometer was at 42° ; then the column in the syphon was 29.7, and the barometer stood at 29.84: the difference is the force of steam at 42° , and is 0.14 inches. By cooling down to 32° the force was not perceptibly different, and we know from later trials that this is nearly correct. Professor Robison, however, seems to have thought it was necessary to have the force 0 at 32° .¹

ROBISON'S EXPERIMENTS ON THE FORCE OF STEAM.

Temperature of the steam.	Force of steam in inches of mercury.		Temperature of the steam.	Force of steam in inches of mercury.	
	By Dr. Robison's experiments.	By our Rule, page 59.		By Dr. Robison's experiments.	By our Rule, page 59.
32°	0.0	0.172	160°	8.65	10.05
40	0.1	0.245	170	11.05	12.6
50	0.2	0.37	180	14.05	15.67
60	0.35	0.55	190	17.85	19.35
70	0.55	0.78	200	22.62	23.71
80	0.82	1.106	210	28.68	28.86
90	1.18	1.53	220	35.8	34.92
100	1.6	2.08	230	44.5	42.0
110	2.25	2.79	240	54.9	50.24
120	3.0	3.68	250	66.8	59.79
130	3.95	4.81	260	80.3	70.8
140	5.15	6.21	270	94.1	83.45
150	6.72	7.94	280	105.9	97.92

If the elastic force .14, from which Robison began to register, had been added to all the experiments below 212° , as it ought to have been, they would have agreed extremely near with the results of later experiments. The experiments made by Achard seldom vary more than a degree or two from those in the above table.

96. Mr. Dalton's inquiries were conducted by a different method. He took a

¹ Mechan. Phil. vol. ii. p. 36.

barometer tube, made perfectly dry, and filled it with mercury just boiled, marking the place where it was stationary ; then graduated the tube into inches and tenths by means of a file : into this tube he poured a little water, (or any other liquid the subject of experiment,) so as to moisten the whole inside ; after this, he again poured in mercury, carefully inverting the tube to exclude all air. The barometer, by standing, sometimes exhibited a portion of water, &c. of one eighth or one tenth of an inch, upon the top of the mercurial column, because being lighter it ascends by the side of the tube ; which may now be inclined, and the mercury will rise to the top, manifesting a perfect vacuum from air. He then took a cylindrical glass tube, open at both ends, of 2 inches diameter, and 14 inches in length ; to each end of which a cork was adapted, perforated in the middle so as to admit the barometer tube, to be pushed through and to be held fast by them : the upper cork was fixed two or three inches below the top of the tube, and half cut away so as to admit water, &c. to pass by ; its service being merely to keep the tube steady. Things being thus circumstanced, water of any temperature may be poured into the wide tube, and made to surround the upper part of the vacuum of the barometer ; and the effect of temperature in the production of vapour within can be observed from the depression of the mercurial column. In this way, he says, he had water as high as 155° surrounding the vacuum ; but as the high temperature might endanger a glass apparatus, instead of it he used the following one for higher temperatures.

Having procured a tin tube of four inches in diameter, and two feet long, with a circular plate of the same soldered to one end, having a round tube in the centre, like the tube of a reflecting telescope ; he got another smaller tube of the same length soldered into the larger, so as to be in the axis or centre of it : the small tube was open at both ends ; and on this construction, water could be poured into the larger vessel to fill it, whilst the central tube was exposed to its temperature. Into this central tube he could insert the upper half of a syphon barometer, and fix it by a cork, the top of the narrow tube also being corked : thus the effect of any temperature under 212° could be ascertained, the depression of the mercurial column being known by the ascent in the exterior leg of the syphon. Mr. Dalton also remarks, that the force of vapour from water between 80° and 212° may be determined by means of an air pump ; and the results exactly agree with those determined as above. Take a florence flask half filled with hot water, into which insert the bulb of a thermometer ; then cover the whole with a receiver on one of the pump plates, and place a barometer gauge on the other : the air being slowly exhausted, mark both the thermometer and barometer at the moment ebullition commences, and the height of the barometer gauge will denote the force of vapour from water of the observed temperature. This method may also be used for other

liquids. It may be proper to observe, that the various thermometers used in these experiments were duly adjusted to a good standard one.

After repeated experiments by all these methods, and a careful comparison of the results, he was enabled to digest a table of the force of steam from water of all the temperatures from 32° to 212°.¹ The only experimental results were the following, which are compared with our formula.

DALTON'S EXPERIMENTS ON THE FORCE OF STEAM.

Temperature of steam.	Force in inches of mercury.		Temperature of steam.	Force in inches of mercury.	
	Dalton's observations.	By Rule page 59.		Dalton's observations.	By Rule page 59.
32°	0·2	0·172	133° $\frac{1}{4}$	4·76	5·24
43 $\frac{1}{4}$	0·297	0·281	144 $\frac{1}{4}$	6·45	6·95
54 $\frac{1}{4}$	0·435	0·442	155 $\frac{3}{4}$	8·55	9·10
65 $\frac{3}{4}$	0·63	0·675	167	11·25	11·7
77	0·91	1·00	178 $\frac{1}{4}$	14·6	15·1
88 $\frac{1}{4}$	1·29	1·447	189 $\frac{3}{4}$	18·8	19·15
99 $\frac{1}{2}$	1·82	2·05	200 $\frac{3}{4}$	24·0	24·07
110 $\frac{3}{4}$	2·54	2·85	212	30·0	30·0
122	3·5	3·89			

From these results he determined the ratio belonging to each interval, and filled in the intermediate degrees by interpolation, considering the forces to increase in a geometrical progression. Above 212° he made no trials at that period, though the table was extended to 325°, and has since been found to be erroneous for the temperatures above 212°.

97. Mr. Dalton afterwards re-examined the subject, and considers from various trials, that the force of steam at 32° cannot be less than 0·2 of an inch; and is most probably 0·25: but with the advantage of having seen the results of Dr. Ure's and Mr. Southern's experiments, and having made new experiments himself for the temperatures between 212° and 300°, he gives the following table, formed from what he considers the most correct experiments on the subject.²

Temperature of steam.	Force of steam in inches of mercury.		Temperature of steam.	Force of steam in inches of mercury.	
	Dalton's numbers.	By Rule page 59.		Dalton's numbers.	By Rule page 59.
36°	0·29	0·201	173°	13·18	13·46
64	0·75	0·633	220	34·20	34·92
96	1·95	1·84	272	88·9	86·2
132	5·07	5·07	340	231·0	236·

¹ Nich. Phil. Journal, vol. vi. p. 263. 8vo.

² Annals of Philosophy, vol. xv. p. 130. for 1820.

It will appear from this, that there is a greater difference between the results of different trials, than between the numbers found by our rule and those results; and hence it may be presumed to be sufficiently exact.

98. For the further satisfaction of the reader, the principal results of Dr. Ure's experiments shall be given, and his simple and elegant mode of making the experiments described; as, in the event of any other species of fluid being found better adapted than water for furnishing vapour, the same mode might be usefully adopted to try its force.¹

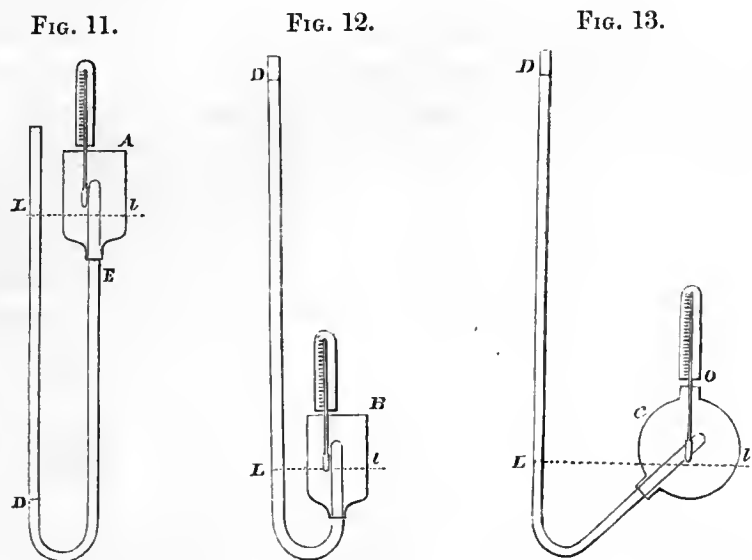

The preceding figure (fig. 11.) represents the construction employed for temperatures under and a little above the boiling point. Figures 12 and 13 were used for higher temperatures; the latter is the more convenient of the two. It was suspended from a lofty window ceiling, and placed with the tube L D in a true vertical position by means of a plumbline. One simple principle pervades the whole train of experiments, which is, that the progressive increase of elastic force developed by heat from the liquid, incumbent on the mercury at *l*, is measured by the length of column which must be added over L, in order to restore the quicksilver to its primitive level at *l*. These two stations, or points of departure, are nicely defined by a ring of fine platina wire twisted firmly round the tube.

¹ Philosophical Transactions for 1818.

At the commencement of the experiment, after the liquid, well freed from air, has been let up, the quicksilver is made to coincide with the edge of the ring l , by cautiously pouring mercury in a slender stream into the open leg of the syphon D. The level ring at L is then carefully adjusted.

From the mode of conducting the experiments, there remained always a quantity of liquid in contact with the vapour, a circumstance essential to accuracy in this research. Suppose the temperature of the water, or the oil in A (fig. 11.) to be 32° , as denoted by a delicate thermometer, or by the liquefaction of ice; and let L D be a column equal to the atmospheric pressure; communicate heat to the cylinder A, by means of two Argand flames, playing gently against its shoulder at each side. When the thermometer indicates 42° , modify the flames, or remove them, so as to maintain an uniform temperature for a few minutes. Then the elasticity will be faithfully represented and measured, by the mercurial column which must be added over D, in order to return the quicksilver to the line l , its zero or initial level.

At E a piece of cork is fixed, between the parallel legs of the syphon, to sustain it, and to serve as a point by which the whole is steadily suspended.

For temperatures above the boiling point, the part of the syphon under E is evidently superfluous, merely containing in its two legs a useless weight of equipoised mercury. Accordingly for high heats, either the apparatus fig. 12 or 13 is employed, and the same method of procedure is adopted. The aperture at O (fig. 13) admits the bulb of the thermometer, which rests against the tube. The recurved part of the tube is filled with mercury, and then a little liquid is passed through it to the sealed end. Heat is applied by an Argand flame to the bottom of c , which is filled with oil or water, and the temperature is kept steadily at 212° for some minutes. Then a few drops of quicksilver may require to be added at D, till L and l be in the same horizontal plane. The further conduct of the experiment differs in no respect from what has already been described. The liquid in c is progressively heated, and at each stage mercury is progressively added over L to restore the initial level, or volume at l , by equipoising the progressive elasticity. The column above L being the accession of elastic force. When this column is desired to be extended very high, the vertical tube requires to be placed for support in the groove of a long wooden prism.

URE'S EXPERIMENTS ON THE FORCE OF STEAM.

Temperature of steam.	Force in inches of mercury.		Temperature of steam.	Force in inches of mercury.	
	Ure's observations.	By Rule page 59.		Ure's observations.	By Rule page 59.
24°	0·170	0·118	190°	19·000	19·35
32	0·200	0·172	200	23·600	23·71
40	0·250	0·245	210	28·880	28·86
50	0·360	0·37	212	30·000	30·00
55	0·416	0·45	220	35·540	34·92
60	0·516	0·55	225	39·110	38·32
70	0·726	0·78	230	43·100	42·00
80	1·010	1·106	240	51·700	50·24
90	1·360	1·53	250	61·900	59·79
100	1·860	2·08	260	72·300	70·8
110	2·456	2·79	270	86·300	82·45
120	3·300	3·68	280	101·900	97·92
130	4·366	4·81	290	120·150	114·4
140	5·770	6·21	295	129·000	123·5
150	7·53	7·94	300	139·700	133·2
160	9·600	10·05	310	161·300	154·5
170	12·050	12·6	312	167·000	159·
180	15·160	15·67	312	165·5	

If a nice agreement with a particular set of observations had been attempted, the formula could have easily been arranged to represent these better; but by so doing it appears to me that the elastic forces would have increased in a higher ratio than we are warranted in expecting from other experiments, and the later inquiries of Mr. Dalton justify the numbers being higher at or about 150° than Dr. Ure's.

99. Mr. Southern's experiments on high pressure steam were made with a digester, with a thermometer fitted to a metallic tube, so that the stem of the thermometer might be immersed as far as it contained mercury. Also, instead of measuring the force of the steam by a loaded valve, a nicely bored cylinder was used, with a piston fitting it so as to have very little friction, to the rod of which a lever was applied, constructed to work on edges like those of a scale beam; and that no error might arise from this construction, a column of mercury was substituted, and the correspondence was within $\frac{1}{100}$ of an inch.

The observations at each of the points of temperature and pressure were continued some minutes, the temperature being alternately raised and lowered, so as to make the pressure in excess and defect; and a mean temperature was taken for the result. This method seems to me entitled to great confidence, and hence I have made the results the principal data for my formula. (See art. 86.)

The experiments below 212° were conducted nearly as Dr. Robison's, and those below 62° were made by Mr. W. Creighton. These low pressure experiments do not seem to be of equal value with the four high pressure ones.

SOUTHERN'S EXPERIMENTS ON THE FORCE OF STEAM.¹

Temperature of the steam.	Force in inches of mercury.		Temperature of the steam.	Force in inches of mercury.	
	Observed force.	By Rule page 59.		Observed force.	By Rule page 59.
32°	0·16	0·172	132°	4·71	5·07
42	0·23	0·266	142	6·10	6·53
52	0·35	0·401	152	7·90	8·33
62	0·52	0·587	162	10·05	10·52
72	0·73	0·842	172	12·72	13·17
82	1·02	1·182	182	16·01	16·35
92	1·42	1·629	212	30·00	30·00
102	1·96	2·21	250·3	60·00	60·00
112	2·66	2·95	293·4	120·00	120·50
122	3·58	3·89	343·6	240·00	247·80

100. A scale of the elastic force of steam at high temperatures was published in 1822 by Mr. Philip Taylor,² which was formed by means of an apparatus not described; but it appears to correspond with the best experiments, and is likely to be near the effect in practice where we may expect some loss of elastic force, compared with the temperature.

TAYLOR'S SCALE OF THE FORCE OF STEAM.

Temperature of the steam.	Force in inches of mercury.	
	Taylor's observations.	By our Rule page 59.
212°	30·00	30·00
220	34·95	34·92
230	41·51	42·00
240	50·00	50·24
250	59·12	59·79
260	70·10	70·8
270	82·50	83·45
280	97·75	97·92
290	114·50	114·4
300	133·75	133·2
320	179·40	178·5

101. The experiments of Schmidt present a surprising accordance with the rule, at the temperatures from 60° to 230°; at these points they slowly separate, the rule being in defect in the highest temperature 290° by 11 inches, and in excess at 43° $\frac{1}{4}$ by 0·163.³

¹ Robison's Mechanical Philos. vol. ii. p. 173.

² Philosophical Mag. vol. ix. p. 452.

³ Dr. Young's Nat. Phil. vol. ii.

102. The force of steam at high temperatures is still wanting to complete the experimental part of the inquiry. A few experiments have been made, which appear to me to be entitled to some confidence, by Professor Arsberger, of Vienna.¹

ARSBERGER'S EXPERIMENTS ON HIGH PRESSURE STEAM.

Temperature of the steam.	Force in inches of mercury.	
	By experiment.	By our Rule page 59.
232°	44·4	43·56
249	59·1	58·7
274	88·8	89·0
322	176·0	183·6
372	325·0	362·
432	620·0	737·

Here the rule is in excess at 432° by more than one sixth; but in an experiment reported by M. Clement, to M. Poisson,² the force of steam at 419° is said to be 35 atmospheres, or 1050 inches of mercury, while our rule gives only 635 inches. I doubt the accuracy of the statement.

103. M. Cagniard de la Tour³ made some essays to ascertain the space and temperature in which a given quantity of water became wholly steam; but from the frequent rupture of the glass tubes, and their loss of transparency, it was difficult to obtain a result. He states, however, that at a temperature but little removed from the melting point of zinc, water could be converted into vapour in a space nearly four times its volume. If this could have been really ascertained with accuracy, it would have given an important datum; but on the above rude approximation no reliance can be placed.⁴

¹ Bulletin des Sciences Tech. vol. i. p. 294.

² Philosophical Magazine, vol. lxi. p. 60.

³ Philosophical Magazine, vol. lxi. p. 58.

⁴ In a paper on the elastic force of steam which has just been published by Mr. Ivory, in the 'Philosophical Magazine,' a completely different process is followed for calculating the force of steam from that I have given; it does not however afford results much nearer to the experiments it is founded on, than those by my formula, while it is somewhat more difficult to apply, and becomes erroneous in high temperatures.

Counting t the temperature from 212° and f the elastic force, his formula is

$$\log. \frac{f}{30} = \cdot 0087466 t - \cdot 000015178 t^2 + \cdot 000000024825 t^3.$$

It is derived from a comparison of Dr. Ure's experiments; and the following table shows the results by those experiments, by Mr. Ivory's formula, by other experiments, and by my formula.

In the absence therefore of proper experiments to ascertain the force of steam, it is difficult to determine a rule that can be depended upon for high temperatures, and we must now try to discover if the force of other vapours will afford any further insight into the subject.

OF THE ELASTIC FORCE OF THE VAPOUR OF ALCOHOL.

104. The elastic force of the vapour of alcohol, or spirit of wine, has been tried by several philosophers. The greater part of the experiments were made in

Temperature of the steam.	Elastic force of steam in inches of mercury.				
	Dr. Ure's experiments.	Mr. Ivory's formula.	Various experiments.		By our Rule page 59.
32°	0·2	0·185	0·16 Creighton		0·172
50	0·36	0·36			0·37
70	0·726	0·721			0·78
90	1·360	1·378			1·53
110	2·456	2·634			2·79
130	4·336	4·408			4·81
150	7·530	7·424			7·94
170	12·05	12·05			12·60
190	19·00	18·93			19·35
210	28·88	28·81			28·86
230	43·10	42·63	41·51	Taylor	42·00
250	61·90	61·50	60·0	Southern	59·79
270	86·30	86·70	82·5	Taylor	83·45
290	120·15	119·9	114·5	Taylor	114·40
310	161·30	162·8			154·5
337		240	234	Christian ¹	226·5
343·6		264	240	Southern	247·8
419		714	1050	Clement	635·0
432		1852	620	Arsberger	737·0

At a temperature of about 770° Mr. Ivory's formula gives an elastic force equal to the modulus of elasticity of water; the steam would, if this were correct, be more dense than water; while La Tour found it required a space four times its volume to become steam at about the same heat. Arsberger's experiments had not been seen by Mr. Ivory, or he would have had reason for doubting the accuracy of M. Clement's observation; but as it is quite unsupported either by a description of the process, or any observations at other temperatures, its deviation in excess both from formulæ founded on a considerable range of experiments, and also from other results, is to be regarded as a motive for doubt rather than for altering our formula. Mr. Ivory most justly remarks, that this furnishes "another instance of the great difficulty of detecting general properties or laws by means of a comparison of particular results;" and it is a difficulty which ought to induce mathematicians possessed of such great powers as Mr. Ivory certainly is, to endeavour to develop the first principles, rather than investigate a formula from experiments alone.

¹ Mécanique Industrielle, vol. ii. p. 232.

the lower ranges of temperature, and in the same manner as those on the force of the steam of water; but in describing them it will be some advantage to begin with the experiments of Cagniard de la Tour, on the space alcohol occupies when converted wholly into vapour. To ascertain this point, alcohol of the specific gravity $\cdot 837$ was introduced into small tubes of glass, and hermetically sealed, with a handle of glass attached to each tube. A tube was two-fifths filled with alcohol, and then slowly and carefully heated: as the fluid dilated, its mobility increased; and when its volume was nearly doubled, it completely disappeared, and became a vapour so transparent, that the tube appeared quite empty. On leaving it to cool for a moment, a very thick cloud formed in its interior, and the liquor returned to its first state. A second tube, nearly half occupied by the same fluid, gave a similar result; but a third, containing rather more than half, burst.

A process was next adopted to ascertain the pressure. It consisted in bending a tube into a syphon, one leg to hold the liquid to be tried, and the other leg containing air kept at a constant temperature of 73° by a cooling apparatus, and separated from the fluid by mercury: both legs being sealed, the end containing the liquid was heated, and when the liquid became vapour the diminution in the bulk of the air was marked.

Alcohol of the specific gravity $\cdot 837$ was reduced into vapour at a temperature of 497° in a space a little less than 3 times its original bulk; and 476 parts of air were reduced to 4; indicating a pressure, according to M. Cagniard de la Tour, of 119 atmospheres, or 3570 inches of mercury.¹

105. The experiments on alcohol vapour at lower temperatures are collected in the following table.

¹ By the same process as was adopted in finding the constants for calculating the force of the steam of water (art. 86.) the formula for the vapour of alcohol of sufficient purity to boil at 173° is

$$f = \left(\frac{t + 100}{154.9} \right)^6;$$

or, in logarithms,

$$\log. f = 6 \left(\log. (t + 100) - 2.19000 \right);$$

where t is the temperature of the vapour, and f its force in inches of mercury. By this rule the force for a temperature of 497° is 3280 inches: the experiment of M. Cagniard de la Tour gives 3570 inches.

EXPERIMENTS ON THE FORCE OF THE VAPOUR OF ALCOHOL.

Temperature of vapour.	Force in inches of mercury.					
	Ure's experiments.	Watt's experiments.	Robison's experiments.	Dalton's experiments.	Bettancourt's experiments.	By Formula page 73.
32°	0·40		0·0		0·0	0·383
40	0·56	0·929	0·1			0·546
50	0·86					0·826
54·5					·48	0·986
60	1·23		0·8	1·4		1·215
64				1·51		1·41
70	1·76					1·75
77					1·62	2·228
80	2·45		1·8			2·465
90	3·40					3·41
96				4·07		4·11
99·5					3·63	4·57
100	4·50		3·9			4·64
110	6·00	5·63				6·22
120	8·10	7·12	6·9			8·22
122					7·36	8·67
130	10·60					10·73
132		10·34		11·0		11·3
140	13·90		12·2			13·85
144·5					13·7	15·48
150	18·00					17·7
160	22·60	20·71	21·3			22·4
167		24·47			25·4	26·25
170	28·30					28·1
173	30·00			29·70		30·00
180	34·73		34·			34·92
189·5					42·0	42·66
190	43·20					43·11
200	53·00		52·4			52·83
210	65·00					64·3
212					68·	66·84
220	78·50		78·5	80·20		77·81
230	94·10					93·6
234·5					105·	101·5
240	111·24		115·			112·0
250	132·30					133·2
260	155·20					157·7
264	166·10					168·6

The specific gravity of the alcohol used by Dr. Ure was ·813, and its boiling point 173°. ¹ The properties of the alcohol employed by Mr. Watt are not given; ² his experiments are very irregular. Dr. Robison's boiled at 173; ³ and above 100° agree well with later observations. Mr. Dalton's appears to have boiled at 175°; ⁴

¹ Phil. Trans. 1818.

³ Robison's Mech. Phil. vol. ii. p. 35.

² Robison's Mech. Phil. vol. ii. p. 33.

⁴ Annals of Philo. 1820. vol. xv. p. 130.

Bettancourt's boiling point is not stated, but appears to have been at 173°,¹ and his results like Dr. Robison's are too small at low temperatures.

Dr. Ure's experiments are confirmed by those of Mr. Dalton, and may be relied on as approaching very near the truth. The formula, it will be observed, represents them with considerable accuracy.

OF THE ELASTIC FORCE OF THE VAPOUR OF SULPHURIC ETHER.

106. M. Cagniard de la Tour made several experiments on ether in the same manner as those on alcohol, art. 104. The ether was converted into vapour in a space less than twice its original volume by a temperature of 392°. This experiment was thrice repeated, with the same result, and 528 parts of air were compressed to 14, giving an elastic force of 37·7 atmospheres.²

107. Other trials were made, the results of which are shown in the following table.

M. CAGNIARD DE LA TOUR'S EXPERIMENTS ON ETHER.

Temperature by Fahrenheit.	Volume in the liquid state 7 parts. Volume in the state of vapour 20 parts.		Force as expanding gas in atmospheres, by formula below.	Volume in the liquid state 3½ parts. Volume in the state of vapour 20 parts.		Force of vapour in atmospheres, by formula below.
	Force of vapour in atmospheres.	Differences.		Force of vapour in atmospheres.	Differences.	
212°	5·6					5·78
234·5	7·9	2·3				7·9
257	10·6	2·7		14·0		10·63
279·5	12·9	2·3		17·5	3·5	14·1
302	18·0	5·1		22·5	5·0	18·4
324·5	22·2	4·2		28·5	6·0	23·8
347	28·3	6·1		35·0	6·5	30·6
369·5	37·5	9·2		42·0	7·0	38·7
392	48·5	11·0		50·5	8·5	48·0
414·5	59·7	11·2		58·0	7·5	60·7
447	68·8	9·1	68·8	63·5	5·5	82·3
469·5	78·0	9·2	70·5	66·0	2·5	100·7
492	86·3	8·3	72·2	70·5	4·5	
514·5	92·3	6·0	73·9	74·0	3·5	
537	104·1	11·8	75·6	78·0	4·0	
559·5	112·7	8·6	77·4	81·0	3·0	
572	119·4	6·7	78·3	85·0	4·0	
594·5	123·7	4·3	80·0	89·0	4·0	
617	130·9	7·2	81·8	94·0	5·0	

¹ Prony's Architecture Hydraulique, vol. ii. p. 180.

² The experiments on sulphuric ether may be very nearly represented by the formula,

$$f = \left(\frac{t + 210}{178·7} \right)^6; \text{ or } \log. f = 6 \left(\log. (t + 210) - 2·25212 \right)$$

when the ether boils at 104° or 105°; but for ether boiling at 98°, the constant logarithm should be 2·23953.

In the above experiment the formula for ether boiling at 105° gives 48 atmospheres for its elastic force at 392°; but the correspondence with the tabular experiments is nearer.

On comparing the two series it will be observed, that the pressure up to the point where the liquids change wholly into vapour is greater in the tube containing the least proportion of liquid; but this I expect is entirely owing to the mode of trial not being susceptible of much accuracy. Up to the point where the change to vapour takes place, the formula derived from Dr. Ure's experiments applies with admirable precision; a new formula is necessary after the change. The formation of vapour from the mercury in the apparatus most probably affects the results in high temperatures.

108. URE'S AND DALTON'S EXPERIMENTS ON ETHER.

Temperature of vapour.	Force in inches of mercury.			Temperature of vapour.	Force in inches of mercury.		
	Ure's experiments.	Dalton's experiments.	Formula, page 75.		Ure's experiments.	Dalton's experiments.	Formula, page 75.
34°	6·20		6·48	140°	56·90		56·4
36		7·5	6·8				
44	8·10		8·25				
54	10·30		10·4	150	67·60		66·9
64	13·00	15·0	13·0	160	80·30		78·8
74	16·10		16·1				
84	20·00		19·83	170	92·80		92·5
94	24·70		24·2	173		120·0	96·9
96		30·00	25·2				
104	30·00		30·00				
	Second kind of ether.						
105	30·00		30·00				
110	32·54		33·00	180	108·30		108·1
115	35·90		36·2				
120	39·47		39·7	190	124·80		125·8
125	43·24		43·4				
130	47·14		47·4	200	142·80		146·
132		60·0	49·1				
135	51·90		51·8	210	166·00		168·5
				220		240	194·

The ether employed by Mr. Dalton boiled in a tube at 96°,¹ and will be very nearly represented by increasing the calculated quantity one fifth for the temperature. Thus, for 132°, we have

$$49.1 + \frac{49.1}{5} = 58.92,$$

and for 220°, we have

$$194 + \frac{194}{5} = 232.8,$$

Dr. Ure's ether boiled at 104° or 105°, and his experiments are very regular.²

¹ Thomson's Annals of Philosophy, vol. xv. p. 130.

² Dict. of Chemistry.

OF THE ELASTIC FORCE OF THE VAPOUR OF SULPHURET OF CARBON.

109. There is a remarkable compound of sulphur with carbon, which is usually distinguished by the name sulphuret of carbon, but is sometimes called carburet of sulphur. It is liquid, and as transparent and colourless as water. It has an acrid and pungent taste, somewhat aromatic: its smell is nauseous and peculiar: its specific gravity is 1·272, and it boils briskly and distils at from 110° to 116°, depending on its purity. When heated to about 680° or 700° in the air, it takes fire and burns with a blue flame. It is scarcely soluble in water. It appears to be a compound of

Sulphur	-	-	84·21
Carbon	-	-	15·79
			100·00

It may be prepared by mixing about 10 parts of well-calcined charcoal in powder with 50 parts of pulverized native pyrites, and distilling the mixture from a retort into a tubulated receiver surrounded by ice: somewhat more than one part of sulphuret of carbon may be obtained from the above quantities.

110. It appears to me that it might be used in a steam engine with some advantage, provided it does not act too much on the metallic parts, nor undergo a change by the continued transition from heat to cold; for it has a high elastic force at a low temperature, being equal to about 4 atmospheres at 212°, and therefore the advantage of a high pressure engine might be obtained without the inconvenience of a high temperature.

EXPERIMENTS ON THE ELASTIC FORCE OF VAPOUR FROM SULPHURET OF CARBON.

Temperature.	Force in inches of mercury.	
	Observed.	Calculated by formula, page 78.
53°·5	7·4	11·73
72·5	12·55	16·35
110	30·00	30·00

These experiments I have attempted to represent by calculation: as the rule by which the numbers were calculated was formed from the experiments in the fol-

lowing table, they serve here to indicate that the observed numbers are probably too low for the true ones.¹

111. EXPERIMENTS ON THE FORCE OF THE VAPOUR OF SULPHURET OF CARBON,
BY M. CAGNIARD DE LA TOUR.

Degrees of heat by Fahrenheit.	Volume in liquid state 8 parts. Volume in the state of vapour 20 parts.		Force of vapour by formula below.
	Force.	Difference.	
	Atmospheres.	Atmospheres.	Atmospheres.
212°	4.2		4.03
234.5	5.5	1.3	5.3
257	7.9	2.4	6.8
279.5	10.0	2.1	8.7
302	13.0	3.0	11.0
324.5	16.5	3.5	13.8
347	20.2	3.7	17.3
369.5	24.2	4.0	21.3
392	28.8	4.6	26.2
414.5	33.6	4.8	31.9
447	40.2	6.6	42.0
469.5	47.5	7.3	50.3
492	57.2	9.7	60.2
514.5	66.5	9.3	71.4
537	77.8	11.3	84.5
559.5	89.2	11.4	99.5
572	98.9	9.7	
594.5	114.3	15.4	
617	129.6	15.3	
628.25	133.5	3.9	

The irregularities in all M. Cagniard de la Tour's experiments would be in part occasioned by the expansion of the tubes under such high pressures and temperatures; hence, to attempt a minute comparison would only show a want of attention to physical effects too common in such inquiries. The usual practice of attempting to supply want of observation by minute calculations, is one of the great defects of the present mode of scientific inquiry, as applied to improve the scientific arts.

112. The forces of various other substances have been tried, but not with much attention to the selection of such as are adapted for the acting vapours in an engine; as, for that purpose, one should be chosen which affords the highest power

¹ The rule in logarithms for sulphuret of carbon, by which the calculated numbers in these tables were found, is

$$\log. f = 6 \left(\log. (t + 280) - 2.34488 \right)$$

to the point where the liquid becomes wholly vapour.

with the least range of temperature above the one convenient for condensation : to a vapour of this kind, heat may be applied without requiring so extensive a surface for the fire to act on as when water is used.

On the other part, a fluid which has a low elastic force at a high temperature may sometimes be conveniently and safely applied to afford a regular heat to the acting vapour ; hence, it becomes difficult to say to what objects it is improper to extend our inquiries.

Mr. Dalton made some experiments on the vapour of ammonia. The ammonia he used boiled at 140° ; and its specific gravity was .9474. It had a force of 4.3 inches at 60° ; but on increasing the temperature, the volatile parts separated first, and left the rest with a greater proportion of water, requiring a still higher temperature to convert them into steam : this fluid is therefore inapplicable.

113. The force of the vapours of petroleum, and of oil of turpentine, has been ascertained by Dr. Ure : the following tables contain his results :—

EXPERIMENTS ON THE FORCE OF VAPOUR OF PETROLEUM,¹ OR NAPHTHA.

Temperature.	Force in inches of mercury.		Temperature.	Force in inches of mercury.	
	Ure's experiments.	Formula.		Ure's experiments.	Formula.
316°	30.00	30.00	350°	46.86	48.1
320	31.70	31.8	355	50.20	
325	34.00	34.1	360	53.30	54.8
330	36.40	36.6	365	56.90	
335	38.90		370	60.70	62.4
340	41.60	42.	372	61.90	
345	44.10		375	64.00	66.5

EXPERIMENTS ON THE FORCE OF THE VAPOUR OF OIL OF TURPENTINE.²

Temperature.	Force in inches of mercury.		Temperature.	Force in inches of mercury.	
	Ure's experiments.	Formula.		Ure's experiments.	Formula.
304°	30.00	30.00	340°	47.30	50.10
307.6	32.60	31.6	343	49.40	52.5
310	33.50	32.7	347	51.70	
315	35.20	35.3	350	53.80	57.3
320	37.06	38.0	354	56.60	
322	37.80	39.0	357	58.70	
326	40.20	41.1	360	60.80	65.4
330	42.10	43.6	362	62.40	
336	45.00				

¹ For the steam of petroleum, the boiling point being 316°, the rule in logarithms is

$$\log. f = 6 (\log. (t + 100) - 2.37291).$$

² For the steam of oil of turpentine, which boils in a tube at 304°, the rule in logarithms is

$$\log. f = 6 (\log. t + 100) - 2.36019).$$

114. There yet remains a substance which seems to possess the properties desirable in the acting vapour of an engine. It is called oil gas vapour, and is separated from oil gas by the compression used to render that gas portable. It has been examined by Mr. Faraday,¹ who found that it is insoluble in water except in very minute quantities. It boils at about 170°, but remains liquid at common temperatures: it consists of a combination of fluids of different degrees of volatility, and by repeated distillations at different temperatures the volatile fluids may be separated; the most abundant separates between 170° and 200°.

At common temperatures the fluid which separates between 170° and 200° appears as a colourless transparent liquid, of the specific gravity 0·85 at 60°, having the general odour of oil gas. Below 42° it is a solid body, which contracts much during its congelation. At zero it appears as a white or transparent substance, brittle, pulverulent, and of the hardness nearly of loaf sugar. It evaporates entirely in the air, and when its temperature is raised to 186°, it boils, furnishing a vapour, which is 2·7 times the weight of the same bulk of common air. It appears, however, that at a higher temperature the vapour is decomposed, depositing carbon.

It is composed of six volumes of carbon, and three volumes of hydrogen, condensed into one.

115. In a paper in the 'Philosophical Transactions' on the application of liquids formed by the condensation of gases as mechanical agents, Sir H. Davy anticipates the probability of the application of the elastic force of compressed gases to the movement of machines.² He founds this anticipation upon the immense difference between the increase of elastic force in gases under high and low temperatures by similar increments of temperature. The force of carbonic acid was found to be equal to that of air compressed to $\frac{1}{30}$ at 12°, and of air compressed to $\frac{1}{35}$ at 32°, making an increase of pressure equal to the weight of 13 atmospheres.

116. I think, however, it will be found, that two other circumstances should be considered in estimating the fitness of compressed gases as mechanical agents. First, The distance through which the force will act; for if this distance of its action be less in the same proportion, as the force is increased by compression, no advantage will be gained; the power of a mechanical agent being jointly as the force, and the distance through which that force acts. Secondly, The quantity of heat required to produce the change of temperature is also to be considered. For if the mechanical power requires as great an expenditure of heat as common steam, no advantage worthy of notice would be gained. In fact the only prospect they afford of being useful, is through lessening the extent of surface to be heated.

¹ Philosophical Transactions, 1826.

² Idem, for 1823.

The idea of employing very powerful pressures, acting through a short space, seems more valuable at first sight than it proves on examination. It is considered that an engine of high power can be got into a small place, and will be of less weight. But the real inconveniences are, the large mass of fuel required to supply the engine a given time, and the immense surface that must be exposed to an intense heat to obtain a given quantity of heat in a given time. Besides, when we attempt to use high degrees of pressure, an accuracy of workmanship, and attention to the elasticity of materials, becomes necessary, which renders the work expensive and of short duration.

The success of Mr. Faraday in reducing various gases into the liquid state is not however the less important. His method consisted in generating the substances in a bent tube of glass hermetically sealed at both ends. Then, by cooling one end of the bent tube and heating the other, when heat was necessary, the gas was condensed in a liquid state at the cold end of the tube.

117. Carbonic acid required the greatest precautions to effect the condensation with safety. The liquid obtained is a limpid, colourless body, extremely fluid, and floated upon the contents of the tube without mixing. It distils readily at the difference of temperature between 32° and 0° : its refractive power is much less than that of water, and its vapour exerts a pressure of 36 atmospheres at a temperature of 32° . In endeavouring to open the tubes which contained it, at one end, Mr. Faraday states, that they uniformly burst with powerful explosions.¹

The gases reduced to a liquid state by Mr. Faraday, with their densities as far as they are known, are collected in the following table, with a column to show the mechanical power compared with steam.²

¹ The ingenious Mr. Brunel is attempting to work an engine where the acting vapour is to be from liquid carbonic acid. It is to be regretted that his great talent for mechanical combination should be employed where there is so little chance of success.

² The power is as the force and the space through which the gas passes in its reduction to the state of liquid. (See Sect. iv.) The space is found by comparing the density of the body in the liquid state with its density in the gaseous under the same pressure; and as the weight of air is to water as 1 : 828, to find the mechanical power of equal volumes of the liquid, we have simply to multiply 828 by the specific gravity of the liquid, and divide the product by the specific gravity of the body in the state of gas. The force does not enter into the calculation, because the density of the gas must obviously be greater in the same proportion. The quantity of heat is most probably in the ratio of the power: if this be the case, all substances will afford equal powers with equal quantities of heat.

Body.	Specific gravity of the gas, air being unity.	Specific gravity of liquid, water being unity.	Temperature.	Force in atmospheres.	Mechanical power of equal weights of the gases.
Carbonic acid gas	1.527		32°	36	
Sulphuric acid gas	2.777	1.42	45	2	426
Sulphuretted hydrogen gas	1.192	0.9	50	17	630
Euchlorine gas	2.365				
Nitrous oxide	1.527		45	50	
Cyanogen	1.818	0.9	45	3.6	395
Ammonia	0.5962	0.76	50	6.5	1057
Muriatic acid gas	1.285		50	40.	
Chlorine	2.496	1.33	50	4.	440
Steam of water	0.48	1.000	212	1.	1711

These are the principal researches that have been made on the force of vapours at different temperatures, when in contact with liquids; but, in order to render the subject more complete, we must consider the force when not in contact with the liquids which generate them, and also their density and volume.

OF THE ELASTIC FORCE OF VAPOUR SEPARATED FROM THE LIQUIDS FROM WHICH THEY WERE GENERATED.

118. It has been remarked, that the elastic force of steam or vapour produced by increase of temperature ceases to follow the same law where it is not in contact with the liquid from which it was formed. (Art. 87.) The density of the steam no longer increases, the force being solely that which prevents it expanding, and is measured from the quantity it would expand if unconfined. The expansion by the same increase of temperature having been found to be the same in all gases and vapours, and the density as the compressing force, as far at least as 60 atmospheres, it becomes an easy task to compute this species of force within that range of compression.

This will also be further useful in determining the volume occupied by steam of a given density and temperature as far as about 60 atmospheres: higher we need not attempt to go for useful purposes; and if we did, our rules would fail, for there is not even a probable chance of the law, of the density being as the force, extending to very high degrees of compression.

119. The quantity a gas or vapour expands under a constant pressure, is found by the following rule.

RULE. To each of the temperatures before and after expansion, add 459. Then divide the greater sum by the less, and the quotient multiplied by the volume at the lower temperature will give the volume at the higher temperature.

Or let t be the temperature with the volume v , and t' any other temperature, then

$$\left(\frac{459 + t'}{459 + t}\right) v = \text{the volume at the temperature } t'.$$

RULE. As the volume the vapour occupies is to the volume it would become by expansion, so is the elastic force at the lower temperature to that at the higher one.

$$\text{Or, } v : \left(\frac{459 + t'}{459 + t}\right) v :: f : f \left(\frac{459 + t'}{459 + t}\right).$$

Taking as an example M. Cagniard de la Tour's experiments on ether, it is stated that it was completely in a state of vapour at a lower degree; but the differences do not indicate this to have taken place till it was 447°, and its force was 68·8 atmospheres; required its force at 617°. In this case

$$\frac{459 + 617}{459 + 447} \times 68\cdot8 = 81\cdot7 \text{ atmospheres.}$$

In the experiment he states it as 94 atmospheres, and undoubtedly in consequence of the vapour of mercury forming in the apparatus, (art. 107.); and a like remark applies to all his experiments; for our rule for the expansion rather exceeds the truth than otherwise.

120. By reversing the process, we may find the volume steam will occupy under any compressive force not exceeding 60 atmospheres, when its volume is known for a given temperature and pressure. For example, at 60° its force being 30 inches of mercury, its volume is 1324 times its volume in water.¹ Now by increasing its temperature to the degree t' its volume would be,

¹ The volume of any vapour or gas at 60° and 30 in. is easily found from chemical tables containing their specific gravity, compared with air at that temperature and pressure; for air is 828 times the volume of an equal weight of water; consequently, the number 828 being multiplied by the specific gravity of the liquid, and divided by the specific gravity of the vapour in question, gives its proportion of volume to an unit of volume of the liquid.

Thus steam is of the specific gravity ·625; and

$$\frac{828}{\cdot625} = 1324.$$

The following table may be found useful in similar calculations with various liquids.

Substance.	Specific gravity in liquid state, water being unity.	Specific gravity in vapour, air being unity.	Volume of vapour for one of liquid at 60° and 30 in.	Constant number for formula.	Volume at the boiling point of the liquid.	Boiling point.
Water	1·000	0·625	1324	76·5	1711	212°
Alcohol	·825	1·6133	423	24·5	476	173
Sulphuric ether	·632	2·586	203	11·7	220	104
Sulphuret of carbon	1·272	2·6447	398	23·0	440	116
Naphtha	·758	2·833	224	13·0	280	186
Oil of turpentine	·792	5·013	130	7·5	193	314
Oil gas liquid	·85	2·7	260	15·0	337	186

From this table it appears that one volume of water produces more vapour than an equal volume of any other substance in the list.

$$1324 \times \frac{459 + t'}{459 + 60} = 2.55 (459 + t').$$

$$\text{And } f : 30 :: 2.55 (459 + t') : \frac{30 \times 2.55 (459 + t')}{f} = \frac{76.5 (459 + t')}{f} =$$

the volume at the force f and temperature t' .

121. Hence, we have this convenient rule for finding the volume or space the steam of a cubic foot of water occupies, when the steam is of any given elastic force and temperature.

RULE. To 459 add the temperature in degrees, and multiply the sum by 76.5. Divide the product so obtained by the force of the steam in inches of mercury, and the result will be the space in cubic feet the steam of a cubic foot of water will occupy.

Example. If the force of the steam be 4 atmospheres, or 120 inches of mercury, the temperature to that force being, according to Mr. Southern's experiments 295° (art. 77.); then $459 + 295 = 754$ and

$$\frac{754 \times 76.5}{120} = \frac{57681}{120} = 480.7.$$

Its volume found by experiment was 404; and considering the difficulty of ascertaining the volume, on account of the allowances to be made for escape of steam of such a high temperature, it agrees very well with the calculated result. According to Dr. Ure's experiments, the force of steam at 295° is 129 inches, which gives 446 for the number of times the volume is increased by converting into steam of that force and pressure.

OF THE MIXTURE OF AIR AND STEAM.

122. It is a well-known fact that common water contains a considerable portion of air or other uncondensable gaseous matter; and when water is converted into steam, this air mixes with it, and when the steam is condensed, remains in the gaseous state. If means were not taken to remove this gaseous matter from the condenser of an engine, it would collect so as to obstruct the motion of the piston: but even when means for removing it are employed, a certain quantity constantly remains in the condenser of an engine; and, in order to determine its state, we must consider the effects produced by mixing air with steam, or vapour, at different temperatures and pressures.

Let us suppose that we have air and vapour of the same temperature t , and elastic force p ; and that the volumes are v and v' . If they were now put one on the other in a closed vessel of the capacity $v+v'$, it is plain they could preserve an equilibrium, because the temperature is the same, and the mutual pressures are equal; but this equilibrium would not be stable.

Experience proves that these gases would gradually mix together till they became completely intermixed. It further shows that during this operation heat is neither evolved nor absorbed; so that after a certain time the mixture is perfectly homogeneous, the two gases holding the same proportion in every part, and the temperature and pressure being t and p . From these facts, established by observation, we may deduce another equally well verified by experience.

123. If two gases, or a gas and vapour, mixed together at the temperature t , fill a volume v ; and if p and f denote the pressures they would separately exert when separately occupying the same volume v , at the same temperature t , the pressure of the mixture will be $p+f$.

In effect, let us suppose that the two gases at first are distinct, and let f be greater than p ; then dilating the gas under the pressure f , until f changes to p , its volume will become

$$\frac{v f}{p}$$

provided the same temperature t has been preserved. Placing the two gases now one on the other, their united volume is

$$v + \frac{v f}{p} \text{ or } \frac{v}{p} (p+f).$$

124. These gases, according to what we have said above, will equally intermix without changing their temperature or common pressure p . Now according to the law of the volume being inversely as the pressure, which is true of mixed as well as of simple gases, if we compress the mixture without changing its temperature until its volume $\frac{v}{p} (p+f)$ becomes v , the pressure p will become $p+f$, the same as we had to prove.

Equally good would the principle hold with three or more gases, or with a mixture of gases and vapour: in all cases the united pressure will be equal to the sum of all the pressures which the gases or vapours would each exert, *when separately occupying* the same volume v at the same temperature t .

When a change of temperature takes place, either after or during the mixture, the first temperature being t ; then

$$\frac{459+t'}{459+t} \times \frac{v (p+f)}{p} = \text{the volume at the new temperature } t', \text{ and pressure } p.$$

125. This is compared with General Roy's experiments in the following table, formed from the mean results which he obtained.¹ Commencing at zero, 1000 parts of air, in contact with water, and under a pressure of 32.18 inches, is

¹ Philosophical Transactions, vol. lxvii. p. 653.

increased in volume by the formation of vapour, and increase of temperature, as shown in the second column of the table ; while the third is the force of vapour at these temperatures by our rule, page 59 : the fourth is computed by the rule in the preceding article.¹

Temperature.	Volume of air and vapour by experiment.	Force of vapour, by Rule page 59.	Volume of air and vapour by formula, art. 124.
0°	1000·00	0·032	1000
32	1071·29	0·172	1076
52	1123·05	0·401	1132
72	1182·50	0·842	1190
92	1255·14	1·629	1260
112	1353·75	2·95	1360
132	1491·06	5·07	1500
152	1688·96	8·33	1680
172	1929·78	13·17	1930
192	2287·44	20·16	2300
212	2671·94	30·00	2850

The agreement with experiment is in this case very near, and it affords a further confirmation of the accuracy of our rule for the force of steam, below the boiling point.

126. In the condenser of a steam engine the vapour will be of the elastic force corresponding to its temperature, and that temperature is determined by that of the fluids which condense it.

It will also always become, after a few strokes of the engine, mixed with as much air as it will saturate at the given temperature and pressure ; and by the preceding inquiry it appears, that this saturation will take place when there is an equal mixture of air and vapour in the condenser ; consequently, only half the quantity drawn out by the air pump at one stroke will be air, the rest will be uncondensed vapour ; and the quantity of air drawn out at each stroke must be at least equal to all the air which enters both from the boiler, from the injection water, and from leakage at the joints in the time between stroke and stroke : a slight variation on either side, however, will not, it may easily be proved, have much effect in retarding the engine.

As the volume the air and vapour occupy determines the air pump to be of a large size, and consequently expensive both in construction and power, in order to

¹ An erroneous formula for this purpose has been copied into several works : it is $\frac{vP}{p-f}$ = the volume ; and does not at all agree with the experiments.

I gave an analysis of the correct rule in my work on Warming and Ventilating, p. 291. It has also been investigated by M. Poisson, whose mode of illustration is followed in the above.

lessen its bulk, a second injection might be made within the air pump; but the utmost that could be gained by this method would be very little more than the difference of volume due to temperature, not perhaps one-tenth of the volume of the pump in any case.

It is important to remark, that in steam from salt water, the same quantity of air will occupy more space, on account of the steam being of less elastic force at the same temperature; but perhaps this is more than compensated for, by salt water containing less air.

OF THE MOTION OF ELASTIC FLUIDS AND VAPOURS.

127. A knowledge of the principles and circumstances which affect the motion of elastic fluids, is of considerable importance, in assigning the relative proportion of the parts of a steam engine. It is a subject that has been very little studied in discussing the theory of this invaluable machine, and therefore it is one which will engage a considerable share of our attention in this work. Steam is in motion during its action; it must move through passages to perform its office, and be forced through others as it retires; and the effect of disproportion it is difficult to determine from practice alone, because the result depends on so many contingent circumstances.

The best method, therefore, must be to separate the effects, and study each independently: there is then reason to hope that they may be united into a perfect system; and at least it shall be our endeavour to forward this desirable end to the extent of our power.

128. The condition of free elastic fluids has been shown to be regulated by the pressure and temperature of the atmosphere; and, when an elastic fluid is confined in a close vessel, its condition as to temperature and pressure must be similar to that it would be in, if in an atmosphere of the same fluid capable of producing the same pressure upon it.

129. The most convenient method of investigating the motion of an elastic fluid, is, to find the height of a homogeneous column of the same fluid, capable of producing the same pressure as that to which the fluid is subjected; for then the fluid would rush into a perfect vacuum with the velocity a heavy body would acquire by falling through the height of the homogeneous column, when a proper reduction is made for the contraction of the aperture.

130. If a pipe of communication be opened between two vessels containing elastic fluids of different elastic forces, the velocity of the efflux through the pipe at the first instant will be that which a heavy body would acquire by falling through the difference between the heights of homogeneous columns, of the fluid of greatest

elastic force, equivalent to the pressures : and it would be as the velocity acquired by falling through the difference between the heights of the columns equivalent to the pressure at any other instant ; the height to be ascertained for the instant at which the velocity is required. After a certain time, the pressures or elastic forces would become equal, and the velocity of course would be nothing.

131. The consideration of chimneys is another case of the motion of elastic fluids, where, by increase of temperature, a part of an atmospheric column is rendered of a different density. Some mistakes have been committed in treating this case ; but we must proceed to treat of the motions which take place in engines, and first of the allowances to be made for contractions.

132. In the motion of elastic fluids, it appears from experiments, that oblique action produces nearly the same effect as in the motion of water, in the passage of apertures ; and that eddies take place under the same circumstances, tending to retard the motions in a considerable degree.

133. The velocity of motion that would result from the direct unretarded action of the column of the fluid which produces it being unity - - - 1·000 or 8
 The velocity through an aperture in a thin plate by the same pressure is - ·625¹ or 5
 Through a tube from two to three diameters in length projecting outward - ·813 or 6·5
 Through a tube of the same length projecting inwards - - - ·681 or 5·45
 Through a conical tube, or mouth piece, of the form of the contracted vein - ·983 or 7·9.

134. Every enlargement of a pipe which is succeeded by a contraction reduces the velocity of the motion, and in proportion to the nature of the contraction, and every bend and angle in a pipe, is attended with a diminution of velocity. Hence, as far as convenience will admit, these causes of loss should be avoided ; and where they must be introduced, such forms should be given as will lessen the defect as much as possible.

OF THE MOTION OF STEAM IN AN ENGINE.

135. We have stated (art. 129.) that the most convenient mode of determining the motion of steam, is, by finding the height of a column of the same fluid which would produce an equal pressure upon a base of equal area : the manner of determining this column is therefore the first point to be considered. The force of steam is sometimes expressed by the pounds on a square inch ; sometimes by the inches in height of a column of mercury, and not unfrequently by the number of atmospheres : it will therefore be an advantage to find the height of a column of water equivalent to each of these measures ; and then, that being multiplied by the

¹ According to experiments on air made by Mr. Banks, 0·634. See *Power of Machines*, p. 13.

relative bulk and pressure of the steam, the height of the column of steam will be found.

The height of a column of water at 60° equivalent to the pressure of	to	}	1 lb. per square inch is 2·31 feet. 1 lb. per circular inch is 2·94 feet. 1 inch of mercury is 1·133 feet. the atmosphere is 34·0 feet.
--	----	---	--

The water is supposed to be of the temperature 60°, and the atmosphere equal to a pressure of 30 inches of mercury: the bulk of the steam will depend on the pressure and temperature, and will be given for the range of practice in a table at the end of the volume, or may be found by art. 121. For example, the volume of steam at 212° being 1711 times the bulk of the equivalent quantity of water at 60°, and the pressure being 30 inches of mercury, or 34 inches of water, we have $1711 \times 34 = 58174$ feet, the height of an atmosphere of steam at 212°.

136. If an aperture were formed so that there would be no oblique action in passing it, a gaseous fluid or vapour would rush through it into a perfect vacuum, with the velocity a heavy body would acquire in falling through the height of the column of the same fluid equivalent to the pressure.

And this velocity in feet per second is equal to eight times the square root of the height of the column; ¹ but through pipes and other apertures the velocity will be only 5, or $6\frac{1}{2}$, or other number of times the square root of the height of the column, as shown in the table, art. 133. for each kind of aperture.

137. RULE. If the height of a column of steam equivalent to the pressure of steam in a boiler be determined, and also the height of a column of the same steam equivalent to the pressure on the piston of a steam cylinder, then the velocity will be equal to 6·5 times the square root of the difference between the heights of the two columns. This result is the velocity in feet per second through a straight pipe.

¹ In algebraic notation; let f be the inches of mercury equal to the force of the steam or the pressure on the fluid, b the bulk of the fluid when the same weight of water is 1, and h = the height of an atmosphere of the fluid of uniform density. Then, $1\cdot13 f b = h$; and

$$8 \sqrt{h} = v = 8 \sqrt{1\cdot13 f b},$$

when the fluid flows into a perfect vacuum without contraction at the aperture. In the best formed pipes it is

$$7\cdot9 \sqrt{h} = v;$$

in common formed ones

$$6\cdot5 \sqrt{h} = v. \text{ But } b = \frac{76\cdot5 (459 + t)}{f} \text{ (art. 121);}$$

hence

$$v = 6\cdot5 \sqrt{86\cdot5 (459 + t')}, \text{ the velocity into a vacuum,}$$

when t' is the temperature of the steam.

138. The quantity of steam generated may be considered to be equal to the quantity consumed in the same time, or that the boiler is of sufficient capacity to admit of its being taken at intervals without a sensible loss of elastic force; and as these conditions are essential to a good engine, we shall consider them to be fulfilled. (See sect. III. art. 210. for the proportion of space in boilers.)

139. The volume of steam required in a second is equal to the area of the piston multiplied by its velocity in feet per second: and its density or elastic force must be as much less than that of the steam in the boiler, as to allow the same weight of steam to pass in a second through the steam passages; for if it passed through the steam passages with no greater velocity than that of the piston, those passages must be of the same area as the cylinder; but as they are less than the cylinder, the excess of velocity must be produced by a corresponding excess of force in the boiler.

140. The steam, till it has passed the narrowest part of the passages, will have the same density as in the boiler, but in the cylinder it must expand till its density be so reduced as to cause the difference of pressure producing the velocity through the contracted passages; and as the density is as the elastic force, the force of the steam in the boiler multiplied by the velocity, and the area of the passage, must be equal to the elastic force on the piston multiplied by its area and velocity.

That is, $f a v = p A V$, when f is the force of the steam in the boiler in inches of mercury; a the area of the steam passages; v the velocity; p the force on the piston in inches, A its area, and V its velocity.

From this we have

$$v = \frac{p A V}{f a}.$$

But by the rule (art. 137.)

$$v = 6.5 \sqrt{1.13 b (f-p)};$$

$$\text{therefore } \frac{p A V}{f a} = 6.5 \sqrt{1.13 b (f-p)}.$$

If the area of the steam passage be required, we have

$$a = \frac{p A V}{6.5 f \sqrt{1.13 b (f-p)}}. \text{ Or } a = \frac{p A V}{6.5 f \sqrt{86.5 n (459 + t')}};$$

when $n f = f - p =$ the loss of force, which should not be exceeded.

141. In practice for low pressure engines it is usual to make the diameter of the passage about one-fifth of the diameter of the cylinder, and then its area is $\frac{1}{25}$ of the area of the cylinder: and as this proportion is grounded upon the experience of the difficulties involved by making the passages larger, it ought not to be departed from without a sufficiently obvious advantage.

142. This formula applies only to the case of a pipe without obstructions, and

we have no experiments by which the effect of these causes of diminution can be estimated with accuracy, but we may endeavour to allow for them on the principles which operate in similar circumstances. For this purpose let the part of the pipe from whence the change of figure takes place, be considered a vessel with an aperture of the kind nearest resembling the figure of the branching pipe, and the loss of motion at the place equal to that which such an aperture would cause.

Thus when the angle is a right angle, the loss of velocity may be considered half that which takes place when a pipe is inserted in the side of a vessel, as the diminutions in the exterior half of the aperture will not be so great in this case; therefore the loss will be

$$\frac{1.000 - .813}{2} = .094 \text{ nearly ;}$$

and may be allowed for by diminishing the velocity *one-tenth*, for each *right-angled bend*,

The same allowance for loss should be made when one pipe branches at right angles from another.

143. In a pipe formed to a regular curve, or bent only to an obtuse angle, the reduction will not exceed that which happens with a conical mouth-piece, which is about $\frac{1}{50}$ of the velocity.

If a pipe be terminated in a valve box, the allowance of *two-tenths* should be made for the loss of velocity in passing the valve.¹

144. Few engines have less than three obstructions equivalent to passing so many different apertures, which together may be expected to reduce the velocity so as to require the number 6.5 to be reduced to 4.5; consequently, the formula may be stated

$$a = \frac{p A V}{4.5 f \sqrt{86.5 n (459 + t)}} = \frac{A V (1 - n)}{42 \sqrt{n (459 + t)}};$$

¹ When a series of obstructions of the same kind occur in a pipe, the reduction for the first being $\frac{1}{a}$, the velocity will be reduced from V to

$$V \left(1 - \frac{1}{a}\right)^n$$

in passing n obstructions. For the loss of velocity at the first obstruction must be $\frac{V}{a}$; hence it will be reduced to

$$V - \frac{V}{a} = V \left(1 - \frac{1}{a}\right);$$

and this quantity will be similarly reduced in the same proportion at each contraction.

To calculate the amount of such a succession of diminutions, we have

$$\log. V + n \log. \left(1 - \frac{1}{a}\right) = \text{the logarithm of the reduced velocity.}$$

which will enable us to compare with practice after considering the other causes of loss.

145. *Loss of force by cooling.* But much of the force of the steam will also be lost in the passage through the steam pipe by cooling. The quantity of steam exposed during a second is as the area and velocity of the steam ; or

$$= \frac{a v}{144} \text{ cubic feet ;}$$

a being in inches, the rest in feet.

The surface is as the length and circumference, or

$$= l \times \frac{\pi d}{12} = \frac{4 l a}{12 d} \text{ square feet.}$$

Hence the loss of heat being directly as the surface, and inversely as the quantity exposed, we have for cooling in metals

$$\frac{2 \cdot 1 (T - t'')}{60} \times \frac{4 l a}{12 d} \times \frac{144}{a v} =$$

the loss of heat in a second ; or rather the loss of heat which the quantity passing in one second experiences.¹ By reducing the expression to its lowest fraction it becomes

$$t''' = \frac{1 \cdot 7 l (T - t'')}{d v}$$

In this equation

T is the temperature of the surface of the steam pipe, which will be about one-twentieth less than that of the steam ;

t'' is the temperature of the air,

l the length of the pipe in feet,

d its diameter in inches,

and v the velocity in feet per second.

146. In applying this formula to find the loss of heat, there are no other circumstances to be considered ; but in its application to determine the loss of elastic force, there is a most important point, to which I would particularly direct the attention of manufacturers of engines. It is the degree to which the temperature of the steam is reduced by passing through the pipe. It is said to be frequently as much as would reduce its temperature below 212° ; when this is the case, we know that part of the steam must become water, and the rest of it become of the force equivalent to a temperature of 212° , and therefore all the excess of force which was generated in the boiler, would be destroyed by the cooling in the passage to the engine.

¹ Tredgold on Warming and Ventilating, art. 44.

147. A knowledge of this cause of the reduction of the force of steam to atmospheric elastic force, and of the importance of not losing force where either economy of heat or of space is desirable, creates a strong desire to know its amount, knowing that the most esteemed manufacturers of steam-boat engines cause the steam to pass round between the jacket and the cylinder; as if to expose it as much as possible to the cooling effect of the atmosphere, to reduce its elastic force before it enters the cylinder to exert its power.

148. The reduction of the temperature of steam reduces its elastic force to that of a lower temperature, and during this reduction a portion of the steam becomes water. If f denote the elastic force in the boiler, and f' that after the heat has been lost,

$$\frac{f - f'}{f}$$

will be the quantity reduced to water, and this multiplied by its heat of conversion into steam must be equal to the heat the whole has lost by cooling; therefore

$$\frac{967 (f - f')}{f} = t'''; \text{ or } f \left(1 - \frac{t'''}{967}\right) = f'.^1$$

And here it will be remarked, that when t''' is equal to the whole heat of conversion, f' will be nothing; or the whole will be cooled into water as it is in an apparatus for warming buildings. We are now in a condition to give an answer to the question of what is the loss of force in any particular case. Let the temperature of the steam be 220° , and its force 35 inches of mercury, the length of the steam pipe 12 feet, its diameter 6 inches, the velocity of the steam in the pipe 80 feet per second, and the temperature of the air 60° . Then by art. 145. we have

$$T = 220 - \frac{220}{20} = 209^\circ$$

$$\frac{1.7l(T - t'')}{dv} = \frac{1.7 \times 12 \times (209 - 60)}{6 \times 80} = 6.3 \text{ degrees;}$$

and therefore by the equation above we have

$$f \left(1 - \frac{t'''}{967}\right) = 35 \left(1 - \frac{6.3}{967}\right) = 34.77;$$

consequently there is in this case a loss of force equivalent to 0.23 inches of mercury, or $\frac{1}{13}$ of the force; but this is one of the most favourable of the cases that usually occur in practice. In steam-boat engines where the steam has to pass round the cylinder, the force in the cylinder is stated, from observation,

¹ The number 967° is here taken as the heat of conversion into steam, but in general I use 1000° as more accurate. (See art. 82.)

not to exceed about twenty-eight inches, when the force in the boiler is about thirty-six inches.

149. It is obvious that the higher the force and temperature, the greater will be the reduction by cooling, and therefore the loss in engines of Woolf's method of construction, where the steam has to make its way round the cylinders, must be greater, and take away much from that increase of effect arising from the use of high pressure steam, to gain which so much risk at the boiler is encountered.

OF THE AREA OF THE STEAM PASSAGES.

150. The formula for calculating the motion of steam in an engine has no maximum value to assist us in the choice of a proportion for applying it in practice; but it shows that the larger we make the aperture, the less we shall lose of the elastic force of the steam. On the other hand, we have shown that the loss of force by loss of heat is greater, the less the velocity and diameter of the pipe. The proportions, however, which about render the loss by the two causes equal have been found most convenient in practice, and therefore claim the preference. There are two rules in use, and neither of these is exactly the same as the theoretical one.

151. The one is to make the diameter of the steam ways one-fifth of the diameter of the cylinder. This appears to be Boulton and Watt's proportion.

152. The other is to make the area of the passage one superficial inch for each horse power.

153. The obvious intention of these rules is, that the steam should move with the same velocity, or require the same impelling force, in any sized engine. Either of them gives nearly the result, but neither of them gives it exactly. For the horse power in a small engine requires more steam than in a large one, and therefore the aperture should be greater in small engines, or less in large ones, than one inch area for each horse power.

Again, engines having a short stroke move slower than those with a long one, and therefore should have the steam passage of a different proportion of the diameter according to the velocity.

154. To render the velocity very nearly the same in all cases, we have this rule.¹

¹ From the equation (art. 144.) we have, when $n = .00694$, supposing $\frac{1}{144}$ part of the force to be lost in producing the velocity,

$$a = \frac{A V}{3.357 \sqrt{459 + t}}$$

Multiply the length of the stroke by the number of strokes per minute, and divide the product by 2400; the square root of the quotient multiplied by the diameter of the cylinder is the diameter of the pipe.

Example. To find the diameter for the steam pipe of an engine of which the diameter of the cylinder is 2 feet, the length of the stroke 2.5 feet, and the number of strokes per minute 38;

$$\frac{38 \times 2.5}{2400} = \frac{95}{2400} = \frac{1}{25},$$

and the square root of $\frac{1}{25}$ is one-fifth; hence the diameter of the steam pipe in this case is one-fifth of that of the cylinder.

The same rule applies to both high pressure and low pressure steam engines, and both to the steam passages and the passages to the condenser; and the excess of force necessary to produce the velocity is very nearly one-144th part of the force of the steam.

OF THE LOSS OF FORCE BY THE COOLING OF THE CYLINDER.

155. The steam after it gets within the cylinder is liable to a loss of force by cooling. It is, in large engines, usually inclosed by a case called a jacket, and steam is introduced between this case and the cylinder to keep the latter hot; but the loss in fuel by this mode is the same as with a naked cylinder, and there is clearly no advantage in preserving the force of the steam by adding this case, unless it be supplied with steam by a separate pipe. (See art. 147.)

156. The investigation for the loss of force in the steam pipe applies in the case of a naked cylinder with a very slight alteration. The steam in this case is progressively exposed to the sides of the cylinder; hence the loss will be some

and when we use the length of the stroke l , and the number per minute m ; $2lm = 60V$, and we may take

$$a = \frac{A l m}{90 \sqrt{459 + t}}$$

When $t' = 220^\circ$, it becomes

$$a = \frac{A l m}{2400}$$

which is the same as the rule. If $t' = 320^\circ$, then

$$a = \frac{A l m}{2520}$$

showing that a rather smaller aperture will do for high pressure steam. A is the area of the cylinder, and a the area of the pipe, in superficial inches.

little, but not materially less, than that which would take place were it kept constantly exposed to the sides. But to the convex surface the ends of the cylinder have to be added.

With the addition of the ends to the surface, the quantity of cooling in degrees per second, (from art. 145.) becomes

$$t''' = \frac{.07 (24 l + d) (T - t'')}{d v}$$

where l is the length of the cylinder in feet, d its diameter in inches, v the velocity of the piston in feet per second, T the temperature of the steam less $\frac{1}{10}$ part, and t'' the temperature of the air. The force is reduced to

$$f' = f \left(1 - \frac{t'''}{967} \right), \text{ the force on the piston, as in art. 148.}$$

157. When low pressure steam is employed, the temperature T will be 212° , and putting $t'' = 60^\circ$, and supposing

$$l = \frac{2d}{12}, \text{ and } v = 3.5,$$

we shall have

$$\frac{.07 (24 l + d) (T - t'')}{d v} = 15.2 \text{ degrees;}$$

$$\text{and } \frac{9.1}{967} = \frac{1}{106}.$$

Therefore in low pressure engines there is a constant loss for all sized engines of about $\frac{1}{106}$ of the power. When a casing is used and kept constantly filled with steam, the loss of heat and constantly of power from the same fuel will be greater; because the surface will be constantly kept at the temperature of the steam. I hope this will be sufficient to establish the truth, that the steam case is a useless addition to the expense of an engine.

158. In a high pressure engine working at 300° , the loss by a naked cylinder is only about $\frac{1}{15}$ part of the force.

159. The best mode of preventing loss is to put a case with an air-tight cavity between it and the cylinder, instead of filling this case with steam; and besides the advantage of saving fuel the engine-rooms will not be heated so much.

160. The single engine will lose more heat but not quite double the quantity of the double engine; hence we shall be about its amount in stating the cylinder at losing $\frac{1}{3}$ of the power. It will also lose double the quantity by the passage of the steam from the boiler to the cylinder.

161. In atmospheric engines the loss of force by cooling in the cylinder, when a separate vessel is used for a condenser, is an interesting inquiry. Assuming that the piston is kept steam-tight without the use of water, the loss must be greater

than in the single steam engines by the amount lost in cooling the inside of the cylinder half the time; hence the value of l the length of the cylinder must be increased one-half, besides doubling the area exposed in a given time. This will render the equation for the loss of temperature, (art. 156.)

$$t''' = \frac{.14 (36 l + d) (\Gamma - t'')}{d v}.$$

With the proportions and temperatures of the example, (art. 157.) the loss by cooling is about $\frac{1}{3}$ of the power; therefore it is not this species of loss which should prevent this simple kind of engine being employed for mines.

If water be applied to keep the cylinder tight, the additional loss from converting this water into vapour will be considerable. If the mean temperature of this water be 180° , the effect of each foot of area will be to abstract, or to destroy a cubic foot of steam per minute, this being the quantity of evaporation from a foot of surface of water sustained at that temperature. Therefore in an engine working at the rate of 170 feet per minute, that is, expending 85 cubic feet of steam of atmospheric density per minute, for each foot in area of the cylinder the loss will be $\frac{2}{3} = \frac{1}{3}$ of its power; hence, adding this to the cooling effect, we have $\frac{1}{3} + \frac{1}{3} =$ about $\frac{2}{3}$ of the power.

162. In the common atmospheric engine where the injection is made within the cylinder, the only person who had attempted to calculate the loss of force was Smeaton; of which some account has been given by Mr. Farey, in Rees's 'Cyclopædia.' The mode of calculation is not very clearly given, and it was formed at a time when the properties of heat were less known.

163. Cylinders are usually made of the same thickness, or so nearly so as to render the variation not worthy of notice; hence we will assume them to be of the same thickness. The quantity of matter in them is cooled by the injection from 212° to about 150° , rarely lower, and in good engines not lower than 170° or 180° ; the mean 160° may be taken for the effect. The specific heat of iron is about 200 times that of steam, and calculating the mass of iron which must have its temperature raised from 160° to between 160° and 212° by each cylinder full of steam, we have the quantity which that of the steam must be lowered.

The surface of a cylinder is equal to its length, increased by half its diameter, multiplied by its circumference $= (l + \frac{1}{2} d) d \pi$; and the thickness, with an allowance equivalent to the escape of heat from the external surface, is one inch and a half $=$ one-eighth of a foot; and the mass of metal equivalent to the absorption of heat is

$$\frac{(l + \frac{1}{2} d) d \pi}{8};$$

its specific heat, allowing for the exposed side of the cylinder decreasing, is equal to that of

$$\frac{200 (l + d) d \pi}{16}$$

cubic feet of steam heated one degree; but the temperature will rise to the mean between the condensing and boiling points, or to

$$\frac{160 + 212}{2} = 186^\circ,$$

or the addition of heat will be 26 degrees. The whole quantity of heat consumed will therefore be

$$\frac{200 \times 26 (l + d) d \pi}{16}$$

This divided by the capacity of the cylinder, or $\frac{l d^2 \pi}{4}$, gives

$$\frac{50 \times 26 (l + d)}{l d},$$

the loss it would sustain in temperature, or

$$t''' = \frac{1300 (l + d)}{l d}, \text{ } l \text{ and } d \text{ being here both expressed in feet.}$$

When the length of the cylinder is twice its diameter, or $2 d = l$, the loss becomes

$$t''' = \frac{1950}{d}.$$

Now one-fifth of the whole power is lost by imperfect condensation, more than in engines with a separate condenser; which is equal to

$$\frac{1127}{5} = 225 \text{ degrees of heat;}$$

and by the condensation and cooling in the cylinder, we have found

$$\frac{1950}{d}$$

Hence the total heat, over and above what is required in other engines, is equivalent to converting into steam

$$\frac{225 + \frac{1950}{d}}{1500}$$

times the water necessary for the steam engine, with a condenser and steam pressure.

With a cylinder 1.5 feet diameter, double the fuel is required, but for a 6-foot cylinder only one-third more than in the single engine of Watt's construction.

164. This enables us to illustrate the fact observed by Mr. Watt, when he

repaired a working model of a steam engine for the university of Glasgow, in 1763. The cylinder of the model was 0·5 feet stroke, and 2 inches, or one-sixth of a foot diameter. He “was surprised to find that its boiler would not supply it with steam, though apparently quite large enough.” By blowing the fire it was made to make a few strokes, but required an enormous quantity of injection water, though it was very lightly loaded by the column of water in the pump. It soon occurred, that this was caused by the little cylinder exposing a greater surface to condense the steam, than the cylinders of larger engines did in proportion to their respective contents.¹

There is no doubt this difficulty was the cause of Mr. Watt turning his thoughts to improve the steam engine. Our rule being applied to this case, $l = \frac{1}{2}$, $d = \frac{1}{6}$, and,

$\frac{1300(l+d)}{ld} = \frac{1300(\frac{1}{2} + \frac{1}{6})}{\frac{1}{2} \times \frac{1}{6}} = 10400$; and $\frac{10400 + 967}{967}$ or 12 times the volume of steam which would fill the cylinder would be consumed to condense at 160°. By lessening the load lifted, and consequently not condensing the steam to so low a temperature, Mr. Watt made the engine work.

165. Now in our formula it will be observed, that 26° is half the degrees the temperature of the steam falls by condensation, and that if we lessen this, the quantity of heat lost will lessen in the same proportion, but the loss by uncondensed steam will be greater. The effect of the engine will be greatest when the sum of these losses is a minimum, and its load should be arranged accordingly.

The loss by cooling the cylinder is

$$\frac{25(212-t)(l+d)}{ld};$$

when t is the temperature of condensation.

The loss by imperfect condensation is

$$\frac{1127 f'}{30},$$

but by our formula (art. 86.)

$$f' = \left(\frac{t+100}{177}\right)^6.$$

Hence, with respect to t ,

$$\frac{1127(t+100)^6}{30 \times 177^6} + \frac{25(212-t)(l+d)}{ld} = \text{a minimum.}$$

¹ Robison's Mechan. Phil. vol. ii. p. 114. Note by Mr. Watt.

Its differential must therefore be = 0, or

$$\frac{1127 \times 6 (t + 100)^5 dt}{30 \times 177^6} - \frac{25 (l + d) dt}{l d} = 0;$$

whence

$$t = \left(\frac{30 \times 177^6 \times 25 (l + d)}{1127 \times 6 l d} \right)^{\frac{1}{5}} - 100.$$

Which reduces to

$$t = 321 \left(\frac{l + d}{l d} \right)^{\frac{1}{5}} - 100.$$

166. When $l = 2d$, or the length of stroke is double the diameter,

$$t = \frac{348.2}{d^{\frac{1}{5}}} - 100;$$

or in logarithms, $\log. (t + 100) = 2.54180 - \frac{1}{5} (\log. d \text{ in feet}).$

167. Hence it appears, that when the length of the cylinder is double its diameter, the temperature of condensation, which gives the minimum loss of heat, varies inversely as the fifth root of the diameter of the cylinder. When the diameter $d = 6$ feet, the temperature of condensation $t = 143.3$; when $d = 3$ feet, the temperature of condensation should be 179.5 ; and by using a table of logarithms, the best temperature for condensation for any other diameter may be easily found by the rule.¹

OF THE ASCENT OF SMOKE IN CHIMNEYS.

168. If a bent tube, of uniform diameter, A C B, were continued to the surface of the atmosphere, the lowest point of the curve being at C, the centre of the aperture of a chimney, and the tube of the same size as a chimney, then the temperatures being equal at the same height in the two branches, the whole would be in equilibrio; but if a part, C D, be of a more elevated temperature than the corresponding part of the other branch of the tube, that air being of less density than cold air, the balance will be destroyed, and motion will take place, the moving force being the difference between the weights of the columns of air. Now a chimney may be considered part of such a tube; for though, in a chimney, the column of air is confined only as far as the short canal or tube of the chimney extends, the actual pressures which occur in the atmosphere are equivalent to the pressures in the bent tube, and must be measured in the same manner.

¹ The Rule suggested by the formula is as follows:—Take out from a table of logarithms the logarithm of the diameter, expressed in feet, and divide it by 5: subtract the quotient from 2.54180, and the remainder will be the logarithm of a number, which diminished by 100, the result will express the required temperature of condensation, in degrees.

169. When CA is the height of a uniform atmosphere, CD the height of the chimney, and DE the quantity the air expands by the heat it receives in passing through the fire, the height ED , or FG its equal, represents the height of the column of air which produces the motion, and the velocity will be that a heavy body would acquire by falling through the height FG . If the whole of CA were empty, then BH , the height of the atmosphere, would be the height through which the body must fall to acquire the velocity with which the air would move into the tube, provided it suffered no contraction at the entrance; but such a contraction is well known to take place in air as well as in water.

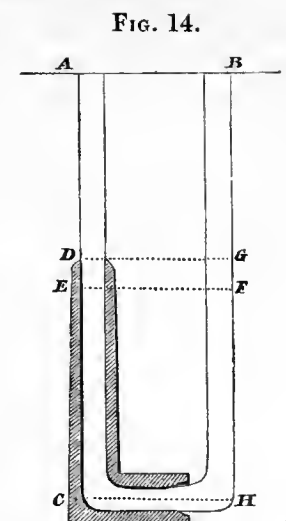

170. When this is applied to a chimney, the smoke being sometimes of a density different from common air at the same pressure and temperature, the same excess of temperature will produce a greater or less effect in proportion as it is of less or greater density than common air. This will be found by subtracting from the expansion the specific gravity of the smoke or vapour, that of air of the same temperature and pressure being unity. Or it may be done by an allowance of a portion of the temperature for the difference of density: either method gives the same result when properly calculated. In this case I intend to adopt the former method. The latter is followed in my book 'On Warming and Ventilating Buildings.'¹

171. Let h be the height in feet from the place where the flue enters to the top of the chimney; e = the bulk to which one foot of air increases by the change

¹ The principles of calculation followed, both in this and in the work referred to, are perfectly identical with those employed by Mr. Gilbert, in an excellent paper on the subject in the 'Quarterly Journal of Science,' vol. xiii. p. 113: but the notation and methods of managing the processes are different; and Mr. Gilbert's mode of calculating the expansion does not afford quite satisfactory results: besides, he makes no allowances for the contractions and loss of force in curvilinear motion. I mention the circumstance, because some people compare and criticise, and imagine those things to be different which are in reality identical, as may easily be shown by putting both in the same notation, and reducing by the rules of algebra. The great object of a practical analyst is to render the final equation as easy of application as possible. As to those who question principles, it is rather unfortunate for them to question those established principles of pneumatics which are confirmed by experiment. It is only when theory and experiment do not agree, that the principles can be called in question.

of temperature; v the velocity; s the specific gravity of the smoke, air being 1; and a = the area of the chimney in inches.

Then $h = CD$, and the expansion being as the height in feet, $h(e-1) = DE = FG$. But the velocity is that which a heavy body would acquire by falling through the height FG ; hence, $v = 8 \sqrt{FG} = 8 \sqrt{h(e-s)}$.¹ When FG is equal to BH , the line AB representing the upper line of a uniform atmosphere, it becomes $v = 8 \sqrt{BH}$; and in all other cases it is as the difference, $DC - CE = ED$, when EC is reduced to the same density as GH .

If B be the volume of air before it be heated, then in its heated state it is Be ; therefore,

$$\frac{va}{144} = \frac{8a}{144} \sqrt{h(e-s)} = Be; \text{ or } \frac{8a}{144e} \sqrt{h(e-s)} = B;$$

also,

$$\frac{a}{144} = \frac{Be}{8} \sqrt{\frac{1}{h(e-s)}}.$$

The expansion e may be found from the table, 'Treatise on Warming,' &c. (art. 220.)

But the bulk of a gaseous body at the temperature t' is

$$e = \frac{459 + t'}{459 + t},$$

when the bulk at the temperature t is *unity*; hence,

$$e - s = \frac{459 + t'}{459 + t} - s.$$

Substituting these expressions in the preceding equation, we have

$$\frac{a}{144} = \frac{Be}{8 \sqrt{h(e-s)}} = \frac{B(459 + t')}{8(459 + t)} \sqrt{\frac{(459 + t)}{h(t' - ts - 459(s-1))}}.$$

172. The divisor, 8, should be changed according to the species of aperture, (see art. 133.) but that which generally applies is 5; and t will be the mean temperature of 52°; in this case B being the quantity per hour,

$$a = \frac{B(459 + t')}{5 \times 22.6 \times 25} \times \sqrt{\frac{1}{h(t' - 52s - 459(s-1))}}.$$

¹ [This, in strictness, should be $8 \sqrt{h \frac{e-s}{s}}$; since $h \frac{e}{s}$ = the column of vapour equivalent to the column h of atmosphere, and $h \frac{e}{s} - h = h \frac{e-s}{s}$ is the excess through which a heavy body must fall to acquire the requisite velocity: but the omission in the text cannot affect the final results, as s is so nearly equal to unity, and the coefficient 8 of the expression itself offers only a rude approximation, though sufficient for common practical purposes. See art. 172.—ED.]

For coal smoke $s = 1.05$, and the formula

$$a = \frac{B (459 + t')}{2825 \sqrt{h} (t' - 78)}.$$

For low pressure steam

$$\frac{B}{56 \sqrt{h}} = a, \text{ the area in square inches.}$$

The application of the formula, with some simple rules suggested by it for engines of different powers, will be given with the proportions of fire-places: the investigation is given here to separate in some measure scientific inquiry from practical details.

OF THE ESCAPE OF STEAM AT SAFETY VALVES.

173. This is a subject which has been little studied. If we suppose the steam to be of the same density as atmospheric air, its elastic force is nearly twice as great, and it would rush into the atmosphere with the same velocity that atmospheric air rushes into a vacuum. Also, in any case, whether the elastic force of the steam be greater or less than this, if n be the number of times its specific gravity exceeds that of atmospheric steam, when that of air at the same pressure is 1, we shall have $v = 8 \sqrt{(n-1)h}$, h being the height of a uniform atmosphere of air. A uniform atmosphere equivalent to thirty inches of mercury is 28,000 feet; hence, $1340 \sqrt{n-1} = v$ in feet per second.

174. In certain cases this will be aided by the buoyancy of the escaping steam, and in very dense steam it may be slightly retarded by the same cause; but these effects are not so great as to need to be introduced in the calculation. They may, however, be sensibly observed by turning the aperture up or down; a light fluid escaping with the greatest velocity when the aperture is turned up, a heavy one when it is downwards.

175. Let a be the area of the aperture in square inches; then, reducing the velocity for the contraction in passing the aperture, we have $300 a \sqrt{n-1}$ = the quantity of steam escaping in cubic feet per minute; n being the number of times the density is greater than that of atmospheric steam: or making c = the number of cubic feet of steam generated in a second, then

$$\frac{c}{5 n \sqrt{n-1}} = a, \text{ the area in inches.}$$

This quantity should obviously be the greatest which the fire could, under any possible circumstances, produce.

When n is less than 1, or the density less than the density of atmospheric steam,

that is, steam at 212° and thirty inches pressure, the equation becomes negative, and steam rises only by the difference between this negative quantity and the buoyancy ; leading us to the beautiful theory of evaporation.

An equivalent rule is given in my book 'On Warming and Ventilating;' but though it is from the same principles, it is not there so directly nor so generally derived.¹

¹ Treatise on Warming, &c. p. 148.

SECTION III.

OF THE GENERATION AND CONDENSATION OF STEAM, AND THE APPARATUS FOR THOSE PURPOSES.

ART. 176. STEAM is generated by the application of heat, and it is condensed by cold (art. 71.); and we have now to consider the best sources for obtaining the heat for its generation with economy, and the means of applying it so as to obtain the most effect. Our section therefore naturally divides itself into an inquiry concerning combustion and fuel; the effect of and application of fuel; the structure of boilers and fire-places; the principles of condensation, and the apparatus.

OF COMBUSTION AND COMBUSTIBLES.

177. There are various substances, which, when heated to a certain temperature depending on their nature, begin to give out heat, and continue to do so till the whole of the substance be completely changed into new products, most of them gaseous, which in ordinary cases are dissipated in the atmosphere. A substance which undergoes this change is termed a *combustible*, or burning body; and if it be commonly used for producing heat, it is called *fuel*.

178. The quantity of heat given out during combustion is the difference between that which the matter operated upon contained before, and that which it contains after combustion. This is an invariable quantity when the same quantity of matter is operated upon, and proportional simply to the quantity of fuel used; unless indeed the process be imperfectly managed, or that we could render the products of such a nature, that they would contain a less quantity of heat than those usually produced. The latter would perhaps be a fruitless research; but chemistry is making rapid advances in the means of fully establishing this point. It is however of the utmost importance, since the application of steam to navigation, to determine the effect of the mixture of combustible bodies, both with a view to fix on those which contain most heat to a given quantity of matter, and to

render the products of less capacity for heat, so as to gain the greatest effect ; using capacity to signify the whole heat these products contain, as defined art. 69.

179. There is no question that a solid contains less heat than the same substance when liquid, and the substance in the liquid less than in the gaseous state ; provided it remain the same chemical compound : but if to a solid, which is a mixture of different simple substances, heat of a certain degree of intensity be applied, the parts of the mixture act on each other, and gaseous products are obtained which contain less heat than the mixture. This is the case with gunpowder, which is a mixture of charcoal, nitre, and sulphur ; and it seems necessary in this species of combustion that one of the substances composing the mixture should be easily fusible. It is a completely mistaken notion to suppose that the presence of any particular substance is essential to combustion ; for it must take place in any mixture of bodies which act chemically on one another at a certain temperature, so as to form new products containing less heat than the substances mixed.

180. That which takes place in a mixture of bodies will also take place if either a simple body or a chemical compound be exposed to the action of another body, with which it always forms a new chemical combination if they be brought in contact at a high temperature. Thus charcoal, heated to about 700° , in contact with oxygen burns ; and the new product formed is carbonic acid gas ; consisting of the charcoal united to oxygen. At about 800° , charcoal abstracts the oxygen freely from the atmospheric air, and therefore burns. Now as the oxygen gas changes neither its volume nor its elastic force, it may be inferred that the whole of the heat contained in the charcoal is liberated, besides some portion of that previously in the oxygen.

181. It is important in this inquiry to know in what state the elements of bodies exist, because this must greatly affect the quantity of heat. If hydrogen in solid compounds be itself in its solid state, then it ought to give out less heat than gaseous hydrogen : but I am of opinion that hydrogen, carbon, and other permanent gases exist in combination in the state of highly compressed gases, and not in their solid state. The experiments I have to compare on combustion will be found to support this opinion ; rendering it tolerably certain, that, in the range of temperature we can command, these elementary bodies are never, even in the liquid state, in combination ; and we are thus freed from what I had regarded as the greatest difficulty in rendering the theory of combustion applicable to useful objects.¹ That this theory has been so neglected, since Count Rumford paid

¹ It has been assumed by the few who have considered this subject, that the combination of oxygen and hydrogen developed the same quantity of heat, whether the hydrogen was in a gaseous, a liquid, or a solid compound ; but this could not happen if in a solid compound the hydrogen were

attention to it, is wonderful, considering that it becomes every day more important. It is universally admitted that steam navigation loudly calls for some inquiry. The immense weight of a supply of ordinary fuel renders long voyages almost impracticable; and while the possibility of making fuel more effective, or of selecting one fuel more effective than another, remains probable, it is worthy of inquiry.

182. The first and most difficult point is, to determine the heat afforded when two simple or elementary bodies unite and form a compound body; but when the heat is determined for each of the binary combinations, that afforded by any other combinations of them may be calculated.

183. The measure of the effect of a combustible is, the number of degrees the heat developed in its combustion will raise the temperature of the same weight of water; or the weight of water that would be heated one degree, the weight of the substance being unity.

184. The heat afforded by carbon when it combines with oxygen is variously stated, and the results are in some measure dependent on the method employed for taking the quantity of heat, and in others the difference is owing to the quality of the charcoal.¹ It combines with two-thirds of its weight of oxygen.

According to Dr. Crawford, 1 lb. of carbon raises	-	10369 lbs. of water	1 degree.
Lavoisier	- - - -	13370	” ”
Count Rumford	- - - -	9720	” ”
Clement and Desormes	- - - -	13300	” ”
Hassenfratz	- - - -	12880	” ”
Dalton	- - - -	5600	” ”
		<hr/>	
		6)65239	
		<hr/>	
Mean	- -	10873	

The greatest discrepancy is in Dalton's experiments, which it appears was owing to the method he employed; and in taking 10800 lbs. of water raised one degree as the measure of the effect of carbon, we shall be nearly correct.

185. The heat afforded by hydrogen when it combines with oxygen is also

united particle to particle; and hence I conclude it exists only as a highly compressed gas in solids containing it, for it appears that it does afford the same quantity of heat in all states.

¹ Phil. Mag. vol. xli. p. 295; Thomson's System of Chemistry, vol. i. p. 148.

differently stated: it combines with eight times its weight of oxygen; and according to the experiments of

Dr. Crawford	-	-	-	-	67200
Lavoisier	-	-	-	-	41440
Dalton	-	-	-	-	44800

3)153440

Mean 51146 lbs. of water is raised 1° by one pound of hydrogen.

The number 50,000 therefore represents the mean effect of hydrogen very nearly, and, as far as we have compared it with other experience, seems to be about the true effect.

186. By the experiments of

Lavoisier, 1 lb. of phosphorus combining with oxygen	raises	-	-	-	-	-	15400 lbs. of water 1°.
Dalton	-	-	-	-	-	-	8400 " "

2)23800

Mean 11900

Sulphur combining with oxygen, according to Dalton, heats 2800 times its weight of water one degree.

187. From these we may proceed to compare the several compound bodies on which experiments have been made, and also to show the proportions of oxygen they consume. The first column of the following table contains the name of the substance, and the author of the analysis; the second column, its composition in decimal parts of its weight; the third shows the quantity of oxygen each of its components requires, and their sum, or that required for the substance; the fourth column shows the heat each component affords, and their sum is the whole the substance yields; the fifth and last column contains the whole heat afforded by the substance according to experiment.

Name.	Composition of combustible portion.	Weight of oxygen to support combustion, the weight of the combustible being <i>unity</i> .	Weight of water, in lbs., heated 1° by 1 lb. of the combustible.	
			By calculation.	By experiment.
GASES.				
Carbureted hydrogen	{ Hydrogen .25 Carbon .75	2· 2· — 4· =	12500	11900 Da.
			8100	
Olefiant gas	{ Hydrogen $\frac{1}{7}$ Carbon $\frac{6}{7}$	1·14· 2·3 — 3·44 =	7143	
			9257	
			16400	
Carbonic oxide	Carbon .43	.57	4744	3500 Da.
LIQUIDS.				
Alcohol, specific gravity .812 Ure's analysis	{ Hydrogen .1224 Carbon .4785	.98 1·27 — 2·25 =	6120	{ 8120 Da. 11150 Ru.
			5167	
Sulphuric ether, spec. grav. .7 Ure's analysis	{ Hydrogen .133 Carbon .596	1·06 1·59 — 2·65 =	6650	{ 8680 Da. 14454 Ru.
			6437	
			13087	
Oil of turpentine Ure's analysis	{ Hydrogen .0962 Carbon .825	.77 2·2 — 2·97 =	4810	8400 Da.
			8910	
Naphtha Ure's analysis	{ Hydrogen .123 Carbon .83	.98 2·22 — 3·20 =	6150	13200 Ru.
			8964	
			15114	
Olive oil	{ Hydrogen .1336 Carbon .772	1·07 2·06 — 3·13 =	6680	{ 20720 La. 12460 Cr. 16300 Ru. 14560 Da.
			8337	
Rape oil, or oil of colza			15017	

Name.	Composition of combustible portion.	Weight of oxygen to support combustion, the weight of the combustible being unity.	Weight of water, in lbs., heated 1° by 1 lb. of the combustible.	
			By calculation.	By experiment.
SOLIDS.				
Bees' wax, yellow	{ Hydrogen ·1137 Carbon ·8069	·91	5685	{ 18620 La. 13580 Cr.
		2·15	8710	
		<u>3·06</u>	<u>14395</u>	
Bees' wax, white				{ 17673 Ru. 14560 Da.
Tallow				{ 15064 Ru. 14560 Da.
Oak wood, dry and pure fibre Gay Lussac and Thenard's experiments	{ Hydrogen ·0569 Carbon ·5253	·455	2845	
		1·4	5673	
		<u>1·855</u>	<u>8518</u>	
Oak wood	{ Allowing 20 per cent for water, mucilage, &c. }	1·484	6825	5662 Ru.
Caking coal from Newcastle Thomson's analysis	{ Hydrogen ·0416 Carbon ·7516	·334	2080	{ 9230 Black 8675 Watt
		2·000	8100	
		<u>2·334</u>	<u>10180</u>	
Cherry coal from Glasgow Thomson's analysis	{ Hydrogen ·100 Carbon ·666	·8	5000	
		1·78	7192	
		<u>2·58</u>	<u>12192</u>	
Splint coal from Glasgow Thomson's analysis	{ Hydrogen ·044 Carbon ·568	·35	2200	
		1·52	6134	
		<u>1·87</u>	<u>8334</u>	
Splint coal, earthy matters not stated Ure's analysis	{ Hydrogen ·043 Carbon ·709	·345	2150	
		1·89	7657	
		<u>2·235</u>	<u>9807</u>	
Ditto	{ Allowing 10 per cent for ashes }		8826	
Cannel coal from near Coventry Thomson's analysis	{ Hydrogen ·2 Carbon ·626	1·6	10000	
		1·67	6760	
		<u>3·27</u>	<u>16760</u>	

Name.	Composition of combustible portion.	Weight of oxygen to support combustion, the weight of the combustible being <i>unity</i> .	Weight of water, in lbs., heated 1° by 1 lb. of the combustible.		
			By calculation.	By experiment. ¹	
Cannel coal from Woodhall near Glasgow Ure's analysis	Hydrogen	·0393	·315	1965	
	Carbon	·722	1·93	7799	
			<u>2·245</u>	<u>9764</u>	
Ditto	{ Allowing 10 per cent for ashes }			8788	
Charred peat Klaproth's analysis	Carbon	·525	1·4	5670	
Coke prepared in a close vessel Mean of Dr. Thomson's experiment	Carbon	·84	2·27	9070	9128 ²

188. These are the results as far as the latest researches in chemistry enable us to carry the comparison: it is sufficient to show that the correspondence is very close, and that the numbers we have selected for the binary compounds are very nearly the true ones. It will be particularly remarked, that in wax, oil, and those substances which are likely to afford the most accurate results, theory and experiment agree.

There is, however, still another mode of prosecuting our inquiries, and perhaps with equally satisfactory results.

189. In gas works, from the quantity of gas and coke afforded by a given quantity of coal or other matter, we have an approximate means of measuring its effect as fuel; but from the want of a correct knowledge of the density of the gas, in each case, we are obliged to assume it to be the same as carbureted hydrogen.

¹ The experiments marked Da. were made by Dalton, Ru. Rumford, and Cr. Crawford. The analyses of the substances are referred to their authors; Dr. Ure's will be found in his 'Chemical Dictionary,' and Dr. Thomson's in his 'Annals of Philosophy.'

² This is the result collected from a comparison of Lavoisier's experiments.—Treatise on Warming Buildings, art. 31.

Kind of fuel.	Composition.	Oxygen.	Heat.
Wigan cannel coal ¹	{ .134 gas .635 coke	0.54	2750
		1.45	5759
		<u>1.99</u>	<u>8509</u>
Staffordshire coal, inferior ²	{ .123 gas .61 coke	.49	2460
		1.39	5534
		<u>1.88</u>	<u>7994</u>
Peat. Klaproth's analysis ³	{ .100 gas .200 carbon	.4	2060
		.535	2160
		<u>.935</u>	<u>4220</u>

190. When any of these species of fuel is used for generating steam, there must be a loss of effect equivalent to the quantity of vapour formed from the hydrogen, and from the water in the fuel: one pound of hydrogen will form nine pounds of steam, and in practice the loss of effect will be one-fifth of the power of the hydrogen. This proportion being deducted from the whole effect, and also 1170 for each pound of water the fuel contained, we have the following table for the power of the most important species of fuel.⁴

Species of fuel.	Effect in lbs. of water heated one degree by 1 lb. of fuel.	Effect in lbs. of water converted into steam of 220°	Quantity to convert a cubic foot of water into low pressure steam.	Quantity to convert a cubic foot of water into steam, allowing 10 per cent for loss.
Olive oil	13700 lbs.	11.7 lbs.	5.3 lbs.	5.89 lbs.
Caking coal	9800 —	8.4 —	7.45 —	8.22 —
Coke prepared in close vessels	9000 —	7.7 —	8.1 —	9.00 —
Splint coal	7900 —	6.75 —	9.25 —	10.28 —
Staffordshire coal	7500 —	6.4 —	9.75 —	10.83 —
Oak wood, dry	6000 —	5.13 —	12.2 —	13.6 —
Charred peat, charred in close vessels	5670 —	4.85 —	12.9 —	14.3 —
Peat compact and dry	3900 —	3.35 —	18.7 —	20.8 —
Ordinary oak	3600 —	3.07 —	20.31 —	22.6 —
Peat compact in the ordinary state of dryness	3250 —	2.8 —	22.5 —	25.0 —

¹ Murdoch, Phil. Trans. 1808.

² Art. Gas Lights, Napier's Suppl. to Encycl. Brit.

³ Philosophical Magazine, vol. xvii. p. 312.

⁴ The latent heat of steam is 1000, (art. 82.) the temperature of low pressure steam is 220°, and

These quantities, derived entirely from theoretical considerations, are so near to the actual effects obtained in practice, that they show us we have little to expect in the form of improvement; and with the addition of one-tenth for various causes tending to decrease the effect, they may be adopted as the measure of effect in those computations we have to make; and the table affords an easy means of comparing the expense of different kinds of fuel.

191. The trials of the quantity of steam a given quantity of fuel will produce, are by no means so numerous as might be expected by those who know not the difficulty of ascertaining the results with precision. People shrink from the task of making accurate trials, either in consequence of the great degree of attention and labour they require, or the expense. The adoption of methods arising out of a competent knowledge of the subject reduces both these in a considerable proportion.

The following brief collection may be useful.

Kind of fuel.	Effect in lbs. of water heated 1° by 1 lb. of fuel.	Low pressure steam of 220° from 52°.	
		Weight of water converted into steam by 1 lb. of fuel.	Weight of fuel to form a cubic foot of water into steam.
Newcastle or Swansea coal, according to Mr. Watt } From	6950 lbs.	5.93 lbs.	10.5 lbs.
	To	8.9 —	7.0 —
	Mean	8.675 —	8.75 —
Newcastle coal, according to Dr. Black	9230 —	7.9 —	7.9 —
Newcastle coal, Wall's End, by my trials	10050 —	8.6 —	7.25 —
Wednesbury coal, according to Mr. Watt, } From	5200 —	4.45 —	14.0 —
	To	7.800 —	9.34 —
	Mean	6500 —	5.56 —
Pine wood (dry), Count Rumford's experiments	3618 —	3.1 —	20.02 —
Oak wood (dry) _____	5662 —	4.85 —	12.9 —
Peat, compact, from Dartmoor, in the ordinary } state of dryness, by my trials	2400 —	2.05 —	30.5 —
Culm (Glasgow) _____	3330 —	2.85 —	22.0 —
Culm (Welsh) _____	4175 —	3.56 —	17.5 —

Sleck, or refuse small coal, produces about three-fourths of the effect of good coal of the same species.

We have hitherto considered effect only when fuel gives the whole, or nearly the whole, of its heat; but a certain rate of combustion and perfect management are requisite to obtain this end.

the mean temperature of the air being about 52, we have $1000 + 220 - 52 = 1170$ nearly; hence dividing the effect in pounds of water heated 1° by 1170 we have the pounds of water that would be converted into steam, and by proportion, the quantity which converts 62.5 lbs. or a cubic foot of water into steam.

PROCESS OF COMBUSTION.

192. The elementary bodies require very different degrees of heat to cause them to form new combinations. Sir H. Davy has rendered it probable that charcoal and oxygen combine at about 700° , when common air is not present; and hydrogen and oxygen at about 800° . But when the oxygen is afforded by the common air, about 800° for carbon, and 950° ¹ for hydrogen, seems to be nearer the temperatures at which they inflame readily; and when the fuel affords incombustible gases, the intensity will still require to be increased. Hence we need not be surprised to find, in the common mode of applying heat, that except in as far as it increases the draught through the fire, it is of little or no advantage for a fuel to contain a large proportion of hydrogen. On the other hand, if the intensity of the heat be too great, the earthy parts of the fuel combine with some portion of the carbon and fuse, forming the glassy scoriæ called *clinkers*, by which some combustible matter is lost. We may expect this effect to take place in a considerable degree whenever the heat approaches to about 1500° , and therefore infer that an average heat not exceeding about 1200° is the best for the production of effect.

The circumstances which must be attended to, that the fuel and its products may remain in this temperature till they be consumed, are next to be considered.

193. First. A quantity of air sufficient to supply the oxygen required for combustion must have as free access as possible to all the parts of the burning mass, and with as little exposure of the surface of the mass to the cooling effect of other air as the draught of the chimney will allow.

194. Secondly. The quantity or mass of fuel in combustion must be of such a proportion to the quantity and temperature of the surface to which it communicates heat, that it can only lose as much heat as it generates when it arrives at the best temperature for combustion; allowing for the cooling effect of the surface acted on by the air required in the process.

195. Thirdly. The flame and smoke must be kept in contact with the vessel as long as it is capable of affording heat.

196. Fourthly. The fluid to be evaporated should enter so as first to receive the heat where the smoke last acts on the fluid, so that there may be the greatest possible difference of temperature between the smoke and the fluid; and, consequently, that the fluid may deprive the smoke of heat, as it becomes gradually heated to the temperature of the vapour before it arrives over the fire.

¹ Dr. Thomson says about 1000° from his own experiments. System of Chemistry, vol. i. p. 224.

SUPPLY OF AIR AND AREA OF FIRE GRATING.

197. The most effective method of supplying fuel regularly with air, that has yet been tried, is that of burning it on a grate placed over a pit to receive the ashes.

And in examining this subject, we have first to inquire what quantity of air must pass through the fire for the combustion of each species of fuel. It has been shown that the different species of fuel require different quantities of oxygen. For the different kinds of coal it varies from 1·87 to 3 lbs. for each pound of coal, and twelve cubic feet of oxygen weigh one pound; also to obtain one pound of oxygen five pounds of air must pass through the fire; consequently, sixty cubic feet of air will be necessary to afford one pound of oxygen. But it is not possible to render the whole of the air effective; part of it will escape unchanged by combustion, and the allowance I have usually made is that only two-thirds is effective; therefore we require ninety cubic feet of air for each pound of oxygen, and the product when carbon alone is consumed is carbonic acid, and the specific gravity of the air after thus changed by combustion will be 1·05. But a fuel sometimes contains hydrogen, and in that case the oxygen and hydrogen form steam of double the volume of the oxygen; and the bulk of the mixture of air and vapour will be 102 feet for each pound of oxygen combining with hydrogen, and its specific gravity will be 0·9. The last column of the following is computed from the numbers given in the last column of the preceding table, (art. 190.)

Kind of fuel.	Air and smoke for each pound.	Specific gravity of smoke.	Air and smoke for one cubic foot of water converted into low pressure steam.
Caking coal	214	1·03	1780 cubic feet.
Cherry coal	242	1·00	
Splint coal	172	1·02	1780 ———
Cannel coal	315	1·01	
Coke	216	1·05	1950 ———
Ordinary wood	173	0·90	3900 ———

It appears therefore that we may state the quantity of air and smoke in round numbers, for coal and coke, at 2000 cubic feet, for each cubic foot of water converted into steam, and for wood at 4000 cubic feet.

198. The grate must be sufficient to admit the air required for combustion in the state of expansion due to the temperature of the burning fuel; and it is moved through the fire by the joint effect of the draught of the chimney and the ash-pit; hence, as deep an ash-pit below as possible should be procured, the ash-pit narrowing to a uniform breadth, the same width as the grate before it arrives at

the fire, the object being to increase the action of the fire without hastening the smoke too rapidly along the flues. By means of the formula in art. 172. we easily compute the area of the spaces between the grating under these circumstances. For coals, the quantity for generating the steam of a cubic foot of water is 2000 cubic feet, the temperature not less than 800°, and the height producing the motion being h feet, we have

$$\frac{70}{\sqrt{h}} = \text{the area of the spaces ;}$$

and, the bars being usually equal in thickness to about three times the space between them,

$$\frac{280}{\sqrt{h}} = \text{the area of the grating for coals in inches ;}$$

$$\text{or } \frac{2}{\sqrt{h}} = \text{the area in feet for one horse power.}$$

When the height from the ash-pit, to where the smoke enters the chimney, is four feet, then the area is one foot ; and one foot of area of grate for each horse power is the common rule of practical engineers.

The proportion of aperture to the solid part of the bar is not always the same, but it ought to be about in the proportion above stated, as air expands to nearly $2\frac{1}{2}$ times in bulk while in the fire.

199. For burning wood and peat the area of the grate must be

$$\frac{4}{\sqrt{h}}$$

for each cubic foot of water converted into steam ; where h is the depth of the ash-pit in feet ; the increased area being gained by increasing the size of the bars.

OF THE SURFACE OF BOILER TO RECEIVE THE EFFECT OF THE FIRE.

200. The surface of boiler to produce a given effect must be sufficient to receive the heat which will produce the supply of steam ; and as fire or bottom surface is the most effectual, that kind of surface should be of sufficient area to receive the whole effect of the fire ; while the flue surface, or sides, may receive the effect of the smoke. Hence we have an easy mode of determining the proportions.

The mean heat of a close fire-place may be considered T ; and if t be the temperature of the steam, and s the bottom surface, then the heat of conversion of water to steam being 1000, added to its temperature less 52°, we have, from an

experiment made by Professor Leslie,¹ $\cdot 828 s (T - t) = 948 + t$, when one cubic foot of water is to be converted into steam in an hour; or

$$s = \frac{948 + t}{\cdot 828 (T - t)}.$$

201. When a mass of fuel is in combustion in a close fire-place, we have shown that it is not desirable for its temperature to exceed 1200° , (art. 192.) Now the surface of the boiler must be at some distance from the fuel, to allow it to develop flame, and therefore the heat having a larger surface to act upon its intensity is less, but at a mean ought not to be less than about 800° , for coal; consequently we may insert 800 for T . For low pressure steam $t = 225^{\circ}$, hence,

$$s = \frac{948 + 225}{\cdot 828 (800 - 225)} = 2\cdot 5 \text{ feet, nearly.}$$

For steam of 300° , the force of which is about 40 lbs. per circular inch above the pressure of the atmosphere, we have

$$s = \frac{948 + 300}{\cdot 828 (800 - 300)} = 3\cdot 0 \text{ feet.}$$

These examples will be sufficient to show the increased quantity of surface required for high pressure steam, and we may now proceed to estimate the quantity of side flue.

202. At an average for coal, 2000 cubic feet of gaseous matter, heated to 800° , is generated, and required for combustion to produce the above effect; and the specific heat of air being $\cdot 00032$, its effect will be equivalent to heating a cubic foot of water $\cdot 00032 \times 2000 \times (800 - t) = \cdot 64 (800 - t)$. Now it will be sufficiently accurate for our purpose to consider the effective excess of temperature to be a little less than the mean between 800 and t ; consequently,

$$\frac{\cdot 828 s' (800 - t)}{2\cdot 5} = \cdot 64 (800 - t); \text{ or } s' = 1\cdot 94 \text{ feet.}$$

203. Comparing $\cdot 64 (800 - t)$ with $948 + t$, we find that the whole energy of the side of flues will amount only to about one-fourth of the effect of the bottom ones; we may therefore reduce the fire surface found by the rule one-fourth for each cubic foot of water evaporated per hour. The rule will then become

$$s = \frac{3 (948 + t)}{4 \times \cdot 828 (800 - t)} = \frac{948 + t}{1\cdot 1 (800 - t)}.$$

204. But in a steam engine boiler this would barely keep the boiler supplied, whereas it is shown that there should be a capability of supplying steam with double the rapidity actually required, otherwise the pressure on the piston will be

¹ Inquiry into the Nature of Heat. Experiment 51 and 52.

less, and the effect less in the same ratio (see art. 331—339); according therefore to this condition the proportion of bottom should be

$$s = \frac{2(948 + t)}{800 - t}$$

The side flue constantly = $2 \times 1.94 = 3.88$ which may be called 4 feet.

Common or low pressure steam, temperature 225°	{ Bottom of boiler . . . 4.1 feet	} For converting 1 cubic foot of water per hour into steam.
	{ Side of boiler flue . . . 4	
2 Atmospheres, temperature 250°	{ Bottom 4.36	
	{ Side 4	
3 Atmospheres, temperature 275°	{ Bottom 4.6	
	{ Side 4	
4 Atmospheres, temperature 293°	{ Bottom 4.9	
	{ Side 4	
5 Atmospheres, temperature 308°	{ Bottom 5.1	
	{ Side 4	
8 Atmospheres, temperature 343°	{ Bottom 5.65	
	{ Side 4	

For sea-water, and low pressure or atmospheric steam,

Temperature 230°, it requires	{ Bottom of boiler . . . 4.14	} For converting 1 cubic foot of water per hour into steam.
	{ Side of do. 4.0	

205. In comparing these with the usual rules, the sum of the bottom and sides must be taken; and it may be remarked that one cubic foot of steam per hour is so nearly equivalent to the horse power used in steam engine calculations, for the larger kinds of engines, that they may be considered the same in these comparisons. Also a bushel of Newcastle coals may be considered equivalent to 10 cubic feet of water converted into steam.

Smeaton, with his wonted care, prepared a table showing the surface of boiler required to be exposed to the effect of the fire and smoke for atmospheric engines, and the quantity of coals to be consumed per hour. His quantity of surface for 1 bushel per hour is 88 feet, and for 13 bushels per hour, not quite 82 feet of surface per bushel.¹ This is equivalent to 8.2 feet of surface for converting 1 cubic foot of water into steam per hour. Our deduction, from calculation, is 8.1 feet for low pressure steam.

Mr. Watt says, he finds that, “with the most judiciously constructed furnace, it requires 8 feet of surface of the boiler to be exposed to the action of the fire and

¹ Rees’s Cyclopædia, art. Steam Engine.

flame to boil off a cubic foot of water in an hour;"¹ which is only the rule of Smeaton in general terms.

206. The proportion of the bottom surface, or that within the immediate effect of the fire and flame, seems to have been subjected to no fixed rule: the proportions used in practice vary from 3 to 5 feet of bottom surface for each cubic foot of water boiled off per hour. Mr. Millington seems to have first indicated the use of measuring the power of a boiler by its bottom surface; and gives as examples, that a boiler for 20 horse power is usually 15 feet long and 6 wide, having 90 feet of surface, or $4\frac{1}{2}$ feet to 1 horse power; a boiler for a 14 horse power, 60 feet of surface = 4.3 feet to 1 horse power.² I have observed boilers to be incapable of supplying the proposed quantity of steam when they had less than 4 feet; and that those were effective which have the proportion assigned by the rule above, provided they also had a proper quantity of flue surface.

207. In regard to high pressure steam, some interesting trials were made by Mr. Wood³ with steam carriage engines, which show the disadvantage of attempting to form steam by intensity of heat instead of quantity of surface.

The first was with a steam carriage boiler 8 feet in length, and 3 feet 9 inches in diameter, with a tube 20 inches diameter, passing through its length, which contains the grate for the fuel from whence the smoke passes along to an upright tube at the end, serving as a chimney: the pressure of the steam in the boiler was limited to 50 lbs. per square inch above the atmosphere.

The whole surface of the tube forming the fire-place and flue would be only 40 feet; and it was the same in all the trials, but of this not more than two-thirds or 27 feet could be effective as fire surface.

208.

Time of experiment.	Coals consumed per hour.	Water boiled off per hour.	Weight of fuel to boil off a cubic foot of water.	Surface of boiler to each cubic foot.
9 hrs. 35 min.	264 lbs.	15.5 feet	17.0 lbs.	1.74 feet
9 — 27 —	268 —	15.1 —	17.6 —	1.79 —
4 — 48 —	323 —	15.8 —	20.5 —	1.71 —

The mean intensity of the fire must have been equal to 1200° , to produce this effect; and the fuel consumed is somewhat more than double the quantity which ought to have generated the same quantity of steam.

209. In another trial the length of the boiler was 9 feet 2 inches, its diameter 4 feet, the diameter of the tube 22 inches, and the force of the steam limited

¹ Robison's Mechan. Phil. vol. ii. p. 147.

² Epitome of Natural Philosophy, p. 266.

³ Treatise on Rail Roads, p. 249.

to the excess of 50 lbs. per square inch. In this case the whole surface of the tube in contact with the water of the boiler could not exceed 52 feet; and two-thirds of this being taken as effective, we have 35 feet for the surface.

Time of experiment.	Coals consumed per hour.	Water boiled off per hour.	Weight of coal to boil off a cubic foot of water.	Surface to a cubic foot of water per hour.
6 hrs. 32 min.	230 lbs.	12·2 feet	18·8 lbs.	2·87 feet
1 — 26 $\frac{1}{4}$ —	410 —	23·0 —	17·8 —	1·52 —

The difference of the results in these trials is chiefly owing to a difference in the density of the steam in the boiler, its state not having been ascertained; and though it might be done in an indirect manner from the number of strokes per minute and the resistance, it would not be accurate enough to furnish us with any useful conclusions.

OF THE SPACE FOR STEAM AND WATER IN BOILERS.

210. A boiler must obviously contain as much steam as will supply the engine at each stroke without any material decrease in its elastic force; and the space will therefore depend on the manner the steam is to be supplied. If it be admitted to the engine only during part of the time of the piston's descent, there must be so much steam that the use of the quantity required may not lessen the elastic force. If the steam be generated equably, and the space for it be only equal to the quantity consumed at each stroke, and all the quantity be wanted during the descent of the piston, the elastic force in the boiler will vary one-half, and the loss of effect be very considerable: this subject is therefore worthy of further inquiry, in order that we may see how far the maxims of practice are confirmed by just principles. Without specifying the kind of engine, it is stated that a boiler should have space for five or six times the volume of steam required for a stroke;¹ others mention eight times: Dr. Young quotes a remark that it should contain ten times the volume,² and Prony has stated that it is one of the advantages of a double acting engine, that it requires a smaller boiler than a single acting one.³

211. Let it be supposed that the action of the fire is uniformly the same, and that during a *unit* of time it generates a *unit* of volume of steam, and that this volume is sufficient to supply the engine; but that the whole of it is required in

¹ Millington's Epitome of Natural Phil. p. 251.

² Natural Phil. vol. ii. p. 259.

³ Architecture Hydraulique, vol. ii. p. 106.

some less time t ; and that c is the capacity of the space for steam in the boiler, and p the elastic force at the commencement of letting on the steam. Then $c + t - 1$ is the quantity of steam in the space c at the end of letting on the steam; and the elastic force being inversely as the space, it will be

$$\frac{p(c+t-1)}{c}$$

at the time it is shut off; and the variation will be

$$p - \frac{p(c+t-1)}{c} = p\left(\frac{1-t}{c}\right).$$

Now in a single acting engine the time t when it acts at full pressure is one-half, hence $\frac{p}{2c}$ is the loss of elastic force; but if we make $c =$ eight times the quantity required, the loss is only $\frac{1}{16}p$, or the elastic force varies only $\frac{1}{16}$, or about one pound on the square inch.

212. If the steam be cut off before the stroke be completed, the variation will obviously be greater; for example, in a single engine cut the steam off at half the descent, and the variation of elastic force in the boiler will be $p\frac{3}{4c}$, or $\frac{1}{11}$ nearly, when the capacity for steam in the boiler is eight times the quantity required for the stroke.

213. In the double acting engine, the steam acting at full pressure, the time t is nearly the same as the time denoted by 1, and about three times the quantity required for the stroke may be sufficient; but if the steam be cut off at any fractional portion of the stroke, put t equal to that fraction, and it will be found to what the capacity must be increased, to render the variation of force inconsiderable. Thus if it be cut off at half the stroke, then

$$p\left(\frac{1-\frac{1}{2}}{c}\right) = \frac{p}{2c},$$

the same as in single engines, and we should not make c less than 8. But it must be remarked, that it is in all these cases c times the volume of steam as it is in the boiler, and not c times the capacity of the cylinder, because during the time the steam acts by expansion, there is none entering the cylinder.

214. For each cubic foot of water converted into steam in an hour by a low pressure boiler, we may assume that one cubic foot of steam is used at a stroke without material error; and if, as agrees with other parts of the arrangement of an engine, the variation be limited to $\frac{1}{30}$ of the force of the steam, we shall have

$$\frac{1-t}{c} = \frac{1}{30} \text{ or } 30(1-t) = c.$$

That is, calling the interval 1 from the time the steam valves are opened to the

cylinder to a succeeding time of opening them ; let the fraction of that interval during which the steam valves are open be subtracted, and 30 times the difference will be the space for steam in cubic feet in a low pressure engine.

Thus, let it be a double acting engine where the steam is cut off at two-thirds of the stroke ; then the whole stroke is the distance of the times of opening the steam valves, and two-thirds is the fraction ; therefore $1 - \frac{2}{3}$ is $\frac{1}{3}$, and $30 \times \frac{1}{3}$ is 10 cubic feet.

215. In a high pressure boiler the same rule applies ; only instead of being the space in feet, 30 times the difference must be divided by the density of the steam compared with the atmospheric steam as unity.

This may be done with sufficient nearness in practice, by dividing by the number of atmospheres equal to the force of the steam in the boiler.

If in a double acting high pressure engine, which admits the steam only during half the stroke, the force of the steam in the boiler be 4 atmospheres, then for each cubic foot of water the boiler is to boil off per hour there should be

$$\frac{30 (1 - \frac{1}{2})}{4} = 3.8 \text{ cubic feet of space for steam.}$$

216. Even in a double engine, which is intended to act at full pressure throughout the stroke, there is the time of opening and closing the valves to be deducted ; and in some of the usual modes one-fourth of the stroke at least is expended, so that we can scarcely in any case say that less than 8, divided by the atmospheres representing the force of the steam in the boiler, should be allowed as the space in feet for steam for each cubic foot of water boiled off per hour.

217. *Space for Water in a Boiler.* That there should be water to cover the sides of the boiler a little higher than the flues, is clear ; but there is another condition which is less obvious but of considerable importance in effect, and it is particularly interesting in steam boats, where we wish to have neither more of space nor weight than is absolutely necessary.

The quantity of water an engine consumes is not admitted with perfect regularity ; it is most equably done when forced in by a pump worked by the engine, and the portion admitted regulated by a float ball. See Plate I. Fig. 2.

The quantity necessary to produce the steam must however be admitted, and its temperature we will suppose to be 100° ; now the water in the boiler we will suppose to be 225° , and the proportion of the quantity in the boiler to that admitted ought to be such that the temperature should not be lowered, so as to reduce the force of the steam one-thirtieth part ; otherwise a manifest disadvantage must take place in the action of the steam. But the depression of the temperature of the water 2° will diminish its elastic force one-thirtieth ; hence, supposing the quantity

introduced at each time to be 1, and the quantity in the boiler to be x , we must have

$$\frac{(1 \times 100) + (x \times 225)}{1 + x} = 225 - 2 = 223;$$

whence we find $x = 62$ nearly; that is, there must be 62 times as much water in the boiler as is introduced at one feed, otherwise the force of the steam will be lowered more than one-thirtieth. The rule applies to both high and low pressure steam; for the variation by a change of 2° of temperature is nearly proportional. The more frequently the feeding apparatus acts, the less water we require, and we also see a stronger motive for using hot water for the boiler than that of barely saving fuel; as the colder it is, the more the steam will be reduced. If a boiler be fed at every stroke, it should have 5 cubic feet of water for each cubic foot of steam it is capable of boiling off per hour, whether the boiler be high or low pressure.

218. The self-acting feeding apparatus must be delicately adjusted to reduce its intervals to even twice that time, and therefore such boilers require at least 10 cubic feet of water for each cubic foot of water boiled off per hour. But a mode of rendering the self-acting feed regular is shown in Plates I. and II.

219. It is shown therefore, that to limit a low pressure steam boiler of a double acting engine, with a self-acting feed, to a change of elastic force not exceeding one-thirtieth, we must have 10 feet space for steam and 10 for water for each cubic foot of water the boiler commonly generates in an hour, or for each horse power; and that if the steam be cut off before the stroke is completed, a greater space must be allowed for steam.

220. It is usually stated that there should be 25 cubic feet of boiler for each horse power, others say 20 is sufficient, and even so low as 8 has been proposed; while another party states that there is no relation between the cubic contents of the boiler and the power. We have now however shown, on unquestionable principles, what ought to determine the least contents of the boiler; and it appears that to omit the estimation either of the surface to receive heat or the capacity, would be erroneous. Both should be considered and determined from the circumstances of the case.

OF THE POWER OF LOW PRESSURE BOILERS.

221. The power of boilers to produce steam is considerably affected by the loss of heat, and a small boiler more so than a large one.

It is one of those cases which seems to be incapable of being investigated otherwise than by experience. In a boiler proportioned to the effect to be pro-

duced, the loss of energy seems to be in the fuel, and it appears to agree very well with practice to consider the loss proportional to the ratio between the surface and capacity of the quantity of fuel, supposing it to be bounded by similar figures. In this manner the following table is derived.

Cubic feet of steam per hour equivalent to power of boiler.	Bottom surface for each horse power.	Side surface for each horse power.	Horse power for low pressure steam.	Quantity of water in boiler with common feed for each horse power.
2·16 cubic feet	8·8 feet	8·6 feet	1 horse power	22 cubic feet
1·73 _____	7·1 —	6·9 —	2 _____	17 _____
1·56 _____	6·4 —	6·2 —	3 _____	16 _____
1·46 _____	6·0 —	5·8 —	4 _____	15 _____
1·39 _____	5·7 —	5·5 —	5 _____	14 _____
1·35 _____	5·6 —	5·4 —	6 _____	13·6 _____
1·32 _____	5·4 —	5·3 —	7 _____	13·2 _____
1·29 _____	5·3 —	5·2 —	8 _____	13·0 _____
1·26 _____	5·2 —	5·1 —	9 _____	12·5 _____
1·25 _____	5·1 —	5·0 —	10 _____	12·5 _____
1·22 _____	5·0 —	4·9 —	12 _____	12·2 _____
1·2 _____	4·9 —	4·8 —	14 _____	12 _____
1·18 _____	4·8 —	4·7 —	16 _____	12 _____
1·17 _____	4·8 —	4·7 —	18 _____	12 _____
1·16 _____	4·75 —	4·6 —	20 _____	12 _____
1·13 _____	4·6 —	4·5 —	25 _____	11 _____
1·12 _____	4·6 —	4·5 —	30 _____	11 _____
1·10 _____	4·5 —	4·4 —	40 _____	11 _____

When a boiler is made of a larger size than would supply an engine of 30 or 40 horse power with steam, it is much better to make two boilers, and to set them side by side, and besides these there should be a reserve boiler to put in use during repairs. That is, for a 40 horse engine I would recommend three 20 horse power boilers; for a 60 horse engine three 30 horse power boilers, and so on; and for smaller engines two boilers, each equivalent to the power of the engine.

OF THE FORM OF BOILERS AS IT DEPENDS ON EFFECTS.

222. The quantity of fire and of flue surface having been ascertained, and the capacity, the next object is to consider the form of boiler best adapted for obtaining these proportions in a convenient manner. If we were to consider the strength of the metal alone, they would be nearly spherical, but we well know that a sphere has the least quantity of surface of any solid having the same capacity.

223. The first boilers used for engines were nearly of a spherical shape. The bottom was next altered to a concave surface, the flue sides were made nearly perpendicular, and the upper part still retained a hemispherical shape. This form

was essentially a short cylinder placed on its base, and terminating in a hemispherical head.

224. *Watt's Boilers.* A rectangular form was adopted by Mr. Watt for the lower portion of the boiler; the upper part he made half a cylinder: the bottom was made concave, but the sides flat. For low pressure steam a boiler may be made abundantly strong of this form, and it affords a little more surface without materially increasing the space the boiler occupies. Making the bottom concave towards the fire also may cause the sediment to settle in the angles instead of immediately over the fire. In large boilers a flue was formed through the middle of the boiler, so as to be covered by the water within.

It was justly remarked by Mr. Watt, that the sole object of the arrangement of his boilers "was to economise the fuel as much as possible. It is not the shallowness or depth of the boiler that produces this effect; but the making of the boilers of such a shape that the air which passes through the fire shall be robbed of almost all its heat before it can make its escape."¹ Mr. Watt assured Dr. Thomson that this object is very well attained by the construction he had adopted, and it undoubtedly is so.

225. When a boiler of a rectangular plan (see Plate 1.) is used, the relations of the length, width, and depth to obtain the necessary quantity of surface and of capacity are easily found, when it has no internal flues; and it is doubtful whether any advantage is gained by such flues or not. The following is an approximate rule for the purpose.

RULE. Take the capacity of the boiler for water, and divide it by the quantity of bottom surface, (art. 221.) the result will be the depth of water.

Multiply together the bottom and side surface for fire and flue, (art. 221.) and divide the product by twice the capacity for water, less the area of the bottom surface, and the result will be one of the dimensions of the bottom.

Divide the bottom surface by the dimensions found, and it gives the other.

Example. To find the proportions of a boiler for an engine of 12 horse power, the capacity for water being 12·2 cubic feet for each horse power.

In this case $12 \times 12\cdot2 = 146\cdot4 =$ the capacity of the boiler for water; and the bottom surface $5 \times 12 = 60$ feet, hence

$$\frac{146\cdot4}{60} = 2\cdot44 \text{ feet,}$$

the depth of water.

¹ Dr. Thomson's *Annals of Philosophy*, vol. vii. p. 173.

Also the bottom surface multiplied by the side surface = $60 \times 59 = 3540$; which divided by $(2 \times 146.4) - 60 = 232.8$ is

$$\frac{3540}{232.8} = 15 \text{ feet nearly,}$$

for one dimension.

Consequently,

$$\frac{60}{15} = 4 \text{ feet,}$$

for the other dimension ; or the boiler should be 15 feet long and 4 feet wide.

226. If the capacity of the top for steam be the same as that for water, and the form a semi-cylinder, the whole depth of the boiler may be found with sufficient accuracy for practice, by making it twice the depth of the water added to one-tenth of that depth ; in the example it will be $(2 \times 2.44) + .244 = 5.124$ feet.

The proportions given by the rule are different from those commonly used, not much in capacity, but considerably in extent of surface for receiving heat, and in having greater length and less width. Boilers of such proportions are undoubtedly stronger as well as more effective.

227. *Cylindrical Boilers.* Cylindrical boilers, with the ends rather flat segments of spheres, should always be used for the production of strong or high pressure steam ; and even for low pressure steam this form seems best.—See Plate II. Many schemes have been suggested for using combinations of cylinders or tubes ; but it is extremely questionable whether any plans have been suggested superior to a simple cylinder with convex ends, and applying as many of these as are necessary for the object.

228. Sometimes the cylinder forming the boiler has the fire wholly within it ; and in consequence of this arrangement it is impossible to get surface for the fire to act on, unless the boiler be of such diameter as to render it extremely dangerous. The immense waste of fuel is shown by the experiments of Mr. Wood, (art. 208.) and yet these boilers have a diameter of 4 feet, with a pressure of 4 atmospheres, tending to separate the parts of the boiler with a force exceeding 140 tons, and only a rude safety valve to limit the steam to this force.

229. *RULE for Cylindrical Boilers.* When a fire is applied externally to a cylinder which is to contain both water and steam, let the capacity for water and for steam be added together, and also the quantities of fire surface ; then divide twice the capacity by the quantity of fire surface, and the result will be the diameter. Also 1.27 times the capacity divided by the square of the diameter will be the length.

Example I. Let the proportions of a high pressure boiler be determined, so that

it shall be capable of converting 7 cubic feet of water into steam per hour, at a pressure of 4 atmospheres.

A boiler for this purpose should contain about 9 cubic feet of space for each cubic foot of water boiled off per hour; consequently, its whole content will be 63 cubic feet. The surface for the fire should be $7 \times (4.9 + 4) = 62.3$ feet, (see art. 204.) Therefore

$$\frac{2 \times 63}{62.3} = 2.02 \text{ feet, the diameter.}$$

And

$$\frac{1.27 \times 63}{2.02 \times 2.02} = 20 \text{ feet, the length.}$$

Example II. Let the boiler be required to boil off 24 cubic feet of steam per hour, at 3 atmospheres, with 11 feet of space in the boiler for each cubic foot boiled off.

The content = $11 \times 24 = 264$ feet. The surface $24 \times (4.6 + 4) = 206.4$ feet; therefore

$$\frac{2 \times 264}{206.4} = 2.6 \text{ feet nearly, the diameter.}$$

And

$$\frac{1.27 \times 264}{6.8} = 50 \text{ feet nearly;}$$

but two boilers each 25 feet long would be better.

Example III. If a low pressure steam boiler be made cylindrical for a 12 horse power, under the same conditions as a rectangular one, (art. 225.)

Then the content = $12 \times 2 \times 12.2 = 292.8$ feet. And the surface = $12 (5 + 4.9) = 118.8$ feet; therefore,

$$\frac{2 \times 292.8}{118.8} = 5 \text{ feet nearly, the diameter;}$$

$$\text{also } \frac{1.27 \times 292.8}{5 \times 5} = 14.8 \text{ feet.}$$

The boiler should therefore be 14.8 feet long, and 5 feet in diameter, and this I think a better form for boilers than the usual rectangular ones.—See Plate n.

230. The steam pipe S should lead from immediately over the fire, and the water should be admitted at the opposite end at N; and in order that the sediment may be with more certainty deposited where the fire has least force, I would insert a partition O across the boiler, to rise within about four or five inches of the surface of the water. This would prevent cold water checking the steam, and also cause the deposit of sediment to take place where the water entered

the boiler, and would confine the cooler parts of its content to where the smoke was of the lowest temperature.

231. Smaller cylinders, or rather tubular boilers, have frequently been proposed for generating steam; Blakey's has already been mentioned, (art. 25.) and Count Rumford had one put up at the Royal Institution, in 1796, for generating steam for warming the rooms. His ideas on the application of his construction to steam engine boilers are worthy of attention.

232. *Count Rumford's Boiler.* The object of this boiler was to get a larger quantity of surface, and the Count had a model of it made and presented to the French Institute. (October, 1806.) This model, as far as it differs from an ordinary steam boiler, being described, the reader will easily understand how to apply it on the large scale.

The body of the boiler is in the shape of a drum: it is a vertical cylinder of copper, 12 inches in diameter and 12 inches high, closed at the top and bottom by circular plates.

In the centre of the upper plate there is a cylindrical neck 6 inches in diameter, and 3 inches high, shut at the top by a plate of copper, 3 inches in diameter and 3 lines in thickness, fastened down by screws.

The flat circular bottom of the body of the boiler, which as before stated is 12 inches in diameter, being pierced by seven holes, each 3 inches in diameter, seven cylindrical tubes of thin sheet copper, 3 inches in diameter and 9 inches long, closed at the lower ends by circular plates, are fixed in these holes, and firmly riveted, and then soldered to the flat bottom of the boiler.

On opening the communication between the boiler and the supply cistern, the water first fills the seven tubes, and then rises to the cylindrical body of the boiler; but it can never rise above six inches in the body of the boiler, for when it has got to that height, the floater is lifted to the height necessary for shutting the cock that admits the water. As the seven tubes that descend from the flat bottom of the body of the boiler into the fire-place are surrounded on all sides by the flame, the liquid contained in the boiler is heated, and made to boil in a short time, and with the consumption of a relatively small quantity of fuel; and when the vertical sides of the body of the boiler, and its upper part, are suitably enveloped, in order to prevent the loss of heat by these surfaces, this apparatus may be employed with much advantage in all cases where it is required to boil water for procuring steam.

And in the case where the boiler is constructed on a great scale, the seven tubes that descend from the bottom of the boiler into the fire may be made of cast iron, whilst the body of the boiler is composed of sheet iron or sheet copper.

But in all cases where it is required to produce a great quantity of steam, it will

always be preferable to employ several of these boilers of a middling size, placed beside each other, and heated each by a separate fire, instead of using one large boiler heated by one fire. For Count Rumford has shown by experiment, in his Sixth Essay 'On the Management of Fire and Economy of Fuel,' that beyond a certain limit, there is no advantage derived from augmenting the capacity of a boiler.

The additional surface obtained by using tubes is unquestionable; and the construction proposed by the Count might be applied with much benefit where much surface is to be gained in a small space. The tubes should, however, have that proportion of capacity necessary for an engine boiler, and not be too small to contain an ascending and descending current.

233. *Woolf's Boilers.* The idea of cylindrical tubes and a magazine for water and steam was further expanded by Mr. Woolf into a variety of forms, which were successively adopted and abandoned. His first project was to have a horizontal cylinder for containing steam and water, with a series of horizontal tubes below it, crossing it at right angles, and connected to the cylinder by short necks; the lower tubes and half the cylinder to be filled with water, and the flame and smoke to pass alternately over and under the tubes in a waving course. And where very strong steam was required, he had two other smaller cylinders, one on each side, in lines parallel to the large one and above the cross tubes, which are connected alternately to these by short necks; the larger cylinder communicating only with the side cylinders.¹ The immediate object of this arrangement is to introduce the cold water so as not to interrupt the rising of the steam, which is the fault of both the first arrangement and also of Count Rumford's.

Another mode of application adopted by Mr. Woolf consists in placing the tubes longitudinally, as the larger cylinder, parallel to each other, but in a gently sloping direction: the upper ends of the tubes all open into the large cylinder near to its end. The tubes are about ten inches in diameter, and extend the whole length of the fire-place, which is formed below them; and the fire acts directly on the lower surfaces of the tubes, and the flame and smoke on the lower side of the principal cylinder. This plan seems to be the latest he has contrived, and a wonderful stock of ingenuity has been exhausted to very little purpose.

234. But there is another form given by Woolf to the boiler, which is too ingenious to be passed without notice: it consists in forming an upper and a lower boiler, and connecting them by short tubes. For a low pressure boiler the arrangement gives much surface, but would be more troublesome to execute than the

* Philosophical Magazine, vol. xvii. p. 40.

common boiler, with scarcely any sensible advantage, or at most not more than is gained by making a flue through the boiler.

235. The reasons for avoiding the complicated forms of the tubular boilers of Rumford and Woolf require very little illustration. We are certain that if a boiler has the proper quantity of surface and capacity, it will be effective; and that all that can be done in this respect by a tubular boiler is to obtain these proportions perhaps in a less space: but if a more simple form be afforded, it certainly claims our preference. As to safety there can be no difference, unless the capacity of the cylinder be reduced to less than would contain the proper store of steam: for it is to be recollected that the stress on the larger cylinder is unalterable by either the disposition or the size of the small tubes; and half the capacity of this cylinder must be capable of holding the store of steam.

Another objection to these boilers is the necessity of using cast iron; but of the defect of this material for boilers it will be necessary to treat further in giving the rules for the strength of them.

236. We have now to consider boilers which have the fire within them. They have been long a favourite species with speculative mechanics, and particularly since the high pressure steam engine was brought into use by Trevithick. It seems a most compact and convenient mode of applying heat, and if we could for a moment forget the current of heat blown up the chimney, one might with some people imagine that the whole of the fire-place being within the boiler it must give out its heat to it alone: such an opinion is however absurd.

It is also urged that it is safe, because the part exposed to the heat of the fire being within the boiler, when it is destroyed the steam will burst inwardly; and this is freely admitted to be true, only it imposes the necessity of having a larger boiler, which of course is more dangerous.

237. The proportions of these boilers will be found to depend on the following circumstances. That part of the area of the tube appropriated to supply air to the ash-pit must be of sufficient size for the purpose; which determines the diameter of the tube. The area of the grating must be considered, (see art. 198.) and then the length of the tube must be at least sufficient to make its superficial contents equal to the surface required for the fire. (See art. 204.) The capacity of the boiler must next be adjusted, so that deducting the space occupied by the tube containing the fire, the quantity remaining will contain the necessary store of water and steam. (See art. 215.)

238. If the nature of the application admit of a supply boiler being added, to receive and heat the water required to replace that boiled off, then the internal flue should have only the quantity of fire surface, and the smoke should be returned

under the supply boiler, as Oliver Evans proposed. When a supply boiler cannot be used, somewhat more than one-fourth of the effect of the fuel will be lost by the smoke escaping at such an elevated temperature.

239. The construction of boilers for steam boats must be such as will render them secure against danger from the fire, and also with as little of either bulk or weight of materials as possible. When they are low pressure boilers, and I would strongly recommend that no other should be used at sea, the force of the steam does not prevent the use of plane surfaces, to bound the flues and fire. The object then is to arrange the fire-place and flues within the boiler, so as to afford the proper quantities of fire, and flue surface, and of capacity, and admit of being cleaned with facility.

Various methods are adopted, but I have observed that the common tendency of a few years' practice is to simplify both the construction and the means of obtaining effect.

240. The boiler is sometimes made so as to admit a clear passage of about eighteen inches between the timbers and the boiler; but this excellent practice is by no means so general as it ought to be; for it not only gives a great degree of security against accident by fire, but also renders the examination and repair of the boiler easy and satisfactory.

241. The grate should not be less than about 2 feet from the floor, and the sum of the areas of the flues of the fires should be somewhat larger than the area of the chimney, or simply larger than the chimney when there is no more than one fire. It will be an advantage to have as many separate fire-places as is convenient, for several reasons. First, The fire is easier to manage, and a less interruption to the generation of steam is caused by feeding it. Secondly, The flue and fire surface are obtained in less space, because two flues have more surface than one capable of conveying the same quantity of smoke. It is, however, scarcely possible to point out the limits which should determine the choice in different cases, as first expense is too often avoided, under the impression that it is more than equivalent to an unknown loss, which will become as regular as it is certain.

242. A flue in about the proportion of 12 inches wide, and 18 or 24 inches high, with one of its ends easily accessible, is a good proportion; height rendering the flue more effective than width, in consequence of the hottest part of the smoke pressing against the upper part of the flue, while the bottom gets speedily covered with a coat of sooty matter, which being a bad conductor of heat, the bottom surface has very little effect. Hence, in estimating the quantity of surface, the bottom of the flue should not be calculated.

243. The fire-place is necessarily surrounded by water, but there is no advantage in this; for water is so rapid a conductor of heat, that it absorbs it too fast

from the fuel which is in combustion, whereas nothing can be more injurious to the perfectness of that process than a rapid abstraction of heat. The sides of the fire ought to be lined with fire bricks as far as the burning fuel extends; and the saving arising from the more perfect combustion of the fuel, and in the duration of the boiler, would more than balance the inconvenience of the construction.

A boiler for a steam boat constructed in this manner is shown in Plate xvii. Fig. 1, 2, and 3. It differs in some respects from the usual forms, but not in any essential points: the great object is to obtain a sufficient quantity of fire surface, and facility of clearing the flues is of considerable importance.

244. *Portable high pressure Boilers.* Boilers for steam carriages, and other purposes where a permanent seat of brickwork cannot be applied, should be arranged in the same manner as those for steam boats, with the exception of the forms being adapted to resist the effect of the steam.

Both the boiler and the flues within it should be cylindrical. The difficulty of the case consists in obtaining even the due proportion of fire surface, without rendering the boiler too large in diameter. Hence, the only thing that seems capable of being done to improve the present construction, is to make the boilers much longer with less diameter; to have the boiler filled with water, and the fire tube larger, with the spaces for steam formed by short vertical cylinders round the steam cylinders.

OF FIRE-PLACES.

245. Various methods have been tried for improving the construction and the mode of supplying the fuel to the fire-places of steam boilers. Smeaton improved them so far that there has been little more useful effect obtained since, than was done by some of his boilers. The later researches on combustion induced Mr. Watt to add a few further improvements, but experience taught him that what might be done by scrupulous attention and just principles was not to be expected in ordinary practice.

246. *Watt's Fire-place.* In improving the furnace, Mr. Watt proceeded nearly on the principles of Argand's lamp. The grate and dead plates were laid in a sloping direction downwards from the fire door, at an angle of about 25° to the horizon; the fire being lighted in the usual manner, and a small quantity of air admitted through one or two openings in the fire door, so as to blow directly on the blazing part of the fire. The fire at first was kept near the dead plate, and the fresh coals with which it was supplied were laid upon that plate close to the burning fuel, but not upon it. When it needed mending, the burning coals and those upon the dead plate were pushed further down without being mixed, and more coals were laid upon the dead plate, but never thrown on the top of those

already on fire, as that would instantly send out a volume of smoke. In this situation they were gradually dried, and the smoke which issued from them consumed by the current of air from the fire door, in passing over the bright burning fuel. The opening or openings, to admit the air, are regulated so as just to admit the quantity which consumes the smoke; more would be prejudicial. He at first constructed these furnaces in a rather different manner; but found the above method the most convenient, and, *when properly attended to*, answers the purpose perfectly with free burning coals, but is more difficult to manage with coal which cakes.

247. *Roberton's Furnace.* Various methods of construction have been contrived to accomplish the objects proposed by Mr. Watt: that of Messrs. Roberton is perhaps on the whole the best. The opening through which the fuel is introduced into the furnace is shaped somewhat like a hopper, and is made of cast iron, built into the brickwork, inclining from the mouth downward to the place where the fire rests on the grate. The coals in this mouth-piece or hopper answer the purpose of a door, and those that are lowest are by this means brought into a state of ignition before they are forced into the furnace. Below the lower plate of the hopper the furnace is provided with upright front bars, which serve to admit air among the fuel, and to admit an implement to force the fuel back, from time to time, to make room for fresh quantities to fall into the furnace from the hopper. By this arrangement the fuel is brought into a state of ignition before it reaches the further end of the bottom grate, where it is stopped by the rising breast of the brickwork, so that any smoke liberated from the raw coals at the front must pass over these red hot coals before it can reach the flue.

Below the upper side of the mouth-piece or hopper, and about the distance of three-fourths of an inch from it, is introduced a cast iron plate. This plate is above the fuel, and the space between it and the top of the hopper is open to admit a very thin stream of air, which, rushing down the opening, comes first in contact with that part of the fire which is giving off the greatest quantity of smoke, mixes with it before it passes over the hot fuel in the interior, and therefore in passing it inflames and escapes undecomposed. This is the worst part of the apparatus; for air so admitted cools the bottom of the boiler.

The quantity of air admitted to pass over the upper surface of the fire is regulated by inserting a wedge-formed piece of iron. The front bars are closed by doors, which, when shut, prevent the heat from coming out, and incommoding the workmen.

248. A considerable improvement was added by Mr. Woolf, to enable them to get rid of clinkers and scoriæ. The contrivance is extremely simple. The combustion of the fuel commences, and is chiefly carried on, on the part of the bottom

grate next the hopper, and the fuel is pushed back from time to time along the grate, and at the end vitrified portions fall into a cavity, the bottom of which is furnished with horizontal slides. These, when drawn out by an iron hook applied to the handle of the slide, discharge the clinkers into the ash-pit. (See Plate II.)

249. The defect of Roberton's method as well as Mr. Watt's consists in admitting a regular current of cold air when it is not regularly wanted, and where it has an injurious effect in cooling the smoke as it rises against the bottom of the boiler. This is greatly remedied by admitting air by means of small side flues, or at the back of the fire, whence having to pass from the ash-pit, through small channels in the hot brickwork, it becomes heated before it issues into the fire-place. But abundance of air will pass the grate if it be properly constructed, and the modification I would recommend is described in Plate II.

Air flues, when used, should have valves to open or close them; and, on the whole, very little good is derived from them unless they be attended to with more care than is usually bestowed on the fire of an engine.

250. *Brunton's Fire-place.* In consequence of the difficulty of supplying a fire equably by hand, so as to sustain the regular demand for steam in a steam engine, it has been attempted to use machinery for that purpose. Several schemes have been tried, but the only one which has succeeded in practice is that invented by Mr. William Brunton.

The method consists in an apparatus for dropping the coals on the grate by small quantities at short intervals of time, (not more than three or four seconds,) and in such a manner that the smoke rising from the fresh fuel must pass over that which is in a further stage of combustion, and consequently be consumed; the uniform supply of air for that purpose being admitted.

The machine is also so contrived that a quantity of coal is put on proportioned to the quantity of work, and the air admitted is regulated in a similar manner.

The advantages of such a method are obvious, and the increase of expense of erection not so considerable as might be expected.

A circular horizontal grate which receives the coals is 5 feet in diameter, and revolves on a vertical axis at the rate of about one revolution per minute. During its revolution the coals fall, from a hopper placed over the boiler, through a vertical narrow rectangular opening, formed through the top of the boiler, of the length and in the direction of the radius of the grate. The quantity discharged at once by the hopper is regulated by the force of the steam in the boiler, and the discharge is made at every fourth or fifth second of time; by this means an uniform fire, regulated by the work it is to perform, is obtained, and with a certainty as absolute as the nature of things will admit. To prevent air being

admitted without passing through the channels which are properly regulated, a thin rim on the under edge of the grate runs in a circular trough filled with sand. These parts, however, will be more clearly understood by a reference to the description of Plate II., where its application to two boilers, which had been previously erected by Boulton and Watt, is shown. The saving of fuel by using this apparatus is stated to be about 25 per cent; and a grate 5 feet in diameter burns 260 pounds (three bushels) of Newcastle coals per hour, and 336 pounds, or three cwt. of Staffordshire coals; that is, 13 pounds for each foot of surface of grate for the former; and 17 pounds each foot for the latter kind. I suppose it requires these quantities also to produce equal effects. The quantity of grate is about two-thirds of that required in the ordinary method.

APPARATUS FOR BOILERS.

251. *Feeding Apparatus.* The use of the feeding apparatus is to supply the boiler with water, in the place of that which is converted into steam. The feed pipe is a vertical pipe passing through the top of the boiler. The lower part of this pipe is turned at the end to prevent steam rising through it; and where it passes through the top of the boiler, it is made steam-tight, and fixed very correctly in a vertical position. The top of the pipe terminates in a small cistern head, which is kept supplied with water by a small pump from the hot water cistern; and at the bottom of the small cistern head there is a conical valve, opening upwards, connected by a chain to a lever, which turns on a centre, with a wire attached to the opposite end. This wire passes through an air-tight stuffing box to a flat stone or piece of metal in the boiler, which is so balanced by a weight, on the opposite end of the lever, as to float on the surface of the water. The stone should be so large, in proportion to the surface of water, as to act sensibly on a very slight depression of the water.

Its action is performed in this manner: when part of the water is evaporated from the boiler, the float descends with the water's surface, and consequently raises the conical valve; now, the small cistern head, being kept constantly full of water by the pipe from the hot water pump, as soon as the valve is raised, water enters the boiler, and when it is filled to the proper level, it raises the float and shuts the valve, till a repetition of the operation becomes necessary. The surplus water raised by the pump runs off by a water pipe from the cistern head.

252. The principal circumstance to be attended to in the construction of this apparatus is to make the height of the water in the cistern sufficient to balance the strength of the steam; for if this height be too small, the water in the boiler

will be forced up the feed pipe by the pressure of the steam, and be driven out at the valve.

For water at 60°, 2.94 feet in height is equivalent to 1 lb. on the circular inch, but the water in the feed pipe will generally be nearly 212°, and then 3 feet is required. Hence, three feet in height for each pound per circular inch is the proper height.

The stone float should obviously be in that part of the boiler where it will be least disturbed by the formation of steam; and the feed pipe should deliver its supplies as far from the point where the steam is principally generated as possible.

253. On account of the force of steam required in high pressure engines, an ordinary feed pipe cannot be applied to supply the boiler, without making it of a very inconvenient height: water is therefore supplied to the boiler by a small forcing pump, worked by a lever connected with one of the reciprocating parts of the engine; and this water, instead of passing immediately into the boiler, should pass through a pipe or receptacle which traverses back and forward in the steam which escapes from the engine, so as to become considerably heated before it enters the boiler, that it may not check the production of steam. A much better method, however, is to make the smoke pass round and heat a small supply boiler, which should have a communication with the proper boiler. The pump in the former case supplies the small boiler.

In supplying a boiler by a pump worked by the engine, the same supply is given at all times, whatever may be the quantity converted into steam and used. Now as the consumption of steam is variable, the quantity injected by the pump must often be in excess. This may be remedied by the use of a float, in land engines. Let A, B, (Fig. 2. Plate 1.) be two connected valves, in the box which receives the water from the pump, the one A opening to the boiler, the other B opening to the waste pipe. If the stem of these valves be connected to the lever of a balanced float, as indicated in the figure, the increase of water in the boiler above its proper level will cause the valves to descend, and close the communication to the boiler, while the waste valve opens and admits the superfluous water to run off by the pipe. In this construction the boiler will receive the supply from the pump regularly at all times, except where it is in excess for the quantity used, and then the float F rises, and shuts the passage of entrance to the boiler, and opens the one to the waste, till the quantity no longer exceeds the consumption. This simple arrangement renders the feed regular, which is of much importance.¹

¹ In the early boilers of Mr. Watt, a whistle was attached: the pipe connected with the whistle descended through an orifice in the top of the boiler to a few inches below the proper level at

254. The same construction applied to the feeding pipe of a low pressure steam engine would be much superior to the common stone float; and I think it would apply, as shown in Plate II. Fig. 2. even to the steam boat; for the oscillation would not prevent either its rise or fall, when an over-supply took place or otherwise; and employing the rise instead of the fall of the water to act on the valve, would be a means of safety as well as of preventing irregular influxes of water to check the steam. (See art. 217.)

255. In a method of admitting water to high pressure boilers invented by Mr. Franklins, the waste water has to raise a loaded valve to escape, and the passage to the boiler is regulated by a balance float placed wholly within the boiler: it is ingenious, but has not the advantage of rendering the supply continuous; it must, as with the ordinary feed pipe, stop till the water has descended so as to raise the valve.

OF REGULATING THE FIRE OF A STEAM BOILER.

256. The force of the steam may be made a means of regulating the fire, either by diminishing the supply of air, or by contracting the chimney by a plate called the damper. As a means of regulation the former ought to be preferred; it being obvious, that a direct diminution of the quantity of oxygen at its entrance to the fire must have both a more immediate and a more beneficial effect than contracting the chimney; the effect of the latter being to increase the temperature and force of the smoke in proportion as the aperture is contracted; and, consequently, the smoke escapes at a higher temperature, carrying off a considerable quantity of heat. The regulation by the damper is the kind generally used; the other method is the same in principle, and only differs in being applied to the ash-pit instead of the flue.

257. *Self-regulating Dampers.* Dampers are frequently under the control of those who have the management of the fire; but in the self-regulating damper the fire is made a means of controlling itself, so as to burn with more or less rapidity as it may be more or less wanted, in the following manner. An iron plate or damper, of sufficient size entirely to close the chimney or flue, slides up

which the water was required to be kept: notice of its evaporation below that point was given by the steam forcing its way through the pipe, and producing a whistling noise, sufficiently loud to call the attention of the engine tender, even if at some distance from his post. Subsequently, the feeding and damper apparatus above described was applied to the Soho Mint engine, about the year 1798; also to Retford cotton mills, near Nottingham, in 1803; and the same arrangement continues to be much in use up to the present time.

and down, vertically, in iron grooves, (see Plate III.) with as little friction as possible. To its upper part is attached a chain, which passes over the two pulleys n and n , through a tube in the bottom of the cistern head of the feed pipe, and down the centre of the feed pipe C, to a hollow or bucket-shaped cast iron weight; the feed pipe being made of larger diameter in this part, when a self-regulating damper is applied to a boiler, to admit the weight without blocking up the pipe so as to prevent the descent of the feeding water. The weight is so adjusted by filling it partly with lead, that it may just overcome the weight and friction of the damper plate, chains, and pulleys, when there is no fire under the boiler; consequently, the damper plate will then be drawn up, and the chimney completely open, at which time the weight will rest on the shoulders or projections at the bottom of the feed pipe; the chain being properly adjusted in length for that purpose. Now as soon as a fire is applied so as to generate steam in the boiler, the steam presses upon the surface of the water, and drives it up to a certain height in the feed pipe; and the weight, by becoming immersed in water, has part of its gravitating force balanced, and therefore becomes no longer able to retain the damper plate at its former height; it will consequently descend till equilibrium takes place, and partly closes the chimney, by which the draught of the fire will be checked. Should it move so as to check it too much, less steam will be formed, and the water will rise to a less height in the feed pipe, and part of the force of the weight will be restored so as to raise the damper again: should the fire ever become so fierce as to drive the water up into the cistern head, the weight should be so far raised as nearly to shut the chimney; when a damper shuts perfectly close, there is a risk of inflammable air collecting and exploding in the flues.

A hand damper is, however, an appendage which a boiler should always have, for when an engine is not in action, it will be useful partially to close it; and no boiler can be considered perfect which has not both a damper and the means of entirely closing the aperture by which the air enters to supply the fire.

258. *Self-acting Air Regulator.* The most direct method of governing the action of a fire is to provide the passages which admit air with the means of opening or closing them at pleasure; and it is a still further advantage when this is done by means of the force of the steam, so that as the steam increases beyond its proper strength, it closes the aperture which admits air to the fire. A method of constructing a self-acting regulator of this kind is shown in Plate I. It is essential in applying it to make all other entrances to the burning fuel to shut as perfectly close as possible.

SAFETY VALVES.

259. The precautions for safety are of much importance : the boilers of steam engines should never be constructed without them, and they should be done with every care to render them effective in preventing accidents.¹

Safety valves are called external or internal, according to the nature of the evil to be prevented. An *internal safety valve* is to prevent the pressure of the atmosphere crushing in the sides of the boilers or pipes to which it is applied. It is usually an inverted conical valve, retained in its seat by a rod connected to a lever, having a weight at its opposite end, such that the force of the atmospheric pressure will overcome it, when its pressure is three or four pounds on the circular inch greater than the elastic force of the steam in the boiler.

In Plate 1. Fig. 1. this valve is shown as inserted in the man-hole plate ; *a* being the valve kept in its seat by the weight on the lever at *b*.

260. The *external safety valve* is to prevent the risk of explosion, should the steam become stronger than that which the boiler is intended to confine ; therefore it is of the greatest importance that it be properly constructed and not liable to derangement.

The application of a loaded valve to limit the force of steam appears to have been first made by Papin to his digesters ; and it was applied by Savery to the boilers of his steam engines. It consisted of a conical valve retained in its seat by a weight on a lever ; and, from its resemblance to a steelyard, was called the steelyard safety valve. It is still much used, but it has the obvious defect that the weight may be increased at the will of the workman, or even may be done through the ignorance of a stranger ; hence valves of this form should not be employed unless the lever and valve be wholly inclosed in a box kept locked by the proprietor. Such a box should have a pipe leading into the chimney, to carry off the steam, and a slight wire or chain to lift the valve by, lest it should stick fast by corrosion.

261. For low pressure steam, the form is rendered more convenient. The conical valve has its load directly upon it, and it ought to be sufficiently large. Its clear area in the narrowest part not being less than is calculated by the annexed rule, and the power of the steam having been determined, a fixed and unalterable weight agreeing with that power should be formed and attached to the rod on the top of the valve ; and the whole should be inclosed in a metal box, having a passage larger than the area of the valve, to convey the steam away to the chimney or other place.

¹ See description of safety valve applied to Boulton and Watt's Marine Engine, Plate XXI.

The greatest power of steam should be a little more than is required to work the engine ; suppose it be 5 lbs. on the circular inch, and the diameter of the lowest part of the seat of the safety valve should be 3 ; then 3 times 3 = 9, the area of the valve in circular inches, and 9 times 5 = 45 lbs., which is the required weight for the load to be placed upon the valve. This valve will not open till the steam presses it with greater force than 5 lbs. on the circular inch. The metal box for the valve being locked up, of course no one but the possessor of the key could alter the load on the valve ; but a handle passing through the cover is necessary to move it, to prevent it rusting fast.

For further security it has been proposed that another safety valve should be placed upon the same boiler, but with rather less load upon it, in order that it may open first, and give notice to the engine man when the steam is likely to become too strong. This should have a stronger handle for moving it, either for letting off the steam when not required, or other purpose ; but the handle to raise the locked valve should be either connected by a chain or slight wire, so that it could not be fixed so as to increase the load on the valve. It would be better to rely on the common valve, than one locked up till it had become stuck fast with rust.

262. A conical seated valve does not appear to me to be the best ; for the locked valve I would prefer a flat seat, and that the metallic surfaces in contact should be narrow, and of metal not liable to corrosion, nor to fix by unequal expansion.

263. To prevent the danger of adhering in steam boat boilers, Mr. Nimmo¹ proposed that the valve should be a hemisphere with its convex surface downwards, to rest in a seat formed to fit it, and the weight he proposed to hang to the lowest part of the valve. See U, Plate xvii. Fig. 1. By this means the motion of the boat would be constantly changing the position of the valve, while its form would render it steam-tight in all positions, without danger of adherence. A chain might be also attached to the upper side of the valve, to lift it without opening the case inclosing it. This method deserves attention : its defect would most likely be want of stability in its seat.

264. The most certain and safe method for low pressure boilers, is to balance the pressure of the steam by a column of water, of a diameter adequate to allow of the escape of the steam as rapidly as it would be possible for the fire to generate it. A feed pipe is to a certain degree a safety tube of this kind, but neither of the size nor construction which safety requires. The tube or pipe T W should be made recurved at the lower end T, Plate II. Fig. 2. its mouth being not lower

¹ Report on Steam Boats ; or, Partington's Historical Account of the Steam Engine, p. 92.

than level with the upper edge of the fire flues. At the upper end it should be provided with a pipe U, to convey down the hot water without the danger of scalding any one, and the upper part should terminate in a higher pipe V, to convey away the steam. The action of this safety tube is, first to lower the water in the boiler to bring the feeding pipe into action, if it be not so before, and then to allow the escape of the steam. I have had two boilers done in this manner; and the effect of endeavouring to render the steam stronger than it ought to be is completely counteracted, and the boiler restored again to its regular pressure in a few minutes after the tube has discharged its column of water. The discharge of a portion of hot water by the tube, and the admission of colder by the feed pipe, tends to lower the steam; but by the feed pipe alone this does not happen, as the hot water then rises in the feed pipe and prevents the entrance of cold. Another advantage of this construction is, that should the water fall below the mouth of the tube, the steam would escape, and if the noise of its escape did not warn the engineer of the state of the boiler, the want of steam would soon be a motive to look after it.

The height of the tube for different pressures is easily calculated, for the height of a column of water equivalent to 1 lb. on the circular inch is, for ordinary temperatures, 3.1 feet; hence for a pressure of 4 lbs. on the circular inch, $4 \times 3.1 = 12.4$ feet, the height for the tube, that is, equal to a little more than 5 lbs. per square inch. It is obvious that it is adapted only for low pressure steam.

265. Other modes have been proposed for constructing valves, some of which are deficient in principle, others are complex in construction and operation. The solid piston valve proposed by Chevalier Edelcrantz would either stick fast with high pressure steam or allow a constant escape; and to this difficulty is added the nicety of fitting a solid piston so as to be and remain steam-tight. If an elastic metallic piston be used instead of a solid one, the expense of construction becomes considerable; and a common packed piston is not to be depended on for the purpose, its friction is so irregular.

266. For high pressure boilers, more careful attention to the means of security are necessary than for low pressure ones, as it is easy to show that the risk is much greater; indeed some most dreadful accidents have had the effect of rendering people more cautious respecting them. Several methods have been used to guard against these accidents by Trevithick, who first brought the high pressure engine into use. He proposed that the safety valve should be inclosed in an iron case and locked, so that no person could get access to it to increase the load beyond what was intended to be employed: he also had a hole drilled in the boiler, which he plugged up with lead, at such a height from the bottom that the boiler

could never boil dry without exposing the lead to be melted, and consequently making an opening for the steam to escape. This contrivance he expected to prevent the boiler being burst, by suddenly forcing water into it when it had been allowed through inattention to boil dry and become red hot.

267. A plug of fusible metal riveted into a hole in the bottom of a boiler, so that it may melt and allow the water and steam to escape into the fire, whenever the contents of the boiler attain that degree of heat which produces steam of a dangerous elasticity, is a method of a like nature.

268. The mercurial steam gauge is generally applied to boilers to show the state of the steam; it is a curved tube, or inverted siphon, in which the mercury rises by the force of the steam, and indicates the pressure. See Section VIII. When this steam gauge is applied to a high pressure boiler, it requires a tube of considerable length, and is an additional security against the bursting of the boiler, because when the steam is too strong, the mercury will be displaced into a proper receiver, and the steam escape through the tube, when the pressure exceeds that which the boiler is designed to sustain. This steam gauge is a most desirable appendage to a high pressure boiler, because it shows at once the state of the steam; but as a means of safety we had better inquire how far either it or metallic plugs are likely to be effective, lest, under an impression of being secure, the reliance may involve us in more of these fatal accidents.

269. In the first place, it is obvious that the aperture or apertures by which the steam is to escape, should be so large that it may escape as fast as the fire can generate it; if it does not, it must accumulate, and eventually explode. Now it is possible to convert a cubic foot of water into steam from somewhat less than 1·5 feet of fire surface, (see art. 200.) and it is making only a small allowance for security to admit that each foot of surface may convert a cubic foot of water into steam.

Hence we derive the following RULE:—Let the density of the steam corresponding to the pressure be found: then multiply 7·5 times this density, by the square root of the quantity the density is greater than 1, and divide the feet of fire surface by the product; this quotient is the square of the diameter of the narrowest part of the valve in inches. Or, divide the area of the fire surface by the number corresponding to the pressure or temperature, under the head divisor in the following table; and the quotient will be the square of the diameter of the valve, in the narrowest part, in inches.

Pressure in inches of mercury.	Temperature.	Density of steam.	Divisor.
30	212	1.00	0
35	225	1.28	5
60	250	2.00	15
90	275	2.85	29
120	293	3.70	45
150	308	4.70	60

The rule, it is to be remarked, is for the smallest aperture that ought to be used, but there is much reason either to use two valves, or to double the area determined by the rule.

Example I. Required the area of a safety valve for a low pressure boiler, fifteen feet long by 4 feet wide, the fire surface being considered equal to the area of the bottom of the boiler. In this case $15 \times 4 = 60$, and the divisor is 5 for low pressure steam; hence,

$$\frac{60}{5} = 12, \text{ the square of the diameter of the aperture;}$$

and the square root is $3\frac{1}{2}$ inches nearly, for the diameter. And either two valves of this diameter, or one of about 5 inches diameter, ought to be used.

Example II. A high pressure boiler with 60 feet of fire surface is used for generating steam of four times the atmospheric pressure, what should be the least diameter of the safety valve aperture?

In this case the divisor is 45, and

$$\frac{60}{45} = 1.34 = \text{the square of the diameter,}$$

and the square root is 1.16.

270. Hence we find that the diameter of a mercurial gauge capable of giving passage to the steam, is not so large as to prevent it being applied in practice and with success, as a means of rendering boilers safe. A safety valve in addition should of course be used, as the bends in the pipe would in some degree retard the escape of the steam.

271. The use of fusible metal plugs I do not think so likely to afford security, for were the plug fusible at the pressure for which the boiler was adapted, it would be so softened by the continued temperature of the working state, as to be incapable of retaining the steam when made of sufficient power to be useful. Lead would be wholly unfit, its melting point being at 612° , a temperature at which the force of the steam would be about 150 atmospheres. Tin melts at 442° , and at this temperature the force is upwards of 25 atmospheres. Alloys may be formed to melt from 212 to 600° , but we have no evidence that the melting points remain

permanent in alloys which are regularly exposed to a heat so nearly approaching to that at which they fuse when newly formed.

Alloys and Metals.	Melting point.
An alloy of lead 1 part, tin 3 parts, bismuth 5 parts, melts at	212°.
Lead 1 — tin 4 — bismuth 5 —————	246
Tin 1 — bismuth 1 —————	286
Tin 2 — bismuth 1 —————	336
Lead 2 — tin 3 —————	334
Tin 8 — bismuth 1 —————	392
Tin	442
Bismuth	472
Lead	612
Zinc	648

But if a range of about two atmospheres above the working pressure be necessary to fuse the plug, and with a less range than that it is scarcely probable it would withstand the working pressure, this mode of obtaining safety ought not to be relied upon in practice. As an additional precaution the fusible plug may be adopted, but not as a principal one, certainly not as one in which great dependence may be placed.

272. It has also been proposed to add a pipe to some part of the boiler, of such thin metal that it may burst rather than the boiler; but this plan, like that of the metallic plugs, can only be useful in cases where the ordinary safety valves do not act, for if it be made at first so that it would break on a small increase above the working pressure, it would be constantly failing at that pressure, it being well known that a metal strained to near its ultimate force will gradually break. Besides, it is exceedingly difficult to determine the strain such a pipe will bear without fracture, within the limits that would render it safe to depend on where life is at hazard.

273. The risk on high pressure boilers, even at their working pressure, becomes considerable in proportion as that pressure is high, and therefore too much caution cannot be employed about them. At least one good safety valve, and a mercurial gauge of sufficient diameter to allow the escape of the steam, should be applied to each; but it is the practice of careful engineers to apply two safety valves.

On the common safety valve an improvement might be made by constructing it so as to be relieved of part of the load on the valve as it rises.

THE AREA OF CHIMNEYS FOR STEAM ENGINE BOILERS.

274. Previous to giving particular rules for the area of chimneys, it may be useful to remark, that a chimney may afterwards be convenient, if considerably larger than is necessary for the use of the engine it is erected for, while the expense bears a small ratio to the increase of size. Hence I would recommend that one double the size of that given by the rule should be built, for the rules apply only to one for the actual power of the engine.

The height should not be less than about 50 feet, and should be higher if it be desirable to avoid the nuisance of smoke in the immediate neighbourhood of the chimney; for though by increasing the height of the chimney there is no diminution of smoke, yet it is spread so as to fall over a large surface.¹

275. RULE. The area of a chimney for a low pressure steam engine, when above 10 horse power, should be 112 times the horse power of the engine, divided by the square root of the height of the chimney.

For less than 10 horse power, it should be 90 multiplied by the number opposite the horse power in the first column of the table, (art. 221.) instead of 112.

Example. Required the area of a chimney for an engine of 40 horse power, the height of it being 70 feet.

In this case

$$\frac{40 \times 112}{\sqrt{70}} = \frac{4480}{8.4} = 533.2 \text{ square inches.}$$

The square root of this is 23 inches, which will be the side of a square chimney. Or multiply 533 by 1.27 and extract the square root for the diameter of a circular one.

But in either case I would advise to build a chimney of double the area, or 1066.4 area, that is, to make the side of the square 33 inches.

In this rule it is supposed that the engine is done in the best manner, and worked with the best coals, that is, one requiring only from 9 lbs. to 11 lbs.

¹ It is a curious circumstance, that when high pressure steam and smoke ascend in the same chimney, the smoke becomes nearly invisible. It seems to have been first observed in Trevithick's engine, when applied to a steam carriage in 1805; and was communicated to Nicholson's Journal (vol. xii. p. 1.) by Mr. Gilbert, who offers no explanation, but states that the admission of the steam into the chimney improved the draught. Nicholson made an experiment which accounts for the vapour becoming invisible, through the heat of the smoke preventing that degree of condensation which is essential to its being seen. (Journal, vol. xii. p. 47.) The disappearance of the smoke is not accounted for; but I think it seems to be deposited in consequence of the density being diminished by intermixture with steam, till it becomes incapable of suspending the particles of sooty matter.

of coal per hour, for each horse power, of an engine above 10 horse power. But where 14 or 16 lbs. of coal per hour is necessary, the flue should be increased in direct proportion to the quantities to be consumed. See the mode of finding the rule in art. 168.

276. When wood is used for fuel, it affords a much larger quantity of smoke, but it is also much lighter, and about one and a half times the area necessary for coals will be sufficient.

277. The same rules may be applied to high pressure engines; taking the cubic feet of water per hour, or the one-eleventh part of the pounds of coal per hour, instead of the number of horse power.

278. The engine chimneys for steam boats and steam carriages are circular, and should not be larger than is absolutely required to give effect to the fuel. This will be about obtained when the square of the diameter is equal to 90 multiplied by the horse power, and divided by the square root of the height in feet.

But here it must be remarked, that where a chimney is less than about 40 or 50 feet in height, the smoke must be allowed to rise at a much higher temperature. It must not therefore be allowed to cool too much by giving its heat to the boiler, otherwise there will be a want of draught. Hence in low chimneys the fuel will not produce its full effect.

Different modes of finishing chimney tops are shown in Plate I. The least expensive is one of the form of an Egyptian obelisk, and it offers least obstruction to the wind.

OF THE CONDENSATION OF STEAM.

279. When any substance or body colder than steam itself is put in contact with it, the steam condenses till the temperature of the cold body becomes the same as that of the steam, or till the whole mass of steam be condensed to a degree of elasticity corresponding to the temperature to which the cold body is raised by the heat of the steam. The greater the quantity of the cold body, the less its temperature will be raised; and also the colder it is, the more the elastic force will be reduced. Hence, to reduce the elastic force of steam as low as possible, the coldness and the quantity of the cooling body should be as great as possible.

280. Any cold body condenses steam; but that it may be effectively done, the body should be capable of presenting a large quantity of surface, and be a good conductor of heat; as when power is to be obtained by condensation, the more rapid the condensation is, the more power is obtained. It may be easily proved that if steam were so condensed as to lose only equal degrees of elastic force in equal times during the action, half the power would be lost.—(See art. 294.)

This is the cause of the failure of every method of slow condensation. It cannot be too prompt, unless a sacrifice of power is made in some other way to gain that promptness, and to which the effect gained by condensation is not equivalent.

281. Water has been found the most effective cold body for condensation; it has great specific heat, perhaps greater than any other body; it is a rapid conductor of heat, and in a jet applies an immense proportion of cooling surface to the steam.

Now since water is frequently difficult to be procured of a low temperature, and sometimes not in sufficient quantity, it becomes important to inquire what effect is produced by given proportions at given temperatures.

282. The weight of the water, W , required for condensation, multiplied by the quantity $x - t$ its temperature is raised, gives the heat it absorbs; and in the steam engine, where the operation is repeated in the same vessels and at the same temperatures, the excess of the temperature $T - x$ of the steam above that to which the condensing water is raised, added to 1000, and the sum multiplied by the weight w of the steam, must be equal to the heat absorbed by the condensing water. That is

$$W(x - t) = w(1000 + T - x)^1$$

$$\text{or, } W = \frac{w(1000 + T - x)}{x - t}, \text{ and } x = \frac{w(1000 + T) + Wt}{W + w}.$$

283. When the temperature of the condensed water is equal to the temperature of the steam, the quantity of water would be equal to that which simply reduces the steam to water without change of temperature; or

$$W = \frac{1000 w}{T - t}$$

But in this case no effect would be obtained. Any greater quantity of cold water reduces the elastic force, but it must be so far reduced as to render the accession of power more than equivalent to that required to work an air pump, and cover the expense of a supply of water, and the extra cost of the engine.

284. In low pressure steam $T = 220^\circ$, and t may be taken at 52° the mean temperature, and if the temperature of the condenser be 100° , then

$$W = \frac{w(1000 + T - x)}{x - t} = \frac{w(1000 + 220 - 100)}{100 - 52} = 23\frac{1}{2} w.$$

That is, $23\frac{1}{2}$ times the quantity of the water required for steam, will be the

¹ To make this equation general, let s be the specific heat of the condensing body, and C the heat of conversion, and s' the specific heat of the body in vapour, then $W s (x - t) = w s' (C + T - x)$.

quantity of water necessary for condensation. And since a cubic inch of water produces about a cubic foot of steam of the rarity it is in the cylinder of an engine working at this temperature, and one-tenth being added for each foot of the capacity of the stroke, $23\frac{1}{2} \times 1.1 = 25\frac{3}{8}$ cubic inches for each foot of the contents of the stroke of the cylinder.¹

If $x = 130^\circ$, it requires of cold water only 14 times the weight of the steam to condense it, and for 120° it requires 16.2 times the weight.²

The force of steam at 100° is 2.08 inches of mercury, its force at 130° is 4.81 inches; consequently the gain of power is 2.73 inches, or about one in thirteen, by condensing at the lower temperature.

If the temperature of the cold water be 70° , and of the condenser 130° , then we find cold water 18 times the weight of the steam will condense it; and that it requires 37 times the weight to condense at 100° , when the cold water is at 70° .

285. From these equations the comparative effects of different temperatures may be calculated, and the economy of using or sparing water will be known and acted upon, instead of the usual method of endeavouring to get the greatest power of the steam in places where water is expensive.

When steam is of considerable density, it does not condense freely; the reason is obvious, the same surface of injection water acting on steam of greater density, and consequently containing a greater proportion of heat, it abstracts the heat more slowly. To avoid this, the condenser should be so large that the steam may expand to the bulk corresponding to a pressure not greater than about one atmosphere and a half. But it is better to make the steam act expansively in the cylinder by Watt's method, (art. 27.) or expand in a second cylinder by Hornblower's method, (art. 32.)

When a lower temperature than 180° cannot be obtained by condensation, it is not worth the extra expense, and at 180° we have for low pressure steam

$$W = \frac{w(1000 + 220 - 180)}{180 - 52} = 8w \text{ nearly;}$$

or eight times the quantity of water required for steam will be necessary to condense it.

286. These computations apply to where condensation is made in a separate vessel, the first idea of which we owe to Mr. Watt. When the condensation is made within the cylinder, the metal of the cylinder has to be cooled down to the temperature of condensation as well as the steam, and a large proportion of the

¹ Mr. Watt says a wine pint, or $28\frac{7}{8}$ inches, is "amply sufficient."—Robison's Mech. Phil. vol. ii. p. 147.

² The usual temperature is about 120° , or just what the hand can bear.

steam is lost in heating it again at each stroke. The means of obtaining a maximum of useful effect from condensing in that manner has been shown, (art. 165.)

287. To find the quantity of water for injection into an engine condensing in the cylinder, the formula is the same as when a separate condenser is used, the difference being in the quantity of steam required; and the water for condensation is greater than when Watt's condenser is employed by

$$\frac{.14 i (T - x)}{x - t} \text{ for each stroke,}$$

i being the weight of the mass of iron contained in the cylinder.

288. The following tabular view of the modes of condensation may perhaps present the subject to the reader in a clearer view than any other kind of concluding summary.

Steam may be condensed	$\left\{ \begin{array}{l} 1. \text{ in the vessel where its power is exerted} \\ 2. \text{ in a separate vessel} \end{array} \right.$	$\left\{ \begin{array}{l} \text{Savery in 1698.} \\ \text{Newcomen in 1705.} \\ \text{Watt in 1769.} \end{array} \right.$
Steam may be condensed	$\left\{ \begin{array}{l} 1. \text{ by projecting a cold fluid against the vessel containing it} \\ 2. \text{ by injecting a cold fluid among it} \\ 3. \text{ by exposing it to large surfaces of cold fluids or solids} \\ 4. \text{ by the pressure of cold fluids against the vessels containing it} \\ 5. \text{ by the union of two or more of these methods.} \end{array} \right.$	$\left\{ \begin{array}{l} \text{Savery.} \\ \text{Newcomen.} \\ \text{Watt.} \\ \text{Cartwright.} \\ \text{Perkins.} \end{array} \right.$

SECTION IV.

OF THE MECHANICAL POWER OF STEAM, AND THE NATURE, GENERAL PROPORTIONS, AND CLASSIFICATION OF STEAM ENGINES.

289. The force of steam when confined, according to its density and temperature, and the circumstances which affect its motion, having been considered, our next object is to investigate the power of steam to produce useful effect, and in this purpose I am desirous of proceeding with the simplicity and fulness this important subject requires.

OF THE POWER OF STEAM, AND THE MODES OF OBTAINING IT.

290. The generation or production of steam, it has been shown, takes place on the application of heat. Conceive a cylindric vessel, A B, to be placed in a vertical position, with a given depth of water in it; and an air-tight piston on the water balanced by a weight equal to its own weight and friction. In this state let heat be applied to the base, A C, then as the water becomes converted into steam, of slightly greater force than the atmospheric pressure, the piston will rise till the whole of the water be in the state of steam. It will be remarked, that the generation of this steam of *atmospheric elastic force* affords no power, the motion being barely produced; it has simply balanced the column of atmospheric air, and excluded it from a given height of the cylinder.

291. *By Condensation.* But in this state of things if the steam be suddenly condensed into water again, it is obvious that the piston will be impelled by a force

FIG. 15.

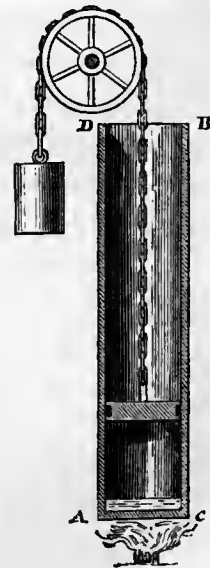

equal to the pressure of the atmosphere on the piston, and through a height equal to that the piston had been raised by the generation of the steam.

292. It thus appears that the power of steam of the elastic force of the atmosphere is, when speedily condensed, directly as the space it occupies. That is, multiply the area of the cylinder in inches by the pressure of the atmosphere in pounds on an inch of area, and by the height in feet; and the result, deducting the friction, will be the quantity in pounds the steam would raise one foot in height.

293. The space occupied by steam of atmospheric elastic force may be increased by raising its temperature above 212° , the increase being equal to the expansion of steam by the given change of temperature; but a quantity of heat nearly equivalent to the increase of volume will be absorbed, and hence the effect of a given quantity of fuel would not be increased by the expedient.

294. If the steam be slowly condensed, as it would be by applying external cold, the effect would be much reduced, because the moving force at any period of the stroke would be only the difference between the elastic force of the steam and the atmospheric pressure; and the most rapid condensation leaves a vapour of some elastic force: but as it acts through the same space as the power of the steam, it does not cause a sensible deviation from the ratio of the power, being as the space the steam occupies, when the power is gained by rapid condensation.

295. *By Generation.* Conceive the same cylinder and apparatus to have heat applied to its base, with only the difference of the piston being loaded with a given pressure per inch of its area. The generation of the steam will raise the loaded piston, but the height through which it will be raised will be less. The steam being acting in opposition both to the pressure of the atmosphere and the load on the piston, the space it will occupy will be in the inverse ratio of the pressures which oppose it in the two cases, supposing the steam of atmospheric elastic force to have been of the same temperature. Thus, if the load on the piston be twice the atmospheric pressure, the piston will be raised only one-third of the height; but on rapid condensation it descends with three times the pressure, and, therefore, whether the steam be generated of atmospheric elastic force, or of a greater force, the power it affords by generation and condensation is the same at the same temperature, and this power is directly as the elastic force of the steam, multiplied by the space it occupies, when the motion of the piston is rectilinear.

296. But if, as in the last case, a loaded piston be raised, and then a valve be opened which allows the steam to escape, the whole power gained will be equal only to the weight raised descending from the height to which it was raised; and

the power which would have resulted from condensation will be lost, and the loss is equal to the pressure of the atmosphere acting through the height to which the piston was raised by the steam. This is the nature of the common *high pressure* steam engine. It is obvious, that the greater the elastic force of the steam, the less is the loss by neglecting to condense it under these circumstances; but it may be remarked, that unless the valve aperture be equal to the diameter of the cylinder, the steam cannot escape at the necessary rate without part of the load acting to expel it; and so much more of the effective force will of course be lost. The effective power is as the space the steam occupies, multiplied by the excess of elastic force above the atmospheric pressure.

297. *By Expansion.* Retaining the same loaded piston, let it be raised by the conversion of a given quantity of water into steam, to the height which corresponds to the load and temperature; then if the load on the piston be wholly removed at that height, the steam will raise the piston by expanding till it becomes nearly of the same elastic force as the atmosphere, and its condensation will produce the same effect as if the steam had been generated of atmospheric elastic force at first; consequently, the effect in raising the load on the piston is wholly additional, and the joint effect of a high pressure and condensing engine is produced by the same steam. The effective power of steam applied in this manner is equal to the space it occupied, as high pressure steam, multiplied by the excess of its elastic force above the atmospheric pressure, added to the amount arising from multiplying the space it occupies when of atmospheric elastic force by the atmospheric pressure. Hence, by this combination of effect the power of steam of high elastic force will be nearly doubled.

298. This is not, however, the mode by which steam can be applied with the greatest advantage; for, instead of removing the load on the piston wholly at the height to which it was raised by the generation of the high pressure steam, a part of it may be removed, and then the steam would expand to a height depending on the portion of the load removed; at that height remove a second portion, and so on, successively, till the steam becomes of atmospheric elastic force. In this case, as far as the load was raised in parts by the expansion of the steam, the effect is greater than in the preceding combination: the mode of calculating it will be afterwards shown, but the principle is that of the expansion steam engines.

299. The preceding is not the only mode of deriving advantage from expansion; indeed it is only a late discovery, and most probably belongs to Woolf as far as he was capable of appreciating it. The methods of Hornblower and Watt only apply to the case now to be considered. Let the piston be raised unloaded, as in the first case, by the conversion of a certain quantity of water into steam of atmospheric elastic force. When the piston is at that height, add a weight equal

to half the atmospheric pressure to the line passing over the pulley; then the elastic force of the steam being unbalanced, the piston would rise till that elastic force would be half the atmospheric pressure, or till the piston would be at double its former height. Now conceive the steam to be condensed, and the weight removed from the pulley at the same instant, and the power of the descent, less the power added to produce the ascent, will be one half more than by simply condensing steam of atmospheric elastic force; and even this ratio may be increased by adding the weight in portions to the line over the pulley, and diminishing the elastic forces of the steam. This is the principle of the expansion engines of Watt and Hornblower.

300. It has been assumed that steam at least of atmospheric elastic force was generated; but this is not a necessary condition, for it frequently occurs that engines work with steam of less elastic force. The same mode of illustration will show whence this happens. Let half the pressure of the atmosphere on the piston be balanced by a weight over a pulley. Then, on the application of heat, steam of half the atmospheric elastic force would be generated, and raise the piston to double the height that it would be raised by steam capable of supporting the atmospheric pressure; consequently, on its being condensed, the descending force will be half the atmospheric pressure acting through double the height; and the steam produces the same effect as before.

We shall have occasion to show the value of this principle in regulating the power of atmospheric engines.

301. In all these illustrations of the modes of obtaining power from steam, I have taken the atmospheric pressure as one of the active forces; in some cases steam pressure is employed in practice, but the difference in employing this or that kind of pressure is dependent on other circumstances than its force, such as the rate of cooling and the like, and does not affect the relations of the forces of steam acting with only small alterations of temperature.

OF COMPUTING THE POWER OF STEAM TO PRODUCE RECTILINEAR MOTION.

302. If we suppose the force of steam in a cylinder to be equal to the mean pressure of the atmosphere, we may easily compute the power of the steam of a given quantity of water, as far as it possibly can be obtained by condensation, and not acting expansively. Thus the space occupied by steam of 212° is 1711 times the bulk of the water which produces it, (art. 120.) when it is capable of resisting the mean pressure of the atmosphere, and that mean pressure is 2120 lbs. on a square foot; hence $1711 \times 2120 = 3,627,320$ lbs. raised 1 foot by the steam of a cubic foot of water. Or multiplying by the area of a circle whose

diameter is unity, we have 2,860,000 lbs. raised 1 foot for the utmost power of a cylindric foot of water converted into steam. To deduct from this there is the waste steam, the friction of the piston, and the resistance of the uncondensed vapour. I shall not attempt at present to compute the extent of these deductions, for it would be premature, but shall give an analytical form to the calculation, for the purpose of applying it to the expansive and other species of engines.

303. If f be the force of the steam in inches of mercury, and t its temperature, the weight of a cubic foot in grains is

$$\frac{5700 f}{459 + t}.$$

Now a cubic foot of water, at the lowest temperature it is likely to be when condensed, will be 436500 grains; hence,

$$\frac{436500 (459 + t)}{5700 f} = \frac{76 \cdot 58 (459 + t)}{f}$$

is the bulk of the steam when that of the water is *unity*.

Now neglecting the taking of *unity* for the bulk of the water, we have $70 \cdot 75 f$ = the force of steam on a square foot; and we have

$$70 \cdot 75 f \times \frac{76 \cdot 58 (459 + t)}{f} = 5418 (459 + t)$$

for the lbs. 1 cubic foot of water converted into steam, of the temperature t , would raise 1 foot high, without reduction for loss by friction, uncondensed vapour, or waste.

This conclusion, that the power of steam is independent of its elastic force, is the same as resulted from the more popular mode of investigation, (art. 294.)

304. But if f' be the force corresponding to the temperature of the condensed water, or of the condenser, then

$$\frac{5418 (459 + t) f'}{f} = \text{the resistance.}$$

For the condensed steam is limited to the space which the whole occupied in its elastic state, and therefore offers a resistance proportional to its force acting through that space. Thus we found the space $\frac{76 \cdot 58 (459 + t)}{f}$; and the force is $70 \cdot 75 f'$; consequently, the resistance of the uncondensed steam is

$$\frac{5418 (459 + t) f'}{f}.$$

305. For the present let the proportion of waste be $1 - w$, and let the friction of the piston be denoted by F , then the power of the steam of a cubic foot of water, of the temperature t , =

$$5418 (459 + t) w - \frac{5418 (459 + t) (f' + F) w}{f} = 5418 (459 + t) \left(1 - \frac{f' + F}{f}\right) w.$$

306. We may next ascertain the effect of EXPANSION; which is easily computed, for when the temperature does not sensibly alter during the action, the force of the steam is inversely as the space it occupies; therefore if b be its bulk, p its force, x any increase of bulk, and δx its variation; then $b + x : b :: p : \frac{p b}{b + x}$; and $\frac{p b \delta x}{b + x}$ = the power developed in expanding through the space δx ; and the integral of this quantity is $p b$ hyp. log. $(b + x) + C$; but when $x = 0$, $p b$ hyp. log. $(b + x) + C = 0$; hence the power is

$$p b \text{ hyp. log. } \frac{b + x}{b}.$$

But, to return to our previous notation, suppose the volume of expansion to be n times the volume of steam, and make $x = n - 1 b$; then since

$$b = \frac{76 \cdot 58 (459 + t)}{f} \text{ and } p = 70 \cdot 75 f;$$

$$\text{we have } \epsilon = p b \text{ hyp. log. } \frac{b + x}{b} = 5418 (459 + t) \text{ hyp. log. } n,$$

for the additional power gained by the steam expanding.

307. When the expansive principle is employed, that is, if the steam be to expand during its action on the piston, an increased length of cylinder becomes necessary; and the reduction of effect which must follow from this cause has been totally overlooked. If n be the bulk of the steam in its expanded state, when its bulk corresponding to the force f and temperature t is *unity*, then

$$5418 (459 + t) \left(1 - \frac{n (f' + F)}{f}\right) w + \epsilon$$

is the mechanical power of a cubic foot of water, when ϵ is the additional power gained by employing the expansion of the steam.

On the value of ϵ being inserted in the expression it becomes

$$5418 (459 + t) \left(1 + \text{hyp. log. } n - \frac{n (f' + F)}{f}\right) w =,$$

for the mechanical power of a cubic foot of water, when the expansive force of the steam is employed.

308. This equation has a maximum, which will be when

$$\text{hyp. log. } n - \frac{n(f' + F)}{f} = \text{a maximum.}$$

That is, when

$$n = \frac{f}{f' + F}.$$

Consequently, we shall have the greatest possible quantity of mechanical power when $\frac{f}{f' + F}$ is inserted for n ; or

$$5418 (459 + t) w \text{ hyp. log. } \frac{f}{f' + F} = \text{the greatest mechanical power.}$$

And where a table of hyperbolic logarithms cannot be conveniently referred to, the result may be obtained by multiplying the logarithm of $\frac{f}{f' + F}$, found from the common tables of logarithms, by 2.302585, which will give the corresponding hyperbolic logarithm.

309. In the best constructed engines, the waste of steam is not less than one-tenth; and, to get the extreme power of the steam of a given quantity of water at this rate of waste, we have $1 - \frac{1}{10} = w = .9$; and the expression becomes

$$4876 (459 + t) \text{ hyp. log. } \frac{f}{f' + F},$$

for the greatest possible power the steam of a cubic foot of water can afford, when acting expansively.

310. In like manner taking the same loss by waste, we have from art. 304.

$$4876 (459 + t) \left(1 - \frac{f' + F}{f}\right)$$

for the greatest possible power of the steam of a cubic foot of water, when the expansive power of the steam is not used. Consequently,

$$4876 (459 + t) \left\{ \text{hyp. log. } \frac{f}{f' + F} - \left(1 - \frac{f' + F}{f}\right) \right\}$$

is the gain by employing the expansive power.

311. Though these equations show us the limits of steam power, and are fittest for illustrating the advantages or disadvantages of difference of temperature and elastic force, clearly exhibiting the economy of using steam of considerable

elastic force, yet they still require to be applied to engines of different species.¹ This will be done in Sect. v. and vi.; but before I quit the illustration of general principles, it will be desirable to investigate the rotary action of steam.

OF COMPUTING THE POWER OF STEAM TO PRODUCE ROTARY MOTION.

312. In a great variety of the cases where steam is employed, a continuous circular motion is to be produced; and it is very generally imagined that a great advantage would be gained if the rotary motion were produced by the direct action of steam, instead of being obtained by the intervention of moving parts, for converting the rectilinear motion produced by steam into a rotary one.

But the fact that every person who has attempted to produce an engine acting by the rotary power of steam, has in a greater or less degree failed in rendering it as effective as a reciprocating engine, makes the theoretical principle of rotary action, an interesting subject of investigation.

313. Conceive a piston, D E, to be fitted to a regularly curved vessel A B, so that it may move round C, the centre of curvature of the vessel, and consequently the centre of motion. Now whether the piston be moved by the force of high pressure steam, or otherwise, the pressure on an inch of area of the piston will

FIG. 16.

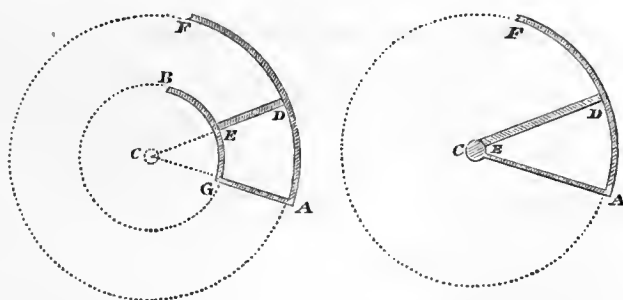

be equal on all its parts; that is, the pressure on an inch, at the most distant part D from the centre of motion, is the same as the pressure on an inch at the part E, nearest to that centre. But since the piston is constrained to move in a circle, the effects of these equal pressures are as their distances from the centre of motion, and limited by the effect of the pressure at the most distant part D. Hence, if the effective pressure of the steam be 10 lbs. on the inch, we have,

¹ A series of tables calculated by these formulæ were published in my 'Treatise on Rail Roads,' p. 161—166.

$$D C : E C :: 10 : \frac{10 \times E C}{D C},$$

the effect at E, that at D being 10. If the centre of curvature C were nearer to the side of the vessel, the effect at E would be less; therefore the effect of the pressure to produce motion is less than in a straight vessel, having the same base; and if the bases be the same, the space the pressure acts through will be as the quantity of steam. Consequently, the quantities of steam being equal, the power of rotary action will be less than that of rectilinear action.

314. If a rectangular piston, D C, revolve round a centre C, then nearly half the power of the steam will be lost.

This rough inquiry will be sufficient to show that much is lost by attempting to employ the rotary action of steam, besides the various other objections arising out of the excess of friction, and the difficulties of executing the parts so as to act properly, usually called practical difficulties.

315. To conduct the inquiry so as to reduce the effect to more accurate calculation, put

$a = D E$, the diameter of the piston;

$r = E C$, the radius of the interior circle;

$x =$ any variable portion of the diameter of the piston counted from E;

$y =$ the breadth of the piston,

and $f =$ the force of the steam on an inch of area.

Then $r + a = D C$; and,

$$r + a : r + x :: f : \frac{f(r + x)}{r + a},$$

the force at the distance x from E; and

$$\frac{f y (r + x) d x}{r + a}$$

is the differential of the pressure at that point; and the space described being $2 \pi (r + x)$ we have

$$\frac{2 \pi f y (r + x)^2 d x}{r + a}$$

for the differential of the power.

When y is uniform and therefore constant, the integral is

$$\frac{2 \pi f y (r + x)^3}{3 (r + a)} + C;$$

and making this expression nothing, when $x = 0$, that is, when the power is nothing, it becomes

$$\frac{2\pi f y}{3(r+a)} (3r^2 x + 3r x^2 + x^3);$$

and when $x = a$, we have

$$\frac{2\pi f y a}{r+a} (r^2 + r a + \frac{1}{3} a^2)$$

for the power of the steam acting in a rotary direction, the piston being the rectangle $a y$.

316. If the piston DC revolve on an axis in the centre C, then $r = 0$, and

$$\frac{2\pi f y a^2}{3} = \text{the rotary power.}$$

But the space occupied by the steam is $\pi a (2r + a) y$, and its rectilinear power is $\pi f a (2r + a) y$. Hence the rectilinear is to the rotary effect of the steam, as

$$(2r + a) : \frac{2(r^2 + r a + \frac{1}{3} a^2)}{r + a};$$

or as

$$2r^2 + 3ra + a^2 : 2(r^2 + r a + \frac{1}{3} a^2).$$

When $r = 0$, or the piston revolves on a centre, then the ratio becomes 3 : 2, or one-third of the power is lost; the same conclusion resulting however the steam acts.

317. We have supposed the piston to be of parallel width, but in some schemes it has been made circular; and in such a case the value of $\frac{1}{2} y$ is $\sqrt{ax - x^2}$. Consequently,

$$\frac{4\pi f (r+x)^2 \sqrt{ax - x^2} dx}{r+a}$$

is the differential of the rotary power. Its integral, from $x = 0$ to $x = a$, is

$$\frac{\pi^2}{2} f a^2 \left(\frac{r^2 + r a + \frac{5}{16} a^2}{r+a} \right),$$

the entire power.

This is a little less than the effect of a rectangular piston. When the piston revolves round an axis in its edge, the rectilinear power of a given quantity of steam is to its rotary power as 3:2 : 2. In the rectangular one it was as 3 : 2. Hence, we see there is no possibility of applying steam with the same advantage in a rotary as in a rectilinear engine; and, even to approximate to it, the radius of the circle described must be great in comparison with the diameter of the piston, and consequently difficult to execute. To employ any other than a circular

form for the piston, would cause more friction, and expose a larger portion of surface to the cooling effect of the atmosphere. These are radical objections to the rotary action of steam that cannot be removed by art.

318. It is so obvious, that it is not necessary to show, that the impulse of steam cannot be employed without great loss of fuel; we may, however, take a general view of the modes in which the action of steam may be applied.

MODES OF APPLYING THE POWER OF STEAM.

319. The arrangement being presented in a tabular form, will be more clear than in continued description. The modes of obtaining the different species of power, and the measures of their effects, have already been explained; for condensation, in art. 291.; for generation, in art. 295.; and for expansion, in art. 297.

320. The action of steam as a moving force is derived from $\left\{ \begin{array}{l} 1. \text{ the generation of steam. (Worcester.)} \\ 2. \text{ the expansion of steam. (Hornblower.)} \\ 3. \text{ the condensation of steam. (Savery.)} \end{array} \right.$

Of the species of action there may be used $\left\{ \begin{array}{l} \text{separately} \left\{ \begin{array}{l} \text{generation.} \\ \text{condensation.} \end{array} \right. \\ \text{or jointly} \left\{ \begin{array}{l} 1 \text{ and } 2. \\ 1 \text{ and } 3. \text{ (Savery.)} \\ 2 \text{ and } 3. \text{ (Hornblower.)} \\ 1, 2, \text{ and } 3. \text{ (Woolf.)} \end{array} \right. \end{array} \right.$

The action may be $\left\{ \begin{array}{l} \text{by pressure} \\ \text{by impulse.} \end{array} \right.$

The action may be exerted on $\left\{ \begin{array}{l} \text{a solid, (Newcomen,)} \\ \text{a fluid, (Worcester,)} \end{array} \right\}$ and may be $\left\{ \begin{array}{l} \text{continuous.} \\ \text{successive.} \end{array} \right.$

The motion of the surface acted upon may be in a $\left\{ \begin{array}{l} \text{straight} \\ \text{curved} \end{array} \right\}$ line.

321. The pressure of steam is the kind of action which is employed in practice; and the reasons for giving the preference to rectilineal motion have been shown, art. 317. In order that it may be economically employed, it is found that a solid is best adapted to receive its action, fluids being liable to decompose by contact with hot steam, or to condense and waste the steam. And, in consequence of a cylinder being the figure adapted to the object, and possessing the greatest capacity with the least surface, and therefore having the least loss both by cooling and by friction, it is almost universally employed. The action is

necessarily successive to render it rectilinear ; but all the species of action are used either jointly or separately. From these species of action, therefore, the engines may be classed.

322. It will be remarked that steam must be either condensed, or generated under pressure, to afford power by expansion ; hence engines may be divided into two classes, depending on condensation being used, or not ; this arrangement being most convenient.

CLASSIFICATION OF STEAM ENGINES.

323.—I. Non-condensing engines acting by the $\left\{ \begin{array}{l} 1. \text{ generative power of steam.} \\ 2. \text{ generation and expansive power of steam.} \end{array} \right.$

324.—II. Condensing engines acting $\left\{ \begin{array}{l} 1. \text{ condensation of steam.} \\ 2. \text{ condensation and expansion of steam.} \\ 3. \text{ generation and condensation of steam.} \\ 4. \text{ generation, expansion, and condensation of steam.} \end{array} \right.$
by the - - -

325. All the engines of the first class, and the third and fourth kinds of the second class, require high pressure steam. Engines of the first class are remarkable for simplicity of construction, but they never give the whole power of the steam. Engines of the second class require a considerable quantity of cold water for condensation, and therefore in some cases cannot be applied. The greatest effect is obtained by the second and fourth kinds of the second class ; or rather it is only in these two species that the whole power of the steam is obtained.

326. In both classes there are certain proportions between the length of the stroke, and the diameter of the cylinder, and between the length of the stroke and the velocity, which give a maximum of useful effect to a given quantity of steam. These being considered, and also the proportions of the additional parts required in condensing engines, the general rules for the power of engines may be established.

OF THE RATIO BETWEEN THE LENGTH OF THE STROKE, AND THE DIAMETER OF THE CYLINDER.

327. The relation between the diameter of a steam cylinder and the length of the stroke, and consequently the proportions of the cylinder, have now to be considered. If all the apertures, and all other parts be duly proportioned, and the velocity regulated so as to be esteemed uniform, then there is no circumstance relating to the motion, which has any influence on the proportions of the steam

cylinder, excepting the small difference arising from the friction not increasing exactly in the same proportion as the square of the diameter; and this difference is so small in ordinary proportions, that we may safely neglect it.

328. The only other circumstance which renders it necessary to attend to the proportions of a cylinder is the quantity of cooling surface to which the steam is exposed during its action. This surface ought to be the least possible; for its effect in condensing, and therefore of destroying the power of the steam, is considerable. (See art. 156.)

The quantity of surface consists of one end of the cylinder, one side of the piston, and the concave surface of the cylinder; but the latter is only gradually brought into contact with the steam during the stroke, and its effect, therefore, only equivalent to about half the effect of an equal surface bounding the steam during the whole of the stroke. Now the power of an engine is greatest when the effect of a given quantity of steam is the most possible; hence the question is to find the least surface capable of confining a given quantity of steam, during its action.

329. When the length of the stroke is twice the diameter of the cylinder, a given quantity of steam is bounded by the least possible quantity of surface during its action in the cylinder;¹ hence I conclude it is the best proportion for the cylinder of a steam engine, except when the space for the engine limits the length of the stroke: and the same conclusion applies to both atmospheric and steam pressure engines.

¹ Let the diameter of the cylinder be x , its length l , its capacity C , and $\pi = 3.1416$. Then, $C = \frac{\pi l x^2}{4}$; the sum of the areas of the bases $= \frac{\pi x^2}{2}$; and the area of half the concave surface $= \frac{\pi l x}{2} = \frac{2C}{x}$; hence the whole surface of the steam exposed to cooling surfaces during its action is

$$\frac{\pi x^2}{2} + \frac{2C}{x};$$

and this surface is to be a minimum, which is determined by taking its differential and making it equal to zero. That is,

$$\pi x dx - \frac{2C dx}{x^2} = 0;$$

whence,

$$x^3 = \frac{2C}{\pi};$$

and substituting for C its preceding value, we have $2x = l$; or a cylinder is of the best proportion when its length is twice its diameter.

330. If we refer to the practice of engine makers, we find no indication of a settled rule for the proportions of the cylinder, when the length of the stroke is not limited by convenience. The proportions followed at different times by Boulton and Watt, in cases where the stroke was not limited, vary from $1\frac{5}{8}$ to nearly 3 to 1, the most common about 2·7 to 1, the changes having no regularity. In Smeaton's table of the proportions of atmospheric engines,¹ the length of the stroke is made to vary nearly as the square root of the diameter, and commences at the lower part of the scale with the proportion of 4 to 1; why the square root of the diameter was fixed upon does not appear. Equally irregular are Maudslay's proportions, but approaching to 2 to 1; Fenton, Murray, and Wood's about as $2\frac{1}{2}$ is to 1. The object seems to have been to render the velocity nearly the same in all engines: the circumstances which regulate the velocity may therefore next be considered.

OF THE MAXIMUM OF USEFUL EFFECT IN STEAM ENGINES.

331. In steam engines there is a certain velocity for the piston, which gives a maximum quantity of useful effect.

In an engine already constructed, the velocity which gives the most useful effect that the engine is capable of producing, is limited by the proportions which have been given to the parts of the engine.

But in an engine to be designed, all the parts should be arranged to agree with the velocity which gives the maximum effect of a given quantity of steam: the difference between these cases is considerable; but in illustrating each by example, I shall have an opportunity of showing that a general rule could not be derived from experiments on a particular engine.

OF THE MAXIMUM FOR ENGINES EQUALISED BY A FLY.

332. Our most simple case for consideration is that where the pressure on the piston is the same throughout its stroke; and we must suppose the fly, conjointly with the mass of matter in the engine, to be so proportioned as to render its velocity as nearly as possible uniform.

Then the greatest uniform velocity the engine could possibly acquire, would be equal to half that which a falling body would acquire in descending the length of the stroke; and with this velocity the work done would be nothing; as the whole force of the steam would be expended in keeping the engine moving at that velocity.

¹ Rees's Cyclopædia, art. Steam Engine.

It must be evident that a regulated or uniform velocity cannot be greater than half the velocity a falling body would acquire in descending the length of the stroke; because with any other velocity the mass moved would not be capable of receiving and imparting equal quantities of motion in equal times, a circumstance essential to the uniform motion of an engine moved by an uniform force.

333. As at the greatest possible velocity an engine has no useful power, and, on the other hand, if the resistance be equal to the pressure of the steam, it will have no velocity, there must be an intermediate velocity, which is the best possible for the engine to work with; and this velocity is one-half the greatest uniform velocity.¹ Now the velocity a falling body would acquire in descending through the length of the stroke is equal to eight times the square root of the length of the stroke, in feet per second; therefore the velocity which corresponds to the maximum of useful effect, being one-fourth of this velocity, is twice the square root of the length of the stroke in feet per second, and 120 times the square root of that length in feet per minute.

334. Hence, for engines regulated by a fly, if the pressure on the piston were the same throughout the stroke, the best velocity for the piston in feet per minute would be 120 times the square root of the length of the stroke in feet.

That is, if the length of the stroke be 4 feet, the square root of 4 being 2, the velocity for a 4 feet stroke is $2 \times 120 = 240$ feet per minute; but the action of the valves not allowing this perfection, almost all engines belong to the next case.

335. If the steam act expansively, the velocity must be less, because the pressure on the piston varies, and the uniform motion the steam would generate in the length of the stroke would be less.

336. In a steam engine where the steam acts expansively, the supply of steam being cut off at the $\frac{1}{n}$ part of the stroke, the best velocity for the steam piston will be found by multiplying the $\frac{1}{n}$ part of the length by $\cdot 7$ added to $2\cdot 3$ times the

¹ Let V be the greatest uniform velocity; m the force producing it; and $w =$ the mass of matter by which it is rendered uniform; v being any other velocity. In this case $m v - w v =$ the effective action; and since $m v = V w$, we have

$$\frac{m V v - m v^2}{V}$$

for the effective part, which is to be the greatest possible.

The differential gives $V dv - 2 v dv = 0$ when the expression is a maximum; whence, $V = 2 v$.

logarithm of n ; then 120 times the square root of the product is the velocity in feet per minute.¹

Example. Let the steam be cut off at one-fourth of the stroke, then $n = 4$; and let the length of the stroke be 8 feet. The logarithm of n is 0.60206; therefore, $0.60206 \times 2.3 + .7$ is 2.0847, which multiplied by one-fourth of the length, or 2, is 4.169. The square root of 4.169 is 2.04; consequently, $2.04 \times 120 = 245$ feet per minute, the velocity for an 8 feet stroke when the steam is cut off at one-fourth of the stroke.

337. In the usual construction of engines not intended to act expansively, put $n = \frac{5}{4}$; and then take 103 times the square root of the length of the stroke.

For steam engines working expansively at the ordinary pressure of about 8 lbs. on a circular inch of the safety valve of the boiler, the best proportion for cutting off the steam is about one-half the stroke, and then the rule becomes 100 times the square root of the length of the stroke in feet, for the best velocity in feet per minute.

Other rules may be easily derived from the investigation in the note.

338. In single acting engines, regulated by a fly, the same relation would obtain between the length of the stroke and the velocity of the piston; but such engines cannot be used with advantage for producing a continuous motion.

OF THE MAXIMUM OF USEFUL EFFECT IN ENGINES FOR RAISING WATER.

339. In single engines for raising water we have two strokes to consider, of different species; the piston being caused to ascend by a counter weight, which should be capable of raising the piston in a short time without adding materially

¹ It has been shown (art. 306) that the expanding power of steam is $p b \text{ hyp. log. } \frac{b+x}{b}$, which added to the uniform portion, and the resistance r from friction and uncondensed vapour being subtracted, it is

$$p b \left(1 + \text{hyp. log. } \frac{b+x}{b} - r \right) = \text{the power};$$

but $b + x = l$, the length of the stroke, and $b = \frac{l}{n}$; hence,

$$\frac{p l}{n} (1 + \text{hyp. log. } n - r) = \text{the power}.$$

In ordinary circumstances $r = .3$, consequently,

$$120 \sqrt{\frac{l}{n} (.7 + \text{hyp. log. } n)} = \text{the velocity in feet per minute}.$$

to its load in the descent: and the descending stroke should not be slower than gives the maximum of useful effect, because in both cases a considerable loss of the power of the steam is taking place during its action.

340. In the ascent of the piston it must be evident that it should never acquire a greater velocity than one which the steam can follow, so as to press it with a force nearly equal to the pressure of the atmosphere; and when the apertures for the steam are arranged for the descending stroke, the ascending one will be regulated by the passage of the steam through the same apertures; and if this be the case, and in the present construction of these engines it always is so, our inquiry may be confined to the descending stroke.

341. The descent of the piston, if the effect of the steam alone were considered, it is obvious, should be determined by the condition which gives the greatest effect by a given quantity of steam; but it is dependent on the resistance of the water increasing as the square of the velocity, and the decreasing effect of the steam in the simple ratio of the increase of the velocity.

342. Now we may be allowed to consider the motion an uniform one, as it is nearly so during the greater part of the stroke; and then when the steam acts at full pressure during the whole of the descent, the velocity in feet per minute should be 98 times the square root of the length of the stroke.¹

¹ Suppose the arms of the beam to be of equal length; the steam apertures being the same, the ascending and descending strokes should be made in equal times. The greatest possible velocity V will be generated when the resistance to the water in the pumps is equal to the counter weight; and as the forces in both directions are to be equal, if m be the force producing the motion; $\frac{1}{2} m$ = the resistance at the velocity V ; and the resistance to motion in pipes being as the square of the velocity, $\frac{m v^2}{2 V^2}$ = the resistance at v , to which the counter weight must be equal; consequently,

$$m v - \frac{m v^3}{V^2} = \text{the effective power which is to be the greatest possible.}$$

The maximum takes place when $V^2 dv - 3 v^2 dv = 0$, that is, when $3 v^2 = V^2$, or $v = .577 V$. To determine V , it may be remarked, that the motion commences with an excess of power, which diminishes by the increase of resistance, till the motion becomes uniform; that the areas of the passages of the valves are only half the area of the pump, and that the mass of matter moved is twice the excess of moving force; hence, $V^2 = 8 s$, and since $3 v^2 = V^2$, it is

$$v = \sqrt{\frac{8 s}{3}} = 1.633 \sqrt{s}, \text{ the velocity in feet per second.}$$

When the velocity is in feet per minute, it is

$$60 \times 1.633 \sqrt{s} = 98 \sqrt{s}.$$

343. When the steam acts expansively, the velocity may be found from that of an expansive engine regulated by a fly, (art. 336 to 338.) as 0·8 times that velocity will be the proper velocity for an engine for raising water.

Thus we found the velocity for an 8 feet stroke, in an expansive engine where the steam was cut off at one-fourth of the stroke, to be 245 per minute, (art. 336.) and 0·8 of 245 is 196 feet per minute.¹

In these investigations I have not attempted to enter into those minute particulars which embarrass the calculation, without producing any material effect on the result.

OF THE PROPORTIONS OF AIR PUMPS AND CONDENSERS FOR STEAM ENGINES.

344. The water used for producing steam, and for condensing it, contains a considerable quantity of air, and sometimes carbonic acid and other gases. These gases separate when water is boiled, and rise with the steam; hence, were there not some method provided to take the air away when the steam is condensed, the cylinder of a steam engine would become filled with hot air, so as to impede, and in the end resist, the pressure of the steam.

345. To estimate, therefore, the proper size for an air pump, the quantity of air or other gas contained in water should be known.

Experiments on this subject have been made by Mr. Dalton,² Dr. Henry, M. Saussure, and Dr. Ure. M. Saussure³ ascertained that boiling alone was not capable of freeing liquids completely from air, but that it may be done by the joint action of heat and the air pump. In a steam engine both these causes operate in extracting air from the water introduced into the engine. According to his experiments 100 volumes of water absorb about 5 volumes of atmospheric air.

In an experiment made by Dr. Henry⁴ on spring water, he found that it afforded by boiling 4·74 per cent of gaseous matter; of which 3·38 per cent was atmospheric air, and 1·38 per cent carbonic acid: but as it is probable that this water was fully saturated, it follows from Saussure's remarks, that a greater proportion would have been obtained if it had been subjected to the combined action of boiling and the air pump; and the whole proportion of gaseous matter in spring water could not be estimated at less than seven per cent.

¹ [It may be proper here to observe, that in practice it is considered that from 96 to 100 feet per minute should be the maximum, since at higher velocities the buckets, &c. wear rapidly, besides other disadvantages.—Ed.]

² Philos. Mag. vol. xxiv.

³ Annals of Philosophy for 1815, vol. vi. p. 329.

⁴ Thomson's Chemistry, vol. iii. p. 204.

Dr. Ure's¹ experiments were also made by boiling different kinds of water, and measuring the result by a pneumatic apparatus, and at the temperature of about 55°: the proportions of gaseous matter in 100 volumes of water were found to be as stated below.

Canal water (in winter)	2·67 per cent.
Filtered river water supplied to Glasgow by the pipes of the Cranstonhill Water Company	2·52 ———
Filtered river water from the pipes of the Glasgow Water Company	2·50 ———
Water from the river Clyde, when swollen by winter rains	2·80 ———

It cannot be supposed that in these experiments the whole of the gaseous contents of the water were obtained, but assuming that two-thirds of the total gaseous contents are obtained by boiling, the quantity will vary from 3·75 to 4·2 per cent; and therefore, for river and canal water, we may assume that water contains 5 per cent of air, or $\frac{1}{20}$ of its volume.

The action of pumping it appears, from Dr. Ure's researches, expels a portion of air from water.

346. The preceding articles afford us data sufficiently accurate for the general purposes of inquiry, and in such inquiry we may suppose that, at the mean temperature and pressure,

River or canal water contains $\frac{1}{20}$ } of its volume of gaseous matter.	}
Spring or well water $\frac{1}{14}$ }	

347. The quantity of water which enters into a steam engine will all of it give out nearly the whole quantity of air it contains; therefore, calculating the volume of water used for steam at each stroke of the engine, and adding to it that used for injection in the same time, we have $\frac{1}{20}$ part for the volume of air at 60°; but in the condenser it will be of the temperature of the hot well, or about 120°; and the quantity the air expands by this increase of temperature being calculated, (see art. 119.) the bulk is found to be 5·6 per cent of that of the water, or $\frac{1}{18}$ of the bulk of the water nearly.

348. Let the injection water added to the water of the condensed steam be of the volume of the cylinder for each stroke, then $\frac{1}{18}$ of $\frac{1}{20}$, or $\frac{1}{360}$ of the cylinder's volume of air, would accumulate at each stroke if there were no air pump. Now a cubic foot of air mixes with a cubic foot of steam, when both are of the same force

¹ Quarterly Journal of Science, vol. xxi. p. 71.

and temperature (art. 122.); consequently this air must accumulate and fill half the capacity of the condenser after a few strokes, and the capacity of the air pump must be such as will remove $\frac{1}{30}$ of air, and $\frac{1}{30}$ of vapour, or both together $\frac{1}{30}$, in order to get rid of the air which enters at each stroke, when it is of such a degree of density that its force is equal to the force of steam corresponding to the temperature of the hot well.

349. If it be assumed that the elastic force of the uncondensed vapour is equal to 2 inches of mercury, and the air pump be equal to the condenser, then the bulk of the air and vapour being shown above to be $\frac{1}{30}$ at the pressure of 30 inches, and the bulk being inversely as the pressure, we shall have $2 : 30 :: \frac{1}{30} : \frac{1}{30}$.

Thus the air pump has to clear the engine of $\frac{1}{30}$ of the volume of the cylinder of air and vapour, and of $\frac{1}{30}$ of its volume of water; the sum of these is, in the nearest fraction, $\frac{1}{18}$ of the capacity of the cylinder, for each stroke.¹

350. In a double engine the air pump makes only one stroke for each cylinder of steam, but since the condenser receives a new quantity to replace that taken by the pump, there is no expansion: hence $\frac{1}{18}$ part of the capacity of the cylinder of a double engine is the least proportion for the air pump, so that the engine may work effectively in the same manner as for a single engine. In both cases the condenser and air pump are supposed to be of equal size to render this proportion applicable, and it is also understood that river water is used.

¹ Let $\frac{a}{n}$ be the volume of air contained in the injection water and the steam, t' the temperature of the condenser, and f' the force of steam corresponding to it, f being the force in the cylinder. Then $\frac{f a}{f' n} \left(\frac{459 + t'}{511} \right) =$ the volume of air, and $a =$ that of water for each stroke.

The condenser must contain both these quantities, and also what the pump leaves; and with an allowance of half for leakage and imperfect action of the valves, its least capacity must obviously be

$$\frac{3 f a}{f' n} \left(\frac{459 + t'}{511} \right) + 2 a = 3 a \left\{ \frac{f}{f' n} \left(\frac{459 + t'}{511} \right) + \cdot 67 \right\}.$$

When the pump ascends, the air will saturate with vapour, and become of twice its former volume; hence if the air pump and condenser jointly contain it in this state, they will be of equal size, and the quantity required will be removed at each stroke of the pump. Putting $t' = 100$, $f' = 2$, and $f = 30$ inches, we have

$$3 a \left(\frac{16 \cdot 5}{n} + \cdot 67 \right) = \text{capacity of air pump} = \text{condenser}.$$

If $n = 20$, as for river water, then $4 \cdot 48 a =$ capacity of pump.

If $n = 14$, as for well water, then $5 \cdot 55 a =$ capacity of pump.

351. For well water the same mode of calculation gives about $\frac{1}{12}$ for the relation between the capacity of the air pump and the cylinder. The usual proportion in Boulton and Watt's practice is $\frac{1}{8}$; and as I have made no allowance for leakage nor imperfect action of valves, this proportion appears to be nearly correct for the case considered.¹

352. There is one thing very evident in this operation: it is that an air pump half the size would be as effective as the present construction, if we could condense in the pump itself; and I see no difficulty in doing so, and propose to show its application to a simple atmospheric engine. (See art. 400.) The advantage, however, will be better understood if we show the power an air pump requires to work it.

POWER REQUIRED FOR WORKING AN AIR PUMP OF A STEAM ENGINE.

353. Let v = the velocity in feet per second; p' = the force of the steam or vapour in lbs. per circular inch; r = the friction of the piston and piston rod, and resistance of the valves; a = the diameter of the pump in inches; and $\frac{a^2}{n}$ = the area of the valves.

The head capable of producing the velocity nv through the valves, (see art. 136.) is $nv = 6.5 \sqrt{h}$; and,

$$h = \frac{n^2 v^2}{42}.$$

In a mixture of air and steam, at the mean force in such a pump, 2100 feet in height is equivalent to a pressure of 1 lb. per circular inch; hence,

$$\frac{n^2 v^2}{2100 \times 42} = \frac{n^2 v^2}{88200} \text{ the pressure in lbs.}$$

Put l = the length of the stroke; and the resistance to the *descent* of the piston will be,

$$r a^2 l + \frac{n^2 v^2 a^2 l}{88200} = a^2 l \left(r + \frac{n^2 v^2}{88200} \right).$$

The resistance to the *ascent* of the piston will be found by considering that the air and vapour is compressed till its elastic force becomes of such an excess above the atmospheric pressure, that it escapes through the valve at the velocity corresponding to the motion of the piston. The friction of the piston and weight of the water is to be added; and the force of the vapour in its expanded state may

¹ In some instances air pumps for double engines have been made about two-thirds of the diameter of the steam cylinder, and half the stroke: such pumps are undoubtedly too large.

be considered equal to the sum of the forces necessary to cause it to pass the valves.

By art. 306, the resistance of the air and vapour is,

$$p b \times \left(1 + \text{hyp. log. } \frac{b+x}{b} \right);$$

and making $b+x=l$, we have $b = \frac{p'l}{p}$; therefore,

$$lp' \left(1 + \text{hyp. log. } \frac{p}{p'} \right) = \text{the power};$$

and when the pressure of the atmosphere $p = 11.55$ lbs. and the force of the vapour $p' = .77$ lbs. or 2 inches of mercury, it becomes

$$lp' \left(1 + \text{hyp. log. } \frac{p}{p'} \right) = 2.85 l, \text{ nearly.}$$

The quantity of water will be one-sixth of the capacity, or $.055 l a^2$ lbs. raised 1 foot. Hence, the whole power required for the ascending stroke will be

$$a^2 l (2.85 + .055 l + r).$$

354. The whole power to work the pump is therefore,

$$\frac{a^2 v}{2} \left(2.85 + .055 l + \frac{n^2 v^2}{88200} + 2r \right) \text{ lbs. raised 1 foot per second.}$$

Example. Let the velocity be 1.8 feet per second; the diameter of the pump 24 inches; the length of its stroke 4 feet; the friction 2 lbs. per circular inch; and the area of the valves half the area of the pump. These numbers being inserted, we have,

$$\frac{24 \times 24 \times 1.8}{2} \left(2.85 + .055 \times 4 + \frac{2 \times 2 \times 1.8 \times 1.8}{88200} + 4 \right) =$$

$$518.4 \left(2.85 + .22 + .00015 + 4 \right) = 3665 \text{ lbs. raised 1 foot per second.}$$

As 550 lbs. raised 1 foot per second is the steam engine horse power, the power is,

$$\frac{3670}{550} = 6\frac{3}{4} \text{ horse power nearly.}$$

The pump would answer for a double engine of about 134 horse power: therefore in this case about one-twentieth part of the power of the engine is required for the air pump; or one-tenth in the case of a single engine of the same sized

cylinder; or a loss equivalent to 13 horse power in an air pump of the size in the example. To reduce this loss one-half by the mode proposed in art. 352 is certainly worthy of attention.

355. It is important to remark the circumstances which contribute to this loss of power. The loss is proportional to the capacity of the pump; therefore the smaller it is the better, provided it be sufficient to take the air. The friction is four-sevenths of the power, the actual resistance of the vapour nearly three-sevenths, and that of the water about one thirty-second. The resistance is greater the smaller the passages and valves are, but such increase does not affect the whole power in a material degree. The increase of the size of the air pump, beyond the proportions I have given, can give advantage only in an ill-constructed and leaky engine; but its decrease, after a very short range, reduces the power considerably.

SECTION V.

OF THE CONSTRUCTION OF NONCONDENSING ENGINES.

356. NONCONDENSING ENGINES, usually called *high pressure engines*, are moved by steam generated under a considerable degree of pressure; and it is the excess of this pressure above the pressure of the atmosphere, which constitutes their power to produce motion. From 30 to 40 lbs. on a circular inch is the excess above atmospheric pressure, commonly employed in this country.

357. The working parts of the engine consist of a cylinder, having passages provided with cocks or valves for steam to enter into it, either at the top or at the bottom; and also the means of letting out the steam to the atmosphere, either at the top or bottom. The cylinder has an air-tight piston, to be moved from one end to the other by the pressure of the steam, with a rod fixed to it, called the piston rod, which slides through an air-tight box at the top of the cylinder, to give motion to a crank or some other piece of machinery.

358. Now, with steam in the boiler having a force of 30 lbs. to the circular inch, if the piston be at the bottom of the cylinder, and the passage from the boiler to the bottom, and that to the atmosphere at the top, be both open, and the rest shut, the steam will exert a pressure of nearly 30 lbs. on each inch of the area of the piston, and cause it to ascend. A little before it arrives at the top, the cocks must be shut, and the moment it has got to the top, the other two cocks should be opened; the steam from the boiler will then press the piston downwards, and the steam before let in will flow out into the open air. Again, the passages must be closed a little before the completion of the stroke, and in this manner the operation may be continued.

359. The close of the cocks before the termination of the stroke prevents either concussion against the end of the cylinder, or strain on the crank shaft; and, when

properly managed, the elasticity of the steam destroys the momentum of the piston, and recoils it back without loss of force.

This will afford the reader a general notion of the action of steam in non-condensing engines, and prepare him for entering more closely into their minutiae. I have divided them into two kinds; and of the varieties depending on different forms of construction there is an immense number.

360. Noncondensing engines,

Acting by	$\left\{ \begin{array}{l} 1. \text{ the generative force of steam,} \\ 2. \text{ the generative and expansive force of steam,} \end{array} \right.$	$\left\{ \begin{array}{l} - \\ - \end{array} \right.$	Leupold, (art. 12.) 1720.
			Watt, (art. 26.) 1769.
			Trevithick, (art. 56.) 1802.
			Evans, (art. 58.)
			Oliver Evans, (art. 58.)
			Taylor and Martineau.

361. *First Species.* When the power is derived solely from *generating the steam under pressure*, (art. 295.) the construction of the parts constituting the engine is very simple. The common method is represented in Fig. 1. Plate iv. With the object of losing as little heat as possible by the cooling of the cylinder, it is generally placed partly within the boiler, and the steam is admitted and let out by a four-passage cock A, placed just without the boiler, with a throttle valve V to regulate the entrance of the steam. The steam escapes to the atmosphere by a pipe E, which is generally surrounded by water W, for the supply of the boiler, which has the effect of partially condensing the escaping steam, and facilitating its escape from the cylinder, as well as of increasing the temperature of the water before it be admitted to the boiler.

362. This construction is defective, in as far as there must be an absolute loss of all the steam in those parts of the admission pipes which are between the cock and the cylinder; and the great density of high pressure steam renders the loss of power considerable. To avoid it, there should be two double-way cocks, one at the bottom and one at the top of the cylinder; or the passages may be opened and closed by a slide, as shown in Fig. 2. where it will be obvious that the spaces between the stops and the cylinder are as small as possible.

363. If we now trace the action of the steam, and the opening of the passages, we shall find to what points to attend in perfecting the operation of the engine. In Plate iv. Fig. 1. represents an engine, of which C is the cylinder, and P the piston at the top ready for descending. The motion of the cock A might end with the end of the stroke, but the steam would be cut off, and indeed all the passages stopped when it is half turned. The closing, when quickly done, commences sufficiently before the end of the stroke, to effect the recoil of the piston (art. 359.);

and at the instant of its change of motion, the steam is fully on it. The compression which the steam left in the cylinder receives when the cock is closed, is not only a means of changing the motion without loss of force, but also occupies the space at the end of the stroke, so as to require only a small quantity to refill it with steam. We might arrange the motion so that the cocks would be half turned, and all the passages closed just at the end of the stroke: this, however, would not be so good a method, as when the cock turns with proper quickness there would be no sensible accumulation of steam to recoil the piston, and the force of that in the boiler would not be fully on, till a part of the stroke was made; and the waste at the terminations of the strokes would be greater. Hence, to complete the motion of the cock with the termination of the stroke, is the better method.

364. In the construction, Fig. 1. at every double stroke there is a loss of the force of all the steam contained in the passages between the cock and the cylinder. This defect may be avoided by the use of the slide, Fig. 2 and 3. The motion of the slide should terminate with the stroke in the same manner as with a cock; and in this construction the recoil of the compressed steam is greater, because it has less space of passage to retreat into. Valves may be placed to give similar advantages, but slides or cocks are in my opinion better adapted to high pressure engines.

365. The modes of giving motion to the cocks, slides, or valves are various: they depend chiefly on the nature of the action the engine is intended for. The same methods are applicable to engines of all species, and therefore are described together. (See Sect. VII.) The power is usually regulated by a throttle valve, but more perfectly by means of Field's valve. (See Sect. VIII.)

366. *The Proportion of Parts.* The length of the stroke of the steam piston should not, if possible, be less than twice its diameter, (art. 327.) The velocity in feet per minute should be 103 times the square root of the length of the stroke in feet, (art. 337.) And, as 4800 is to the velocity thus found, so is the area of the cylinder to the area of the steam passages, (art. 154.) The strength, proportions, and construction of the parts are given in Sect. VII. and the methods of equalization and regulation in Sect. VIII.

367. *The Power of a Noncondensing Engine* may be calculated with considerable accuracy, from knowing the excess of the force of the steam in the boiler, above the atmospheric pressure, as shown by the steam gauge, the diameter of the cylinder, and the velocity of the piston. The effective pressure on the piston is less than the force in the boiler when that force is represented by *unity*,

1. By the force producing motion of the steam into the cylinder, (art. 154.)	- - - - -	·0069
2. By the cooling in the cylinder and pipes, (art. 158.)		·016
3. By the friction of the piston and waste	- - -	·2000
4. By the force required to expel the steam into the atmosphere, (art. 154.)	- - - - -	·0069
5. By the force expended in opening valves, and friction of the parts of the engine	- - - - -	·0622
6. By the steam being cut off before the termination of the stroke, (art. 363.)	- - - - -	·1000
		<hr/>
		·3920

We may consider this 0·4, and then the effective pressure is 0·6 of the force of the steam in the boiler, diminished by the pressure of the atmosphere; whence we have the following rule for the power of an engine of this species.

368. *RULE. For noncondensing engines working at full pressure.* Multiply six-tenths of the excess of the force of the steam in the boiler, less four-tenths of the pressure of the atmosphere in lbs. on a circular inch, by the square of the diameter of the cylinder in inches, and by the velocity of the piston in feet per minute; the product is the power of the engine in lbs. raised 1 foot high per minute.¹

To find its equivalent in horse power, divide by 33000.

Example. Let the diameter of the cylinder be 11 inches, the length of the stroke 2·5 feet, the number of strokes per minute 33, and the force of the steam in the boiler 24 lbs. per circular inch above the atmospheric pressure: in this case the velocity is $2 \times 2\cdot5 \times 33 = 165$ feet, and $(24 \times 0\cdot6 - 11\cdot5 \times 0\cdot4) \times 121 \times 165 = 195657$ lbs. raised 1 foot per minute.

And,

$$\frac{195657}{33000} = 6 \text{ horse power nearly.}$$

369. If the area of the cylinder in feet be multiplied by the velocity of the engine in feet per minute, it will be the volume of steam consumed when of the density of that in the boiler; and, dividing by the volume of steam which a cubic

¹ Put a = the diameter of the cylinder in inches, v = the velocity of the piston in feet per minute, and f = the force of the steam in the boiler in inches of mercury; then,

$$\frac{0\cdot6 f - 30}{2\cdot6} \times a^2 v = \text{the power in lbs. raised 1 foot per minute,}$$

2·6 inches of mercury being 1 lb. per circular inch.

foot of water forms at the temperature or force in the boiler, (art. 121. or tables at the end,) the result will be the cubic feet of water consumed per minute; and the quantity of water, and consequently the quantity of fuel, (art. 190.) will be known; but the supply of water should be a little in excess.

370. The purposes to which noncondensing engines of this kind have been applied, are to impelling steam carriages, moving materials within deep mines, draining mines in places difficult of access, driving machinery in places where water cannot be obtained at a moderate expense, and in various instances where low pressure steam was equally available; but for most of these purposes it is inferior to the next species: the sole advantage it possesses being that of uniformity of force in every part of the stroke; which in some instances is desirable, but in others hurtful.

NONCONDENSING ENGINES TO WORK BY EXPANSION.

371. *Second Species.* The only difference required in the construction of a noncondensing engine to enable us to use the expansive power of the steam, is in the arrangement for opening and closing the steam passages. The steam must be admitted from the boiler only during a part of the stroke, and then shut off, but the passage for the escape of the steam should be open during the whole of the stroke. When the passage from the boiler is shut, the steam acts by expansion, and the power it affords by expansion is wholly in addition to that which is obtained by the preceding species; whence the economy of this method.

372. The most important question is to determine that point in the length of the stroke at which the steam should be cut off, so that it may afford the greatest quantity of useful effect from a given quantity of steam; for then a given quantity of fuel produces the greatest useful effect. Now we have shown the resistance from friction, &c. to be nearly, if not exactly, 0·4 of the whole force of the steam in the boiler, (art. 367.) and it is obvious, that when the steam has expanded till its excess of force be equal to this resistance, it will produce no further useful effect; and also that as far as the expansion exceeds this limit, there must be a decided loss of power. Hence, if we consider the capacity of the cylinder to be 1, the force being inversely as the space the steam occupies, it must be, as the whole force of the steam in the boiler is to 1, so is the whole force on the piston, when it is just equal to the friction, to the portion of the stroke when the steam should be cut off.¹ That is, if the whole force in the boiler be 120 inches

¹ Put f = the force in the boiler in inches of mercury, and $\frac{1}{n}$ = the portion of the stroke made before the steam is cut off, then,

of mercury, the atmospheric pressure being 30, the resistance is $120 \times .4 = 48$, the inches equivalent to the friction; and $30 + 48 = 78$, the whole force on the piston, consequently,

$$120 : 78 :: 1 : 0.65 = \frac{1}{1.54},$$

the portion of the stroke to be made before the steam be cut off, when its force in the boiler is 120 inches, or 90 inches in excess above the atmosphere.

373. The excess of force in the boiler must be about four-tenths of the pressure of the atmosphere, or twelve inches of mercury, to cause motion at the proper velocity: but the absolute friction being only about half this force, the engine may begin motion with about a force of six inches.

374. The most common mode of cutting off the communication between the cylinder and boiler, at the proper period of the stroke, is to give a slide two motions; the first shuts off the steam, and the second motion lets it on at the opposite end, and opens the other to the atmosphere. Such a construction is shown by Plate iv. Fig. 4. the position of the slide being shown when the steam is cut off by its first motion. This construction represents the principle followed by Messrs. Taylor and Martineau; but they place the axis of the cylinder horizontally, and construct the pistons of the cylinder and of the slides in a rather different manner from those drawn.

A horizontal piston rod never works well, and the expense of such a frame as enables us to use it in a vertical position can rarely be more than equivalent to this defect; nevertheless, in mountainous districts, where mines are difficult of access, a horizontal cylinder has the advantage of being very easily fixed.¹

375. The power of an engine of this kind should be regulated by altering the time of cutting off the steam; its power may vary from full pressure through the stroke to that obtained by cutting off at the point above determined: the average state that will give the greatest advantage, being to cut off at a mean between the point which gives the maximum of effect, and that which gives the greatest power required for the work; for a loss of power arises from cutting off sooner than is indicated by the rule, when the right amount of friction is calculated upon. For modes of giving motion to the slide, see art. 478.

$$n = \frac{f}{.4f + 30},$$

if we disregard the diminution of the pressure due to the fall of temperature in the process of expansion.

¹ Belidor shows a method of constructing a piston for a horizontal cylinder by the addition of friction rollers. Arch. Hydraul. tom. ii. p. 240.

Oliver Evans made a rude attempt to investigate the advantage of cutting off the steam in high pressure engines, claiming the principle as his own; but the engine he describes is not arranged for that purpose; he uses valves for the steam passages:¹ the objection to valves above a certain size is the difficulty of opening them.

376. The proportions of the parts for expansion engines may be ascertained by the same rules as for full pressure, (art. 366.) excepting that the velocity should be found by the rule, art. 336.

377. To determine the *power of a noncondensing engine working expansively*, it will be most useful first to ascertain the mean effective pressure on the piston, and from thence the power.

To find the mean pressure, let the steam have to be cut off at the $\frac{1}{n}$ part of the stroke. Add 1 to 2·3 times the logarithm of n ; divide the sum by n and subtract 0·4 from the result; then the remainder multiplied by the whole force of the steam in the boiler in lbs. per circular inch, and 11·55 subtracted from the product, for the pressure of the atmosphere, the result is the mean effective force of the steam on the piston in lbs. per circular inch.²

To find the power, multiply the mean effective pressure by the square of the diameter of the piston in inches, and by the velocity in feet per minute; the product is the lbs. raised 1 foot per minute.

To find its equivalent in horse power, divide by 33,000.

378. Example. If an engine work expansively, the steam being cut off at

¹ Steam Engineers' Guide, p. 30 and 67. Philadelphia, no date.

² Making $b + x = l$, and $b = \frac{l}{n}$, we have, (see art. 306)

$$p b \left(1 + \text{hyp. log. } \frac{b+x}{b} \right) = \frac{p l}{n} (1 + \text{hyp. log. } n);$$

and therefore the power of a cylinder a inches in diameter, working at a velocity of v feet per minute, is

$$\frac{p v a^2}{n} (1 + \text{hyp. log. } n) - \text{friction and resistance of the atmosphere.}$$

The latter is $\cdot 4 p a^2 v + 11\cdot 55 a^2 v$; hence

$$a^2 v \left\{ p \left(\frac{1 + \text{hyp. log. } n}{n} - \cdot 4 \right) - 11\cdot 55 \right\} = \text{the lbs. raised 1 foot per minute.}$$

The hyperbolic logarithm of n is equal 2·30285 times the common logarithm of n ; whence the rule.

When n is fixed by the rule, art. 372. viz. $n = \frac{p}{\cdot 4 p + 11\cdot 55}$, the formula reduces to the more simple form of,

$$\frac{a^2 v p}{n} (\text{hyp. log. } n) = \text{the power in lbs. raised 1 foot high per minute.}$$

the $\frac{1}{1.5}$ part of the stroke, the cylinder being 12 inches in diameter, the velocity 160 feet per minute, and the whole force of the steam in the boiler 120 inches of mercury, or 46 lbs. per circular inch,

First. $2.3 \times \log. 1.5 = 0.405$

Add 1 1.

Divide by 1.5) 1.405

0.936

Subtract 0.4 the friction and loss.

0.536

Multiply by 46 the pressure of the steam.

24.656

Subtract 11.55 the resistance of the atmosphere.

And 13.106 lbs. = the mean effective pressure on each
circular inch of the piston.

Also $12 \times 12 = 144$ the square of the diameter.

Multiply by 160 the velocity,

23040

and again by 13.1 the mean pressure.

Then 301824 lbs. = weight raised 1 foot per minute.

And $\frac{301824}{33000} = 9.15$ horse power.

379. When the steam is cut off at the $\frac{1}{n}$ part of the stroke, the quantity of steam consumed in cubic feet per minute will be found by multiplying the area of the cylinder in feet by the velocity in feet per minute, increased by one-tenth, and dividing the product by n . If this result be divided by the volume which a cubic foot of water occupies when in the state of steam of the force in the boiler, (see art. 121. or tables,) the quotient will be the quantity of water required per minute, and the equivalent quantity of fuel will be found by art. 190. The actual supply of water, and the power of the boiler should be n times that quantity; the engine will then either work at full pressure or expansively, as occasion may require.

380. In an expansive engine the moving force varies from full pressure to

nothing in the course of the stroke: for some objects this variation is desirable, because the motion of the piston is not accelerated so much towards the end of the stroke. It may be used for any of the purposes to which steam power has been found applicable; and where water is not easily procurable, it becomes the most economical species of engine.

381. *Double cylinder expansive engine.* An engine of the noncondensing kind may be worked expansively by means of a double cylinder, according to Hornblower's method, (art. 32.) In Plate iv. Fig. 5. C is the cylinder for the strong steam, and B that in which it acts by expansion. The steam enters at S from the boiler, and passing through the passage t at the top of the small cylinder, forces down the piston; the steam previously in the cylinder C passes through b , and ascending by the pipe e , enters the large cylinder B at a , and by its expanding force causes the piston to descend, the expanded steam below the piston escaping to the atmosphere by the passage c and through d . The pistons in the passages, being moved by the rods g , h , to the other sides of the apertures to the cylinders, the pressures are reversed, and the expanded steam escapes to the atmosphere by the passage a , through the aperture f . This construction is not very complex to obtain the motion of both pistons in the same direction; but it obviously could be done by one slide if the pistons had contrary motions, and I see no sound objection to their motions being contrary; and then the axis of motion should be between them. The effect of this mode of applying steam is the next point of consideration.

382. Let f be the force in inches of mercury or $0.385 f$ the force in lbs. on a circular inch of the small piston, a its area, and l the length of its stroke. Also, let $m a$ be the area of the large piston, and $n l$ the length of its stroke. Then at any portion x of the descent of the piston in the small cylinder, $n x =$ the descent in the large one. The original space of the steam being $l a$, and its pressure being inversely as its bulk; $(l - x) a + m n a x : l a :: f : \frac{f l}{l + (m n - 1) x} =$ the elastic force of the steam between the pistons. And if $.385 f'$ be the resistance from friction, loss of force, and the resistance of the atmosphere, we have,

$$.385 f a \left(1 - \frac{l}{l + (m n - 1) x} + \frac{m l}{l + (m n - 1) x} \right) - .385 m a f' =$$

the forces of both cylinders; and the differential of the power is,

$$.385 f a \left(d x + \frac{(m n - 1) l d x}{l + (m n - 1) x} \right) - .385 m n a f' d x.$$

Its integral is,

$$.385 f a \left\{ x + l \text{ hyp. log. } (l + \overline{m n - 1} x) \right\} - .385 m n a f' x,$$

which, corrected, becomes when $x = l$,

$$\cdot 385 f a l \left\{ 1 + \text{hyp. log. } m n \right\} - \cdot 385 m n a f' l.$$

Or

$$\cdot 385 f a l \left\{ 1 + \text{hyp. log. } m n - \frac{m n f'}{f} \right\} = \text{the power.}$$

383. The ratio of the capacity of the large cylinder to the small one is dependent on the amount of friction and loss of force. In the small cylinder the loss must be the same as in the cylinder of an engine working at full pressure; this appears from our mode of inquiry to be 0·4 of the force of the steam in the boiler, (art. 367.) And in the second cylinder the friction of the piston, the cooling of the cylinder, and the excess of force required to expel the steam into the atmosphere added together make $\cdot 016 + \cdot 2 + \cdot 007 = \cdot 223$ of the remaining force, or $\cdot 223 \times \cdot 6 + \cdot 4 = \cdot 5338 =$ the whole loss in the two cylinders. Hence,

$\cdot 5338 f + 30 : f :: 1 : m n = \frac{f}{\cdot 5338 f + 30} =$ the capacity of the large cylinder, when that of the small one is *unity*.

If $f = 120$ inches, then,

$$\frac{f}{\cdot 5338 f + 30} = 1\cdot 28, \text{ the relative capacity of the large cylinder.}$$

And in all cases the value of $m n$ must be less than that of n in the note to art. 377. Also, since $\cdot 5338 f + 30 = f'$, we have, from art. 382.

$$\cdot 385 f a^2 v \left(1 + \text{hyp. log. } m n - \frac{m n f'}{f} \right) = \cdot 385 f a^2 v \text{ hyp. log. } \frac{f}{\cdot 5338 f + 30}$$

for the power of the engine, of which the velocity of the small piston is v feet per minute, and its diameter a inches, the whole force of the steam being f inches of mercury in the boiler.

Consequently, the power is less in an engine with a double cylinder, than in one with a single cylinder, in the ratio of,

$$\text{the hyperbolic log. of } \frac{f}{\cdot 5338 f + 30} \text{ to that of } \frac{f}{\cdot 4 f + 30}.$$

A decrease of power and a more complex arrangement renders the double cylinder engine inferior in every respect, except that of the moving force being more equable than in a single cylinder.

384. *Of the best force for the steam of noncondensing engines.* The circumstances determining the choice of the force of the steam are almost entirely of a practical nature. As far as regards the production of the steam itself, a greater quantity of fuel will be required to generate strong steam, and there will be more

loss of heat in the operation; consequently, as far as the generation of the steam is concerned, the lower the force the better. But in the noncondensing engine the steam has to work against the pressure of the atmosphere, and loses so much of its effect; hence the more its force exceeds the atmospheric pressure, the greater will be the effect of a given quantity of steam in proportion to this loss. On the contrary, when the strength of the steam is considerable, there is much waste by leakage,¹ which with the extra expense of fuel tends to counterbalance the advantage of increasing the force; and considering these circumstances, with the danger of strong steam, it appears to me that steam of four or five atmospheres is about the best force for these engines.

¹ The rate of increase of loss by leakage may be estimated, for it depends jointly on the goodness of the workmanship, and the force tending to separate the parts. Now a good workman may fit the parts so that they would not exceed, under a strain of 1 atmosphere, a continued aperture of the 5000th part of an inch in breadth; and then if f be the force in inches of mercury, and a the diameter in inches, the magnitude of the joint will be,

$$\frac{3 \cdot 1416 a f}{30 \times 5000} = \frac{3 \cdot 1416 a f}{150000} \text{ square inches.}$$

The velocity of escape will be less than $6 \cdot 5 \sqrt{86 \cdot 5 (459 + t)}$ or $60 \sqrt{459 + t}$ (art. 136.); consequently, the quantity lost per second cannot exceed,

$$\frac{3 \cdot 1416 a f \sqrt{459 + t}}{2500}.$$

If v be the velocity of the piston in feet per second, the steam required in the same time will be $\cdot 7854 a^2 v$; hence, the quantity required being *unity*, the loss will be less than,

$$\frac{3 \cdot 1416 a f \sqrt{459 + t}}{\cdot 7854 a^2 v \times 2500} = \frac{f \sqrt{459 + t}}{625 a v}.$$

When $v = 4$, $a = 10$, $f = 133$, and $t = 300^\circ$,

$$\frac{f \sqrt{459 + t}}{625 a v} = \frac{1}{7} \text{ nearly.}$$

SECTION VI.

OF THE CONSTRUCTION OF CONDENSING ENGINES.

385. THE distinguishing feature of this class of engines is, that of condensing the steam to the state of water. The moving force is nearly equivalent to the force of the steam, as in the boiler, moving through the difference between the space in the state of steam and that in the state of water. Different systems of construction render the effective or useful power more or less, but I will endeavour to give the general principles in a few words, and then proceed to more minute detail.

386. The essential parts of a *single condensing engine* consist of a *cylinder* having a passage to admit steam at the top, and one from the bottom to convey the steam to another cylinder, called a *condenser*. The condensing cylinder has a passage from the lower part of it to an air pump; and both the air pump and the condenser are immersed in a cistern of cold water, a jet of which plays into the condenser. The cylinder has an air-tight piston fixed to a rod, which moves in an air-tight box in the top of the cylinder. Conceive there to be a valve in the piston, which, whenever the piston arrives at the bottom, opens and allows the steam to pass from the upper to the lower side of the piston. Then, let the jet be stopped, and the cylinder and condenser be filled with steam from the boiler, and the piston be raised to the top of the cylinder by a counter weight at the other end of the beam, to which the piston rod is fixed. The cock being open to admit the steam from the boiler to the cylinder, if the jet of cold water be allowed to play into the condenser, nearly the whole of the steam in the condenser, and in that part of the cylinder below the piston, will be reduced to water, and the pressure on the top of the piston being equal to the elastic force of the steam in the boiler, while the elastic force of the vapour remaining below it is very small, the difference of the forces will press down the piston, and, consequently, raise an equivalent weight at the other end of the beam.

When the piston arrives near to the bottom of the cylinder, the passage to the condenser is shut, and the valve in the piston opens; then the steam above the piston passes through to below it, as the piston rises by the action of the counter weight; and, being at the top, the valve in the piston closes, and the valve to the condenser opens, and another stroke is made, and so on successively.

But since a large quantity of water is used at each stroke, and the water contains a considerable quantity of air, the condenser would soon become filled with air and water, and the engine would cease to work; to avoid this the *air pump* is added, which, being worked by the beam, makes a stroke at each stroke of the steam piston, and clears the condenser of air and water.

387. In an atmospheric engine with a condenser, the principal difference consists in the steam being let both into and out of the cylinder by passages at the bottom; and the descent of the piston is caused by the pressure of the atmosphere on its upper surface, which is open to the air.

388. But in the atmospheric engine, as constructed before Mr. Watt's improvement of condensing in a separate vessel, the jet of cold water was thrown into the cylinder itself at each stroke; and hence the cylinder required to be heated and cooled at each stroke at a great expense both of fuel and cold water.

The addition of a separate condenser was the most valuable of Mr. Watt's improvements; his next in importance was the double acting engine. The saving from the concentration of power, which results from these improvements, can be judged of only by those who are intimately acquainted with the employment of mechanical power. To them the merit of his invention must be known and duly appreciated, and by their estimation it must ultimately be valued in public opinion.

389. The double acting engine, in general construction, resembles the single one described in the preceding article. (Art. 386.) It differs in having a passage from the boiler both to the top and the bottom of the cylinder, and a similar passage from both to the condenser. Hence, it does not require a counter weight to raise the piston, nor that the steam should pass from the upper to the lower side. The force of the steam impels the piston in both directions; and compared with a single engine of the same size, a double quantity of steam is used, and double power is exerted in the same space and time.

390. In any of these species, steam may act expansively, whether the atmospheric or steam pressure be used; but the moving force may be rendered more uniform, by using two cylinders of different sizes: in the smaller of these cylinders the steam acts with all its force throughout the stroke, and in the other it gradually expands as the stroke proceeds, and therefore the moving force is variable: but as the forces on both pistons jointly constitute the moving force,

it is never less than the force of the steam on the smaller piston. This arrangement was devised by Hornblower. (Art. 32.) The engines may be of either single or double power ; but whether the engine has double or single power, it is, in the usual construction, a complex piece of machinery.

391. We may now proceed to arrange the different species, and show the proportions adapted to particular cases.

CONDENSING STEAM ENGINES.

I. By condensation	$\left\{ \begin{array}{l} 1. \text{ Atmospheric pressure} \\ 2. \text{ Steam pressure} \end{array} \right.$	$\left\{ \begin{array}{l} \text{Single} \\ \text{Double} \end{array} \right.$	Newcomen, 1705. Watt, 1769. Watt, 1782.
II. By condensation and expansion	$\left\{ \begin{array}{l} 1. \text{ Atmospheric pressure} \\ 2. \text{ Steam pressure} \end{array} \right.$	$\left\{ \begin{array}{l} \text{Single} \\ \text{Double} \\ \text{Combined cylinder} \end{array} \right.$	Watt, 1782. Watt, 1782. Hornblower, 1781.
III. By generation and condensation.			
IV. By generation, expansion, and condensation	$\left\{ \begin{array}{l} \text{Single} \\ \text{Double} \end{array} \right.$	$\left\{ \begin{array}{l} \text{Cornish engines on Watt's construction.} \\ \text{Woolf, 1804.} \\ \text{Cornish engines on Watt's construction.} \\ \text{Woolf, 1804.} \end{array} \right.$	

OF THE CONSTRUCTION OF ENGINES WORKING BY CONDENSATION.

392. Of the engines working by condensation alone, two kinds may be distinguished ; in the one kind the moving force is the pressure of the atmosphere, in the other it is the pressure of steam : the former may be further divided into those which condense in the cylinder, and those having separate condensers ; and the latter into single and double acting engines.

ATMOSPHERIC ENGINES.

393. *The common atmospheric engine.* In the atmospheric engine, as it is usually constructed, condensation is effected in the cylinder. The parts required for this object are, a cylinder C, Plate vi. Figs. 1 and 2. close at the bottom and open at the top ; a piston P ; a passage S for the steam from the boiler to the bottom of the cylinder, provided with a valve V, or cock ; a passage for cold water to condense the steam, to inject into the cylinder at I, with a cock D ; and a

passage E for the water used for injection to run out at, provided with a self-acting valve F to prevent it flowing back ; a valve G for the air contained in the water to escape at is also necessary. Mechanism for opening and closing the valves is connected to the engine beam ; and a small supply of water by a pipe is constantly furnished to the top of the piston, to keep the packing saturated, so as to be steam-tight.

394. The operation is simple : the beam is so balanced that the steam being admitted by the steam valve V below the piston, it rises to the top of the stroke ; the steam valve is then shut, and the injection cock D is opened, and a jet of cold water rises through I, which condenses the steam to a lower degree of elasticity, and the water runs out by the passage E at the valve F ; the pressure of the atmosphere on the piston P being unopposed, it forces it down, and the air extricated by the water is expelled towards the termination of the stroke at the valve G.

The steam and injection cocks are moved by tappets on a bar moving vertically, and connected to the beam. The steam valve should close and the injection cock open just when the up stroke is completed, and the period of closing the injection cock should be adjusted to the power the engine is to exert ; the steam valve ought to open with the rise of the piston.

395. *The proportions of the parts.* The length of the cylinder should be twice the diameter, art. 329. The velocity in feet per minute should be ninety-eight¹ times the square root of the length of the stroke in feet, (art. 342.) the engine being supposed to be applied to raise water. The area of the steam passages will be found by this proportion, as 4800 is to the velocity in feet per minute, so is the area of the cylinder to the area of the steam passage, art. 154. The temperature for condensation which affords the greatest useful effect will be found by art. 166. If the area of the cylinder in feet be multiplied by half the velocity in feet, and that product by 1.23 added to 1.4 divided by the diameter in feet, (art. 163.) the result divided by 1480 will give the cubic feet of water required for steam per minute. If from 1220 the temperature of condensation be deducted, and the result divided by the difference between the temperature of the cold water and the temperature of condensation, the quotient will be the number of times the quantity of water required for injection must be greater than that required for steam (art. 284.); in general it will be about twelve times the quantity, but it had better be a little in defect than excess. The aperture for the injection must be such that the above quantity of water will be injected during the time of the stroke. The moving force in the first instant is only that due to the height of

¹ See note p. 190.

the cistern; and therefore in order that the injection be sufficiently powerful at first, the head should be about three times the height of the cylinder; and making the jet apertures square, the area should be the 850th part of the area of the cylinder, or its side should be $\frac{1}{3}$ of the diameter of the cylinder. The conducting pipe should be about four times the diameter of the jet.

396. *To determine the power of an atmospheric engine.* The moving force is the pressure of the atmosphere, from which the whole of the friction and the force of the uncondensed steam is to be deducted.

The moving force is the pressure of one atmosphere or	-	-	1.00
The loss of force measured in atmospheres consists of,			
1. The uncondensed steam corresponding to the temperature of condensation (usually about 160°)	-	-	.34
2. The force to expel it and the air from the cylinder (art. 154.)	-	-	.007
3. The friction of the piston (art. 474.)	-	-	.050
4. The force required to open and close the valves, raise injection water, and overcome the friction of the axes	-	-	.093
		<hr style="width: 50%; margin: 0 auto;"/>	
Making total loss of force	-	-	0.49
		<hr style="width: 50%; margin: 0 auto;"/>	
The portion of the pressure of the atmosphere equal the effective pressure is	-	-	0.51
or 5.9 lbs. per circular inch.			

397. *RULE* for the power of the common atmospheric engine. Multiply 5.9 times the square of the diameter of the cylinder in inches, by half the velocity of the piston in feet per minute; and the product is the effective power of the engine in lbs. raised 1 foot high per minute.

To find the horse power, divide by 33000.

Example. Let the diameter of the cylinder be 72 inches, and the length of the stroke 9 feet, making 9 strokes per minute: in this case, half the velocity is $9 \times 9 = 81$ feet per minute; consequently $5.9 \times 72^2 \times 81 = 2477433.6$ lbs. raised 1 foot per minute, or

$$\frac{2477433.6}{33000} = 75 \text{ horse power.}$$

This example is the size of the Chase Water engine, designed by Smeaton, (see art. 24. p. 23.) His estimate of the equivalent horse power differs from this chiefly through using a different measure of that power; but he also estimated on con-

densing at a lower temperature than 160° : and to estimate correctly, the proper force of the uncondensed steam should be inserted in the causes of loss of force for each particular case.

398. The engine may be regulated by cutting off the steam before the piston has arrived at the top, and cutting off the injection sooner: further means of regulation are described in Sect. VIII. By cutting off the steam it acts expansively, and a less quantity produces the effect. Water for the top of the piston, and for the supply of the boiler, should be raised from the hot well. The quantity of water required to supply the boiler being ascertained in cubic feet per minute, (art. 395.) the fuel will be known by referring to art. 190. and the size of the boiler by art. 225 or 229.

In the case of the Chase Water engine,

$$\frac{6^2 \times .7854 \times 81}{1480} \left(1.23 + \frac{1.4}{6} \right) =$$

2.4 feet of water per minute, or 144 cubic feet per hour; and 8.22 lbs. of caking coal convert 1 cubic foot of water into steam; therefore the quantity per hour will be 1183.7 lbs., or $\frac{1183.7}{75} = 16$ lbs. per hour for each horse power. The boiler may be either rectangular or cylindrical, with the steam limited to 1 lb. on the circular inch.

399. The atmospheric engine is applicable to raising water in most cases where coals are abundant: the engine is simple in construction and in operation, and does not require that accuracy of workmanship which is necessary for an engine acting by steam pressure. On a small scale it has less advantage; for when the cylinder is not more than about 2 feet in diameter, the consumption of fuel becomes great in proportion to the effect: the drainage of coal mines, and raising water to supply towns, and for irrigation where fuel is cheap, are its proper objects.

400. *Atmospheric engines with a separate condenser.* The manner in which an engine of this kind may be constructed, is shown in Plate VI. Fig. 2., where C is the cylinder with its piston P: the steam comes from the boiler by the pipe S, and by a slide B is let into the cylinder at D, or kept out. A is a pump with a solid piston, to receive the condensed steam, air, and water, and expel it: the injection is made into the pipe E; and I is the injection cock: F is a cock to let out any air that may collect below the piston *p* when the engine is at rest. To begin the operation, the slide B must be raised above S, and steam admitted till all the air be blown out at the valve Q; the pistons being at the top in both the cylinder and pump: then shut off the steam by the slide B, and open the injection; and, in consequence of the condensation produced by the jet, both the pistons will descend,

and during the first descent the cock F should be open, but afterwards closed: the injection being stopped, and the slide B moved to close the passage to the condenser, on opening that for the steam the pistons will again ascend, and the air and water of condensation will be expelled at the valve Q: the alternate opening and closing of the passages and the injection cock are required to continue the action.

401. This engine may be regulated by closing the valve B at any period of the ascent, and the cock I at any period of the descent; and as the application will be limited to raising water, the velocity in feet per minute should be 98 times¹ the square root of the length of the stroke, (art. 342.); the length of the cylinder twice its diameter; the area of the steam passages to the area of the cylinder, as the velocity in feet per minute is to 4800, (art. 154.) The air pump should be one-fourteenth of the capacity of the cylinder, (art. 349. note); or making the stroke of the air pump half that of the steam piston, the diameter of the pump should be three-eighths of the diameter of the cylinder. The quantity of steam is found by multiplying the area of the cylinder in feet, by half the velocity in feet, with the addition of one-fifth for loss by cooling and waste (art. 161.): the result divided by 1480 will give the quantity of water per minute required to supply the boiler, and 24 times that quantity will be that required for injection, (art. 284.) The diameter of the aperture for the injection should be one thirty-sixth of the diameter of the cylinder, and the injection pipe one-ninth.

402. *The power of this atmospheric engine* will be the difference between the pressure of the atmosphere on the piston, and the retarding force multiplied by half the velocity.

The pressure of the atmosphere being	-	-	-	-	-	1·000
The retarding forces are,						
1. The resistance of the uncondensed steam, temperature 125°,	=					·134
2. The force to expel it through the passages, (art. 154.)	-	-				·007
3. The loss by cooling in the cylinder, &c. (art. 161.)	-	-				·067
4. The friction of the piston, (art. 474.)	-	-	-	-		·050
5. The force required to open the valve, raise water for injection,						
and overcome the friction of the axes	-	-	-	-		·100
6. The force required to work the air pump, (art. 354.)	-	-				·100
						0·458
Sum of the retarding forces	-					
Effective pressure in parts of the atmosphere	-	-	-	-		0·542

¹ For ordinary pumping engines the velocity should not exceed 40 times the square root of the length of the stroke. (See note p. 167.)—ED.

This is equivalent to 6·25 lbs. on a circular inch : the excess of force of the steam in the boiler is a full compensation for some other causes of loss of power.

403. **RULE.** Multiply 6·25 times the square of the diameter of the piston, by half the velocity in feet per minute, and the product is the effective power in lbs. raised 1 foot high per minute.

Divide by 33000, and the quotient will be the number of horse power.

Example. If the diameter of a cylinder be 32 inches, and half the velocity be 110 feet per minute ; then $6\cdot25 \times 32^2 \times 110 = 704000$ lbs. raised 1 foot per minute, or

$$\frac{704000}{33000} = 21\frac{1}{3} \text{ horse power.}$$

404. As the quantity of water required for the boiler is found by art. 401. the quantity of fuel is easily found from art. 190. In the example of the preceding article we have $\frac{1\frac{1}{2} \times (2\frac{2}{3})^2 \times \cdot7854 \times 110}{1480} = \cdot49$ feet of water per minute, or 29·4 feet per hour ; consequently $29\cdot4 \times 8\cdot22 = 246$ lbs. of caking coal per hour ; or

$$\frac{246}{21} = 11\cdot7 \text{ lbs. per horse power.}$$

For the proportions of the boiler, see Sect. III. ; and for the beams and other parts, in reference to strength, see Sect. VIII.

405. For raising water this species of atmospheric engine is admirably adapted ; it can be constructed without difficulty by ordinary workmen ; and for water works, drainage, irrigation, canals, and other cases where water is required in considerable quantities, it is an economical mode of obtaining power.

STEAM PRESSURE ENGINES.

406. *Boulton and Watt's single engine.* The essential parts and operation of a single engine having been described, (art. 386.) we have only to show the construction as it regards effect. Fig. 4. Plate v. shows a section of the cylinder C, condenser B, and air pump A, of a single engine, arranged as is most convenient for exhibiting the parts. The steam enters from the boiler to the cylinder by the pipe S, through the valve *c* ; and presses down the piston P, which is supposed to be taken at the time of its descent : the steam below it goes into the condenser, and is condensed by the jet which plays into it. The air pump bucket *p* is descending in the air and vapour which the pump had received from the condenser during the previous ascent. When the piston is at the bottom of the cylinder, a

motion is given to the rod O, which shuts the valves *a* and *c*, and opens the valve *b*; there is then a communication open by the pipe E, between the top and bottom of the cylinder, and the pressure of the counter weight must be sufficient to overcome the friction of the piston, and expel the steam from the upper to the lower side of the piston: the action of the counter weight has also to expel the air and water of condensation through the valve Q by means of the air pump. The mode I have shown of placing the valves and moving them by a single motion is not Messrs. Boulton and Watt's, but is one intended to render the motion of the steam from the upper to the under side of the cylinder more quick, by the pipe E being exhausted: the motion of the valves is simple and easily balanced. The valves of Messrs. Boulton and Watt are similar to Fig. 5. but they move them independently of one another; and this ought to be the case for an engine to work expansively, unless a separate valve acted on by a regulator be used to cut off the steam, (see Sect. VIII.) An elevation of Boulton and Watt's single engine is represented in Plate XII. as applied to raising water.

407. *The proportions of the parts.* The length of the cylinder should be twice its diameter, (art. 329.) The velocity of the piston in feet per minute should be 98 times¹ the square root of the length of the stroke, (art. 342.) The area of the steam passages should be equal to the area of the cylinder, multiplied by the velocity of the piston in feet per minute, and divided by 4800, (art. 154.) The air pump should be $\frac{1}{3}$ th of the capacity of the cylinder, or $\frac{1}{2}$ the diameter and $\frac{1}{2}$ the length of the stroke of the cylinder, (art. 351.) and the condenser should be of the same capacity. The quantity of steam will be found by multiplying the area of the cylinder in feet, by half the velocity in feet; with an addition of $\frac{1}{10}$ th for cooling and waste (art. 160.); and this divided by the column of the steam corresponding to its force in the boiler (art. 121.) gives the quantity of water per minute required for steam, from whence the proportions of the boiler may be determined, (see Sect. III. art. 224 and 227.) At the common pressure of 2 lbs. per circular inch on the valve, the divisor will be 1497. The quantity of injection water should be 24 times that required for steam, (art. 284.) and the diameter of the injection pipe $\frac{1}{3}$ th of the diameter of the cylinder. The valves in the air pump bucket should be as large as they can be made, and the discharge and foot valves not less than the same area. For the proportions of the beams and other parts for strength, see Sect. VII.; and for the modes of regulation and management, see Sect. VIII.

408. The power of the single engine may be ascertained as follows:—

¹ See note p. 190.

Let the force in the boiler be denoted by - - - -	1.000
The effective pressure on the piston is less than the difference between the force of the steam in the boiler, and the resistance of the uncondensed steam,	
1. By the force producing the motion of the steam into the cylinder, (art. 154.) - - - -	·007
2. By the cooling in the cylinder (art. 160.) and pipes, (art. 148.) - - - -	·038
3. By the friction of the piston and loss by escape, (art. 474.) - - - -	·05
4. By the force necessary to expel the steam through the passages - - - -	·007
5. By the force required to open and close the valves, raise injection water, and the friction of the axes -	·100
6. By the steam being cut off before the end of the stroke	·100
7. By the power required to work the air pump, (art. 354.)	·100
	<hr/>
	·402
	<hr/>
	·598

The force of the steam in the boiler is commonly 35 inches of mercury; that of the uncondensed steam (temp. 120°) is 3.7 inches; hence, $35 \times .598 = 20.93$ inches, and $20.93 - 3.7 = 17.23$, or 6.65 lbs. is the mean effective pressure per circular inch on the piston; and when the steam in the boiler is of any other force, the mean effective pressure may be determined in the same manner.

409. RULE. Multiply the mean effective pressure on the piston by the square of its diameter in inches, and by half the velocity in feet per minute, and the product is the effective power in lbs. raised 1 foot high per minute.

Divide by 33000, and the result is the number of horse power.

Example. Let the force of the steam in the boiler be 35 inches of mercury, the diameter of the cylinder 48 inches, and half the velocity 135 feet per minute. Then the mean pressure is 6.65 lbs., and $6.65 \times 48^2 \times 135 = 2068416$ lbs. raised 1 foot, or

$$\frac{2068416}{33000} = 63 \text{ horse power.}$$

The water required would be

$$\frac{1.1 \times 4^2 \times .7854 \times 135}{1497} = 1.25 \text{ cubic feet per minute, or 75 per hour;}$$

and (by art. 190.) $75 \times 8.22 = 616.5$ lbs. of caking coal,¹ or $\frac{616.5}{63} = 9.8$ lbs. per hour, for each horse power.

410. The application of the single engine is limited by the nature of its action, to raising water or other works admitting of an inefficient returning stroke, but for these purposes it has great advantages. I would suggest, as an improvement, that the condensation should be effected as described for the atmospheric engine, (art. 400.) and that it should always act more or less by expansion: the full effect of expansion cannot however be obtained, unless the action be equalized by a proper arrangement of the pressures and counter-weight.

411. *Single engine acting expansively.* When the single engine acts expansively, it is necessary to determine the point of the stroke at which the steam should be cut off. Now the pressure on the piston should never be less than the mean moving force, otherwise it would be overpowered, and the column of water would descend again; consequently we may adopt this analogy. As the whole force of the steam in the boiler is to *unity*, so is half the greatest effective force on the piston added to the resistance from friction, &c. to the portion of the stroke at which the steam should be cut off. Thus, if the force in the boiler be 35 inches of mercury, and the resistance of the uncondensed steam 3.7 inches, then $3.7 + 35 \times .402 = 17.77$ inches, the loss of power from friction, &c. (art. 408.) and consequently $\frac{35 - 17.77}{2} + 17.77 = 26.38$, the pressure on the piston at the end of the stroke; therefore $35 : 1 :: 26.38 : .75 = \frac{3}{4}$ of the stroke. The steam will obviously act expansively in its ascent in the same proportion; whence a less counter-weight is necessary.

412. To find the mean pressure on the piston in an expansive engine. Let the portion of the stroke made, when the steam is cut off, be $\frac{1}{n}$,

Then the n th part of the whole force in lbs. per circular inch, of the steam in the boiler, multiplied by 2.3 times the common logarithm of n , added to .3, is the mean moving force or pressure; which is to be used in the rule (art. 409.) for finding the power, and also for adjusting the load.

Example. Suppose the steam to be cut off at three-fourths of the stroke, then $\frac{1}{n} = \frac{3}{4}$, or $n = 1.33$, and its logarithm = 0.12516; the whole force being 35 inches of mercury, or 13.5 lbs. per circular inch, we have,

¹ This is equivalent to raising about 17,000,000 lbs. 1 foot by a bushel of coals, or 192,000 lbs. by 1 lb. of coal.

$$\frac{3 \times 13.5 \times (2.3 \times .12516 + .3)}{4} = 13.5 \times .441 = 5.95 \text{ lbs. per circular inch, for}$$
the mean pressure.

413. The velocity should be found by the rule, art. 343. and the quantity of steam will be as much less than that required for an engine working at full pressure, as the portion of the stroke at which the steam is cut off is less than the whole stroke; and in other respects the quantity of water, fuel, water for condensation, &c. should be determined by the rules in art. 407.¹ The counterweight will be less in the same ratio, as the pressure on the piston is less than it is in a common engine. Owing to a larger sized engine being required, the expansive method is not valued as it ought to be, except when the force of the steam in the boiler is increased; and this I would recommend to the extent of two atmospheres, but not higher.

414. *The double engine of Boulton and Watt.* It has been already shown in what the double engine differs from a single one (art. 389). The parts are shown in Fig. 1. Plate v. where C is the cylinder; the steam enters at S, and passes into the upper part of the cylinder at F, or into the lower part at D, as in Fig. 3.; Fig. 1. showing the piston in the state of descending, and Fig. 3. as ascending. From the lower part of the cylinder in Fig. 1. the steam escapes through D into the condenser B, where it is condensed by a jet of cold water, which plays into it constantly; and the uncondensed gases and water pass through the valve G during the ascending stroke, and during the descending one they pass from the lower to the upper side of the pump bucket, through its valves, and are drawn up by the ascending stroke, and expelled at the valve Q into the hot well. When the steam piston P ascends, the steam from the upper part of the cylinder passes through F down the pipe E to the condenser. The steam passages D and F are opened and closed by a *D-slide*; so called from its plan resembling the letter D; it is moved by the rod O, by tappets or other methods (see Sect. VII. where the different methods are described). In small engines the steam passages are frequently opened and closed by cocks, in larger ones by valves or slides, the species of which, and the pistons and other parts, are described in Sect. VII.

415. *The proportions of the parts for a double engine acting with full pressure.* When the case to which the engine is applied will admit of it, the length of the cylinder should be twice its diameter (art. 329). The velocity of the piston in feet per minute should be found by multiplying the square root of the length of

¹ Taking the example of art. 409. we find 22,000,000 lbs. may be raised 1 foot by a bushel, or nearly 250,000 lbs. by 1 lb. of coal; and I do not think more has been actually done with low pressure steam by a single engine.

the stroke by 103 for machinery, or by 98¹ for raising water (art. 337 and 342). The area of the steam passages should be equal to the area of the cylinder multiplied by the velocity of the piston in feet per minute, and divided by 4800 (art. 154). The air pump should be $\frac{1}{4}$ th of the capacity of the cylinder, or $\frac{1}{2}$ the diameter, and $\frac{1}{2}$ the length of the stroke of the cylinders (art. 351), and the condenser should be of the same capacity. The quantity of steam will be found by multiplying the area of the cylinder in feet by the velocity in feet, with an addition of $\frac{1}{10}$ th for cooling and waste; and this divided by the volume of the steam corresponding to its force in the boiler (art. 121.) gives the quantity of water required for steam per minute, from whence the proportions of the boiler may be determined (see Sect. III. art. 224 and 227): at the common pressure of 2 lbs. per circular inch on the valve, the divisor will be 1497. The quantity of injection water should be 24 times that required for steam (art. 284), and the diameter of the injection pipe $\frac{1}{3}$ th of the diameter of the cylinder. The valves in the air pump bucket should be as large as they can be made, and the discharge and foot valves not less than the same area. For the proportions of the beams and other parts for strength, see Sect. VII.; and for the modes of regulation and management, see Sect. VIII.

416. *To determine the power of a double acting engine.*

Let the force of the steam in the boiler be denoted by	-	-	1.000
Then, besides the loss from uncondensed steam, there is loss,			
1. By the force producing the motion of the steam into the cylinder, (art. 154.)	-	-	.007
2. By the cooling in the cylinder, (art. 157.) and pipes, (art. 148.)	-	-	.016
3. By the friction of the piston and loss, (art. 474.)	-		.125
4. By the force necessary to expel the steam through the passages, (art. 154.)	-	-	.007
5. By the force required to open and close the valves, raise injection water, and the friction of the axes			.063
6. By the steam being cut off before the end of the stroke			.100
7. By the power required to work the air pump, (art. 354.)	-	-	.050
			<hr/>
			.368
			<hr/>
			.632

¹ See note, page 167.

The force of the steam being generally 35 inches of mercury in the boiler, the temperature of the uncondensed steam 120° , and its force 3.7 inches; hence, $35 \times .632 - 3.7 = 18.42$ inches, or 7.1 lbs. per circular inch, for the mean effective pressure on the piston.¹

417: RULE. Multiply the mean effective pressure on the piston by the square of its diameter in inches, and that product by the velocity in feet per minute, the result will be the effective power in lbs. raised 1 foot high per minute.

To find the horse power, divide the result by 33000.

Example. The diameter of the cylinder of a double engine being 24 inches, the length of the stroke 5 feet, the number of strokes per minute $21\frac{1}{2}$, and the force of the steam in the boiler 35 inches of mercury, or 5 inches above the pressure of the atmosphere; required its power.

The velocity is $2 \times 5 \times 21\frac{1}{2} = 215$ feet per minute, and the mean effective pressure on the piston will be 7.1 lbs. per circular inch; therefore $7.1 \times 24^2 \times 215 = 879264$ lbs. raised 1 foot high per minute, or

$$\frac{879264}{33000} = 26.64 \text{ horse power.}$$

The nominal power of this engine would be only 20 horse power by Boulton and Watt's mode of calculation, but it will be found that the nominal and real power nearly agree when the steam acts expansively (art. 422).

The water required for the above engine (art. 415.) will be,

$$\frac{1.1 \times 2^2 \times .7854 \times 215}{1497} = .50 \text{ cubic feet per minute, or 30 cubic feet per hour;}$$

and (art. 190.) $30 \times 8.22 = 246.6$ lbs. of caking coal, or $\frac{246.6}{26.64} = 9.25$ lbs. per hour for each horse power.²

When an engine is of less than 10 horse power, the consumption of fuel will be greater per horse power about in the ratio given in art. 221.

418. This engine is applicable to every purpose for which a stationary engine is adapted, and it is only in cases where water is procured with difficulty that it is not applied: it has also lately been brought into use as a moving agent in steam vessels. (See Sect. x.) When the steam acts expansively, the power is obtained with a smaller quantity of fuel, and to save fuel is a great object in every application of steam power.

¹ This is 9.05 lbs. per square inch.

² Mr. Watt states to the effect that 8.7 lbs. is the quantity equivalent to 1 horse power, but no doubt he means when working expansively. Notes on Robison, vol. ii. p. 145.

419. *Double engine acting expansively.* The motion of a double engine acting expansively ought to be equalized by a fly or some other method, (see Sect. VIII.) otherwise the effect cannot be perfectly obtained. To determine the point of the stroke at which the steam should be cut off, we have this proportion :

As the whole force of the steam in the boiler is to 1, so is $\cdot 368$ times that force, (art. 416.) added to the resistance of the uncondensed steam, to the part of the stroke to be made before the steam be cut off.

Thus, if the force in the boiler be 35 inches of mercury, and the resistance of the uncondensed vapour 3.7 inches, we have

$$35 : (35 \times \cdot 368) + 3.7 : : 1 : \cdot 473 = \frac{1}{2.1} \text{ of the stroke.}$$

420. To find the mean pressure on the piston of an expansive engine, the part of the stroke at which the steam is cut off being $\frac{1}{n}$, divide 2.3 times the common logarithm of n by n , and multiply the quotient by the whole force of the steam in the boiler in lbs. per circular inch ; the result will be the mean moving force on the piston per circular inch.

Example. Suppose the steam to be cut off at $\frac{1}{2.1}$ of the stroke, then $n = 2.1$, and the logarithm of 2.1 is $\cdot 32222$;

$$\text{consequently, } \frac{2.3 \times \cdot 32222}{2.1} = \cdot 354 ;$$

and as the pressure corresponding to this point of cutting off the steam is 35 inches, or 13.5 lbs. per circular inch, we have $13.5 \times \cdot 354 = 4.8$ lbs. per circular inch, the mean pressure.

421. The velocity should be found by art. 336 or 343. and the quantity of steam will be $\frac{1}{n}$ part of that required when the engine works at full pressure ; therefore the water for steam, the fuel, injection water, will be less in the same proportion in regard to the dimensions of the cylinder ; but the passages, pumps, boiler, and other proportions should be found by the rules in art. 415. in order that the engine may work either at full pressure or expansively, as circumstances may render desirable.

422. Taking the dimensions and force of steam of the engine given as an example in art. 417. its power as an expansive engine would be $4.8 \times 24^2 \times 215 = 594432$ lbs. raised 1 foot high per minute, or

$$\frac{594432}{33000} = 18 \text{ horse power.}$$

At the full pressure, the fuel was 246·6 lbs.; in this case it is $\frac{246\cdot6}{2\cdot1} = 117$ lbs.¹ hence $\frac{117}{18} = 6\cdot5$ lbs. per horse power; the advantage is therefore as 6·5 : 9·2, or as 10 : 14.² For small engines this quantity requires to be increased in the ratio given in the table, art. 221.

423. The mode of cutting off the steam by giving two movements to the slide during the stroke is shown in Plate v.: Fig. 2. shows the position of the slide when the piston is descending and the steam cut off, with the passage D to the condenser still open. Slides have the defect of requiring a separate passage to introduce the steam to expel the air from the engine at the time of starting, technically called "blowing through;" but in other respects they seem to afford the most simple and durable means of opening and closing the passages.

COMBINED CYLINDER ENGINES.

424. In Hornblower's engine with two cylinders the steam acts at full pressure in the one, and expansively in the other: as a single engine it is decidedly inferior to Boulton and Watt's construction in every respect, except that of the moving force being more nearly uniform, for there is the additional friction of the small piston; and it is a singular fact, that a single engine of this kind is more complex than a double one. As mine engines they appear to be nearly abandoned, and therefore it is not necessary to occupy space in describing a species which will be sufficiently understood by imagining two single engines acting on one beam, the one of which works at full pressure, and the steam which propels it acts expansively in the other cylinder during the next stroke. In both cylinders the steam has to change from the upper to the lower sides of the piston during the ascent. The ratio of the size of the expansion cylinder to the other should be determined by the same rule as for double engines of this kind (art. 426), and in other respects the proportions should be as for single engines.

425. *The double engine with combined cylinders.* This engine will be understood most easily with a simple mode of letting on and off the steam. Let C be the small cylinder, Plate vi. Fig. 3. and D the large one, and S the place where the steam enters the pipes. The steam enters the small cylinder at *a* when the piston descends, and the portion below its piston passes through *b*, and rising in the

¹ This is the same as raising 27,000,000 lbs. 1 foot high by 1 bushel of coals.

² If we take the mean between 6·5 and 9·2 or 7·85, it is what we may expect to be the ordinary consumption of an engine with a variable resistance, when of the best kind.

passage *c*, enters the large cylinder at *d*, while the steam passes to the condenser through *e*. When the motion is reversed by the slide being moved till the parts are on the other side of the passages, then similar motions take place in the reverse directions, and the vapour passes through *f* down a pipe to the condenser. Thus the whole apparatus is reduced to a slide box, the rod of which has only one motion for each stroke; and though it is here shown between the cylinders for convenience, it may be placed in the angle they form when close to each other.

426. *The proportions of combined engines.* The smaller cylinder should have the same proportions as for a non-condensing engine working with steam of the same force, (art. 366.) and the loss of force must be the same, that is 0.4 of the force of the steam in the boiler.

The loss of force at the piston of the large cylinder, when its power is 1 will be,

1. By the cooling in the cylinder and pipes	- - - -	.016
2. By the friction of the piston	- - - -	.125
3. By the force necessary to expel the steam through the passages	- - - -	.007
4. By the power required to work the air pump	- - - -	.050
	<hr style="width: 100%;"/>	.198

Consequently, $.6 \times .198 = .1188 =$ the portion of the whole power, which added to the loss in the small cylinder, the total loss is $.1188 + .4 = .5188$, or $.52$ nearly. Hence, if *f* denote the whole force of the steam in the boiler, 3.7 the resistance of the uncondensed steam, and *n* the times the capacity of the large cylinder is to exceed the small one, we have

$$n = \frac{f}{.52f + 3.7}$$

If for example the force of the steam in the boiler be 120 inches of mercury, then

$$n = \frac{120}{(.52 \times 120) + 3.7} = 1.82;$$

that is, the large cylinder should be 1.82 times the capacity of the small one; if it be larger, a loss of effect must necessarily ensue.

427. The power of a combined cylinder engine is easily ascertained from the investigation, art. 382. by substituting the proper constant numbers. The resulting rule for the mean pressure, supposing it to be collected on the surface of the small piston, is 2.3 times the common logarithm of the number of times the large cylinder is greater than the smaller one, multiplied by the force of the steam in the boiler on a circular inch. Thus if the force be 120 inches of mercury, then

the capacity of the large cylinder should be 1.82 times the small one; therefore $2.3 \times \log. 1.82 = .575$: and as each inch of mercury is equivalent to .385 lbs. on a circular inch, $120 \times .385 = 46.2$ lbs., and $46.2 \times .575 = 26.56$ lbs. on a circular inch, for the mean pressure collected at the small piston.

428. RULE. The mean pressure being found as above, let it be multiplied by the square of the diameter of the small cylinder in inches, and by the velocity of the small piston in feet per minute, the result will be the power in lbs. raised 1 foot per minute.

Divide by 33000 for the horse power.

Example. If the force of the steam be 120 inches of mercury, the diameter of the small cylinder 11 inches, and the velocity of its piston 160 feet per minute, then the mean pressure is 26.56 lbs.; and $26.56 \times 11^2 \times 160 = 514200$ lbs. raised 1 foot per minute, or

$$\frac{514200}{33000} = 15\frac{1}{2} \text{ horse power.}$$

429. The quantity of steam required per minute will be equal to the area of the small cylinder in feet multiplied by the velocity; and the quantity of water will be found by dividing by the volume which the steam from a cubic foot of water occupies, when of the force it is in the boiler, allowing one-tenth for waste. In the above example it is,

$$\frac{1.1 \times .66 \times 160}{479} = .242 \text{ cubic feet of water per minute, or } 14.52 \text{ per hour.}$$

The fuel will therefore be $14.52 \times 8.22 = 119.35$ lbs. of caking coal per hour, or

$$\frac{119.35}{15\frac{1}{2}} = 7.7 \text{ lbs. of coal per hour for each horse power.}$$

Comparing this with art. 422. we find there is no advantage in using two cylinders as regards economy of fuel.

430. The effects that may be obtained by engines of different species have now been reduced for the first time to definite measures, and their proportions referred to scientific principles. I have in these two sections endeavoured to render assistance to the practical engineer in as condensed and easy a form as possible, and yet with the minute circumstances in detail which are susceptible of variation by improvement in action or construction. He will see that the sum of the particulars must be near the truth, and the circumstances which increase or diminish any one of them must be apparent, or easily known by a reference to the article where it is investigated; and if he will be careful to distinguish actual practice from pretension, he will find that science and practice go hand in hand, the one supporting the conclusions of the other. It is an undeniable proposition, that the ultimate bearing

of practice is towards that which is most economically adapted for its object ; and the proper use of science is to assist in arriving at right conclusions with the least expense in trials : but at the same time that economy of power is considered, I think appropriate forms, good proportions, and excellent workmanship should be attended to in all machinery ; and in many instances it is desirable that they should be beautiful, for a beautiful machine will be so attended to as to produce economy where an inferior one would perish by neglect.

SECTION VII.

OF THE PROPORTIONS, AND THE CONSTRUCTION, OF THE PARTS OF STEAM ENGINES.

431. THE steam engine has hitherto been studied as a whole ; but in order to become more perfectly acquainted with its nature, we must dissect it, and study it in parts. This forms the object of the present section. Some of these parts have to be considered only as far as strength is concerned, as beams, shafts, cross-heads, &c. ; others in respect to the motions they are to produce, as the parallel motion, the eccentric motion, &c. ; others depend on the combination of moveable parts with accuracy of workmanship, as pistons, valves, &c. besides the modes of constructing joints, &c. According to the dependence of these parts on one another, it seems desirable to treat them in the order of valves, pistons, stuffing boxes, hand gear, piston guides, parallel motion, strength of parts, (as beams, cranks, wheel-arms, gudgeons, and teeth of wheels, — cross-heads and frames, — shafts and journals, — piston rods, connecting rods, and parallel motion rods, — cylinders, pipes, and boilers,) and joining pipes.

OF COCKS AND VALVES.

432. Under the head “Cocks and Valves” may be included all those methods which may be found useful for opening and closing passages for steam. It is of some advantage, in discussing their respective merits, to class them ; and the most simple method of doing this seems to be by the motion which opens them. In this way, our arrangement will be as follows :—

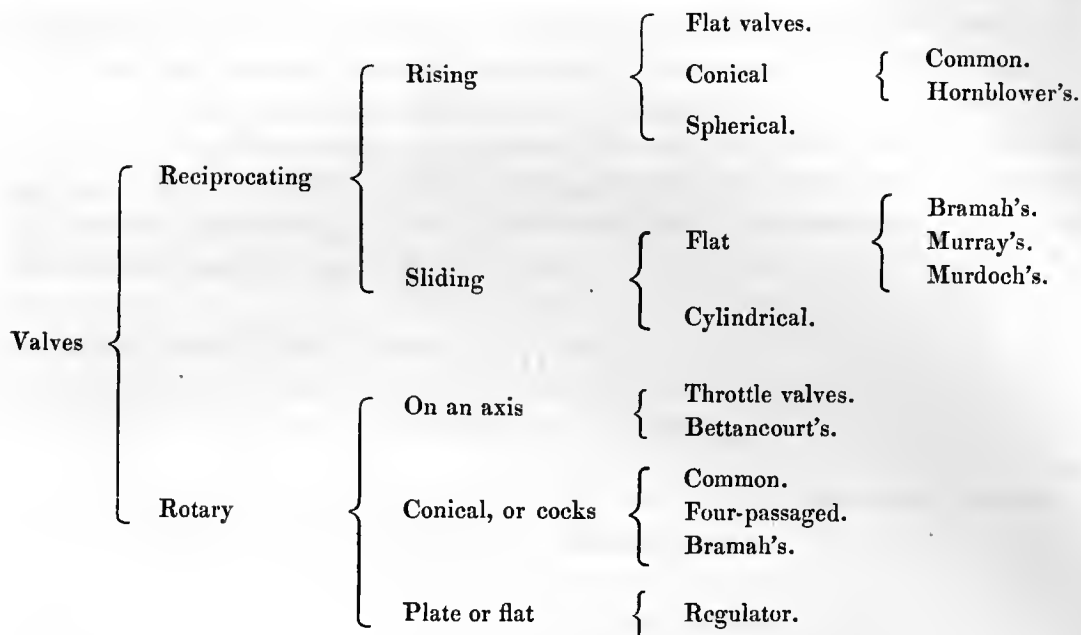

433. The office of a valve or cock being to open or to close a passage in the most perfect manner, and either instantly or progressively, as may be proper for the object in view, it is evident that those which offer the least obstruction to the passage, and are opened with the least force, are the best. Hence the convenience of considering them in succession in this place, and referring them to their respective uses.

434. All the species of valves become more difficult to manage in proportion as the apertures become larger. The area of the passage when open should be rather more than equivalent to that of the narrowest part of the pipe, and by comparing these areas the proportions of the valve boxes or apertures will be easily found for each species.

435. When valves, cocks, or sliders are to be moved to admit steam to a steam engine, the motion should be as quick as circumstances will permit, so that the passages may be wholly opened or wholly closed at the proper time with the least delay; for it may be easily shown that a considerable loss of effect arises from valves opening or shutting with a slow motion.

RISING VALVES.

436. The common CLACK VALVE is one of the most simple: in its common form it is a plate of leather a little larger than the valve aperture with a part of it fixed

in the joint as a hinge. The leather is strengthened by a metal plate on each side, the lower one less, and the upper one larger than the valve aperture. It must open to an angle of about 30° , to allow a free passage equal to its aperture, and the box should be one and a half times the diameter of the valve aperture.

Its chief application in the steam engine is for the valve between the condenser and air pump, called the foot valve, and for the blow valve; but on account of the heat of the water, it is necessary to use metal instead of leather, and to grind the parts to fit.

The foot valve G, Fig. 1 and Fig. 4. Plate v. is sometimes suspended by a hinge joint to the upper side of the passage, and falls against an inclined seat, the inclination being as much as to cause the weight of the valve to close it, and not more.

437. A DOUBLE CLACK VALVE consists of two semicircular valves, and is used for pump buckets: the construction of this is similar to the single clack valve, and the valves must rise to the same angle. They have the advantage of being more convenient than single ones for large pistons. The air pump bucket in a steam engine is furnished with metal valves of this species. See Plate v. *p*, Figs. 1 and 4.

To afford a greater quantity of passage with less resistance to open the valves, a kind of pyramidal valve, consisting of four triangular pieces, is sometimes used; but the construction is complex, and without corresponding advantages.

438. A FLAT METAL PLATE has frequently been recommended for a valve, particularly for a safety valve: it requires a guide sufficient to keep it in its proper seat; which may be most effectively done by a spindle sliding in holes in cross bars, above and below the valve. The diameter of the box should be to that of the valve as 3 : 2; and the parts should be ground together with emery, till they fit steam-tight. Its advantage as a safety valve is supposed to consist in its being less liable to stick fast, and with this opinion I perfectly agree: in other respects it differs little from the conical valve.

439. The CONICAL STEAM VALVE is a plate of metal, with its edge bevelled to fit into a conical seat: it is sometimes called a puppet or T-valve. The steam valves of Watt's engines were at first made of this kind. In this valve the diameter of the box should be to the greater diameter of the valve as 3 : 2; and it should rise not less than one-fourth of its greatest diameter when quite open; but both these proportions must be increased if the valve be out of the centre of the box. These valves and seats are often made of brass; but gun metal is better, the plate and the seat for it being of the same metal. They are turned to fit as nearly as possible; and afterwards the one is ground into the other with fine emery powder, till it accurately fits the seat.

The best angle for the valve to fit in its seat is 45° , for the pressure is ba-

lanced by the reaction of the sides. With less taper the valve has a tendency to set fast: with greater it occupies more space. When the conical valve exceeds five or six inches in diameter, it requires great power to open it against the pressure of the steam, and is therefore inconvenient. Mr. Watt applied a piston to the stem of the valve, fitted to a cylinder of the same diameter as the valve, on the opposite side of the passage; and the steam acting on the valve and piston equally, the difficulty of raising it was much reduced.

When the valve is to be self-acting, that is, to move as soon as its narrower surface is exposed to a given pressure, then the weight of the valve must be equal to the square of the diameter multiplied by the pressure in lbs. on a circular inch.

440. A valve is sometimes made with the seat a portion of a sphere, and the valve either a portion or a complete sphere to fit it. This species, under the name of a CUP VALVE, has been strongly recommended for safety valves; and by suspending the weight below the valve, it is expected in a steam vessel to be constantly in motion, so as to prevent sticking. See U, Plate xvii. Fig. 1. In other respects the cup valve seems to be inferior to the conical valve.

441. HORNBLOWER'S VALVE. A common valve must often have to be opened against a pressure depending on its surface: to avoid this, a valve on a different principle was invented by Hornblower. This valve, Fig. 4. Plate vi. is inclosed in a box, and consists of a short cylinder resting on two conical seats, one on the exterior of the cylinder, and the other an interior seat at the bottom of it. The valve is raised or depressed by the usual methods applied to the cross bar at the top, and it is guided by the rod which slides in a socket in the lower seat. If there be strong steam on the upper side of the valve, and light vapour below, the pressure tending to keep the valve close is exerted only on the horizontal areas of the two seats, instead of being distributed over the whole surface of the valve.¹

This reduction of pressing surface is obviously considerable in large valves. The principal passage for the steam is very direct; and at the lower seat, the steam in its passage going chiefly down through the body of the valve, it is interrupted only by the cross bar at the top.

442. *Improved form for* HORNBLOWER'S VALVE. The obvious difficulty of the valve is to make it fit steam-tight on two seats; but if we make the outside of the cylinder to slide in a stuffing box, or in an elastic packing of metal (see V, Fig. 1. Plate vi.) that difficulty is removed, and the largest valves may be made with no other resistance to being opened, than the pressure on the seat, and the friction of the surface of the cylinder. It is simply the common conical valve inverted,

¹ Professor Robison saw the theoretical advantages of this construction: but why has the account he gave of it been omitted in the reprint of his works?

and that which formed the seat in the common valve moves instead of the plate, and should obviously slide in a steam-tight case.

SLIDING VALVES.

443. The sluice is the oldest form of this valve, but its advantages for any other than rough work in wood do not appear to have been understood: indeed it was not to be expected that metallic surfaces would slide on each other so closely as to be tight and durable, unless very truly worked and of a hard metal.

Mr. Watt endeavoured to employ them at first, but did not succeed, and it was not till about thirty years ago, when more accurate methods of workmanship were introduced, that the slide valve appeared.

444. BRAMAH'S SLIDE VALVE. This slide valve is extensively used for pipes of water works, breweries, gas works, and various other purposes, and is exceedingly well adapted for steam passages. It consists of a box with a slider at right angles to the passage, moved by a rod passing through a stuffing box.

The slider is ground to fit accurately against the circumference of the passage with one surface, and is held close by a spring; it is moved by a handle for small apertures, and for larger ones by a rack and pinion.

445. The first idea of employing slides for more than one aperture appears to have been to the air pump by Lavoisier or some of his associates, on which Dr. Robison has remarked, that a sliding plate performs the office of four cocks in a very beautiful and simple manner; he adds, however, "that the best workmen in London thought they would be difficult to execute." The same principle was applied to the steam engine by Murray in 1799, a sliding box answering the purpose of opening and closing four steam passages, to use Dr. Robison's words, "in a beautiful and simple manner."¹

446. MURRAY'S SLIDE. The apertures all terminate in a steam-tight case, and within this a smaller box slides up and down, so as alternately to open and close the passages. A section of it is shown in Plate VI. Fig. 5. The sliding part is moved by the rod *o* passing through a stuffing box. The steam from the boiler enters at *S*, and, when the slide is down, passes through *a* to the top of the cylinder, while the passage *b c* from the bottom of the cylinder to the condenser is open through the interior of the slide; in like manner when the slide is up, the passage *b* for the steam to the bottom of the cylinder is open, and the passage *a c* from the top to the condenser is open.

A small reciprocating motion is obviously sufficient for the motion of the slide;

¹ Art. Pneumatics. Robison's Mech. Phil.

its friction from the pressure of the steam against the box is considerable ; but in order to reduce it, the rubbing surfaces should not be too small, and the harder they are the better : for steam boats, gun metal is used ; but where salt water is not to be employed, the sliding parts which apply together may be made of steel, and hardened ; they then act and wear extremely well.

447. MURDOCH'S SLIDES. In slides formed in the preceding manner there is a loss of steam, in consequence of the apertures being opened and closed at some distance from the places where the steam immediately enters the cylinder. This has been avoided in Messrs. Boulton and Watt's engines, where they have used similar slides invented by Murdoch, in which the strong steam is in the place assigned by Murray to the weak ; and in engines with a long stroke, they make the two sliders separate, and move them by a rod of communication ; because it would be more difficult to fit a long slide, so that there would be a certainty of its rubbing surfaces being in complete contact, as the least deviation of these sliders, whether at the top or bottom of the cylinder, would cause a considerable leakage. Maudslay also, in his later boat engines, has adopted the same arrangement of slides as Boulton and Watt. See Fig. 2. Plate iv.¹

448. Slides are getting into considerable repute for many purposes, and even in appearance the intricacy of a double engine is much diminished by using them. The contrivance of the slide to shut off the steam at any portion of the stroke, is a point of some importance. Mr. Millington justly esteems the want of the power to do so a defect, and says it is common to the slide and four-passaged cocks ;² but this objection may be removed in both cases by increasing the quantity of motion of the sliding surfaces one-half. For this purpose the slide should be the depth of the aperture shorter than will cover both the apertures to the cylinder, (see Figs. 1, 2, and 3. Plate v.) and it should be moved twice during the stroke by an adjustable tappet : the first motion shuts off the steam, as in Fig. 2 ; the second opens the passage to the condenser, and admits the steam at the other end. In this case let F and D represent the passages to the cylinder, S the place where the steam enters, and E the passage to the condenser. Suppose the steam to have been admitted to the upper part of the cylinder by the passage F, Fig. 1. and the slide to have been moved its first motion in Fig. 2. so as to cover F, and still leave D open to the condenser ; then, at the next movement, Fig. 3. the slide will be at the bottom and admit steam at D, and F will be open to the condenser. The steam should encircle the pipe E ; it then does not increase the friction materially by its pressure.

¹ Messrs. Maudslay and Co., in the first instance, used a four-way cock.

² Epitome of Natural Philosophy, p. 313.

449. The chief object of attention in setting out a slide, is to shorten its motion as much as possible, so as not to reduce the area of the passages. The area of the rubbing surface can scarcely be estimated at less than 8 times that of the passages, which will be about $\frac{1}{3}$ th of the area of the cylinder, (art. 154.) hence $\frac{8}{3}$ ths = the pressure; and taking the maximum pressure to be double the mean pressure, and the friction being supposed $\frac{1}{3}$ th of the pressure, it will be $\frac{2}{3}$ ths of the moving force, and it will be, in a short cylinder in action, about $\frac{1}{3}$ th of the length of the stroke; whence the loss amounts to about $\frac{1}{2}$ nd part of the power of the engine. In long cylinders the ratio will be less.

450. The *cylindrical slide* of metal, like a piston in a tube, was applied by Edelcrantz to the safety valve, but such a slide would obviously either be subject to stick fast, or allow steam to escape, as it would bear neither wear nor corrosion. Woolf's slide for regulating the quantity of steam passing an aperture is of the same kind, and seems to have no useful application whatever.¹ The attempt has been made to apply the metallic piston as a slide, and there is no doubt that it may be used both for that purpose and for the back of a flat slide: the object must be to construct it so as to be tight, and wear equally when applied to a cylinder. The advantages of such a slide I have endeavoured to show in Plates iv. and vi.²

The Box SLIDE, now much in use, is shown in Plate v. Fig. 6.

451. SEAWARD'S SLIDES. A great improvement has been recently made in the construction and application of slides, by Mr. Samuel Seaward, who took out a patent in 1835. On each of the nosles, or passages to the cylinder, and within the steam pipe, is attached a smooth face of cast iron or other metal, having the smooth part standing from the cylinder. Upon these faces two flat slide valves or shutters are caused to move either conjointly or separately, by means of stalks or spills, each being furnished with a knuckle-joint at its upper or lower end, where it is attached to the stalk so freely, as to easily move from off the face, independent of the spill or stalk. These slide-valves or shutters will effectually prevent the steam from entering the cylinder, since the pressure of the steam from the boiler will keep them close to the faces upon which they move. For the exit

¹ Philosophical Magazine, vol. xvii. p. 164.

² In Fig. 4. Plate iv. I have shown a mode of construction for the piston slide, which would possess some advantages. A ring, cylindrical on the outside and conical in the inside, may be cut into two or more parts, with lap joints, and these parts may be expanded by the pressure of the steam on a conical part made to fit the interior of the ring; on the opposite side there should be a plate ground to fit the surface of the ring, and between this plate and the bottom of the cone an elastic packing of hemp should be inserted, and the whole held together by nuts upon the piston rod. The steam apertures should be divided so that no single aperture should exceed one-eighth of the circumference.

of the steam from the cylinder two similar slide-valves move on faces attached to the eduction pipe, and may also be moved conjointly or separately: but it is not always necessary that there should be two distinct slides and faces within the induction pipe; in small double action engines the two steam passages may be brought so close, that one steam slide working over both apertures will answer the purpose. By this arrangement, each slide is pressed against the face on which it moves, by the simple pressure of the steam, and thus any water that may accumulate within the cylinder is driven back to the steam pipe, the valves being lifted off their faces by its pressure. The eduction and steam-slides being entirely distinct from each other, although set in motion by one eccentric, and one set of hand-gear, may be adjusted to expand the steam through any portion of the stroke, which is important when high pressure steam is employed. Amongst other advantages of these valves may be mentioned, simplicity of action and management, no trouble of packing and adjustment, and yet perfectly tight with the least possible friction; also they are so constructed that each slide-valve and face may be easily detached without affecting any one of the other principal valves and faces.¹

The engines of the following steam vessels are fitted with Seaward's patent slide-valves, viz.

The Volcano	150 horse power	}	Government Packets.
Megæra	150 - - -		
Naslednik	150 - - -	}	Russian Packet.
Vivid	190 - - -		
Water Witch	190 - - -	}	Hull Packets.
Emerald	140 - - -		
Duchess of Kent	130 - - -	}	Ramsgate and Boulogne Packets.
Ruby	100 - - -		
Gem	80 - - -	}	Gravesend Packets.
Topaz	70 - - -		
City of Kingston	100 - - -	}	Jamaica Packet.
Paris	190 - - -		
			Havre and Hamburgh Packet.

ROTARY VALVES.

452. **AXIS VALVES** are the most simple of the valves moved by rotary motion. A valve of this kind consists of a plate of metal fixed on an axis in the passage; the axis crosses the centre of the plate, and is made to pass through an air-tight aperture to the outside: they are extremely useful where perfect tightness is not required, as in the throttle valve, for dampers and the like. Belidor applied an axis valve to pump work, by putting the axis a little to one side of the centre;

¹ For further description, see the Appendix.

it then, however, becomes so very difficult to fit, that its use has not been continued; and this difficulty must always exist in a valve with two seats, otherwise it is easy to simplify Belidor's valve.¹

A species of slide to revolve on an axis was designed by Bettancourt for a double engine: such a slide would not, however, keep in order for any length of time, and does not appear to have been used.²

453. Cocks are so well known as to need no description; and on a small scale they are certainly the best adapted for opening and closing pipes of any thing that has yet been proposed. They do not answer so well when they are in constant action; but even then it is doubtful whether or not they are inferior to other methods, and much depends on their being properly constructed. For a single or common cock the plug should be nearly cylindrical where it has to be exposed to much pressure. The common reduction of the diameter is about one-sixth of the length.

454. For various purposes a double passage cock is useful, and in some cases one with a triple passage may be required; but the one most commonly applied to the steam passages of steam engines is of the kind called the four-way cock, and is in fact a rotary slide. Of these we have to consider two kinds: the common one, the application of which was suggested by Leupold, art. 12. and applied by Trevithick; and Bramah's improved one.

455. A FOUR-WAY COCK, by its motion round its axis, opens a communication alternately from the boiler and condenser, to the top and bottom of the cylinder of a steam engine; Fig. 1. Plate iv. The simplicity of its action in some degree compensates for its friction, but there is the disadvantage of part of the steam being lost in the pipes at each stroke. Its form should be nearly cylindrical, otherwise its friction and tendency to wear unequally will be increased. When it is ground to fit truly, the pressure of the steam tends to keep the surfaces in contact, and to wear the cavity into an elliptical shape; hence it is soon necessary to grind it to fit again.

456. The cock applied in this manner does not admit of the steam being cut off at any portion of the stroke without the use of other valves; but by dividing the spaces, so that the solid part on each side of the aperture by which the steam passes to the condenser is double the aperture, the cock may be moved at twice, so as to cut off the steam at the first movement, and leave the passage to the condenser open till the second. See Fig. 6 and 7. Plate vi. The cock must move back and forward in this case, but it will be obvious that the disposition of the surfaces is such as will prevent the wear being so destructive as it is in the common form.

¹ Architect. Hydraulique, tom. ii. p. 220.

² Prony, Architect. Hydraulique, tom. i. p. 572.

457. **BRAMAH'S FOUR-WAY COCK.** In the common one the pressure being wholly against the side of the conical plug, its wear is unequal and friction considerable: to remove these, the conic frustrum is formed on a cylindric axis, and the steam is admitted upon its larger end, by which the pressure on the seat is nearly equalized; and by turning in the same direction constantly, the wear is equalized, notwithstanding the inequality of pressure.

These cocks, with some deviations, have been very much employed by Mr. Maudslay in small engines; and an example of their application to his portable engine is shown in Plate xv. and the parts to a larger scale in Plate viii. In the plan, C is the cylinder, I the four-way cock, and E the pipe by which the steam enters. The cock is represented with all the apertures shut; but the figure above the plan is a section through the cock. The steam enters at E, flows over the top of the cock, and by an aperture G in the top it passes either to the top or to the bottom of the cylinder, according as the aperture in the side of the cone is turned to the one or the other of these passages.

By comparing the effect of turning the cock to the right or left from the position it has on the plan, the manner of opening and closing the passages will be obvious. The higher passage leads to the condenser, (marked F in the two sections,) the middle one to the top, and the lower one A to the bottom of the cylinder. If the cock be turned to the right, so that the opening in the triangular aperture through which the steam descends from the top is opposite the middle passage, then the steam will pass to the top, and the condensed vapour will have a passage open from the bottom to the condenser, through the body of the cone. If the cock be turned to the left, the centre of the triangular passage will become opposite the passage to the bottom of the cylinder, and the steam will pass in that direction, and a passage from the top to the condenser will be open through the body of the cock. In this cock the motion is back and forwards.

The escape of steam at the lower part of the cone is prevented by a packing of hemp round the cylindric part, and the cylindric part of the top is pressed by a spiral spring, with an oil cup H, and screw above it to act on the spring, if occasion requires.

The pressure and friction of this cock will not be greater than that of a slide, if both be equally well executed. The loss of steam in the passages is an objection, and the steam cannot be shut off without closing the passage to the condenser; this however is in some degree compensated for by the application of Field's valve. See Plate xv.

458. **FOUR-WAY COCK to cut off the steam at any portion of the stroke.** The mode by which this may be done, is to make the cock so much larger that there will be the breadth of two apertures between the middle and each adjoining passage. The diameter will be increased only in the ratio of 8 to 10; the rubbing surfaces

will remain nearly the same, and the cone will be more equally pressed into its socket.

459. **DOUBLE-PASSAGED COCKS.** By far the most simple method in practice would be to use two double-passaged cocks: the apparent simplicity of one cock involves more trouble and care, and after all is not so good as two small ones. Two are as easily moved as one when the movements are simultaneous, and more conveniently managed where the steam is to be cut off.

460. **PLATE OR FLAT VALVES.** The general nature of these valves may readily be conceived by imagining two flat plates to be ground to fit one another, and one to turn on an axis passing through the other plate; the plates being both pierced with apertures which coincide in one position of the moveable plate, and are all closed in another position. Valves of this kind, made of hard steel, were resorted to by Perkins for high pressure steam. When accurately made and applied, so that the pressure is tolerably equal on the moving plate, they might be useful. They admit of reducing the quantity of motion to open them in a considerable degree, but not without dividing the passage into small apertures.

461. **REGULATOR.** The steam valve is called a regulator in the atmospheric engine; it is a kind of rotary plate valve, but it is formed wholly on one side of the axis, and hence is more difficult to make work air-tight. Its construction, as designed by Smeaton, is shown in the annexed figure,

FIG. 17.

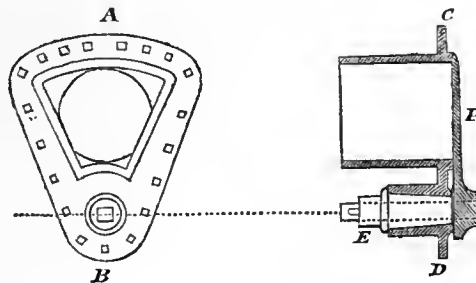

where A B is the under side of the aperture, and C D a section, with the plate P which covers it, and which is turned by a handle applied at E.

OF PISTONS.

462. The great desideratum in a piston is, that it should admit of no leakage, and have as little friction as is consistent with this indispensable quality.

Pistons may be rendered tight by an elastic packing of vegetable or animal matter ; but the latter kind of packing cannot be used for steam, on account of the heat destroying it.

Pistons may also be made wholly of metal, constructed so as to admit of a certain degree of elasticity.

After considering some particulars common to all pistons, we will treat of pistons, as below, dividing them into two classes.

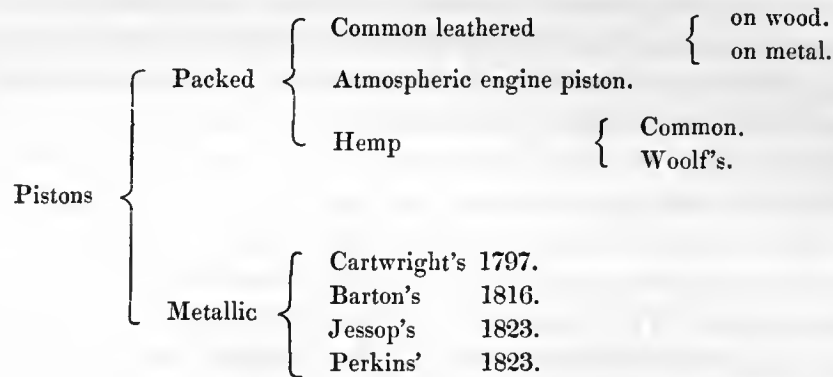

463. When a piston rod is to be pushed as well as drawn, unless it be of a certain thickness in proportion to the diameter, it is liable to stick if there be the slightest inequality in the friction, or in the centring of the rod. If it were a thin plate, nothing but its connexion to the rod would prevent it turning with the slightest inequality of its friction, on being pushed ; and as we make it thicker, the thickness interferes more and more with any tendency to turn. The proportions which will secure us from the risk of this evil are not difficult to ascertain.

Let the pressure on the piston A B move the rod C D. Then, in order that the piston may move steadily, its friction at the circumference multiplied by half the diameter of the piston, should be equivalent to the pressure producing that friction, multiplied by half the thickness of the piston ; consequently, the thickness should be to the diameter, as the friction is to the pressure of the rubbing surfaces.

The friction of brass on iron is at an average one-eighth of the pressure ; hence the thickness of metallic pistons should not be less than one-eighth of the diameter.

The friction of hemp packing on iron is about one-sixth of the pressure, hence the thickness of the packing should be one-sixth of the diameter. Practice is

FIG. 18.

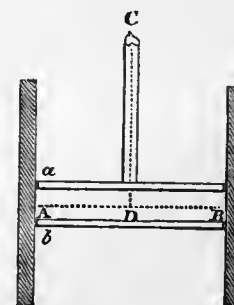

extremely variable on this point, but the mean appears to be not far distant from the rule. For leather on iron the friction is greater, the average approaching to one-fifth of the pressure.¹ When the pressure on the piston draws the rod, a thickness not more than four-tenths of that which is required when the rod is pushed will be sufficient.

It will be evident enough that the central part of the thickness of the piston adds little to the steadiness of its motion, though it increases the friction; hence that construction of a piston has the advantage which renders the upper and lower part *a b* tight, without putting a like stress on the intermediate ones at *A*.

464. The common position is a double cone of wood (Fig. 19.) having two

FIG. 19.



FIG. 20.

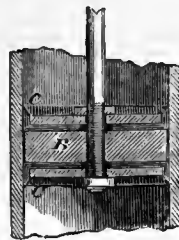

bands of strong leather fastened round it with nails or hoops. The joints in the leather are not seamed, but closed as accurately as possible, and not put opposite to one another.

465. If the parts be made of metal, a cylinder of brass should be turned to fit the barrel or the cylinder it is to move in, (Fig. 20.) so that it will slide freely without sensible resistance. Then an upper and lower plate, made of sufficient thickness for the piston to be of the depth the diameter requires, confines two cupped leathers *C C*, with the edges cut to an angle of about 45° .

Both these pistons have the advantage of the friction being at the upper and lower edges; and bevelling the edges of the leather causes the force of the fluid to spread it against the surface of the pump barrel. This mode of bevelling the leathers seems to have been first used by Mr. Smeaton for a fire engine bucket, and the general principle of construction was first applied in his air pump in 1752. Mr. Bramah applied it to the various parts of his presses, and found its advantage in the application of high pressures.

¹ Belidor, who seems to have first applied the solid piston, gives the proportions so that the thickness is nearly equal to the diameter: the friction, with such a proportion, must be greatly increased, as it must be in every part air-tight. His plates in another place show the thickness somewhat less than one-third. Architect. *Hydraulique*, vol. ii. p. 117 and 223.

466. The atmospheric engine piston consists of a plate of cast iron, about one-eighth of an inch less in diameter than the cylinder, and about one inch and a half thick, formed with a rim about four inches from the edge. A flat ring corresponding to the part beyond the rim is fitted upon it, and both have holes for bolts to screw them together, which is done after a packing of soft hemp or gasket, saturated with tallow, has been inserted. In order to render it more tight, a portion of water is kept constantly on the upper side of the piston.

Smeaton had a superior method of constructing the piston for atmospheric engines, which rendered the loss by the condensation of steam much less. The construction of that for the Chase Water engine, with a seventy-two inch cylinder, being given, will show this method. The bottom of the piston was made of wooden planks fastened by bolts to the piston plate, with rings on the under side of the planks to receive the heads of the bolts. The advantage of wood for this purpose, in cases where the injection is made in the cylinder, is obvious. See Fig. 1. Plate vi.

The plank bottom, of elm or beech, was about two inches and a quarter thick when worked, and was formed by two planks halved together, in the form of a cross, and grooved on the edges with a three-quarter inch groove, to receive the ends of the pieces to fill the corners between the cross, put in so that the pieces may have the grain radiating from the centre: a few rivets to hold the cross planks together were inserted, where they were halved into each other, at their intersection, and the whole being hooped with a good iron hoop half an inch thick and two and a quarter broad, it bound all tight together. The outside diameter of the hoop was a quarter of an inch less than the cylinder. The flat iron rings for the under surface of the piston should be let in flush with the surface of the wood, and the bolt heads counter-sunk: the planking was screwed on with a double thickness of flannel and tar between it and the iron piston plate, and any irregular hollows filled up with additional thicknesses of flannel and tar, so as to exclude the air between the plate and the wood. The bolts were carefully secured so as to make a water-tight joint from above. The plank was covered on the lower side by a lining of deal boards, shot clear of sap, and three quarters of an inch thick, nailed to the planks, with a single thickness of flannel and tar between, so as to exclude the air; after this the lower surface of the lining was made perfectly flat and smooth.

467. The HEMP PACKED PISTON is now most commonly employed for steam engines, and the usual mode of construction is as follows: the bottom of the piston *b* (Plate vii. Fig. 1.) is fitted as accurately to the cylinder as it can be done, to leave it at full liberty to rise and fall through the whole length. The part of the piston immediately above this is from one to two inches, according to the size of the engine, less all round than the cylinder, to leave a circular space into

which unspun long hemp, or soft rope prepared for the purpose, and called gasket, is wound as evenly and compactly as possible, to form the packing. This packing is compressed together by a plate or cover C, which is put over the top of the piston, having a projecting ring to fit over the lower part, and complete the upper side of the space for the packing, the pressure being produced by screws S S, &c. Both the upper and lower part of the space round the piston, to contain the packing, is a little curved, that the pressure produced by the screws on the packing may force it against the inside surface of the cylinder, into as close contact as possible.

The screws being tightened when the piston is in the cylinder, the particular form of the piston has the effect of squeezing out the packing, and causing it to press forcibly against the inside of the cylinder at its upper and lower edges. When the packing wears so as to become too small by use, these screws, which are more or less in number according to the size of the piston, are always resorted to for tightening it, as long as they are capable of acting; and when this is no longer the case, the piston top must be removed, and an additional quantity of new packing introduced. The piston rod is generally attached to the bottom part of the piston, by passing it upwards into a conical hole made to receive it, to which the bottom of the rod is exactly fitted, and a screw nut, or a wedge, between the top and bottom is inserted, which effectually secures it.

The piston is kept supplied with melted tallow by means of a funnel on the top of the cylinder lid, provided with a cock to prevent the escape of steam.

468. WOOLF'S PISTON. In the usual method, whenever the piston, by continued working, becomes too small and occasions a waste of steam, it is necessary to take off the top of the cylinder, in order to get at the screws, even when fresh packing is not wanted. This being laborious work, is therefore generally avoided by the person who attends the engine, as long as it can possibly be made to work without taking this trouble; and the neglect occasions a great and unnecessary waste of steam, and consequently of fuel in proportion.

The object of Mr. Woolf's improvement is to enable the engine man to tighten the piston, without the necessity of taking off the cover of the cylinder, except when new packing becomes necessary. He accomplishes this by the following methods.

To the head of each of the screws a small toothed wheel is fixed, so that it may be turned, and therefore tightened, by means of a central toothed wheel, which works upon the piston rod as an axis: if one of the small wheels be turned, it turns the central wheel, and the latter turns the others. The one which is to be turned by the handle is furnished with a projecting square head, which rises up

into a recess in the cover of the cylinder. This recess is surmounted by a plate fixed on with screws, called a cap or bonnet, that can be easily taken off, or put on again in its place.

The other method is similar in principle, but different in construction. Instead of having several screws all worked down by one motion, there is in this but one screw, and that one is a part of the piston rod, Plate VII. Fig. 2; on this is placed a wheel *d* of a convenient diameter, the hole in the centre of which is a female screw, cut to work into that of the piston rod. The wheel is turned round so as to tighten the piston by means of a pinion *a*, provided with a square projecting head for that purpose; rising into a recess in the cylinder cover of the kind already described, and the cover or top plate is prevented from turning with the wheel by means of the pins *e e*, called steady pins.

METALLIC PISTONS.

469. CARTWRIGHT'S PISTON. The idea of employing metal instead of elastic vegetable matter, to render the pistons of steam engines tight, was one part of the patent obtained by Cartwright in 1797.¹ It consisted in using six or more solid masses of metal in the place of the usual packing; these masses being segments of rings, *a a*, Plate VII. Fig. 3. made to fit the internal surface of the cylinder, with a second series *b b*, crossing the joints of the other, and both series were pressed against each other and the cylinder by V-springs; and by having two sets, with the joinings of the rings in the one set, opposite the solid parts of the rings of the other set, the escape of steam at the joints was to be prevented. The upper and lower parts were connected by plates, to which the piston rod was joined. (See the section, Fig. 3.)

The two exterior rings of brass were made of the full size of the cylinder, and cut into several segments, as shown at *a a a*, and laid one above the other so as to cross the joints. The joints in the under rings are shown by dotted lines in the figure; and in like manner are disposed the two interior rings, both being confined to their

¹ Mr. Watt tried metallic packings in some of his early engines, but gave them up on account of the practical difficulties in keeping them tight, and from their wearing the cylinders unequally. They are now much employed in the cylinders of sea-going vessels, where opportunities for packing cannot be embraced without considerable inconvenience and loss of time; but in point of effect, it is questionable whether there be any saving.

The best description are those manufactured with one or more cast iron or brass rings, the joints of which overlap, with a packing behind: this is preferable to those constructed with springs, which soon lose their elasticity and become useless.

places by a top and bottom plate, to which the piston rod is fixed. The segments are pushed away from the centre by steel springs, of the form of the letter V.

Pistons on Cartwright's plan have not been quite successful in practice, when the cylinders have not been truly bored; and the causes were pointed out very clearly by Mr. W. Nicholson, soon after the invention was brought before the public.¹ The pieces forming the piston having a determinate curvature, and being too strong to be sensibly flexible, cannot be expected to accommodate themselves to any irregularity in the cylinder in different parts of its length, as is done by the elastic stuffing of hemp; and there is reason to doubt, in applying them, whether the pressure of the rings or pieces together has not been too powerful for the springs to perform their office when applied in this manner.

As to the actual difference between the friction of metal, and hemp against metal, when the pistons are equally steam-tight, it is undoubtedly in favour of metallic pistons (art. 463).

470. BARTON'S PISTON. A piston considered superior to Cartwright's was made by Mr. Barton, Plate VII. Fig. 4. It consists of one thick ring E, of brass or cast iron, made very nearly to fit the cylinder, and then cut into three or more equal segments: the equal triangles remaining are used as wedges to expand the segments of rings into a larger circle. The segments, and small triangles or wedges, are secured between a top and bottom plate, as in the piston last described, with spiral springs to press the triangles outwards from the piston rod, making them act as wedges to press the segments against the inside of the cylinder; and as these wear by use, the points of the wedges themselves protrude, and, being formed of the same metal, still make part of the piston. A piston of this kind, and a true cylinder, has been known to work for some years without requiring any other attention than keeping it properly greased; but it is easy to prove that the wedges and segments do not expand equally, hence in this state it was not applicable to high pressures; besides, the imperfection of Cartwright's piston still remained. It has however been recently much improved by Barton, and therefore I propose to describe it more fully in its improved state.

The piston is represented by a plan and section, Fig. 4. It is composed of a solid cylindrical cast iron body A, having a conical hole B, to receive the enlarged end of the piston rod, to which it is secured by a cross pin D, passing through both. A space or groove is formed round the body of the piston, to receive four brass, cast iron, or cast steel, hardened and tempered segments marked E, which are spread asunder by four triangular wedges G, of the same metal as the

¹ Philosophical Journal.

segments, acted on by eight spiral springs of tempered steel. These springs are inserted in cylindrical cavities at both ends, in order to render them secure from bending, and yet allow them to play freely. With the same view, each spring has a cylindrical pin of steel within it, a little shorter than the spring. In pistons made for high pressure steam there are three grooves, formed round the exterior part of the segments, as in Fig. 5.; the middle one *a* designed to hold oil or grease, to lubricate the rubbing surfaces. The upper and lower grooves, *b b*, are for hoops of tempered steel, having a forked loose joint, as Fig. 6., at one point in each. These hoops are nicely fitted to the grooves; and when the piston is placed in the cylinders their jointed ends meet. Each hoop is prevented from turning round in the groove by a pin or stud, in order that the two hoops may not have their joints opposite to each other. These hoops, or rather springs, form an important addition, and assist greatly in preventing the leakage, which otherwise would take place through the unequal expansion of the segments and wedges; for the point of the wedge will move outwards over *n m*, Fig. 4., while the segments move only over *n o*, and consequently would wear the cylinder into grooves, were it not rounded off, and the hoops added, to prevent the escape of steam.

But by combining hardness and elasticity, Barton has done much to render these pistons tight and durable: they still however depend chiefly on the skill of the workman: when they are done well by a person who understands them, they undoubtedly answer effectively, so long as the springs retain their elasticity.

471. To avoid the effect which the unequal expansion of the parts of Barton's piston produces, I would recommend the construction shown by Fig. 7., where the wedge-formed pieces do not extend to the surface of the cylinder; and to prevent there being an aperture at each joint, two series of segments and wedges should be used, as shown in the section: the joints of the lower series are shown by dotted lines in the plan.

472. It is of importance to remark, that the metallic packing is pressed so as to be steam-tight by the steam itself; and it is essential to their perfect operation that the steam has egress to the cavities in the piston, and that the parts fit perfectly against each other in all the horizontal joints. Let strong steam be on the upper side *A*, of the piston, Fig. 7. and the lower side *B*, be open to the condenser; then the steam enters at the joints *e e*, presses the segments close on the lower plates, and fills the interior so as with the assistance of the springs to press the segments outward against the cylinder. Also, when the lower side is open to the steam, and the upper one to the condenser, the steam enters at *f f*, pressing the segments close against the cylinder and upper plate. If this were not so, the springs could not possibly press with sufficient force to keep the joints steam-tight;

for a fluid cannot be confined by a force less than its own elastic force ; and hence the pressure producing friction is always greater than the pressure of the steam on the rubbing surface, by that due to the pressure of the springs.¹

473. JESSOP'S PISTON. A completely different method of applying metal to render pistons steam-tight was invented by Mr. Jessop, and secured by patent in 1823. It consists of an expanding coil of metal, which binds round the piston body in a spiral form. Fig. 8. Plate VII. shows a section of a piston of this kind, where A A is the elastic spiral of metal, which, when at liberty and removed from the piston, assumes the form shown in Fig. 9. To form a piston of this kind, a bed of hemp packing, B B, is first prepared, which answers the double purpose of preventing steam passing at the joints, and of supplying a means of pressing the springs against the surface of the cylinder. A small addition of hemp packing is at times necessary to make up for the wear.

The action of the steam in keeping this piston tight, is by pressure on the top and bottom plates, as in the common hemp-packed pistons. The pressure and wear of these pistons will be more equable than in the other metallic kinds when they are equally well made, and they have been as successful in practice.²

474. OF THE FRICTION OF PISTONS. The rubbing surface of a piston must be pressed against the cylinder with a force at least equal to the pressure of the steam it confines, otherwise the surfaces would separate and the steam escape. Now it has been shown (art. 463.) that the thickness of the rubbing surface should be equal to that portion of the diameter which expresses the friction ; therefore, let r be the friction when the pressure is *unity*, t = the thickness, a = the diameter, and p = pressure of the steam ; then, $\pi t a p r$ = the friction ; or since $t = r a$, it is $\pi p a^2 r^2$ = the friction, to which one-tenth may be added for that of the piston rod.

The moving force is,

$$\frac{\pi p a^2}{4} ;$$

consequently that part of the moving force equal to the friction is,

$$\frac{4 \cdot 4 \pi p a^2 r^2}{\pi p a^2} = 4 \cdot 4 r^2.$$

¹ So little is known by many mechanicians of the nature of the action of pistons, that it is not unusual to hear them express an opinion on the friction of a piston from the force required to move it in an open cylinder ; and on a level with it is the method of estimating the friction of an engine by the power it requires to move it when it is doing no work. The true state of the fact is, that the friction is as the stress on the parts, and this stress bears a relation nearly in proportion to the work done.

² An arrangement of the parts of a metallic piston was one of the objects of a patent obtained by Perkins ; but as it is inferior to those already described, it will be sufficient to refer to it. See Repertory of Patents, vol. i. p. 224.

In double engines with metallic pistons, $4.4 r^2 = \frac{4.4}{8 \times 8} = .069$ of the power.

In double engines with hemp-packed pistons $4.4 r^2 = \frac{4.4}{6 \times 6} = .1222$ of the power.

In single engines with hemp-packed pistons $.4 \times 4.4 r^2 = \frac{1.76}{6 \times 6} = .049$ of the power.

In high pressure engines the friction is supposed to be in the same ratio; but the loss of steam past the piston being in respect to the power in the inverse ratio of the diameter of the piston, I have assumed the friction and loss to be two-tenths of the power, and that because it corresponded with observation in two cases where I had a tolerably certain means of comparing the power and effect. Calculation gives the loss a little more. See note to art. 384.

PISTON ROD COLLARS, OR STUFFING BOXES.

475. The piston rod collar, or stuffing box, is a contrivance for rendering the place where a smooth rod or plunger passes into a vessel air-tight. This mode of giving motion without admitting air must have been long in use; we meet with it in various works without an allusion to the time of its invention. It is so similar to the construction of a piston, that a separate detail seems scarcely to be necessary. As in the piston, so in this the effect is produced by elasticity; and leather, hemp, cotton, cork, and metal, have been used for the purpose.

Where the heat of steam is not likely to be injurious, leather is generally employed. It was first employed in discs, cut to fit the rod, and pressed together by screws. The next was cupped leathers; and the first instance of their application seems to have been at the York Buildings water works,¹ and they were used by Smeaton for his air pump: he also applied them to the piston rods of the blowing machines at Carron, and describes how to form the cups by stamping them into a cylinder of the size of the rod they are intended for.² What renders Smeaton's stuffing box for the blowing cylinders more curious, is, that he uses a block of hard wood for the rod to pass through, and the rods it seems were draw-filed. The application of cupped leathers to the plungers of the hydrostatic press by Mr. Bramah, put them to the test on a large scale, under immense pressures.

476. The stuffing box with the hemp packing is made to fit tight round the piston rod in a manner nearly similar to the piston. A collar with a hole through it, just sufficient to give easy passage to the rod, is screwed down, to confine the

¹ Architecture Hydraulique, vol. ii. p. 62. Description of the Pumps of York Buildings Water Works, London.

² Philosophical Transactions, vol. xlvii. p. 415. Reports, vol. i. p. 360.

packing, and cause it to press against the rod ; it is cup-formed at the top to contain tallow to grease the rod. See Plates iv. and v.

477. Metallic packing was tried for piston rods by Cartwright, and has since been much improved by Barton : it is however a part of so much less importance than the piston, that it will not be very often thought prudent to be at the expense, though the ingenuity of the contrivance renders it desirable to describe it. Barton's metallic substitute for stuffing boxes is shown in the annexed figures ; where D is the piston rod, E the box with a ledge for the cast iron plate F to rest on, and G another above it to receive the cast iron plate H. The cover I of the box is secured by screws in the usual manner, with plates of lead in the joints J and K,

FIG. 21.

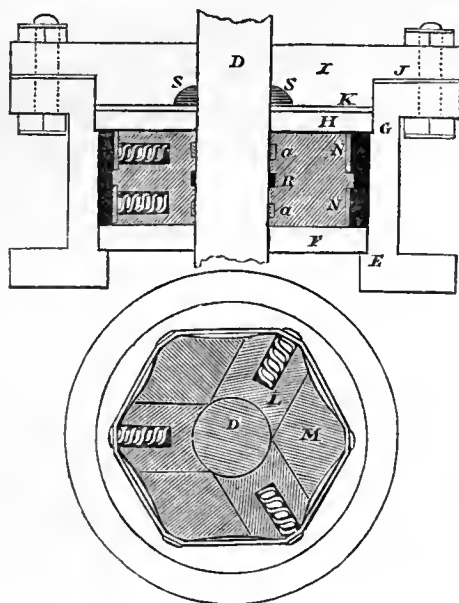

for the purpose of making the joints closer. The three principal metal blocks L embrace the piston rod D, and three wedging blocks M fill up the spaces between them. Two thin hoops N N of tempered steel, firmly riveted together at their ends, surround the outside of the blocks, binding upon the rounded exterior angles of the blocks, and these angles are left on in the middle to keep the hoops in their places. At each of the exterior angles of the blocks L, there are two spiral springs, fitted to cylindrical holes, and also provided with cylindrical pins, as those of the piston. By these and the elastic hoops the blocks L are strongly pressed towards the piston rod. Two other hoops *a a* of elastic steel, cut across, are inserted in two grooves to be in contact with the rod, and serve to close the joints more perfectly : they are fixed in a similar manner to the rings round the piston before described.

The middle groove R is formed between the two others to receive grease ; and a circular cavity S S is also made around the hole in the cover of the cylinder for the same purpose.¹

In constructing this collar the blocks L should be parallel, otherwise the wear will be irregular, and the springs will soon be ineffective ; the blocks M should not wear unless the piston rod wears ; and perhaps it will be steam-tight, unless assisted by a hemp packing behind the hoops N N.

MODES OF OPENING VALVES, COCKS, AND SLIDES.

478. The motion may be given either from the reciprocating or from the rotary parts of an engine. In engines which have no rotary parts, motion is communicated to the valves by a rod or beam, called a **PLUG TREE**, attached to the engine beam near to the end moved by the piston rod. This plug tree is provided with certain adjustable projections called **TAPPETS**, which strike the levers or handles of the valves, and thus open and shut them at the proper intervals as the beam ascends or descends. These handles turn on axes, and act as levers to move the valves, slides, or cocks. The most important point is to render the action certain, for the effect of the engine depends on the passages being opened and closed at the proper times. When valves are employed, they are generally opened by weights. (See Plate ix. Fig. 3.) A weight w , sufficient to overcome the friction and open the valve, acts by a short arm a on the axis, which requires to be turned to move the valve ; the weight is kept suspended by a spring catch b while the valve is close, and when the catch is disengaged by the handle c , being moved by the tappet d , the valve opens. If the valve be large, it requires a considerable weight w to open it against the pressure of the steam ; and in that case either the valve described in art. 442, or Watt's mode of relieving the pressure, may be adopted. It will naturally be inquired, why weights are raised to open the valves instead of using the direct power of the beam. The only reason assigned for so doing is, that a weight opens a valve more rapidly, and the loss by closing them slowly was not quite so readily detected ; though the absolute loss is about the same, and the practice is becoming more common to open them by direct action.

The descent of the weight which opens a valve is regulated by an ingenious method : it either descends into, or forces a piston into a vessel of water, (see C, Fig. 3. Plate ix.) while the aperture by which the water escapes from under it may be increased or diminished at pleasure ; the weight therefore acts with its

¹ Gill's Technical Repository, vol. iv. p. 242.

full force to open the valve, but as soon as it begins to move, it is retarded by the water, till it be finally stopped. During the ascent, a valve opens inwardly at the bottom of the vessel, and therefore the engine has not more than the weight to raise again.

In engines for raising water this mode of opening valves has always been followed. The difficulty of opening large valves was probably the cause of its introduction, and the ingenuity of its mechanism has preserved it in use; but I think there will be an advantage both in simplicity and effect, to let the motion of the plug tree act directly on the valves, as shown in art. 482: the tappet by which the steam is shut off should be capable of considerable range, whether for adjusting by hand or by a self-acting apparatus. (See art. 554.)

479. In an engine having a fly, it is esteemed better to apply an eccentric wheel within a hoop upon the fly-wheel shaft, and this by its evolution alternately pushes and draws a rod connected to the hoop, and thus gives motion to the valves, cocks, or slides. Such an apparatus is shown in Plate xv. Fig. 2. in which *N* is a cross section of the fly-wheel shaft, and *k* the eccentric wheel fixed upon and revolving with it; a circular hoop of metal encompasses the eccentric wheel in such a manner as to permit its turning round, and from this hoop the arm *i* projects, and it is braced to increase its strength. It terminates in an arm upon a centre, which by a second arm gives motion to the rod *l*, and causes another axis to move, which, by a pair of bevelled wheels, moves the cock of the engine partly round upon its axis *n*, and back again. The advantage of an eccentric wheel is the easy changes of motion it makes; for being constantly moving, it gives no stroke at the times of change; and in large engines part of the weight of the eccentric apparatus is balanced by a weight, so that there is only a slight pressure on the shaft. (See Plate xix.)

Let *r* be the radius of the eccentric circle, and *a* the distance of its centre from the centre of motion; then $(r + a) - (r - a)$ will be the extent of the movement, $= 2a$, or twice the eccentricity; and in any other position the place counted from the centre will be $a \cos. \alpha$ where α is the angle between the centres, whose cosine is equal to the horizontal distance. When they are in a vertical line, $\alpha = 90^\circ$, and $\cos. \alpha = 0$, the distance is 0, and this corresponds to the termination of the stroke. Now we know from the nature of the circle that the cosines increase rapidly at first in departing from the angle of 90° ; but at one-sixth of the stroke counted from either end of it, a valve, slide, or cock, can be only half way opened, and unless its motion be greater than that required to open it, the time it will be about fully open, will be only one-ninth part of the stroke.

480. Eccentric rollers to raise the valve rods have the same defect; but the application is ingenious. Conceive the shaft *Y*, Fig. 1. Plate viii. to be kept in

motion by the crank shaft of a double engine, causing the shaft Z to revolve by means of the wheels 7, 8; then if on Z two eccentric wheels 4, 4, be fixed under two rods which slide vertically in guides, (see *z, z*, Fig. 2.) and provided with friction rollers 3, 3, the revolution of the shaft Z will alternately raise and depress the rods, which by the arms 9, 10, 11, 12, raise and depress the valves by their stems. The lever or handle 13 is used to open or close the valves by hand in setting to work, &c. It will be remarked that this construction does not admit of cutting off the steam without also shutting the condenser.

481. As far as regards opening and closing the passages more rapidly, a good improvement has been made on the eccentric motion, by altering the form of the portion fixed on the shaft so as to act more nearly as a tooth or cam, and by placing adjustable spanners on the eccentric rod; but why not at once form it as a tooth, or a series of teeth, in the best manner to produce the movements required? Suppose the object be to cut off the steam at some part of the stroke by a slide or cock, then there must be two motions, the one double the length of the other. Let A B, Fig. 1 and 2. Plate ix. be the first, and B G the second, and from the centre D describe circles through these points; set off A E for the time to be expended in closing the passage to the condenser, and A F for the time of opening the passage for the steam; then, that the action may be easy, the curve H G should be drawn, so that each of its parts may be a parabola, the one with its vertex at H, that of the other at G.¹ To produce the second motion, another wheel should be placed on the same axis, behind the first one, with the curve I K. If these curves have corresponding ones, and act on connected rollers, the motion will be certain, and the range confined, and the motions of the engine may be made to reverse in the case of boat or carriage engines; for the position of the slide being changed by hand, the pressure of the steam will impel the crank shaft in the contrary direction, and the toothed wheel will move the slide or cock in the proper directions.

In order that the steam may be cut off at any period of the stroke, according to the resistance or the work on the engine, the wheel with the curve I K may be made to slide round on its axis, and the curve I K may be placed so that the period of cutting off the steam may be varied from N to O.

482. If valves are to be opened, the weight of the valves and rods is generally sufficient to close them; hence the rods do not require to be connected so as both to push and draw, but on the other hand a separate rod for each valve is required for a valve engine to work expansively,² and the toothed wheels or cams to move

¹ The best curve for generating motion from rest is the common parabola. See Emerson's *Mechanics*, 4to ed. prop. 91. case 3.

² From the nature of the motions of the valves, slides and cocks being incompatible with the

the rods will be placed with most advantage under the rods, as on the axis Z, Plate VIII. Fig. 1 and 2.

483. To apply the same principle to a reciprocating engine; let A B, Fig. 4, 5, Plate IX. be the plug tree, with the curve C D to act on the roller at C, which, as soon as the plug tree descends to C, begins to cause the roller frame to slide, and turn the axis E, so as to depress the slide rod by the arm F. The steam will be shut off by H I on the descending stroke, and by K L in an ascending one.

484. To regulate the period of cutting off the stroke, the portions containing the curves I H and K L may be made in two parts, to slide side by side by means of a screw; and if the rod having the screw upon it slides in a wheel acted upon by either a governor or other regulator, the engine will regulate itself. (See art. 554.)

485. In all cases an axis to be alternately moved in opposite directions should be balanced, and the stress of all heavy parts should be relieved by counterbalancing them by weights acting on levers. The hand gear should be a power proportioned to the force required to move the slides, cocks, or valves. (See art. 449.)

PISTON GUIDES.

486. The motion of the piston rod should be in a straight line in the direction of its length, and when the point it acts upon describes the part of a circle, the construction must be such that each may be confined to its proper motion, and yet the piston rod must produce the circular motion with as little oblique action as possible.

The most simple method is to confine the piston rod to its direction by means of a guide or guides, and to let it act on the part which moves in a circular direction by means of a connecting rod. To reduce the friction of the guides, rollers may be added. A very simple combination of this kind is shown in Plate XV. Fig. 1. A wheel or roller F is fixed on the piston rod D, and is confined to a vertical motion by the guides G G, and the motion is transmitted to the crank I by a connecting rod H H. When the fly is of sufficient power, the whole loss of force in this combination is simply the friction produced by oblique action, and

employment of the expanding force of steam in the engines of most makers, we infer that, Boulton and Watt's excepted, very few have availed themselves of this great source of economy. The proprietors of engines are too anxious about the power that an engine of a given sized cylinder possesses, forgetting that if an engine work with a minimum quantity of fuel, it must have a larger cylinder to do the same work. In estimating the comparative economy of engines, nominal power should not be considered, but the effect produced by each pound of fuel.

is less in proportion as the connecting rod is longer; provided the stress from weight be not materially increased.¹

CRANKS.

487. The crank is one of the best contrivances for changing a reciprocating into a rotary motion. There are three different cases:

1. The moving force may be uniform and in a straight line,
2. The moving force may be uniform and in a curved line,
3. In either case the force may be variable.

A crank increases the velocity of the moving force, and in the usual construction, in the ratio of the circumference of a circle to twice its diameter; but this ratio is susceptible of variation, as is also the action of the power. This will be evident from the annexed figure; as if A B be the motion of the piston rod, the crank

Fig. 22.

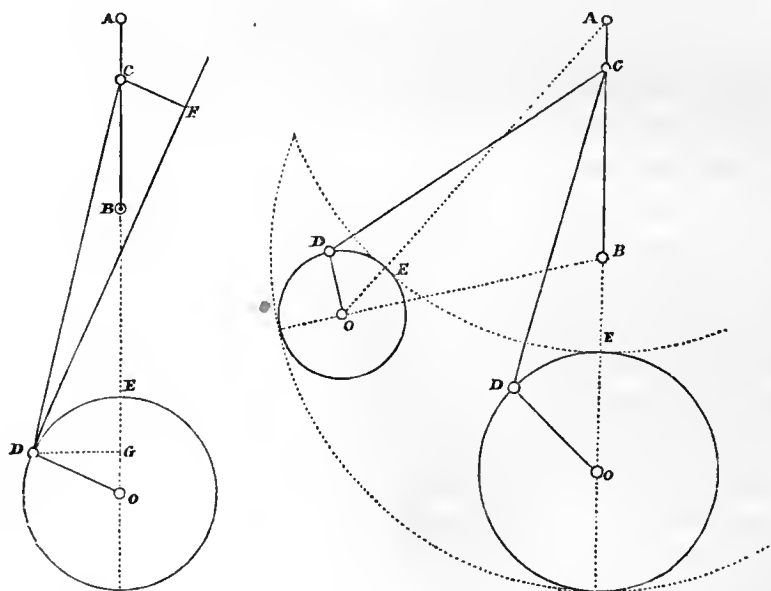

¹ The whole increase of stress required for converting a reciprocating into a rotary motion cannot double the friction on the crank axis in any case, and as double this friction never amounts to a tenth part of the power of an engine, there is no reason to hope for an equal degree either of economy or simplicity by using the rotary action of steam. (See art. 313—317. and the table, art. 487.)

may be any where in the lune represented by the dotted lines, and drawn from the centres A and B, with radii each equal to the length of the connecting rod. If we sum up the forces acting in the circle, we find them exactly equal to the mechanical power in the straight line, the additional friction excepted.

The following table is calculated for an uniform force acting in a straight line; the moving force in the straight line is supposed to be *unity*, and the table shows the pressure it produces in the direction of a tangent to the circle, at the quarters and at every thirty degrees of its path. It will enable the reader to judge of the effect of a variable force; and where the acting point describes a curve, it is less regular, but not so different nor so important as to require investigation: the last column is added to show the additional stress on the axis above that which would take place if the axis were turned by toothed wheels.¹

¹ When the moving force reciprocates in the straight line A B, and the end D of a connecting rod is moved round in a circle; let c be the angle D C O which the connecting rod forms with the direction A B of the motion, and α the angle D O E or arc described from E. The force in the direction of the connecting rod is $P \sec. c$, where P is the force when the rod is in the position A E. Also, since C F is parallel to O D, the $\angle O C F = \angle D O E = \alpha$, and consequently the $\angle D C F = c + \alpha$; therefore the force in the direction F D of the tangent to the circle = $P \sec. c \sin. (c + \alpha) = P \sec. c (\sin. c \cos. \alpha + \cos. c \sin. \alpha) = P \left(\frac{\sin. c}{\cos. c} \cos. \alpha + \sin. \alpha \right)$. But, when the connecting rod is n times the length of the crank, $\sin. \alpha = n \sin. c$, $\sin. c = \frac{\sin. \alpha}{n}$, and $\cos. c = \frac{\sqrt{n^2 - \sin.^2 \alpha}}{n}$; therefore,

$$P \sin. \alpha \left(\frac{\cos. \alpha}{\sqrt{n^2 - \sin.^2 \alpha}} + 1 \right) = \text{the circular force at D for any angle } \alpha.$$

The additional stress on the axis or shaft, and consequently the friction, is as

$$P \sec. c \cos. (c + \alpha) \text{ or } P \left(\cos. \alpha - \frac{\sin.^2 \alpha}{\sqrt{n^2 - \sin.^2 \alpha}} \right).$$

The additional friction (being about one-eighth of the pressure) is therefore never greater than $\frac{P a}{16 r}$; where a is the diameter of the shaft, and r the radius of the crank, both in inches.

By construction of the figure the values may be found from a scale of equal parts; for if C G be the pressure, F D will be the force in the circle, and C F the stress on the axis.

TABLE OF THE VARIATION OF ROTARY FORCE, WHEN A CRANK IS IMPELLED BY A CONSTANT FORCE.

Portion of the stroke described, the whole being 1.	Portion of circle described, in degrees from the beginning.	Length of the connecting rod, the length of the crank being 1.						Stress on the axis, when the connecting rod is 6 times the length of the crank.
		2	3	4	5	6	7	
0·000	0°	0·00	0·00	0·00	0·00	0·00	0·00	1·000
0·067	30	0·72	0·65	0·61	0·59	0·57	0·56	0·825
0·146	45	0·97	0·87	0·83	0·80	0·78	0·77	0·624
0·250	60	1·10	1·01	0·98	0·95	0·94	0·93	0·375
0·500	90	1·00	1·00	1·00	1·00	1·00	1·00	0·169
0·750	120	0·62	0·75	0·75	0·78	0·79	0·80	0·625
0·854	135	0·43	0·57	0·57	0·60	0·62	0·63	0·790
0·933	150	0·27	0·39	0·39	0·42	0·43	0·44	0·907
1·000	180	0·00	0·00	0·00	0·00	0·00	0·00	1·000

The length of the crank is supposed to be 1; and the table applies to any other length of crank, when the connecting rod is 2, 3, 4, 5, 6, or 7 times its length: the columns below these numbers show the rotary force corresponding to the positions indicated in the first and second column. The stress in the last column being greatest at each end, will have a tendency to wear the shaft into the form of an oval, having its longest diameter at right angles with the connecting rod.

PARALLEL MOTION.

488. The next method to be described for communicating motion from a piston rod to a beam is that called the 'Parallel Motion.' It was invented by Mr. Watt, who first gave a notice on the subject in 'Robison's Mechanical Philosophy;' and its theory has been since analytically investigated by Prony. We shall, by confining the enquiry to practical conditions, however, be able to treat it more briefly, and show how the best proportions for practice may be obtained.¹

There are two cases, which for simplicity we shall investigate separately, though they are generally both in use in the same engine.

489. FIRST CASE. If each of two bars A B, C D, Plates x. (A) and (B) Fig. 4. has an axis at one end, round which it moves, and the other end be connected with a third bar B D, by moveable joints; then there is a point E in the middle bar which will nearly describe a straight line. The rectilinear movement of the air-pump rod, in

¹ A patent for the protection of the Parallel Motion was taken out by Mr. Watt in 1784, and the invention was in 1787 applied in its most perfect form to the engines of the Albion Mills.

a steam engine, is often obtained by this method ; and as the motion is not perfectly rectilinear, it is desirable to determine the point which renders it most nearly so.

490. In any regulating apparatus of this kind, it is of considerable importance that the strains on the parts should not change their directions during the stroke ; and this condition being premised, we shall have less difficulty in forming them to act with regularity and certainty. The entire arcs described by B and D, in Plate x. (A) have their equal chords in the same vertical line bd ; and since the distance between the upper extremities and between the lower extremities of these chords is in each case equal to the length of the link B D, it is plain that the distance between the middles of these chords is also equal to the link ; that is, if A B, C D, were both horizontal, we should have $aD =$ the link B D, which evidently cannot be the case, as the link is in an oblique position at half stroke. The beam A B, and the radius bar C D, will however be both nearly in a horizontal position at the middle of the stroke ; and if the strain is not to change its direction, the connecting bar B D should not pass a vertical position at either termination of the stroke : and to limit it to this condition, we shall in Plate x. (A) suppose the bar, as shown by the dotted lines, to be exactly vertical, or coinciding with the direction of the piston rod at each end of the stroke.

Let A B and C D, Fig. 4. Plates x. (A) and (B) be the bars, B D the connecting rod, and E the point to which the piston rod is to be attached ; bd being the direction it is to move in. Put A B = ns , C D = ms , B D = l , and the length of the stroke of the piston rod s , which is equal to the chord of the arc described by the bar A B. Make the versed sine of that arc v , and the versed sine of the arc described by the end D of the radius rod = w . Then aB is the sum of these versed sines = $v + w$; and $v + w : v :: l : BE = \frac{vl}{v+w}$. But, by the properties of the circle, we have $s(m - \sqrt{m^2 - \frac{1}{4}}) = w$, and $s(n - \sqrt{n^2 - \frac{1}{4}}) = v$; therefore,

$$BE = \frac{(n - \sqrt{n^2 - \frac{1}{4}}) l}{(m - \sqrt{m^2 - \frac{1}{4}}) + (n - \sqrt{n^2 - \frac{1}{4}})}.$$

But we have very nearly $\sqrt{n^2 - \frac{1}{4}} = n - \frac{1}{8n}$, $\sqrt{m^2 - \frac{1}{4}} = m - \frac{1}{8m}$; and therefore $n - \sqrt{n^2 - \frac{1}{4}} = \frac{1}{8n}$, $m - \sqrt{m^2 - \frac{1}{4}} = \frac{1}{8m}$; consequently,

$$BE = \frac{ml}{m+n} \quad DE = \frac{nl}{m+n}.$$

$$\therefore BE : DE :: m : n :: CD : AB ;$$

that is, *the segments of the link are inversely proportional to the lengths, or radii, of the beams.*

When AB is equal to CD , the point E is in the middle of the length of the bar BD .

491. **RULE I.** With any proportion between the lengths of the bars AB and CD ; for instance, if $AB : CD :: n : m$. Then from the number n subtract half the square root of four times its square, less one, for a first number. Also from the number m subtract half the square root of four times its square, less one, for a second number.¹ Divide the first number by the first added to the second, and the quotient multiplied by the length, BD , of the link or bar, will give the distance of the point E from B .

Example. Let AB be to CD as $2 : 3$; then $2 \times 2 \times 4 = 16$, and $16 - 1 = 15$, of which the square root is 3.873 nearly, and its half is 1.9365 ; and $2 - 1.9365$ is $.0635$ for the first number. Next $3 \times 3 \times 4 = 36$; and $36 - 1 = 35$, of which the square root is 5.916 , and its half is 2.958 ; and $3 - 2.958 = .042$, therefore

$$\frac{.0635}{.0635 + .042} = .602 \text{ nearly.}$$

Hence the length of the link or bar BD , multiplied by the decimal $.602$, is the distance of the point E from B , or $BE = .602 BD$, when AB is to CD as 2 to 3 . Or if the point E be given, then BE divided by $.602$ will give BD , the length of the bar, link, or distance of the point of connexion D from B . The parallel motions of the engines in Plates x_i . and x_{ix} . are examples.

The following rule is much easier in its application, and equally good for ordinary purposes.

RULE II. Divide the link into two parts, having the same proportion to each other as the beams, placing the greater part next to the shorter beam.

This rule applied to the preceding example gives $BE = \frac{3}{2+3} BD = .600 BD$.

492. **SECOND CASE.** In this case, to a bar which moves on an axis at A , Fig. 5. Plates x . (A) and (B) conceive three shorter bars to be added to the end, so as to form with a part of the bar the parallelogram $BDGF$; and let another bar DC , which moves on a centre at its extremity C , be attached to the lower angle D of the parallelogram which is most distant from the centre C , round which the bar moves. Then the piston rod being attached to the other lower angle G of the parallelogram, its motion will be nearly rectilinear in the direction GH .

The purpose of rendering the stress in the same direction during the whole of the stroke would determine me to prefer the construction which renders the links BD , FG , vertical at both extremities of the stroke, as in Plate x . (A): this is not however the usual mode in practice, for the line of motion of the piston rod is

¹ These two numbers are the versed sines of the arcs described by the beam and radius bar, n and m expressing the radii.—Ed.]

commonly made to divide the versed sine of the arc, described by the end of the beam, into two equal parts, as in Plate x. (B.)¹

Let,

b = the length of the beam from the centre of motion, A F.

c = the length of the parallel bar D G.

r = the length of the radius bar C D.

s = half the length of the stroke.

v = the versed sine of the angle described by the radius bar.

α = half the angle described by the beam.

Assume that the radius bar is horizontal when the beam is horizontal; this cannot be strictly true, except when the vibration is bisected, but is generally very nearly so. Then, $(b - c) \sin. \alpha = \sqrt{2rv - v^2} =$ half the chord of the arc described by the end D of the radius bar. But $v = c(1 - \cos. \alpha)$; and substituting this value of v in the equation and squaring, it becomes

$$(b - c)^2 \sin. ^2 \alpha = 2rc(1 - \cos. \alpha) - c^2(1 - \cos. \alpha)^2;$$

and by reduction, observing that $\sin. ^2 \alpha = (1 - \cos. \alpha)(1 + \cos. \alpha)$,

$$r = \frac{b(b - 2c)}{2c} (1 + \cos. \alpha) + c,$$

which is a convenient formula for the radius bar when the angle is fixed; but when it is not, we have

$$r = \frac{b(b - 2c)}{2c} \left(1 + \sqrt{1 - \frac{s^2}{b^2}} \right) + c = \left(\frac{b}{2c} - 1 \right) \left(b + \sqrt{b^2 - s^2} \right) + c,$$

the length of the radius bar.

If the centre C of the radius rod should be fixed by necessity or convenience as in steam packet engines, let $h = CG$ its horizontal distance from the line traversed by the piston; then $c = r - h$, which substituted in the above, and again solved for r , we get,

$$r = \frac{\frac{1}{2} b^2 (1 + \cos. \alpha)}{h + b (1 + \cos. \alpha)} + h = \frac{\frac{1}{2} b (b + \sqrt{b^2 - s^2})}{h + b + \sqrt{b^2 - s^2}} + h,$$

in which the former term expresses the parallel bar G D; and h must be considered

¹ Tredgold has adopted the former construction in Plates xi. xix. and xx.: there can be no doubt, however, that almost every circumstance is in favour of the latter mode of adjustment, and that manufacturers have shown good judgment in adopting it. The bisection of the vibration certainly causes the strain to change its direction, but this is of little consequence, compared with the important advantage of rendering it of the least possible amount. Another advantage in this construction is, that the beam and radius bar are parallel to the horizon at half stroke; and that the radius bar, like the beam, works equally on both sides of it.—ED.

as negative in the calculation, when the radius bar is to be less than the parallel bar.

This expression, which will be found to be of important use in rectifying and adjusting the motions of old engines, and indeed in all cases where it may be necessary or desirable to have the radius bar to work from a stated centre, was first investigated in the valuable treatise on 'Mechanics for Practical Men,' by Messrs. James Hann and Isaac Dodds, (Newcastle, 1833,) a work in which mathematical theory and useful practice are combined throughout, with remarkable clearness and simplicity.

If the beam from the centre of motion to the point F be one and a half times the length of the stroke or $b = 3s$; then,

$$r = \left(\frac{3}{2} + \sqrt{2}\right) \frac{s(3s - 2c)}{c} + c = 2.9142 \frac{s(3s - 2c)}{c} + c.$$

In any case, except when the radius bar CD, and parallel bar DG are of the same length, the deviation is increased by increasing the quantity of angular motion of the beam. Hence, beams having short parallel bars should be limited in the extent of angular movement; indeed the motion should not in general exceed 20° , and this is very nearly the case when the distance of the end F of the beam from its centre of motion A, is to the length of the stroke as 3 : 2; in such case the radius bar may be found as follows :

493. RULE III. To find the length of the radius bar, when the length of the beam from the centre of motion is to half the length of the stroke, as 3 to 2. From three times half the length of the stroke subtract twice the length of the parallel bar, and multiply the difference first by the half length of the stroke, and then by the number 2.914. Divide the product by the length of the parallel bar, and the quotient added to the length of the parallel bar will be the length of the radius bar.

Example. Let the length of the stroke be 8 feet, its half 4 feet, and let the length of the parallel bar DG be 3 feet; then $3 \times 4 - 2 \times 3 = 6$; and $6 \times 4 \times 2.914 = 69.936$, which divided by 3 gives 23.312; add to this the length of the parallel bar 3 feet, and we have $23.312 + 3 = 26.312$ feet, for the radius bar CD.

A short parallel bar is assumed in this example, to show the great length of radius bar required in such a case.

The length of the links DB, GF, are from four to five-tenths of the length of the stroke, depending on convenience and space; but the longer they can be made, the less oblique strain will take place during the motion. The vertical distance

between the centres of motion of the beam and the radius bar should be nearly equal to the length of the links.

494. RULE IV. To find the length of the radius bar when there is no assigned proportion between the length of the stroke and the radius of the beam.

First, from the length of the radius of the beam, divided by twice the length of the parallel bar, subtract *unity*.

Secondly, Find the square root of the difference between the square of the radius of the beam, and the square of the half length of the stroke, and add this root to the radius of the beam.

Thirdly, Multiply together the numbers so found, and the product added to the length of the parallel bar will be the length of the radius bar.¹

Example. Let the radius of the beam A F be 12 feet, the length of the stroke 6 feet, and the length of the parallel bar D G, 5 feet. Then the first operation is,

$$\frac{12}{2 \times 5} - 1 = 1.2 - 1 = 0.2.$$

By the second operation, the square of 12, less the square of 3, is $144 - 9 = 135$, of which the square root is 11.62, and $12 + 11.62 = 23.62$.

Hence,

$$\text{Radius rod} = 23.62 \times 0.2 + 5 = 9.72 \text{ feet.}$$

This calculation may be much simplified in the following manner. Join A G meeting D B in E; then since D B, G F, are always parallel during the motion, we have $A E : A G :: A B : A F$, an invariable ratio; consequently, if E describes a straight line, G will also describe a straight line. But it has been shown that E will very nearly describe a straight line when the segments D E, E B of the link are inversely as the radii C D, A B, or when

$$D E : E B :: A B : C D.$$

But by similar triangles, $D E : E B :: D G : A B \therefore D G : A B :: A B : C D$, and,

$$C D \cdot D G = A B^2 \text{ or } C D = \frac{A B^2}{D G} = \frac{A B^2}{B F}.$$

¹ Where great accuracy of motion is required, diminish in all cases the length of the stroke by its one-sixth part, before it is used in any of the calculations where it is introduced. This preparation will reduce the deviation from a straight line to the least possible amount.—ED.

Hence this rule :—

RULE V. The link divides the beam into two parts : divide the square of the length of the central part by the length of the extreme part, or the length of the parallel bar, and the quotient will be the length of the radius bar.

This rule applied to the preceding example gives the radius bar $= \frac{7 \times 7}{5} = \frac{49}{5} = 9.80$ feet, which differs only 0.08 from the other calculation.

When convenience requires the rod to be attached to some other point between D' and B, as in Fig. 1. it is still only necessary to make the radii inversely as the segments D E, E B of D B, as in the preceding proportion, viz.

$$D E : E B :: A B : C D,$$

since the track of G must be similar to that of E.

And it may be observed, that as this ratio approaches to a ratio of equality, the more accurate will be the motion, particularly if the beam and bars be fitted parallel at half stroke ; so that the line of the piston rod may bisect the versed sine of the half arc described by the end of the beam, or the horizontal distance through which it vibrates.

The calculation may be differently conducted by supposing A F' to be the radius of the beam, G' F' to be the extreme link or connecting rod, the other link D B to remain unaltered, and supposing the piston to work from the point G'. For on these suppositions the point G' will obviously describe a path exactly similar to that of the point G ; hence we may proceed and calculate the length of the radius bar C D, according to the common rules ; and this method has the advantage of taking into account the length of the stroke if required.

With this arrangement, which is used for boat engines, the parallel bar may be attached from the point D, and as is shown in Plate x. (B), Figs. 10 and 11, to which the above reasoning equally applies, the piston rod will then be attached to a point G, in the connecting bar F H produced. In fact, the parallel bar may evidently be fixed to the connecting bars at any distance from the beam, without affecting the motion or the calculation of the parts : strength and convenience are the principal considerations for its regulation. Suppose Fig. 8, the parallel bar G D to be continued to *m*, so that its length G *m* may be equal to the radius of the beam ; and the extremity *m* to be connected to a bar A *m* equal and parallel to B D and F G. Then it is plain, that during the motion the point *m* will oscillate over the small arc *m n*, centre A, of which the horizontal chord *m n* is equal to the versed sine of the arc, described by the extremity of the beam. Let the combination be now divested of the beam A F, and connecting bars B D, F G ; let the bar A *m* still work from the fixed centre A,

and suppose Gm now to represent the beam; then, inverting the figure, we shall have the usual motion by means of the VIBRATING PILLAR, and hence the preceding rules may be applied to the calculation of this motion.

If AB be retained as a parallel bar, and BD as a connecting bar, the point E may then be employed for a pump rod, as in the particular case of Fig. 9.

Figs. 12 and 13 exhibit a very simple motion, by which the number of parts is diminished, and two diagrams are given to show that any length of radius bar may be used for such motion, provided the link be properly apportioned.

495. When the proportions to obtain parallel motion have been found by the preceding rules, the point for the air-pump rod in the link DB is easily found by drawing a line from G to A , as in several figures, and then the rod must be attached to the point of intersection. Its distance from the point B may be calculated by the proportion,

$$AF : FG :: AB : BE = \frac{AB \times FG}{AF}.$$

Thus if AF be 12 feet, FG 3 feet, and AB 7 feet; then $\frac{7 \times 3}{12} = 1.75 = BE$.

In like manner, for any complex case, as in Woolf's engine with two cylinders, the points of connexion for the piston rods must all be in the line AG , as is shown in some examples in the plates; or the point for the air-pump rod being found by the rule, (art. 491.) the point for the piston rod may be ascertained by drawing a line through the points AE , Fig. 4. Plate x. (A) till it cuts the line in which the piston rod is to move at G ; then draw GF parallel to the link BD , and GH parallel to the beam, and $BFGH$ are the moveable points of the parallelogram, and G the point to which the piston rod should be connected. The calculation and construction of the parallel motion adopted for steam boat engines, Figs. 1. may be conveniently solved by the methods before described.

TO FIX THE RADIUS BAR. The line of the piston must be first made to bisect the versed sine of the arc described by the end of the beam. Plumb the piston rod when at the top extremity of its stroke; then the radius bar being moveable about D , with the other end C describe a circular arc. Bring the piston down to the lowest extremity of the stroke, again plumb the piston rod, and in the same manner describe another arc intersecting the former. The point of intersection will evidently be the centre upon which the end C of the radius bar is to move.

The *length* as well as position of the radius bar may be similarly ascertained by geometrically finding the positions of the point D respectively at the top extremity, at half stroke, and at the bottom extremity; and then describing a circle through the three points so found.

If great accuracy be required, it will be better to take the positions within each extremity by about one-sixth of the half stroke, the note, page 235, being previously followed in the calculation of the parts.

TO FIND THE LENGTH OF THE CONNECTING ROD. Set the beam at half stroke, that is, parallel to the horizon; then the distance between the centre of the pin on which the connecting rod is to move and the centre of the shaft, is the length of the connecting rod.

In concluding this part of our subject we may further observe, that a considerable increase of accuracy in the motion will be obtained by the adoption of the expedient recommended in the note of page 230, in each calculation where the length of the stroke is taken into account; and this will be an advantage of some importance in the construction of large engines. According to Rules II. and V., if the beam and radius bar be adjusted parallel to the horizon at half stroke, and the vibration of the beam bisected, the *direction of the motion* of the point G where the piston is connected will be *precisely vertical at half stroke*, and its deviation will take place, alternately right and left, towards each extremity of the stroke. By Rules I. and IV. the *three principal positions* of the point G, viz. at the two extremities and at half stroke, will be *precisely in a vertical straight line*, and its deviation will take place, on alternate sides, between the middle and each extremity. Thus in the adjoining diagram, if the beam and radius bar be fixed parallel at half stroke, G G G G, Fig. 1. represents the form of curve described when calculated by Rule II. or V.; but when the radius bar is properly fixed as directed, the point G will coincide with the line at each extremity, and at another point not exactly but nearly at half stroke, and at half stroke the bars will not in this case be exactly parallel.

Also Fig. 2. shows the curve according to Rule I. or IV.; but if the half length of the stroke be diminished by its one-sixth part previously to the calculation of the rule, the position of the curve described will be as represented in Fig. 3., in which the intersections occur at the middle and one-sixth of the half stroke from each extremity. These rules will cause the bars to be precisely parallel to the horizon at half stroke, and may be fixed in this way, or, perhaps more conveniently, adjusted by the method before described.

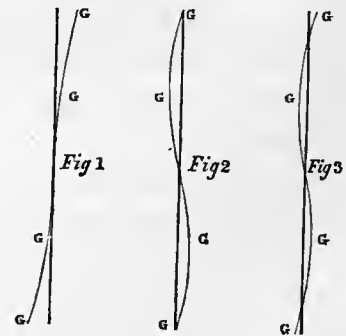

OF THE STRENGTH OF THE PARTS OF STEAM ENGINES.

496. In considering this important branch of my subject, I propose to follow the most simple methods I can devise, and those most readily applied in practice. The foundation of the inquiry must be the power of the steam in the boiler, or rather the greatest power it can possibly acquire without escaping at the safety valve. Now since there is always a risk of the safety valve not being in perfect order, we may in a great degree provide against such risk, by taking the load on the valve at double the actual load upon it. Thus, if the load on the valve be 8 lbs. on a circular inch, consider it 16 lbs.; and 16 lbs. added to 11·5 lbs., the pressure of the atmosphere, will give 27·5 lbs. for the strength of the steam, or the pressure which must cause the machine to move backwards.

497. In the case of steam boats, a greater degree of surplus of strength ought to be provided, because accidents at sea are attended with more serious consequences; and I would recommend all good machinery to be regulated by the following rule: it is, to add the load per circular inch on the safety valve to the pressure of the atmosphere, and to take double this quantity as the utmost force of the steam: that is, if the load on the safety valve be 8 lbs. on a circular inch, let this be added to 11·5, the pressure of atmosphere, the sum is 19·5, and double this is 39 lbs. per circular inch, for the possible pressure on the piston.

If the parts be formed to resist this pressure, then, in the case of the machinery being impelled backwards by an excess of resistance, they will not be injured by it, except where the momentum of a heavy fly wheel renders it necessary to provide a resistance to impulsive force.

498. The datum for the resistance of the material must be the strain it will bear without a permanent derangement of its parts; and this strain is about one-third of its cohesive force.¹

499. In respect to the effect of the friction of an engine, it ought to be added to the power in estimating the strength; because when the resistance is capable of reversing the motion of the engine, it also must have to overcome the friction of the intermediate parts; but when the force of the steam is considered double its whole pressure, as limited by the safety valve, the friction may be neglected.

500. The stress on any of the moving parts of a steam engine may be most easily found by comparing the number of revolutions or vibrations it makes for each double stroke of the piston: the stress is inversely as the number of revolutions or vibrations multiplied by the diameter of the circle, or the chord of the arc described by the point where the force acts: thus if a wheel 4 feet in diameter makes three revolutions while the piston makes one stroke, and the length of the

¹ See Practical Essay on the Strength of Cast Iron, &c. sect. v. Second edition.

stroke be 5 feet ; then $4 \times 3 : 5 ::$ pressure on the piston : stress on the teeth of the wheel, equal five-twelfths of the pressure on the piston. The stress thus found is to be considered as a weight applied at the point to which the motion belongs.

In like manner, the period of the motion of the working point of any machine may be considered unity ; and by comparing the chords of the arcs described in the same time, and the revolutions in the same period, the stress may be found in terms of the force required to overcome the resistance at the working point.

501. The method to be followed in determining the strength, is, when there is only one working point to proceed from the engine, taking its power as the measure of the stress at every point, and to make the part so that it shall be sufficiently strong to bear a reversion of the motion ; but if the power of the engine be divided among various trains of machinery, then its power should be the measure of strength only to the point where the trains branch, and for each separate train the greatest possible stress at the working point should be made the measure of the strength of its parts.

502. The advantage of reasoning by general formulæ is so great, that it will be adopted, and the rules as they arise given in words at length with examples.

Let,

D = the diameter of the piston in inches,

L = the length of its stroke in feet,

P = the double of the whole elastic force of the steam in the boiler, in lbs. per circular inch.

l = the length from the centre of motion to the centre of stress in feet,

a = the depth or diameter,

b = the breadth in inches ;

f = the cohesive force of a square inch at the point of alteration, and

R = the radius of any wheel.

Then the force on the piston is $D^2 P$ in lbs.

503. STRENGTH OF RODS WHERE THE STRAIN IS WHOLLY TENSILE. There is in every case of this kind a possibility of the strain deviating one-sixth of the diameter of the rod from the axis, and when it does so the resistance is,

$$\frac{a^2 f}{2 \times 1.27} = \frac{a^2 f}{2.5} \text{ nearly ;}$$

$$\text{consequently, } D^2 P = \frac{a^2 f}{2.5}, \text{ or } a = D \left(\frac{2.5 P}{f} \right)^{\frac{1}{2}}$$

For malleable iron $f = 17800$, consequently,

$$a = \frac{D}{84} \sqrt{P}.$$

This rule applies to rods subject to a tensile strain only : such are piston rods of single acting engines ; pump rods.

For head links it becomes,

$$\frac{D^2}{84} \sqrt{P} = b t = \text{the breadth multiplied by the thickness in inches.}$$

504. RULE. Multiply the diameter of the steam piston in inches, by the square root of twice the elastic force of the steam in the boiler, in lbs. per circular inch, and the product divided by 84 is the diameter of the rod in inches.

Example. If the force of the steam be 16 lbs. per circular inch, and the diameter of the cylinder 54 inches, then the square root of 32 is 5.657, and

$$\frac{54 \times 5.657}{84} = 3.6 \text{ inches, the diameter required.}$$

For the atmospheric pressure it is one-sixteenth of the diameter.

505. OF THE STRENGTH OF RODS ALTERNATELY EXTENDED AND COMPRESSED. In the compression of rods the force increases with the flexure; but if the length never exceed about thirty-six times the diameter, its error will be very small to assume that degree of flexure; and by taking in addition the greatest possible deviation, from misfitting, which is half the diameter of the rod,¹ with this simplification we have

$$D^2 P = \frac{a^2 f}{8.75} \text{ nearly, or } a = D \left(\frac{8.75 P}{f} \right)^{\frac{1}{2}}.$$

For cast iron $f = 15300$, and $a = \frac{D}{42} \sqrt{P}$.

For malleable iron $f = 17800$, and $a = \frac{D}{45} \sqrt{P}$.

For tempered steel $f = 45000$, and $a = \frac{D}{72} \sqrt{P}$.

This rule applies to piston rods of double engines, parallel motion rods, air pump and force pump rods, and the like; and if P be increased in the ratio of the radius to the sine of the greatest angle a connecting rod makes with the direction, it applies to connecting rods.

506. RULE. Multiply the diameter of the piston in inches by the square root of twice the pressure of the steam in lbs. on a circular inch, and divide the product by,

42 for cast iron,
45 „ wrought iron,
72 „ tempered steel;

the quotient will be the diameter in inches.

Example 1. The force of the steam being 16 lbs. per circular inch, and the diameter of the piston 80 inches, that of the piston rod should be, for wrought iron,

$$\frac{80 \times \sqrt{32}}{45} = 10.06 \text{ inches.}$$

Example 2. The force of the steam being 4 atmospheres = 46 lbs. per circular

¹ Practical Essay on Cast Iron, art. 246.

inch, and the diameter of the cylinder 11 inches, the diameter of a piston rod of wrought iron should be,

$$\frac{11 \times \sqrt{92}}{45} = 2.34 \text{ inches.}$$

If the rod be of steel, then the diameter should be,

$$\frac{11 \times \sqrt{92}}{72} = 1.46 \text{ inches.}$$

Example 3. The force of the steam being 16 lbs. per circular inch, and the diameter of the piston 24 inches, the diameter of a cast iron connecting rod should not be less than,

$$\frac{24 \times \sqrt{32}}{42} = 3.23 \text{ inches.}$$

The middle is commonly expanded into a form of greater lateral strength; and in all cases should be of larger diameter than the ends, in the proportion of about one-tenth.

507. For air pump rods, the pressure of the atmosphere and the diameter of the pump must be taken, instead of the force of the steam and the diameter of the cylinder. Parallel motion rods should be three-sevenths of the diameter of the piston rod, except in the case of that for steam boat engines, when there is lateral stress. Connecting rods for giving motion from the cross-head to beams, or to cranks, should be seven-tenths of the diameter of the piston rod.

508. OF THE STRENGTH OF ARMS OF BEAMS, CRANKS, &c. It may be assumed as a principle, that a beam of uniform thickness should not be of less thickness than one-sixteenth of its depth, otherwise it is liable to overturn; besides, in cast iron it is not safe to trust the strength of a casting, which is not a sixteenth part of its depth in thickness. Now for the case, when the velocity is the same as that of the piston $D^2 P l = 212 b a^2$,¹ and when $16 b = a$, and $12 l = n D$, it becomes for cast iron

$$a = D \left(\frac{\frac{4}{3} P n}{212} \right)^{\frac{1}{2}}.$$

That is, when D = the diameter of the piston in inches, and d = the depth of the beam in inches, the breadth one-sixteenth of that depth, n the number of times the diameter is contained in the length from the centre of motion to the point where the force is applied, and P double the force of the steam in the boiler, in lbs. per circular inch. The depth at the end should be half the depth at the centre of motion, and the breadth uniform; and an access of strength may be given by forming the section, so as to increase the thickness at the edges to one-ninth of the depth, or till the parts between be reduced to the thickness of one-sixteenth of their width.

¹ Practical Essay on Strength of Iron, art. 116.

For wrought iron use 240 instead of 212, and for wood 64.

509. **EXAMPLE 1. BEAMS.** An engine beam is 3 times the diameter of the cylinder, from the centre to the point where the piston rod acts on it, the force of the steam in the boiler is 14 lbs. per circular inch, its double is 28, and the diameter of the piston is 24 inches. In this case,

$$a = D \left(\frac{\frac{4}{3} P n}{212} \right)^{\frac{1}{3}} = D \left(\frac{\frac{4}{3} \times 28 \times 3}{212} \right)^{\frac{1}{3}} = \cdot 81 D;$$

or $a = 19\cdot 4$ inches, and the mean breadth is $1\cdot 21$ inches, and the breadth at top and bottom $2\cdot 16$ inches.

If of wrought iron with the same proportions, $\cdot 78 D = a$, and the breadth = one-sixteenth of the depth.

Of wood with the same proportions, $\cdot 78 D = a$, but the breadth = one-fourth of the depth.

510. **CRANKS.** A crank should embrace a shaft, so that its depth at the shaft should be $1\cdot 5$ times the diameter of the shaft; hence, if $S D$ be the diameter of the shaft, the depth of the crank must be $1\cdot 5 S D$, but since (art. 508.) $D^2 P l = 212 b a^2$, we have

$$b = \frac{P l}{2\cdot 25 S^2 \times 212} = \frac{P l}{477 S^2}$$

EXAMPLE 2. A crank shaft is equal in diameter to $\cdot 31$ times the diameter of the cylinder, and the force of the steam in the boiler being 14 lbs. per circular inch, or $P = 28$ lbs., required the breadth of the crank at the shaft, its radius being $2\cdot 5$ feet. In this case,

$$b = \frac{P l}{477 S^2} = \frac{28 \times l}{477 \times \cdot 31^2} = \cdot 6 l, \text{ in inches;}$$

and as $l = 2\cdot 5$ feet, it is $\cdot 6 \times 2\cdot 5 = 1\cdot 5$ inches, and the depth is $1\cdot 5 \times \cdot 31 \times 30 = 14$ inches.

511. **WHEEL ARMS.** The arms of wheels may be considered in respect to strength only; and if the rim be of equal strength, then a wheel should have six arms in all cases, when it is of sufficient magnitude to require its strength to be found by rule. With this condition we have $2 D^2 P R = 212 \times 6 b a^2$, or $D^2 P R = 3 \times 212 b a^2$. If we consider the arms to be one-third of the breadth of the wheel, and allow, as excess of strength, that which is added to give it lateral strength, then

$$\frac{D^2 P R}{212} = b a^2, \text{ or } a = D \sqrt{\frac{P R}{212 b}}$$

When R the radius = 1, and $P = 28 =$ twice the force of the steam in the boiler, then

$$a = \frac{D}{\sqrt{7 b}}$$

as inserted along with the proportions of teeth in the table, art. 513.

512. The teeth of wheels will be most conveniently given in a tabular form, with a correction for curvature in determining their breadth, which is not included in the formula in my treatise on cast iron. The first column shows the stress on the teeth in lbs.; the second, the horse power nearly equivalent, when the velocity is three feet per second; the third column, the pitch; the fourth, the thickness; and the fifth, the breadth of the teeth: the sixth column shows the greatest depth of the middle of the arm at the base in the direction of the wheels' motion, when that part is one-third of the breadth of the teeth, and the radius is one foot; hence, being multiplied by the square root of any other radius in feet, it will be the depth for it; the seventh column shows the breadth of the rib which strengthens the arm; and the eighth, the diameter of a cylinder, when the force of the steam is thirty-five inches of mercury in the boiler, and the teeth move at the same velocity as the piston. For any other velocity the stress will be found by art. 500.

513. A TABLE OF THE STRENGTH, &c. OF TEETH AND ARMS FOR WHEEL WORK.

Stress in lbs.	Horse power at 3 feet per second.	Teeth of Wheels.			Wheel with 6 arms.		Diameter of the cylinder for low pressure steam,—teeth moving at the same velocity as the piston,—in inches.
		Pitch in inches.	Thickness in inches.	Breadth in inches.	Depth of arm for 1 foot radius, in inches.	Breadth of rib in inches.	
22	0.25	0.25	0.119	0.75	0.87	0.25	2.0
85	0.5	0.50	0.238	1.25	1.24	0.42	3.7
191	1	0.75	0.357	1.75	1.67	0.60	5.5
337	2	1.00	0.475	2.50	1.76	0.80	7.4
520	3	1.25	0.590	3.00	2.00	1.00	9.2
800	4	1.50	0.730	4.00	2.20	1.30	11.3
1040	5	1.75	0.835	4.25	2.40	1.40	12.9
1370	7	2.00	0.955	5.00	2.50	1.70	14.8
1720	9	2.25	1.070	5.50	2.70	1.80	16.6
2100	10.5	2.50	1.190	6.00	2.85	2.00	18.4
2560	13	2.75	1.310	6.75	3.00	2.20	20.3
3000	15	3.00	1.430	7.25	3.20	2.40	22.2
3600	18	3.25	1.550	8.00	3.30	2.60	24.0
4150	21	3.50	1.670	8.50	3.40	2.80	26.0
4800	24	3.75	1.790	9.25	3.50	2.90	28.0
5700	27.5	4.00	1.910	10.25	3.60	3.40	29.5
6300	31.5	4.25	2.025	10.50	3.70	3.50	31.5
6900	34.5	4.50	2.150	11.00	3.80	3.70	33.3
7700	38.5	4.75	2.270	11.75	3.90	3.90	35.0
8500	42.5	5.00	2.390	12.25	4.00	4.00	37.0

514. The strength of beam gudgeons may be determined by the rule, $P D^2 = 854 a^2$.¹

It reduces to,

$$a = \frac{D \sqrt{P}}{30};$$

and the length should not be less than eight-tenths of the diameter. For low pressure steam, twice its force is 28 lbs. per circular inch, or $P = 28$, and therefore in that case one-sixth of the diameter of the cylinder should be that of the gudgeon. For pins for connecting rods where the bearing is double, the stress is reduced one-half, and

$$a = \frac{D \sqrt{P}}{43}.$$

Or in the case of low pressure steam,

$$a = \frac{D}{8}.$$

515. THE STRENGTH OF SHAFTS. The shafts are supposed to be supported so as to render the lateral stress as small as possible, then the resistance to twisting alone has to be considered, and as no part of the shaft should be less than the bearings or journals, therefore allowing one-sixth for wear $R D^2 P = 960 a^3$;² when the shaft revolves in the same time, the piston makes a double stroke, and if the radius $R = n D$, we have

$$a = D \left(\frac{n P}{960} \right)^{\frac{1}{3}},$$

for the diameter in inches.

If it revolve N times while the piston makes a double stroke, then (art. 500.) we have,

$$a = D \left(\frac{n P}{960 N} \right)^{\frac{1}{3}}.$$

For wrought iron the divisor should be 1080 instead of 960.

Example. What should be the diameter of a shaft of cast iron, when the crank arm is equal to the diameter of the cylinder, double the force of the steam in the boiler 28 lbs. per circular inch, the piston 30 inches in diameter, and one revolution of the shaft made in the same time as a double stroke? In this case n and N are each = 1, and,

$$a = D \left(\frac{P}{960} \right)^{\frac{1}{3}} = D \left(\frac{28}{960} \right)^{\frac{1}{3}} = 0.31 D, \text{ in inches,}$$

$$\text{or } a = 0.31 \times 30 = 9.3 \text{ inches.}$$

¹ Essay on Strength of Iron, art. 139.

² Essay on Strength of Iron, art. 224. R being in this case in inches.

OF THE STRENGTH OF PIPES AND WORKING CYLINDERS.

516. The thickness for pipes and cylinders of solid metal is more frequently determined by the condition, that the castings may be sound and perfect, than by a regard to strength; yet it is necessary to show the proportions essential for strength, that a mistake in this respect may not occur.

The data required are the tensile strain a square inch of the metal will bear without permanent alteration at the proposed temperature, the pressure of the steam on a circular inch including such allowance as is proper for the risk of increase, and the diameter of the cylinder. I advise to take double the whole force of the steam when it escapes at the safety valve of the boiler.

We may safely consider the cylinder to be of equal resistance throughout its length; and hence, if we take the stress upon an inch of that length, that stress will be equal to the diameter in inches, multiplied by the greatest possible force on a square inch, and the resistance will be twice the thickness of the cylinder, by one-fourth of the limit of tensile strain of the metal, the tension being considered to be unequal on the resisting part. Thus we have the following rule.

517. RULE. For the thickness of solid metal, pipes, or cylinders to bear a given stress, the whole being of an equal temperature:—

Multiply 2·54 times the internal diameter of the cylinder, by the greatest force of steam on a circular inch; divide by the tensile force the metal will bear without permanent alteration, the result is the thickness in inches.

Example. To determine the thickness of a cast iron cylinder, 60 inches diameter, for a pressure not exceeding 3·2 lbs. per circular inch, in addition to the atmospheric pressure. In this case twice the force is 30 lbs. on the circular inch, and the resistance of cast iron is 15,000 lbs. per square inch; hence,

$$\frac{2\cdot54 \times 60 \times 30}{15000} = 0\cdot305 \text{ inches.}$$

518. Were there the direct force alone to consider, we see that a very thin cylinder or pipe is sufficient, but the pressure is often aided by a powerful strain from unequal expansion. If e be the extension the metal will bear without alteration, and t its thickness, a being the diameter of the pipe, we have

$$\frac{t}{2} : e :: a : \frac{2ea}{t},$$

the greatest quantity which the expansion of one side of the pipe should exceed the other, = $h\epsilon$, when h = the excess of heat, and ϵ = the expansion for one degree.

In cast iron, $e = \frac{1}{1200}$, and $\epsilon = \frac{1}{162000}$; hence,

$$h = \frac{270 a}{t},$$

the increase which would strain the metal as far as it would bear without permanent derangement.

519. Here we suppose the heat to be confined to a single point; but generally, or rather in all cases, a considerable portion of surface is directly affected by the heat: in this case a near approximation will be to double the effect of expansion, or make,

$$h = \frac{135 a}{t}.$$

In the case of pipes and cylinders, the greatest difference of temperature will never exceed 300° ; and then,

the force of cohesion the cylinder loses by unequal expansion = $\frac{300 t}{135 a} = \frac{2.2 t}{a}$.

If this be added to the former, we derive,

$$t = \frac{2.54 a p}{15000} + \frac{2.2 t}{a}; \text{ or } t = \frac{a p}{6000} \left(\frac{a}{a - 2.2} \right).$$

The effect of irregular expansion is sensible only in small cylinders: in the case of a cylinder of 60 inches diameter we found its thickness .305 inches, and it became only .315 when corrected for expansion.

For pipes of *less than 5 inches diameter*,

$$t = \frac{a p}{6000 (1 - 0.116 a)}.$$

For working cylinders both wear and other causes of pressure exist; the latter will require at least that the thickness should be double, and for wear half an inch may be added, as about the proper quantity of allowance.

520. RULE. For the thickness of a working cylinder. Multiply four times the elastic force of the steam in lbs. per circular inch by the diameter in inches, and divide by 6000. The result multiplied by the quotient arising from dividing the diameter by the diameter less 2.2, is the thickness for strength, to which half an inch may be added for wear.

Example 1. A cylinder 24 inches in diameter is to be made of cast iron, for steam not exceeding $3\frac{1}{2}$ lbs. per circular inch on the safety valve, or $11.5 + 3.5 = 15$ elastic force, required its thickness.

$$\text{We have } \frac{15 \times 4 \times 24}{6000} = .24; \text{ and } \frac{24}{24 - 2.2} \times .24 = .264;$$

which, added to half an inch, is .764 inches, the thickness required.

Example 2. A cast iron cylinder for a high pressure engine being 9 inches in diameter, and for steam 50 lbs. per circular inch elastic force, required the thickness.

In this case, $\frac{4 \times 50 \times 9}{6000} = \cdot 3$; and $\frac{9}{9 - 2 \cdot 2} \times \cdot 3 = \cdot 4$;

to which adding $\cdot 5$ for wear, it is $0 \cdot 9$ inches.

521. *Of the strength of flat plates to bear the pressure of steam, or other elastic fluids.* The strength of a plate is limited by the curvature it takes by the strain; and when the length and breadth are equal, the resistance is the same in both directions; but in any other case the two flexures do not correspond, and the resistance depends chiefly on the curvature in the shortest direction of support.

From the laws of deflexion it will be $l^2 : b^2 :: 1 : \frac{b^2}{l^2}$, the resistance in the longitudinal direction; and $1 + \frac{b^2}{l^2}$, multiplied by the resistance in the shorter direction, gives the whole resistance.

When a plate is fixed at the edges, the flexure lessens the quantity of strain on the resisting part, but only in a small degree; and in bending to the new position, the inner part of the matter must be partially compressed, and the resistance to tension will extend only to a little more than half the thickness, and varies as the distance from the neutral line: hence it is only one-fourth of tf , when one-fourth of the thickness is an inch, t being the whole thickness, and f the cohesive force of a square inch; and allowing for riveted plates,

$$\frac{tf}{4} \times \frac{2}{3} = \frac{tf}{6} = \text{the resistance in one direction};$$

$$\text{and } \left\{ 1 + \left(\frac{b}{l} \right)^2 \right\} \frac{tf}{6} = \text{the whole resistance.}$$

The stress is as the force on a given portion of the curve, resolved into its tendency to split the material. If z be a part of the curve, and r the radius of curvature,¹ we have $z : r :: 1 \cdot 27 p z : 1 \cdot 27 p r$, the stress, p being the pressure

¹ But the curvature is limited by the stretching and bending in the shorter direction; suppose it to be wholly by bending, and we have,

$$e : 1 :: \frac{t}{2} : r = \frac{t}{2e};$$

therefore in this case,

$$\frac{1 \cdot 27 p t}{2 e} = \left\{ 1 + \left(\frac{b}{l} \right)^2 \right\} \frac{t f}{6},$$

$$p = \frac{\left\{ 1 + \left(\frac{b}{l} \right)^2 \right\} f e}{3 \cdot 8}.$$

Hence we find, that the resistance of a plate is quite independent of its thickness when it bends

on a circular inch; hence,

$$1.27 p r = \frac{t f}{6} \left\{ 1 + \left(\frac{b}{t} \right)^2 \right\},$$

$$\text{or } t = \frac{7.62 p r}{f \left(1 + \frac{b^2}{t^2} \right)}.$$

In square or circular plates it becomes

$$t = \frac{3.81 p r}{f}.$$

For wrought iron, $0.006 r = t$ when low pressure steam is to be confined, and both r and t are in inches; when the length is great compared with the breadth, or the bounding edges are not properly confined in one direction, double the result.

OF THE EXCESS OF STRENGTH TO RENDER BOILERS SAFE.

522. The pressure tending to separate a boiler is about proportional to the load on the safety valve; that to crush it together is equal to the pressure of the atmosphere. In the latter case it cannot exceed that pressure; in the former a considerable excess may take place if any derangement happens to the valves; and it is to provide against accident, in the event of the valves being out of order, that an excess of strength in the boiler is necessary.

It is clearly a matter of opinion, founded on the experience of past accidents, as to the degree of excess required, and it has been almost universally allowed, that three times the pressure on the valve in the working state should be borne by the boiler without injury.

This degree of excess of power seems to be fully sufficient for the ordinary low pressure steam boilers; indeed, I should think twice the pressure a proper allow-

in this manner, but that the pressure is limited.

For wrought iron, $f = 17800$, and $\epsilon = \frac{1}{1400}$; hence $\frac{f \epsilon}{3.81} = 3.33$; and therefore we have,

$$3.33 \left\{ 1 + \left(\frac{b}{t} \right)^2 \right\},$$

for the greatest stress in lbs. on a circular inch that a plate will bear.

When the plate is either square or circular, it becomes 6.85 lbs. per circular inch, = 8.5 lbs. per square inch. When of other proportions, as in the equation, and when the length is very considerable, it becomes simply 3.33 lbs. per circular inch, or 4.25 lbs. per square inch.

Copper bears about the same strain.

This is important, as it shows us that flat surfaces cannot be used with safety to confine high pressure steam.

ance, and were it always provided, there would be little chance of accident if the valves be properly constructed and attended to.

It becomes insufficient in high pressure boilers, because a common low pressure boiler contains about ten times the volume of steam required for one stroke of the engine, consequently the time of twenty strokes must elapse before the density of the steam could accumulate to three times its working density, supposing the engine to be stopped, and the valve out of order; but if the boiler contains only as much steam as is required for one stroke, the force will be increased to three times in the time the engine would have made two strokes. This rapidity of the increase of force does not leave the necessary time to examine, nor even to open the valves in this extreme case, and the hazard must be greater in consequence. In all cases the time of accumulating power should not be shorter than it is in the common boiler. Besides, in working an engine where the excess of force increases so fast, the loss of steam would be considerable from any variation of the heat of the fire, even were the valve to act properly, and therefore there is a temptation to load the valve beyond its regular weight. To render the security on the stoppage of the engine equal in all cases, the excess of strength should be inversely as the space allowed for steam.

It is still more important to consider the subject, in relation to the danger arising from unequal action of the fire; and for this the excess of strength should be inversely as the contents of the boiler expressed in units of the power.

Thus, taking the horse power as the measure, if one boiler contains twenty cubic feet for each horse power, and another only ten, the boiler with only ten feet of space should be of twice the strength; for equal powers require equal fires, and the effect of excess of fire in raising the temperature and force of the steam is inversely as the quantity of matter acted upon; hence the risk of the dangerous increase of strength is inversely as the quantity of water and steam the boiler contains.

523. The proportion for excess of strength I shall therefore consider to be two times that which is proper for the working pressure when the boiler contains twenty cubic feet for each horse power; and containing any other quantity as n cubic feet per horse power, it will be

$$n : 20 :: 2 : \frac{40}{n} .$$

The effect of unequal expansion, of improper form and flexure, and of wear, must be included in the calculation of the strength; for these are not allowances for risk, but actually necessary for security.

Boilers may fail from strains produced by other causes besides the force of the steam, and these may be noticed to guard against the circumstance which produces them.

If a boiler flue rise from the fire, and then *descend* again before it enters the chimney, it will in particular states of the fire be liable to fill with inflammable gas, which takes fire and explodes. The effect of such an explosion in the flues of a boiler must cause an impulsive strain on the boiler, under which it may fail.

The danger may be avoided by making the flues lead off to the chimney without depression, and constructing the damper so that it cannot be perfectly closed; and it should either rise so as to close the upper part of the aperture last, or move horizontally.

Hydrogen gas may be, and frequently is, formed in steam boilers, through the water being in contact with a part of the boiler which is red hot; and it seems to be regularly produced during the formation of steam at very high temperatures: and though it appears to me that it would not add to the risk of an explosion happening, it undoubtedly would render it more destructive if it should take place.¹

BOILERS FORMED OF PLATES.

524. Having determined the resistance of plates of any curvature, it is easy to apply these rules to rectangular boilers; remarking, that it is indifferent whether the curve be convex or concave to the pressure, provided it have either abutments as an arch, or forms a complete circle. I doubt the efficacy of the usual abutments, and I think the fact that boilers fail round the seats is greatly owing to the strain and motion of the parts at every change of force or temperature.

A rectangular boiler may be considered as a cylinder, taking the greatest diagonal line of its section for the diameter; and for strength the thickness will be, (art. 521.)

$$t = \frac{3.81 \ a \ p}{f}.$$

For *wrought iron*, $f = 17800$ lbs.

$$t = \frac{a \ p}{4660}.$$

¹ In a letter I received from Mr. W. Williams, of Cyrfartha Iron Works, he attributes the destructive effects of an accident in that neighbourhood to an accumulation of hydrogen inflaming when the boiler burst. The boiler was constructed of the old spherical form, twenty feet in diameter; the thickness of the plates when new was, top plates a full quarter of an inch, bottom plates half an inch; load on the safety valve 7 lbs. per circular inch. Many lives were lost by this explosion; and the boiler was thrown to a distance of 150 feet, to a place 30 feet above the level of its former seat. The upper plates were undoubtedly too weak.

The excess of strength for risk being $\frac{40}{n}$ (see art. 523.), we have

$$t = \frac{a p}{120 n}.$$

For *copper*, $f = 11000$ and

$$t = \frac{a p}{72 n}.$$

525. RULE for the upper plates of long rectangular and cylindric boilers. Multiply the load in lbs. per circular inch on the safety valve, by the greatest diagonal of the section of the boiler in inches, and for *wrought iron* divide the product by 120 times the cubic contents of the boiler per horse power; the result is the thickness in inches. For *copper*, divide by 72 instead of 120.

The bottom plates should be as much thicker as will compensate for wear; usually twice the thickness of the top ones.

Example 1. In a rectangular boiler the greatest diagonal being 8 feet, and consequently equivalent to a radius of curvature of 96 inches, the load on the valve $3\frac{1}{2}$ lbs. per circular inch, and the space for steam for each horse power 16 feet; required the thickness for the top plates of wrought iron.

In this case,

$$\frac{3.5 \times 96}{120 \times 16} = 0.175 \text{ inches, for the top plates.}$$

The bottom plates should not be less than $2 \times .175 = .35$ inches.

This nearly corresponds with the practice of the best makers.

526. Example 2. If the boiler be a long cylinder, of which the diameter is 60 inches, and the pressure on the safety valve 30 lbs., the boiler containing 20 feet for each horse power of the engine; then,

$$\frac{30 \times 60}{120 \times 20} = 0.75 \text{ inches.}$$

In practice boilers of this kind are made barely equivalent to the working pressure: can we wonder that they sometimes fail?

The same rule applies to internal flues, with addition for the effect of the fire.

527. OF SPHERICAL BOILERS. A spherical boiler has its dimensions equal, and consequently (art. 521.) its thickness should be,

$$t = \frac{3.81 a p}{2 f}.$$

Hence for *wrought iron*, $t = \frac{a p}{240 n}$;

and for *copper*, $t = \frac{a p}{144 n}$.

RULE for spherical boilers. Multiply the diameter in inches by the pressure on

the valve in lbs. per circular inch, and divide by 240 times the cubic contents of boiler for each horse power for *malleable iron*, or for *copper* by 144 times instead of 240.

Example. A boiler is of a spherical form, 20 feet in diameter, with 20 cubic feet to a horse power, and the load on the valve 7 lbs. per circular inch, what should be its thickness? The diameter is 240 inches, therefore

$$\frac{7 \times 240}{240 \times 20} = \cdot 35 \text{ inches,}$$

or a little less than three-eighths of an inch. (See note to art. 523.)

When cylindric boilers have spherical ends, the radius of curvature may be equal to the diameter of the cylinder, and they will be equally strong with the same thickness of metal: flat segments are more convenient in construction, and occupy less space to get the same effect.

CAST IRON BOILERS.

528. The preceding rules apply only to boilers of ductile metals: in forming one for brittle ones, the effect of unequal expansion must be considered. For cylindric boilers,

$$t = \frac{2 \cdot 54 \ a \ p}{f} \times \frac{40}{n} = \frac{a \ p}{150 \ n}, \text{ (art. 517 and 523.)}$$

and the mode of allowing for expansion was shown in treating of cylinders, art. 519.

In boilers composed of solid tubes it is possible that in a tube having a diameter of 8 inches or more, the excess of temperature on one of its sides may be 1000°, and then $\frac{7 \cdot 4 \ t}{a}$ = the loss of force, indicating that in those circumstances a tube would ultimately burst, of whatever strength it were made, if $7 \cdot 4 \ t$ were made greater than a ; for whenever the quotient is *unity*, or more than *unity*, the unequal expansion alone is beyond the power of the material.

This explains the known fact, that such tubes break without apparent defect, or the use of steam stronger than usual.

From these principles we derive the following for cast iron boilers: a being the diameter, and p the elastic force of the steam, $\frac{a \ p}{150 \ n}$ = the thickness for strength; which, added to a thickness equivalent to the loss of force it may sustain by unequal expansion, is, for boiler cylinders *above* 8 inches diameter,

$$t = \frac{a \ p}{150 \ n} + \frac{7 \cdot 4 \ t}{a}; \text{ whence,}$$

$$t = \frac{a^2 \ p}{150 \ n \ (a - 7 \cdot 4)}.$$

For boiler tubes, or cylinders *under* 8 inches in diameter,

$$t = \frac{a p}{150 n (1 - 0.116 a)}.$$

In either case there is a risk of failure when the diameter is less than 7.4 inches in the first, and when 0.116 times the diameter is greater than one in the second case. If the thickness be much more than the rule gives, the risk from unequal expansion increases; if it be less, the joint effect of pressure and inequality may cause failure.

529. RULE for the strength of cast iron tubes exceeding 8 inches in diameter. Multiply the square of the diameter by the pressure on the safety valve in lbs. on a circular inch, and divide the product by 150 times the cubic feet of space in the boiler per horse power, multiplied by the difference between the diameter and 7.4 inches; the result is the thickness in inches, which should be increased for wear and tear in proportion to the degree of durability required.

Example 1. The internal diameter of the tube being 10 inches, the cubic feet of boiler per horse power 10, and the load on the valve 36 lbs. on the circular inch, what should be its thickness? In this case,

$$\frac{10 \times 10 \times 36}{150 \times 10 (10 - 7.4)} = .92 \text{ inches.}$$

Example 2. The internal diameter of a cast iron cylinder for a boiler being 3 feet, and the force of the steam to be confined to 5 atmospheres, 58 lbs. per circular inch on the valve, what should be its thickness, the space of boiler for each horse power being 16 feet? In this case,

$$\frac{36 \times 36 \times 58}{150 \times 16 \times (36 - 7.4)} = 1.1 \text{ inches.}$$

OF JOINING PIPES AND OTHER PARTS OF ENGINES.

530. Joints are generally connected by screw bolts passing through flanches; between these flanches an elastic material of a durable nature is inserted, or a compound called a cement, which unites and forms one mass with the joined surfaces.

Iron cement is the most valuable of the latter kind; it may be compounded as follows:—To two ounces of sal-ammoniac, add one ounce of flowers of sulphur, and sixteen ounces of clean cast iron filings or borings; mix all well together by rubbing them in a mortar, and keep the powder dry. When the cement is wanted for use, take one part of the above powder and twenty parts of clean iron borings or filings, and blend them intimately by grinding them in a mortar. Wet the compound with water, and, when brought to a convenient consistence, apply it to

the joints and then screw them together. A considerable degree of action and reaction takes place among the ingredients, and between them and the iron surfaces, which causes the whole to unite as one mass ; the surfaces of the flanches become joined by a species of pyrites, all the parts of which cohere strongly together. Mr. Watt found that the cement is improved by adding some fine sand from the grindstone trough.

531. For some purposes it is more convenient to join the parts with white lead paint, mixed with a portion of red lead to a proper consistence, and applied on each side of a piece of thick canvas, flannel, or plaited hemp, previously shaped to fit the parts, and then interposed between them before they are screwed together : it makes a close and durable joint, and is generally used for those joints which have occasionally to be opened, and for those which must be separated repeatedly before a proper adjustment is obtained ; and when this is the case, the white lead ought to be predominant in the mixture, as it dries much slower than the red.

532. There is another cement often used by coppersmiths, to lay over the rivets and edges of the sheets of copper in large boilers, to serve as an additional security to the joinings, and to secure cocks, &c. from leaking. It is formed by mixing pounded quick lime with serum of blood or white of egg into a paste, and must be applied as soon as it is made, for it speedily gets so hard as to be unfit for use. The properties of this cement have been long known to chemists, and it may be found useful for many purposes to which it has never yet been applied : it is cheap and very durable.

533. Steam-tight joints may also be formed by fitting the parts very accurately to a conical aperture, and screwing them close together with bolts of a less expansible metal ; and the same method may be followed where the pressure of the steam tends to close the joint.

When two flat surfaces are to be joined, they may be made to fit together very accurately, and a single ring of fine copper wire inserted in between them before screwing them close. The pressure of the screws partially flattens the wire, and makes it fit so accurately, as to prevent the escape of even very high pressure steam.

SECTION VIII.

OF EQUALIZING THE ACTION, REGULATING THE POWER, MEASURING THE USEFUL EFFECT, AND MANAGING THE STEAM ENGINE.

534. THE action of a steam engine is variable ; consequently, when an equable motion is necessary, its action must be equalized. It may also be employed in one hour to overcome a small resistance, and in another to overcome a considerable one ; therefore, the means of regulating the power to the work should be provided : we have also to consider certain methods which may be made subservient to ascertaining the useful effect of an engine after it is erected, or, in the language of technical men, its PERFORMANCE ; and, lastly, the mode of managing the generation of steam, and the working of an engine.

OF EQUALIZING THE ACTION OF STEAM ENGINES.

535. An equable motion is desirable in almost every kind of machine, it being strained much more by an irregular desultory one, as well as the fabric that supports it, than when the motion is equable. The strength of the machine must be adapted to the greatest strains that occur, but the quantity of work done is equivalent to the mean action only, and more is not performed by a desultory motion, than by one at a mean rate and uniform. There are two modes used for equalizing the action of an engine, which we propose to describe. The one is by the *fly wheel*, the other by a *counter-weight*.

536. OF THE FLY WHEEL. A fly wheel is a wheel with a heavy rim which absorbs the surplus force at one part of the action, to distribute it again when the action is deficient ; it has been aptly compared by Professor Leslie, to “a reservoir which collects the intermitting currents, and sends forth a regular stream.”¹ To equalize a motion which is subject to variation at each reciprocation in the steam

¹ Natural Philosophy, vol. i. p. 152.

engine, the fly is used. Its heavy mass of matter must be so shaped, as to balance itself in any position on an axis connected with the machinery, and turning round with a part of it.

The proportions of the fly wheel must be derived from the laws of rotary motion. They are not often stated very clearly, and rather in too comparative a form for the purpose of application: Dr. Jackson's equation¹ is derived most in unison with my own methods, and adding the time, the radius corresponding to the angular velocity of the exterior ring of the wheel, and comparing with the force of gravity to obtain the coefficient, it is

$$\frac{32 P a r t}{b x^2} = n v.$$

In this equation

P = the mean quantity the moving force varies in its intensity in excess above the resistance,

t = the time in which that variation takes place;

v = the velocity,

$n v$ = the greatest variation of velocity,

a = the leverage the force P acts with,

r = the radius corresponding to the velocity v , and

w = the weight of the fly acting at the distance x from the axis.

It is obvious that the mass of the fly must be sufficient to receive the excess of force during the time it acts, and afford it again to the machine in an equal lapse of time, and so that the velocity shall not vary more than the n th part. The only point, therefore, which depends on practical experience, is what variation of velocity may be allowed. On this point however there is no difficulty, as the practice of different makers is so different, as to show that it may be taken with considerable latitude.

The weight of the rim may always be considered to be collected at the extremity of the radius; and then $x = r$, and the equation becomes,

$$\frac{32 P a t}{w r} = n v.$$

The effect of the arms of the wheel may be neglected, as it is a problem which neither requires nor admits of a very refined solution, in consequence of the uncertainty regarding the precise variation of the intensity of the moving force; hence it ought not to be rendered complicated.

537. From this equation it appears, that when the weight or the diameter of

¹ Theoretical Mechanics, art. 400—403.

the rim is considerable, and still more when both are so, it may acquire a great momentum with but little increase of angular velocity, or lose a considerable momentum with little diminution of that velocity. It thus becomes a receptacle for the surplus energy of the power, when it acts with most intensity, or when the resistance is least, and preserves it for future demand.

By either a diminution of resistance, or an increase of power, the machine would otherwise be considerably accelerated; the excess of motive force is however, in a great measure, expended upon the fly, in which it generates a proportional momentum with little increase of velocity: again, when the resistance is increased, or the moving power diminished, the machinery would be very sensibly retarded if the momentum accumulated in the fly did not continue the motion with little diminution of its own velocity; and other things being the same, the shorter the interval of reciprocation or of unequal resistance, the less will be the change of velocity.

The greater the angular velocity of the axis of the fly is, the greater will be its dominion or equalizing power, all other things being equal; for the variation of velocity is inversely as the velocity of the rim.

Every part of a machine which has either a continuous or pendulous motion, particularly when it is massive, will obviously act as a fly in equalizing the motion of the machine.

The greater part of these remarks have been made in a less general form by Dr. Robison¹ and Dr. Jackson;² but they also state that when a more perfect equalizer is wanted, we should increase the power of the fly wheel by enlarging the diameter rather than the mass, because we thus produce the same effect with less weight, consequently with less transverse strain upon the axle and supports, and less friction. This must however be carried only to small extent, for a mass of matter with an immense velocity, sustained by arms which must be completely incapable of resisting its impulse, becomes a very dangerous appendage to a machine. Arms of cast iron could not resist a sudden check, with a rim moving at the velocity of eighteen feet per second, and equal to the weight of the arms,³ consequently such wheels should be of limited diameter.

538. When it is necessary to exceed a velocity of twelve feet per second at the rim, malleable iron arms should always be used, and a velocity of thirty-three feet per second at the rim is about the extreme limit for a fly, even where the ring is of malleable iron. For cast iron rims, with arms of malleable iron, I should not think a velocity exceeding eighteen feet per second to be safe.

¹ Mechanical Philosophy, vol. ii. p. 250.

² Theoretical Mechanics, p. 227.

³ Essay on the Strength of Cast Iron, art. 261.

With these explanations we may now proceed to form rules from the equation. The equation is

$$w = \frac{32 P a t}{r n v}$$

but the dimensions of the rim will be more convenient than the weight; and the weight $w = 2 \times 3.1416 r A \times 3.2$ lbs., for cast iron, $= 20 r A$, consequently,

$$A = \frac{1.6 P a t}{r^2 n v}, \text{ the area of the section of the rim in inches.}$$

If the fly wheel shaft makes N revolutions per minute, then in the time t it will make $\frac{t N}{60}$; $\therefore v = \frac{6.2832 t N r}{60}$ and,

$$A = \frac{15 P a}{r^3 n N}.$$

539. The next point to be considered is the degree of equalization a machine requires. Its own parts have much effect, and the species of parts which act as flies are most numerous in machines which require the equalizing power of the fly the most. At a mean, perhaps a variation of one-tenth is nearly corresponding with practice, and with this condition the rule is,

$$A = \frac{150 P a}{r^3 N}.$$

540. CASE I. *A double engine with a crank.* In this case the variation is from the full force of the steam to nothing at each quarter of the stroke; hence, the mean excess is one-fourth of the greatest force P on the piston, and the rule in the nearest simple expression is,

$$A = \frac{40 P a}{r^3 N}.$$

RULE. Multiply forty times the pressure on the piston in lbs., by the radius of the crank in feet, and divide this product by the cube of the radius of the fly wheel in feet, and by the number of its revolutions per minute, the result is the area of the rim of the fly in inches.

The number of horse power, multiplied by 200, will be the greatest pressure on the piston, nearly.

Example. The pressure on the piston of an engine being 4000 lbs., the radius of the crank 2.5 feet, and the revolutions per minute 22, required the section of the rim of a fly of 9 feet radius. In this case,

$$\frac{40 \times 4000 \times 2.5}{9^3 \times 22} = \frac{400000}{16038} = 25 \text{ inches nearly,}$$

for the area of the section of the rim.

541. CASE II. *In a single engine with a crank the mean excess is half the moving force; hence,*

$$A = \frac{80 P a}{r^3 N},$$

or the rim of the fly wheel should be double that required for a double engine with the same sized cylinder, or of twice the power.¹

542. COUNTER-WEIGHTS. If the beam of a single engine be balanced when at rest, that weight which it is necessary to add or subtract, to cause the piston to rise at the proper speed, is called the counter-weight. The excess of force of the steam overcomes the friction of the parts, and the additional weight ought to be sufficient to cause it to rise and acquire double the velocity of the engine, if it freely accelerated during the whole stroke. If W be the whole weight of matter moved, w = the counter-weight, and l = the length of the stroke, then

$$\frac{64 l w}{W + w} = 4 v^2,$$

$$\text{or } w = \frac{v^2 W}{16 l - v^2}.$$

But (art. 342.) $v^2 = 2.66 l$; v being for one second: hence, $w = 0.2 W$; consequently, the counter-weight should, with these proportions, be one-fifth of the mass of matter it has to move, supposing the whole to be collected at the ends of the beam; and it is most easily found by trial. The resistance of the water in the pumps will reduce the accelerated to an uniform motion of half the final velocity it would have acquired with no such resistance.²

OF REGULATING THE POWER OF ENGINES.

543. An engine is frequently applied where the work to be done is not constantly the same; and when the machinery of a part of it is suddenly stopped,

¹ In single acting atmospheric engines a weight has been applied to the fly wheel, such that its force to turn the shaft should be exactly half the force of the steam to turn it, and placed so as to rise while the piston was descending, and descend during the rise of the piston. To find the weight, we have

$$w = \frac{P a}{2 r};$$

w being the weight, and P the mean pressure on the piston. It is supposed to be applied to the rim of the fly, and the section of the continued rim should be the same as for a double engine of the same power. This mode is described in 'Fenwick's Essays on Practical Mechanics,' p. 39. Woolf proposed to equalize the motion of an engine by a piston working in a cylinder; this, however, has no other effect than a weight, while the friction and expense of construction are considerably increased. See Nich. Journal, vol. vi. p. 218. and vol. vii. p. 134.

² Smeaton arranged his engines to make the returning stroke in less time than the acting one. (Reports, vol. ii. p. 360.) Watt states it to be generally agreed that the reverse should be the case. (Robison's Mech. Phil. vol. ii. p. 99.) The reasons for making them equal are stated in art. 340.

or suddenly set on, if the moving power were to remain the same, an alteration of the velocity must take place; it must move faster or slower. This change of velocity would in most cases be very hurtful to the work, and cause considerable loss; besides, there is always a velocity at which a machine will act with greater advantage than at any other; therefore the change of velocity arising from the above cause, is in all cases a disadvantage, and in all delicate operations exceedingly injurious. In a cotton mill, for example, where the power moved the spindles with a given speed, if so much of the work were at once thrown off as to increase the velocity in a considerable degree, a loss of work would immediately take place, and an increase of waste from the breaking of the threads; on the other hand, there would be much loss of the time of the attendants, if the machinery moved too slow.

An equally bad effect is observed in raising water, and other species of work.

544. **THE THROTTLE VALVE.** The power of a steam engine is usually regulated by increasing or diminishing the steam passage, and this is generally performed by admitting the steam into the cylinder, more or less freely, by means of what is called a throttle valve: this valve is formed of a circular plate of metal, *a*, Fig. 1. Plate VIII. having a spindle fixed across its diameter. The plate is accurately fitted to an aperture in a metal ring of some thickness, through which the spindle is fitted steam-tight, and the ring is fixed between the flanches of that joint of the steam pipe which is next to the cylinder. A square part is formed on one end of the spindle, to receive an arm or lever *b*, by which the valve may be turned in either direction.

545. For many purposes engines are thus regulated by hand at the pleasure of the attendant; but where a regular velocity is required, means must be applied to open and shut it, without any attention on the part of the person who has the care of the engine. For this purpose Mr. Watt, after trying various methods, fixed upon the conical pendulum, which he called a governor. (See art. 550.)

An axis valve of this kind has much advantage over a valve of any other form for a circular pipe, because it contracts the aperture without being difficult to move, or presenting more than the necessary obstruction; but it is by no means an economical mode of varying the power of the steam engine.

546. *To regulate by working more or less by expansion.* This may be done by adjusting the motion of the steam valves, so that they may be closed at an earlier or later period of the stroke, according as the engine has less or more work upon it. This method is confined chiefly to regulating by hand, (see art. 481. and Plate ix.) The self-acting regulator in use applies with good effect only to valve engines, as neither the common slide nor cock can be adjusted otherwise than to close the passage to the condenser. (See art. 448. and 456.)

547. **FIELD'S VALVE.** An ingenious mode of cutting off the steam at any period of the stroke has however been discovered by Mr. Joshua Field.¹ It consists of a valve placed in the situation usually assigned to the throttle valve; that is, near to the place where the steam is admitted to the cylinder. This valve is to be opened at once, at the commencement of the stroke, so as to afford full passage to the steam, and shut at once after a certain part of the stroke is made, that the rest of it may be completed by the expansive power of the steam. This may be done by causing the valve to open by a tooth or cam on a cylinder, on one of the revolving shafts formed to raise the valve, and keep it open till the shaft has made part of its revolution, and then shut it. If the toothed cylinder be made to slide on the shaft, and the form of the tooth be such that as the cylinder is moved in one direction the valve will shut sooner, and in the other direction later, there is then the means of regulating the period the valve shall be open, and consequently of regulating the power of the engine. This may either be done by hand, or by causing the cylinder having the tooth to slide by the governor. Its application to Maudslay's portable engine, where it is moved by the governor, is shown in Plate xv. It was there first applied by way of experiment, which will account for the indirect passages for the steam, and for retaining the throttle valve. The saving of power, according to the experiment, amounted to about 10 per cent.

548. When atmospheric engines condensing in the cylinder have to work under loads inferior to their whole power, they are regulated by lessening the quantity of injection, or by shutting the injection cock sooner; but in almost all engines employed for raising water which are regulated by hand, it is necessary to provide the means of warning the attendant of the power being in excess.

549. **SPRING BEAMS.** In engines with fly wheels no precaution is necessary to limit the motion of the beam, because this is most effectually done by the length of the crank, while the fly continues the rotary motion so as to prevent strain on the crank shaft; but in engines where a crank is not used, as in engines for pumping, a very strong piece of timber is bolted across the top of the beam at each end, as shown in Plate XII. each of which strikes against two wooden springs, one placed on each side of the beam, on the two longitudinal beams which support the axis of the engine beam, and which are on this account called the spring beams of the engine. To prevent noise, the springs are covered with cork at the place where

¹ This is an ingenious adaptation of what Mr. Watt practised in the reciprocating engine, viz. shutting off the steam at any required period of the stroke. In the rotative engine the same object has been accomplished since the application of Murdoch's slide valve, in 1799, by increasing the depth of its face to the required expansion in the cylinder, and properly adjusting the motion of the excentric.—ED.

they receive the stroke; and when they are bent beyond a certain degree they cause a bell to ring, which gives the attendant notice that the engine requires regulation.

THE CONICAL PENDULUM OR GOVERNOR.

550. If two or more balls be suspended from a revolving axis so as to revolve with it, the balls will rise when the velocity is increased, and fall when it is diminished; and by connecting arms to the rods by which the balls are suspended, their rising or falling may be made to move a lever so as to open or close a valve, or the like, on any change taking place in the velocity of the machinery; and hence it is employed to render an engine the regulator of its own power to the effect it is to produce.

In the construction of this apparatus it is necessary to consider the place of the balls corresponding to the mean velocity, the range of motion, and the weight and velocity of the balls.

Different modes of combining the parts are used by different engineers; one of these is shown in Plate VIII. Fig. 1. where g is the revolving axis, f the point of suspension, jj the balls, ee the rods by which the balls are suspended. These rods are connected to the rods ii , and by that means raise or depress the sliding piece h , and with it the lever l , which acts on the throttle valve. The parts marked k k are two rests to receive the balls when the engine is not in motion.

551. The vertical distance between the point of suspension and the plane in which the centres of the balls revolve, is the same as the length of a pendulum which makes one vibration, forward and back again, in the same time the balls make one revolution. The usual velocity for the axis is 30 revolutions per second, and therefore the height should be the same as the length of the seconds' pendulum, that is, 39.14 inches. To find the height for any other number of revolutions per minute, divide 35226 by the square of the number; thus, for twenty revolutions, $20 \times 20 = 400$, and

$$\frac{35226}{400} = 88.065 \text{ inches, the height required.}$$

552. The range may be settled from considering the greatest change of velocity the machinery may acquire without injurious effect on the work; and with this range the governor ought to be capable of completely cutting off the acting power. Now the greatest variation should not generally exceed one-tenth of the velocity, that is, one-twentieth on either side of the mean; and the range of the plane of revolution will, in that case, be nearly one-fifth of the height of

the point of suspension above the plane of revolution at the mean velocity.¹ Thus, if the mean height be 39·14 inches, then one-tenth on each side will be

$$39\cdot14 + 3\cdot914 = 43\cdot054$$

$$39\cdot14 - 3\cdot914 = 35\cdot226$$

$$\text{One-fifth of } 39\cdot14 \quad = \quad \frac{7\cdot728}{\quad}, \text{ the range.}$$

Where a throttle valve is acted on by a governor, the steam passage should be fully open at the usual velocity of the engine, and contracted only when it exceeds that velocity, otherwise the steam must be always throttled, except when the engine is working against an unusual resistance.

553. The balls are made from 30 to 80 lbs. each; their effect, however, depends considerably on the angles formed by the combination of bars. In the form in Fig. 1. Plate VIII. the force is small, but the quantity of motion is considerable; while that in Fig. 3. Plate xv. has more force and less motion. The angle the ball rods make with the axis, should be about 30° when they are at rest; and provided the range be sufficient, the angle the connecting rods make with the axis, may be made acute with advantage in point of power.²

554. The velocity of an engine for raising water has in some instances been regulated by a small cylinder provided with a piston, and fixed on a pipe from the air vessel of the main; which, when the engine goes too quick, forces water into the lower part of the small cylinder, and raises its piston. The piston is loaded with a weight corresponding to the proper velocity of the engine, and therefore it is only when it goes too rapidly, that, the friction increasing in the

¹ For if v be the mean velocity, and it increases to $v + n v = v (1 + n)$; then the height of the plane of revolution will be altered from h to $\frac{h}{(1 + n)^2}$; or in the ratio of $(1 + n)^2 : 1$, consequently, the change in the velocity will be to the change in the height of the plane of revolution, as $1 + n : (1 + n)^2$; and the increments are as $n : 2n + n^2$, or as $1 : 2 + n$; and when n is a small fraction, it is nearly as $1 : 2$.

From want of attention to this point, the governor has been supposed to be deficient in sensibility to the changes of velocity in a nice machine; and M. Preus has proposed to use a small pump to raise water to a cistern, from whence it escapes by an aperture which can be regulated at pleasure. When the engine moves at a greater speed than the proposed one, the water rises in the cistern, and raises a float which closes the throttle valve. See Phil. Mag. vol. lxii. p. 298. It is obvious that it cannot exceed the governor in sensibility, while it will require considerable attention to keep it in order.

² Several trials have been made to apply the governor to boat engines, but it appears to me that the changes are too sudden for this mode of regulation.

main pipes, the pressure in the air vessel increases also; and this pressure being also communicated by the small pipe to the regulating cylinder, causes its loaded piston to rise, and the motion is communicated to the top or steam valve by means of spindles and gearing to the regulating screw, so as to regulate the steam; or, on the other hand, if the engine works too slow, the pressure in the air vessel diminishes, and the loaded piston descends and opens the valve.

In order to prevent the motion of the piston being too great, the load is divided into links like a chain, and, as the piston rises, more links are raised, consequently the load increases; and also as it descends, the links, by resting on the ground, diminish the load. A spring might be applied to produce a similar effect.

This plan, however, as it did not regulate the pressure of steam in the boiler, and from the friction did not act promptly, has been some time abandoned.

555. In some cases the further improvement has been adopted, of using this method to adjust the tappets which shut off the steam. For this object, the motion of the small piston is communicated to a wheel which turns a pair of bevelled wheels, the one of which is on the square part of a screw rod attached to the plug tree; and whenever the motion is too rapid, the rod is turned, and moves the tappet so as to cut off the steam sooner, and the reverse. The square part of the rod slides in the wheel upon it without change, except when that wheel is moved by the regulator piston.

556. OF THE CATARACT. The power of an engine for raising water may also be regulated by increasing or diminishing the interval between its strokes; this is done by causing the tappets to disengage a loaded piston, which descends in a small air vessel, expelling the air from it by a pipe, which can be regulated by a cock at pleasure; the valves are not free to open till this piston be at the end of its stroke. The air vessel is a cylinder of from five to six inches diameter, and twenty inches in length, open at the top with a valve opening inwards at the bottom, that it may ascend without unnecessary resistance. It is provided with a pipe from the bottom, of sufficient diameter to allow the air to escape when the engine is at full speed, which has a cock to regulate the time of discharge. It is also fitted with an air-tight piston, the rod of which is connected with the apparatus which opens the valves. Two air vessels are required for a double engine.

OF THE METHODS OF ASCERTAINING THE STATE AND EFFECTIVE POWER OF A STEAM ENGINE.

557. Certain instruments have been invented which are of great use in ascertaining the state of an engine; and these ought to be kept in good order,

so as to be capable of affording the required proof at any time. Mr. Watt has most justly remarked, "it is the interest however of every owner of an engine to see that they, as well as all other parts of the engine, are kept in order."¹

The instruments consist of a steam gauge, the condenser gauge, and the indicator.

558. STEAM GAUGE. The steam gauge, Plate VIII. Fig. 1, 18. is a short bent tube of iron, nearly half an inch in diameter, with one end fixed into the boiler or the steam pipe, and open to it; with a portion of mercury in the bent part of the tube. The part joined to the boiler or steam pipe is freely open to the steam, which, pressing on the surface of the mercury in the pipe, raises it in the other leg of the tube, which is open to the air at the upper end, and the height it is raised is measured on a scale, 20, by a slender stem from a light float on the surface of the mercury; which therefore shows the elastic power of the steam over that of the atmosphere. The scale should be adjusted by allowing the air free access to the mercury on both sides.

The scale is commonly divided into inches and parts; each inch corresponds to 2 inches of mercury, and to a pressure of 0.775 lbs. on a circular inch, or to 0.98 lbs. on a square inch. If each of the divisions of the scale be made 1.3 inches, and these each divided into 10 equal parts, the pressure in lbs. and tenths on a circular inch will be shown by the gauge. Some divide the scale into half inches, then each division represents an inch of mercury.

Sometimes a cock, 19, is placed between the mercury and the steam, so as to use it or not at pleasure.

To render the divisions of the gauge larger, Mr. Watt made his gauge pipe of glass, to terminate in a cistern of mercury enclosed in an iron box. The action is then like a common barometer; the steam having free access to the surface of the mercury in the cistern.

559. CONDENSER GAUGE. This is sometimes called the barometer gauge, from its resemblance to a barometer. It is made of iron tube in the form of an inverted syphon, Plate VIII. Fig. 1, 21. with one leg about half the length of the other. To the upper end of the longer leg, 24, a pipe is joined which communicates with the condenser, and has a stop cock, 22, to open or close it. When a proper quantity of mercury is poured into the short leg of the syphon, and it is open to the atmosphere at both ends, it naturally stands level in the two legs. A light float with a slender stem is placed in the short leg, and a scale, 25, attached, which is usually divided into half inches; and as by the exhaustion in

¹ Robison's Meehan. Phil. vol. ii. p. 156.

the condenser, the mercury rises as much in the long leg as it falls in the short one, these divisions will be equivalent to inches on the common barometer.

The condenser gauge should indicate the state of the vapour in the condenser, to be capable of sustaining from two to three inches of mercury. While it does not exceed three inches, the condensation may be esteemed very good; and about two inches is the best I have seen obtained in practice.

The difference between the elastic force of the vapour in the condenser, and the elastic force of the steam in the boiler, as shown by the gauge, added to the height of the barometer at the time, gives the relative force of the steam to move the engine, but many deductions have to take place before we have the real moving force; nevertheless they show the state of two very important parts of the engine. (See Sect. v. and vi.)

560. THE INDICATOR. The force of the steam and the state of exhaustion in the cylinder, at the different periods of the stroke of the engine, cannot be ascertained by the condenser gauge, and for that purpose it was necessary to form an instrument less subject to vibration; the instrument in use is called the INDICATOR, and is found to answer the end tolerably well. It consists of a cylinder about one inch and three quarters in diameter, and eight inches long, exceedingly truly bored, with a solid piston accurately fitted to it, so as to slide easy by the help of some oil; the stem of the piston is guided in the direction of the axis of the cylinder, so that it may not be subject to jam or cause friction in any part of its motion. The bottom of this cylinder has a cock and small pipe joined to it; a flat pillar D, Plate xvi. Figs. 1 and 2. is screwed to the cylinder of the indicator C, and supporting the frame E E, which is twelve inches by seven inches, with the upper and under rail grooved to retain the sliding-board K.

The piston rod G is about five-eighths of an inch in diameter, and sixteen inches long; and H is the guide for it screwed to the pillar D, at about six inches above the top of the cylinder C.

A spiral spring I is attached to the piston at F, and to the guide at H. It should be about seven inches long when at rest, and of such a strength as to allow the piston to descend to within about an inch of the bottom of the cylinder C, when it is loaded with 15 lbs. upon every square inch of its area; and the spring should admit of being compressed one inch and a half.

The board or panel K slides in the grooves of the frame E E, and should be seven inches square; and a small brass slider L should be set at any height on the piston rod G, by means of a screw. A short pencil is inserted in the other end, with a weak spring to push it against the surface of the board K, which is caused to slide by a weight N, attached to a line passing over a pulley; the opposite line

O being attached to any convenient part of the parallel motion of the engine, so as to cause the board K to traverse a space of about fourteen inches and a half during each half stroke of the engine.

Operation. By opening the stop cock B, a direct communication is made between the cylinder of the steam engine and the cylinder of the indicator. When the force of the steam in the cylinder is greater than the pressure of the atmosphere, the piston F will rise; when the force of steam is less than atmospheric pressure, it will sink. The indicator will consequently rise when the upper steam valve opens, and will be at a height proportional to the force of the steam in the cylinder during the stroke of the engine; and when the eduction valve opens, it will sink, and by the rapidity and quantity of its descent denote the state of the vapour in the condenser. During the motion of the piston F, the sliding-board will move horizontally, and the pencil in the socket in L will trace on the board K, or on a paper on its surface, a figure, P Q R S, resembling those shown on an enlarged scale in the annexed figures. Of this figure, P Q is described during the descent

FIG. 23.

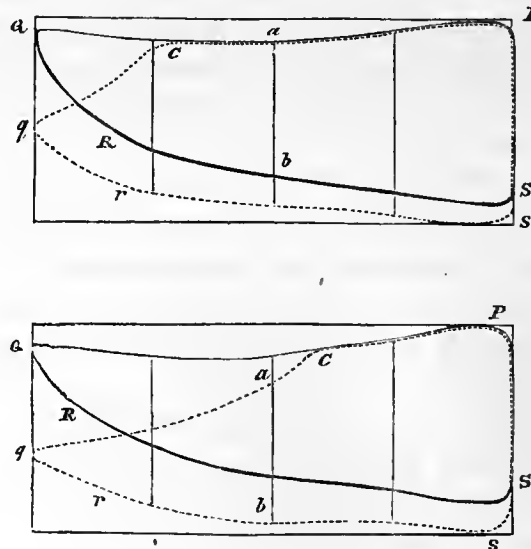

of the steam piston; at Q the condensation takes place, and the indicator is forced down by the pressure of the atmosphere, till it is balanced by the resistance of the spring and the vapour in the cylinder. While the engine makes the ascending part of the stroke, the line R S is described; and the line S P is described during a fresh admission of steam by the upper valve.

The area P Q R S is proportional to the force of steam on the piston during the stroke ; but the steam is not exerting the greatest power in proportion to the quantity of fuel when this area is the greatest ; for when the steam acts by expansion, the area described will resemble the figure P Q R S, the steam being cut off at C, and more power will be exerted by a given quantity of steam. In the same engine doing different quantities of work the figures show two cases ; the black lines represent the power when the throttle valve is used for regulation, and the dotted lines when the engine is regulated by cutting off the steam.

561. Let p be the number of lbs. on a circular inch of the indicator piston, which causes it to descend a inches, and let m be the length of the line $a b$, measured in inches on the diagram drawn by the indicator, then $a : m :: p : \frac{m p}{a}$, the pressure exerted by the steam in lbs. on a circular inch, at the point a of the descent of the piston. Thus, if by trial 2 lbs. per circular inch causes the piston to descend 1 inch, then $\frac{m p}{a} = \frac{m \times 2}{1} = 2 m$; or each inch of the indicator would correspond to 2 lbs. per circular inch.

If the distance the tracer moves horizontally be divided into equal parts, and the vertical distance between the lines P Q and R S be taken at each point of division, and the sum of these distances, less half the distance P S, be taken and divided by the number of divisions, the result will be the mean distance the piston of the indicator moves over ; and calling this mean distance m , it will be,

$$\frac{m p}{a} = \text{the mean pressure on the steam piston in lbs. per circular inch.}^1$$

562. TO MEASURE THE USEFUL EFFECT OF AN ENGINE. The preceding methods only give the state of parts, but the useful effect depends on the whole being in order ; and the most simple and convenient mode of measuring the effect is by means of friction.² If the rim of a brake wheel on the engine shaft of a known diameter be pressed with a force producing a known degree of friction, which is exactly equal to the effect of the engine at its working speed, then it is clear that if the friction this pressure produces be ascertained, the power of the engine will be equal to the friction multiplied by the velocity of the rubbing surface.

¹ The indicator was invented by Watt, (Robison's *Mech. Phil.* vol. ii. p. 156.) and the sliding board and tracer were afterwards applied by Mr. Southern. Figures made by the board and tracer, as far back as 1802, are still to be found amongst the archives of Soho.

² It is for use in those cases where the work itself is not susceptible of accurate measure ; and almost all engines for impelling machinery are in this class. The power of engines for raising water is easily computed.

To apply this, let AB be a lever, with a friction strap that may be tightened upon the cylindrical surface of the shaft or wheel C , and let it be tightened by the screw at B , (the lever being stopped by the stop D ,) till the friction be equal to the power of the engine when all other work is thrown off; then, while the engine is still in motion, add such a weight at E as retains the lever in a horizontal position.

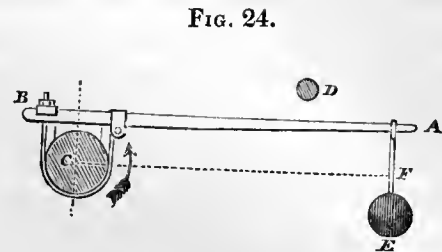

To calculate the power. Multiply together the length FC of the lever in feet, the weight E in lbs., the number of revolutions of C per minute, and the number 6.2832 , the result will be the lbs. raised 1 foot per minute; and, divided by 33000 , it is the horse power.¹

Thus if a shaft C make 25 revolutions per minute, and the length FC of the lever be 10 feet, and if it be found that a weight of 240 lbs. is sufficient to retain the lever in a horizontal position, then $6.2832 \times 10 \times 240 \times 25 = 376992$ lbs. raised 1 foot, or $11\frac{1}{2}$ horse power nearly.

The trial is so easily made, and the result so accurate a test of the qualities of an engine, that I strongly recommend it to the notice of those who are desirous of having good engines.

563. THE COUNTER. To estimate the saving of fuel by the application of Watt's engines, an apparatus was attached to the beam to ascertain the number of strokes the engine made in a given time: it is called the counter, and consists of a train of wheel-work resembling that of a clock, so arranged that every stroke made by the engine moves one tooth, and the index shows how many strokes have been made between the times of examination. The counter is enclosed in a box and locked, to prevent it being altered during the absence of the observer. If the box be attached to the axis of the beam, the inclination of the beam causes its pendulum to vibrate every time the engine makes a stroke, and thus moves the counter round one tooth for every stroke. The box may also be fixed to the supports of the beam, and then at every stroke a small detent is moved one tooth. The

¹ For, let l be the leverage the weight w acts with, and r the radius of the wheel or shaft C ; the friction f , the velocity v , and the revolutions of C per minute n . Then $f v =$ the power, $f = \frac{l w}{r}$, and $v = 6.2832 r n$; consequently $v f = 6.2832 l w n$, the power in lbs. raised 1 foot, when l is in feet and w in lbs.

counter is still used in Cornwall, in order that the effect of the engines may be reported on by the inspectors; and it is useful in various instances where a check on the consumption of fuel is desirable.

OF WORKING STEAM ENGINES.

564. The first attention should be directed to the qualities of the fuel and the water. The fuel, of whatever kind, should be dry, in small parts, and free from earth, &c. No coals should be above the size of an egg, and they should contain as little pyritical matter as possible. Wood should be in billets not more than a foot long, nor two or three inches diameter. The water used should be pure and soft when it can be had.

All natural waters contain a quantity of matter, which they derive from the strata through which they flow. The purest springs usually rise in beds of gravel, or in siliceous or argillaceous rocks; and they contain, for the most part, only a minute portion of saline matter, which is principally common salt. The water of limestone or calcareous districts generally contains a much larger quantity of solid matter, most frequently lime in solution, either carbonate or sulphate of lime, which occasions that peculiar quality in waters commonly known by the name of hardness.¹ The waters of mines are still more impure; they often contain earths, acids, alkalies, and saline compounds. Hence water in its natural state is often unfit for a steam engine.

Almost the only practicable method of improving water is that of exposing it long to the air in ponds: a more effective one is to use the same water over and over again, with only such addition as compensates for loss; but even this requires a larger reservoir to allow the water time to cool. Foul river-water may be cleared by filtering through sand or gravel.

To prevent the sediment from the water adhering to boilers, it is common to put in crushed potato, the refuse of malt, and the like, and change it frequently.

565. For sea-boat engines sea water must be used, and it deposits salt after the water is saturated. This may be prevented by letting a small quantity of hot water escape constantly from the boiler. One hundred parts of sea water contains three parts of its weight of saline matter; and is saturated when it contains thirty-

¹ Hard waters do not readily dissolve soap, nor form a good lather with it; on the contrary, they partially decompose it, and a light flocculent substance is produced, which is insoluble in water.

six parts;¹ consequently, if the boiler contain one hundred parts of water, and s parts be used for steam, and n parts let out, fix on the degree of saturation, for example, to contain a parts of saline matter; then if $3(s + n) = an$, the quantity of salt entering and the quantity quitting in the same time will be equal; hence,

$$n = \frac{3s}{a-3}.$$

If $a = 30$, the water in the boiler will not reach to a higher degree of saturation when a ninth part of the quantity used for steam is allowed to escape. Hence, as it requires only about one-sixth of the quantity of fuel to boil water that is required to convert it into steam, the loss of fuel will be $\frac{1}{3} \times \frac{1}{3} =$ one fifty-fourth part.²

566. OF WORKING A CONDENSING ENGINE. The engine is supposed to be at rest, the cylinder quite cold, and the condenser partially filled with water, and the piston at the top. When the water in the boiler begins to boil, let steam enter by the valves, or the slide, and the communication which is added when a slide is used; it will then fill the cylinder and pipes; and the injection cock being shut, it will gradually displace the water in the condenser,³ by forcing it out at the blow

¹ According to Mr. Faraday's experiments, the deposits take place at the following degrees of saturation and temperature, when 1000 parts of sea water were reduced by evaporation.

Quantity of sea water.	Boiling temperature.	Salt in 100 parts.	Nature of deposit.
1000	214°	3	None.
299	217	10	Sulphate of lime.
102	228	29.5	Common salt.

² An ingenious combination was formed by Messrs. Maudslay and Field, to avoid this loss, by causing the water entering the boiler to traverse the central parts of the pipe which removed the saturated hot water; the loss of effect then becomes very small, even when the degree of saturation is much less. Now to prevent the deposition of sulphate of lime we must make $a = 10$, and then three-sevenths of the quantity required for steam must be let out, and one-fourteenth of the effect of the fuel will be lost. It may be necessary to explain, that sulphate of lime does not appear to exist in sea water till a change of combination among its constituents takes place through evaporation; also, it requires thirty-six parts of salt to saturate one hundred of water at 226°, but it appears that deposit takes place at 228° with only thirty parts.

³ The best method would be to use a cock to let out the water from the condenser, placed so low as to completely drain it, and the water should be let out in the first instance; then the steam should be let on, and as soon as steam issues at the cock, it should be closed, till it be evident that the cylinder is as hot as the steam will render it; then open the cock again till steam has passed out a few seconds, and close it, confining the steam to the top of the piston, and open the injection, when motion will commence if the operation has been properly performed.

valve, and afterwards the air. When all the air except that mixed with the steam is driven out, which will be known by the sharp cracking noise at the blow valve, this noise must be allowed to continue till it be supposed that there has been time for at least as much steam as fills the engine to run through. Then shut off the steam except to the upper side of the piston, and open the injection cock; if motion does not commence, the injection cock must be shut, and the blowing through of steam repeated. If the engine have a steam case or jacket, that case must be cleared of air and water, and filled with steam before the operation of blowing through be commenced.

The noncondensing species of engines require nothing more than to be heated and freed from water, and atmospheric engines condensing in the cylinder to be freed of air.

567. OF THE MANAGEMENT OF THE FIRE. The chief thing is to obtain as equable a supply of steam as possible; and the object of the attendant must be to render it so with the least occasion for opening the fire door. He must endeavour to preserve a clear free burning fire, which cannot be done if it be allowed to become foul by clinkers accumulating. Every coal which will not pass a ring of about two inches and a half diameter should be broken; and either feed frequently, thinly, and equally over the surface of the fire, or adopt the method pointed out in art. 249; but in important works Brunton's method should be applied (art. 250).

568. Great care should be taken to keep the engine and boiler clean and in good order, and for this purpose frequent and steady attention is more effectual than twice the quantity of irregular labour. In work of this kind that which is done well is twice done; and the most furious zeal is vastly inferior to steady attention, for the one destroys the objects of its care, the other preserves them.

The best kinds of oil and tallow should be used: for piston grease, tallow is most esteemed; and when cylinders are new, a small addition of very soft black lead in fine powder improves the effect of the tallow. Oil appears to be improved by the addition of a small quantity of wax.

SECTION IX.

OF THE APPLICATION OF STEAM ENGINES TO DIFFERENT PURPOSES.

569. THE great variety of objects to which steam power is or may be applied, renders it necessary to confine our attention to the most prominent ones for illustration. These are to raising water; to impelling machinery for mining, manufacturing, and agricultural purposes; and to land carriage: the application to navigation however is so distinct and important as to require a separate treatment; and it is therefore reserved for the next section.

OF RAISING WATER.

570. Water is generally raised by means of pumps of the lifting or forcing species. The stroke of a pump should not exceed about eight feet, otherwise the air disengaged from the water, the escape by the bucket or piston, and the defect of pressure on the fluid which is rising after the piston, becomes greater than the escape by the valves. The velocity of the piston should not exceed 98 times the square root of the length of the stroke, (art. 342.)¹

571. Owing to the escape at the valves and the disengagement of air, the quantity of water a pump in the best order delivers at one stroke is,

$$\frac{\cdot95 l a^2 \times \cdot7854}{144} = \cdot00518 l a^2 \text{ cubic feet ;}$$

where l is the length of the stroke in feet, and a the diameter of the pump in inches; or substituting half the velocity for l , it gives the cubic feet per minute.

572. The power required to raise water a given height is found by taking the exact height in feet, from the surface of the water to the point of discharge, adding one foot and a half for each lift, for the force required to give the water the velocity, and also one-twentieth of the height for the friction of the piston. Call this quantity in feet h ; then $\cdot341 h a^2 =$ the load in lbs.

¹ See note, page 167.

Whence, if P = the mean effective force on the steam piston in lbs. per circular inch, we have

$$D = a \left(\frac{.341 h}{P} \right)^{\frac{1}{2}},$$

the diameter of the steam piston in inches.¹

And as 180 feet per minute is a very good velocity for raising water, if Q be the quantity in cubic feet,

$$a = \left(\frac{Q}{.00518 \times 90} \right)^{\frac{1}{2}} = (2.15 Q)^{\frac{1}{2}};$$

hence,

$$D = \left(\frac{.7332 h Q}{P} \right)^{\frac{1}{2}}.$$

Example. Suppose it be required to raise 80 cubic feet of water per minute by a single acting engine, the mean effectual pressure of the steam being 11 lbs. per circular inch, and the lift 149 fathoms in 6 lifts. In this case 149 fathoms = 894 feet; hence, $9 + 894 + 44.7 = 948 = h$; and $\left(\frac{.7332 \times 948 \times 80}{11} \right)^{\frac{1}{2}} = (5054.171)^{\frac{1}{2}} = 72$ inches nearly, for the diameter of the cylinder; and $(2.15 \times 80)^{\frac{1}{2}} = 13.115$ inches = the diameter of the pump; the velocity being 180 feet per minute.

Both these diameters ought to be increased 5 per cent. for contingencies.

DRAINAGE OF MINES.

573. In this country the drainage of mines is a subject of vast importance. It is mines which supply the means of employing steam power, and also a large proportion of the materials on which that power is expended. To persons accustomed to mines, it is seldom necessary to state those principles which should direct them in the choice of engines. The absolute necessity of an economical system of drainage is felt and acted upon; and it is by comparison of annual expense, and not by a comparison of the effect from a given quantity of fuel, that this economy should be estimated.

A mine engine should be simple in construction, durable in use, and made with

¹ When a given quantity of water is to be raised; if Q be that quantity, we have

$$a^2 = \frac{2 Q}{.00518 v}, \text{ and } a^2 = \frac{P D^2}{.341 h}, \therefore \frac{2 Q}{.00518 v} = \frac{P D^2}{.341 h}.$$

Also, $l = \frac{2 D}{12}$; and $v = 98 \sqrt{l}$; hence we find,

$$D = \left(\frac{3.3 Q h}{P} \right)^{\frac{2}{3}}.$$

a view to easy repair. When coals are not expensive, the most simple methods are the most economical; for instance, at the mouth of a coal pit, the extra consumption of coals is of less value than the extra wear and tear of a complex engine.

574. The modes of draining mines are dependent on the nature of the district where they are situated. If it be mountainous, a subterraneous channel or day level drift¹ may be made, from the lowest part of the mine to terminate in the nearest valley, to carry off the water; and it is only when this method is impracticable that water is raised by power, and even then the water is raised no higher than to where a day level drift can be obtained. But it frequently happens that the flatness of the country renders any other method impracticable, than that of raising the water to the surface. For example, in the coal-field of Northumberland and Durham, many of the large double pits exceed one hundred fathoms in depth, and some are nearly 150 fathoms deep, with no means of drainage by levels. These pits therefore require very powerful engines, and lately they have chiefly erected double engines, some of which are above 100 horse power: the largest I saw there was one on the south side of the Tyne, which was working with 160 horse power, and was capable of exerting the power of 200 horses in action at once. In Cornwall they have some larger engines; but two engines should always be preferred, when the cylinder of one engine would exceed about sixty inches in diameter, for two engines give many advantages.

575. When double engines are used for lifting water, they generally work one set of pumps by the outward end of the beam, and another set by a diagonal spear from the piston rod end. And in cases where it has not been convenient to divide the pumps into two sets, the ascending motion of the piston has been employed to raise a weight equal to the pressure of half the column of water in the pumps; but for such cases a single engine should be preferred.

576. The following table (p. 278.) will give some idea of the work done by a given quantity of fuel, and of the nature of the engines most approved of in Cornwall; the results however can be correct only through the different errors of the mode of estimation balancing one another, for the weight of the column of water is less than the resistance, and the counter only registers the strokes, and not the actual quantity of water raised.²

¹ In Cornwall and Devon it is called an *adit*, in some other places a *sough*.

² In the year 1811, a number of the respectable proprietors of the valuable tin and copper mines in Cornwall resolved that the work which their respective steam engines were performing, should be ascertained, as it was suspected that some of them might not be doing duty adequate to the consumption of fuel; and for the greater certainty of attaining their object, it was agreed that a counter should be attached to each engine, (art. 563.) and all the engines be put under the super-

intendence of some respectable engineer, who should report monthly the following particulars in columns: viz.

The name of the mine ;
the size of the working cylinder ;
whether working single or double ;
the load per square inch in the cylinder ;
length of stroke in the cylinder ;
the number of pump lifts ;
the depth in fathoms of each lift ;
diameter of pumps in inches ;
time worked ;
consumption of coals in bushels ;
number of strokes during the time ;
length of stroke in pump ;
load in lbs. ;
lbs. lifted one foot high by a bushel of coals ;
number of strokes per minute ;
and, lastly, a column for name of engineer and remarks.

Messrs. Thomas and John Lean were appointed to the general superintendence ; and the different proprietors, as well as the regular engineers of the respective mines, engaged to give them every facility and assistance in their power. The first monthly report was for August 1811. See *Phil. Mag.* vol. xlvi. p. 116. See also Appendix.

PART OF A MONTHLY REPORT CONTAINING SIX OF THE MOST EFFECTIVE ENGINES, IN DECEMBER 1826;

THE WHOLE NUMBER REPORTED ON, FORTY-SIX.

Mines.	Diameter of cylinder.	Load per square inch on the piston.	Length of the stroke in the cylinder.	Number of strokes per minute.	Number of lifts.	Depth of lift.	Diameter of pump.	Consumption of coals in bushels.	Number of strokes.	Length of stroke in the pump.	Load in lbs.	lbs. lifted one foot high by consuming one bushel of coals.	Remarks and Engineers' names.
		lbs.	ft. in.		fath. ft.	inches.				feet.			
Wheal Hope.	60 inch single	8.37	9 0	5.5	1 1 1	46 5 11 2 11 2	15 12 $\frac{1}{8}$ 11	1242	261,890	8.0	27,766	46,838,246	Drawing all the load perpendicularly. Main beam over the cylinder. One balance-bob at surface. <i>Grose.</i>
Wheal Vor.	80 inch single	13.37	10 0	5.56	5 4 1 1	135 2 44 0 12 0 11 5	15 16 9 $\frac{1}{2}$ 9 $\frac{1}{4}$	3274	199,960	7.5	89,607	41,045,698	Drawing perpendicularly 135 fathoms, and on the underlay 27 fathoms. Main beam over the cylinder. Two balance-bobs under ground. <i>Sims and Richards.</i>
Consolidated Mines.	90 inch single	9.42	9 11	8.12	1 1 6	6 0 15 0 144 1	12 12 16	4680	304,500	7.5	81,673	39,854,853	Drawing perpendicularly, with main beam over the cylinder. One balance-bob at surface. <i>Woolf.</i>
Dolcoath.	70 inch single	10.05	8 9	6.3	1 5 1 3 1	2 0 93 1 22 0 65 1 15 3	8 $\frac{1}{2}$ 11 $\frac{1}{2}$ 12 11 $\frac{3}{4}$ 13	2660	264,970	7.25	35,021	39,375,762	Drawing perpendicularly 179 fathoms, and on the underlay 33 fathoms. Main beam over the cylinder. Four balance-bobs under ground, and one at the surface. 60 fathoms of dry rods in the shaft. <i>Jeffrees.</i>
Ting-Tang.	63 inch single	13.4	7 9	6.1	2 4 1 1 1	39 0 81 3 20 3 11 3 12 0	9 14 12 9 8	1980	229,520	6.75	48,646	38,063,288	Drawing perpendicularly, with main beam under the cylinder. 15 fathoms of horizontal rods under ground. <i>Sims and Sons.</i>
Binner Down.	70 inch single	6.12	10 0	8.6	1 1 1	2 5 23 2 40 4	10 9 18	2628	420,550	7.5	31,395	37,680,271	Drawing all the load perpendicularly. Main beam over the cylinder. <i>Thomas.</i>

The engineers' names are given who plan the construction and superintend the execution and erection of the engines, for which they are paid in proportion to the power; they also attend to them afterwards, and direct such renewals or repairs as may be necessary, at fixed salaries. The principal manufacturers of engines for the Cornish mines are Messrs. Trevenan, Carne, and Wood; Messrs. Harvey and Co.; Messrs. Fox and Co.; and Messrs. Price and Co.

577. The depth of the pump shaft of a mine is divided into lifts of not more than twenty-five or thirty fathoms, if it can be avoided, with a cistern at each lift, consequently the water is raised from cistern to cistern. The size of the pumps is seldom greater than sixteen inches in diameter, and it will always be found better to make an additional set than to exceed this size.

578. The engines most adapted for economy of fuel are described in art. 411 and 419; those which are most simple, in art. 393 and 400; and as it frequently happens that engines have to be removed from place to place, an engine supported by frames of cast iron is shown in Plate XI.

579. For drawing ores and coals, a double engine of from twenty to thirty horse power is used; the size of the cylinder should be such, that the power shall be equal to the resistance when the stress is the greatest; hence, engines for this purpose require more fuel to raise the same quantity of matter a given height, and there is also much loss of effect through stoppages, changes of motion, &c. When 1 lb. of coal raises 70,000 lbs. of ore, it is about the maximum quantity in irregular work of this kind. The weight of matter drawn at once is from 3 to 7 cwt. The weight of a rope is about $.27 c^2$ lbs. per fathom; when c is the circumference in inches: the greatest stress on a rope should not be more than 700 times the weight of a fathom of the rope; and the stress on the engine should be equalized by the rope winding on to a spiral drum,¹ like the fusee of a watch, by which the expense of the engine, and the expenditure of fuel would be reduced. The engine should work expansively, (art. 419.) and be equalized by a fly wheel, (art. 540.) and regulated by a governor, (art. 550.)

When an inclined plane is necessary under ground, a small high pressure engine is sometimes used to draw the coals to the principal shaft, of the kind described in art. 371.

580. Engines are also employed to break ores by means of stampers, a process which seems capable of much improvement. Double engines are employed to raise the stampers by means of cams; and as the power of the engine is nearly uniform, the space through which the stamper is raised, should increase

¹ See Encycl. Métho. Dict. de Chimie et Métallurgie, Seconde Partie, Planche 20; or Gilpin's Method, Transactions of the Society of Arts, vol. xxv. p. 76.

at first in the proportion due to an uniform force; otherwise the motion will be irregular, and the loss of power considerable. The weight of a stamper is usually made about 190 lbs., and the height it is raised about 2 feet; and not less than two-thirds of the stampers should be rising at any instant of time.

WATER WORKS.

581. The same formulæ apply to water works as to other modes of raising water, when it is raised perpendicularly; but as this is seldom the case, instead of adding 1·5 feet for each lift, as in art. 572,

$$\text{add } \frac{v^2 L}{140 a} \text{ feet to the vertical height;}$$

where v is the velocity in feet per second, L the length of the main in feet, and a its diameter in inches: add also one-tenth of the height for the friction of the piston, and proceed in other respects as in the article referred to.

582. The supply of a town should be ten cubic feet per day for each house, and for the averaged sized houses this is not more than comfort and cleanliness requires; or two cubic feet per day for each individual, besides what is required for watering streets, for breweries, engines, and various purposes; and for these purposes two cubic feet more ought to be delivered in summer, making a total of four cubic feet per day for each person, for the greatest quantity: in small and open towns a less quantity of water is required; but even in these, two cubic feet and a half ought to be calculated upon.¹ In raising water by forcing, the air vessel should always be in the direction of the motion of the fluid, and not to one side of it; want of attention to this, causes those concussions to take place which tear the joints asunder, break the cranks, and spoil the machinery. Double engines with fly wheels are the most economical when fuel is dear, (art. 419.) and single engines where it is cheap, (art. 411 and 400.) See Plates XII. and XIII.

¹ The following table is compiled chiefly from Leslie's Nat. Phil., with some additions, and a more reasonable estimate of the quantity supplied to ancient Rome.

Towns.	Inhabitants.	Supply of water per day.	Each person per day.
London	1,225,694	3,888,000 cubic feet	3·15 cubic feet
Edinburgh (old service)	138,235	80,640 _____	0·61 _____
Rome (modern)	136,000	5,305,000 _____	39·0 _____
Rome (ancient)	1,200,000	10,500,000 _____	9·0 _____
Paris	713,765	293,600 _____	0·42 _____
Plymouth	21,570	33,400 _____	1·56 _____

OF IMPELLING MACHINERY FOR MANUFACTURING PURPOSES.

583. IRON MANUFACTURE. In this manufacture the steam engine is applied to blowing machines, forge hammers, rolling, flatting, and slitting machines, and various other purposes.

584. BLOWING MACHINES. The object of this machine is to supply oxygen to furnaces, either for melting or reducing ores to the metallic state; hence, in order that the effect may be the same, or nearly so, when the same fuel is used, the supply of oxygen should be the same. But in the same bulk of dry air there is nearly 10 per cent less oxygen at 85° than at 32° ; and 12 per cent less when the air at 85° is saturated with vapour; consequently, if 1500 feet per minute be a sufficient supply for a furnace in winter, it may require 1625 feet per minute in summer, to have the same effect; and the difference ought clearly to be gained partly by the aperture being enlarged, and partly by increasing the intensity of the blast.

The blast is usually produced by condensing the air, till it will sustain a column of from four to six inches and a half of mercury, (one and a half to two lbs. per circular inch,) according to the quality of the coal; and the mean between these is most generally found to answer: the quantity discharged varies from 3000 to 1200 feet per minute.

If v be the velocity of the piston of a blowing cylinder in feet per minute, p the force of compression in lbs. per circular inch, and a the diameter of the blowing cylinder in inches, then, allowing that the friction increases the power from 1 to 1.25, we have $1.25 p v a^2 =$ the power in lbs. raised one foot high per minute, when the stroke is effective in both directions, and half that when in one direction only.¹ The capacity of the air chest should be proportioned by the principle given in art. 211, and the passages to it should be about one-twentieth of the area of the cylinder. The quantity of air delivered into the chest will be about one-fifth less than the capacity of the cylinder, when taken at atmospheric density, partly through escape by the valves, and by the air not entering till the space within the cylinder is rarefied so as to produce the velocity.

For this as well as all other parts of iron manufacture, the double acting condensing engine, prepared to work either expansively or at full power, will be found the best. (See art. 421.)

¹ The rule is only an approximation, but nearly correct for small degrees of compression; in greater ones the principles of the note to art. 377 should be applied.

585. COTTON MILLS. The steam engines best adapted for cotton mills are double acting engines working expansively. The mean pressure on the piston of an engine of this kind, using low pressure steam, when working with the greatest advantage, is about five pounds per circular inch, (art. 420.) and each circular inch of the piston may be estimated to drive three spindles of cotton yarn twist with the preparatory machinery. And for mule yarn with its preparation, if 15 be added to the number of the yarn,¹ and the sum be multiplied by $\cdot 26$, the result will be the number of spindles for each circular inch of the piston. Thus if it be No. 40, then $40 + 15 = 55$, and $\cdot 26 \times 55 = 14$ spindles.

It is somewhat more accurate to estimate the power of the engine in horse power, and then one horse power will drive 100 spindles with cotton yarn, and the preparatory machinery. And add the number of the yarn to 15, and multiply the sum by 8, and the result will be the spindles that are equivalent to one horse power of mule yarn with preparation.

One horse power will work twelve power-looms with preparation.²

The day's work, supposing it to be 11 hours, ought to be done with about 90 lbs. of the best caking coal for each horse power.

586. PAPER MILLS. Steam engines are also used extensively in making paper; for where the supply of water is regular, it has acquired a value equivalent to steam power, while the latter possesses many advantages.

A beating machine requires about seven horse power to work it; the new machines for making paper, from two to two and a half horse power; and three and a half horse power will prepare one ton of old rope in a week, when the machine works ten hours per day.³

OF IMPELLING MACHINERY FOR AGRICULTURAL PURPOSES.

587. In farming, there are few things that admit of the employment of steam power with economy; but where it is employed at all, it is an advantage to apply it to as many purposes as possible.

The species of work to which it is susceptible of application, are—thrashing and

¹ The number is the hanks to the lb. of yarn, and a hank appears to be 120 yards. A spindle produces two hanks per day at an average, and the waste in spinning is about 10 per cent.

² Brunton's Compendium, p. 109.

³ Fenwick's Essays, third edition, p. 62.

winnowing grain, chaff-cutting, grinding bones for manure, and to grinding corn for fattening cattle and for family uses.

The boiler may be further applied to steam food for cattle. No other objects occur to me, except to notice, that for drainage in fenny districts, and for irrigation in others, it is worthy of the landowner's consideration, whether its application would or would not repay the expense.¹

588. THRASHING. Thrashing machines to be driven by a steam engine are made from four to six horse power; and the usual proportions are,

The feeding rollers 35 to 37½ revolutions per minute, diameter 3½ inches.

Straw rakes 30 revolutions per minute, diameter 3½ feet.

Drum 300 revolutions per minute, diameter 3½ feet.

The drum has four beaters faced with strong iron plate; and a cylindric frame with four sets of teeth, five inches long, attached to its circumference, forms the straw rake.²

The breadth of the machine, or length of the rollers to receive the feed, is limited by the width to which one feeder can attend in a proper manner, and about from four to five feet is the range: the thickness of the feed cannot be materially altered from that which gives the best effect; and therefore there is only the velocity in which the power can be altered beyond the small change in width. The quantity of wheat thrashed by a machine four feet in breadth varies, according to its quality, from twelve to twenty-four Winchester bushels per hour, and from sixteen to thirty bushels of oats per hour.

The power required is 100,000 lbs. raised one foot per minute when for thrashing, and 133,000 raised one foot per minute when winnowing machinery is also

¹ By a single engine, (art. 411.) 280,000 cubic feet of water may be raised one foot high by one bushel of coals, and for any other height divide 280,000 by the height in feet. It will require an engine of one horse power to work eleven hours and a half per day, to raise that quantity daily. The expense will be about £8 per annum for each horse power, to return the first cost, and pay for the renewals and repairs of the engine; the fuel is one bushel of coals per day for each horse power; and one man and boy will attend an engine of ten or twelve horse power, and also partly to the distribution of the water: the quantity required for an acre would be about 500 cubic feet per day, and therefore an engine of ten horse power would supply 560 acres, if it had to be raised ten feet, at a cost which in few cases could exceed ten shillings per acre if continued for six months per year. On proper lands for the purpose, the return would be ample, and a more perfect mode of applying water to land will very probably be discovered.

² The straw advances so that each inch receives three strokes of the beaters; and the stroke should be made with a velocity of about 55 feet per second, or the beater should move at the rate of 3300 feet per minute; these conditions being attended to, the parts may be, in other respects, arranged as the engineer pleases.

worked ; other sized machines nearly in proportion to their breadth : this supposes the machine to be well made and kept in tolerable order.

The proper species of engine for farm use is the double engine (art. 414 and 419.) with slides, and the whole arranged in the most simple and obvious manner.¹

589. CORN MILLS. The mean quantity of power required to grind and dress a Winchester bushel of wheat per hour is 31,000 lbs. raised one foot per minute, and the best velocity for the circumference of a millstone is twenty-three feet per second ; and with this velocity a pair of five feet stones will grind from four to five bushels per hour, according to their condition and the state of the grain : the double expansive engine should be used for this kind of work ; and when working to the best advantage with low pressure steam, it should grind fourteen bushels of wheat for each bushel of coals, and the average should be eleven bushels and a half for one bushel of coals.² The same species of engine with strong steam will of course do more work with a given quantity of fuel. (See art. 419.)

OF THE APPLICATION OF STEAM POWER TO CARRIAGES.

590. The application of a power within a carriage to move it, is a subject that at an early period engaged the attention of speculative men. Some of their schemes are described by Emerson in his 'Mechanics,' and he gives an example of calculation there (Ex. 20. p. 194.) which seems to be very little understood. The object of it is to determine the power required to move a waggon ; but in fact it simply determines the relation of the forces, the power being the same whether it be in the waggon or out of it, provided it does not add to the weight of the waggon. But power cannot be gained without adding weight ; and in steam carriages the whole mass of the engine, with its boiler and fuel and water, has to be moved as well as the load ; and in order to keep the engine as simple and light as possible, and to avoid the weight of water and complexity of a condensing apparatus, high pressure steam is always employed.

The idea of employing steam as a moving power has been considerably

¹ If an engine be applied for irrigation, it may have the thrashing machine attached when the situation is convenient ; but in that case a double engine should be used.

² For 6.5 lbs. per hour is equal to a horse power, (art. 419.) and a bushel of coals being thirteen times this quantity, it is equal to thirteen horse power per hour ; and 31000 : 33000 : : 13 : 14, nearly.

ridiculed, and some of the schemes for applying it not without reason. As far as railways are concerned, it has however been proved to be applicable, and with as few accidents as in any other of the varied applications of steam power.¹

591. OF THE APPLICATION OF STEAM POWER TO RAILWAYS. The power of steam may be applied by means of a fixed engine, or by a moveable one called a *steam carriage*.

FIXED ENGINES have been applied only in the case of inclined planes, and no peculiarity is required in the construction of the engines, more than is wanted in one for impelling a machine. Low pressure engines are generally employed for this purpose; and they are obviously the most safe and economical for the end, unless when there is not a convenient supply of water.

The motion of the engine ought to be equalized by a fly wheel, and it should also be provided with a regulating valve.

To proportion the power of the engine to the effect, the area of the piston in inches, multiplied by the effective pressure on an inch in lbs., should be equal to the resistance of the carriages added to the friction of the rope and the engine.

If A be the ascending, and D the descending load, and q the resistance from friction at the axis, and i the angle of inclination,

Then $A (\sin. i + q) - D (\sin. i - q) = (A - D) \sin. i + (A + D) q =$ the resistance of the carriages.

The weight of the rope or chain, and of the moveable parts of the engine, being C, its friction and the stiffness of the rope may be represented by C S, hence,

¹ On common roads there are several circumstances which prevent the application of steam power. The undulations of the road render it necessary to provide a power competent to ascend the greatest inclination, and consequently an immense addition must be made to the weight of the engine, so as to make the engine itself on an ordinary road consume half the power it generates. The resistance of these roads may be reduced by using larger wheels, as it chiefly arises from the wheels sinking into the road; and larger wheels afford a greater surface without increasing the quantity to be depressed, while broad wheels give very little if any advantage. See my book on 'Rail Roads,' p. 44. It may be proved, that no species of feet can be applied that will require less power than plain wheels. An animal is contrived to move among obstructions, and when we attempt to copy from the beautiful arrangements of our Creator, we should never lose sight of their object. It is their perfect adaptation to the end, and their accomplishment by the most simple means, that excites our admiration; and the more we study the fine examples of the application of power which nature affords, the more we feel the advantage of knowing the first principles which determine the action of natural forces.

if a be the diameter of the piston, and p = the pressure on a circular inch, we have,

$$a^2 p = (A - D) \sin. i + (A + D) q + C S.$$

From this the diameter of the cylinder is easily found, and in all cases

$$q = \frac{r f}{R},$$

where R is the radius of the wheels of the carriage, r that of the axles, and f the friction, when the pressure is 1.

Also

$$S = \frac{x f}{X},$$

where X is the diameter of the pulleys, and x that of the axes. When the railway is level,

$$a^2 p = (A + D) q + C S.$$

In these equations the piston of the engine, and the load, are supposed to move at the same velocity.

592. STEAM CARRIAGES. The engines of steam carriages are double non-condensing engines, of the kind described in art. 372. They have generally two cylinders. If,

p be the mean effective pressure on the piston,

a the diameter of the cylinders,

v the velocity in feet per minute;

i the angle of inclination of the rails of the road,

q the friction of all the axes,

W the weight of the carriages and their loads,

V their velocity in feet per minute,

and E the weight of the engine.

Then, $V (W + E) (q + \sin. i) = 2 a^2 p v$, in ascending the inclination;

and, $V (W + E) (q - \sin. i) = 2 a^2 p v$, in descending the inclination.

Also

$$\frac{E (.08 \cos. i - \sin. i)}{q + \sin. i} = W,$$

so that the engine may not slide in ascending; and

$$\frac{E (.08 \cos. i + \sin. i)}{q - \sin. i} = W,$$

when it will not slide in descending.

In either case,

$$q = \frac{r}{8R};$$

when r is the radius of the axle, and R the radius of the wheels.

The engines should work expansively when moving at the ordinary rate, and upon the mean inclination, with the power of working at full pressure on the steeper ascents. See Sect. v. art. 371—380.

For further information respecting steam carriages and railways, see the Appendix.

SECTION X.

OF STEAM NAVIGATION.

593. ON the value of the application of steam to impel vessels, it has become unnecessary to say more than that its employment is extending rapidly at almost every place on the globe where the trade is considerable, and that its use is limited only by its yet imperfect state. If we had intended to have confined our researches to the mere application of an engine to a vessel already constructed, our labour would have been short, and easily completed: but the construction of vessels is a subject which is capable of improvement; and while we think there is a power in science to indicate the steps by which it may be improved, it is our duty to submit it to the reader.

The forms of vessels for stability, speed, capacity, and strength; the kinds of vessels for different purposes, the resistance, and modes of propulsion; the nature of the engines adapted for vessels, the strength of their parts, and the species of fuel, and its management to obtain the best effect; are all objects of importance, and each of these we propose to consider.

These inquiries are equally applicable to mercantile and to government purposes, but there is yet another portion of the subject to which it would be desirable to direct attention.

In the case of war, steam boats will become a means of attack; therefore it ought to be considered how far they may become a means of defence, the power of resisting being the best guard against a mode of attack, which will deprive us of many of the advantages of our insular state. Hence, the construction of gun boats for the defence of rivers, and of river navigation, and harbours, would be a proper subject for inquiry, if our limits did not forbid it.

OF THE FORMS OF VESSELS FOR STABILITY, SPEED, CAPACITY, AND STRENGTH.

594. In considering the properties of a vessel, the orderly arrangement of our subject requires that we should treat,—First, Of stability, or the power a vessel

has of resisting any change of position when in the water; Secondly, The forms having stability which have the least resistance, and are therefore best adapted for speed; Thirdly, The different methods of propelling vessels; and Fourthly, The construction for strength.

OF THE STABILITY OF VESSELS.

595. A perfectly spherical ball floating in a fluid has no stability whatever, except that which arises from the friction of the fluid against its sides. On the addition of a small weight to any point of its surface, that point would immediately descend, and become the lowest: such a form would be useless as a vessel. It is obvious, however, that when a weight has been added, and become the lowest point, the sphere possesses a degree of stability depending on the quantity of weight, compared with the weight of the sphere itself. Hence, stability may be given by disposing the weight of a floating body.

Stability may also be given by the form of the floating body: a spheroid, for example, remains in stable equilibrium when its longer axis is horizontal, and a triangular prism resists change of position with considerable energy from its peculiar form; so does a thin rectangular prism.

596. Stability is distinguished by its being *longitudinal* or *lateral*; these should be separately considered, and when each is the greatest possible, their joint effect will be a maximum.

597. For river navigation, the mode of obtaining stability does not appear to be of much importance, but for a sea vessel it must be obtained, so that the vessel may have the least motion possible in consequence of the action of the disturbing forces; hence, it is necessary to consider that the sea is not a level surface at rest, and that at the time when stability is most important to a vessel, the greatest degree of unevenness occurs.

598. **LONGITUDINAL STABILITY.** A vessel at rest would be least disturbed by the motion of the sea, if its surfaces at the water line were vertical ones, and the fore and aft parts of the same figure; but in motion it is an advantage that the parts should spread above water, both fore and aft, to prevent the vessel burying its head in the wave, or dropping behind as the wave leaves it. The quantity of motion is not increased by this construction, provided the parts produce similar effects; and the degree of inclination should be proportioned to the velocity the vessel is expected to make. It is also obvious, that the vessel will be more easy in its longitudinal motions, the more gradually it terminates at its extremities. If the vessel be inclined by the action of a lateral force, the longitudinal motions

will be more easy, in proportion as the cross section approaches to that of a solid of revolution.

599. LATERAL STABILITY. The inequality of the surface of the sea will alone produce considerable lateral motion, if the sides be not sensibly vertical; hence, in sea vessels lateral stability should not be obtained by form at the surface of the water. The next important point is, that the stability should be equal throughout the length.

To render it easier to manage the inquiry, we may consider the vessel to be a homogeneous mass of matter, with vertical or circular surfaces at the water lines when at rest; and that it is of a parabolic form, having the equation $px = y^n$, taking the two cases when the ordinate y is the half breadth, and when it is the depth; for these cases enable us to contrast very opposite forms.

600. The ordinates being *parallel to the depth*, we have the difference of the moments of the parabolic parts, when i is the angle the body makes with its position, and B D (Fig. 3. Plate xvi.) coincides with the water line =

$$\int y dx \left\{ \left(\frac{b}{2} - x \right) \cos. i + \frac{y}{2} \sin. i \right\} - \int y dx \left\{ \left(\frac{b}{2} - x \right) \cos. i - \frac{y}{2} \sin. i \right\} = \frac{n y^2 x \sin. i}{2 + n};$$

and the difference between this quantity and the moment of twice the area of the triangle B C b is the stability.

$$\text{But, } \frac{2}{3} \left(\frac{b}{2} \right)^3 \sin. i = \frac{b^3 \sin. i}{12} = \text{the moment of the triangles};$$

hence,

$$S = \frac{b \sin. i}{12} \left(b^2 - \frac{6 n a^2}{2 + n} \right), \text{ the stability.}$$

The capacity of the section is $\frac{n a b}{1 + n}$.

601. If the negative quantity be less than b^2 , the body has no stability; hence we see that a certain relation must hold between the breadth and depth, to render a vessel stable.

602. If the form be a triangle, then $n = 1$, and putting A = the area, we have,

$$S = \frac{b \sin. i}{12} (b^2 - 2 a^2), \text{ and } A = \frac{a b}{2}.$$

603. If the form be a common parabola, then $n = 2$, and

$$S = \frac{b \sin. i}{12} (b^2 - 3 a^2), \text{ and } A = \frac{2 a b}{3}.$$

604. If the form be a cubic parabola, then $n = 3$, and

$$S = \frac{b \sin. i}{12} (b^2 - 3.6 a^2), \text{ and } A = \frac{3 a b}{4}.$$

605. If the form be a parabola where $p x = y^5$, as in Fig. 3. Plate XVI. then,

$$S = \frac{b \sin. i}{12} (b^2 - 4.3 a^2), \text{ and } A = \frac{5 a b}{6}.$$

606. The stability and capacity both increase as the ordinate of the parabola becomes of a higher power, but a greater breadth is necessary in proportion to the depth.

607. When the ordinates are *parallel to the breadth*,

$$\begin{aligned} \int y dx \left(\frac{y}{2} \cos. i + (a - x) \sin. i \right) - \int y dx \left(\frac{y}{2} \cos. i - (a - x) \sin. i \right) \\ = 2 \sin. i \int y dx (a - x) = \frac{2 n^2 a^2 y \sin. i}{(n + 1) 2 n + 1}; \end{aligned}$$

and,

$$S = \frac{b^3 \sin. i}{12} - \frac{2 n^2 a^2 b \sin. i}{(n + 1) (2 n + 1)} = \frac{b \sin. i}{12} \left(b^2 - \frac{12 n^2 a^2}{(n + 1) (2 n + 1)} \right).$$

The capacity is $\frac{n a b}{n + 1}$ as before;

and in the case of the triangle we have the same results.

608. But if the form be a common parabola, or $n = 2$, then

$$S = \frac{b \sin. i}{12} (b^2 - 3.2 a^2), \text{ and } A = \frac{2 a b}{3}.$$

609. If the form of the parabola be $p x = y^5$, as in Fig. 4. Plate XVI. then,

$$S = \frac{b \sin. i}{12} (b^2 - 4.5 a^2), \text{ and } A = \frac{5 a b}{6}.$$

610. This species of figure may be easily traced through all the varieties of form, and it is so easy to compute its capacity and to describe it by ordinates, that it is much to be preferred to the elliptical figures which foreign writers have chosen for calculation.¹ The breadth should be every where in the same ratio to the depth, to render the stability equal throughout the length, or so that the vessel may undergo no strain from change of position.²

¹ For a mode of describing curves of this kind, see my 'Principles of Carpentry,' Sect. i. art. 58.

² For other methods see Bossut's Hydrodynamique, tom. i. chap. xiii. et xiv; or Poisson's Traité de Mécanique, tom. ii. p. 389.

OF THE RESISTANCE OF VESSELS.

611. The resistance of a vessel moving in a fluid increases from the commencement of the motion, till it is equal to the moving force, and then the motion becomes uniform. It is the resistance at this uniform motion only, which we have to consider.

In order to assist in the first steps of the inquiry, let us confine ourselves to a prismatic vessel with flat ends, moving in the direction of its length.

612. The resistance of such a prism would be nearly equal to the head of water, which would give the water in a canal of the same length, and one and a half times the section of the immersed part of the prism, the same velocity as the prism.

For let AB be that head; then the resistance to efflux at D must be equal to the resistance to motion at C , the section being the same; otherwise the motion would accelerate. But the fluid will rise at C , and fall at D , till the difference be equal to the head due to the velocity of the boat; and the efflux at D must

FIG. 25.

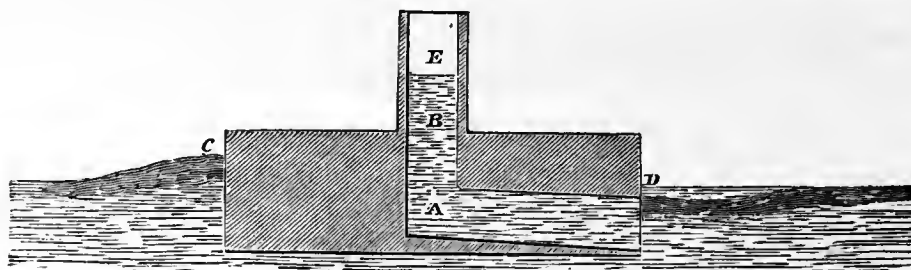

both supply a void with fluid equivalent to the velocity of the boat, and supply a resistance equal to the head pressure. This will be the case when two-thirds of AB is the head corresponding to the velocity. Hence, if v = the velocity, $AE = h$, and $BE = x$ = the head equivalent to the friction,

$$v^2 = \frac{64(h-x)}{1.5};$$

where 64, neglecting a small fraction, is the proper coefficient for the motion of a fluid when free from friction or cohesion; consequently,

$$x = h - \frac{1.5 v^2}{64}.$$

613. Now if c be the perimeter of the section in contact with the fluid, and a its area, l the length of the vessel, and $F = 64$ times the friction when the surface is 1, we have,

$$x = \frac{c F v^2}{64 a},$$

the head equal to the friction being nearly as the square of the velocity directly, and the area inversely, and the friction being as the surface of the fluid put in motion, or the rubbing surface of the vessel.

These two values of x must therefore be equal, hence

$$h - \frac{1.5 v^2}{64} = \frac{l c F v^2}{64 a};$$

or the whole head is,

$$h = \frac{1.5 v^2}{64} + \frac{l c F v^2}{64 a}.$$

But the resistance being usually estimated in lbs., we have for sea water $64 h a$ = that resistance, = $v^2 (1.5 a + l c F) = R$, the resisting force; and the power required is as the force and velocity = $v^3 (1.5 a + l c F) =$ the lbs. raised one foot per second, when F is in lbs.

614. For fresh water put 1.45 in the place of 1.5, but the correction is not necessary in practice. The coefficient F is 0.0032 lbs. found from experiment.

615. If the body have a simple angular prow, and an after body of the same figure, and α be the angle the prow forms with the direction of its motion, and β the angle of the after part, then the pressure on its surface depends on the velocity of the surface, in a direction perpendicular to itself. This velocity before is $v \sin. \alpha$; and behind $v \sin. \beta$; being to the velocity of the vessel as the sine of the angle is to radius; and therefore the resistance would be,

$$v^2 \left(\frac{2 a \sin.^2 \alpha + a \sin.^2 \beta}{2} + l c F \right).$$

The effect of this head in the direction of the motion of the vessel is as the sine of α to radius at the prow, but the quantity of fluid required to fill the void behind is constant for the same angle; hence the resistance is,

$$v^2 \left(\frac{2 a \sin.^3 \alpha + a \sin.^2 \beta}{2} + l c F \right) = R,$$

and,

$$v^3 \left(\frac{2 a \sin.^3 \alpha + a \sin.^2 \beta}{2} + l c F \right) = \text{the power in lbs. raised one foot per second.}$$

This gives the resistance when the vessel is of a wedge shape at both ends, or of any regular pyramidal form, α being the angle the slant side of the pyramid makes

with the length; also when the body terminates either in cones or pyramids, the angles being those the slant sides form with the length.

616. If the section be a triangle, and the ends triangular pyramids, β being the angle the side of the triangle forms with the upper surface, then, if q be the product of the $\sin. \alpha$, by $\sin. \beta$, the resistance will be,

$$v^3 \left(\frac{a(2q^3 + q^2)}{2} + 0.0032 lc \right) = \text{the power in lbs. raised one foot per second.}$$

The resistance of this figure is less than that of any convex curved solid, but its capacity is also small; and its stability depending on the form at the water lines, it will be subject to roll at sea. Great capacity cannot be obtained with a minimum of resistance.

617. If the plan of the water lines be composed of circular arcs, the bottom flat, and the radius be m times the half breadth of the boat, and z be the length of the curved part, r = the radius, and a the depth, which is uniform; then $3z = r(4\sqrt{2m} - \sqrt{2m - m^2})$, and

$$v^3 a \left(\frac{3z - r(1-m)(3-4m)\sqrt{2m}}{4} + \frac{(2-2(1-m)\frac{1}{3}(1-m)^2 + 3m)r}{3} + \frac{.0032 lc}{a} \right) =$$

the power in lbs. raised one foot per second, required to keep the vessel in motion at the velocity v .

618. In canal boats $m = \frac{1}{3} = .125$, or the radius is 4 times the breadth, and therefore $v^3 (.35 ab + .0032 lc) =$ the power in lbs. raised one foot per second.

If the radius be equal the breadth, then $m = .5$, and $v^3 (.74 ab + .0032 lc) =$ the power in lbs.

619. Mr. Bevan made some experiments with a canal boat of the form just described, the results of which he has communicated to me for the purpose of comparing theory with practice.

The length of the boat was 69.57 feet, its width 6.83 feet, its floating depth when tried 0.89 feet; the bottom was flat, and the sides were parallel to within about 13.75 feet of each end, but the ends were curved, the curves being circles described by a radius of 8 times the half breadth of the boat. The whole surface in contact with the water was 540 feet; and the weight was $9\frac{1}{4}$ tons. Putting these numbers in the equation (art. 618.) we have

$$v^2 (.89 \times 6.83 \times .35 + .0032 \times 540) = 3.8 v^2 = \text{the resistance.}$$

Velocity.		Resistance in lbs.	
Feet per second.	Miles per hour.	By experiment.	By calculation.
feet.	miles.	lbs.	lbs.
1.0			3.8
1.31	0.89	6.1	6.5
1.98	1.35	14.0	14.8
2.93	2.00	28.0	32.5
3.666	2.50		51.0
4.30	2.92	56.0	70.0

The agreement is sufficiently near for practical purposes.

620. The area of the bottom being 417 feet, a ton will sink it an inch. The increase of section by adding a ton to the load is therefore $\frac{6.83}{12} = .57$ feet; and the increase of surface 12 feet. Adding each ton must therefore increase the resistance about 3.2 lbs., at the velocity of $2\frac{1}{2}$ miles per hour; therefore the load in tons multiplied by 3.2, added to 51 lbs. for the boat, will give the force required to draw it. Thus if the load be 20 tons, the force of traction will be $20 \times 3.2 + 51 = 115$ lbs.

621. The forms used for vessels are generally curved surfaces of double curvature. To investigate these we may consider them divided into gores, having their bases at the section, and meeting in a point at the water line. A solution on this supposition is fully sufficient for practical objects. Let r be the radius of curvature of the gore, and c its breadth at the base, a being its distance from the axis. Then the differential of the area of the section occupied by the gore will be,

$$c \, dx - \frac{c \, x \, dx}{a};$$

and,

$$v^2 c \left(1 - \frac{x}{a}\right) dx \left(\frac{2 \sin.^3 a + \sin.^2 a}{2}\right) = \text{the resistance from pressure.}$$

By using the approximate equation, $2 r x = y^2$, we have

$$dx = \frac{y \, dy}{r}, \text{ and } \frac{y}{r} = \sin. a,$$

hence,

$$v^2 c \left(\frac{y^4}{r^3} + \frac{y^3}{2 r^3} - \frac{y^6}{2 r^5 a} - \frac{y^5}{4 r^4 a}\right) dy = \text{the differential of the resistance.}$$

Its fluent is,

$$\frac{v^2 c y^4}{r^3} \left(\frac{y}{5 r} + \frac{1}{8} - \frac{y^3}{14 r^2 a} - \frac{y^2}{24 r a}\right) = \text{the direct resistance.}$$

Putting $y = \sqrt{2 r x}$, and $b = 2 x$; $x = a = \frac{r}{n}$, and correcting by comparison with particular cases, we have,

$$v^2 c \left\{ \frac{b}{n} \left(\frac{.1617}{\sqrt{n}} + 0.0833 \right) + .0032 \left(l + .29 b \sqrt{1 + 2 n} \right) \right\} = \text{the resistance in lbs.}$$

622. Now, by taking a radius that will describe an arc nearly agreeing with the form, the resistance will be found with tolerable accuracy, even in the most complicated forms; and in cases where the curve is a circle, it will be very near the truth. To render it more easy to make such calculations, the following table is added, with examples to explain its application.

Radius of curvature in half breadths.	Equations for different radii of curvature.
1	$v^2 c \left(.245 b + .0032 (l + .5 b) \right) = \text{resistance}$
1.25	” .188 - + ” + .545 ” = resistance
1.50	” .146 - + ” + .58 ” = resistance
1.75	” .120 - + ” + .616 ” = resistance
2	” .101 - + ” + .65 ” = resistance
2.25	” .086 - + ” + .68 ” = resistance
2.5	” .075 - + ” + .71 ” = resistance
2.75	” .067 - + ” + .74 ” = resistance
3	” .060 - + ” + .77 ” = resistance
4	” .041 - + ” + .87 ” = resistance
5	” .032 - + ” + .955 ” = resistance
6	” .025 - + ” + 1.05 ” = resistance
7	” .021 - + ” + 1.13 ” = resistance
8	$v^2 c \left(.018 b + .0032 (l + 1.2 b) \right) = \text{resistance}$

In this table b is the breadth of the vessel at the surface of the water, l the length of the part which is parallel, c the girt from water edge to water edge, of the lower part of the midship section, v the velocity in feet per second, and the result is the resistance in lbs. To find the power, multiply the resistance again by the velocity; or use the cube instead of the square of the velocity in the above table, the result is the lbs. raised one foot per second.

623. Required the resistance of a vessel of which the breadth is 22 feet, the length of the parallel part 80 feet, and the girt of the midship section 31 feet, when the velocity is 10 feet per second, and the radius of curvature equal 4 half breadths.

In this case, by the table we have,

$$v^2 c \left(.041 b + .0032 (l + .87 b) \right) = 10^2 \times 31 \left(.041 \times 22 + .0032 (80 + .87 \times 22) \right) =$$

3778·9 lbs. for the resisting force ; consequently the power is $10 \times 3778\cdot9 = 37789$ lbs. raised one foot per second ; and as 550 lbs. raised one foot per second is a horse's power, the resistance is equivalent to $\frac{37789}{550} = 68\cdot7$ horse power.

As ten feet per second is six nautical miles per hour, or nearly seven common miles, and the power required is as the cube of the velocity, it is easily ascertained.¹

OF THE METHODS OF PROPELLING STEAM VESSELS.

624. Much of the advantage of steam power depends on its being commodiously and effectively applied to propel vessels. A slight review of these methods will therefore enable us to judge whether or not the most effective and commodious have been resorted to.

The first and most simple and ancient method of applying a power within a vessel to move it, is by means of oars, and the mode of combining them appears to have been carried to a considerable degree of perfection. Oars, however, are not at all adapted to move a large vessel ; they occupy too much space, and would require too complicated a system of machinery to move them. Second : next in simplicity, and perhaps also next in time, is the method of putting a wheel like a water wheel, with paddle boards on each side of the vessel. This mode is now almost universally followed. Third : an ingenious combination of parts has been proposed, to be constantly under water, and to fold up into a small space when they are moved forward, and spread when striking backward. Fourth : inclined planes placed behind the vessel, and moved with an alternating motion. Fifth : Daniel Bernouilli's method, proposed in 1752, consisting of planes immersed in the water, parallel to the sides of the vessel, which, turning in a collar, were to be moved in a plane, perpendicular to the keel. Sixth : a screw, resembling the water screw, working in a cylinder entirely immersed in the water.² Seventh : or two spirals or screws to work in opposite directions without a cylinder.³ And lastly : a pump

¹ Some recent valuable experiments by John Macneill, Esq., C. E., show that the preceding investigations and formulæ for the resistance of vessels, (which are far from being clear,) are not to be depended upon as accurate. See Appendix.—ED.

² It was proposed by Mr. Scott of Ormiston. Dr. Thomson's *Annals of Philosophy*, vol. xi. p. 438.

³ This method was partially tried by Mr. Whytock, (*Brewster's Philosophical Journal*, vol. ii. p. 39.) and is alluded to by Col. Beaufoy, who states it to have been brought from China ; and he attended to see an experiment on a considerable scale, made in Greenland Dock by Mr. Lyttleton. This gentleman had fixed to the stern-post of a Virginia pilot boat, a frame containing a large copper spiral, which, by a winch turned by two or more men, gave it a rotary motion : the effect was much less than expected, for, notwithstanding the boat was completely empty and considerable exertions used, the progressive velocity did not exceed the rate of two miles per hour.

to raise and propel water out behind the vessel: this mode was proposed by Bernouilli, and afterwards by Mr. Linaker.¹ These, with numberless variations, the greater part of which are obviously inferior to the methods in their simple form, have been proposed. Some of the best we propose to notice. Our selection must however be limited, because it must be confined to those which afford sufficient power in a convenient manner, and without being liable to injury by the violence of the waves, or to get out of order.

625. The species may be divided into two classes; viz. 1. those in which the action is continuous, or nearly so; 2. those which act at intervals. To the first class belong the second, sixth, and seventh methods; to the second, the first, third, fourth, fifth, and eighth.

Since, when the action is continuous, the area of the surfaces in action, multiplied by their resistance, must be equal to the area of the vessel, by the vessel's resistance when reduced to the same direction, it is obvious that all those which act at intervals only, must require to be of greater area than those which act continually. Hence, unless there be some other manifest advantage, this circumstance alone must determine us to reject all except the first class, and of this to take only the second, sixth, and seventh methods. Most of the others would require complicated action, and be inconvenient in practice. The first class also reduces to two; for the two opposite water screws without a cylinder give about the same effect as one with a cylinder; and this method, though it has not been used, deserves attention, from the circumstances of its being capable of acting wholly below the surface of the water, and in a direction parallel to the motion of the vessel, and only so far above the centre of resistance as is deemed necessary to stability. I can easily conceive that the trial of an experiment may be the means of condemning a very useful principle, merely through inattention to the proportions and mode of action.

OF THE SPIRAL PROPELLER OR WATER SCREW.

626. The acting portion is a spiral surface projecting from a cylindrical axis; and, in order that it may be at all effective, each point in the surface must revolve so rapidly, that the motion of that point in the direction of the axis must be greater than that of the vessel. Also if the angle of the spiral to the axis be constant, it is obvious, that by having more than one revolution, the rest add little to the effect, perhaps not equivalent to the additional friction.

¹ Buchanan on Propelling Vessels by Steam, p. 40.

Let $BAC = a$ be the angle which the screw forms with a line AB perpendicular to its axis; then during the time the boat would move from C to B , a point

FIG. 26.

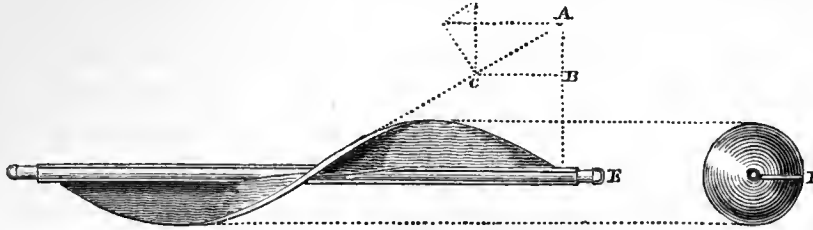

in the surface must move from B to A , otherwise it would retard the boat; and, in order that it may be effective, it must move at some greater velocity. But the velocity of the boat, v , is to that of a point in the surface when no effect is produced, as $BC : AB :: v : \frac{AB \cdot v}{BC} = \frac{v}{\tan. a}$. Hence the actual effective velocity must be,

$$V - \frac{v}{\tan. a} = \frac{V \tan. a - v}{\tan. a}.$$

Let x be the variable radius of the cylinder, then $\frac{2 \pi x}{\cos. a}$ = the length of the spiral, and $\frac{2 \pi x dx}{\cos. a}$ = the differential of its area. Its resistance is therefore,

$$\frac{\pi (V \tan. a - v)^2 (2 \sin. a^2 + \sin. a) x dx}{\cos. a \tan. a^2},$$

when the vessel is at rest; and when it is in motion, it increases in the ratio of $\frac{V \tan. a - v}{\tan. a} : v$; hence,

$\pi v (V \tan. a - v) (2 \sin. a^2 + \sin. a) x dx$ = the differential of the resistance.

The integral gives,

$$\frac{1}{2} \pi v x^2 (V \tan. a - v) (2 \sin. a^2 + \sin. a) = \text{the resistance.}$$

This resistance is to the effect to impel the boat, as the radius is to $\tan. a$; hence,

$$\begin{aligned} \frac{1}{2} \pi x^2 v (V \tan. a - v)^2 (2 \sin. a^2 + \sin. a) \tan. a &= \text{the force,} \\ \text{and } \frac{1}{2} \pi x^2 v^2 (V \tan. a - v) (2 \sin. a^2 + \sin. a) \tan. a &= \text{the effect,} \end{aligned}$$

which should be equal to the resistance of the vessel.

It is a maximum when $v^2 (V \tan. a - v) = \text{a max.}$: that is, when $V = \frac{3v}{2 \tan. a}$. Hence the effect at the maximum is $\frac{1}{4} \pi x^2 v^3 (2 \sin. a^2 + \sin. a) \tan. a$.

But the power to produce it must be, $\frac{3 \pi x^2 v^3 (2 \sin. a^2 + \sin. a)}{8}$, its velocity being

V. Consequently, when $\tan. a = 1$, the power is to the effect as 3 to 2, as in the ordinary paddle wheel ; but if $\tan. a = 1.5$, the power and effect are equal : on the contrary, if $\tan. a = .5$, or the angle C A B is about 26° , the power is to the effect as 3 : 1.

Now a little more than one revolution of the spiral would produce this effect, and a second revolution at the same angle could have very little action, because the water would have acquired all the velocity the spiral could communicate. If it be continued, it should therefore be made with a decreasing angle.

627. In practice the size corresponding to these effects is every thing ; our next object must therefore be to ascertain it. Taking an angle of 60° for the angle C A B, $\tan. a = 1.732$, and $\sin. a = .866$. The effect is in this case,

$$\frac{1.732}{4} \pi x^2 (2 \times .866^2 + .866) = 0.73 \pi x^2 ;$$

but πx^2 is the area of the end of the cylinder, therefore each foot of surface of the end of the cylinder will act with a force of 0.73 lbs. for one foot per second. The length of the cylinder would be $2 \pi x \tan. a = 10.8$ times its radius, or 5.4 times its diameter. The power required for this effect is,

$$\frac{3 \pi x^2 (2 \times .866^2 + .866)}{8} = .887 \pi x^2,$$

or 0.887 lbs. for each foot of area of the end of the cylinder, for one foot per second.

When $a = 40^\circ$, the effective force is only 0.4368 lbs. per foot, and the power to each foot must be .64 lbs. The power therefore decreases nearly in the same ratio as the length.

These calculations are sufficient to show that this method may be used with considerable advantage, the action being under water, and the projection from the side not so great as paddle wheels ; while the smoothness and the uniformity of the motion are circumstances much in its favour. On the other hand, the mode of communicating motion and the resistance the parts will offer that are applied for that purpose, are objections ; for the present I shall therefore content myself with recommending it to the notice of my readers.

PADDLE WHEELS.

628. The next inquiry is to ascertain the effect of paddle wheels. Of these the commonest species are plain boards, called paddle boards, fixed to the arms of a wheel ; these arms are as thin as is consistent with strength, and are connected by one or more thin iron rings, to act as braces in giving them firmness ; they are

sometimes made to slide on the arms, so as to reduce or increase the depth of immersion in the water, according as the vessel is more or less laden.

629. To determine their power, let V be the velocity of the exterior portion of the wheel, and r its radius; then the velocity at any distance $r-x$ from the centre is $\frac{V(r-x)}{r}$. But while the paddle acts on the water, the vessel moves forward, and the water recedes only at the rate of the difference between the velocity of the wheel and that of the vessel; therefore, if v be the velocity of the boat, $\frac{V(r-x)}{r} - v =$ the velocity with which the paddle strikes the water. Hence, as the quantity of water so struck and put in motion is nearly proportionate to the velocity of the vessel, we have,

$$1.5 v \frac{V(r-x) - r v}{r} = \text{the resistance to one square foot of the paddle;}$$

and, making $b =$ the breadth of the paddle,

$$\frac{1.5 v^2 (V r - V x - r v) b dx}{r} = \text{the differential of the effective power.}$$

The integral is

$$\frac{1.5 v^2 b (V r x - \frac{1}{2} V x^2 - r v x)}{r};$$

and when the depth of the paddle is h , it is

$$\frac{1.5 b h v^2 \left\{ (r - \frac{1}{2} h) V - r v \right\}}{r} = \text{the direct power,}$$

which must be equal to the resistance of the vessel.

The loss by oblique action has to be estimated before the power of the engine can be found, but previously we may proceed to determine the best velocity for the wheels in still water.

630. Let the equation be freed of all its constant multipliers, except those relating to or connected with its velocities; then it is $v^2 (V r - \frac{1}{2} V h - r v)$; and making v variable, its differential is $2 V r v dv - V h v dv - 3 r v^2 dv = 0$; from whence we have,

$$V = \frac{3 r}{2(r - \frac{1}{2} h)} v, \text{ and } v = \frac{2(r - \frac{1}{2} h)}{3 r} V.$$

The excess of the velocity of the outer point of the paddle therefore depends in part on its depth compared with the radius; the greater the depth, the less excess is necessary.¹

¹ The above is according to the principles of Tredgold's investigation, but it is not here sanctioned as to its accuracy. Although the quantity of water put in motion may be proportional to the velocity of the vessel, it does not appear that the whole of this water is *struck by the paddle*,

631. If this value of V be inserted in the equation for the area of the paddles, then $\cdot 75 v^3 b h =$ the effect of the paddles, which must be equal to

as is assumed at the outset; on the contrary, a large portion is evidently put in motion by secondary pressure. The pressure on the paddle must in all cases be nearly proportional to the square of its velocity ($V' - v$) *through the water*, V' denoting the velocity of the "centre of pressure," which is near to the centre of the paddle. It should however be observed, that the passage of each paddle leaves a vacuum behind it, and that its repletion causes a temporary stream, which necessarily diminishes the effect of the succeeding paddle. Consequently, if we represent the pressure by $c(V - v)^2$ the coefficient c must be rather less than in the case of the motion of a body through still water; and it can only be regarded as constant for quick velocities, as the diminution from the cause alluded to will be most considerable when the velocities of the vessel and paddle are slow.

If we suppose the vessel to be influenced only by the engine and the resistance of the water, and disregard the variations of her immersion, the resistance will obviously be proportioned to v^2 , and, the velocities being uniform, it must be equal to the reaction or pressure against the paddles, in the direction of the motion of the vessel. Let $C v^2$ denote this pressure, and let k be the distance of the centre of pressure below the axis, or the leverage with which it acts; then $C k v^2$ is the effort to turn the wheel. As $k v^2$ must therefore be constant under given circumstances, whatever be the dimensions of the wheel and paddle, it is evident that the velocity will be increased by diminishing k , and that in this respect small wheels are preferable to large ones, were it not for the power required to overcome the increased oblique action, and the inconveniences attending it. In strictness k refers to the centre of the entire horizontal pressure against all the paddles immersed, and this will be near the middle of that which is most depressed. If we suppose k to be proportional to r , the effort to turn the wheel may be represented by $C' r v^2$, and, ω denoting the angular velocity of rotation, $C' r \omega v^2 = C' V v^2$ will then represent the whole power expended by the engine. It hence also appears, that when the engine works with a given power and a given speed, both $r v^2$ and ω must be constant for all sized wheels, the dimensions of the paddle and the radius of the wheel being properly adapted to each other, for the due consumption of the steam generated in the boilers.

To put the relations in an analytical form, let the notation be as follows:—

- P the pressure on the piston in lbs. per circular inch,
- a ,, radius of the cylinder,
- l ,, length of stroke,
- n ,, number of strokes per minute,
- u ,, velocity of the piston in feet per second,
- v ,, velocity of the vessel ,, ,, "
- V ,, velocity of the centre of pressure of the wheels,
- k ,, the radius of the wheel to the centre of pressure;

and let $B^2 v^2$ be the pressure or resistance, in lbs., experienced at the bow of the vessel, and $b^2 (V - v)^2$ that on the paddles, both estimated in the line of motion, so that

$$B v = b (V - v) \quad (1)$$

then B^2, b^2 , will be factors proportional to the equivalent resisting surfaces of the boat and the paddles immersed. And since, in respect of the engine, the pressure $B^2 v^2$ on the

the resistance of the vessel; and the comparison is easily made by means of the equations for the resistance of vessels (art. 622). The power required

paddles acts with the velocity V , and the pressure $P a^2$ on the piston acts with the velocity u , we have, neglecting the effects of oblique action,

$$P a^2 u = B^2 v^2 V \quad \dots (2)$$

We have also, from the mechanical arrangement of the parts,

$$V = \frac{2 \pi n k}{60} = \frac{\pi n k}{30} \quad \dots (3)$$

$$u = \frac{2 n l}{60} = \frac{n l}{30} \quad \dots (4)$$

These four equations, which embody the whole theory of paddle wheels, may be easily discussed for any purpose that may be had in view. The following expressions, deduced from them, are the most commonly applicable:—

$$V = \frac{B + b}{b} v = \pi \frac{k u}{l} \quad \dots (a)$$

$$u = \left\{ \begin{array}{l} \frac{B + b}{B b} \sqrt{\frac{P a^2 l^3}{\pi^3 k^3}} \quad \dots (u_1) \\ \left(\frac{B b}{B + b}\right)^2 \frac{V^3}{P a^2} \quad \dots (u_2) \\ \frac{B^2 (B + b)}{b} \frac{v^3}{P a^2} \quad \dots (u_3) \end{array} \right.$$

$$v = \left\{ \begin{array}{l} \frac{\pi b}{B + b} \frac{n k}{30} \quad \dots (v_1) \\ \frac{1}{B} \sqrt{\frac{P a^2 l}{\pi k}} \quad \dots (v_2) \\ \frac{1}{B} \sqrt[3]{\frac{B b}{B + b} P a^2 u} \quad \dots (v_3) \end{array} \right.$$

$$V = \left\{ \begin{array}{l} \pi \frac{n k}{30} \quad \dots (V_1) \\ \frac{B + b}{B b} \sqrt{\frac{P a^2 l}{\pi k}} \quad \dots (V_2) \\ \sqrt[3]{\left(\frac{B + b}{B b}\right)^2 P a^2 u} \quad \dots (V_3) \end{array} \right.$$

Equations (v_3) , (V_3) show that with given sized paddles and draught of water, the velocities, under all circumstances, will be proportional to the cube root of the quantity of steam consumed per minute. Also equation (u_1) shows that more steam may be consumed by either increasing the length of the stroke or diminishing the radius of the wheel, while (v_2) , (V_2) indicate a corresponding increase of the velocities in the ratio of the cube root of the increased consumption. It is also evident from these last equations, that if the paddle be lessened or b diminished, the velocities u V and consumption of steam will be increased, while v will remain unaltered.

For any particular vessel the constants B , b , may be determined from a few good experiments; the former will be nearly proportional to the square root of the draught of water, and the latter nearly as the square root of the area of one of the paddles.—Ed.

to produce the effect is,

$$\frac{3r}{2(r - \frac{1}{2}h)} \times .75 v^3 b h = \frac{2.25 r v^3 b h}{2(r - \frac{1}{2}h)}.$$

A somewhat greater power is required, because there is also a loss by oblique action, and this will be expressed with accuracy enough for the object by multiplying the power by,

$$\sqrt{\frac{r - \frac{1}{3}h}{r - \frac{1}{2}h}}$$

where r is the radius CB , and h the depth of the float boards DB . For the

FIG. 27.

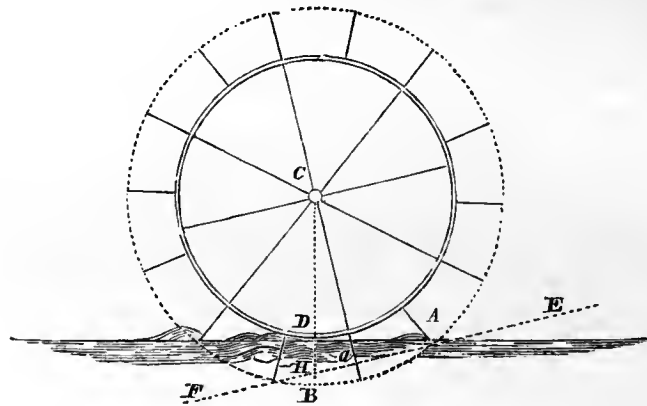

centre of gravity, a of the immersed part ABD may be considered the actual point where the whole force acts, instead of being distributed over the segment; and its mean direction will be EF , which is perpendicular to the line AC , drawn from the centre of the wheel through the centre of gravity: and the direction of this line will determine the loss by oblique action, for the power is to the effect as $AH : AD$, and is nearly given by the multiplier above.

An example may give a clearer idea of its effect. Let the radius of the wheel be 8 feet, and the depth of the paddles 2 feet, then

$$\sqrt{\frac{8 - \frac{2}{3}}{8 - 1}} = 1.024, \text{ nearly.}$$

Hence, as it will not exceed one-fortieth part of the whole, it may be neglected. The mean direction of the action is of greater importance to the motion, than the loss of power.

632. We have supposed the paddles to be of the same breadth every where,

but this may not be the best form, and therefore let $h^n : b :: x^n : \frac{b x^n}{h^n} =$ the breadth at any point x , which substituted for b we have

$$\frac{1.5 v^2 b (V r - V x - r v) x^n dx}{r h^n} = \text{the differential of the power.}$$

Its integral is,

$$\frac{1.5 v^2 b}{r h^n} \left(\frac{r(V-v) x^{n+1}}{n+1} - \frac{V x^{n+2}}{n+2} \right);$$

and when $x = h$, it is

$$\frac{1.5 v^2 b h}{r} \left(\frac{r(V-v)}{n+1} - \frac{V h}{n+2} \right).$$

If $n = 0$, the form of the paddle is a rectangle with the same result as before.

633. If it be a triangle, $n = 1$, and the result is less than for the rectangle, the velocity and area being the same.

634. If $n = \frac{1}{2}$ the form is parabolic, and the result is,

$$\frac{1.5 v^2 b h (10 r (V - v) - 6 V h)}{15 r}.$$

There we obviously gain advantage, by getting an equal resistance with less breadth, and by this form the resistance to the paddle is least when it strikes the water obliquely as at A, and increases as its action becomes more

FIG. 28.

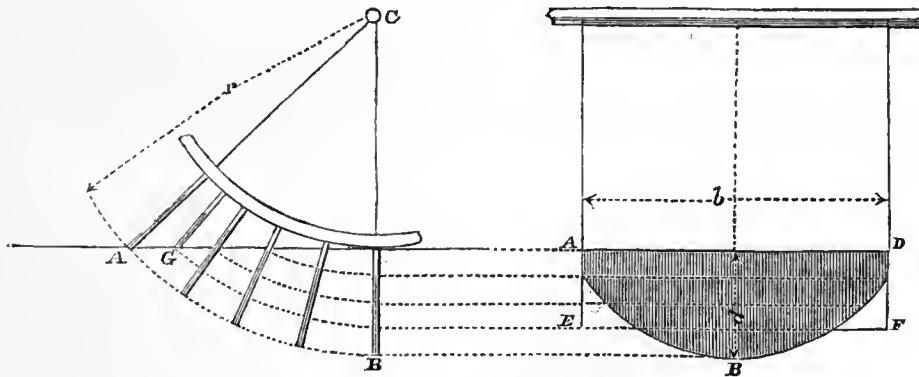

direct. The velocity for the maximum effect is to the velocity of the vessel as $2r - 1.2h : 3r :: v : V = \frac{3rv}{2r - 1.2h}$, which is less than for square paddles; if this value of V be inserted in the equation, we have $\frac{1.5 v^3 b h}{3} =$ the power of the paddles when they are of a parabolic form, with the depth h , and breadth b .

If the form of the exterior edge be more rounded than the vertex of the common

parabola, the effect again decreases. I was led to examine this point, by observing the form of those fins of fish which are used for impelling in a similar manner. The lines A D E F show the size of a square paddle capable of producing the same effect. It strikes the water at once with its whole breadth, as at G. The parabolic one strikes a little sooner, and gradually acquires its full hold of the water.

635. The best position for the paddles appears to be in a plane, passing through the axis, as represented in the figure; if they be in a plane which does not coincide with the axis, they must either strike more obliquely on the fluid on entering, or lift a considerable quantity in quitting it.

In the direction of the breadth of the paddle, it is evident the form should be such that the resistance to its motion should be the greatest possible, and the pressure behind it the least possible. These conditions appeared to be fulfilled, in a high degree, by making it a plane in this direction also. A flat curve has been used, the concave surface to strike the fluid, and perhaps with a very small increase of power. To set the paddles at any other than a right angle, must obviously be a defect; for the resistance to motion becomes less when the surface strikes the water obliquely, whereas the greater this resistance, the greater the effect in impelling the vessel.

636. It is desirable that the action of the paddles should be as equable and continuous as possible. But in attempting to render the action of the paddles equable, their number ought not to be increased more than can be avoided, because the construction is more expensive, and the time for the water to flow between them so as to afford a proper quantity of reaction is reduced; neither do they clear themselves so well in quitting the water. If we suppose A E to be the line the water would assume when at rest, the most favourable arrangement with the smallest number of paddles appears to be to make a paddle at A, just entering,

FIG. 29.

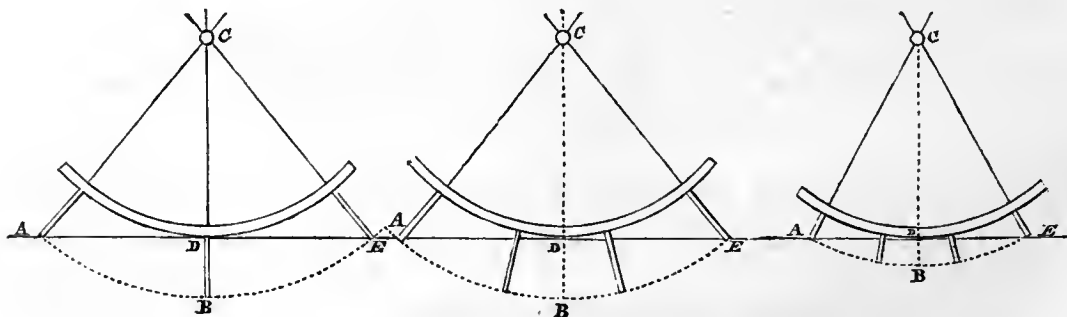

when one at B is in a vertical position, and the one E quitting the water: if a smaller number were employed, there would be a short interval, during which

none of the paddles would be in full action. A still more equable action will be obtained by dividing the immersed arc into three; beyond this I do not think the advantage will be worth the extra expense, therefore I propose to give general equations for any proportion, and particular rules for three to be immersed.

637. To determine the radius of the wheel or the depth of the paddles, when the number of the paddles is given, becomes an easy problem when the preceding conditions are to be adhered to. For, put r = the radius B C, x = the depth B D of the paddles, n their number, and a the number of parts into which the immersed arc is divided. Then $\frac{a 180^\circ}{n}$ = the angle A C B, corresponding to half the immersed arc, and

$$r \cos. \frac{a 180}{n} = C D,$$

the cosine of the angle, being the depth from the centre of the wheel to the surface of the water; and,

$$r \cos. \frac{a 180}{n} = r - x; \text{ or } r \left(1 - \cos. \frac{a 180}{n} \right) = x = B D, \text{ the depth of the paddles.}$$

And,

$$\frac{x}{1 - \cos. \frac{a 180}{n}} = r = B C, \text{ the radius of the wheel.}$$

From these equations we have the following rules for the case when three paddles are immersed, or when $a = 3$.

638. RULE I. To find the radius of the wheel, when the number and depth of the paddles are given. Divide 540 by the number of paddles, which will give the degrees in the angle contained by half the immersed arc. From unity subtract the natural cosine of this angle, and the depth of the paddles divided by the remainder will give the radius of the wheel.

Or the radius of the wheel multiplied by the remainder will give the depth of the paddles.

639. RULE II. To find the number of paddles, when the radius of the wheel and the depth of the paddles are given. Divide the depth of the paddles in feet, by the radius of the wheel in feet, and subtract the quotient from *unity*. Find the angle corresponding to the remainder as a natural cosine, and 540 divided by the degrees in that angle is the number of paddles required.

If the radius of the wheel be 8 feet, and the depth of the paddles 2 feet, then,

$$1 - \frac{2}{8} = .75 \text{ which is the cosine of the angle } 41^\circ 4',$$

$$\text{and } \frac{540}{41.4} = 13, \text{ the number of paddles.}$$

640. The size of the wheels depends chiefly on the mode of giving them motion from the engine; they must be so large as to have the proper speed at the circumference, and where large wheels can be admitted, they have some advantages: they must necessarily be narrower, and they strike the fluid in a favourable direction, and also quit it better; the paddles having more direct action on the water, they splash it about much less; the weight of the wheel also renders it more effective, as a regulator of the forces acting upon it. On the other hand, there are some strong practical objections to very large wheels for sea vessels; they give the momentum of the waves a greater hold on the machinery, they are cumbersome and unsightly, and they raise the point of action too high above the water line.

641. When the wheels are on the first motion, the radius is determined by the velocity of the engine. Let that velocity be n strokes per minute, then $3.1416 \times 2r =$ the circumference of the wheel; r being its radius, and its velocity per minute is $3.1416 \times 2rn$: but this is to the velocity of the boat nearly as 3 to 2;¹ hence,

$$3.1416 \times 2rn = \frac{88 \times 3v}{2},$$

or $\frac{21v}{r} = n$, the number of strokes per minute, when $v =$ the miles per hour.

Also fixing the number of strokes we have,

$$\frac{21v}{n} = r, \text{ the radius of the wheel.}$$

This therefore reduces to this simple rule:

RULE. The velocity of the vessel per hour multiplied by 21 is equal to the number of strokes per minute, multiplied by the radius of the wheel.

From this exceedingly simple rule it can be known at once whether the wheel becomes too large or not, when the simple crank motion is used; it ought to be used in preference to a second motion, in all cases where it does not involve some other difficulties than merely the size of the wheel.

For further information on the subject of paddle wheels, the reader is referred to the Appendix.

MODIFICATIONS OF PADDLE WHEELS.

642. Several methods have been tried or projected for getting rid of certain supposed defects of the paddle wheels. The quantity of force lost by oblique action

¹ This ratio is obtained from art. 630.

has been greatly overrated, and most of the contrivances are directed to remove it either wholly or in part. The methods proposed are of two kinds. In one a gradual change of position of the paddle is produced by the movement of the wheel; completely forgetting, that by loss of the velocity, the decrease of force is as the square, while by variation of direction the loss is only in simple proportion. Mr. Oldham, of the Bank of Ireland, proposed a plan for these revolving paddles, to avoid the defects of the fixed paddles commonly used; and states, that the violent action of the paddles of common wheels, in striking the water in a rough sea, is entirely removed by the use of the revolving paddles, as they enter and rise out of the water with a peculiarly soft and easy motion. We can only regret that so much ease cannot be obtained without a considerable and constant sacrifice of power.

The other method is to cause the paddles to change at once to a new position at two points in the revolution, by means of proper catches and mechanism. This is a better method for cases where the wheels are to work when deeply immersed in water; but such wheels require to be made so very strong and powerful, that there appears to be small probability of the machinery keeping in order.

The plan of making paddles which seems most plausible, is to have a pair of wheels at each side of the vessel, having two endless chains acting on them, with paddles fixed on these chains. As the chain passes in one direction, the paddle boards are immersed in the water, and return in the opposite direction out of the water; the two wheels around which they pass being partially under water. The whole of the impulse given by these boards from the lower part of one wheel to the lower part of the other, seems as though it would be direct and effectual; and it is stated, that so far as the plan has been tried on a very small scale, it has been successful. It is said however by Buchanan to have been tried on the Duke of Bridgwater's canal, where it did not give satisfaction; and the reason not being assigned, we must endeavour to show whether or not the arrangement can have greater effect than the common paddle wheel.

If a wheel have a sufficient number of paddles to force the whole of the fluid opposed to the area of the paddle into motion, it is obvious that any continuation of the line of action of the paddles will be only equivalent to the friction of the stream put in motion by their first action on it: and this effect is by far too small to be obtained by a complicated arrangement, which it would be difficult to render durable; hence the construction is imperfect.

The subject is further treated in the Appendix.

OF THE STRENGTH OF VESSELS.

643. It was not till 1818 that steam vessels were made to perform regular voyages at sea ; and in proportion as they have had experience, the strength of the vessels has been increased. A vessel should be considered as one slightly flexible frame, and the strength determined so that the greatest possible stress, acting with the most disadvantage probable, would not derange the natural elasticity of the parts, nor disturb the connexions. The want of considering the frame as a whole, has often led to weak modes of construction, and improper modes of bracing. A vessel is also to be considered in the condition where hydrostatic pressure contributes least to its support. The strains reduce to those which would take place in a large hollow beam, of which we have to find the neutral axis, and then the resisting forces are easily measured.¹ When the timbers are filled in between, it must increase the strength, if it be done in a proper manner ; and this increase might perhaps be obtained with less material, and less addition to the weight of the vessel, but the advantage of leaving no hollow cavities is of much importance both to the durability and cleanliness of a vessel.²

644. In respect to timber, fir has the advantage of lightness, and for straight timbers it is stronger than a like weight of oak ; but for curved timbers the harder woods which have greater lateral cohesion are better.

OF THE APPLICATION OF SAILS.

645. It is found that sails may be effectively combined with steam power, whenever the direction is not within four points of that of the wind.

But when the force of the wind becomes considerable, and the sea rough, the wheels often revolve without touching the water in the hollows of the waves, and acquire a great increase of velocity, to be reduced, as soon as they meet the wave again, to less than the ordinary speed. To lessen the abruptness of these changes, it is necessary to diminish the supply of steam, and consequently the power of the engine.

646. It appears to be impossible to apply so much sail as to give a steam vessel the advantage of being used as an effective sailing vessel, in the event of the engines or coals failing. The proper object of sails in a steam vessel is to save fuel

¹ See my 'Elementary Principles of Carpentry,' Sect. 1 and 2; and 'Treatise on the Strength of Iron,' art. 85 *a*.

² See Philosophical Transactions for 1820.

when the wind can be of service,¹ and to do this with economy, the engines should work expansively (see art. 419.); hence, the arrangement of the engine should be such as would answer to work at full pressure in a calm. This condition enables us to fix the power of the engine by the rate for still water; and if the vessel has sails sufficient to maintain the speed with about half the power of the engines, when the wind is fair, it will be as much as can be usefully employed. The greatest attention should be given to keep the centre of effort on the sails as low as possible, and to arrange them so that the angle of the vessel's inclination may be inconsiderable, that the wheels may not dip unequally.

647. The average speed in still water, beyond which it does not seem to be desirable to go, is ten feet per second; that is, seven common miles, or six nautical miles per hour: and at this velocity, when the wind is as powerful as it is prudent to carry all the canvas, the direct effect will be only one horse power for each thirty-two yards superficial.²

648. A fair wind also contributes to the motion of a vessel, by giving motion to the sea itself; a head wind opposes its motion, and a current has a similar effect. If v be the velocity a vessel is impelled at in still water by the power P , and the velocity of the current be $\pm n v$, using the upper sign when it is with the vessel, then $P (1 \pm n)^2 =$ the power the boat will require.

If the stream be in the direction of the vessel's motion, and half its velocity in still water, then $n = .5$ and $P (1 - .5)^2 = .25 P$; or the vessel will require only one-fourth of the effective power.

If the vessel move against the stream, the stream being half its velocity in still water, then $P (1 + .5)^2 = 2.25 P$; or the vessel will require $2\frac{1}{4}$ times the power to preserve its velocity.

649. But in ascending a stream the difference must be in the velocity, and it

¹ It is a common notion, that the sails should be used in addition to the steam power, to gain greater velocity; but this is not desirable, except for post-office packets and the like, because an immense extent of canvas affords only a very small power when the vessel moves at a considerable velocity; hence, economy directs to saving fuel, rather than increasing speed.

² To find the effect of the wind in any other direction, and with any other velocity, let V be the velocity of the wind in feet per second, $a =$ the angle it makes with the direction of the vessel's motion, $v =$ the velocity of the vessel in feet per second, $b =$ the angle a perpendicular to the surface of the sail makes with the direction of the motion of the vessel; then it is nearly,

$$\frac{3200 \cos. b}{(V \cos. (a + b) - v \cos. b)^2} = \text{the yards of canvas,}$$

equivalent to a horse power or 550 lbs. raised one foot per second.

is generally so also in the descent; hence, if v be the velocity of the stream, and $m v$ the velocity of the vessel moving in the stream, then

$$v^2 = m(mv + u)^2.$$

The value of m is not easily separated in this equation, but by assuming that the force of the wheels is invariable, we have $v^2 = (mv + u)^2$; or $v + u = m v$. The upper sign to be used when the vessel moves with the current.

Hence, if the velocity in still water be 8 miles per hour, and that of the stream 3 miles per hour.

Then down the stream $v + u = 8 + 3 = 11$ miles; and up the stream $v - u = 8 - 3 = 5$ miles.

If the velocity of the paddles alter, the power will not be constant; and if it do not alter, this ratio cannot exactly hold.

RULE FOR THE POWER OF BOAT ENGINES.

650. The power of boat engines may be ascertained thus. Let p be the mean pressure on the piston in lbs., a its diameter in inches, v its velocity in feet per minute, and h = the number of horses equivalent to its power; then

$$h = \frac{p v a^2}{33000}.$$

Let the length of the stroke in feet be l , then $v = A \sqrt{l}$, where A is the multiplier found by art. 336.; hence,

$$h = \frac{p v a^2}{33000} = \frac{p A a^2 \sqrt{l}}{33000} = h, \text{ or } a = \left(\frac{33000 h}{p A \sqrt{l}} \right)^{\frac{1}{2}}$$

In logarithms, $\log. a = \frac{1}{2} (\log. 33000 + \log. h - \log. p - \log. A - \frac{1}{2} \log. l)$.

For low pressure steam acting at full pressure throughout the stroke we have $A = 103$, (art. 337.) and $p = 7.1$. (art. 416.) Hence, in this case the rule becomes

$$\log. a = \frac{1}{2} (\log. h + 1.66726 - \frac{1}{2} \log. l).$$

Also,

$$\log. h = 2 \log. a + \frac{1}{2} \log. l - 1.66726.$$

651. If m times the length of the stroke in feet be the diameter in inches, then

$$\log. a = \frac{2}{3} (\log. h + 1.66726 + \frac{1}{2} \log. m).$$

The most common proportion now used is $m = 9$, or the length of the stroke four-thirds of the diameter, hence,

$$\log. a = \frac{2}{3} (\log. h + 2.14438).$$

Example. If the resistance be equal to 100 horse power, with two engines of 50 each;

$$\begin{array}{r} \text{the log. } 50 = 1.69897 \\ \phantom{\text{the log. } 50 = } 2.14438 \\ \hline \phantom{\text{the log. } 50 = } 3.84335 \\ \phantom{\text{the log. } 50 = } 2. \\ \hline \phantom{\text{the log. } 50 = } 5) 7.68670 \end{array}$$

$$\log. a = \log. 34.5 = 1.53734$$

Hence, the diameter should be 34.5 inches, and the length of the stroke $\frac{34.5 \times 4}{3} = 46$ inches.

OF ARRANGING THE PROPORTION OF POWER FOR VESSELS.

652. If we now proceed through a calculation of the proportions, and a statement of the conditions to which we ought to attend in arranging the parts of an engine for a vessel, it will form the best illustration of the use of the preceding rules.

653. *The resistance of the vessel* should be ascertained for the average velocity: now without pretending to fix the best average, I will suppose this to be 10 feet per second, or 7 miles per hour in still water.¹ Let the length of the parallel part of the vessel be 72 feet, the mean radius of curvature of the ends be 6 half breadths, the breadth at the midship section 25.7 feet, and the girt of that section in contact with water 38 feet. Then the velocity being 10 feet per second, we have by the table, (art. 622.)

$$\begin{aligned} 10^3 \times 38 (\cdot 025 \times 25.7 + \cdot 0032 (72 + 1.05 \times 25.7)) &= \\ 10^3 \times 36.5 &= 36500 \text{ lbs. raised one foot per second,} \\ \text{or } 36500 \text{ divided by } 550 &= 67 \text{ horse power nearly. } ^2 \end{aligned}$$

654. Now if we were to fix on the area and velocity of the paddles for this velocity, it would not be possible to work with advantage against either wind or

¹ This will be equivalent to an average speed of nine miles per hour, where sailing power is to be used in addition.

² The coefficient .0032 (see art. 614.) is very likely too high; it is taken from the experiments made by the *Society for the Improvement of Naval Architecture*, and agrees with the more recent experiments of Col. Beaufoy; but I am quite convinced that when water is in motion the friction is less, only the exact measure remains to be determined.

current; besides there is a disadvantage in large paddles at sea, which is greater than the loss by varying from the maximum. Hence, I would recommend to arrange the paddles for a velocity about one foot per second greater than the average rate. Consequently, (art. 631.) $11^3 \times .75 \times b h =$ the power of the paddles; and as the resistance is 36500, we have

$$\frac{36500}{11^3 \times .75} = b h = 36.6 \text{ feet, the area of the paddle boards.}$$

Again, suppose the radius of the wheels to be four times the depth of the paddles, then by the second equation of art. 631. we have,

$$\frac{2.25 r \times 11^3 \times b h}{2 r - h} = \frac{9 \times 11^3 \times 36.6}{7} = 62633 \text{ lbs. raised one foot per second,}$$

or 62633 divided by 550 = 114 horse power nearly.

655. As the vessel requires 114 horse power, if we have two engines, each will be 57 horse power; and (art. 651.)

$$\begin{array}{r} \log. 57 = 1.75587 \\ \quad 2.14438 \\ \hline \quad 3.90025 \\ \quad \quad 2 \\ \hline \quad 5) 7.80050 \end{array}$$

$$\log. \text{ diameter} = 1.56010$$

or the diameter = 36.32 inches; the length of the stroke four-thirds of the diameter, or 48.43 inches; and consequently (art. 336.) the number of strokes per minute will be $25\frac{1}{2}$: hence, (art. 641.) corrected for the depth of the paddle,¹ we have, when the velocity is 11 feet per second, or 7.5 miles per hour,

$$\frac{24 \times v}{25.5} = \frac{24 \times 7.5}{25.5} = 7.1 \text{ feet,}$$

for the radius of the wheels; and dividing it by 4 gives the depth of the paddles 1.8 feet. But in order to reduce the breadth of the wheel, it is better that they be made 2 feet, and the radius of the wheel 7.3 feet; the paddles will then be 2 feet

¹ For when the depth is one-fourth of the radius, $V = \frac{3 r v}{2 r - d} = \frac{12 v}{7}$, instead of $\frac{3 V}{2}$; hence, $\frac{3}{2} : \frac{12}{7} :: 21 : 24$.

by 9·2 feet for each wheel, making an area of 36·8 feet for both, or the breadth of the wheel 9·2 feet.¹

The other proportions of the engines will be found by the general rule, (art. 415.) except that a somewhat smaller quantity of water produces the steam, owing to its being of a higher temperature, (see art. 90.) but it is only about 2 per cent less, and the fuel required is not sensibly altered; there is also a slight advantage by the force of the steam being less in the condenser than when pure water is used. (See table, art. 94.) Hence, the cistern of water to contain the condenser is omitted without loss. The engines should be prepared to work expansively, to be adjusted by hand, (see art. 419 and 481.) and the strength of the parts will be found by art. 496—527: the management of the water is treated of in art. 565. and the parallel motion, art. 488—495.

656. I think it would be desirable to try the effect of giving a considerable degree of elasticity to the arms of the paddles, and to form the boards in the manner shown in Fig. 28. page 305. The wheels of vessels appear to be kept too forward, so as to keep the fore part of the vessel constantly heaving upwards; and such an action is unfavourable. A vessel should bear firmly in the direction of its motion to move well; and that this remark is true in practice as well as theory, may be inferred from the fact, that in the present construction they find an advantage in using the sails to steady, and determine the direction of the vessel's motion. In vessels for towing,² this may be adopted with still greater advantage; and in both cases the proper place for the wheels appears to be behind the centre of gravity of the vessel.

The following Tables are collected chiefly from the evidence printed in the Reports on the Holyhead Steam Packets, by the committee appointed by the House of Commons; and will afford a means of comparing the practice of different manufacturers:—

¹ The proportions of the vessel in this case are as nearly those of that called the *James Watt*, as I could ascertain them; and in the tables which follow, the best information I could procure respecting that vessel is given in order to compare the calculated with the reported effect: the velocity is that in still water, that is, the velocity in the river with that of the current deducted therefrom.

² The power required for towing a vessel may be estimated by art. 622.

657. TABLE OF STEAM VESSELS.

		Maudslay, Son, and Field, London.								
		Dec.	Enterprise.	Commerce.	Bears Van Amsterdam.	London Engineer.	Lightning.	Hartequin.	Joanhoe.	Crusader.
Name of engine builder	-	-	-	-	-	-	-	-	-	-
Name of the vessel	-	-	-	-	-	-	-	-	-	-
Name of builder of vessel	-	-	-	-	-	-	-	-	-	-
Length of deck	-	166 ft. 7 in.	-	-	-	-	126 ft. 0 in.	21 ft. 0 in.	18 ft. 6 in.	16 ft. 2 in.
Breadth (extreme)	-	30 ft.	26 ft.	22 ft. 4 in.	25 ft. 10 in.	24 ft. 0 in.	22 ft. 4 in.	7 ft. 8 in.	7 ft. 0 in.	6 ft. 3 in.
Draught of water	-	10 ft.	14 ft.	10 ft. 0 in.	8 ft. 0 in.	5 ft. 0 in.	8 ft. 2 in.	13 ft. 0 in.	12 ft. 6 in.	11 ft. 6 in.
Paddle wheels, diameter	-	20 ft.	15 ft.	18 ft. 0 in.	16 ft. 0 in.	12 ft. 6 in.	15 ft. 0 in.	7 ft. 0 in.	6 ft. 0 in.	5 ft. 6 in.
Paddle wheels, breadth	-	10 ft.	7 ft.	7 ft. 0 in.	8 ft. 0 in.	6 ft. 6 in.	9 ft. 0 in.	7 ft. 0 in.	6 ft. 0 in.	5 ft. 6 in.
Paddle wheels, velocity of extremity in miles per hour	-	-	12.8 miles	-	-	-	-	-	-	-
Paddles, depth	-	-	-	-	-	-	-	-	-	-
Tonnage (register)	-	700 tons	500 tons	400 tons	500 tons	315 tons	296 tons	232 tons	160 tons	95 tons
Total power of engines	-	200 h. p.	120 h. p.	140 h. p.	120 h. p.	70 h. p.	100 h. p.	80 h. p.	60 h. p.	50 h. p.
Velocity in still water	-	-	-	-	-	-	-	-	-	-
Coals per hour	-	-	-	-	-	630 lbs. Wylam coals.	-	1240 lbs. average	-	-
Engines, number	-	2 engines	2 engines	2 engines	2 engines	2 engines	2 engines	2 engines	2 engines	2 engines
Engines, diameter of cylinders	-	53 in.	43 in.	46½ in.	43 in.	36 in.	40 in.	36 in.	32 in.	29½ in.
Engines, length of stroke	-	60 in.	48 in.	54 in.	48 in.	30 in.	8 in.	42 in.	36 in.	36 in.
Engines, strokes per minute	-	20 strokes	24 strokes	22 strokes	25 strokes	28 strokes	25 strokes	28 strokes	30 strokes	32 strokes
Engines, diameter of air pump	-	-	-	-	-	-	-	-	-	-
Used for	-	Navy	East Indies	Liverpool and Dublin	Amsterdam and London	Margate packet	Navy	Post office packet	Post office packet	Post office packet
Date of construction	-	1827	1825	1826	1826	1818	1824	1824	1826	1827
Calculated power of engines at the best velocity and full pressure	-	272 h. p.	160 h. p.	197 h. p.	160 h. p.	88 h. p.	137 h. p.	104 h. p.	76 h. p.	68 h. p.

OF STEAM NAVIGATION.

658. TABLE OF STEAM VESSELS.

Name of engine builder	Boulton and Watt, Soho, Birmingham.						Fenton and Co., Leeds.
	<i>Soho.</i>	<i>James Watt.</i>	<i>City of Edinburgh.</i>	<i>Shannon.</i>	<i>Sovereign George IV.</i>	<i>Caledonia.</i>	
Name of the vessel	-	-	-	-	-	-	<i>Hero.</i>
Name of builder of vessel	-	Wood and Co.	Wigram.	Fletcher and Son	Evans.	Wood and Co.	Bancham.
Length of deck	163 feet	146 feet	143 feet	180 feet	126 feet	95 ft. 6 in.	6 feet 4 inches
Breadth (extreme)	27 feet	25 ft. 8 in.	25 ft. 6 in.	49 feet	21 ft. 10 in.	15 ft. 0 in.	14 feet 0 inches
Draught of water	-	10 ft. 0 in.	-	-	8 ft. 6 in.	4 ft. 6 in.	8 feet 0 inches
Paddle wheels, diameter	15 ft. 8 in.	18 ft. 0 in.	18 feet	-	16 feet	-	15 miles
Paddle wheels, breadth	8 ft. 0 in.	9 ft. 0 in.	8 feet	-	8 feet	-	1 foot 6 inches
Paddle wheels, velocity of exertion in miles per hour	14.6 miles	12 miles	12 miles	-	-	-	233 tons
Paddles, depth	2 feet	2 ft. 0 in.	2 feet	-	-	-	90 horse power
Tonnage (register)	510 tons	448 tons	400 tons	513 tons	210 tons	102 tons	11 1/2 miles
Nominal power of engines	120 h. p.	100 h. p.	80 h. p.	160 h. p.	80 h. p.	28 h. p.	2240 lbs.
Velocity per hour in still water	-	10 miles	-	-	9 1/2 miles	8 1/2 miles	2 engines
Coals per hour	-	-	-	2 engines	896 lbs.	2 engines	30 strokes
Engines, number	2 engines	2 engines	2 engines	2 engines	2 engines	2 engines	Margate packet
Engines, diameter of cylinders	42 inches	39 inches	36 inches	36 inches	-	-	1821
Engines, length of stroke	48 inches	42 inches	42 inches	42 inches	-	-	1821
Engines, strokes per minute	26 strokes	27 1/2 strokes	27 1/2 strokes	27 1/2 strokes	-	-	Post office packet
Engines, diameter of air pump	23 inches	21 inches	19 1/2 inches	19 1/2 inches	-	-	1821
Used for	Passengers	Passengers	Passengers	Passengers and 200 tons goods	Post office packet	Post office packet	1821
Date of construction	1823	1821	1821	1826	1821	1815	1821
Calculated power of engines at the best velocity and full pressure	151 h. p.	122 h. p.	104 h. p.	-	-	-	-

659. TABLE OF STEAM VESSELS.

Name of engine builder	Napier, Glasgow.				Fawcett and Littledale, Liverpool.				
	United Kingdom.	Majestic.	Superb.	Talbot.	St. Patrick.	Prince Llewellyn.	Albion.	Duke of Lancaster.	Cambriv.
Name of the vessel	-	-	-	-	-	-	-	-	-
Name of builder of vessel	-	Scott and Co.	Scott and Co.	Wood and Co.	Mottershead and Hayes.				
Length of deck	175 ft.	-	-	92 ft.	130 ft.	103 ft. 6 in.	103 ft.	91 ft. 2 in.	-
Breadth (extreme)	45 ft. 6 in.	-	-	17 ft. 11 in.	22 ft. 1 in.	18 ft. 1 in.	17 ft.	17 ft. 6 in.	-
Draught of water	-	-	-	-	13 ft. 8 in.	9 ft. 6 in.	9 ft. 6 in.	8 ft. 4 in.	-
Paddle wheels, diameter	-	-	-	-	-	-	-	-	-
Paddle wheels, breadth	-	-	-	-	-	-	-	-	-
Paddle wheels, velocity of extremity	-	-	-	-	-	-	-	-	-
Paddles, depth	-	-	-	-	-	-	-	-	-
Tonnage (register)	630 tons	350 tons	241 tons	140 tons	200 tons	103 tons	94 tons	86½ tons	-
Power of engines	200 h. p.	100 h. p.	70 h. p.	60 h. p.	100 h. p.	60 h. p.	50 h. p.	50 h. p.	-
Velocity per hour in still water	-	10 miles	9 miles	-	-	-	-	-	-
Coals per hour	2240 lbs.	2240 lbs.	1670 lbs.	784 lbs.	-	-	-	-	-
Engines, number	2 engines	2 engines	2 engines	Scotch coal	2 engines	2 engines	2 engines	2 engines	-
Engines, diameter of cylinders	-	-	-	-	42 in.	32 in.	30 in.	30 in.	-
Engines, length of stroke	-	-	-	-	42 in.	33 in.	33 in.	30 in.	-
Engines, strokes per minute	-	28	-	-	-	-	-	-	-
Engines, diameter of air pump	-	-	-	-	-	-	-	-	-
Used for	Edinburgh packet, 175 passengers	-	-	Post Office packet.	1822	1822	1822	1822	1822
Date of construction	1826	1816	1820	1819	1822	1822	1822	1822	1822
Calculated power of engines at the best velocity and full pressure	-	-	-	-	142 h. p.	73 h. p.	73 h. p.	67 h. p.	-

The average consumption of coals is that required when the engine is in full action, and including all delays, waste, &c.; and is to be understood as that which multiplied by the hours it requires for the average passage, would give the quantity consumed for each passage; and the store ought evidently to be for the longest passage. In the best engines (of this time) it will be found to vary from 12 to 16 lbs. of Newcastle coals per hour for each nominal horse power, and in inferior engines it may extend to 20 lbs.

When the consumption is stated at less than it amounts to, at 12 lbs. per hour for each nominal horse power, it may be fairly esteemed an experimental trial; and of course the fires are more carefully attended, with every precaution to prevent waste and give effect. The last column of Table III. will nearly give the fuel required per hour if the nominal power be taken in the first column, (art. 664.) when applied to steam boats.

The velocity of sea vessels appears to average about ten miles per hour; their power to face a wind is inconsiderable, because the wind gives the surface of the water so much velocity, that the paddles act with less force in proportion as the velocity of the water approaches to the difference between the velocity of the paddles and that of the vessel; and when these are equal, the boat will commence moving backward; and it is also with much reason supposed that the action of the wind itself tends greatly to retard a vessel's motion when it is directly opposed to it: for if a vessel of 100 horse power has a surface of 60 yards above water,¹ and the velocity of the wind be 50 feet per second, (in which vessels are under their courses,) then by the equation, (art. 647, note)

$$\frac{2500 \times 60}{3200} = 47 \text{ horse power,}$$

for the resistance offered to motion when the vessel is at rest; and as with whatever velocity the vessel moves against the wind, this velocity should be added to that of the wind, the plus sign being the proper one, in the equation for this case it will appear that the power to move forward is extremely limited with so much surface above water.

The only vessels in the table, art. 657. which have dimensions to enable us to approximate to their speed, are the 'Lightning' and the 'Dee;' and, notwithstanding the great quantity of power to be placed in the 'Dee,' I expect that its velocity in still water will be one-eighteenth less than that of the 'Lightning' in similar circumstances; and it would require the engines of the 'Dee' to be 230 horse nominal power to render them of equal speed. The 'Dee' spreads above water at an angle of about 50 degrees with the water line, to a width of about

¹ This is estimated from a vessel in use, and esteemed.

5 feet on each side, in the same manner as in boats for the accommodation of passengers.

660. Much has been said respecting American steam vessels; and these vessels as far as excellent workmanship, neatness of fitting up, and convenience is concerned, do appear to be superior to our own. Their best engines however seem to be not more than equal to the British ones, if so good, as many of the reports respecting them carry internal evidence of their inaccuracy. The best I have met with is that of the steam vessel called the 'Chancellor Livingston,' constructed by Mr. Fulton for the Hudson River, from New York to Albany. It is one of their largest vessels: the keel is 154 feet long; deck 165; breadth 32 feet; draught of water about 7 feet 3 inches, and burden 520 tons; the principal cabin 54 feet long, 7 high: ladies' cabin, above the other, 36 feet long, with closets; the forward cabin 30 feet long, and 7 high. The number of sleeping-berths, in the principal cabin, is 38; in the ladies' cabin 24; in the fore cabin 56; in the captain's cabin on deck 2; in the engineers' and pilot's 3; in the forecabin 6; and for fire-men, cooks, &c. 6; being a total of 135. The engine is of 60 horse power; the diameter of cylinder 40 inches, length of stroke 5 feet; the boiler is 28 feet long, 12 broad, with 2 funnels; the paddle-wheels 17 feet diameter; paddle-boards 5 feet 10 inches long; they have 2 fly-wheels, each 14 feet diameter, connected by pinions to the crank shaft. The machinery rises 4 feet and a half above the deck. Average rate of sailing is said to be 8 and a half to 8 and three quarter miles an hour. With a strong wind and tide in her favour she has made 12, but with wind and tide against her not more than 6 miles per hour. As for low pressure steam the engine is estimated at the greatest power of the cylinder, and it has been imagined that the vessel is moved by less power than the British vessels of equal magnitude.

The fallacy arises out of erroneous methods of measuring vessels to register their tonnage.

TO ASCERTAIN THE REGISTER TONNAGE OF A STEAM VESSEL.

661. The breadth is to be taken at the broadest part of the vessel, whether it be above or below the main wales, and is to be from the outside to outside of the plank; the length is to be the horizontal distance between the back of the main stern post and the fore part of the main stem, under the bowsprit; and calling this length l , the breadth b , and r = the length of the engine-room, the rule is

$$\left(\frac{l-r-\frac{3}{5}b}{188}\right) b^2 = \text{the tonnage. (Sect. 59th Geo. III. cap. 5.)}$$

Example. If the breadth be 32 feet, the length 162 feet, and the length of the engine-room 47 feet,

$$(162 - 47 - 19.2) \frac{32^2}{188} = 520 \text{ tons.}$$

The register tonnage is the same whether the draught of water be 7 feet or 14 feet; and it is the same whatever may be the form of the vessel: it is an unpleasant task for an Englishman to mark as fallacious the modes of measuring the capacity of vessels adopted by his government; it is necessary however for the purposes of science not only that it should be pointed out, but that the error should be corrected.¹

¹ Since the publication of the first edition, the Law of Tonnage has been altered and established by Act of Parliament, William IV., Sept. 9, 1835, of which the following is a summary:—

Divide the length of the upper deck between the after-part of the stem and the fore-part of the stern-post into SIX EQUAL PARTS, and note the foremost, middle, and aftermost points of division. DEPTHS. At these three points measure in feet and decimal parts of a foot, the depths from the underside of the upper deck to the ceiling at the limber strake, or, in case of a break in the upper deck, from a line stretched in a continuation of the deck. BREADTHS. Divide each depth into five equal parts, and measure the inside breadths at the following points, viz., at one-fifth and at four-fifths from the upper deck of the foremost and aftermost depths, and at two-fifths and four-fifths from the upper deck of the midship depth. LENGTH. At half the midship depth measure the *length of the vessel* from the after-part of the stem to the fore-part of the stern-post.

CALCULATION. To twice the midship depth add the foremost and aftermost depths for the *sum of the depths*; and add together the foremost upper and lower breadths, three times the upper breadth with the lower breadth at the midship, and the upper and twice the lower breadth at the after-division, for the *sum of the breadths*.

Then multiply together the *sum of the depths*, the *sum of the breadths*, and the *length*, and divide the product by 3500, which will give the number of tons or register.

If the vessel have a poop or half deck, or a break in the upper deck, measure the inside mean length, breadth, and height of such part thereof, as may be included within the bulk-head; and multiply these three measurements together, and divide the product by 92.4. The quotient will be the number of tons to be added to the result as above found.

To ascertain the tonnage of *open vessels*, the depths are to be taken from the upper edge of the upper strake.

For STEAM VESSELS, the tonnage due to the engine-room shall be deducted from the total tonnage calculated from the above Rule. To determine this, measure the inside length of the engine-room from the foremost to the aftermost bulk-head; then multiply this length by the midship depth of the vessel, and the product by the inside midship breadth at two-fifths of the depth from the deck, and divide the final product by 92.4.

662. TABLE I. Of the Properties of the Steam of Water of different degrees of elastic force.

Total force of steam.			Excess of force above the atmosphere.		Temperature, Fahrenheit.	Volume in cubic feet, the water being 1.	Weight of a cubic foot in grains.	Specific gravity, air being 1.	Velocity into a vacuum in feet per second.	Heat of conversion from water of 52°, to steam.
In atmospheres.	In inches of mercury.	In lbs. per circular inch.	In lbs. per circular inch.	In lbs. per square inch.						
·0183	·55	·21	—11·33	—14·4	60°	72190	6·1	·0115	1377	1008°
·0333	1	·385	11·155	14·2	77	41010	10·7	·0202	1400	1025
·0667	2	·77	10·77	13·7	98·7	21400	20·5	·0358	1427	1047
·1	3	1·15	10·39	13·2	112·5	14570	30	·0568	1445	1061
·133	4	1·54	10·0	12·7	123	11130	39	·0744	1458	1071
·25	7·5	2·88	8·66	10·99	147·6	6187	71	·134	1499	1096
·5	15	5·77	5·77	7·33	178	3249	135	·255	1526	1126
·75	22·5	8·65	— 2·89	— 3·66	197·4	2232	196	·371	1549	1146
1·00	30	11·54	0·	0·	212	1711	254·7	·484	1566	1160
*1·17	35	13·46	+ 1·02	+ 2·44	220	1497	292	·553	1575	1168
1·5	45	17·31	5·77	7·33	233·8	1178	363	·687	1591	1182
1·75	52·5	20·19	8·65	10·99	242·5	1022	427	·81	1601	1191
2·0	60	23·08	11·54	14·65	250·2	905	483	·915	1610	1199
2·5	75	28·85	17·31	21·98	263·5	737	593	1·123	1625	1212
3·0	90	34·62	23·08	29·3	274·7	623	700	1·33	1638	1223
3·5	105	40·39	28·85	36·63	284·5	542	810	1·53	1649	1233
4	129	46·16	34·62	43·95	293·1	479	910	1·728	1658	1241
5	150	57·7	46·15	58·60	308	391	1110	2·12	1674	1256
6	180	69·24	57·7	73·25	320·6	331	1317	2·5	1688	1269
7	210	80·78	69·24	87·90	331·5	288	1520	2·88	1700	1280
8	240	92·32	80·78	102·55	341·2	255	1660	3·25	1710	1289
9	270	103·86	92·32	117·20	350	229	1910	3·61	1720	1298
10	300	115·4	103·86	131·85	358	209	2100	3·97	1729	1306
20	600	230·8	219·26	278·35	414	111	3940	7·44	1786	1362
30	900	346·2	334·66	424·85	450	77	5670	10·75	1823	1398
40	1200	461·6	+ 450·06	+ 571·35	477	60	7350	13·88	1850	1425
1	2	3	4	5	6	7	8	9	10	11

The mode of obtaining the first five columns is obvious; and in the fourth and fifth the negative sign indicates that the force of the steam is less than atmospheric pressure, and the numbers show how much less: the sixth column is calculated by art. 89, the seventh by art. 121, and from it the eighth and ninth: the tenth column is calculated by the equation in the note to art. 136, with the allowance for contraction of the aperture; and the last column is obtained in the manner shown in the note to art. 190.

* The usual force of low pressure steam.

663. TABLE II. Of the Proportions of Single Acting Steam Engines equivalent to different numbers of horses ; the horse power being 33000 lbs. raised one foot high per minute, and the elastic force of the steam in the boiler = 35 inches of mercury.

Steam acting expansively.								Steam at full pressure throughout the stroke in the same engine.	
Number of horse power.	Diameter of the steam piston.	Mean pressure on the piston, at 5½ lbs. per circular inch.	Velocity of the steam piston per minute.	Length of the stroke.	Number of strokes per minute.	Water required per hour to supply the boiler.	Coals consumed per hour.	Number of horse power.	Coals consumed per hour.
horses.	inches.	lbs.	feet.	feet.	strokes.	cubic feet.	lbs.	horses.	lbs.
10	26.4	3850	174	4.4	19½	11.1	114	11.2	152
15	31.1	5324	187	5.2	18	16.7	164	16.8	220
20	34.9	6702	197	5.8	17	22.3	213	22.5	285
25	38.1	8012	203	6.3	16	27.7	257	28.	343
30	41.1	9270	214	6.8	15½	33.3	307	33.5	410
35	43.7	10490	221	7.3	15¼	39.	356	39.2	475
40	46.1	11670	227	7.7	14¾	44.5	401	45.	536
45	48.3	12820	232	8.0	14½	50.	450	50.5	600
50	50.4	13950	237	8.4	14¼	55.5	500	56	670
55	52.3	15050	242	8.7	14	61.2	551	62	735
60	54.2	16140	246	9.0	13¾	66.7	600	67	800
65	56.0	17210	250	9.3	13½	72.1	649	73	865
70	57.6	18260	254	9.6	13¼	78.	702	78	940
75	59.2	19290	257	9.8	13	83.3	750	84	1000
80	60.8	20310	260	10.1	13	89.	801	89	1070
85	62.3	21330	264	10.4	12¾	94.5	851	95	1140
90	63.7	22320	267	10.6	12½	100	900	101	1200
100	66.5	24290	272	11.0	12¼	111	999	112	1330
120	71.5	28100	283	11.9	12	133	1197	134	1600
140	76.0	31790	291	12.6	11½	156	1404	157	1860
160	80.2	35380	299	13.3	11¼	178	1602	179	2140
180	84.1	38870	307	14.0	11	200	1800	201	2400
200	87.7	42300	313	14.6	10¾	222	1998	224	2650
213½	90	44550	318	15.0	10½	237	2133	265	2860

664. TABLE III. Of the Proportions of Double Acting Steam Engines equivalent to different numbers of horses; the horse power being 33000 lbs. raised one foot high per minute, and the elastic force of the steam in the boiler = 35 inches of mercury.

Steam acting expansively.								Steam acting at full pressure throughout the stroke in the same engine.	
Number of horse power.	Diameter of the steam piston.	Mean pressure on the piston at 4.8 lbs. per circular inch.	Velocity of the steam piston per minute.	Length of the stroke.	Number of strokes per minute.	Water required per hour to supply the boiler.	Coals consumed per hour.	Number of horse power.	Coals consumed per hour.
horses.	inches.	lbs.	feet.	feet.	strokes.	cubic feet.	lbs.	horses.	lbs.
1	7.8	289	114	1.3	44	0.8	15	1.46	31.5
2	10.25	516	131	1.75	37½	1.37	23	2.95	49
3	12.05	697	141	2.	35	2.36	30½	4.4	64
4	13.52	877	149	2.25	33	3.13	38	5.9	80
5	14.9	1049	157	2.5	31½	3.92	45	7.4	94
6	15.9	1214	162	2.65	30½	4.7	53	8.85	111
7	16.9	1373	167	2.8	29¾	5.5	60	10.3	126
8	17.85	1527	171	2.97	29	6.3	67	11.8	140
9	18.7	1678	175	3.1	28½	7.05	73	13.3	153
10	19.5	1826	180	3.25	28	7.82	80	14.6	168
12	20.9	2113	186	3.5	26½	9.4	95	17.7	199
14	22.3	2390	191	3.7	25¾	11.0	109	20.7	230
16	23.6	2659	196	3.9	25	12.6	122	23.6	256
18	24.7	2922	201	4.1	24½	14.1	135	26.5	283
20	25.75	3179	206	4.3	24	15.7	149	29.5	312
22	26.75	3431	211	4.5	23½	17.3	163	32.5	341
24	27.7	3678	213	4.6	23¼	18.8	176	35.5	370
26	28.6	3922	216	4.75	22¾	20.4	189	38.4	395
28	29.45	4161	220	4.9	22½	22.	203	41.3	425
30	30.27	4397	222	5.04	22¼	23.5	216	44.2	451
32	31.1	4630	226	5.2	21¾	25.1	230	47.3	480
34	31.82	4860	229	5.3	21½	26.7	243	50.	510
36	32.56	5088	232	5.43	21¼	28.3	256	53.	535
38	33.3	5313	234	5.55	21	29.7	269	56.	561
40	34.	5535	237	5.67	21	31.4	283	59.	596
42	34.63	5756	239	5.77	20¾	33.0	297	62.	624
44	35.13	5919	241	5.85	20½	34.5	311	65.	652
46	35.9	6190	244	6.0	20¼	36.2	324	67.5	680
48	36.5	6404	246	6.1	20¼	37.7	338	70.5	709
50	37.13	6617	248	6.2	20	39.3	353	73.5	739
52	37.7	6828	250	6.3	20	40.7	367	76.4	768
54	38.3	7036	252	6.4	19¾	42.4	381	79.3	798
56	38.85	7245	254	6.49	19½	44.0	396	82.2	827

Table III. continued.

Steam acting expansively.								Steam acting at full pressure throughout the stroke in the same engine.	
Number of horse power.	Diameter of the steam piston.	Mean pressure on the piston, at 4·8 lbs. per circular inch.	Velocity of the steam piston per minute.	Length of the stroke.	Number of strokes per minute.	Water required per hour to supply the boiler.	Coals consumed per hour.	Number of horse power.	Coals consumed per hour.
horses.	inches.	lbs.	feet.	feet.	strokes.	cubic feet.	lbs.	horses.	lbs.
58	39·4	7453	255	6·57	19½	45·4	409	85·1	850
60	39·9	7656	257	6·65	19½	47·0	423	88·1	887
62	40·5	7860	259	6·75	19½	48·6	437	91·0	916
64	41·0	8062	260	6·83	19	50·2	452	93·9	946
66	41·5	8263	261	6·9	19	51·8	466	96·8	975
68	42·0	8462	263	7·0	18¾	53·4	481	99·7	1005
70	42·5	8662	265	7·1	18¾	55·0	495	102·7	1035
72	43·0	8858	266	7·17	18½	56·6	509	105·6	1064
74	43·4	9013	268	7·23	18½	58·1	514	108·5	1094
76	43·9	9250	269	7·3	18½	59·8	538	111·4	1123
78	44·4	9444	270	7·4	18½	61·5	554	114·3	1153
80	44·8	9637	272	7·47	18½	62·5	563	117·3	1182
85	45·9	10120	275	7·65	18	66·5	599	124·6	1256
90	46·97	10590	279	7·83	17¾	70·5	635	131·9	1330
95	48·0	11060	282	8·0	17¾	74·4	670	139·2	1404
100	49·0	11520	284	8·16	17½	78·2	704	146·0	1478
105	49·95	11980	287	8·32	17½	82·1	739	153·3	1552
110	50·9	12430	290	8·5	17	86·0	774	161·6	1626
115	51·6	12760	292	8·6	17	89·9	809	167·9	1700
120	52·7	13330	294	8·8	16¾	93·8	844	175·2	1774
125	53·6	13760	297	8·9	16¾	97·7	879	182·5	1848
130	54·4	14210	299	9·0	16½	101·7	915	189·8	1921
135	55·3	14740	300	9·2	16½	105·6	950	197·1	1995
140	56·1	15080	302	9·35	16½	109·5	986	204·4	2069
145	56·84	15510	306	9·47	16½	113·4	1021	211·7	2143
150	57·6	15930	308	9·6	16	117·3	1055	219·0	2217
155	58·4	16360	310	9·7	16	121·2	1091	226·3	2291
160	59·1	16780	312	9·83	15¾	125·2	1127	233·6	2364
175	61·3	18030	318	10·2	15½	129·1	1162	240·9	2438
180	62·0	18440	320	10·3	15½	133·0	1197	248·4	2512
200	67·7	22000	334	11·3	14¾	156·4	1408	292·0	2956

1000

1000

EXPLANATION OF THE PLATES;

WITH REFERENCES

TO THE

ARTICLES WHERE THE CONSTRUCTION IS INVESTIGATED.

PLATE I.

Fig. 1. is an isometrical projection of a rectangular steam boiler, (art. 225, 226.) with part of the top plates of the boiler, and part of the brickwork removed to show the internal parts. A is the boiler; the half of the doorway to the fire is at B, and the fuel rests on the fire-bars G, and against the back F: the flame passes over F, and along under the bottom; it rises at H, and returns in a flue by the nearest side, passes round the end by the flue I, and along a flue by the further side to the chimney at L; a horizontal damper K regulates the aperture to the chimney. See art. 257. The door to the ash-pit C should shut perfectly close, and the supply of air for the fire should enter by a passage E, the aperture of which is regulated by the force of the steam acting by the chain *n, n*, (art. 258.) In the figure the air is supposed to enter by the grating at D. The supply of water enters by the pipe M N, the end N being turned along the bottom of the boiler, that the water may acquire heat before it mixes with the rest; the admission is regulated by the stone float *c*. (art. 251—253.) The steam passes to the engine by the pipe S, and when it is not required, it goes off by the safety valve V, (art. 260.) and through the pipes T W. The internal valve is on the man-hole plate at *a b*, (art. 259.) The steam gauge is at *h*, (art. 558.) the gauge cocks at *k, i*; and a cock to clear the boiler of water is at R. Opposite each flue, as at Q, there must be an aperture to clear it out at.

Fig. 2. shows a method of admitting water to a boiler where high pressure steam is used. The pump forces the water by the pipe D, through the valve aperture A, into the boiler; but when the quantity is in excess, the copper float F closes the valve, and opens the valve B to the waste pipe C, by which the surplus passes off. The parts must be balanced on the axis by the weight G. (See art. 253.)

Fig. 3. 4. 5. and 6. are tops for engine chimneys. Fig. 3. is a plain obelisk: the proportions of an Egyptian obelisk are very well adapted for a chimney, and if the faces were stuccoed and covered with sunk figures, it would render them novel and ornamental. Fig. 4. is an octagon top for a square shaft; Fig. 5. an octagon chimney; and Fig. 6. a chimney to represent a column. (See art. 274—278.)

PLATE II.

This plate represents a plan and two sections of a cylindrical steam boiler, (art. 227—230.) Fig. 1. is a cross section, Fig. 2. a longitudinal section, and Fig. 3. the plan; in the last, half of it is the plan above the level of the boiler bottom, and the other half below it. The fuel is put in at the fire-door B, it inflames at D, and the smoke in passing over the hot current of air rising through the red fuel at E is consumed. The ash-pit door is supposed to be provided with a register to regulate the admission of air, but it would be better to make it regulate itself as in the preceding plate. By pushing back the plate *k* by the handle *i*, the clinkers are let out behind, (art. 248.) The supply of water is regulated by a hollow copper-ball float, and the supply is continuous, except, when by the water rising, the valve is closed, (art. 254.) To prevent sediment depositing over the fire, I would recommend a division to be placed across the boiler as at O; the safety pipe T W is recommended instead of the valve, on account of the certainty of its action. The first effect of strong steam is to displace the water down to the level of the mouth of the pipe at T; this sets the feed pipe into action, and steam and water rise by the pipe T W till the boiler be cooled to its proper temperature, (art. 264;) no internal valve is required: S is the steam pipe leading to the engine. The same letters refer to the same parts in all the figures. For the area of the grate, and ash-pit, see art. 197—199; size of the boiler, art. 229; the area of the chimney, art. 274—278; and the strength of the boiler, art. 525.

Note. In Section III. I neglected to remark that the boilers formed of small pipes cannot possibly produce more effect than others, and that every boiler must contain a certain quantity of water and steam, otherwise the slightest neglect of the fire would cause the engine to stop. It has been pretty clearly ascertained that not one of the combinations hitherto proposed, has equalled the kind of boiler above described.

PLATE III.

This plate represents Brunton's apparatus for feeding furnace-fires by means of machinery. The general principles of the method and its advantages have been stated, (art. 250.) and it only remains to describe the parts of the figure. The apparatus was added to two boilers of Boulton and Watt's construction. To the original boilers A A, two additional boilers B B, are attached, which are prepared for the purpose of being over the revolving fire-grate; the smoke from which passes over and under the bridges *d d*, and round the boilers A A, by the flue C; and D D are the flue-doors. The coals, broken to a proper size, are put into the hoppers E E, and fall through the openings F F, and through the top of the boiler to the grate. The door H, to examine or repair the fire-place, is attached to the boiler by a cement joint. The additional boilers are connected to the main boilers by the steam pipes G G.

To clear the dust away that falls over the edge of the revolving grate, there are doors at I I; they also admit a small quantity of air to the burning fuel. The axis K of the grate is turned by the pinion and wheel at L, turned by the upright shaft N, which receives its motion by the shaft R from the engine.

The pivot of the shaft N, and of the spindle K, are in the foundation plate M. The grate bars are surrounded by fire bricks *h*, and a thin hoop projects below the frame, and moves in sand in a trough *f*, and prevents air entering by any other passage than through between the bars: a scraper attached to the grate, and consequently moving with it, keeps the channel *i* clear of dust.

To regulate the fire, the chains S S are connected to the damper chains, and raise or depress the wedge U by the lever T, and thus increase or diminish the supply of coals according to the force of the steam. (See art. 257.)

The feed pipe O, with its stone float *c* and balance *l*, are as in other boilers, (art. 251.) The gauge-cocks are at Z, the man-hole at *a*, with an internal valve at *b*; the safety valve is at V, with a pipe Q to convey away the steam; P is the pipe for conveying steam to the engine, with a self-acting stop valve W, to prevent the steam passing from one boiler to the other when both are in action; and X Y is a lever handle for closing the aperture when only a small supply of steam is required.

The construction will admit of considerable variation; and its advantages in saving fuel, in regularity of action, and in consuming the sooty matter of smoke, render it a desirable addition to a large boiler.

PLATE IV.

Fig. 1. is a section of the parts of a high pressure engine with a four-passaged cock. The engine is supposed to be partly within the boiler, of which D B is the top plate. P is the steam piston, and R the piston rod, A is the four-passaged cock; the steam enters from the boiler at S, and passes through *t* to the top of the piston, and the steam below escapes through the passage *b*, and pipe *a* and E, to the atmosphere; the pipe E is surrounded by water, which the escaping steam warms ready for the boiler. By turning the cock the motions are reversed, but it is obvious we cannot in this engine employ the expanding force of the steam. The motion is regulated by a throttle valve V. See art. 356—361.

Fig. 2. and 3. show a section and plan of a similar engine, with a D-slide instead of a cock; the steam enters from the boiler at S, and by the passages being shut and opened close to the extremities of the cylinder, there is no loss by the communicating pipes being filled with strong steam. See art. 364. This engine will not work expansively unless the construction of the slide be altered. See art. 371. Contrary to the usual practice, the packing of the slide is on the sliding part; the advantage of this plan is obvious, but the practical difficulty of boring a semi-cylinder is incurred.

Fig. 4. is a simple arrangement of the high pressure engine by which the expanding power of the steam may be used; it is the invention of Murdoch. The passages are opened and closed by pistons sliding in a pipe: the steam enters this pipe at S, and the steam is supposed to be just shut off by the upper piston, so that by the expansion of that in the cylinder the rest of the stroke is completed, the passage E to the atmosphere being still open. See art. 371—380. The slide would be improved by making it of the form of a D-slide.

The construction of the pistons of the slide is a suggestion which may perhaps answer better than the common ones, (art. 450. and note.)

Fig. 5. is an arrangement to illustrate the action of a high pressure engine to work expansively by means of combined cylinders. See art. 381—383.

PLATE V.

Fig. 1. is a section of a double-acting condensing engine, with a slide adapted for working by the expanding force of steam; the slide being, in Fig. 1., in the position for letting the steam on at the top. Fig. 2. shows the steam shut off, and the passage to the condenser still open; and Fig. 3. the position when the steam is let on at the bottom. See art 448. The steam enters at S, and a pipe of communication between the steam pipe and the condenser is necessary, to allow steam to enter the condenser when the engine is about to be set to work, (art. 414.)

Fig. 4. is a section of a single-acting condensing engine, with valves to the passages, (see art. 406.); and Fig. 5. a different arrangement of the valves for a single engine.

Fig. 6. represents the box slide, admitting steam through the upper passage and open below to the eduction passage, or to the condenser.

In all these figures the same letters indicate the same parts. C is the steam cylinder, P the steam piston, R the piston rod, B the condenser, with a jet of water playing into it from I the injection cock; A is the air pump, and *p* its piston; G is the foot valve between the condenser and air pump; M the air pump, and Q the discharge valve of the air pump, through which the air and hot water are forced into the hot well K, from whence a part is raised by a small force pump to the boiler feed head, and the rest runs off by a waste pipe. H is the blow valve to the condenser, (art. 566.) The condenser and air pump are placed in a cistern, which is constantly supplied with cold water by a pipe N.

The jet should be made through a rose on the end of the pipe; for, to produce speedy and perfect condensation, the cold fluid should present the greatest possible surface to the steam it is to condense, (see art. 280.); and it should be impelled into the condenser with greater force than the ordinary head in the cistern admits of.

In large engines the connecting eduction pipe E, Fig. 1. may be on the outside of the steam pipe S, and the parts of the slide connected only by a rod, as mentioned in art. 447.

PLATE VI.

Fig. 1. is a section of a common atmospheric steam engine ; C is the cylinder, and the piston is supposed to have a wooden bottom, according to the practice of Smeaton, (art. 466.) ; the steam is let on by a modification of Hornblower's valve, (art. 442.) instead of the common regulator, (art. 461.) For the proportions of the engine, see art. 393—399.

Fig. 2. is a section of an atmospheric engine with a separate condenser and air pump ; see art. 400—405. An elevation of this engine is shown in Plate XI.

Fig. 3. is a section of a combined cylinder engine on Hornblower's principle, (art. 32.) where the steam passages are opened and closed by a combination of slides in one pipe. See art. 425—429. Woolf's engines have two cylinders, but the passages are opened by valves.

Fig. 4. is a section of Hornblower's double-seated valve. See art. 441.

Fig. 5. represents a section of Murray's slide ; it is a sliding cover which alternately covers the passages *ac* and *cb* : the disadvantage of this construction is, that the pressure of the steam is nearly three times as great on the moving surfaces, as it is in Murdoch's arrangement shown in the last Plate. See art. 446.

Fig. 6. and 7. show the mode of forming the apertures of a four-passaged cock, so that the steam may be shut off at any period of the stroke without closing the passages to the condenser. See art. 456. T is the passage to the top, and B that to the bottom of the cylinder ; the steam enters at S, and C is the passage to the condenser. Fig. 6. shows the position of the cock when the steam is entering, and Fig. 7. when it is shut off.

PLATE VII.

This plate is to represent the construction of pistons.

Fig. 1. represents a section, and part of the plan, of the common packed piston, which is tightened by the screws *S* when it wears. See art. 467.

Fig. 2. shows one of Woolf's methods of tightening the whole of the screws at once, and consequently in the most regular manner, without having to take off the cylinder lid. See art. 468.

Fig. 3. is the plan and section of Cartwright's metallic piston, (art. 43.) as at first executed; it was afterwards made with spiral and other springs, acting only on the interior segments of rings *bb*, but it required that the outer ones should be moved; and this has been done by making the interior segments in short pieces to cover the joints of the outer ones, so as to leave space to insert springs between them, to act directly on the outer segments, by Mr. Lloyd: it has also been done by inserting a short cylindrical piece against each joint of the outer ring, both the cylindrical pieces and the outer segments being pressed outwards by spiral springs: this method is employed by Messrs. Hall. See art. 469.

Fig. 4. represents Barton's construction of metallic pistons in plan and section. The points of the wedges *G* expand faster than the segments *E* in the ratio of *mn* to *on*, and hence wear the cylinder unequally. To prevent this, the points are shortened, and two elastic hoops *bb*, Fig. 5. are put round, neatly fitted with a loose tongue joint, as shown at Fig. 6. See art. 470.

Fig. 7. shows a method of avoiding the defect of Barton's piston, by keeping the points of the wedges as much within the segments of the piston as may be necessary for wear, before a change of parts becomes necessary, and making two series to break joints. See art. 471, 472.

Fig. 8. represents a section of Jessop's piston, and Fig. 9. the expanding coil of metal which rubs against the cylinder. See art. 473. I am of opinion that a more perfect method of pressing the packing against the metal coil, is the only thing wanted to render this decidedly the best kind of piston.

The friction of pistons is investigated in art. 474.

PLATE VIII.

Fig. 1. represents a section of the steam pipes and valves of Messrs. Fenton and Murray's¹ double engine, Plate xiv.; and Fig. 2. the communicating rods. The steam enters by the pipe C, which has a throttle valve at *a*, to regulate the supply of steam to the engine, (art. 544.) It is regulated by the action of the governor balls on the lever *b*, by the connecting rod *c*: the rotary motion is communicated to the axis of the governor, by means of a band passing from a pulley on the crank shaft to a similar pulley *d* on the axis of the governor. The governor consists of two bent levers *e e*, passing through a slit in the middle of the spindle, and turning upon an axis at *f*. The upper part of the spindle has a slide *h*, which is connected to the levers by the rods *i i*, and ascends when the centrifugal force of the governor increases, so as to cause the balls to rise, and descends when it decreases; and the lever *l* moves with it, and consequently the valve. When the engine is at rest, the balls *j j* rest against the arms *k k*; the upper end of the levers *e e* are nearer to each other; and the rod *c* is raised so that the throttle valve may be quite in a horizontal direction, and the pipe completely open for the passages of the steam. See art. 550.

By the pipe D D, the steam passes either to the top or bottom of the cylinder from the throttle valve *a*, and by the eduction pipe E E the steam from either passes down to the condenser. The valves *n o* have each a cylindrical tube or spindle passing through the stuffing boxes *r s*; the upper end of each of these has a stuffing box, the upper one at *t*, the other at *u*, for the rods of the valves *p q*, which open to the eduction pipe E, so that either the steam or eduction valves may be opened without allowing steam to escape.

Fig. 2. is a front view of the two sliding rods which give motion to the valves *n, o, p,* and *q*. These rods are kept in a perpendicular direction by the pieces *z z*, and the guide 1; the lower end of the rods have friction rollers 3 3, which are acted upon by the two eccentric pieces 4 4, on the horizontal shaft Z, which derives its motion from a shaft Y, placed at right angles to, and communi-

¹ In reference to these nozles and side pipes, Fenton and Murray brought an action against Boulton and Watt for an infringement on their patent for working one valve through the other; but it was decided that Mr. Boulton's Mint Engine had been working with valves similarly constructed for a length of time previous to their patent.

cating by means of beveled wheels with the crank shaft. Four arms, 9, 10, 11, and 12, are fixed to the rods *v v* and *w w*, for the purpose of moving the valves, and a lever or handle (13), turning on a pin screwed on the pipe E, is used to open and shut the steam valves when the engine is first set to work ; (see art. 566 ;) the steam gauge (21) is for measuring the pressure of the steam above that of the atmosphere, (art. 558.) and the condenser gauge (24) is for measuring the force of the vapour in the condenser, (art. 559.)

Fig. 3. 4. 5. and 6. represent the four-way cock as executed by Maudslay. Fig. 5. is the plan taken at the horizontal line D E, in Fig. 3. and 4., which are sections through the steam cock. In these figures E is the steam pipe, and F the pipe leading to the condenser G. Fig. 4. is the steam cock or cone ground into its seat, and provided with a grease cup H to afford a regular supply.

Fig. 6. is a plan of the upper side of the steam cone. See art. 457 and Plate xv.

PLATE IX.

The apparatus for opening and closing the steam passages is of more importance to the perfection of the steam engine, than any other part of its mechanism. In the present state of the engine the action is either very complicated or imperfect: my object in this plate is to show how the imperfection of the most simple method may be avoided, and also how it may be applied to reciprocating movements.

Fig. 1. shows a section,¹ and Fig. 2. a plan, of an apparatus for opening and closing the steam passages by means of the rotary motion of the crank shaft D: the object of the method is to give such a form to a wheel on the shaft D as will move the pin *e* twice during the stroke, and in the easiest and quickest manner. For this purpose the shaft passes through a rectangular frame which rests in grooves on the shaft to keep it in its place, with liberty to slide backwards and forwards; and it is provided with two rollers, to be acted on by the curved surfaces of a wheel fixed on the shaft. The curve H G moves the valves at the termination of the stroke, and I K shuts off the steam, that the engine may work expansively the rest of the stroke. In order that there may be the power of varying the time of cutting off the stroke, the curve I K may be on a separate piece M, (Fig. 2.) capable of being moved from N to O. The apparatus is supposed to move a slide of the kind represented in Plate v. Fig. 1; but is equally applicable to move the four-passaged cock, (art. 456 and 458) or valves. For the nature of the curves, see art. 481.

Fig. 4. and 5. represent the same principle applied to a reciprocating motion. The plug-tree A B is kept in its place by guides on the brackets; these guides slide in the dark grooves. The curved parts H I, C D, K L, &c. successively move, horizontally, the frame C on four rollers supported by the brackets attached to the engine; and by the backward and forward motion it turns the axis E, and raises or depresses the lever F, which acts on the rod of the slide. The same movement would obviously open valves or turn a cock. By the lever on the right-hand side, the roller frame may be moved by hand; but by not reversing Fig. 5. it has been shown there on the left. See art. 483.

Fig. 3. represents the method of opening valves by weights, the plug-tree A B being made a means of raising the weights, and of disengaging them by the tappets *f*, *d*. See art. 478.

¹ Fig. 1., as represented in the Plate, is too much limited to allow the motion to be reversed.

PLATES X. (A) AND (B).

The figures of these plates are to illustrate the combinations used to produce rectilinear motion, from motion in a circular arc.

Fig. 1. is the parallel motion used for steam boat engines. The beam $A F$ is below the cylinder; from G , the end of the cross head, draw a line to A , the centre of the axis of the beam, and it will cut the rod $D B$ in E , and the length of the radius bar $C D$ may be found by art. 492.; when $E B$ is equal to $E D$, the length of the bar $C D$ is equal to $A B$, and this is the best though not always the most convenient form. The rod $D' G$ may be at any height, provided it be parallel to $A F$; and B may be at any point in $A F$, if the position of C is not limited.

Fig. 2. shows the most common construction for engines with the beam above the cylinder. H is the piston rod connected at G , and $C D$ is the radius bar. The line $G A$ cuts the link $B D$ in E , the proper point for the air pump rod. Fig. 3. shows a plan of the upper side of the beam, where $C D$, $C D$ are the radius bars; and the beam is in two parts, as is usual in large engines.

Fig. 4. is a diagram to illustrate the investigation of the properties of the combination in its most simple form. See art. 489.

Fig. 5. is a diagram for the apparently more complicated case, when the rod is fixed to one angle of a parallelogram. See art. 492.

Fig. 6. shows how to arrange for three piston rods to move parallel, as for Woolf's engine: the points of suspension must be all in the line $A G$; and any number of them may be similarly adapted.

Fig. 7. shows another arrangement for three rods at one end, and two at the other end of the beam. See art. 495. The dotted arcs, Plate x. (B), show how the centre C for the radius bar may be determined geometrically, by drawing a circle through the three positions, D, d, d' , of the point of connexion.

In all the cases the corresponding points are marked by the same letters, and therefore by referring to the investigation of Fig. 4. the relations may be traced: the particular forms of different engine makers will be found by turning the part upside down, altering the place of the parallel bar $G D$, or altering the proportions of the parts. In every combination where the bar $C D$ is not equal to $A B$, the variation from rectilinear motion increases with the extent of the angle described.

Variations of the parallel motion are exhibited in some of the other Plates.

Fig. 8. is designed to show that the vibrating pillar motion is exactly the same in principle, and only differs in the particular mode of combination. See art. 494. Fig. 9. is a particular case.

Fig. 10. and 11., parallel motions for steam boat engines, show how the point of connexion of the radius rod may be determined by geometrical construction. Thus, having determined the three points, H, h, h' , set off hk equal to Ch' ; join Ck , and bisect it with the straight line nd , meeting kh in the point required: for since $kd = Cd$, and $hk = Ch'$, we have $hd = h'd'$; and hence when d arrives at d' , h will coincide with h' , and the motion will thus be properly adjusted. Fig. 1. may be constructed in this manner. See art. 492.

Fig. 12. exhibits a simple parallel motion, and is easily constructed geometrically by finding C , the centre of a circle, passing through the three points $D D' D''$. Fig. 13. shows how a pump rod may be attached to this motion.

PLATE XI.

This plate represents a plan and elevation of an atmospheric engine for raising water from a mine. The beam is supported by a frame of cast iron, designed so that it may be taken apart when it is necessary to move the engine to another mine, (art. 578.) The steam comes from the boiler by the steam pipe S , and is admitted to the cylinder C by a sliding piston in B , (see Fig. 2. Plate VI.) and then the piston in the cylinder C rises to the top of the stroke, and the piston rod forces the end f of the beam up with it; as the beam rises, it draws the rod FG with it, which near the end of the stroke moves the sliding frame H , (art. 483.) and by the rod O the slide in B , so as to shut the steam off, and open the passage to the air pump A : into the passage a jet of water plays at I . The piston then begins to descend by the pressure of the atmosphere and raises the pump rods, and at the end of the stroke the part F of the rod FG moves the slide, and shuts the passage to the air pump, and opens that for the steam. See Plate VI. Fig. 1.

The parallel motion¹ is guided by the radius rod cd attached to the frame, (art. 491. and 495.) and by connecting the rods hi : the same rod does for both ends of the beam. The sliding frame H is supported by a cross bar beneath H , and another at K , and the slide may be moved by hand by the lever M . Cold water for injection is supplied by the pump E , and water is raised from the hot well by the pump D , and passes to the boiler by the pipe Q , with a small branch pipe at P , to give water to the top of the piston. See art. 400—405.

¹ In the parallel motion apparatus, shown in Fig. 1., the vibration of the beam is not bisected. See p. 233, Note.

PLATE XII.

This plate shows an elevation of a single acting engine, as executed by Messrs. Boulton and Watt. The boiler *a* is inclosed in a case of brickwork, and the steam passes by the steam pipe *b*, to the cylinder *c*, which is firmly attached to the floor of the engine room, by the bolts *d, d*: its upper end is covered by the lid *e*, through which the piston rod *k* slides in an air-tight box called a stuffing box. The beam *f g* moves on its axis or gudgeon at *h*; and the bearings in which the gudgeons work are sustained by the floor and wall *i*.

The pump rod *j*, carrying a counter-weight, is suspended at the end *g* of the beam; and both it and the piston rod *k* are connected by a parallel motion apparatus to the working beam *f g*. See art. 492.

The condensing cistern is at *m*, and contains the air pump *n*, the condenser, and hot well *o*: a continued supply of cold water is procured by the action of the cold water pump *p*, and the excess is carried off by a waste pipe to the well *g*; the whole of the external part of the apparatus being kept by that means at the lowest temperature possible.

The upper steam valve is at *r*, and the lower at *s*, and the exhaustion valve at *t*. See Fig. 5. Plate v. These valves are moved by the plug tree *v*, which is furnished with tappets to give motion to the levers acting on the valves *r, s, t*. See art. 478.

The pump to raise water from the hot well *o*, to supply the boiler, is at *u*, and the water is conveyed by the pipe *w w* to the small cistern *x* on the top of the feed pipe, which is provided with a valve, and acted on by a lever connected by a wire passing down through a stuffing box *y*, to a stone float in the boiler, which by its descent opens the valve, and allows the admission of an additional supply of water when it is required, (art. 251.)

In order to prevent concussion, two blocks 1, 2, are fixed across the upper side of the beam, and extend on each side so as to strike on four wooden springs, on the floor which supports the beam. See art. 549.

For large engines the beam is in two parts, with a space between them, as shown in Fig. 3. Plate x.

The proportions of the single engines are given in Sect. vi. art. 406—413; the application, in art. 572, 573. 582. and 587; their effects, art. 576; and their power, and consumption of fuel, Table n. art. 663.

PLATE XIII.

This plate represents a double acting steam engine for raising water, (art. 570, 582.)

The steam from the boiler enters by the steam pipe S, passes through the top valve *a*, to act on the piston *p*, and forces it down; and just before it arrives at the bottom of the cylinder, the plug on the rod R will come in contact with a lever, and shut the valves *a b*, and open *c d*, which were shut; the steam will now continue its course down the pipe S through the valve *d*, act on the bottom of the piston *p*, and again force it up to the top of the cylinder, while the steam which forced it down will make its escape to the condenser B, through the valve *b*, by a pipe which conveys the steam from the valves to the condenser.

Having described one double stroke of the engine, it is only necessary to remark that its continued motion is made of a repetition of the same thing over again. The steam which passes to the condenser B meets with a jet of cold water from the injection cock I, and the greater part of it is reduced to the state of water, and it is the office of the air pump A to clear it away. The rod R works the air pump which draws out all the injected water, air, and condensed steam, and discharges it through the valve at the top of the air pump into the hot well, where a certain portion of the water is again forced back to the boiler by the force pump L, and the remainder runs to waste: at the same time, to the other end of the great beam is attached the rod of the cold water pump N, which supplies the cistern containing the condenser and air pump with cold water; and from this source the injection cock has its supply.

The governor Q is put in motion by beveled wheels on the shaft of the fly wheel P, (art. 540.) and regulates the throttle valve in the steam pipe S, so as to close it a little for a less admission of steam when the speed is increasing; and on the contrary, when the engine relaxes in its speed, the balls will again begin to fall, and open it a little so as to admit more steam; by this means the work may vary, and yet a uniform motion be kept up by the engine, (art. 550.)

In the pumping apparatus, the rod M is the pump rod for the purpose of raising water; when the rod descends, the water will be forced through G into the upper air vessel E, from whence it passes in a continued stream to the reservoir, at a distance and height proportional to the power of the engine. The barrel of the pump will be refilled from F, the source which communicates with the lower air vessel H; when the rod rises, the opposite valve at the top will open, and the water

will be forced through into the air vessel E, and the supply for the descending stroke will rush in by the bottom valve from F, and, as before, be discharged through G.

For the proportions of this kind of engine (see art. 414—423). I would recommend the adoption of Field's valve instead of the throttle valve. See art. 547.

PLATE XIV.

This plate represents a double acting steam engine, for impelling machinery, as executed by Messrs. Fenton, Murray, and Co., of Leeds.

The engine is supported by the walls A A A A, part of which form the walls of the engine house. The steam cylinder B is secured to the wall below it by bolts; it is enclosed in a jacket or casing of cast iron, a little larger than the cylinder, and the space between them is supplied with steam, to keep the temperature of the cylinder as near to the temperature of the steam as possible. (See art. 155.) The steam comes from the boiler by the steam pipe C C, to the valve pipe D D, and passes to the condenser by the eduction pipe E E, leading to the condenser F, which with the air pump G is immersed in the cold water cistern H, supplied through the pipe J. The cold water pump I is worked by the rod O attached to the engine beam. The air pump is worked by the rod N, and delivers the water into the hot well, from whence the hot water pump K, worked by the rod P, the upper part of which is connected with the working beam at Q, raises a quantity of hot water to supply the boiler.

The working beam Q is supported by the cast iron column R, and is connected to the piston rod L by the parallel motion M M (see art. 188); the other end of the beam gives a rotary motion to the crank shaft by means of the connecting rod S, the lower part of which is attached to the crank T; and a spur wheel U on the crank shaft, working into a pinion on the shaft V, gives motion to it, and to the fly wheel W, (see art. 540.) By means of a train of shafts and beveled wheels X Y Z, moved by the crank shaft, the axis, carrying the eccentric rollers which move the valves, is kept in motion, and the rods *a b*, which are connected to the valves, are raised and depressed at the proper times, or by hand by the lever *e*, in the manner more fully described in Plate VIII. In some of their engines they use slides nearly of the kind mentioned in art. 447. The injection of cold

water to the condenser is regulated by a cock, moved by the handle *c* on the spindle *d*.

The governor *g* (see art. 550.) is kept in motion by bands from the crank shaft, and opens or closes the throttle valve in the steam pipe C by means of a lever *h h*. See Plate VIII. Fig. 1.

The proportion of the parts for a double engine of this kind may be ascertained by art. 414—423. It ought to be made to work expansively, but in this case it has not been done: the saving resulting from causing the engine to work expansively, will be in the ratio of about 10 to 7 to do the same work, (art. 422.) See Table III. art. 664.

PLATE XV.

As an example of a portable condensing engine for impelling machinery, I have taken that of Mr. Maudslay, where the beam is omitted, and the crank connected directly with the piston rod. Fig. 1. is a front elevation of an engine; Fig. 2. a longitudinal section; and Fig. 3. an end view. The cylinder B is supported by a cast iron frame A, and C is the piston, with the rod D, connected to a cross head at E, and guided by the wheel F, which keeps the piston rod in a vertical direction, by moving in the frame G; the side rods H H connect the cross head E with the double crank I I, which turns in the plummer blocks or bearings J J, one on each side of the frame, and to which the fly wheel shaft K, carrying a fly wheel M, is connected by a coupling box, or clutch L, at the end next the engine.

Two eccentric wheels N N, on the crank shaft K, give motion to the levers O and T, by means of the connecting rods P P. The lever O, supported by the bearing Q, works the cold water pump S, by the rod R; while the beam T, working on the centre V, works the air pump X by the slings *v*, and the hot water pump Y; which by the feed pipe Z supplies the boiler with hot water. On the cross rail (*a*) the guide is fixed to confine the air pump rod to a vertical motion; the condenser *b* surrounds the air pump, and is again surrounded by one of the cold water cisterns *c*; the two cisterns are connected by a pipe *d*: the steam from the cylinder passes to the condenser through the eduction pipe *e*, and the cold water for injection is admitted to the condenser by the cock *f*. The air and condensed steam ascends through the foot valve *g* in the bottom into the air pump.

The mechanism for opening and closing the steam passages consists of an eccentric piece *k*, fixed on the crank shaft, the action of which communicates a reciprocating motion to the rod *i*, which by a bent lever moves the connecting rod *l*, and lever *m*, that is fixed at one extremity of a spindle having a beveled wheel at the other ; which works into another on the spindle *n* of the steam cock *o*, by which the steam is admitted from the steam pipe to the cylinder. The engine is worked by hand by means of the handle *h*.

A pair of beveled wheels on the fly wheel shaft gives motion to the governor balls, and these raise or depress the piece marked *p* on the axis, which by its peculiar form acts on a lever, and retains the valve in the steam pipe at *q* open for a longer or shorter time for the admission of steam according to the velocity of the engine, (see art. 547.) There is also an apparatus for working the throttle valve by the same governor.

This engine is in a very compact form : it is however a little too complex, and its frame reminds one of an antiquated style of cabinet-work ; but the beauty of the workmanship is unequalled, and is faithfully represented by Mr. Clement's drawings.

To proportion the parts of an engine of this kind, see art. 419—422. and the articles there referred to ; and Table III. (art. 664.) It is adapted for engines of from 2 to 30 horse power.

PLATE XVI.

Fig. 1. and 2. represent the instrument called the indicator, for measuring the force of the steam in the cylinder of an engine. See art. 560.

Fig. 3. and 4. are diagrams to illustrate the comparative stability of opposite classes of forms for vessels. See art. 599, 600.

Fig. 5. If the motion of a vessel were always direct, its sides should be parallel, and one of the section Fig. 3. may be terminated by making both the extremities of the same figure, and formed by circular arcs; then if the section be similar, so that the stability may be equal throughout the length, (art. 599.) the water lines will increase in curvature towards the keel (they are shown by dotted lines); but the actual obliquity of the resisting surface, by which these resistances are measured, decreases in descending. The objection I should make to this mode of forming a vessel is, that it would not have a sufficient tendency to keep in its course; and I think a better form would be obtained by conceiving the midship section to advance parallel to itself, and also towards the keel, in the same manner as is shown in the next figure.

Fig. 6. If the section Fig. 4. be the midship section, and the plan of the load-water line be formed by arcs of circles, and the sections be all drawn by the same mould as the midship section, as far as the breadth at the part allows, then the form will be as Fig. 6.; the water lines would be all of the same curvature, the capacity would be easily measured, and the construction would be simple.

But it is necessary to remark, that parallel sides are best only for direct motion. In an oblique motion, such as that almost universally produced by wind, the vessel should diminish towards the stern; the oblique force of the wind then presses its side against the fluid so as to produce an effect similar to that of an inclined plane, if the sails be properly set, and I think the diminution should commence where the curvature of the fore-part ends.

It is chiefly for direct motion that a steam vessel is intended, and where it is so, parallel sides have the advantage; but where sails are to be used with effect in addition to steam power, the direct resistance must be a little increased, or the capacity diminished, to get a clean run when the oblique force of the wind is available. Hence, it appears that a vessel adapted for one mode of action is not the best for another; and instead of theory being imperfect, it is evident that it only wants to be followed up by analysing the different cases which occur in practice. It is difficult to conceive how much this subject has been neglected, or how much remains to be done.

PLATE XVII.

Fig. 1. is a section of a steam vessel with its boiler in two parts ; the right part is shown in a section across it through one fire-place F, and its flues N, P ; and through the cross flue L of the other fire-place, and through the safety valve U (art. 263.); showing the dampers O, R, and the passages of the flues to the chimney. Of the left part the fire-door end is shown with the fire-doors D D, the handles for clearing the clinkers B B, the doors for cleaning the flues at E E E, and the gauge cocks G ; also part of the chimney C, the steam pipe S, and a slide valve V, to shut off the steam from the engine. There should be as much space between the boiler and the sides of the vessel, as to admit a person to go round to examine it. The floor under the boiler should be rendered as strong as possible, and the boiler should rest on a plate of iron bedded on a layer of bricks or tiles laid over the floor in cement ; in this manner a thin plate of wrought iron extending under the whole, being flexible, and brick a slow conductor of heat, is more secure than a much thicker cast-iron plate.

Fig. 2. is a plan, showing the arrangement of the two fire-places F F, and their flues. The fire-door is at D, the fire on the grate F, the clinkers fall at H, and the smoke turns at L and returns along the flue N, rises at O, and goes back along a flue P over N. The boilers should be strengthened by internal frames disposed in triangles, and so as to afford supports for the flues.

Fig. 3. is a longitudinal section through the boiler, and one of the fire-places :¹ the same letters refer to the same parts in all the figures ; see art. 239—244. : for the fire and flue surface, art. 204. ; for the capacity, art. 215—220. ; for the area of the chimney, art. 278. ; for safety valves, art. 259—272. ; for the strength of boilers, art. 525. ; and for the management of sea water, art. 565.

¹ In this last figure there is scarcely sufficient space allowed for the action of the slide valve V.

PLATE XVIII.

To Boulton and Watt steam navigation is indebted for the effective method of working two engines jointly, giving, with other advantages, a more equable motion to the paddle wheel, and, in the event of accident to one of them, enabling the vessel to proceed with the other at about two-thirds of her greatest velocity.

This plate is an isometrical projection¹ of a steam boat engine, in the manner they were first arranged by Messrs. Boulton and Watt; and nearly the same general principle of construction is followed by all the best manufacturers. Two small engines connected in this way were adapted to the 'Prince of Orange' and 'Princess Charlotte,' on the Clyde, by these gentlemen, in 1814. Previous to this, it had been the practice to employ only one engine, ranged by the side of the boiler, having a fly wheel on the paddle axis to assist the engine in passing its centres; and in such case the occurrence of any accident immediately put an end to the progress of the vessel by steam.

The steam comes from the boiler by the pipe in the front of the figure, and passes into the steam case and round the cylinder to the slide box, (see art. 146.); from whence it is let into the cylinder in a manner which will be more clearly understood by referring to the next plate: from the lower part of the cylinder a trunk proceeds to the condenser, which is below a square cistern; beyond which a part of the air pump is seen, and to the left of it the hot water pump to supply the boiler.

The motion of the parts commences at the cylinder: the piston rod is supposed to be descending, and by means of a cross bar (called a cross head) and two side rods, it depresses the ends of the side beams, these side beams moving on axes in the centre; the other ends rise and force a cross bar upwards, to the middle of which the connecting rod is fixed, by which the crank of the paddle wheel shaft at the upper part of the figure is turned; and also by the rising of the further end of the side beams, the cross head of the air pump and hot water pump is raised by two side rods. The motion of the piston rod is guided by a combination of rods called the parallel motion, (see art. 495.) and the slide is moved by an eccentric

¹ Some account of this simple and useful mode of drawing, which was invented by Professor Farish, is given in Dr. Gregory's 'Mathematics for Practical Men.'

wheel on the crank shaft ; and to reduce the friction its weight would cause, it is balanced by a heavy ball acting on a lever below it.

Though the figures on the next plate are not a plan and section of this engine, yet the same parts, with the exception of the steam pipe, are nearly in the same places ; and hence, by comparison of the two, the uses and action of the parts may be understood.

The weight of an engine of this kind is not exactly proportional to its power ; but is nearly so ; and that of a forty horse power engine, with proper duplicate parts, water, and other appendages, is about 100 tons. See Section x.

PLATE XIX.

In this plate, Fig. 1. is a section, and Fig. 2. a plan, of a steam boat engine. A strong frame of cast iron supports the crank shaft I, and connects the parts of the engine; and the whole is sustained by two strong beams on the floor. The steam pipe S brings the steam from the boiler to the passages of the slide, and from thence to the top or bottom of the cylinder A, and it passes from the slide to the condenser B, where it is condensed by a rose jet playing constantly; the air pump C expels the air and water into the cistern D, from whence it runs out by a pipe. The motion of the piston is transmitted to the crank by means of the double side beams or levers E F, moving on the axis G; these are connected to the cross head of the piston L L by two rods called the side rods, and the ends E are connected to the crank by the connecting rod H. The air pump is also worked by side rods from the side beams, and the hot water pump from the same cross head. The parallel motion is guided by the radius rod M N; see art. 489.: the vibration of the beam is not bisected; see page 233, note. The slide is on Murdoch's construction, (art. 447.) and is moved by a wheel on the crank shaft I, with a sliding frame P, (art. 481.) and by hand by the lever T; the slide rod being moved by slings from the arm R. The valve O is used to let steam into the condenser in setting the engine to work, and the air and water are blown out at the discharge valve into the cistern D.

For the strength of the parts, see art. 496.; the proportions of the engine, art. 419—422. The parts of the slide should be counterbalanced, in order that its resistance may be equal in either direction.

Each vessel generally has two of these engines, placed parallel to one another, with a passage between them; and there is room left for working the fires between the cylinder and the boilers. The coals should be kept in iron tanks in the engine-room, each to hold a given weight of coal, with the object of ascertaining with accuracy the consumption for any time; about four tons is a sufficient quantity to be together, and they should be kept out of the danger of taking fire.

The proportion of the power to the effect is given in Sect. x. art. 655.

PLATE XX.

Fig. 1. represents a side elevation of a steam carriage, and Fig. 2. part of a cross section to double the scale :¹ the same letters refer to the same parts in both. The steam is generated in a cylindrical boiler A, and the fire and flues surround it ; it is joined to two cylinders H H, of the same diameter, intended as reservoirs for steam, and in these are inserted the engine cylinders G G' : the parts I I form a reservoir of water not exposed to the pressure of the steam, but surrounding the flues and chimney so as to be heated ready for injection into the boiler A by a small force pump.

In order to distribute the heat of the fuel so as to render it effective on a larger surface, there are two fire-places, with fire-doors at B B', but fed with coals by hoppers from the boxes D D' ; the doors are used only to clear the bars, and should be kept open as little as possible. The fire-flues meet at the middle : the one from the fire B' rises at F', (Fig. 2.) passes along on the upper surface of the cylinder A, round H at M, also round the end of the boiler, and returns on the opposite side, to ascend the chimney in the division E' ; the other proceeds in the same manner in the opposite direction, and ascends at E. There are two apertures for air C C, to each ash-pit, both of which should be provided with registers, so that those may be open which either face a strong wind, or (in ordinary cases) those which face the direction of the motion of the carriage. For a like reason the top of the chimney E should have two apertures, that the motion of the air, or the motion in the air, may assist the draught.

The engine and boiler are supported by a frame, and this is supported by the axis ; but to prevent the carriage resting on three wheels, there may be four spiral springs in the boxes L L, and the cross heads must be connected to the piston rods by moveable joints, and all the bearings must be formed so as to admit of the motion which would take place by the sinking of one of the wheels in a certain degree. The waste steam passes from the slides to the chimney by the pipes K ; and there should be two safety valves, one locked in a box at J, the other open for the use of the engine-man at J'. See art. 266—273.

¹ This drawing is, through some oversight, not accurately double in all its parts ; and in the parallel motion of Fig. 1. the vibration of the beam is not bisected ; see page 233, note.

There will, I think, be some advantage in making the pistons act together, because the effect will be as great as by dividing it, supposing both methods to be perfect ; and in acting together, there would be less interference of the motion of the one with that of the other. The slide would be best moved from curved teeth on the beams. See art. 481.

For the proportions and construction of the boiler, see art. 244, 227, 278, and 522—526 ; for the engines, see art. 271—380 ; and for the power required, see art. 590.



PLATE XXI.

This plate, which represents Kingston's valves, is given by Mr. Dinnen as connected with the subject of his valuable paper in the Appendix on steam boilers, and the following is his description, &c.

I. BLOW-OFF VALVES.

- a*, Gun-metal pipe with conical base, passing through the ship's bottom, with the conical part outwards and made even with the same. Inboard, the cover of the pipe (forming the gland or stuffing box and the nozzle which joins to the stop-cock of the blow-off pipe) is screwed on the upper end of the pipe, down to the ship's floor, on to a chock of wood fitted thereon as requisite, in the manner of a screwed bolt and nut.
- b*, The valve, fitted within the cone of the pipe and opening outwards, having a copper rod which passes through a stuffing box in the cover. A guard protects the valve beneath.
- c*, Cover, which is screwed tightly on the pipe.
- d*, Gland or stuffing box.
- e*, Handle for lifting the valve.
- f*, Nozzle, with a flanch for connecting the valve with the stop-cock of the blow-off pipe.
- g*, Guard, extending across the base of the pipe, and having no guide spindle passing through it; for the object of allowing the valve to be pressed entirely on one side, thereby affording a more ready passage to any matters intruding into the pipe from the boilers.
- x*, Planking of the ship's bottom.
- m*, Timbers of the ship's floor.
- n*, Chock, fitted on the timbers to accommodate the required length of the pipe.

II. INJECTION VALVES.

- a'*, Gun-metal pipe, passing through the ship's bottom.
- b'*, The valve, having a guide spindle below.

- c'*, Cover, screwed on the pipe.
d', Gland, or stuffing box.
e', Handle of the valve.
f', Nozle with flanch for connecting the valve with the stop-cock of the injection pipe.
g', Guard, so constructed as to form a grating, in order to prevent weeds or other substances from being admitted into the condensers ; and having a socket rising from the centre, through which the lower spindle of the valve passes.
h h', Two copper standards, screwed into the cover, having mortices or key ways through them, which coincide in direction with a corresponding one in the rod; and are so adjusted, that when the valve is completely open, a key passing through them maintains the valve in its place, and thereby prevents its being closed by the pressure of the water without rushing in to fill up the void in the condensers.
i, Key, or cutter, for fixing the valve as above.
m, Ship's timbers.
x', Planking of the ship's bottom.

III. HAND-PUMP VALVES.

These are the same as the Injection, with the exception of the grating.

MANNER OF FIXING THE VALVES IN THEIR PLACES.

The situation of the pipes being fixed, a close jacket of fearnought, well covered on both sides with a mixture of white and red lead, is sewn on from the base to the lower part of the screw, and a corresponding hole is formed in the ship's bottom.

Then the pipe, being *set* up in its place by shores, is firmly screwed up by the cover, and the space between the cone and a corresponding flanch of copper sheathing (extending two or three inches up between the planking and the cone, to protect the former from the attacks of the worm) is well caulked ; this done, a copper screw is fitted through the lower part of the cone, into the wood, to prevent the possibility of the pipe turning or heaving the cover on or off.

The cover is now taken off, and the space around the upper part of the pipe is caulked ; then it is finally replaced and screwed down on a copper washer of about $\frac{1}{8}$ inch in thickness.

The chocks are well coated on their under sides with red and white lead.

PLATE XXII.

BOILERS OF H.M. STEAM VESSEL "AFRICAN."

See the description of the next plate.

PLATE XXIII.

BOILERS OF H.M. STEAM FRIGATE "MEDEA."

This and the preceding plate are also furnished by Mr. Dinnen in connexion with his paper in the Appendix on steam boilers. The following is his description.

(The same letters refer to corresponding parts in the several views.)

- a*, Furnaces.
- a'*, Grate bars.
- a''*, Bearer bars.
- b*, Ash pits.
- c*, Bridges.
- d*, Flues.
- e*, Smoke-joints, } for connecting the fore with the after boilers.
- e'*, Steam-joints, }
- f*, Uptake, through which the smoke, &c., passes from the flues to the chimney.
- g*, Chimney.
- h*, Air casing, which surrounds the base of the chimney to prevent too great a transmission of heat to the deck, or other materials liable to be injured thereby.
- i*, Dampers with their levers, for checking the draught of the furnaces.
- j*, Water ways between the flues and fireplaces.
- j'*, Water ways of the bridges, and beneath the flues and fire-places, such that one may enter at the mud hole doors, forward and aft, and pass over the entire bottoms of the boilers, and under the flues.
- k*, Mud hole doors, with a similar one on each after boiler.
- l*, Furnace doors.
- m*, Clinker bars, for supporting the levers employed in clearing the furnace bars.
- n*, Feed pipe, with two branches and valve boxes, for supplying the boilers with water.

- o*, Floats, with indexes, for shewing the height of the water in the boilers.
- p*, Glass water-gauges, through which the exact height of the water is seen.
- q*, Gauge cocks, below which the water is never supposed to descend.
- r*, Steam chests.
- s*, Safety valve box, containing the two safety valves, with the waste steam pipe rising from the same.
- s'*, Waste steam pipe.
- t*, Pipes for conveying the water overboard from the safety valve box, and likewise that resulting from the condensation of the steam in the globe, or other contrivance at the head of the waste steam pipe.
- u*, Safety valve levers:—accessible at the front of the boilers, the safety valves being lifted by other levers fitted to the same axes, within the steam chest.
- v*, Man holes, with their covers in place.
- w*, Communication valves, having screwed spindles, which are acted on from above by two levers, for the purpose of shutting off either boiler from the main steam pipe.
- x*, Main steam pipe.
- y*, Reverse valves, to prevent the boilers collapsing by the pressure of the atmosphere, which, in case of a vacuum being formed, presses the valves inwards to restore the equilibrium.
- z*, Vacuum pumps, the rods of which are attached to levers on deck, by working which, on charging the boilers with water from the sea, an exhaustion is effected which causes the water to rise within, from the pressure of the atmosphere without, and thus saves the labour of forcing many tons of water into them. The time occupied in fully charging the boilers of the “Medea” by these pumps was usually from fifteen to twenty minutes.
- z'*, Blow-off pipes, with a nozzle to each boiler.

The same description applies generally to Plate XXII. of the African's boilers, which are fitted with precisely similar appendages, with the exception of the vacuum pumps.

PLATE XXIV.

MORGAN'S PADDLE WHEEL AND SEAWARD'S PADDLE WHEEL.

This plate relates to Mr. Barlow's paper on "Paddle wheels" given in the Appendix, page 40, and a description of the drawings is to be found at pages 41 and 42.

PLATE XXV.

POSITIONS OF A FLOAT OF A RADIATING PADDLE WHEEL, AND ALSO OF A VERTICALLY ACTING WHEEL, IN A VESSEL IN MOTION.

This plate relates to Mr. Barlow's paper on paddle wheels, and is described by him at pages 45 and 49 of the Appendix.

PLATE XXVI.

CYCLOIDAL PADDLE WHEEL FITTED TO THE "GREAT WESTERN" STEAM VESSEL, WITH ANOTHER DRAWING REPRESENTING THE POSITIONS OF ONE OF THE FLOATS.

This plate likewise relates to Mr. Barlow's valuable paper in the Appendix, where it is described by him at page 53.

PLATES XXVII. AND XXVIII.

These plates are designed to illustrate Capt. Oliver's paper on the supposed advantages of sail on large SEA-GOING steam vessels under various circumstances of unfavourable winds. Plate XXVII. represents a scale of different courses from the Cape of Good Hope to the Isle of France, with the several distances marked, and Plate XXVIII. represents four drawings of her Majesty's steam ship Phoenix, in different positions with respect to the wind.

 PLATE XXIX.

This plate exhibits the various situations of a trial at sailing of her Majesty's steam ship of war Medea with the Caledonia, Vanguard, and Asia. For particulars see the end of Lieut. Baldock's excellent Memoir of the Medea, Appendix, page 100.

 PLATE XXX.

In 1816 a vessel (Caledonia) was purchased by Messrs. Boulton and Watt, and fitted with two engines of fourteen horses' power, solely for the purpose of making experiments under various circumstances and modifications of paddle wheels. One of these experiments embraced the ascension of the Rhine in the winter of 1817 as high as Coblenz.

The plate represents a side view of the engines manufactured by Boulton and Watt for the Red Rover and City of Canterbury steam vessels. This form of marine engine adopted by them about this period, say 1817, was fitted on board the Favourite in April 1818, and, with the exception of some slight improvements principally made by themselves, it still remains unchanged.

In the first edition of this work it was stated in mistake, that they had adopted it from the Clyde. This is incorrect, and we take the present opportunity of stating that this mode of construction is due to Boulton and Watt, and that a preference has been given to the arrangement by several of the best makers who have followed it.

PLATE XXXI.

This plate is a longitudinal section of the preceding engine with boiler attached, and the same reference letters apply to both.

The engines and boiler stand on sleepers of oak X X, African oak from its stiffness being generally employed. And the base of the engine is secured by bolts passing through the sleepers and bottom timbers¹. The steam pipe S brings the steam from the boiler to the space between the slides, *c*, and by their movement admits it to top and bottom of cylinder A. At the termination of each stroke it passes to the condenser B, by the upper and lower eduction pipes, C and D, and is there condensed by a jet of cold water. The air pump E, withdraws the air and water, from the condenser to the hot-water cistern F, which being close at the top forms an air vessel to expel the water from the cistern through the waste water stop-valve pipe G.

The motion of the piston rod is transmitted to the crank by means of the main levers H, I, moving on the main gudgeon K. These are connected at the cylinder and to the cross bar of the piston by two side rods L L, and the other end, I I, to the crank by the connecting rod M.

The air pump E is also worked by two side rods from the main levers, and the hot water and bilge pumps from the same air-pump cross bar N.

The piston rod is guided by a parallel motion *a a*, the slides *b b* are separate, but connected by a rod similar to their land construction of 1808. These and the upper eduction pipe have been lately applied by Boulton and Watt, and may be considered a great improvement upon the long slide, where the expansion of the metal is liable to twist the face and render them leaky.

Motion is given to the slide valves by the eccentric circle O, by means of the eccentric rod *d*, connected with the eccentric arm *e*, from which it may be disengaged with facility when the engines are required to be stopped; *f*, the working gear shaft, receiving its action from the eccentric arm.

P P, Upper and lower blow valves, the former is used before starting the engines to admit steam into the condenser to blow out the air and water by the lower valve, so as to form a partial vacuum in the condenser.

Q and R, Upper and lower headstock frames which support the engine and paddle

¹ It may not be irrelevant to notice here, that owing to this mode of securing the engines the proprietors of the Red Rover were recently enabled to raise that vessel when sunk in forty feet water. The principal chain which lifted her being secured to the frames of the engines, it having given way when fastened to the vessel itself. It is the practice of some makers to bolt only through the sleepers, which we by no means consider so secure.

shaft connected with the hot water cistern and cylinder casing, the ribs or webs of which are disposed in the direction of the strain : there are many more fanciful and pleasing forms, but certainly none so mechanical or so well adapted to the purpose. T, Injection pipe through side of vessel,—*g*, bilge injection.—To be used in the event of the vessel leaking to any extent, in which case the river injection would be shut off, and the bilge one opened. This is an appendage which has till lately been overlooked by other makers, but a very necessary one, as by such means about four gallons per horse power per minute might be withdrawn by injecting from the vessel.

U is a longitudinal section of the boiler ; V, the grate ; and W, the flues ; *y*, safety valves enclosed in safety pipe, and perfectly inaccessible to the engine-man for the purpose of applying extra weight to endanger the boiler. This description of valve was used by them as far back as 1814, in a vessel fitted on the Tyne, consequently three years previous to the examination before the Committee of the House of Commons for some such precaution. *h h*, Blow-out pipes and cocks ; *i i i*, feed pipes ; *k k*, &c., hold-down bolts, occasionally cased with brass to prevent corrosion.

PLATE XXXII.

This plate represents, with similar reference letters, a transverse section of the same splendid steamers, the Red Rover and City of Canterbury, shewing on the left the cylinder, and on the right the crank end of the engine, with the paddle wheels, main beams for support of paddles, stays, &c., &c.

PLATE XXXIII.

SIDE ELEVATION OF THE ENGINE OF THE NILE STEAM SHIP.

<i>a</i> , Boiler.	<i>u</i> , Hot water cistern.
<i>b b b b</i> , Flues.	<i>v</i> , Condenser.
<i>c</i> , Fire place.	<i>w</i> , Air pump.
<i>d</i> , Steam box.	<i>x</i> , Air pump side rod.
<i>e e</i> , Blowing-off valve and pipe.	<i>y y</i> , Feed pump and rod.
<i>f</i> , Air case.	<i>z</i> , Connecting rod.
<i>g g</i> , Man holes.	A, Paddle wheel shaft.
<i>h</i> , Steam pipe.	B, Crank on ditto.
<i>i</i> , Cylinder.	C, Crank on intermediate shaft.
<i>j</i> , Slide valve.	D, Drag link.
<i>k</i> , Working beam.	E, Paddle wheel.
<i>l</i> , Cylinder side rod.	FF, Suction for feed, hand pumps, and injection cock.
<i>m</i> , Motion side rod.	GGG, Blowing-out pipes.
<i>n</i> , Parallel rod.	HHHH, Feed pipes and head.
<i>o</i> , Working gear.	III, Pipe for charging boiler by hand pump.
<i>p</i> , Counterbalance.	K, Pipe and cock for washing deck.
<i>q</i> , Working gear arm.	L, Guard rod.
<i>r r</i> , Eccentric and frame.	
<i>s</i> , Gear for starting, &c.	
<i>t</i> , Reverse motion.	

PLATE XXXIV.

PLAN OF THE ENGINE OF THE NILE STEAM SHIP.

<i>a a</i> , Boilers.	<i>g g</i> , Man holes.
<i>b b b b b</i> , Flues.	<i>h</i> , Steam pipe.
<i>c c c c</i> , Fire places.	<i>i i</i> , Cylinders.
<i>d</i> , Steam box.	<i>j j</i> , Slide valves.
<i>e</i> , Blowing-off pipe.	<i>k k k k</i> , Working beams.
<i>f</i> , Air case.	<i>l l</i> , Motion cross bars.

<i>m m</i> , Cross heads to slide valves.	A, Paddle wheel shaft.
<i>n n</i> , Cross heads to cylinders.	B, Crank on ditto.
<i>o o</i> , Working gear.	C, Crank on intermediate shaft.
<i>p p</i> , Counterbalance.	D, Drag link.
<i>q</i> , Working gear arm.	E, Paddle wheel.
<i>r r</i> , Eccentric frame and rod.	F F F, Suction for feed, hand pumps, and injection cocks.
<i>s</i> , Gear for starting, &c.	G G, Hand pumps.
<i>t</i> , Reverse motion.	H H, Injection pipes.
<i>u u</i> , Hot water cisterns.	I I I I, Pipes for charging boilers by hand pumps.
<i>v v</i> , Air pump cross heads.	K K, Blowing-out pipes.
<i>w w</i> , Air pumps.	L L L L, Feed pipes.
<i>x x</i> , Blow valves.	M M M M, Guard rods.
<i>y y</i> , Injection cocks.	
<i>z</i> , Connecting rod.	

PLATES XXXV. AND XXXVI.

CROSS SECTIONS OF THE ENGINE OF THE NILE STEAM SHIP.

<i>a a</i> , Boilers.	<i>s s</i> , Side rods to cylinder.
<i>b b b b</i> , Flues.	<i>t</i> , Cross head to air pump.
<i>c c c c</i> , Fire places.	<i>u u</i> , Side rods to air pump.
<i>d</i> , Steam box.	<i>v</i> , Connecting rod bar.
<i>e</i> , Blowing-off valve and pipe.	<i>w w</i> , Short links.
<i>f</i> , Air case.	<i>x</i> , Connecting rod.
<i>g g</i> , Man holes.	<i>g</i> , Paddle wheel shaft.
<i>h</i> , Steam pipe.	<i>z</i> , Crank on ditto.
<i>i i</i> , Feed pipe and head.	A, Drag link.
<i>j</i> , Waste water pipe.	B, Crank on intermediate shaft.
<i>k k k k k k</i> , Blowing-out pipes.	<i>c c</i> , Plumber blocks.
<i>l l l</i> , Gauge cocks.	D, Paddle wheel.
<i>m</i> , Cylinder cross head.	E E, Suction pipes, to feed hand pumps, and injection cocks.
<i>n</i> , Motion cross bar.	F F, Pipes for charging boilers by hand pumps.
<i>o o</i> , Side rods to slide valve.	G G, Pipes for washing deck.
<i>p</i> , Cross head to slide valve.	H H, Air pumps.
<i>q</i> , Working gear.	
<i>r</i> , Working gear arm.	

I I, Blow valves.
 K K, Hot water cistern.
 L L, Feed pumps, dotted.

M, Condenser.
 N, Handle of injection cock.
 oooo, Holding down bolts, dotted.

PLATES XXXVII., XXXVIII., AND XXXIX.

ENGINES OF HER MAJESTY'S STEAM FRIGATE PHŒNIX.

These three plates represent a plan, side elevation, and transverse section of the steam engine of her Majesty's steam frigate Phœnix; they also describe the engines of the Medea, Rhadamanthe, and Salamander, the machinery of these four vessels being identical, and all manufactured by Messrs. Maudslay, Sons, and Field. Plate XXIII. gives a more detailed representation of the boilers of these vessels, and may be referred to for additional information.

The general arrangement of these engines is on the ordinary side beam construction; all the working part, except the beam, of wrought iron; metallic piston; and the crank pins are so arranged that the wheels may be readily disconnected for sailing.

The boilers are of iron, in two independent parts, and furnished with valves so contrived that they may be used either separately or both together.

The wheels are of the ordinary construction, except those of the Medea, which are Morgan's; some of the others have had cycloidal boards applied to the original wheels.

The proportions of these engines are as follows:—

The nominal power is	110 each, or 220 H. P. collectively.
Diameter of cylinder	55½ inches.
Length of stroke	5 feet.
Diameter of wheels	21 feet. 8 ft. 6 in. wide.
The Medea, Morgan's	24 feet. 5 ft. 8 in. „
Length of engine room	58 feet.

The tonnage of the Phœnix, Rhadamanthe, and Salamander is about 800 tons; that of the Medea being 807 tons. They carry two heavy traversing guns, 10 calibre, which throw an 84 pound shot; one of these guns is placed in the bow and one at the stern; below they carry four 18 pounder carronades, with provisions for 120 men. They can stow from 200 to 300 tons of coal at a draught of water of 14 feet.

The consumption of coal being 15 tons per day, they can steam from 15 to 20 days.

The scale of the drawings is ¼ of an inch to the foot.

PLATE XL.

ENGINES OF THE GRAVESEND PACKET RUBY.

This celebrated vessel, undoubtedly the fastest in Europe, and perhaps in the world, was built by Mr. Wallis, of Blackwall, near London, in the year 1836, from the designs and specifications of Mr. O. Lang, Jun., of Her Majesty's Dock Yard, Woolwich. The engines were made by Messrs. Seawards and Co., of the Canal Iron Works, near London.

The very great success of this vessel, she having beaten all competitors from the time of her starting to the present, may be attributed to two principal causes:—

First, to a most judicious arrangement in the form and construction of the vessel, by which the quantity of materials used in the building are brought so to bear upon one another that each piece performs the office assigned to it; and no more timber is used than what is requisite to give the ship the necessary strength and solidity. From the method of planking which is adopted, consisting of three thicknesses of oak placed diagonally and longitudinally, the vessel is completely trussed from end to end, and at once combines strength and lightness in an eminent manner. The length of the Ruby is 155 feet between the perpendiculars, 19 feet beam, and 9 feet 6 inches depth of hold; she will carry with ease 800 passengers. When launched she drew about two feet of water. Her after cabin is 33 feet long, and will dine 100 passengers; the ladies' cabin is about 15 feet long, and the fore cabin 33 feet.

Secondly, her superiority is attributable to her engines, which consist of two 50 horse power engines, (100 horse power the two,) in the making and fixing of which, every care was taken to have them as light and efficient as possible, without endangering their stability; and the calculation of weights and of displacement was so nicely adjusted, that when the whole of the weights were on board, and the vessel equipped for service, her real draught of water, 4 feet fore end and 4 feet 6 inches aft, was within a quarter of an inch of the builder's estimate. The weight of the engines complete with the water in the boiler is exactly 90 tons 5 cwt., being about 18 cwt. to the horse power; the diameter of the cylinder is 40 inches, length of stroke 3 feet 6 inches, diameter of outer edge of paddle wheel 17 feet, and length of board 9 feet 2 inches, with a dip of 17 inches with 200 passengers on board; then the speed of the engines is 30 strokes per minute, the pressure of the steam being only $3\frac{1}{2}$ lbs. above the atmosphere. The speed of the piston is therefore 210 feet per minute, the speed of the outer edge of the paddle board is nearly 20 miles per hour, and the speed of the vessel through still water by repeated trials is exactly $13\frac{1}{2}$ miles per hour.

It is a remarkable fact, that from the first day of trial up to the present time, this boat has not varied her speed $\frac{1}{2}$ th of a mile per hour; she has neither increased nor lost her speed. This is mostly to be attributed to the fact of the engines being in a most perfect state when set to work, but more particularly to the use of the patent slide valves on board of this vessel, and which after two years' working have been found as perfect upon their faces as when first put together; a further proof of their superior working is evinced by the vacuum in the condensers of the engines having never varied $\frac{1}{4}$ th of an inch, remaining constantly between $28\frac{1}{4}$ and $28\frac{1}{2}$. This is ascertained by barometers attached to each engine, which are not affected by the atmosphere and makes the vacuum as perfect as possible, for supposing the waste water as it leaves the condenser to have a temperature of 110° , which is equal to $1\frac{1}{2}$ inch of mercury, (see Professor Robinson's experiments,) when added to $28\frac{1}{4}$ it gives $29\frac{3}{4}$, the usual height of the marine barometer in fine weather.

The safety valves are arranged upon the plan invented and used by Messrs. Boulton and Watt a long time since, and now generally adopted by the engineers of London. They are so arranged that no one on board can possibly have access to them; the engine man can at pleasure open them and let the steam escape, but he has no means by which he can keep them down, beyond the weight placed upon them by the engine maker, which weight is, as before stated, $3\frac{1}{2}$ lbs. on the inch; and it is a curious fact, that this boat has attained the great speed named, with this small pressure, while in a variety of instances vessels from different outports, working with high pressure steam, and with the safety valves loaded *ad libitum* by the engineers and captains, have never been able to approach her in speed. This clearly proves, what the late Mr. Watt demonstrated long ago, that the most efficient, safe, and economical mode of working steam engines for marine purposes is at a pressure of from $2\frac{1}{2}$ to $3\frac{1}{2}$ lbs. on the inch. At the same time, for single acting pumping engines there is no doubt an advantage gained by the judicious use of high pressure steam, say of 30 lbs. on the inch, working expansively, with boilers properly constructed, but which boilers for many reasons are not at all fit for steam vessels; in fact, almost all the melancholy accidents that have lately occurred to steam boats by the explosion of their boilers, have been caused by the injudicious application of high pressure boilers to marine purposes.

It is here worthy of remark, that the Americans, who claim to propel their vessels at the high speeds of 15, 16, and in some cases 18 miles per hour, (which, by the by, has been amply contradicted in this work by an able American writer, who states the greatest speed through still water attained by the best American steamers, he believes to be in one instance 14 miles per hour, but that the rest of the New York boats do not come up to this,) state that the principal cause of their

alleged triumphs is owing to the use of high pressure steam, used expansively; the causing the pistons of very long stroke engines to move at the rate of 300, 400, and sometimes 600 feet per minute; and lastly, to the superior form of the bows of their steamers, which are built so as to glide over the water instead of cutting through it.

In the case of the Ruby, in all these important matters she is decidedly the reverse of the Americans; the piston only travels about 210 feet per minute, very low pressure steam is used, the stroke of the engines is very short, being only two inches more than the diameter of the cylinder, and the form of the bow is decidedly that which will cut or divide the water without the least tendency to ride over it, inasmuch as this vessel's bow is shaped like a knife, being as long on the keel as at the water's edge within two feet.

Judging from these facts, it will be seen that high pressure steam, length of stroke, and prow-shaped bows, qualities so loudly extolled by the Americans, are not all necessary for speed, but on the contrary, the first two are positive nuisances; the length of stroke rendering the vessel an unwieldy, ill-contrived machine, totally useless for the purposes of sea navigation, as events have proved; while the high pressure steam system has been the means of filling the journals with those ever-occurring, heart-rending, and sickening details of hundreds and thousands that are being yearly sacrificed to ignorance and prejudice, by attempting to do that by the dangerous use of high pressure steam which can be so well effected by steam of a low pressure, and that too at one half the consumption of fuel.

The limits of this paper will not permit the writer to digress upon the subject of consumption of fuel, except by stating, that in no instance has the use of high pressure steam applied to an engine for rotary purposes ever been attended with economy of fuel, but the reverse; and it is not a little singular, that in this age, even in this year, northern engineers are imitating the Americans, by the use of the long stroke and high pressure steam, in the Thames, which one would think might have been spared this pestiferous curse. The results have been, and are, that the short stroke engines are propelling the boats, both sea and river class, faster than the long stroke ones. This length of stroke has been obtained by the placing of one half the machinery upon deck, some 12 or 14 feet high, and thus making the vessel frightfully crank and most unseemly to look at, while in vessels going head to wind, it exposes some hundreds of square feet of surface to be acted upon as a back sail.

The great danger of high pressure steam will be evident to every one, when it is recollected that within the last three years, three different vessels have had dreadful explosions, viz., two on the Thames and one at Greenock, (besides some less fatal ones in different parts of the north,) by which more lives have been sacrificed to the

Moloch of high pressure steam, than has ever occurred with low pressure steam during the whole progress of steam navigation, extending now almost to a period of 40 years, and in the course of which nearly 3000 steam vessels have been fitted out and successfully worked.

REFERENCES.

<p>A, The cylinder. B B, The sway beams. C, The cross head. D, Main gudgeon. E E, The side rods. F, The fork head. G, The connecting rod. H H, The cranks. I I, The shafts. K K, The side frames. L L L, The condenser, hot well, and foundation plate, all cast in one piece. M, The air pump. N, The feed pump. O O, The sleepers. P, The crank pins.</p>	<p><i>a a</i>, The steam nozzle and valves. <i>b b</i>, The eduction nozzle and valves. <i>c</i>, The steam pipe. <i>d</i>, The throttle valve. <i>e</i>, Handle and rod of throttle valve. <i>f</i>, Starting lever. <i>g</i>, Spill of steam valve. <i>h</i>, Spill of eduction valve. <i>i i i i</i>, Levers for working the valves. <i>k</i>, Rod to connect levers. <i>l l</i>, Parallel motion. <i>m</i>, Snifting valves. <i>n</i>, Blow through valve. <i>o</i>, Eccentric rod. <i>p</i>, Eccentric beam and balance.</p>
---	---

DIMENSIONS.

Speed of the engine	30 strokes.
Diameter of wheel	17 ft. 6 in.
Diameter of the float	17 6
Diameter of cylinder	3 4
Length of stroke	3 6
Weight of engines (two)	80 tons.
Dimensions of boiler	18 feet long, 14 feet 2 inches wide, and 7 feet high.
Length of paddle board	9 ft. 2 in.
Width of board	15 inches.
Speed through still water	13½ miles.

This boat has run four times a day to and from Gravesend six months, making 48,600 miles; a feat never equalled.

Beats Red Rover	10 minutes.
Star	12 „
Mercury	27 „

Beats Vesper	10 minutes.
Diamond	12 „
Gem	5 „

Against tide from Gravesend to London—all other boats from 30 to 60 minutes.

For further information, see description of Plate XCIX.

PLATE XLI.

SECTION OF ONE OF THE ENGINES OF THE DON JUAN, PENINSULA COMPANY'S PACKET.

The Don Juan was built by Messrs. Fletcher and Fearnall, of Limehouse, in 1836. She was sailed round to Glasgow, where her engines were put in by Messrs. Claud, Girdwood, and Co., the makers. On her first return voyage from the Mediterranean to London, she unfortunately struck on the Tarifa point and went down in deep water.

PLATE XLII.

BOILERS OF HER MAJESTY'S SHIPS HERMES, SPITFIRE, AND FIREFLY.

The drawings represent a front view and sections of boilers recently constructed by the Butterly Company, who are now making a spare set to be used for any one of the three vessels which may first require them. These boilers are very compact, light, and efficient, and any two of them may be employed in case of accident to one of them, when the vessel is at sea. Each has its own steam-pipe, which can be shut off at pleasure, its safety valve, and a damper, which being closed, as shewn in the transverse section, cuts off the communication with the chimney. A contrivance is effected by which a man can creep into the boiler underneath the flues to clean or repair it, which has been found very useful; it does not increase the height of the boilers, and adds very little to their weight. The front view of the boilers is placed in a section of the Hermes, to shew "the channels" or passages by which the man has access to the under side of the flues, down between the engine sleepers or foundation timbers.

The cylinders of the Firefly are $43\frac{1}{2}$ inches in diameter, and the stroke is 4 feet 6 inches, which, at 22 revolutions per minute, gives the velocity of piston 198 feet per minute. The area of the piston in square inches is 1486.1, and if the effective pressure be 10 lbs. per square inch, it would make the horses' power $\frac{14861 \times 198}{33000} = 89.2$

horses' power. But the speed of the piston is taken at 185 feet, large allowances are made which the present improved state of workmanship perhaps renders unnecessary, and the engines are estimated at $2 \times 70 = 140$ horses' power. Probably for a sea-going vessel, where the engines often cannot work at their proper speed, we are right in so doing.

PLATES XLIII., XLIV., XLV., AND XLVI.

The drawings in these plates shew an elevation, plan, and two sections of the engine room of those armed Russian steam ships Jason and Colchis, lately built by Messrs. Fletcher and Fearnall, of Limehouse, and fitted with engines by the Butterly Company for the Imperial Government, under the direction of Mr. Glynn. It has been thought unnecessary to give a drawing of the boilers, as they are similar to those made for our own government, and differ only in dimensions. The difference of dimensions is shewn in the general drawing, the internal construction being the same as shewn in the boilers of her Majesty's steamers Hermes, Firefly, and Spitfire, Plate XLII. The Jason and the Colchis are, it may be said, sister ships, but the Colchis being the last built, some slight alterations were made by the constructor, Mr. Fearnall, and the Colchis was his last work as it was his best. This celebrated shipwright died on the 23d of October, 1837; and for the construction of steam ships he had no superior. The vessels being expressly designed for the Black Sea, and this being a shallow sea, carried ten days' fuel, and with all their stores and equipments drew only 9 feet 6 inches water; yet with only 2×60 horse power engines they were propelled through the water at the rate of 10 nautical miles (or about $11\frac{1}{2}$ statute miles) per hour. They each carry one long heavy gun (a 32 pounder) in midships on the quarter deck, besides two bow guns for chasing a flying enemy; also 32 pounders, and smaller guns for signals and salutes. They lie very low on the water, and as war steamers, are formidable antagonists, whilst their capabilities as sea boats have been put to severe trials in the Bay of Biscay in heavy gales of wind.

PLATES XLVII. AND XLVIII.

SAMUEL HALL'S IMPROVEMENTS ON STEAM ENGINES.

Some very important improvements have been made on the steam engine by Mr. Samuel Hall, of Basford, near Nottingham, for which he has obtained letters patent. The principal objects of these improvements are to supply the boilers with pure distilled water (thereby increasing their duration,) to effect an economy of fuel, and to produce an increase of power. These objects, it is stated, are obtained by condensing the steam by the external application of cold water, instead of injecting it into the steam. The improvements have been in successful operation for upwards of four years, having been applied to several land engines and to a considerable number of marine engines, varying from 70 to 320 horse power each pair, and there is every probability that they will generally supersede injection engines. As Mr. Watt attempted to condense steam without injecting cold water into it, and came to the conclusion that it was impossible to effect a sufficiently rapid condensation of steam, for steam engines worked by vacuum, by means of the external application of cold water, and as many other persons have also failed in similar trials, it is desirable to ascertain the means adopted by Mr. Hall, and for this purpose we give the following extract from the specification of his patent, shewing wherein his invention consists, and the causes of his succeeding in obtaining a desideratum which others have attempted without success.

EXTRACTS FROM THE SPECIFICATION.

“ The objects of my invention (which invention I confine to steam engines worked by a vacuum produced by condensation) are to condense without injection water (for the purpose of creating as good a vacuum as is obtained and well known in injection engines) the steam which passes through the engine for the working thereof, and also to condense for the most part (if not wholly) that portion of steam which usually escapes into the atmosphere through the safety valves when the pressure of the steam in the boiler is too high during the working of the engine, in order that the water resulting from the condensation of such steam may be returned into the boiler. And also, further to supply so much more distilled water to the boilers of the above mentioned description of engines as is required to supply and replace any waste that may take place in the working thereof, in order to avoid the introduction of any water (into the boilers) containing saline or other extraneous matters.

“My invention does not consist in the novelty of any one of the five apparatus hereinafter mentioned, but in the combination of the whole five, or at least three out of the five, within proper proportions, (as hereinafter described,) as regards the first three, which I have found by experience to be beneficial, and from the want of knowing and observing which I have reason to believe that all persons who have made former attempts of the same nature have failed. I now proceed to describe the above mentioned five apparatus, consisting of—

“First, a sufficient quantity of metallic surfaces in the form of vessels, channels, passages, or pipes of any convenient form, arrangement, or construction. The extent of such metallic surfaces should be about 2800 square inches for the condensation of 60,000 cubic inches of steam per minute.

“Secondly, a pump or any other proper apparatus for the passing of a sufficient quantity of cold water amongst such above mentioned pipes, not only to condense all the steam of steam engines, but also to cool the water resulting from the condensation thereof, to as low a temperature as (or even lower than) that of the mixture of the condensed steam and injection water, which is discharged from the air pumps of injection engines, in order to produce by such application of cold water, when used in combination with the metallic surfaces, as above stated, and with the air-pump hereinafter mentioned, as good a vacuum as is obtained and well known in such injection engines, if not indeed a still more perfect vacuum. The quantity of cold water which I employ is ten gallons for such condensation of such 60,000 cubic inches per minute.

“Thirdly, the ordinary air-pump of the capacity hereafter stated to produce, when in conjunction with the before mentioned two apparatus, a sufficiently perfect vacuum, as above defined.

“Fourthly, an apparatus for distilling water to replace the waste of water that may take place in the working of the engine, in order to avoid, as above mentioned, the introduction of any water into the boilers containing saline or other extraneous matters.

“Fifthly, an apparatus, which I call the steam saver, for saving the steam that usually escapes into the atmosphere from the safety valves, when it becomes of too high pressure during the working of the engine, the apparatus causing such steam to pass into the condensers to be converted into water and return to the boiler. It may be proper here to remark, that within certain limits which experience will readily suggest, the above mentioned proportions of metallic surfaces of cold water and capacity of the air-pump may be varied in a certain inverse order, that is to say, if the cold water be diminished, the extent of metallic surfaces or the capacity of the air-pump, or both, should be increased; and on the other hand, if the extent of

metallic surfaces be diminished, the quantity of cold water or the capacity of the air-pump, or both, should be increased to produce the same effect.

“Having now described the five several apparatus the combination of which (within proper proportions as hereinbefore described as regard the first three) constitute my invention, I proceed again to define and explain the extent of my claims. I now therefore state, I do not claim the exclusive use of any one of the five apparatus herein described taken separately, some of them, if not all, having been used before, nor indeed do I claim the use of any two of them, if unaccompanied by any or either of the others, but I do claim as my invention the exclusive use of the threefold combination of the sufficient quantity of metallic surfaces, the sufficient quantity of cold water passing among them, and the sufficiently capacious air-pump as hereinbefore fully described, whether the said threefold combination be used alone or combined with the distilling apparatus and the steam saver, or either of them. I also claim the exclusive right of combining the distilling apparatus and the steam saving apparatus, or either of them, with the above mentioned threefold combination, or even with the two first of them, videlicet, the metallic surfaces and cold water passing among them, should a less air-pump be used. In witness whereof,” &c.

The advantages of Mr. Hall's patent engines over injection engines will perhaps be best understood by his comparative statement of them.

“COMPARISON BETWEEN INJECTION STEAM ENGINES AND SAMUEL HALL'S PATENT STEAM ENGINES.

1. Injection engines, when applied to steam navigation, comprise of necessity the barbarous practice of supplying dirty salt water to the boilers.

2. In injection engines, the water in the boilers may become saturated with salt, in which case it will not boil under 225° of temperature.

3. In injection engines, in order to prevent the water from becoming saturated with salt, a large quantity of boiling water must be pumped out of the boilers, or blown off, and replaced with cold water

The patent engines effect a supply of the purest distilled water to the boilers, by which they are always kept in a perfectly clean state.

The patent engines having pure distilled water in the boilers, it boils at 212° or at 13° less temperature than salt water, and of course requires less fuel to convert it into steam.

The boilers of the patent engines never require any blowing out, no matter how long the engines are in uninterrupted operation.

every two or three hours, which cold water, having to be brought up to the boiling point, causes a considerable waste of fuel to take place.

4. In injection engines, the boilers will, after every precaution is taken, become coated with hard scale of considerable thickness; this being a bad conductor of heat prevents the free transmission thereof from the fires to the water, causes the boilers to burn and wear out very rapidly, and greatly increases the consumption of fuel.

5. In order to prevent the boilers of injection engines from burning and wearing out with a rapidity that could not be submitted to, it is necessary in long voyages to suspend the working of the boilers in order to empty and cool them, for the purpose of clearing away and chipping off the scale that firmly adheres to them, which operation considerably injures the boilers.

6. In injection engines, the oil which is put into the cylinders, stuffing-boxes, slides, &c., is speedily carried away by the injection water into the sea; the time, therefore, of its being in the engines is so short that nine tenths of it is wasted and does but little if any good, and it does not, as in the patent engines, enter the boilers and protect them from the corrosive action of hot salt water.

7. In injection engines, a portion of the salt contained in the water is carried over mechanically along with the steam into the working cylinders, slowly corroding and wearing the slides, valves, and other

The patent boilers of the engines will be perfectly clean not only for many voyages but for years, and their durability will be very much greater than that of boilers supplied with salt water; and a comparatively small consumption of fuel will also be the result.

In the patent engines, all delays and inconveniences arising from the emptying and clearing of boilers are entirely superseded, for by their permanent cleanliness, the water they contain entirely defends them from the action of the fire, and as no deposit takes place, they are not subjected to the injury caused by chipping off scale, as in injection engines.

In the patent engines, not a particle of the oil which is given to the internal parts of the engine, &c., is washed away into the sea or lost, but it is all carried into the boilers, whereby they are protected from corrosion, and an ample lubrication of the engines is effected at scarcely any cost, as hereafter mentioned.

In the patent engines, a portion of oil being always, as before stated, introduced in commixture with the pure water into the boilers, it passes over mechanically along with the steam in minute parti-

internal parts of the engines, whereby they are rendered untrue, and a considerable quantity of steam escapes past them and is wasted.

8. In injection engines, salt water, dirt, sand, and other impurities pass through the air pumps and thereby render them and their piston rods, &c., very rough and full of furrows; in consequence whereof, great friction in working them and waste of power is occasioned.

9. In injection engines, a considerable power is required to pump out the injection water; in engines of 450 horse power, (like those on board the Great Western,) 2700 gallons of water per minute have to be pumped out of a vacuum, (reckoning six gallons per horse power per minute,) and this requires as much power as the pumping of that quantity of water out of a well 30 or 32 feet deep.

10. In injection engines, in stormy weather and heavy seas the condensing water enters the condensers as rapidly when the engines are going at a slow as when they are going at a fast speed, and as it is impossible to regulate the quantity of injection water according to the irregularity of the speed of the engines, great danger arises on the one hand of choking the condenser and the air pump, and of even breaking down the engines, by the admission of too much water when they are going slow, or on the other hand, of deducting greatly from the power of the engines by

cles into the cylinder, thus, this ample lubrication actually improves the slides, valves, and other internal parts of the engines instead of injuring them, whereby a great saving in their wear and tear is effected.

In the patent engines, nothing but distilled water and oil pass through the air pumps, which instead of becoming rough are thereby rendered more smooth and polished, and of course brass buckets, piston rods, and linings to the air pumps are not necessary, as is the case in injection engines.

In the patent engines, the air pump has only to pump out of the vacuum, the water resulting from the condensation of the steam, which in a pair of engines of 450 horse power is only about 50 gallons per minute; the saving of the power, therefore, required to pump out the 2700 gallons per minute of injection water is so much additional effective power gained and applicable to the paddle wheels.

The patent engines, in the roughest weather and when the greatest power is required, preserve as perfect a vacuum, and consequently as great a power, as in fine weather, and all the power required in injection engines to supply the proper quantity of condensing water is superseded, and the engineer is relieved from that onerous duty.

injecting too little water into them when their speed is great, thereby deteriorating the vacuum and reducing the power of the engines, and that at the time when the greatest power is required.

11. In injection engines, the proper supply of water to the boilers is dependent upon and entirely at the mercy of the engineers, from whose negligence such serious accidents arise as those of the explosion of the two Hull steam vessels, the Union and Victoria, and many others, by which a most serious loss of life has taken place and great injury has been done to the reputation of steam navigation.

12. In injection engines, the vacuum is injured by the air which is in mechanical combination with the injection water being conveyed by it into the condenser.

In the patent engines, the boilers are never liable to be burnt down or injured by the water becoming in them, by accident or by the carelessness of engineers, too low, for as every cubic foot of water which is converted into steam is by condensation reconverted into precisely the same quantity and returned to the boilers, the water is always kept in them at exactly the same height without any attention on the part of the engineer.

In the patent engines, a superior vacuum is obtained, owing to no air being introduced into the condensers, and to the condensation being more perfect than can be effected by injection."

"ADVANTAGES APPERTAINING TO THE PATENT IMPROVEMENTS.

"First, from the various causes above mentioned, a saving of at least one third part of the fuel is effected in the patent engines, or in other words injection engines consume half as much more fuel as the patent engines.

Second, for every ton of coal that is saved, a ton of profitable freight may be substituted.

Third, as vessels with engines to which the patent improvements are applied make their passages nearly as quick in stormy as in fine weather, and as they do not require during or at the end of their passages, however numerous, any blowing out or cleaning of the boilers, to occasion delays, every vessel is capable of making more passages and of becoming in that ratio more profitable.

Fourth, as boilers supplied with pure distilled water will endure a much greater length of time than those in which salt water is used, not only is the annual expense of the boilers greatly diminished, but the loss of the time of the profitable use of the vessel during the taking out of old boilers and the replacing them with new ones is also avoided, to say nothing of the breaking up of the decks and other expenses attending the business.

Fifth, as the internal parts of the engines are kept so much longer in repair owing to the causes above mentioned, the perpetual expense and time required in repairing such parts is greatly diminished; indeed there is no doubt but the slides, valves, pistons, and all the internal parts of the engines are in much finer condition after having been in operation for years, than they are the first day they are set to work. The circumstance of salt being carried over with the steam into the cylinders (when salt water is used in the boilers) is unquestionable, as well as that it is the cause of the valves and other internal parts of the engines becoming so soon in bad condition, whereby a great waste of steam takes place even long before they become so very much worn as to render it indispensably necessary to give them a thorough repair.

The regulation of injection water, and of the water to supply the boilers, forms no part of the duty of the engineer, as they are quite superseded by no injection taking place, and the boilers being self-supplied with undeviating accuracy.

It may also be observed, that the comparative advantages of the patent engines do not appear to be so great on the first starting of new engines, or even during the first month or two, as the boilers and machinery of injection engines, are then as clean and in as good order as those of the patent engines; but afterwards, when the boilers of the former become thickly coated with scale, the internal parts of the engines are worn and galled, while those of the latter are actually improved, and the comparison should then be made.

Lastly, it is certain that a vessel with the patent engines of 300 horse power, will effect an increase of economy and advantage of £2500 or £3000 per annum over a vessel having injection engines of that power, and consequently the former will realize so much greater a profit."

The following engines are now in operation with the improvements applied to them:

The *Sirius* steam ship with a pair of engines of 320 horses' power, both included, on the station from London to New York, being the first steam vessel that performed that voyage across the Atlantic and back. This vessel belongs to the St. George Steam Packet Company, and is chartered by the British and American Steam Navigation Company.

The *Megara* steam ship with a pair of engines of 140 horses' power, stationed in the Mediterranean, and built by the Lords Commissioners of the Admiralty for her Majesty's navy. Engravings of her engines are given in this work, Plates XLIX., L.

The *Hercules* steam vessel with a pair of engines of 180 horses' power, stationed between Glasgow, Dublin, and Cork, belonging to the St. George Steam Packet Company.

The *Sea-horse* steam vessel with a pair of engines of 260 horses' power, stationed between Hull and Rotterdam, belonging to the St. George Steam Packet Company.

The *Juno* steam vessel with a pair of engines of 260 horses' power, stationed between London and Cork, belonging to the St. George Steam Packet Company.

The *Vulture* steam vessel with a pair of engines of 260 horses' power, stationed between London and Cork, belonging to the St. George Steam Packet Company.

The *Tiger* steam vessel with a pair of engines of 300 horses' power, stationed between Hull and Hamburg, belonging to the St. George Steam Packet Company.

The *Wilberforce* steam vessel with engines of 300 horses' power, stationed between London and Hull, belonging to the Humber Union Steam Company. Engravings of the engines of this vessel are given in this work.

The *Kilkenny* steam vessel with a pair of engines of 300 horses' power, stationed between London and Waterford, belonging to the Waterford Commercial Steam Navigation Company.

The *Windermere* steam packet with a pair of engines of 60 horses' power, stationed between Liverpool and Ulverstone, belonging to James Winder, Esq., of Liverpool.

The *Albatross* steam packet with a pair of engines of 70 horses' power, stationed between Hull and Yarmouth, belonging to Messrs. Boardman and Harmer, of Norwich, and others.

In addition to the engines above mentioned, a magnificent pair of engines of 500 horses' power, on board the British Queen steam ship of 1863 tons, will be, in the course of a short time, in operation between Great Britain and the United States.

And another pair of engines of 500 horses' power are making for the President, another vessel building for the British and American Steam Navigation Company, of 2028 tons, being also for navigation between Great Britain and the United States.

A pair of engines of 220 horses' power are also now making for the Honourable the East India Company.

In addition to the above, a considerable number of land engines are in satisfactory operation with Mr. Hall's improvements, but it is not necessary to particularise them.

The great importance of Mr. Hall's improvements to steam navigation and to land engines, where water containing saline and other extraneous matters only can be procured for the condensation of the steam used in working engines, is strongly illustrated by extensive documentary evidence, corroborating the advantages that have been stated.

For graphical explanation, see Plates XLIX. and L.

PLATES XLIX. AND L.

ENGINES OF HER MAJESTY'S STEAM SHIP MEGÆRA.

Her Majesty's steam ship Megæra is fitted with Messrs. Seaward's engines and Mr. Samuel Hall's condenser.

Plate XLIX. represents an elevation of the engines.

Plate L. exhibits a section of the same engines, and comprises a delineation of Seaward's Patent Slide Valves, the principle of which has been described in Art. 451.

The same letters refer to corresponding parts in both Plates.

- | | |
|---|--|
| <p>A, Is the boiler, of which—
 <i>a</i>, Is the furnace door.
 <i>a'</i>, Grate bars.
 <i>a''</i>, Furnace.
 <i>b</i>, Bridge.
 <i>c</i>, Flues.
 <i>d</i>, Take-up.
 <i>e</i>, Chimney, which is surrounded with a double casing <i>e'</i>, filled with incombustible and non-conducting matters, calculated to intercept the heat and thereby prevent accident from fire.
 <i>f</i>, Water space beneath the flues, sufficient to permit a free passage for cleaning and repairs.
 <i>f'</i>, Water space between the flues.
 <i>g</i>, Steam box, on which are fitted the safety valves <i>g'</i> in close iron boxes <i>g''</i>.</p> | <p><i>h</i>, Is the stop valve, fitted on the upper end of the steam pipe <i>h'</i>, so that the steam may be completely shut off from either boiler, and the engines, as found necessary.
 B, The steam cylinder, with its piston <i>B'</i>; <i>m</i>, <i>m'</i>, <i>m''</i>, steam slide casing, of which the boxes <i>m'</i>, <i>m''</i>, contain the steam slides which are connected by the pipe <i>m'</i>, with the steam pipe <i>h'</i>, leading from the boiler A.
 <i>n</i>, <i>n'</i>, <i>n''</i>, Exhaustion slide casing, the boxes <i>n</i>, <i>n''</i>, containing the exhaustion slides, which are connected with the top chamber of the condenser L, by the exhaustion pipe <i>n'</i>, and the nozzle at <i>n</i>.</p> |
|---|--|

Both the steam and exhaustion slide casings are cast on the cylinders, due consideration being paid to the difference in expansion and contraction of the side pipes *m'*, *n'*, and of the cylinder B.

By this construction, the usual joints at the nozzles, 1, 2, 3, 4, by which the slide casings are attached to the cylinders are dispensed with, and of course the risk of leakage avoided.

r r, *s s*, Are the steam slide facings or back plates, through which are apertures corresponding with those of the nozzles 1 and 2.

t t, v v, Are the exhaustion slide facings or back plates, the apertures through which correspond, in like manner, with those of the nozles 3 and 4.

The four back plates *r, s, t, v*, are distinct from the casings, and are fixed in the boxes or recesses *m, m'', n, n''* of the slide casings, by folding wedges or keys, so that *r r, s s* have their backs against the cylinder, while *t t, v v* present their faces to the same, their backs being wedged to projections or flanches adapted thereto, in the recesses *n, n''*.

To insure perfect joints, a plain caulking space is left at the bottom and back of each slide-face, while the edges, which fit the casing at the face, have dovetail portions removed so as to permit the insertion of soft or elastic packing, which, with that beneath and at the back, completely surrounds the aperture and renders all tight.

Facility is afforded of removing either back plate when requisite, by driving back the folding wedges or keys, which keep them firmly in place, this dovetail form of the edge permitting the facings to be readily detached from the packing after being pressed by the wedges.

w, x, y, z, Are four slide valves, of rectangular figure, receiving their motion from rods or spills passing through the stuffing boxes 5, 6, 7, 8.

The valves *w, x* are the steam slides, having their backs always presented to the steam from the boiler, which maintains them in close contact with the faces of the back plates *r r, s s*.

The valves *w, x*, it will be seen, are connected to their rods or spills by knuckle joints, so as to permit perfect freedom of motion off their facings, independently of the rods. By this contrivance, water carried over from the boilers into the cylinder, is forced back by the piston into the steam pipe *h'*, till drawn off by cocks fitted at the bottom for such purpose; thus obviating the risk of accident from its accumulation, and dispensing at the same time with the necessity for escape or discharge valves.

The backs of the exhaustion valves *y, z*, being alternately submitted to the pressure of the steam on the descent and ascent of the piston, while their faces are presented to the condenser, it will be observed that perfect contact of the slides with their back plates *t t, v v* will ensue.

Thus the four slides *w, x, y, z* are caused to operate without packing, and without being submitted to greater friction than that due to the simple pressure of the steam.

ACTION OF THE VALVES.

The steam passing from the boiler A, by the steam pipe *h'*, is regulated in its admission to the slide valves *w*, *x*, by the throttle valve *i*, the rod *j j*, with its lever *j'* and adjusting arc *j''* being conveniently adapted for the same.

The engine then, after being cleared of air, &c., through the blow valve *l*, is put in motion by means of the starting lever *p'*, and causes the eccentric O, through its rod *o'*, to actuate the lever *p*, of the exhaustion balance-shaft X, a system of levers *q q*, affording the means of engaging and disengaging the same, according to the necessity of reversing or stopping the wheels. And the shaft X, being connected with the balance-shaft Y, of the steam slides by the levers *u, u'*, and the rods *u''*, it is clear that both shafts will operate simultaneously on all four slide valves, which are connected to the levers *u, u'*, of the said shafts by the side links 9, 10, 11, 12. Now when the lever *p*, is urged by *o'*, from the condenser L, the steam slides *w, x*, will be caused to descend, admitting the steam above the piston B', through the passage No. 1, while No. 2 will be closed by the slide *x*. The exhaustion slides *y, z*, ascending at the same time, will permit the steam from beneath the piston to pass off, through the passage No. 4 and pipe *n'*, into the condenser, the passage 3 being closed by the slide *y*.

When the lever *p*, on the contrary, is drawn towards the condenser L, the exhaustion slides will be depressed, while the steam slides are caused to ascend, thereby reversing the operation of the steam.

The lever *u*, moreover, which gives motion to the steam slides is so contrived that, the extremity of the rod *u''* can be moved by an adjusting screw, through a considerable space in a slot seen at *u*, thereby lengthening and shortening the leverage, and consequently the stroke of the steam slides.

The steam is thus caused to act expansively, to such extent as the variable circumstances of the weather at sea may suggest, the advantages of which are shewn in Arts. 422, 451, and elsewhere.

Hall's condenser is shewn at L, of which 13 is the upper chamber, containing a thin plate 14, completely perforated with small holes, by which the steam from the cylinder B, is distributed in its passage through the pipes 15 15, to the bottom chamber, 16.

The pipes 15 15, are surrounded with cold water, which is supplied through the pipe R', by the double acting pump R, R', whose motion is derived from the main lever C, through the rods W T, and the lever U, which is supported by the bracket V; the waste water passing into the sea through the opening S.

M, Is the air pump, through which the bucket M' discharges the water resulting from the condensation of the steam from the cylinder, in its passage through the pipes 15 15, together with the air and uncondensed vapour, into the hot well Z, through its valve 17, whence it is carried forward by the feed pipes into the boiler A.

Still, in order to meet unavoidable losses of water from the boilers by the waste of steam, &c., a distilling vessel A', of cylindrical figure, is introduced within the boiler, which uniformly maintains the requisite height of water therein, in the following manner :

A pipe 18, connecting the upper surface of the still A' with the upper or steam chamber 13, of the condenser, is furnished with a stop cock 19, which when open permits the vapour generated in the still to pass over into the condenser, whence it is returned by the feed pipes, in addition to the water resulting from the steam of *exhaustion*, into the boilers, and is regulated in quantity by the amount of opening of the stop cock 19.

The connection with the condenser produces a nearly corresponding vacuum in the still, whence evaporation takes place at a lower temperature and much more rapidly than if exposed to the atmosphere at the ordinary boiling point of 212°.

As the evaporation proceeds, and the water in the still becomes lower than the level marked in the drawing, the copper float 20, descends, carrying with it the rod 21, of the index 22, and causing the valve 23 to be lifted at the same time. The valve 23, being connected with the supply pipe 24, which is joined at the other extremity with the waste pipe S of the condenser, affords abundance of sea water to pass into the still, until again closed by the float 20 ; the index 22 exhibiting the operation.

By the frequent repetition of this process, it will be seen that the water in the distilling vessel A', will become saturated with salt, and in that respect the still will be assimilated, with the exception of risk from burning in case of neglect, to ordinary boilers working with sea water ; it is also kept clean by the same rule, thus :

The pipes, 18 and 24, being first shut off from the still by their respective stop cocks, a communication is opened by the cock 25, with a pipe 26, which descends nearly to the bottom of the still, its other end passing through the ship's side. At the same time, another pipe, (not seen,) also furnished with a stop cock, allows the steam from the boiler to pass into the upper part of the still, whence by its pressure the brine and other impurities are completely driven out into the sea.

These latter pipes being shut off and the former ones opened, the process of distillation goes on as usual.

The piston B', acting on the cross head D, gives motion to the side rods E, which are connected at the lower ends with the beams or main levers C, and these vibrat-

ing on their axes C', transmit the motion to the connecting rod G, through its side links or forks H, and fork head F.

The crank I, being impelled by the upper end of the connecting rod, produces a rotary motion about the paddle shaft N, which is supported by the framing K K.

The air-pump bucket M', receives its motion through the cross head P and side rods Q, which are connected to the beams at Q'.

To maintain rectilinear motion of the piston rod, a perpendicular rod 27, from the beam C, is caused to act on the radius crank 28, and parallel rods 29, whose action is transmitted to the piston through the side rods E, as in the other parallel motions.

PLATES LI., LII., LIII., AND LIV.

ENGINES OF THE HULL AND LONDON PACKET WILLIAM WILBERFORCE.

Plate LI. represents a plan of the engines of the Wilberforce Hull and London packet, built by John and Edward Hall, of Dartford, and fitted with Samuel Hall's patent condensers, and Francis Humphrys's patent slides. The mechanical arrangement of these engines differ from other marine engines provided with Hall's condensers, as every part of the condensing apparatus is fixed on the foundation plates of the engines, and the cold water pumps receive their motion directly from the great levers, by means of side rods and cross heads, like the air pumps, by which arrangement the parallelism of the several rods employed in working the cold water pumps is preserved, and the pumps themselves firmly and substantially fixed and united with the several other parts comprising the engines; thus also affording every convenience for ready access to the valves or plungers in case of their requiring repairs.

The slide valves of these engines, as well as the pistons and air pump buckets, are wholly metallic, and their operation have proved them to be quite as efficient as D slide valves in their most perfect condition without requiring any care or attention from the engineer; and they work with so little friction that one man can when required handle both engines, although the leverage power, as will be seen by inspecting the engravings, is little more than as two to one; this affords a great advantage to a marine engine, particularly in a crowded river like the Thames, through which the Wilberforce has to pass; but their more important advantage is felt in the steady maintenance of the power of the engines, and in the economy of fuel arising from the total absence of the leakage common to all hemp packed slide valves when neglected by the engine man or not plentifully supplied with melted tallow.

The general operation of these engines is like all other marine engines fitted with Hall's condensers, excepting that the water pumped from the condensers by the air pumps is not forced by the air pumps through the feed valves directly into the boilers, but is delivered into a casing or cylindrical jacket surrounding the chimney, and flows out at the upper part of the casing, into a stand pipe, sufficiently high to retain a column of water to overcome the pressure within the boilers, like the usual mode of feeding boilers in an ordinary Boulton and Watt engine. By this means the water acquires an additional temperature of about twenty degrees before it enters the boilers, and it is more perfectly separated from any bubbles of air which may arise in admixture with the water, when it leaves the air pumps.

The nominal power of these engines is 285 horses'; a very rapid and perfect exhaustion of the cylinders is effected, as will be seen by diagrams, pages 385, 386, taken with great care by a very good indicator adjusted for the occasion. The advantage of Samuel Hall's process of condensing by contact instead of by injection, will be very manifest on inspecting the diagram No. 2, taken in a heavy sea while the vessel was rolling and exposed to the effects of half a gale of wind; yet the vacuum was as perfect as in smooth water, and the exhaustion of the cylinder, proved by actual experiment, amounted to 13 lbs. upon each square inch of its area, which, together with the pressure of the steam, gives a mean force on the piston of 16.54 lbs. per square inch, and produces an absolute effect of 283.6 horses' power, or 567.2 horses' power with both cylinders, after deducting 2 lbs. per square inch on the pistons for the friction and power expended in working the pumps, &c., leaving an effect of 98 per cent. more than the nominal power of the engines; the diagram No. 1 gives a still greater effect than this, being more than 100 per cent. above the nominal power, and the mean effect, as ascertained by the indicator and shewn by the several diagrams, amounts to 96 per cent. more than their nominal power.

The uniform velocity of the engines in smooth water is 22 revolutions, the pistons moving through 264 feet per minute when the draught of the vessel is 9 feet 6 inches forward and 11 feet aft, at which draught the paddle wheels are immersed 3 feet 6 inches, measuring from the outer edges of the centre floats to the surface of the water, and the total area of the paddle boards thus immersed, amounts to 102 feet in each wheel.

The same letters of reference are employed to denote the same parts in each engraving, the use and operation of which will be understood on referring to the several plates.

Plate LII. represents a longitudinal elevation of the engines.

Plate LIII. represents a cross section shewing the after parts of the engines and the paddle wheels.

Plate LIV. shews a longitudinal section of the engines.

A, Steam pipes.

B, Throttle valves for regulating the supply of steam to the engines.

C, Blow valves for clearing the engines of air, by the admission of steam previous to starting.

D, Inlet sluices and pipes, 11 inches' diameter in the clear, for admitting the supply of water to the cold water pumps.

E, Relief valves for the purpose of affording a ready escape for any accidental accumulation of water within the cylinders, either below or above the pistons.

F, Humphrys's metallic slides, by which the great pistons are actuated.

G, The cold water pumps for forcing the water into the condensing cisterns H; these pumps are 18 inches' diameter having a stroke of 2 feet 8 inches, and supposing their chambers to be quite filled with water at each stroke, will supply at the rate of 8 gallons of water per minute per horse power, which is forced round the lower extremities of the condensing pipes and, ascending amongst them with considerable velocity, escapes through apertures in the cisterns at their upper extremities, by the pipes marked L.

H, Condensing cisterns; each cistern containing 2374 half inch copper pipes, 8 feet long each between the top and bottom plates, in which their ends are fixed, thus giving a total length of 18992 feet of pipe to each condenser exposed to the cold water, which is equivalent to $\frac{18992 \times 2}{285.4 \text{ H P}} = 133$ lineal feet of $\frac{1}{2}$ inch pipe per horse power.

I, Air pumps, 35 inches' diameter and 3 feet stroke, by which the water and air is pumped out of the condensers and conducted by the pipes K to the casing or jacket surrounding the chimney, where it is warmed and perfectly separated from the air and descends through a stand pipe into the boilers by its hydrostatic pressure, as usual in the ordinary mode of feeding low pressure boilers.

K, The feed pipes, 4 inches' diameter; each pipe is provided with a stop valve to prevent the water returning from the casing around the chimney into the air pumps.

L, Outlet pipes, 11 inches' diameter in the clear, through which the water from the condensing cisterns is conducted outside of the vessel.

M, Bilge pumps.

O, Starting handles for working the slide valves.

INDICATOR DIAGRAMS,

SHEWING THE PERFORMANCE OF THE ENGINES ON BOARD THE WILBERFORCE DURING A VOYAGE BETWEEN LONDON AND HULL, ENGRAVED FROM THE ORIGINAL CARDS.

DIAGRAM, No. 1.

$$15.35 - 2 = 13.35; \frac{13.35 \times 2827 \times 252}{33,000} = 288.2 \text{ Horses' Power.}$$

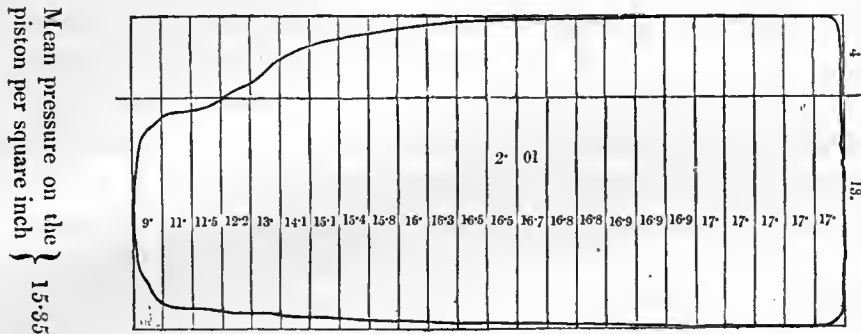

Pressure of Steam in Boilers, 11 inches of Mercury. Revolutions, 21. Condenser Gauge, 29.5. 2h. 30m. P.M.
Taken at the Nore from London to Hull. April 7th, 1838.

DIAGRAM, No. 2.

$$16.54 - 2 = 14.54; \frac{14.54 \times 2827 \times 228}{33,000} = 283.6 \text{ Horses' Power.}$$

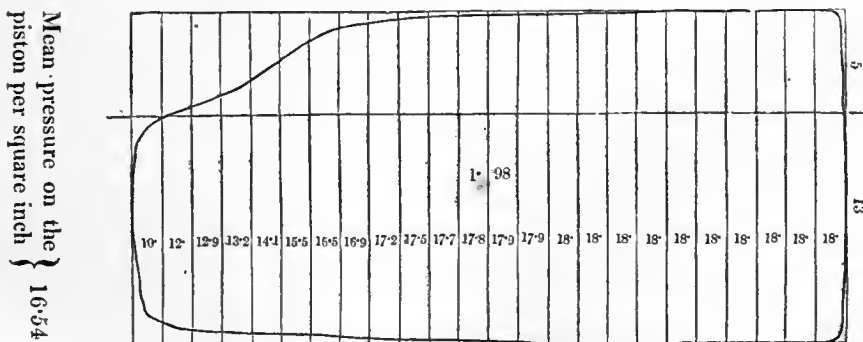

Pressure of Steam in Boilers, 13.5 inches of Mercury. Revolutions, 19. Condenser Gauge, 29.5. 11h. 30m. P.M. Abreast of Winterton. Wind, N.W., blowing very hard. Considerable swell, Vessel rolling, Gib and Fore Sails set.
From London to Hull. April 7th, 1838.

EXPLANATION OF THE PLATES.

DIAGRAM, No. 3.

$$15.97 - 2 = 13.97; \frac{13.97 \times 2827 \times 228}{33,000} = 272.8 \text{ Horses' Power.}$$

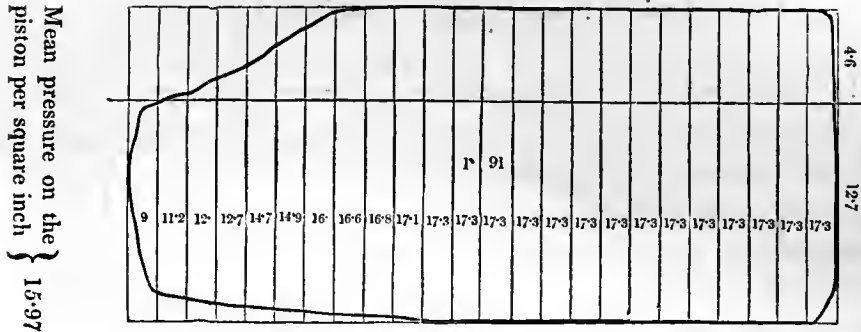

Pressure of Steam in Boilers, 10 inches of Mercury. Taken in the Humber; strong head wind and ebb tide. Revolutions, 19. Condenser Gauge, 29.3. 10h. 30m. A.M. From London to Hull. April 8th, 1838.

DIAGRAM, No. 4.

$$14.41 - 2 = 12.41; \frac{12.41 \times 2827 \times 261}{33,000} = 277.4 \text{ Horses' Power.}$$

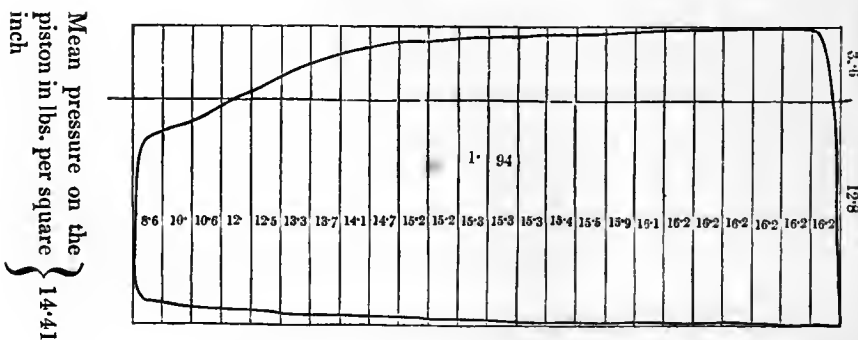

Pressure of Steam in Boilers, 12 inches of Mercury. Revolutions, 21.75. Condenser Gauge, 29.5. 10h. 30m. A.M. Taken in the River Thames. From Hull to London. April 12th, 1838.

MODE OF CALCULATING THE POWER OF AN ENGINE BY THE INDICATOR CARDS.

The mean pressure on the piston, as proved by the indicator in diagram No. 1, is 15·35 lbs. upon each square inch of its area, and the area of the piston being 2827 inches, it follows that the total pressure on the piston is equal to 15·35 multiplied by 2827, which amounts to 43394 lbs., but as an allowance of 2 lbs. upon each square inch area is made for the power necessary to overcome the friction of the engine and to work the pumps, the *effective* pressure on the piston will be represented by multiplying $15\cdot35 - 2 = 13\cdot35$ by 2827, which gives 37740·4 lbs.; and as this pressure is maintained at a velocity of 252 feet per minute, (the piston making 21 double strokes of 6 feet each,) it follows that the power of the engine will be expressed by multiplying 37740·4 lbs. by 252, the velocity in feet per minute, and then dividing the product by 33,000 for the horses' power.

OBSERVATIONS made on the PERFORMANCE of the ENGINES of the STEAM SHIP WILBERFORCE, from LONDON to HULL,
 APRIL 7th, 1838.

Time.	Pressure of steam in lbs. per square inch.	Velocity of engines.	Condenser gauges.	Temperature of water.	Temperature of water from condenser.	Temperature of water from air pumps.	Temperature of water from casing round chimney.	Temperature of the atmosphere.	OBSERVATIONS.	
h. m.		
3 30	Left St. Katherine's Wharf, draught forward, 10 ft. 5 in., draught aft, 11 ft. 8 in.	
9 37	Abreast of Blackwall.	
11 43	6.0	21	29.0	Abreast of Gravesend.	
1 15	5.5	31	29.0	Abreast of the Nore Light vessel.	
2 30	3.0	20.25	29.5	43°	59°	54°	71°	Took Diagram No. 1, larboard engine.	
3 30	3.5	19.75	29.5	Heavy swell.	
4 30	3.5	19	29.5	Abreast of Orfordness.	
5 45	3.5	29.5	Heavy swell, wind due W. Fore sail, top, and square sail set.	
6 30	4.5	20	29.5		
6 40	5.0	21	29.3		
7 30	4.5	20	29.4		
8 0	4.25	19.5	29.4		
8 30	4.25	18	29.4	Abreast of Lowestoff. Heavy sea; vessel rolling.	
8 45	5.0	Heavy swell; fore sail and top sail.	
9 45	6.0	20	29.0	Gib and fore sail; wind NW.	
11 0	6.0	18.5	29.0	Took Diagram No. 2, abreast of Winterton; wind NW, blowing very hard.	
11 30	6.5	19	29.0	Abreast of Hasborough lights.	
12 5	Abreast of Croner.	
12 30	5.0	20.5	29.3	Abreast of the Dudgeon; gale from the NW.	
12 45	5.0	21	29.3		
1 30	6.5	17	29.0		
7 30	4.75	20	29.4	39° Sea	57°	56°	66°	39°		
10 0	3.5	19	29.5	Strong head wind and ebb tide in the Humber; took Diagram No. 3.	
10 30	5.0	19	29.3	40° Humber	56°	53°	65°	39°		
11 30	4.5	19.5	29.4	Abreast of the Hull Docks.	
12 25		
	101.75	393.0	4.84..	Mean pressure of steam in lbs. per square inch.					Total time occupied from London to Hull, the vessel being very heavily loaded, with a considerable swell of the sea all the way, and 11 hours' gale—27 hours, 55 minutes.	
	21	20	19.65..	Mean revolutions of the engines.						
Number.			236..	Velocity of the pistons in feet per minute.						

OBSERVATIONS made on the PERFORMANCE of the ENGINES of the STEAM SHIP WILBERFORCE, from HULL to LONDON, 11th and 12th of APRIL, 1838.

TIME.	Pressure of steam in lbs. per square inch.	Velocity of engines.	Condenser gauges.	Temperature of water.	Temperature of water from condensers.	Temperature of water from pumps.	Temperature of water from casing round chimney.	Temperature of atmosphere.	OBSERVATIONS.	Ft. In.
h. m.										
11 25	4.5	20	29.5	44° Humber.	60°	61°	70°	59°	Started from abreast the Hull Docks, draught forward 10; aft 11 2. Wind WSW; gfb and fore sail set. Abreast of Spurn Lighthouse.	Ft. In. aft 11 2.
12 30	4.5	21	29.5			
1 0	4.5	21	29.5			
1 30	4.5	21	29.5	Gib, top, and fore sails set (swell). Commenced weighing coal, but obliged to discontinue on account of the swell.		
2 30	4.0	21	29.5			
3 15	4.5	20.5	29.5			
3 30	4.0	20.5	29.5	Abreast of the Dudgeon.		
4 20	4.5	20.75	29.5	Abreast of Hasborough Lights.		
4 30	4.75	21.5	29.5			
5 30	5.10	21.6	29.3			
6 30	5.25	21.0	29.3	Wind WSW, abreast of Winterton, all sails set. Abreast of Newharp; fresh head wind, all sail off.		
7 0	5.0	21	29.3			
7 30	4.5	20.5	29.5			
8 0	Abreast of Yarmouth.		
8 20			
8 30	4.25	19	29.5			
8 55	4.5	19.5	29.5	Abreast of Lowestoff.		
9 25	4.5	29.5			
9 30	5.75	21	29.0			
9 50	5.5	29.0	Abreast of Orfordness.		
10 30	5.0	20.5	29.2			
11 30	4.5	20	29.4			
11 55	29.4	Abreast of Harwich; engines obliged to be stopped owing to the brasses of one of the starboard great levers heating through neglect, the vessel floating back with the ebb tide to nearly abreast of Orfordness, when the engines were again started. Again abreast of Harwich.		
12 30	4.5	20	29.4			
1 0			
4 15	5.75	20.5	29.0	Abreast of the Nore Light vessel. Abreast of Gravesend Pier. Took Diagram No. 4. Abreast of St. Katherine's Wharf.		
5 30	4.5	21	29.4			
7 0	5.0	21.25	29.3			
7 32	5.5	21.5	29.0	45° Nore.	53°	55°	74°	Abreast of the Nore Light vessel. Abreast of Gravesend Pier. Took Diagram No. 4. Abreast of St. Katherine's Wharf.		
9 25	5.5	21.5	29.0			
10 30	6.0	21.75	29.0			
11 35	5.5	29.0	Total time occupied from Hull to London . . . hrs. min. Time lost by stopping engines off Harwich . . . 3 15	20 55	
135.85	518.85			
23	25			
Number.									Time occupied from Gravesend to London including many interruptions arising from a crowded pool } 2 10	
									Total time occupied from Hull to Gravesend . . . 18 45	

4.65... Mean pressure of the steam in lbs. per square inch.
20.75... Mean revolutions of the engines.
249... Velocity of the pistons in feet per minute.

PLATE LV. A.

This plate represents a longitudinal section of Mr. Francis Humphrys's patent marine engine, of fifty horses' power, as executed by the Messrs. Hall, of Dartford.

A A, Is the cylinder.

B B, The working piston.

C, The crank.

D D, A steam-tight casing or trunk, of a rectangular form, rounded at each end, which is permanently attached to the piston in such manner that the axis of the one shall correspond exactly with that of the other, and which works up and down with the piston.

E E, Is the lid or cover of the cylinder A A.

G G, The stuffing box, which is made to fit the outside of the casing or trunk D D, instead of, as usual, fitting the piston-rod.

H, Is the connecting rod firmly secured to a cross pin or axis I, working in metallic bearings, one end of which rod is attached to the bottom of the piston, and the other passes up through an aperture in the piston into the casing or trunk D D, and is ultimately connected with the crank C.

K K, Is a box or cover which encloses the cross-pin or axis I, with its bearings, and is jointed steam tight to the piston.

L L, A hollow space cast in the cylinder bottom or bed-plate for the reception of the box K K, when the piston is at the bottom of the cylinder. The result of these arrangements is, that on the engine being set to work the motion of the piston is at once communicated by the connecting rod H, to the crank C, and causes it to revolve without the intervention of beams, cross-heads, or other auxiliary appendages, by which diminution in the number of the moving parts of the engine, and consequent simplification of its action, it is greatly reduced in size and weight.

a a, Slide valves.

c, Starting handle.

d, Air-pump rod.

e, Hot well.

f, Discharge pipe.

g, Snifting valve.

h, Eccentric rod.

The same letters of reference are employed to denote the same parts of the engine in each of the engravings, by a reference to which its operation will be better understood.

PLATE LV. B.

This plate shews a longitudinal elevation of Humphrys's engine.

- A A, Cylinder and jacket.
 C, The crank.
 D D, The steam-tight casing or trunk, which works up and down with the piston.
 H, The connecting rod, which vibrates freely within the steam-tight casing or trunk, as the crank revolves.
a a, Slide valve boxes or nozles.
c, Starting handle.
d, Air-pump rod.
e, Hot well.
f, Discharge pipe.
h, Eccentric rod.
k, Hand pump for supplying the boilers with water when the engine is not working.
l, Throttle valve.
m, Steam pipe.
n, Small pipe for supplying the cylinder jacket with steam.
u, Bilge pump.
o, Relief valve connected with the feeding apparatus, by which the water escapes into the hot well when it is shut off from the boiler.

PLATE LVI. A.

This plate represents a midship section of the steam packet Dartford, shewing a front elevation of a pair of Humphrys's engines of fifty horses' power each.

- | | |
|--|--|
| C C, Cranks. | <i>k</i> , Hand pump. |
| D, The trunk. | <i>ll</i> , Throttle valves. |
| H H, Connecting rods. | <i>mm</i> , Steam pipes. |
| <i>aaaa</i> , Slide valve boxes or nozles. | <i>pp</i> , Balance weights of slide valves. |
| <i>cc</i> , Starting handles. | <i>r</i> , Condenser. |
| <i>d</i> , Air-pump rod. | <i>s</i> , Air-pump. |
| <i>e</i> , Hot well. | <i>t</i> , Injection cock. |
| <i>ff</i> , Discharge pipes. | <i>xxx</i> , Foundation plate. |
| <i>hh</i> , Eccentric rods. | |

PLATE LVI. B.

This plate shews a plan of the engines of the Dartford.

- E E*, The cylinder lids or covers.
C C, The cranks.
D D, The steam-tight casings or trunks.
G G, The stuffing boxes.
H H, The connecting rods.
a a, Slide valve boxes.
c c, Starting handles.
e, Hot well.
f f, Discharge pipes.
h h, Eccentric rods.
s, Air pump.
k, Hand pump.
u u, Bilge pumps.
v v, Feed pumps worked by levers connected with the cross head of the air-pump rod.
w, Platform on which the engineer stands to start the engines.
x x x x, Foundation plate, cast in one piece and firmly secured to the four sleepers.
y y y y, This plate measures 13 feet 8 inches athwartships, and 8 feet 6 inches fore and aft, which is the space occupied by the two engines. The cylinders are each 42 inches diameter, and the pistons have a stroke of 3 feet 8 inches; the paddle wheels are 18 feet diameter, and 7 feet wide; the load water draught of the vessel is 8 feet 9 inches; the mean revolutions of the engines 26.

PLATES LVII., LVIII., AND LIX.

FORTY-FIVE HORSE POWER ENGINE CONSTRUCTED BY W. FAIRBAIRN AND CO.

- | | | | |
|-------------|---|------------------------------|---|
| Plate LVII. | } | Fig. 1. Elevation of engine. | } The letters refer to the same parts in all the views. |
| | | 2. Plan of ditto. | |
| LVIII. | } | 3. Front elevation. | |
| | | 4. Back ditto. | |
| LIX. | | 5. Cross section. | |

A, Base plate of engine and condenser.
 B, Steam cylinder.
 C, Column and hot well.
 D, Cut-off valve, and steam-pipe from boiler.
 E, Slide valve casing.
 F, Slide valve.
 G, Steam passages.
 H, Metallic piston.
 I, Passage to condenser.
 K, Condenser.
 L, Air-pump.
 M, Foot valve.
 N, Air-pump bucket.
 O, Discharge valve.
 P, Waste water-pipe.
 Q, Injection pipe and regulating valve.
 R, Force pump.
 S, Solid plunger of force-pump.
 T, Beam.
 U, Piston rod.
 V, Air-pump rod.
 W, Force-pump rod.
 X, Connecting rod.

Y, Crank shaft.
 Z, Toothed fly-wheel, forming first motion wheel.
a, Governor wheels.
b, Governor.
c, Wheels for working cut-off valve gearing.
d, Eccentric rod for working slide valve.
e, Socket for the starting handle.
f, Vibrating shaft to work slide valve.
g, Lever for counterbalance weight.
h, Boot-leg for giving motion to the slide valve.
i, Slide valve rod.
k, *K*, Counterbalance weight of slide valve.
l, Stud on small wheel for giving motion to the rod *m*.
m, Rod for working cut-off valve.
n, Vibrating shaft for ditto.
o, Lever on shaft *n* for working cut-off valve.
p, Rod with regulating screw, and levers for ditto.

PLATES LX., LXI., LXII., AND LXIII.

TEN HORSE POWER ENGINE CONSTRUCTED BY W. FAIRBAIRN AND CO.

Plate	LX.	Fig. 1. Elevation of engine.	} The letters refer to the same parts in all the views.
	LXI.	2. Plan of ditto.	
	LXII.	3. Sectional plan.	
	LXIII.	4. Cross sectional elevation.	
		5. Sectional elevation.	

A, Engine base.
 B, Column or pillar, to support the end of crank shaft.

C, Crank shaft.
 D, Fly wheel.
 E, First motion spur wheel.

F, Steam-pipe from boiler.	O, Feed pump.
G, Stop valve.	P, Feed pipe.
H, Cylinder.	Q, Water cock.
I, Belt round the cylinder, to bring the steam into the valve case.	R, Clack valves of feed pump.
K, Slide valve.	S, Connecting rod.
L, Steam ports.	T, Eccentric, for working the slide valve.
M, Piston.	U, Eccentric rod for ditto.
N, Education pipe.	V, Governor wheels.
	W, Governor.

PLATE LXIV.

ELEVATION OF LOCOMOTIVE ENGINE, STANHOPE AND TYNE RAILWAY; CON- STRUCTED BY MESSRS. ROBERT STEPHENSON AND CO., OF NEWCASTLE- UPON-TYNE.

This plate exhibits a general elevation of the engine without the tender. It should be observed, that the construction of locomotive engines has undergone considerable variation in external form and detail since the establishment of the Liverpool and Manchester railway. The particular form and arrangement of engine represented in the accompanying engraving is such as was adopted on this railway about the year 1834. The following is a general table of the dimensions of the various parts.

	Ft.	In.
Diameter of boiler	3	6
Length of ditto	8	0
Length of fire-box outside	3	7
Breadth ditto	4	0
Depth below boiler	2	3
Length of inside fire-box	2	11½
Breadth of ditto	3	7⅛
From top of bars to crown of fire-box	3	5⅜
Area of fire-grate in square feet	10	7
Length of smoke-box	2	1¾
Breadth of ditto	4	1½
Depth below boiler	2	5
Diameter of chimney	1	2
Height from rail	14	0

	Ft.	In.
Brass tubes, diameter outside	0	1 $\frac{3}{8}$
Distance of centres	0	2 $\frac{1}{2}$
Diameter of cylinders	1	0
Length of stroke	1	6
Distance of centres	2	7
Steam ports		7 in. \times 1 $\frac{5}{8}$ in.
Diameter of pumps	0	2 $\frac{1}{4}$
Diameter of wheels (2 pair coupled)	4	6
Ditto wheels, one pair	3	6
Distance of centres of coupled wheels	4	6
Centre of axle from fire-box	1	3 $\frac{1}{2}$
Diameter in middle	0	5 $\frac{1}{8}$
Diameter of crank pin	0	5 $\frac{3}{8}$
Length of ditto	0	3
Diameter of inside bearings	0	5 $\frac{3}{8}$
Length of ditto		two 2 $\frac{3}{4}$ in., and two 0
Diameter of outside bearings	0	3 $\frac{1}{2}$
Length of ditto	0	5 $\frac{3}{8}$
Diameter of plain axle, including coupled wheels	0	4 $\frac{1}{2}$
Ditto where wheels are on	0	4 $\frac{1}{16}$
Ditto outside bearing	0	3 $\frac{1}{2}$
Length of ditto	0	5 $\frac{3}{8}$
Distance apart	5	6 $\frac{1}{2}$
Springs' length	2	9 $\frac{1}{2}$
Breadth	0	3
Depth	0	2 $\frac{3}{8}$
Number of plates, 8.		
Plain axle for small wheels, diameter in middle	0	3 $\frac{1}{2}$
Diameter where wheels are on	0	4 $\frac{1}{2}$
Diameter of bearing	0	3 $\frac{1}{2}$
Length of ditto	0	5 $\frac{3}{8}$
Length of frame (extreme)	17	0
Breadth of ditto	6	3 $\frac{3}{4}$
Depth of ditto	0	7
Thickness	0	4

For description of parts, see Plates LXV., LXVI., LXVII. A., and LXVII. B.

PLATE LXV.

SECTION OF LOCOMOTIVE ENGINE, STANHOPE AND TYNE RAILWAY.

Plate LXV. is a general section of the engine, divested of its internal apparatus of tubes, &c., in order to prevent unnecessary complication, and to explain more clearly the more important divisions of the engine.

A locomotive engine is thus shewn to consist of three principal divisions; namely, A, the external fire-box, containing the internal one in which the fuel is placed; B, the boiler, of a cylindrical form, containing the brass tubes placed longitudinally from the smoke-box end D, to the fire-box end A; through these tubes the flame circulates, thereby distributing a maximum quantity of heated surface to the water. The boiler contains two or more long stays, E E, extending from the internal plate of the smoke-box end to the external plate of the fire-box end; the use of these stays is for preventing too great a strain upon the tubes by the expansion of the metal. In the earlier engines considerable inconvenience was experienced by the cylinders becoming primed, in consequence of water and steam coming over together and entering them, occasioned principally by the motion of the engine. This inconvenience has been obviated by the introduction of the chamber or steam-head C, into which the steam rises;—from the interior of this chamber the steam is conducted by a pipe (not shewn) to the cylinders. The relative position of the cylinders, piston, and guide frame, to preserve the parallelism of the piston-rod is shewn, by the references F, G, and H; I is the connecting rod attached to the crank J; K the man-hole for ascertaining the state of the fire-box, and as an entrance for the purpose of cleaning the same. The fire-bars L, it will be seen, are so placed that with a short lever they may be unhooked from their position, and the whole of the fire allowed to fall out when no longer required. M is the fire or furnace door.

PLATE LXVI.

SAFETY VALVES, STANHOPE AND TYNE RAILWAY LOCOMOTIVE ENGINE.

This Plate contains drawings to a working size of the two kinds of safety valves usually employed upon locomotive engines. Fig. 1 is a longitudinal section of the lever safety valve, with the application of Salter's improved spring balance attached instead of a weight. Fig. 2 is an elevation of the back of the balance, on

the line A, fig. 1. The balance terminates with a bent rod, B, somewhat of the curvature of part of the boiler to which it is attached by the screw C. The semi-cylindrical cylinder D contains a strong helical spring, which, by its extension or contraction, (occasioned by the rising or falling of the lever E, fig. 1,) moves a vernier upon the face F of the balance, indicating the power employed in raising or extending the spring. The face upon which the vernier moves is graduated according to the elasticity of the spring. The metallic circular and mitred valve G, fig. 1, is operated upon its under side by the steam, which rises from the interior of the boiler, passing through the chamber H, fig. 1, and again through a series of holes drilled in the seat of the valve I, fig. 1; the valve preserves its parallelism by the spindle K being guided in the tube L. Fig. 3 is a top view or plan of the whole apparatus.

Fig. 4 represents the construction of the spring safety valve, differing only from that represented above by the pressure of the steam being directly applied to the congeries of springs C C C without the intervention of the lever before described. This valve is usually covered and protected by a trumpet-shaped pipe, so that it may not be improperly loaded or tampered with by any one employed about the engine; neither are the springs so stiff as those employed in the lever valve, consequently any escape of steam from the boiler is first blown off through this valve and gives the requisite notice for checking the intensity of the fire.

Fig. 5 is a plan of the cap at A, fig. 4. Fig. 6 is a plan of the valve at B, fig. 4.

PLATE LXVII. A.

CYLINDER COVER AND CONNECTING RODS, STANHOPE AND TYNE LOCOMOTIVE ENGINE.

Plate V., fig. 1. The cylinder cover of the Stanhope and Tyne engine. A, the brass stuffing through which the piston-rod alternates. B B, brass stuffing piece.

Fig. 2. Side view of one end of the outside connecting-rods. A, wrought iron strap, secured to the connecting-rod by the gib and key; the brasses B B are brought to their bearings by tightening the key C. A set screw at A, fig. 3, secures it in its position; the brasses of these connecting rods work on a ball end crank pin, as shewn at B, fig. 3, which is a section of the end of the connecting rod.

PLATE LXVII. B.

THE CYLINDER AND PISTON AT LARGE; STANHOPE AND TYNE RAILWAY
LOCOMOTIVE ENGINE.

This plate represents the form, construction, and dimensions of the cylinder and piston of this engine, and fig. 1, Plate LXVII. A., the cylinder cover, to the same scale.

The steam from the boiler is admitted into the steam-chest A, fig. 1, from the pipe B, and from thence into the cylinders through the steam ports C, by the alternating action of the slide D; the exhausting pipe is shewn at E. F is the rod to which the brass slide D is attached; this rod receives the requisite alternating action by means of an eccentric and driver of the usual construction, placed upon the cranked axle of the engine.

The piston of this engine is represented in vertical section at fig. 2, and in horizontal section at fig. 3. The vertical section shews the piston to consist of two metallic rings A A, (brass,) the upper one being grooved to receive the tongue of the lower one. These rings are kept forcibly pressed against the cylinder by the split ring (steel) B B, figs. 2 and 3, in addition to which, are four other steel springs C C C C, fig. 3, which may be adjusted to any further degree of tension by the nut-screws D D D D. The piston cover and bottom are brought up by the screws C C, fig. 2, passing through the holes E E E E, fig. 3, tapped for that purpose. The piston-rod is keyed through, as shewn by the space for the keys at D, fig. 2.

The following scale of dimensions with respect to the diameters of wheels and piston rods may be found useful.

WHEEL TYERS FOR LOCOMOTIVES, BY ADMEASUREMENT.

Diameter of Wheels.		Circumference.				
Feet.	In.	Feet.	In.	In.	In.	
5	0	.	.	16	6	by 5 by 1 $\frac{3}{8}$
4	6	.	.	14	9	do. do.
4	0	.	.	13	2	do. do.
3	6	.	.	11	8	do. do.
3	0	.	.	10	2	do. do.
2	8	.	.	9	2	do. do.
2	6	.	.	8	7	do. do.

DIAMETER OF PISTON-RODS IN LOCOMOTIVE ENGINES, AS USED BY
MESSRS. ROBERT STEPHENSON AND CO.

Diameter of Cylinder, in inches.	Diameter of Piston-rod, in inches.
5	.74
6	.9

Diameter of Cylinder, in inches.		Diameter of Piston-rod in inches.
7	. .	1.04
8	. .	1.2
9	. .	1.34
10	. .	1.5
11	. .	1.64
12	. .	1.8
13	. .	1.94
14	. .	2.1
16	. .	2.375

For more detailed information on this important subject, see description of Plates LXXXIX—XCII.

PLATE LXVIII.

This Plate represents a plan and section of boiler seating, for a twenty horse engine, at the manufactory of Messrs. Whitworth and Co., Manchester.

PLATE LXIX.

This Plate represents Messrs. Hague's double acting cylinder, with slides, &c.

Fig. 1 is the cylinder, showing the facings for slide; A is the passage to the top; B the passage to the bottom; and C the exhausting passage.

Fig. 2 is a section of the cylinder and slide in the position for letting in the steam at the top A, and exhausting at the bottom through BC; D is the slide with the exhausting passage through it; F is a spring to keep the slide to its face; and G the steam pipe from the boilers.

Fig. 3 shows the facings of the slide.

Fig. 4 shows the side of ditto.

PLATES LXX. A. AND LXX. B.

SECTIONS OF THE ENGINES OF THE HON. EAST INDIA COMPANY'S ARMED STEAM VESSEL BERENICE, MANUFACTURED BY ROBERT NAPIER, ESQ., OF GLASGOW.

- | | |
|---|---|
| <p>A A, Boilers.</p> <p>B, Steam pipe connected to jacket of cylinder.</p> <p>C, Cylinders.</p> <p>D, Bed plates of engines, with condenser, hot well, &c., cast in one piece.</p> <p>F, Hot well.</p> <p>H, Framing.</p> <p>I, Steam chest for containing D, slide valve.</p> <p>J J, Eccentric rod and gearing for connecting and disconnecting engines.</p> <p>K, Piston rod.</p> <p>L, Cross heads.</p> <p>M, Cylinder side-rods.</p> <p>N, Parallel motion.</p> <p>O, Side beams (or side levers).</p> <p>P, Air pump side rods.</p> <p>Q, Connecting rods.</p> <p>R, Main cranks.</p> <p>S, Intermediate shaft.</p> <p>T T, Paddle wheel shafts.</p> <p>U, Paddle wheel.</p> <p>V, Paddles (or floats).</p> <p>W, Plumbing blocks.</p> <p>X, Waste pipe from top of hot well.</p> <p>Y, Stays for binding engines together.</p> <p>Z, Eccentric pulley.</p> <p>Nos. 4 4 4, Engine bearers.</p> <p>5, Keelson.</p> <p>6, Keel.</p> | <p><i>a a</i>, Safety valves on top and bottom of cylinder.</p> <p><i>b</i>, Stuffing box on cylinder cover.</p> <p><i>c</i>, Valve shaft.</p> <p><i>d</i>, Parallel motion shaft.</p> <p><i>e</i>, Starting shaft.</p> <p><i>f</i>, Hand gear for starting engines.</p> <p><i>g</i>, Expansion valve shaft.</p> <p><i>h h</i>, Gear for working expansion valve.</p> <p><i>i</i>, Side rods for working parallel motion.</p> <p><i>j</i>, Waste water pipe.</p> <p><i>k</i>, Injection pipe.</p> <p><i>l</i>, Waste pipe from feed pump.</p> <p><i>m</i>, Pump for filling boilers, washing decks, or extinguishing fire; the pump may be worked by the engine or crew.</p> <p><i>n</i>, Steam pipe.</p> <p><i>o</i>, Feed pipes for boilers.</p> <p><i>p</i>, Feed pump.</p> <p><i>q</i>, Cast iron crank hatches.</p> <p><i>r</i>, Malleable iron stays for supporting ends of paddle beams.</p> <p><i>s</i>, Malleable iron knee and stays for supporting ends of beams.</p> <p><i>t</i>, Handle for working pump on deck.</p> <p><i>u</i>, Funnel.</p> <p><i>v</i>, Steam chest.</p> |
|---|---|

The engines are 250 horse power, and the following are the principal dimensions :

Diameter of cylinder	4 ft. 8 in.
Length of stroke	5 6
Diameter of wheels	23 0
Length of paddle boards	8 6
Breadth of ditto	2 1
Diameter of funnel	4 0
Length of funnel above deck	36 0

PLATES LXXI. AND LXXII.

BEALE'S PATENT ROTATORY ENGINE.

As many fruitless endeavours have been made at various times to construct engines on the rotatory principle, capable of performing their work regularly and efficiently, as well as economically, we beg to submit the present description of Mr. J. T. Beale's invention to the attention of our readers*.

The several figures in plates LXXI. and LXXII. represent different views of this engine (of 8 horses' power) and its parts, drawn to a scale of 1 inch to the foot.

Plate LXXI. Fig. 1 is a plan or horizontal view of the engine complete, showing the general arrangement of the whole; but as very few of the working parts peculiar to this engine can be seen in this or either of the other external views, we shall not particularize any further, until we come to the sections, thinking it rather desirable, in order to preserve simplicity and perspicuity, to confine ourselves in the first instance to the mere citation of the several parts, each with its respective letter of reference, as follows, viz.—

- a*, Shows the foundation of the engine.
- b*, Is the band wheel.
- c*, The entrance steam pipe.
- d*, The cylinder.
- e*, The exit steam pipe.
- f*, The cam, or wiper, by which the slides are worked.
- g g*, The slide rollers.

* The precise claims to novelty urged by the patentee may be seen on referring to the specification of his patent, inrolled in the Inrolment Office of her Majesty's High Court of Chancery, August 27th, 1835; for although, in the present engine, several of the parts have been modified and improved, still the principle is the same.

- h h*, Tail pieces connecting the rollers with the slides.
i i, Springs tending to force the tail pieces with the slides inwards.
k k, Rods for attaching the tail pieces to the slides.
l, Bearings for the hollow axle.
m, Train of gearing communicating with the governor *n*.

The connection of the latter with the throttle valve in the entrance steam pipe is shown at *o*.

p, Is a wheel taking into the intermediate wheel, *m*, working a pump for supplying water to the boiler.

A, Is a sluice cock for letting on the steam; and

B, A double cock lubricator.

Fig. 2 is a front elevation, the engine in this figure being supposed to have moved half a turn to the left hand from the position in which the parts are shown in the former figure.

Plate LXXII. Fig. 1 represents a side elevation of the engine, showing all the parts in similar positions to those represented in the plan or horizontal view.

Fig. 2 is a longitudinal vertical section taken through the cylinder *d*, steam stop (or what may be called) piston *g*, hollow axle *r*, &c., the connection of the slides *s s*, with the tail pieces *h h*, by the rods *k k*, being also shown in section, in order to render it more evident. The hollow axle *r* has a partition *t*, shown in the middle, dividing the entrance from the exit steam way, as may be more clearly seen at figs. 3 and 4. In this figure the entrance steam way is shown in section at *u*, and the exit *v*, in dots; the cam or wiper *f*, as also the slide race or grooved way, are likewise shown in dots. The piston (marked *g* in the figure) is composed of several pieces of metal connected together as shown, the manner of fixing it between the hollow axle *r* and the inside of the cylinder being as follows. A standard piece, as at *w*, may be cast with the hollow axle *r*, but is preferred to be screwed firmly to it, to which the blocks of metal *x* are fastened, also with screws, but which screws, in this case, are passed through slots, in order to allow of a little play; the connection of the blocks, *x*, with the pieces *y*, which fit closely against the internal periphery of the cylinder, is formed by a tongue on the former, fitting into a corresponding dovetailed groove in the latter, the whole being kept perfectly tight during action by a spring, placed as seen by dots in fig. 3. The rotatory motion of the engine is effected by the elastic pressure of the steam admitted through the axle *r*, by the aperture *u*, into the cylinder *d*, exerted between the stationary steam stop or piston and each slide alternately as they are brought up the groove *z* into close contact with the axle *r*, by the action their respective rollers, *g*, receive in working over the stationary cam or wiper *f*. In this figure, the dotted line on the right hand

is intended to represent the base, the section being taken as looking into the cylinder from the front.

Fig. 3 shows a detached plan or horizontal view of the hollow axle and piston, with the partition and two steam ways in dots.

Fig. 4 represents a horizontal section of the above, taken through the centre of the hollow axle, showing the exit steam way *v* complete, and the partition *t* in section.

Fig. 5 is a face view of the side of the piston, fitting against the internal periphery of the cylinder; and fig. 6 exhibits a plan view of one of the slides *s*, with the tail piece *h* and roller *g* shown connected to it. This figure represents, in section, the method of attaching the slide *s* to the tail piece *h*, which is done in the following manner: on to the sunken part, 1, of the slide is cast a pin, 2, and over this pin is placed a wrought iron piece or collar, fitting rather loosely, into which the rod *k* is screwed, as shown in the plate.

PLATE LXXIII.

CONTRIVANCE FOR PREVENTING A LOCOMOTIVE ENGINE FROM RUNNING OFF A RAILWAY. BY RICHARD AYRE, ESQ., NEWCASTLE-UPON-TYNE.

This plate represents one of the ingenious contrivances of Mr. Ayre.

The figures 1, 2, 3, are different views of the locomotive engine, with the necessary apparatus. In fig. 1, AAA, represents a steel bar descending below the rail in the inside, about an inch below the flange of the wheel. This bar is connected to the frame of the engine by a joint, B, about which it is moveable; and a roller, E, is attached at the bottom, and a cross bar or brake, G, at the top. It is also connected with the steam valve by means of the chain HH; C is a joint to enable the bar to move backward or forward; D is a spring connected to the frame of the engine and, by the chain ED, to the bar AAA, which spring would be pulled down were any thing to come in contact with the bottom of the bar AAA, in the line of railway, and enable the end of the bar to move back and relieve itself. Also FF are two springs to keep the cross bar from the side of the engine, as shown in the cross sections fig. 2 and fig. 3.

Should there be any tendency to run off the railway, the bottom of the bar AAA, would by the pressure against the rail be driven inwards, and by its action round the joint B, the brake G would be caused to press against the wheels, and thus by the corresponding friction stop the motion; and at the same time this

object would be materially assisted by action of the chain HH, which in consequence of the motion of the top of the bar AAA, would regulate the steam valve so as to entirely close it in an extreme case. Fig. 2 shows the positions in an extreme case, when by means of a switch, or pall, which lies upon the cross bar, the parts are effectually prevented from returning to their original positions, and the motion of the engine and train is soon brought to a stand.

The same arrangement is fitted to the other side of the engine, and, as shown in Figs. 2 and 3, cross chains are fixed from side to side, so as to connect the top of each bar with the bottom of the other, and thereby insure the effect of the brakes against all the four wheels, as shewn in Fig. 2.

PLATES LXXIV. TO LXXXIII.

The drawings contained in these plates relate to Mr. Mornay's valuable paper on "Paddle Wheels," inserted in the appendix, page 117, and their explanations are to be found in that paper.

PLATES LXXXIV. TO LXXXVIII.

SIXTY-FIVE INCH CYLINDER ENGINE, ERECTED BY MESSRS. MAUDSLAY, SONS,
AND FIELD, AT CHELSEA WATER WORKS, 1837.

The drawings in these Plates are as follow :

Plate LXXXIV. Elevation of the engine pumps and air vessel.

Plate LXXXV. Longitudinal section through the centre of the cylinder, nozles, beam, main pump, &c.

Plate LXXXVI. Fig. 1. Front elevation of the hand gear, levers, and rods, with expansion tappet, &c. Fig. 2. Transverse section of nozles through centre of valves. Fig. 3. Side elevation of the hand gear, levers and rods, &c., &c.

Plate LXXXVII. Longitudinal section through the centre of one of the boilers, shewing the steam boxes, feed heads, floats, &c.

Plate LXXXVIII. Fig. 1. Front elevation of the boilers, shewing the furnace doors, steam boxes, damper pipes, feed heads, &c. Fig. 2. Transverse section of the boilers, shewing the steam boxes, pipes and stop valves, safety valves and pipes.

REFERENCES TO THE DRAWING, PLATE LXXXIV.

A, Cylinder.	L L, Cranes for raising cylinder and pump covers.
B B B, Nozles and valves.	M M, Catch pins.
C C, Condensing cistern.	N, Cold water pump.
D, Air pump.	O O, Hot water pump and air vessel.
E, Eduction pipe to condenser.	P, Pump rod.
F, Expansion tappet.	Q Q, Well.
G, Damper barrel for regulating the valves.	R, Working barrel of main pump.
H, Main beam.	S S, Clack barrels.
I, Sliding counter weight.	T, Air vessel.
K, Hoisting beams.	V; Main pipe.

This engine is single acting, the diameter of the cylinder is sixty-five inches, and the length of stroke eight feet; the diameter of the working barrel of the main pump is twenty-five inches, and the length of the stroke, also eight feet.

The boilers are six feet wide, eight feet high, and twenty-five feet long.

The operation of this engine and its appurtenances being nearly similar to the action of other engines before described, it is scarcely necessary to advert to it but for the purpose of explaining that its effective action is only in one direction, viz., during the descent of the cylinder piston. It may be explained as follows:—the progress of blowing through * being accomplished, the three valves † shut again, and the injection cock opened, the steam and eduction valves are opened, the former to admit the steam from the boiler into the top of the cylinder, and the latter to permit its egress from the bottom of the cylinder to the condenser. The equilibrium valve remaining shut, the pressure of the steam acting above the piston, with the vacuum underneath it, is sufficient to move the piston, and as it approaches the end of the stroke, or bottom of the cylinder, the hand gear tappets, and catches operate, first, to shut the steam valve, secondly the eduction valve, and lastly, when at the bottom of the stroke, to open the equilibrium, and thus open the communication between the top and bottom of the cylinder, the counterbalance at the outer or pump end of the beam then exerts a force sufficient to move the

* Opening the valves for the steam to pass from the boiler into the cylinder and through the nozles to the condenser, and thus expel the air, vapour and water through the blow valve and valves of the air pump.

† Nozles in front of cylinder; upper steam-valve; centre equilibrium valve; lower eduction valve.

piston up again, and transfer the steam from the top to the bottom of the cylinder, when the lower tappet shuts the equilibrium valve, and the action of its catch releases the catch of the steam and eduction valves, thereby admitting of their opening as before, and being the means of making the motion of the engine continuous.

The general construction of this engine is so analogous to that applied for pumping engines in water works of late years, that we think it necessary only to direct attention to those parts which are particularly striking.

Viewed merely as a machine, it is an admirable specimen of workmanship. The beam, and many of the parts, exhibit great strength, and are fully equal to the application of the expansive principle of working, should the adoption of it at a future period be determined upon. The castings throughout are of a superior description, and the fittings and bright work exhibit an attention to detail that cannot fail to attract the notice of the mechanic; he will perceive that the lathe and planing machine have lent their aid to all the bearing surfaces, and that every care has been taken to ensure solidity of construction.

The boilers are of wrought iron, upon the marine principle, securely stayed, and fitted with safety valves, feed pipes, and the usual apparatus, with the addition of whistle pipes, that old but effectual mode of making known the deficiency of water in the boilers.

Arrangements have been made to cover the boilers, steam pipes, and cylinder with non-conducting substances, as soon as the works are proved.

The structure of this engine admits of its being worked to the various altitudes required for street supplies, the chief means of regulation being the expansion tappet and safety catch, the latter acting when the length of the stroke exceeds the proper limit. The counterweight for adjusting the engine moves between guide strips inside the beam; it is worked by a long screw, which (the cross handle being moveable) admits of the whole range of the weight between the catch pins when the engine is at work.

The main pump and clack seats are fixed in a very substantial manner; they are supported by four strong iron beams, (through which very large holding down bolts pass,) and they are steadied by iron plates fixed above and forced against the masonry. The supporting beams are fixed within four feet of the bottom of the working barrel, and the masses of stone above them are considerable.

The pump clacks are of gun-metal, fitted with wrought iron plates leathered; these are of large dimensions compared with the working barrel, and they are fixed in separate chambered seatings and held fast by distinct rods pressed down by set screws.

Duplicates of such of the parts as are liable to derangement are kept in readiness, powerful cranes and hoisting girders are fixed, and the various tools so arranged that the taking to pieces and refixing any part of the engine and pump can be effected without loss of time.

The engine is calculated to raise 2250 gallons of water per minute.

PLATES LXXXIX. TO XCII.

PATENT LOCOMOTIVE ENGINE,
MADE BY MESSRS. R. STEPHENSON AND CO., NEWCASTLE-ON-TYNE,
FOR THE LONDON AND BIRMINGHAM RAILWAY.

This engine was made in 1836 for Messrs. Cubitt, the contractors for constructing a part of the London and Birmingham Railway near Berkhamstead, and was used by them for carrying the earth excavated in the construction of the line. The engine was employed in this manner for about a year and a half; when, the works being nearly completed, it was no longer required, and was purchased by the Railway Company for the purpose of carrying ballast for repairing the road, and other similar purposes, in which work it is now employed together with other engines.

Although the original cost of these engines is very considerable, being about £1400 each, it is found to be advantageous to use them in executing the earthwork of railways when the earth has to be carried to any considerable distance, as they take the place of so many horses and greatly expedite the work. They are also generally worth a great deal when done with for the particular purpose, as was the case with this engine, which was sold for upwards of two thirds of its original cost. The expense of using them is nearly the same as that of doing the same work by horses, if the saving of time from the greater speed and heavier loads that can be carried are not taken into the account; but the advantage in these respects is so great that locomotive engines are generally used for the works of railways whenever the earthwork is of any considerable importance.

A locomotive engine differs considerably from other steam engines in many particulars, as the engine and boiler are combined together in one machine, and have to be carried along at a great velocity, together with the fuel and water required for supplying the boiler. Very considerable modifications in the construction are thus rendered necessary, in order to obtain sufficient lightness and compactness combined with the requisite power. The cylinders are very much smaller than is usual in other engines, the steam used being of very high pressure; the boiler is also made of small dimensions in proportion to the power, for the sake of portability,

requiring therefore a construction affording the means of generating steam very rapidly, or having a great evaporating power, in order to supply the steam in sufficient quantity and of the required pressure. The whole engine has to be very strongly and firmly made and framed together, to enable it to resist the violent strains and shocks produced by the rapid motion of so heavy a mass even upon the comparatively smooth surface of the rails, and also to meet the accidents to which it is liable, and which are generally very serious.

The construction of these engines has undergone very great and extensive improvement during the last few years, and they have not long arrived at their present state of perfection; those made before the last ten years were greatly inferior, having not more than a fourteenth of the power of the present ones.

The engine here described, and shewn in the engravings, contains the latest improvements, and is similar in construction to most of those used on railways in England and on the Continent.

DESCRIPTION OF THE ENGINE.

Plate LXXXIX. is a side elevation of the engine and tender. The engraving is highly shaded to show more fully their general appearance.

Plate XC. a longitudinal section through the centre of the engine and tender, showing their internal construction; the section below the boiler being taken through the right hand cylinder and crank.

Plate XCI. Fig. 1, is a plan of the engine and tender; the plan of the engine is taken just below the boiler, in order to show the machinery beneath it, and at the left cylinder the plan is taken a little lower down, showing a section of the steam chest and more of the machinery; figs. 2, 3, and 4 are detached views of the working gear for the slide valves; figs. 2 and 3 being side elevations, showing the working gear in different positions, to explain their action; and fig. 4 a back elevation, showing it in the same position as figs. 1 and 3. The plan of the tender is taken at the top.

Plate XCII. contains an elevation of each end of the engine, and a cross section through each of the end portions.

The plates are all drawn to a scale of three quarters of an inch to a foot, or one-sixteenth of the real size, and the same letters of reference are used to denote the same parts in each of the figures.

The different parts of the engine are shown in detail on a larger scale in the wood cuts accompanying the descriptions, according to the size or importance of the parts.

The construction and object of the different parts of the engine will be explained in succession, together with the wear to which they are subject, the improve-

ments that have been made in them, and the principal variations in construction from other engines.

The general order of description will be, I. THE BOILER, AND THE MANNER OF GENERATING THE STEAM, with the means of supplying the boiler, of cleaning it out, and of insuring its safety; also of ascertaining the pressure of the steam, and the quantity of water.

II. THE CYLINDERS, AND THE MANNER OF USING THE STEAM, with the mode of supplying the cylinders with steam, and working the pistons and slide valves; and of moving the wheels and propelling the engine.

III. THE WHEELS, FRAMING, &c., OF THE ENGINE, with the springs, axle boxes, and guides, &c., connected with the frame.

And IV. THE TENDER, for carrying coke and water to supply the boiler.

THE BOILER, AND THE MANNER OF GENERATING THE STEAM.

The boiler consists of several distinct parts; the cylindrical portion A called peculiarly the boiler, the external fire-box B communicating with it, the internal fire-box C, containing the fire-grate D, and the tubes E communicating between the internal fire-box and the smoke-box F, upon which is fixed the chimney G.

THE BOILER AA (Plates LXXXIX. and CX.) is a cylinder 7 feet 6 inches long, and 3 feet 6 inches in diameter outside; it is made of wrought iron plates five-sixteenths of an inch thick, lapping over each other, and joined together by iron rivets seven-eighths of an inch in diameter and $1\frac{3}{4}$ inches apart, as shown at A in fig. 5, which is a section of a joint, half size. The rivets are inserted red hot and contract in cooling, drawing the plates forcibly together, and making a very close joint.

FIG. 5.

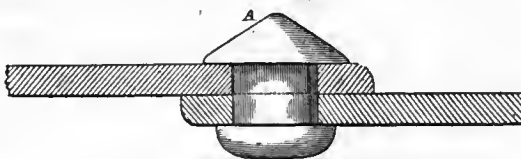

The boiler is covered with wood *aa* (Plate XC.) one inch thick, put on in longitudinal staves, and bound round by the iron hoops *bb*, Plates LXXXIX. and CX., which are screwed together at the bottom; this casing of wood is for the purpose of retaining the heat, and preventing it from being carried off by the air when moving rapidly through it, wood being an imperfect conductor of heat.

THE EXTERNAL FIRE-BOX BB is a box nearly square, 4 feet wide outside, and 3 feet $7\frac{1}{2}$ inches long in the direction of the boiler, made of wrought iron plates five-sixteenths of an inch thick, like those of the boiler; the bottom is 2 feet 1 inch below the boiler, and the upper part is a semi-cylinder, concentric with the boiler, as shown in the cross section, fig. 2, Plate XCII. The fire box is open at the bottom, and has a circular opening cut in the front side, of the same size as

the boiler and corresponding to it; the boiler being fastened to it by means of angle iron *cc*, (Plate XC.,) as shown in the section, half size, in fig. 6; the angle iron *A* is bent round the boiler at the place of its junction with the fire-box, and riveted to the plates *B* and *C* of the boiler and fire-box. The plates composing the front and back of the fire-box are bent inwards at right angles all round as at *dd*, (Plate XC.,) forming flanches upon which the plates of the sides and top are riveted.

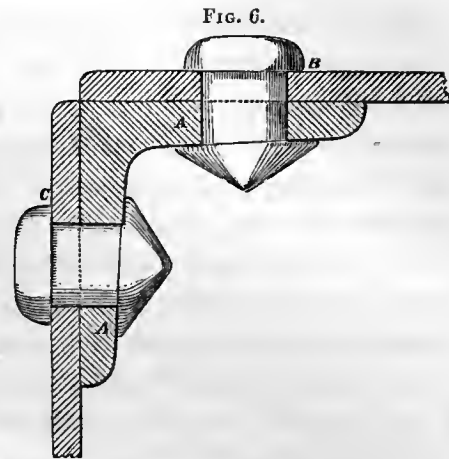

THE INTERNAL FIRE-BOX *CC* is of similar shape to the external, but flat at the top and closed at all sides except the bottom; a clear space of $3\frac{1}{2}$ inches is left all round between it and the external fire-box, and on the side next to the boiler the space is 4 inches. The internal fire-box is made of copper plates seven-sixteenths of an inch thick, except the side next the boiler, which is seven-eighths of an inch thick, but all of the plate except the circular portion opposite to the boiler is beaten down until it is only seven-sixteenths of an inch thick, the same as the rest. The roof and sides of the box are formed of one plate, as shown in the section fig. 2, Plate XCII., and another plate forms the back, corresponding to that in the front next the boiler; the front and back plates are turned inwards at the edges like those of the external fire-box, and the other plate fixed to them by three-quarter inch copper rivets. The internal fire-box is fastened at the bottom to the external, by setting the plates out until they touch the outer plates, and riveting them together with copper rivets, as shown at *ff* (Plates XC. and XCII.). The plates are sometimes set out only so as to approach the outer plates within $1\frac{1}{2}$ inch, and a copper ring inserted between them, the rivets being put through the ring, and the joint thoroughly closed by hammering it up underneath; but it is generally found that the joint keeps watertight best when made by setting the plates together and riveting them: a double row of rivets is generally used. An oval hole, 14 inches wide and 12 inches high, is cut in the back plate of both fire-boxes for the fire-door *gg* (Plate XC., and fig. 1, Plate XCII.); the plate of the internal fire-box is set out all round it to meet the outer plate, and the two are fixed together by a row of copper rivets; a copper ring is sometimes inserted between the plates here, as well as in the joint at the bottom of the fire-box. The fire-door consists of two wrought iron plates connected together by rivets, leaving a space of half an inch between them; this protects the outer plate from the fire, and prevents it from getting too hot.

The fire-grate *DD* is fixed 3 feet 2 inches below the roof of the fire-box, and 9 inches above the bottom, and is composed of separate loose bars of wrought iron, $2\frac{1}{2}$ inches deep in the middle, and 1 inch thick at the upper side, tapering downwards to allow more free ingress for the air; the fire-bars are bent down at the ends and drop into holes in a square ring of iron, *hh*, which runs round the fire-box at a little distance from the side, and is supported by a piece of angle iron, *ii*, bolted to the front and back plates of the fire-box. The fire-bars are made separate and moveable in order that they may be easily replaced when worn out, which happens very frequently from the great heat to which they are exposed; and also for the facility with which the fire can be extinguished in case danger should be apprehended from any accident; for by lifting them out of the holes with a bent rod, kept for the purpose, they can be dropped, together with the whole of the fire, upon the road: this is indeed the manner in which the fire is extinguished when the engine has done working. An ash-pan is fixed under the fire-box in some engines, made of sheet-iron, of the same shape as the external fire-box, and open only in front; it serves to catch the cinders and prevent their falling on the road, but is rather inconvenient when the fire has to be let out.

The boiler being cylindrical has an equal strain in all directions from the pressure of the steam; but as the fire-boxes are flat on all sides except the top of the external one, they would have a tendency to be separated from each other by the pressure of the steam if they had not some support. For this purpose they are connected together by a number of three-quarter inch copper bolts, *kk*, which are screwed along their whole length and are passed through holes in both plates, tapped to receive them, and then riveted over at the ends for additional security; these copper bolts are screwed in about 4 inches apart all over the sides and back of the internal fire-box and that portion of the front that is below the boiler. As the roof of the internal fire-box only requires support, that of the external one being cylindrical, it is strengthened by six wrought iron ribs, *ll*, (Plates XC. and XCII.,) placed parallel to each other and longitudinally upon the roof, and fastened to it by bolts screwed through the roof-plate, and having, in addition, a nut screwed on at the under side; the ribs are $1\frac{1}{4}$ inch thick, and increased at the bolt holes, and $2\frac{1}{2}$ inches deep at the middle, where the strain is greatest. The ribs *ll*, are cut away on the underside between each of the bolts, so as to touch the roof-plate only where the bolts pass through them, in order that there may be as little mass of metal as possible exposed to the immediate action of the fire; for when a considerable thickness of metal is interposed between the water in the boiler and the fire, the heat cannot be absorbed by the water with such rapidity as it is supplied, and the metal becomes in consequence greatly heated, and is rapidly destroyed. The durability of the internal

fire-box depends very much on the care of the engine man ; with proper use it will last several years, but if the water is allowed to get too low in the boiler, so as to have but little depth over the roof, the plate will be liable to get frequently uncovered, from the motion of the engine, and be rapidly destroyed. To prevent this accident a small plug of lead, *m*, (Plate XC. and XCII.,) is put through a hole in the centre of the roof of the fire-box, and riveted over on both sides ; when the water gets so low as to uncover this plug it is melted by the heat, and the steam, rushing into the fire-box, extinguishes the fire. The internal fire-box is made sometimes of wrought iron, and is generally found to last nearly as long as a copper one ; the iron fire-box costs considerably less, but requires more care in using and is very liable to crack and become leaky at the joints.

TUBES.—The communication between the fire-box and the chimney is made by a number of tubes, *E E*, (Plate XC. and XCII.,) which are fixed water-tight at one end into the front plate of the fire-box *e*, and at the other into the plate *n*, (Plate XC.,) which closes the front end of the boiler ; the tube plate, *e*, of the fire-box being made thicker where the tubes are inserted, to allow for its being weakened by the holes cut in it. There are 124 of these tubes ; they are $1\frac{1}{2}$ inch in diameter outside, and a space of three quarters of an inch is left between them. They are made

of the best rolled brass, one thirteenth of an inch thick, (called No. 13. wire-gauge ;) the edges of the brass are properly chamfered and lapped over each other and soldered together, the solder being applied inside ; the tubes are then drawn through a circular steel die to make them truly cylindrical. The holes to receive them in the tube plates *e* and *n*, (Plate XC.,) are bored quite cylindrical so as to fit the tubes exactly, which are just long enough to come to the outside of both plates : the ends of the tubes are then fixed by driving in a steel hoop or ferrule, made slightly conical, as shewn in Fig. 7 ; which is a section full size of the tube *AA*, the plate of the fire-box *BB* in which it is inserted, and the ferrule *CC* ; the ferrule is a little larger than the tube, so that, when driven in, it compresses the tube very forcibly against the sides of the hole, and makes the joint completely watertight. The ferrules are sometimes made of wrought iron, but they generally do not last out the tube in that case, and require replacing by new ones before the tubes are worn out ; the steel ferrules are better, as they last nearly twice as long. When a tube or a ferrule requires taking out, the ferrule has to be

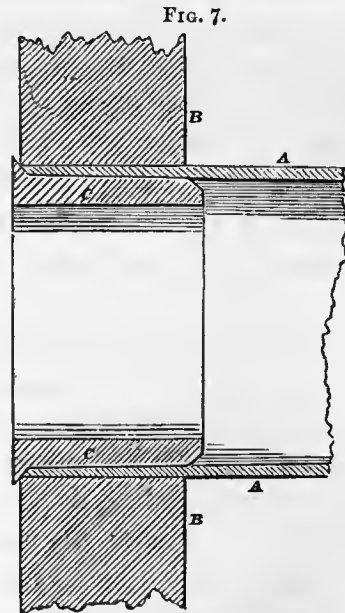

When a tube or a ferrule requires taking out, the ferrule has to be

cut quite through with a chisel and then turned inwards so as to detach it from the tube, which can then be driven out.

By causing all the flame and heated air to pass through a great number of small tubes surrounded by the water, a very great and rapid means of heating the water is obtained, as a very large heated surface is thus exposed to the water. The first locomotive engines had merely a large flue passing from the fireplace to the chimney; it was bent round at the end and returned again to the back, the chimney being placed at the same end as the fireplace; the fire was contained in the commencement of the flue, which was made larger for the purpose. This is the general principle of the construction of the boilers for stationary engines where the size and weight of the boiler are not of so much importance, and the flues can be made large enough to get a sufficient area of heated surface in contact with the water. But as in a locomotive engine all the machinery has to be moved at a great velocity, the size and weight of the boiler are obliged to be diminished very much, and some other means has to be adopted to obtain the requisite heating surface.

The Rocket engine made by Mr. R. Stephenson, which was the engine that gained the prize for the best locomotive, at the opening of the Liverpool and Manchester Railway in 1829, was the first engine made with tubes in this country*.

The former locomotives with only a flue through the boiler, had never been able to travel faster than about eight miles an hour, as they had not sufficient heating surface in the boiler to generate the steam for supplying the cylinders more rapidly; the speed attainable by a locomotive being limited only by the quantity of steam that can be generated in a given time. The introduction of tubes into the boiler is one of the greatest improvements that has been made in the construction of locomotives, and was the cause of the superiority of the Rocket engine to those that competed with it, and to all the former engines. The velocity it attained at the competition trial was 29 miles an hour, and the average $14\frac{1}{4}$ miles an hour.

The tubes of the Rocket engine were 3 inches in diameter, and only twenty-four in number; in the engines made subsequently, the size was reduced and the number of them doubled and trebled, by which means the heating surface was very much increased and with it the power of the engine. The smaller the tubes are, the greater is the heating surface obtained, as small circles have a much larger circumference in proportion to their area than large ones; but when the tubes are diminished in size, the total area of passage through them from the fire-box to the chimney is also diminished; and consequently if the diameter of the tubes were much

* It appears that the merit of the first invention of a boiler with tubes is due to a French engineer, M. Seguin, who had a patent for it in 1828; although the application of the principle in the Rocket engine was undoubtedly an independent invention.

diminished the draught of the fire would be checked from the passage to the chimney being too small. The heating power of the boiler would thus be injured, although the amount of heating surface exposed to the water was increased, and the abstraction of the heat from the hot air rendered more perfect. The exact size of tubes which produce the best total effect is to be discovered only by experience, and has not yet been completely decided.

Small tubes have another disadvantage in being liable to choke up very much with the particles of coke which are carried through them in great quantities by the force of the draught, and in their retaining the cinders which are continually blown into them, but which pass clear through larger tubes. The small tubes are often contracted one third in diameter by the deposit of coke on their inner surface during the day's work, and they have to be cleared out every night by passing a rod through them; the larger tubes never require clearing out.

The tubes were at first made of copper, and some have been of wrought iron, but the copper tubes were found to wear very fast, generally lasting only three or four months, and were a great source of expense from the necessity of frequently renewing them. Brass tubes were first tried in the locomotives on the Liverpool and Manchester Railway in 1833, at the suggestion of Mr. Dixon, the resident engineer, and were found to be very much superior; they are now universally used for locomotives. Brass tubes, of the dimensions mentioned above, last about two years, being six or eight times as long as copper tubes of the same dimensions. This increase of durability appears partly caused by their greater hardness, as it has been observed that the soldered joint, which is made with harder brass, wears less than the other parts; but the whole cause has not yet been satisfactorily ascertained. The tubes are much worn by the friction of the cinders that are blown through them by the force of the draught; but it is very probable that their wear is principally caused by chemical or thermo-electric action. The tubes in the middle and about the fourth row from the bottom are worn out the first, and it is only the ends next the fire-box that are destroyed.

When the tubes become very thin they are crushed inwards by the force of the steam, and the water is blown out at the ends of the tube into the fire; when the tubes are getting old, this frequently takes place whilst an engine is running, and it is stopped by the accident. A plug of hard wood is driven into each end of the burst tube, which is preserved from being burnt by the contact of the water inside the tube, and the engine runs on again. When several of the tubes have burst and been plugged up, they are taken out and replaced by new ones; and if the engine is required to be in constant use, a complete set of new tubes is soon required to avoid the liability of delays from the bursting of the tubes; they weigh about 16lbs. when new,

and lose about $6\frac{1}{2}$ lbs. in the time they are in use. The cost of both the brass and of the copper tubes is about £1 each, and this makes the expense of repairing an engine very considerable when a complete set of new tubes is required. The tubes being fixed firmly into both ends of the boiler, serve to support and strengthen them; but for an additional support to the upper part, six wrought iron rods, *o o*, (Plates XC. and XCII.,) are placed above the internal fire-box, by the side of each other and longitudinally in the boiler; and the ends are attached by a pin to a piece of wrought iron, called T iron, riveted on to the end plate of the boiler and to the back plate of the fire-box.

THE SMOKE-BOX FF, is 4 feet wide, like the fire-box, and 2 feet long, and is closed on all sides; the back of it is formed by the wrought iron plate *n*, half an inch thick, closing the end of the boiler to which it is attached by means of a piece of angle iron riveted to both, like the similar joint at the fire-box. The rest of the smoke-box is made of quarter inch iron plate, the front and back plates being bent in round the edge, and the other plates riveted to them as in the fire-box, except the front plate, which is fixed by screw bolts and nuts, because it is required occasionally to take it off.

Upon the smoke-box is fixed the chimney G, (Plates LXXXIX., XC. and XCII.); it is 15 inches in diameter, and is made of one eighth inch iron plates, riveted together and bound round by hoops, as shewn in the section; the top is made funnel-shaped to give more free egress to the hot air, and the bottom has a piece of plate riveted to it, forming a flanch all round, by means of which the chimney is bolted down upon the smoke-box.

In the lower part of the smoke-box are fixed the two cylinders HH, where the steam is used and motion produced; these will be described afterwards. The steam, when it has been used in the cylinder and has performed its work, is no longer wanted, and is let out into the air by the pipe *p*, (Plates XC. and XCII.)

The tubes open into the upper part of the smoke-box, and the hot air passes from them up the chimney; no smoke is produced, except at first lighting the fire, as the fuel used is coke, which does not cause any smoke in burning, but only a light dust. The height of the chimney is obliged to be small, as it can never exceed 14 feet height from the rails; so that the draught produced by it is not at all sufficient to urge the fire to the intense degree of ignition that is necessary to produce steam at the pressure and in the quantity that is required, and some other more powerful means has, therefore, to be adopted to produce the draught. This is done by making the waste steam issue through the pipe *pp*, (Plates XC., XCI., and XCII.,) called the blast pipe, which is directed up into the centre of the chimney, and is gradually contracted throughout its length to make the steam rush out with more force; this pipe is made of copper one eighth of an inch thick, and is $3\frac{3}{4}$ inches in diameter

inside at the bottom where it joins on to the cylinders, and tapers to $2\frac{1}{2}$ inches at the top.

The waste steam rushes out of the pipe with great force up the chimney, carrying the air with it, and causing a very powerful draught through the tubes and the fire; a whole cylinder full of steam is let out at each stroke, and the two cylinders deliver their waste steam alternately, so that when the engine is running fast an almost constant current of steam in the chimney is produced, and the interval between the blasts can scarcely be perceived. By this method the fire is not blown, as is usual, by forcing air into it, but by extracting the air from the flues and drawing air through the fire. In the first locomotives no means were used for increasing the draught of the chimney, and their power of generating steam was consequently very limited; the introduction of the steam blast for urging the fire, and of the tubes for conveying the heated air through the water, are the principal causes of the great power of the present locomotives.

There is, however, a considerable loss of power attending the use of the blast-pipe, from the obstruction it causes to the egress of the waste steam; for the waste steam opposes the action of the steam in the cylinders, and should be allowed to escape freely that its pressure might be as small as possible. This causes the greater economy of working in the large stationary and marine engines, where the waste steam is condensed and its opposing pressure is reduced almost to nothing: but in a locomotive engine, on the contrary, its average resistance is not less than 6lbs. on the square inch; and when running very fast, and the issue of waste steam is almost continuous, the whole loss of power amounts to nearly half that of the engine. But the draught must be obtained by an expenditure of some of the power of the engine, whatever means may be employed to produce it; and the plan of producing it by the blast of waste steam is the best, as no power is wasted upon working any machinery for the purpose, and it has the advantage of great simplicity in its application. In some locomotive engines, made by Messrs. Braithwaite and Ericsson, a revolving fan-wheel, worked by the engine, has been used to perform the same operation of drawing the air from the flues; and in the "Novelty," by the same makers,—one of the engines that competed for the prize on the Liverpool and Manchester Railway,—air was forced into the fire-box, but that plan was afterwards abandoned from its being found not so advantageous.

The force of the draught produced by the steam-blast is so great that cinders are drawn through the tubes and even thrown red hot out of the top of the chimney; sparks are also emitted occasionally, and have sometimes caused accidents. To prevent the cinders and sparks from getting out of the chimney, a wire sieve is often fixed on the top of the chimney, but this has a disadvantage in impeding the draught

and the exit of the waste steam very considerably; though it is made convex and larger than the chimney, so as to have a larger surface, and to impede the passage as little as possible. The sieve is, however, but an imperfect remedy, for the cinders are thrown against the sieve with so much force, that the meshes are soon destroyed. A sieve has been tried placed at the bottom of the chimney, so that the blast pipe ran through it, and in this position it afforded much less obstruction to the draught than when placed at the top of the chimney; for the blast of steam which produces the draught being entirely above it, would not be impeded, and the loss of power from impeding the exit of the waste steam would also be avoided. But the plan was afterwards abandoned, as the sieve was found to be destroyed so quickly as to require constant repair, from being exposed immediately to the air, and to all the cinders, that are drawn through the holes, striking against the front plate of the smoke-box, and rebounding upwards towards the chimney.

DAMPER.—I I, (Plates LXXXIX., XC., and XCII.,) is a damper placed in the chimney just below the top of the blast pipe, consisting of a thin iron plate fitting the chimney closely, with a hole cut in its centre just large enough to allow the blast pipe to pass through. A flat bar is bolted on to it to serve as a spindle, and fixed a little out of the centre, in order to clear the blast pipe when the damper is elevated, as shewn in Plate XC. This spindle is made round at each end, and turns in bosses riveted to the outside of the chimney; one end passes quite through, and has a short lever, *q*, fixed on to it; the diameter of this end of the spindle is of the same size as the width of the flat part, to allow of the spindle being put into its place through the hole in the boss in which it turns, before it is attached to the damper in the chimney. A long rod, *r r*, (Plates LXXXIX. and XC.,) is attached to the lever, *q*, on the spindle, and reaches to the top of the fire-box, terminating in a handle, and resting in an iron fork, *s*, fixed in the top of the fire-box, in which either of two notches made in the rod can catch; so as to hold the damper either vertical, as in Plate XC., or in a horizontal position, closing up the chimney, as shewn by the dotted lines across the chimney in Plate XC.

The damper is used to check the draught when a less intense action of the fire is required, such as when the engine is standing still or running down hill, and very little power is wanted; it causes very little obstruction to the exit of the waste steam, as the blast pipe passes through it. It is a curious circumstance, that whilst the damper is raised, the waste steam passes out of the chimney in an invisible state unless the atmosphere is nearly saturated with moisture, from the increased capacity of the hot air for moisture enabling it to absorb the steam in the chimney. A slight change in the dryness of the atmosphere, or the temperature of the engine fire, causes the steam to be visible; and hence it is always visible in winter,

and in summer is invisible only when the hygrometer is high; its appearance is, indeed, a tolerably correct indication of the hygrometric state of the atmosphere. When the damper is lowered, the steam instantly becomes visible from the want of hot air to absorb it, and it then issues from the chimney in dense white volumes.

SMOKE-BOX DOORS.—A large door, *tt*, (Plates XC. and XCII.,) is made in the front plate of the smoke-box, for the purpose of affording access to the cylinders and the tubes; there is a ledge fixed inside round the opening, against which the door is closely pressed by four finger nuts, put upon screws fixed in the smoke-box plate, and passing through projecting lugs upon the door. There is also a small door, *u*, near the bottom of the smoke-box, for the purpose of clearing out the cinders and ashes that collect in it: both doors have to fit closely, that no air may enter at them to impair the draught.

FEED PUMPS.—The boiler is supplied with water by the two feed pumps *KK*, which are worked by the engine; their construction will be explained afterwards. One of them is sufficient to supply the necessary quantity of water for the boiler, and the other is thrown out of action; but two are furnished in the engine, in order that if one should fail from any accident, the other may take its place without any delay being caused. On forcing the water into the boiler, it checks the generation of steam by its coldness, and the effect of the engine is also diminished in consequence of the power required to work the pump; for this reason the action of the feed-pump is generally suspended when the engine is ascending an inclination, and requires its greatest power, and the supply of water is made up by working both pumps on a succeeding level or descent:—this is an additional advantage in having duplicate pumps. A small cock, called the *pet cock*, is fixed in the pipe leading to the boiler from each pump, and a long handle, *v*, is fixed to it, extending to within reach of the engine-man, standing behind the engine; these cocks are opened occasionally to ascertain whether the pumps are working properly, when a stream of water should be forced out at each stroke*.

* The *pet cock* was invented by Mr. George Stephenson, to obviate what was for some time an incurable defect in the feed pumps of locomotive engines,—the pumps could not be made to keep in action, as they were fixed close to the boiler, and hot water entered from the leaking of the valves, causing them to be filled with steam instead of water at each stroke; thus preventing them from forcing any water into the boiler, which could, therefore, be used only for a short time, whilst the water in it would last, the boiler having then to be emptied of steam and refilled. The cause of this stoppage of the action was at length discovered, and the *pet cock* applied, by opening which the steam in the pump was let out, and the action renewed; the name was given to it playfully, from its petting or coaxing, as it were, the pump to do its duty. It is not now required for this purpose, as the pump is separated from the boiler by a long tube with a valve at each end, and the hot water cannot get into it.

GAUGES.—L L, (Plates XC. and XCII.,) is a glass gauge for showing the height of the water in the boiler; it is shewn detached in fig. 8, which is a section through the centre of it to a scale of $2\frac{1}{4}$ inches to a foot, or three times the size of the engraving. The gauge consists of a strong glass tube, *A*, fig. 8, about three quarters of an inch diameter outside, fitted into a brass socket, *B B*, at top and bottom, the joints being made steam-tight by hemp packing, put round the glass, and compressed against it by the glands *C C*, which are screwed in round the glass. From each of the socket-pieces *B*, a tube, *D*, proceeds with a cock in it and a screw on the end for fixing it into the fire-box; and the piece *E*, containing another cock, is screwed into the lower piece, and the plug *F* into the upper piece, affording the means of putting the glass tube down into its place. When the two cocks in *D D* are opened, the water of the boiler rises in the glass tube to the same height that it is in the boiler, the upper part of the glass being filled with steam, the height of the water in it shewing always the level of the water in the boiler; the cocks are for the purpose of stopping the communication, when required, from the gauge being out of order or otherwise. The cock in the piece *D* is for the purpose of clearing out the gauge, by allowing a stream of water to run through it; and it is often necessary to open it when examining the gauge, in order to get rid of the bubbles of steam formed by the rapid ebullition of the water, which sometimes render it difficult to ascertain the precise height of the water. The difficulty is also increased by the motion of the engine producing oscillation in the water; but the disturbing effect is much diminished by choking the tube, or making the communication with the boiler through the tube *D* very small, so as to impede the motion of the water in the tubes. A small plug, *G*, is screwed in opposite each tube, *D*, to afford the means of clearing out the tubes *D*, by passing a wire through them when the plugs *G* are taken out.

To afford an additional means of ascertaining the height of the water in the boiler, two gauge cocks, *M M*, are fixed in the side of the fire-box, one being four inches above the other, and the lower one, one inch above the top of the internal firebox. The boiler is generally filled at starting, until the water runs out at the upper cock; and during working the water level is kept between the two cocks, and often up to the upper one. The cocks are opened occasionally to try the level, and if steam should ever be found to blow out at the lower cock, showing that there is not more than one inch of water over the roof of the internal fire-box, instant attention has to be paid to the feed-pumps, and the fire damped if necessary, to

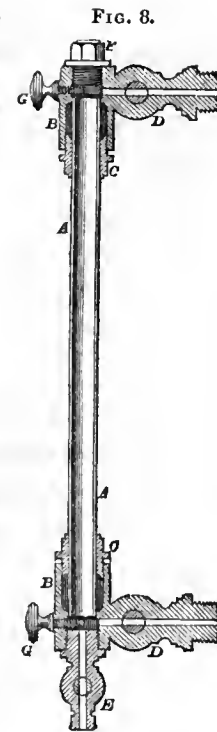

prevent the roof of the fire-box being uncovered and getting burnt. The glass tube is, however, the more certain guide, being less affected by the oscillations of the water than the gauge cocks.

THE LEAD PLUG, *m*, (Plates XC. and XCII.,) described before, is an additional security against any accident arising from the water being suffered to get too low in the boiler.

SAFETY VALVES.—The pressure of steam in the boiler is regulated by the safety valve *N*, (Plates LXXXIX., XC., and XCII.,) the construction of which is shewn in fig. 9 and 10, drawn to a scale of $2\frac{1}{4}$ inches to a foot, or three times the size of the engraving. Fig. 9, is a longitudinal section through the valve, and fig. 10, a plan of the valve-seat with the valve removed. The valve *A* is made of brass; it is conical round the edge, or mitred at an angle of 45° , and has a spindle or stalk, *B*, cast on it in the middle. The seat *C* of the valve is also of brass, and is cast with a flange at the bottom, to bolt it on to the boiler; and the valve is ground into the upper part, so as to fit it steam-tight. The opening in the valve seat, *C*, is $2\frac{1}{2}$ inches diameter, and across it is cast a thin piece *D*, extending to the bottom, and having a longitudinal hole through it, in which the spindle *B* of the valve works; this is to hold the valve steady when it is raised, and to guide it into its seat again. A projecting lug, *E*, is cast on the valve seat, in which is fixed the standard, *F*; this is forked at the top, and receives the end of the lever *G*, which turns in it upon a centre pin; a rod, *H*, is jointed to the lever by another pin, at 3 inches from the former one, and bears directly upon the valve.

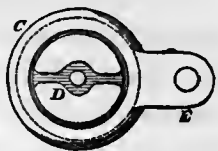
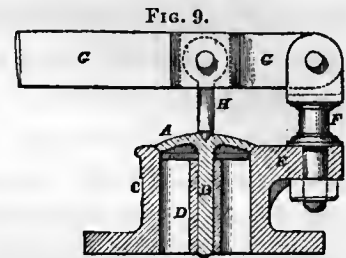

FIG. 10.

At the other end of the lever, and at a length of 3 feet from the fulcrum, is attached by a finger nut, the rod of a common spring balance, *w*, (Plates LXXXIX. and XCII.,) the bottom of which is fixed on to the fire-box; this spring balance is screwed up by the finger nut on the valve lever, until the required pressure on the valve is produced, which is generally 50 lbs. on the square inch above the atmosphere; and the valve, on rising to let out the surplus steam, has to raise the spring balance, which acts upon it with twelve times the leverage.

In stationary engines, the safety valve is kept down by a weight hanging on the lever, and shifted to different positions to alter the pressure on the valve; but in a locomotive engine a weight could not be used, because the motion of the engine would cause it to jolt up and down, and the valve would be continually letting off steam. There is one disadvantage attending the use of the spring balance that the other plan is free from; namely, that any opening of the valve by raising the lever,

compresses the spring in the balance more, and increases the pressure upon the valve, so that the free egress of the surplus steam is checked, and the pressure of the steam is allowed to become greater than that indicated by the balance when the valve is shut; the longer the lever is, the greater is this difference of pressure, and it is sometimes as much as 10 lbs. per square inch.

In observing the pressure on the safety valve, allowance must also be made for the effect of the mitre, or conical part of the valve; for when it is raised, the steam acts on the conical part as well as on the bottom of the valve, and has therefore a greater power in lifting the valve; and this diminution of the pressure on the valve varies with the extent of the mitre and with the degree that the valve is opened.

These different circumstances render the safety valve but an imperfect means of ascertaining the pressure of the steam in the boiler. In stationary engines, which are generally worked at a much lower pressure, a mercurial gauge is often used to indicate the pressure of the steam; but this instrument cannot be used in a locomotive, as a tube of great size, and not less than twelve feet high would be required; it has, however, been used as a means of testing the accuracy of the indications of the safety valve by a temporary connection with the engine.

O, (Plates LXXXIX. and XC.,) is the lock-up safety valve, enclosed in a case, to prevent access to it so as to increase the pressure to a dangerous degree. The valve is exactly similar in construction to the other safety valve, but instead of being held down by a lever and spring balance, several small elliptical springs, *x x*, (Plate XC.,) about six inches long, are placed one above another and over the valve, and pressed down by a screw at the top in the frame *y y*, fixed into the valve seat. By turning this screw, the pressure on the valve can be adjusted to any required degree; and when the case is fixed on, the valve is effectually protected from having the pressure altered. The lock-up valve is loaded rather more heavily than the ordinary working pressure, 50 lbs.; so that it does not blow except when the pressure has exceeded that limit, as in performing work requiring more power than usual.

A large spiral spring is used in some engines to press upon the valve, being fixed in a similar manner to the elliptical springs; it is rather more compact, but is not quite so free in its action, as the pressure increases more rapidly on the using of the valve.

MAN HOLE.—P, (Plates LXXXIX. and XC.) is a circular opening into the boiler, called the man hole; it is 16 inches in diameter, and surrounded by a ring, *z*, (Plate XC.,) bolted on to the boiler, having a flanch at the top for fixing on the cover. This opening is large enough for a man to enter, and affords access to the interior of the boiler for making repairs in it, or for cleaning it out.

MUD HOLES.—These are two small openings, Q Q, in both sides of the fire-box at the bottom, closed by plates bolted upon the outside, and are for the purpose of

cleaning out the fire-box and removing the sediment that is deposited from the water. Two mud holes, at opposite corners of the fire-box, are usually opened twice a week, and the deposit washed out by directing a stream of water into them; each pair of opposite holes being opened alternately. The boiler does not often require cleaning, but it is occasionally washed out by putting the water hose in at the man hole, and washing all the sediment into the fire-box; this is found to be quite sufficient to keep it clean.

BLOW-OFF COCKS.—R R are two cocks, one inch in diameter, fixed one in each side of the fire-box, close to the bottom, for the purpose of emptying the boiler; this is called *blowing off*, as it is done just after the engine has left work, and the water is blown out with great force by the pressure of the steam. This blowing off serves to cleanse the boiler, and the whole water has to be thus emptied out two or three times a week when the engine is in full work, as it gets foul after remaining in the boiler for some time.

FIRE AND HEATING POWER.—The fuel used is coke, and is that most generally used in locomotives; coal was employed in the first ones, and is now made use of on railways in the collieries and where passengers are not carried; but on the large public railways it is inadmissible on account of the smoke that is produced. Coke has an advantage over coal in being very light in substance and not caking together, but allowing the draught of air to pass freely through the fire; it is also capable of attaining a very intense degree of ignition; but its lightness renders it more liable to be drawn through the tubes by the draught, and the fine dust or ashes, produced by its combustion, is very annoying to outside passengers. The coke used is of the best quality; and the operation of coking the coal is performed only with a view to the abstraction of the volatile parts, as the hydrogen, and the losing as little as possible of the carbon; gas coke or the remains of the coal used in gas works is very inferior, being overburnt and having lost a good deal of its carbon to form the gas, carburetted hydrogen; it also contains a good deal of sulphur, which is very injurious to the metal of the boilers; this causes also the principal objection to the use of coal. The coke used in the locomotives on the London and Birmingham Railway is made upon the works, and is very nearly pure carbon. Welsh stone coal or anthracite has been also tried; it produces no smoke or flame, being almost pure carbon, like coke; but it appears to be not suited to locomotives, from its density and flying into small pieces, so as to form a close mass on the fire-grate, and not allow a sufficiently free passage for the air through the fire.

The fuel is carried in the tender behind the engine and immediately contiguous to the fire-door, so that it can be readily shovelled into the fire when required; it is supplied on an average in quantities of about half a cwt. at intervals of from five to ten minutes. The heating the water in the boiler and getting up the steam takes about

an hour and three quarters on an average, and requires the consumption of about one and a half or two cwt. of coke; in some places the boiler and tender are supplied with hot water by means of a stationary boiler, in order to expedite the getting up of the steam, and also as a means of economy.

The area of the fire-grate is $9\frac{1}{2}$ square feet; it is 18 inches below the bottom of the lowest tubes, and the space for the fire when quite filled up to the tubes is 14 cubic feet, and holds about $2\frac{1}{2}$ cwt. of coke; but the fire-box is not always filled so full as this, and usually contains about one and a half or two cwt.

The surface of water exposed to the heat directly radiated from the fire is the whole surface of the internal fire-box, deducting the fire-door and the tubes, and is equal to 50 square feet; and that exposed to the current of hot air, or conducted heat, is the interior surface of the tubes, and is equal to 432 square feet. The surface exposed to radiated heat is considerably more efficacious in generating steam than that exposed to conducted heat only, as the supply of heat is more copious, and the proportion was found to be about three times in an experiment tried by Mr. Stephenson, which is the only one that has been made upon the subject; the experiment was made with an old engine and the proportion may be somewhat different in the modern engines.

The area of passage for the heated air from the fire-box to the chimney is the sectional area of all the tubes inside the ferrules; the ferrules are three eighths of an inch less than the outside of the tubes, and are therefore an inch and a quarter in diameter inside; and the sectional area of them all, (124 in number,) is 1.06 square feet. The area of the passage through the chimney is rather more, or 1.23 feet.

In the Rocket engine the area of passage through the tubes was .90 square feet or nearly the same as in this engine, though the fire-grate was but half the size; but the heating surface of the tubes was only one third, from the large size and small number of the tubes; the heating surface of the fire-box was also only three quarters of that of the present engine.

In the old engines before the Rocket, the area of passage through the flue was two and a half times the size, but the heating surface was only one thirteenth of that in the present engine; the fire-box had also only one fifth of the heating surface; the fire-grate was three quarters of the size.

THE CYLINDERS AND THE MANNER OF USING THE STEAM.

STEAM PIPE.—SS, (Plates XC. and XCII.,) is the steam pipe for conveying the steam from the boiler to the cylinder where it is to be used; it is made of copper three sixteenths of an inch thick, and the part within the boiler is 5 inches' diameter inside; it passes through the tube plate of the smoke-box and is bolted to it by a flanch. The pipe then divides into two smaller ones, $3\frac{1}{2}$ inches in diameter, which pass down

on each side of the smoke-box to the cylinders, as shown in Plate XCII. Fig. 4; they are turned on one side in order to keep them clear of the tubes, so as to allow access to all the tubes, that they may be taken out when necessary through the smoke-box door. It is also necessary to protect the steam pipes from the immediate action of the hot air issuing from the tubes, which is nearly hot enough to melt copper. In the first engines, the steam pipes were brought straight down to the cylinders across the ends of the tubes, but they were found to be very rapidly destroyed.

The area of the large steam pipe is 19·6 square inches, and is equal to the areas of both the small ones, which are 9·6 square inches each.

The other end of the steam pipe is connected to the box *a'*, (Plate XC.,) by means of the stuffing box *b'*, containing packing made of loose spun hemp, called gasket, compressed against the steam pipe by the brass gland *c'*, which is bolted to a flanch on the stuffing box *b'*. This stuffing box is necessary because iron expands by heat only two thirds as much as copper, so that when the boiler and its contents are heated, the wrought iron increases in length less than the copper pipe, and the pipe would be very much strained if it were rigidly fixed at both ends, and the joint would soon become defective by the repetition of the action; but the stuffing-box allows the end of the pipe to slide through it, and still keeps the joint steam-tight, preventing all injurious action*.

The steam enters through the funnel-shaped copper pipe *d'*, (Plate XC.,) which is fixed upon the top of the box *a'*, and this pipe rises nearly to the top of the steam dome T, which is made of brass, cast three eighths of an inch thick, and is 15 inches in diameter and 2 feet high, and bolted down by a flanch on to the fire-box. The object of this steam dome, and of carrying the steam pipe up to the top of it, is to obtain the steam as pure and dry as possible, by taking it at a distance from the water; because from the great agitation of the water in the boiler, and the rapid emission of the steam to the cylinders, some of the water gets mixed up with the steam in a finely divided state, and is liable to pass over with the steam into the cylinders. This effect is called *priming*, and is very injurious when it takes place to any extent, for all the water carried over into the cylinder is wasted and occupies the place of steam, and thus diminishes the power of the engine; but principally because it accumulates in the cylinder and sometimes remains in it, being unable to escape with the waste steam; and in that case, from being so incompressible, it causes the breaking of some part of the engine. By carrying the steam pipe up into the dome, the quantity of water taken with the steam is very much diminished, as it has time to separate, and the expanded end of the steam pipe nearly filling the dome, serves to catch the water and prevent its entering the steam pipe.

* The brass tubes of the boiler are liable to the same action, but as they are small and very firmly fixed at the ends, the expansion is immaterial, the tubes allowing for it by bending slightly.

The priming is much increased when the water in the boiler is not clean or pure ; and an engine that does not prime perceptibly with good water may prime very much if supplied with impure or hard water. When priming, the water is thrown out in a shower from the chimney at each blast, and the power of the engine is very much impaired, as the violence of the ebullition of the water is thereby greatly increased. The prevention of the priming was found to be a very great difficulty in the first locomotives, and several contrivances were made use of for the purpose ; such as making the steam pass through a plate pierced with holes before entering the steam pipe, or dividing the dome by a plate over which the steam had to pass to the steam pipe. But it has been observed that the priming has been gradually diminished by increasing the steam room or space in the boiler occupied only by steam ; for this renders the generating of the steam more uniform, as the abstraction of the successive cylinders full of steam is less felt and causes less agitation when the total quantity of steam is greater. In the first locomotives very little steam room was afforded, but in this engine the steam room is generally about 44 cubic feet, and there is no perceptible priming under ordinary circumstances.

REGULATOR.—In the box *a'* (Plates XC. and XCII.,) is placed the regulator *e'*, extending across the box so that all the steam must pass through it before it can enter the steam pipe *S* ; and by means of this the steam is either shut off or allowed to enter the steam pipe in greater or less quantities. The regulator is shewn in figs. 11, 12, and 13, to a scale of double the size of the engravings, or $1\frac{1}{2}$ inch to a foot. The box is made of cast iron half an inch thick, and has a plate, *A*, extending across it, with two openings *BB*, of nearly a quadrant each ; the diameter of the opening is $8\frac{1}{2}$ inches, and that of the solid part in the centre separating them, 2 inches. The brass plate *C*, placed against this plate, fits exactly the space between the openings *BB*, and if turned round and placed over the openings would project beyond or overlap them three quarters of an inch on each side, as they are three quarters of an inch smaller than a complete quadrant. The spindle *D* passes through a boss in the centre of the plate *C*, turning at its end in a socket in the plate *A*, but without touching the bottom of the socket, and a small pin is fixed into the spindle fitting into a notch, *E*, in the centre boss, to enable the spindle to turn round the regulator plate *C*, and yet allow it to be withdrawn a little without drawing the regulator plate away from the other plate. The plates are held together by the pressure of the steam ; and by

FIG. 11.

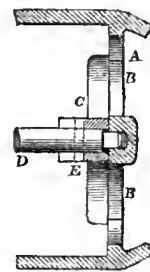

FIG. 12.

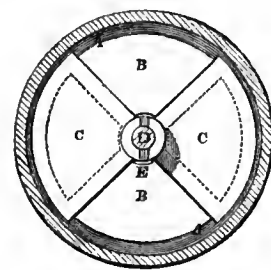
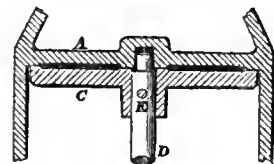

FIG. 13.



forming the connection with the spindle in this manner, they are enabled to keep in close contact, although the position of the spindle should be altered; and the regulator plate is still made to turn with the spindle.

The two plates are ground together, so that when the regulator plate is turned round and covers the openings, the passage is closed completely steam-tight; the under side of the regulator plate, and the solid space between the openings in the other plate, are both hollowed a little in the middle, as shewn in the section through the centre of each, in fig. 13, so that they touch only for a space of three quarters of an inch round the edge. This diminishes the labour of grinding them, as there is so much less surface to grind, and also ensures their fitting round the edges, where alone it is required; for the little steam that will pass through the hollow between the plates when the regulator is partially open, is of no consequence, as it will only slightly increase the quantity of steam passing through.

The other end of the box *a*, (Plate XC.,) is fixed by a flanch to the back plate of the fire-box; and an opening is cut in the plate corresponding to the inside of the box, which is closed by a plate, having the stuffing-box *f'*, fixed on to its inside with its gland *g'*. The spindle of the regulator turns steam-tight in this stuffing-box, a collar on the spindle resting against the end of it; and the handle, *h'*, is fixed on the end of the spindle, moving between two brass arcs, *i'*, (Plate XC., and fig. 1, Plate XCII.,) which are connected together at the ends, and bolted on to the fire-box: these arcs serve as guides for the handle when moved, and stop it at each side. In fig. 1, Plate XC., the regulator is shewn quite open; but if it were made to turn round, it would immediately begin to contract the passage for the steam, and when turned a quarter round, the passage would be completely closed. The motion of the handle is therefore through a quarter of a circle, or half a quadrant on each side of the vertical position. When the handle is put down on the right hand side, the regulator is shut, and when down on the left side, it is full open; and in intermediate positions the regulator is proportionally open, except for the small distance at each end along which it is passing over the overlap. The area of passage through the regulator when full open, is 21.9 square inches, or a little more than the area of the steam pipe, which is 19.6 square inches.

This is the form of regulator that is most frequently used, as it is simple in its construction and not liable to get out of order, and particularly as it is very uniform and regular in its action; and excepting the small overlap, the degree of opening is exactly proportionate to the amount of motion of the handle. Another contrivance that is also used for the purpose, consists of a conical valve like a safety valve, which closes the end of the steam pipe; and is drawn away gradually from its seat, when turned round with the handle, by means of a fixed pin

fitting in a spiral groove on the spindle, similar to a screw; only that the groove makes but a quarter of a turn round the spindle, and is very much inclined to it, so as to cause the valve to be sufficiently drawn back by a quarter turn of the handle. This regulator is very efficient, and acts a little more uniformly than the other, but the friction in it is greater from the spiral motion, and it is more liable than the other to get out of order and stick fast.

STEAM CHESTS.—The steam chests or slide valve boxes U U, (Plates XC., XCI., and fig. 4, Plate XCII.,) are made of cast iron half an inch thick; and are bolted down upon the top of each cylinder, and to the front plate of the smoke box, in which holes are cut of the same size as the steam chests, and closed by cast iron plates termed bonnets bolted on the outside. The steam chests have the two branches of the steam pipe fixed upon them at the back, and opening into them; and a stuffing box, *k'*, is cast upon the end of each, passing through the tube plate *n*, the joints being completely and firmly closed by running melted lead into it all round.

SLIDE VALVES.—In the steam chests are placed the slide valves, V V, shown in section longitudinally and across in Plate XC., and fig. 4, Plate XCII. They are brass boxes $1\frac{1}{2}$ inch deep inside and three eighths of an inch thick, having flanches five eighths of an inch thick all round them at the bottom. The slide valves are made to move backwards and forwards by the spindles *l'*, which have each a cross piece at the end that fits into a notch in the back of the valve; the spindle is generally connected to the valve by means of a rectangular wrought iron frame, called a bridle, dropped over the valve and having the spindle screwed into it. The bridle has an advantage in holding the valve very steady, and yet allowing it to drop through readily as it is worn by friction, and thus keep always in contact with the surface that it slides upon. The valve spindle *l'* moves steam-tight through the stuffing box *k'* at the inner end of the steam chest.

CYLINDERS AND PISTON.—The cylinders, H H, where motion is produced by the pressure of the steam, are made of cast iron, five eighths of an inch thick and 12 inches diameter inside, and are bored out perfectly smooth and cylindrical. A box is cast on the top of each cylinder, running along its whole length and flat on the upper side, containing two hollow rectangular passages *m', n'*, and another passage *o'*, between them; these are separated from each other, and the ends of them are shown coming to the outside and opening into the steam chest at the left cylinder, (Plate XCI.) The two outer passages *m', n'*, are the steam ports; they are eight inches long and one inch wide, and open one into each extremity of the cylinder, for the purpose of conveying steam to and from the cylinders; their area is 8 square inches, or rather less than the area of the steam pipes. The other passage *o'*, is the waste steam port, of the same length, and one inch and a half wide on the face; expanding inside, as shown in Plate XC., occupying all the space between the

steam ports, and passing round the cylinder (as in fig. 4, Plate XCII.) until it clears the steam chest and comes to the outside again opposite to the other cylinder; having gradually assumed a circular form three inches and three quarters in diameter, as shown by the dotted lines in Plate XC. The cross area of this passage is made of such dimensions that although it alters in shape, it is in all parts equal to the area at the end, that of a circle three inches and three quarters diameter or 11 inches area. On the outside of this opening in each cylinder are fixed the two ends of the branching copper pipe p' , of the same diameter, termed a breeches piece, and having the blast pipe P bolted on to it. The piece p' is fixed on to the cylinders by screws put into holes tapped to receive them in the solid metal, as there is no place for nuts. The steam chest is also fixed on to the cylinder at the hinder end in the same manner. The flanches are made rather thicker to allow for being weakened by the holes in them, and those of the copper pipes are three eighths of an inch thick, and made of brass soldered on to the pipe; the pipes are made of one eighth of an inch sheet copper lapped and soldered at the edges. A layer of canvas or of gasket, like that used for packing, covered with red lead and oil, is placed between the flanches of the pipes and under the flanch of the steam chest, and in all other similar joints, in order to make them steam-tight.

The face of the ports that the slide valve moves upon is made quite even and true by a planing machine, and the valve is ground upon the face to make it fit steam-tight; the face is sunk down round the ports beyond that part over which the slide moves, in order to diminish the surface to be planed and ground. The spaces between each of the steam ports and the waste port, called the bars, are one inch wide. A section of the slide valve, quarter size, is shown in fig. 14, where

A and B are the back and front steam ports, C is the waste port, and DD the bars. The width of the slide inside is the same as the ports, as shown in fig. 4 (Plate XCII.); the length E , (fig. 14,) is one-eighth of an inch less than the distance between the ports, and

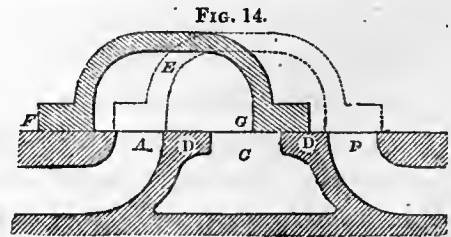

the flanches F and G are one-eighth of an inch wider than the ports; so that when the slide is in a central position, as shown by the dotted lines, the flanches F and G lie exactly over their respective steam ports, and overlap them one-sixteenth of an inch on each side. This overlap is for the purpose of ensuring that one port is completely closed before the other is opened, in order that they may never communicate with each other under the slide during its motion, nor the steam be allowed to enter both ports at the same time.

The slide valve is moved backwards and forwards a distance of 3 inches, or $1\frac{1}{2}$ inch on each side of the central position, and is carried beyond the inner edge of each steam port alternately, a distance of nearly half of an inch, as shown in

fig. 14, before its motion is changed and it begins to move back again; this distance that the slide moves beyond the port is called the travel. The waste port is always covered by the slide, as the travel is less than the width of the bars, so that the steam is always prevented from entering the waste port from the steam chest. During the reciprocating motion of the slide, each of the steam ports is alternately uncovered, and the steam allowed to enter and flow into the cylinder; the port is then covered again by the slide, and when the flanch has passed over, communicates through the inside of the slide with the waste steam port, allowing the steam which has performed its duty in the cylinder to escape by the port at which it had entered, into the waste port and out at the blast pipe; this action is called the eduction. The slide valve is held upon the face of the ports only by the pressure of the steam upon it, which is quite sufficient to keep it always steam-tight whilst moving; as all the inside of the slide is open to the air through the waste port, and the flanches fit air-tight upon the face of the ports, so that the whole pressure of the steam upon the slide is effective in keeping it down: the area of the slide being 55 square inches, the pressure upon it is about $1\frac{1}{4}$ tons. In large stationary engines the steam is admitted under the slides, as the pressure of the steam upon the slides would be more than is necessary to keep them tight, and would cause very great friction; the slides have, in this case, to be held down by other means, as packing or springs upon the back of them. At the extreme position of the slide, as in fig. 14, the inner edge of the flanch *G* approaches the opposite bar, thus contracting the opening of the waste port to the size of the port out of which the steam is escaping; if contracted more, the free exit of the steam would be obstructed.

The front end of each of the cylinders is closed by a cast iron cover *W*, seven eighths of an inch thick, let into it; the cylinder runs through the plate of the smoke box, projecting beyond it, and having a flanch resting against the inside of the plate, and fixed to it by bolts, which are screwed through the plate into the flanch. The cylinder cover *W* is of the same size as this flanch, and is held on to the cylinder by the same bolts that fix the cylinder to the smoke box plate; the heads of the bolts are made thin to clear the cover, and the bolts are prolonged beyond their head to pass through the cover, and have nuts screwed upon them on the outside. The other end of the cylinder has also a flanch, by which it is bolted to the inside of the tube plate; this is shewn on a larger scale in figs. 15 and 16, which are a longitudinal and a cross section of the cylinder to a scale of $2\frac{1}{4}$ inches to a foot, or three times the engravings. *OO* is a section of the cylinder; *PP* the back steam port leading into the end of the cylinder; *QQ* is the tube plate or back plate of the smoke box; and *R* the flanch upon the cylinder, similar to that at the other end. The cylinder runs through the plate, and comes flush with

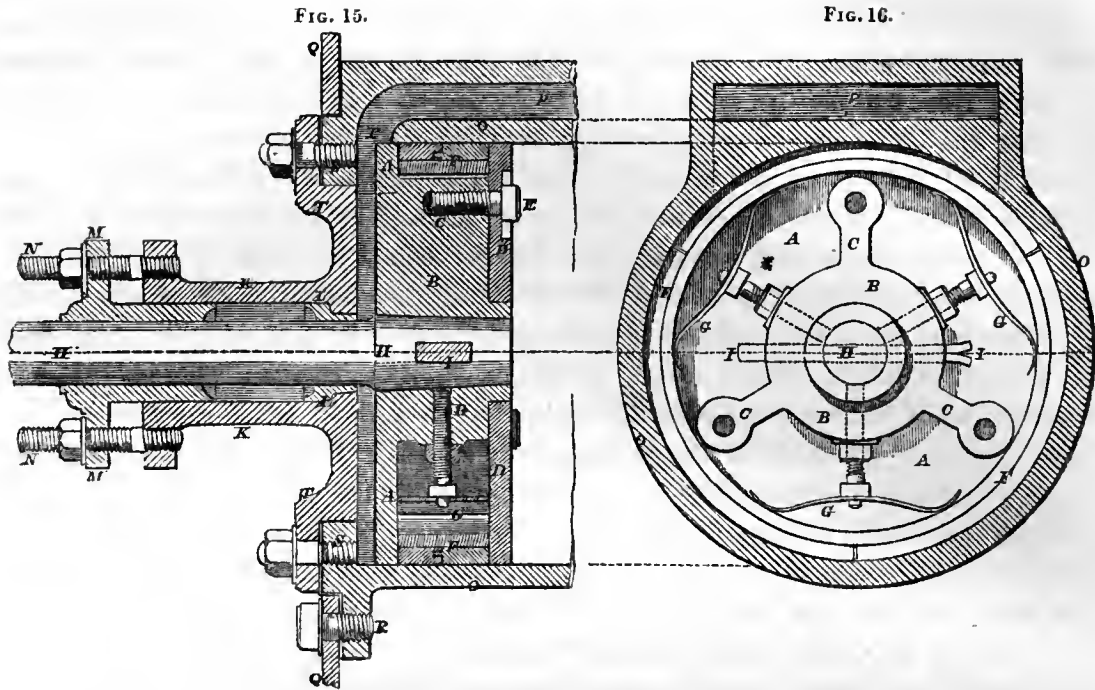

the outside; the joints and the space between the flanch and the plate are run with lead all round to make the cylinder quite firm and steady, as the hole in the plate does not accurately fit the cylinder; the joint at the other end of the cylinder is also run flush with lead for the same reason. The flanch is fixed to the plate by six three-quarter inch bolts, which are screwed into the flanch from the outside, in order that they may fit closely to the holes in the flanch and the plate, and hold the cylinder quite steady. A flanch *SS* is cast on the inside of the end of the cylinder, projecting into the cylinder, and the cover *T* is bolted to the outside of this flanch, having a projection in the centre that fills up the opening, and makes the end of the cylinder even or flush inside; the cover is fixed on by six bolts, screwed into the flanch of the cylinder, and having nuts on them on the outside; the bolts are made square where they pass through the cover, to prevent their turning when the nuts are screwed on. It is not required to have ready access to this end of the cylinder; but at the other end it is necessary that there should be no obstruction, as the cylinder is required to be completely opened occasionally to get the piston in and out. *X* (Plate *XC.*) is one of the pistons; there is one in each cylinder, fitting the cylinders accurately, so as not to let any steam escape between them and the cylinders when they are moved backwards and forwards. The piston is made entirely of brass, and consists of a plate, *A*, (figs. 15 and 16,) five-eighths of an inch thick, having a boss, *B*, cast on the centre, with three arms, *CCC*, three quarters of an inch thick, also cast upon it, radiating from the centre and equidistant from each other.

These arms and the centre boss stand up $2\frac{1}{2}$ inches from the plate *A*, and another plate, *D*, of the same thickness as the first, is put upon them, making the whole thickness of the piston $3\frac{3}{4}$ inches. The plate *D* is held steady in its place by a projection on the centre boss passing through it, and is fixed by screws *CC*, tapped into the bosses at the ends of the arms *C*, the heads of the screws *CC* being countersunk into the plate *D*. The plates *A* and *D* are turned so as to be just capable of moving in the cylinder without touching it, and three brass rings *FF* are placed between them. The inner ring is three-eighths of an inch thick, and is the same width as the space between the plates; the two outer rings are half an inch thick, and of half the width; and one of them has a projecting ring or rebate upon its edge, fitting into a corresponding groove in the other to keep them steady. The rings are turned exactly to fit the cylinder and each other, and cut through in one part, having been first hammered a little all round on the inside, which gives them a tendency to expand, and causes them to fly open on being cut; when, therefore, they are put in their places in the cylinder, they press against the cylinder by their elasticity, and keep in close contact with it, so as to make a steam-tight joint during the motion of the piston. The divisions in the rings are placed in opposite positions, or break joint, in order to prevent the escape of steam through them; for if they were to coincide, a passage would be left for the steam through the piston.

The elasticity of these rings is found to be quite sufficient to keep the piston steam-tight when moved in the cylinder, and it continues so for a long time; when, however, the rings become so much worn by the friction as to have expanded nearly to the utmost, some other means is necessary to press them against the cylinder. For this purpose the three steel springs *GGG* are placed in the piston; they are of the same width as the inside ring, against which they bear, and one-eighth of an inch thick in the middle, and a pin is put through each of them, having a collar bearing against the spring, and screwed at the other end into the centre boss of the piston; by unscrewing the pin a little the spring can be made to press harder against the ring when required, and the pin is then fixed by screwing up the set-nut upon it against the boss. When the piston is first made and the rings are new, these springs are not required, and they are set so as only to touch the rings; but as the rings wear and become too loose in the cylinder, the springs are screwed up more and more, and made to press harder against the rings; and when they are very much worn they are kept tight to the cylinder by the springs only, as they have expanded to their utmost. Access is readily obtained, when necessary, to the inside of the piston, by taking off the front cylinder cover and unscrewing the front plate *D* of the piston.

The pistons are often made upon different modifications of Barton's prin-

iple; with two or more rings of cast iron or brass, about an inch thick, cut into three or four segments, and having wedges inserted between them, which are constantly pressed outwards by springs, so as to keep the segments always tight to the cylinder; the springs are either spiral or flat springs like those in the engraving, or a circular steel hoop, a little larger than a circle touching the ends of the wedges, is forced in so as to bear against them. These pistons are liable to a defect from which the other with the spring rings is free; that of wearing grooves in the cylinder where the points of the wedges rub against it, as the wedges have to wear down faster than the segments; the plan shown in the engravings is very efficient, and appears on the whole to be the best. The hemp packing used sometimes in stationary engines is now generally superseded by metallic packing, as it requires frequent renewal, and is unequal in its pressure, the piston having to be packed very tight at first, in order to keep tight for any considerable time; in a locomotive, where the motion of the piston is very rapid, it would be quite inadmissible.

H H, or Y, (Plates XC. and XCI.,) is the piston-rod; it is $1\frac{3}{4}$ inches diameter, and is made conical at the end, being increased to $2\frac{1}{8}$ inches diameter in the centre boss of the piston, which is fitted upon it very exactly, and fixed by the cotter or key I, half an inch thick, and tapered slightly from $1\frac{1}{2}$ inches wide; the piston rod has to be fixed very firmly, and is split at the end, to prevent its getting loose. The other end of the piston rod passes through the stuffing box K, (figs. 15 and 16,) in the cylinder cover; it is made of steel, and turned truly cylindrical, to move through the stuffing box with as little friction as possible. The stuffing box has a half inch space round the piston rod for the packing, which rests against the brass ring or bush L, fitted on to a small flanch at the end of the stuffing box, and is compressed by the brass gland M, which leaves about three inches for the packing. The gland has two projections on the outer end, making an oval shape, and is held by bolts passing through these projections and screwed into corresponding projections on the stuffing box.

The piston is impelled by moving the slide valve from its central position, so as to admit the steam from the steam-chest into the cylinder through one of the ports, as in Plate XC., where the front port *n'* is shewn open; and the steam pressing against the front of the piston impels it to the back end of the cylinder. The slide is then moved to the opposite position, covering over the front port *n'*, and opening the back port *m'*, to admit the steam behind the piston and impel it back again to the fore end of the cylinder; at the same time allowing the steam in front of the piston, which had impelled it before to the back of the cylinder, and is now waste steam, to escape by the inside of the slide and the waste port *o'*, into the blast pipe, rushing

out thence up the chimney. At the end of this *fore stroke* the position of the slide valve is again reversed to admit the steam in front of the piston and impel it to the back of the cylinder, or make the *back stroke*; the waste steam behind the piston escaping through the back port and the inside of the slide into the waste ports as before: and on repeating the forward motion of the slide, another fore stroke is produced. The steam is thus made to produce a reciprocating motion of the piston from one end of the cylinder to the other; by moving the slide backwards and forwards from one extreme position, when one port is opened to the steam, to the other extreme, when that port is closed and the other opened. The motion of the slide is in the same direction as that of the piston, but precedes it, as it must take place before the stroke of the piston; and it is produced by the machinery, as will be explained afterwards. The amount of motion, or *length of stroke* of the piston, is 18 inches, and it moves to within half an inch of each of the cylinder covers. In stationary engines, the action of the steam in the cylinder is exactly similar; but the cylinders are vertical instead of horizontal, and the strokes of the piston are up and down instead of fore and back. The horizontal position of the cylinders is disadvantageous in causing an unequal wear of the pistons and cylinders, from the weight of the pistons and piston rods acting always on one side; and in also producing a strain on the piston rod from the wearing of the piston. However, in locomotives, where the pistons are very small and light, this unequal wear is quite imperceptible, though in large stationary engines, whose pistons are several feet in diameter, the action would be very injurious; and many small stationary engines are also made with horizontal cylinders, as the arrangement has several advantages in simplifying and strengthening the machinery.

When the waste steam is let out at the end of each stroke, there is also let out the steam occupying the space of half an inch at the end of the cylinder beyond the stroke of the piston, and the quantity required to fill the ports, which are both lost as they are expended without producing any effect. The steam lost at the ends of the cylinder cannot be avoided, as some clearance must be allowed for the piston to prevent the chance of its striking against the cylinder covers; and also to allow space for the escape of water that may accumulate in the cylinder, either from priming or from condensation of steam. To let out this accumulated water, a cock, q' , (Plate XC.,) fixed in a boss in the centre of each cylinder cover, is opened occasionally. A small pipe, r' , (Plates XC. and XCII.,) with a cock in it, is also fixed into the lower part of the blast pipe, passing through the bottom of the smoke-box for the purpose of letting out any water that may accumulate there. The steam lost in the ports can be diminished by shortening them, and for this purpose double slide valves have been used; the ports were carried directly up from the cylinder at

each end, a branch from the waste port being brought up alongside of them corresponding in size and distance with the present one, and a separate slide placed over each port. The action of the steam in this arrangement was exactly the same as in the present one, but the quantity of steam wasted in the ports was much diminished. Double slides were used in several of the first locomotives, but they have since been abandoned; as the quantity of steam contained in the ports is but small compared with the contents of the cylinder, and the arrangement added considerably to the friction and the complexity of the machine. However, in all stationary engines, except some of the smallest, double slides are used, but they are generally of a different construction and made together in one piece.

CROSS-HEADS AND GUIDES.—The outer end of the piston rod *Y* is attached to the cross head *Z*, (Plates *XC.*, and *XCI.*) shewn on a large scale in figs. 17, 18, and 19, which are drawn three times larger than the engraving, or to a scale of $2\frac{1}{4}$

FIG. 17.

FIG. 19.

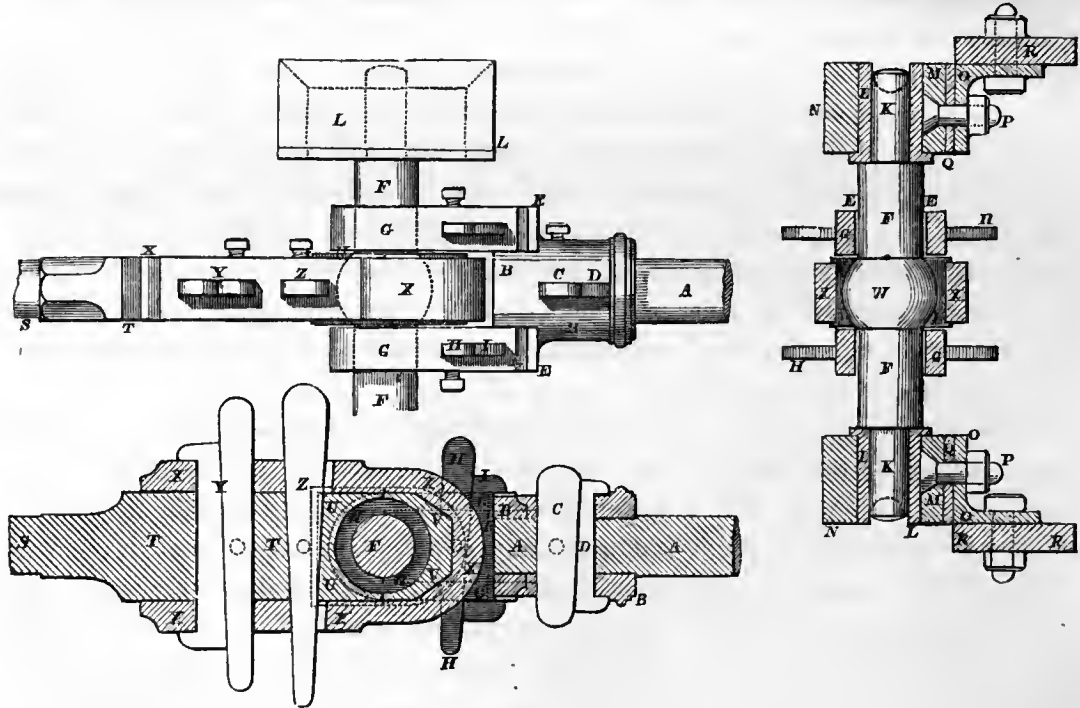

FIG. 18.

inches to a foot. Fig. 17, is a plan; one side being shewn broken off, as it is exactly like the other side; fig. 18, is a longitudinal section through the centre; and fig. 19, a cross section shewn complete on both sides. The end of the piston-rod *AA* is turned down smaller, and fitted into the wrought iron socket *BB* by the key or cotter and gib *C* and *D*; the gib *D* being tapered like the key, making their outer edges parallel. Two arms, *EE*, project from the end of the socket *B*, parallel to

each other, having a semicircular notch at the end fitted exactly to the cross head *F*, which is a turned iron pin, one inch and three-quarters in diameter. The cross head *F* is attached to the arms *E E*, of the socket *B B*, by wrought iron straps, *G G*, fitted on to both, and fixed by the keys and gibs *H* and *I*; the gibs being required to prevent the ends of the straps being sprung open by driving the keys. A small projection upon the cross head is fitted into a notch in one of the arms, *D*, in order to prevent its turning round.

The ends of the cross head *K K* are inserted into two guide blocks, *L L*, 6 inches long and $1\frac{3}{4}$ inch thick, with flanches on the inner side; these are made of steel and are grooved on the sides to save metal. Each of these guide blocks is placed between two steel bars, *M N*, $2\frac{1}{2}$ inches wide, fixed firmly to the frame of the engine, and shewn at *A' A'*, in Plates XC. and XCI. The guide blocks and bars are ground together and fitted accurately, enabling the blocks to slide steadily and easily between the bars; the upper bar, *M*, is five-eighths of an inch thick, and the lower one, *N*, one inch thick in the middle, and five-eighths of an inch at the ends; the two being connected firmly together by small pillars, *c'*, (Plate XC.,) fixed into them at each end. The lower bar, *N*, is required to be stronger than the upper one, as it is only supported at the ends. The upper bar, *M*, is fixed to a piece of angle iron, *O*, (fig. 19,) by bolts *P*, with countersunk heads, ground down flush with the bar; small pieces of brass, *Q*, being interposed between the bar and the angle iron at each of the bolts, affording the means of adjusting the bars accurately level when the angle iron *O* is fixed on to the engine framing *R*. The bars *M N* are adjusted exactly parallel to each other, and to the axis of the cylinder, so as to allow the blocks, *L*, to slide behind them without any strain when moved by the piston rod and cross head; and they serve the purpose of guiding the end of the piston rod, and causing it to move always exactly in the line of the axis of the cylinder.

CONNECTING RODS.—The connecting rods *B' B'*, (Plates XC. and XCI.,) are fixed at one end to the cross heads, and at the other end to cranks on the axle, *C' C'*, of the large wheels, *D' D'*, of the engine; they are of wrought iron, two inches diameter in the middle, and taper down to one inch and five-eighths towards the ends. The manner of fixing them to the cross heads, is shewn in figs. 17, 18, and 19, *S* being the end of the connecting rod, enlarged at *T T* to three inches wide, and made square and flat at the end. The brass bearing, *U*, is fitted to the end, and has another brass piece, *V*, upon it, made octagonal on the back; the two brasses are two inches wide, and have flanches upon them at the sides, as shewn by the dotted lines in fig. 18, that of the end brass *V* being semicircular.

The brasses are fitted accurately on to a spherical ball, *W*, that is turned upon the

middle of the cross head, and are held upon the end of the connecting rod, *T*, by the iron strap, *X*, fitted between the flanches of the brasses and fixed to the connecting rod by the key and gib *Y*, so as to hold them firmly and steadily together. The key *Z* is put through the connecting rod and strap close to the inner brass *U*; the holes in the strap being made larger than the key at the outer end, so that the key bears against the brass *U*, and forces it against the brass on the cross head. The connecting rod moves upon the cross head, and the friction causes the brasses to wear, so that they require tightening up occasionally by driving in the key *Z* farther, and bringing them nearer together; a little space is left between the brasses to allow for this. Small screws are inserted opposite to each of the keys, and are screwed against them when they are driven into their places to prevent their jolting loose.

The construction of the other end of the connecting rod is shewn on the same scale in figs. 20 and 21, which are a plan and a longitudinal section of it.

FIG. 20.

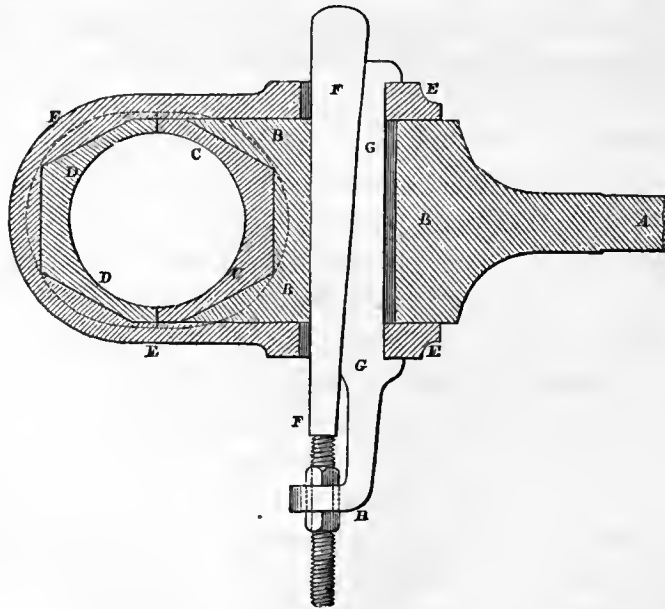
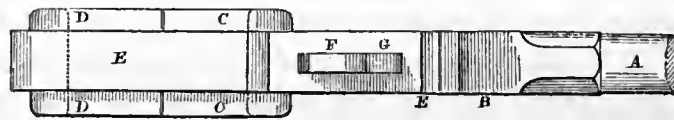

FIG. 21.

A is the end of the connecting rod, which is enlarged at *BB* to five inches and three quarters wide, and cut out to an octagonal shape at the end, fitting the brass bearing *C*. The other brass, *D*, is similar to it, and they are both three inches wide, with

semicircular flanches on the outside to hold them steady; and are fitted on to the crank pin, which is cylindrical, and five inches' diameter, as shewn by the dotted lines in fig. 20, and rounded out to a shoulder on each side. The brasses are held by the strap *E*, which is fixed on to the end of the connecting rod by the key *F* and gib *G*; the key terminates at the bottom in a screw passing through the prolonged end, *H*, of the gib, and held by nuts. These nuts are screwed up against the end of the gib, when the key is driven into its place; and effectually prevent its jolting loose; the hole for the screw being made oblong, to allow for the side motion of the key. The holes in the strap *E*, for the key, are made rather longer outwards than the key, and the key-way in the connecting rod is as much longer at the inner end; causing the key to bear only against the connecting rod, and the gib against the strap: the strap is thus drawn farther on the connecting rod by driving the key, and the brasses are brought nearer together, and tightened up on the crank pin as they are worn by friction. This end of the connecting rod is shortened as much as the brasses wear, as the outer brass is drawn inwards by the key; but the other end of the connecting rod is lengthened by the wear of the brasses, because the outer brass is fixed, and the inner one is pressed against it by the key. The total length of the connecting rod is thus kept always nearly the same, as the wear of one set of brasses compensates for that of the other. If this were not the case, the piston would be brought nearer to one end of the cylinder than the other by the wear of the brasses, and would require more clearance, to prevent it striking the cylinder cover.

CRANKED AXLE.—The axle *C'* of the large wheels *D'*, (Plate XC. and XCI.,) is called the cranked axle, from its having two cranks in it, to which the connecting rods from the two pistons are attached. It is drawn to a scale of an inch to a foot, or one third larger than the engravings in figs. 22 and 23, and it is shewn in the same position as in the Plates. It is made all in one piece and of the best wrought iron, termed back-barrow, or scrap-iron, and is $6\frac{1}{2}$ feet long, and 5 inches in diameter. The axle is cylindrical at the centre part, *A*, (fig. 22,) and is increased to five and a quarter inches at *CC*, where the cranks are formed. The two cranks, *R* and *L*, for the right and left hand cylinders, are exactly at right angles to each other, as shewn in fig. 23, which is a section through the axle at *E*; the sides of the cranks *DD* are four inches thick. The crank pins *BB* are five inches diameter and three inches long, the same dimensions as the brasses in the ends of the connecting rods, which are fixed upon them; and the length of the cranks from the centre of the axle to the centre of the crank pin is nine inches, which is exactly half of the stroke of the piston. Upon the parts *FF*, which are seven and a half inches long, the wheels are firmly fixed, so as to prevent their turning or shaking upon the axle; and outside the wheels, at *GG*, the axle is reduced to three inches and an eighth diameter

for five inches in length, having a collar at the end; these parts, *G G*, turn in brasses, which are fixed in the outside frame of the engine, and have the weight of the engine resting upon them. The axle is all turned in a lathe, and each of the crank pins is also turned by suspending the axle on centres corresponding with the centre of the crank pins; and made in strong cast iron arms, that are firmly fixed on the ends of the axle, and project beyond the cranks, so as to balance the axle, and enable it to turn round on the centre line of the crank pin. The axle is by this means made very true, and the cranks are made of exactly the proper length, and at right angles to each other. The corners of the cranks are chamfered off, as shewn in the figure, and the ends of the smaller cylindrical parts well rounded out.

The crank *R* of the right hand cylinder is shewn vertically, and in its lowest position; and the piston in the cylinder is shewn in the middle of its stroke, or at half stroke. (See Plate XC.) If the piston be now made to move backwards, by admitting the steam to the front of it, it will press against the crank pin by means of the piston rod and connecting rod, with a force equal to the pressure of the steam upon it; and as the piston is twelve inches diameter, or 113 square inches area, this force upon the crank will be $2\frac{1}{2}$ tons, when the steam is at the usual pressure of 50 lbs. per square inch. And as the cylinder and cranked axle are firmly connected together by the framework of the engine, they cannot be separated by this force upon the crank;

the crank therefore gives way by turning round, making the axle and wheels upon it revolve in the direction of the arrow, until it is brought to its farthest position and becomes horizontal, as the left hand cylinder is shewn in Plates XC. and XCI., and the piston has arrived at the end of its stroke.

FIG. 22.

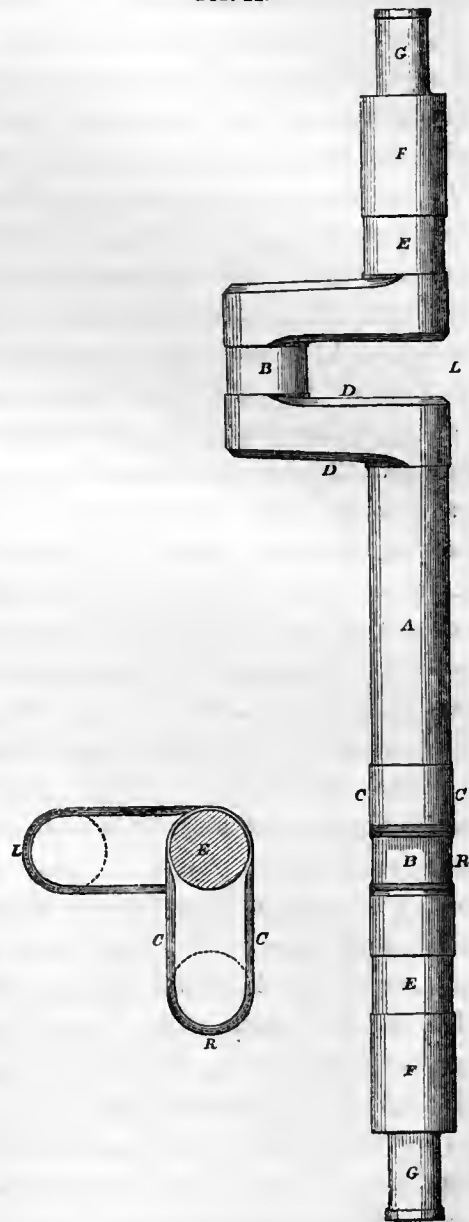

FIG. 23.

On reversing the slide valve to admit the steam behind the piston, and produce a fore stroke, the piston has no power to move the crank, as it is pulling directly in a line with the centre of the axle, and only tending to break the axle; and the crank has therefore to be moved on, so as to rise a little above the centre line, when the piston is able to move it, and pulls it round to the opposite position, or the side next the cylinder, and the piston arrives at the end of its stroke. On the commencement of a back stroke the piston has also no power to move the crank, it being again on the centre, and requiring to be assisted on a little, to enable the piston to act upon it and push it round to the opposite side again. The crank requires assisting over these two centres, or dead points, in order that continued rotation may be produced by the reciprocation of the piston; and for this purpose the two cranks upon the axle, which are worked by the two pistons, are placed at right angles to each other: for when one of the cranks is on the centre, and the piston connected with it has no power to make it revolve, as is the case with the left hand crank in Plates XC. and XCI., the other is at half stroke, and its piston has the greatest power upon it, so that it moves the axle round and makes the other crank pass the centre. In a similar manner, when they have made a quarter revolution, the right hand crank comes to the centre, but the piston of the left crank is then in full action, and this continues throughout the revolution, one crank being always in full action, when the other comes to the centre and ceases to propel the axle.

The power of the piston to propel the crank is greatest at half stroke, when the connecting rod is at right angles to the crank, and acts with the leverage of the full length of the crank; but as the piston advances to the end of the stroke, the angle that the connecting rod forms with the crank is continually diminishing, and with it the leverage and power to propel the crank, until at the end of the stroke the crank comes to the centre, and the connecting rod ceases to have any power to move it; the mean leverage throughout the stroke being only about two thirds of the length of the crank. This would cause therefore the motion to be very irregular if there were only one crank; but with two cranks placed at right angles to each other, the irregularity is very nearly corrected; as at half stroke the power of one piston only is effective, and at quarter stroke the power of both pistons together, though acting with equal advantage, very little exceeds the full power of the one alone. In stationary engines which have only one cylinder, the irregularity of the action of the crank is compensated for by the use of a large and heavy fly-wheel; which when once set moving, has sufficient momentum to bring the crank over the centre, and to render the velocity of the motion very uniform, as there is not time to accelerate its velocity perceptibly in the middle of the stroke, or to diminish it at the ends. Marine

engines which have no fly-wheels are always in pairs, like locomotives, except in some of the smallest vessels.

The connecting rod being inclined below the piston rod during the back stroke, and above it in the fore stroke, requires a moving joint at the end which takes hold of the cross head; and the cross head is made spherical at that part, to prevent any lateral strain that might arise during the motion from the crank not being accurately in the line of the piston rod, or the axle at right angles to it. The varying position of the connecting rod also renders the guides for the piston rod necessary to resist the great oblique strain upon it caused by the inclined positions of the connecting rod tending to force it upwards in the back stroke, and in the opposite direction during the fore stroke. This oblique strain is diminished by increasing the length of the connecting rod; which is therefore made as long as possible, in order to diminish the friction of the guide blocks, leaving only a small clearance beyond the crank and head of the piston rod at their extreme positions. Other modifications of the plan are also used to preserve the parallel motion of the piston rod, such as a single square bar placed on each side with the edges at top, termed diamond guides, and having sockets on the ends of the cross heads sliding upon them; but the other plan is found to be most advantageous; in small stationary engines similar plans are also sometimes adopted. But in stationary and marine engines generally, the motion of the piston is maintained in a straight line by various combinations of rods, forming a parallel motion, which has less friction than guides, and is more convenient in those cases. The strain is also diminished by the piston rod being connected with the end of a beam instead of directly with the connecting rod, which has a much less irregular motion.

The two cranks are thus made to revolve uniformly by the action of the steam upon the pistons in the cylinders, and move with them the axle and the wheels fixed upon it. The wheels are made to revolve in the same direction that they would turn if the engine were running forward; and they cannot turn round without either slipping round upon the rails, or rolling forward upon them and moving the engine with them. If the adhesion of the wheels upon the rails is greater than the resistance of the engine to being moved, and the pressure of the steam be sufficient, the wheels will roll forward upon the rails; and the engine will be propelled, and be able to draw after it a load, the resistance of which is equal to the excess of the adhesion of the wheels upon the rails above what is required for moving the engine itself. The adhesion of the wheels is not always the same; it is the greatest when the rails are most clean, and are either quite dry or quite wet; and it is least when the rails are dirty, and greasy with being partially wetted. For this

reason an engine, which is not loaded so much as the full adhesion of the wheels upon the rails, will often slip, and let the wheels turn round quicker than the engine is running, on passing a station, or any part of the line where the rails are liable to be dirtied by the traffic of persons across them.

The adhesion of the wheels is found to be about one fifth of the weight upon them when the rails are in a good state, and it varies between that and one tenth or twelfth. The weight upon the driving wheels as they are termed, is six tons, and the adhesion is therefore sufficient for drawing a load of 280 tons besides the engine upon a level. When the first locomotives were made, it was thought that the adhesion of the wheels upon the rails could not be sufficient to draw any load besides the engine, if it were enough for that; and various contrivances were resorted to, in order to obtain the necessary fulcrum from which to move the engine. Levers were first tried which resembled a horse's legs, and were thrust against the ground by the piston rods; a chain was also tried lying on the ground between the rails and taken hold of by a wheel in the engine; also a rack was fixed inside the rails and a toothed wheel turned by the engine worked in it. Locomotives which are intended for conveying heavy goods have their adhesion upon the rails generally increased by coupling four wheels together so as to make them all turn together, and thus obtaining the adhesion of all the four to assist in drawing the load. The power of the engine can then be increased as the increased adhesion will enable it to be exerted; for the power of engines with only two driving wheels cannot exceed a certain limit, or it will be greater than the adhesion of the wheels and the excess will be useless. The wheels that are coupled together are of the same diameter, and have connecting rods attached to cranks, which are fixed on the axles outside of the wheels. Some of the old engines had their wheels coupled by a pair of cog wheels; and also by an endless chain passed round a pulley on each axle.

The plan of driving the wheels of a locomotive by means of cranks upon the axle, is attended by the disadvantages that the axle is weakened very much by the cranks in it, and the power is applied at some distance from the wheels where it is wanted. The action of the pistons upon the cranks, alternately pulling and pushing them, and the great weight that the cranked axle has to carry, make it necessary that it should be made very strong in order to stand its work; they are therefore very heavy and expensive, costing about £50 each. They are very seldom broken, though they sometimes get bent by the engine running off the line; but the older locomotives had their cranked axles broken more frequently, as they were not made so strong at first. Several plans have been tried for obviating the necessity for a cranked axle, but they do not appear to be any of them so good upon the whole. The Rocket, and some of the first locomotives upon the Liverpool and Manchester Railway, had their cylinders

placed outside and fixed above the wheels; and the connecting rods took hold of crank pins outside of the wheels and fixed into them, so as to drive them directly. But it was found better afterwards to place the cylinders in the smoke box, where they were protected from the air, which cooled them very much before; and the machinery could then be fixed more conveniently; some engines, however, are still made on that construction. Engines have also been made with vertical cylinders, which worked cranks outside the wheels by means of bell cranks and connecting rods.

ECCENTRICS.—Upon the cranked axle C' , (Plates XC. and XCI.,) are fixed the four eccentrics E', E'', F', F'' , for the purpose of working the slide valves. The construction of one of the eccentrics is shewn to double the scale in figs. 24 and 25, which are

drawn to a scale of an inch and a half to a foot. Fig. 24 is a side elevation of an eccentric, and fig. 25 a section through the centre of it. A is a portion of the cranked axle, five inches diameter; B and C are two cast iron pieces, two inches and a quarter wide, forming the eccentric, and each fitted half round the axle; the smaller one, C ,

FIG. 25.



FIG. 24.

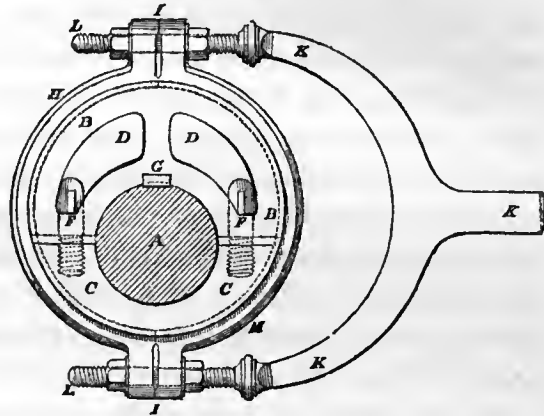

being one inch thick in the middle, and the two pieces forming together a circle of ten inches diameter. They have a projection of a quarter of an inch running round both sides of the outer edge, and the piece B has two openings, DD , cast in it to diminish the metal, leaving a thickness of an inch on each side. A rebate, E , projects from the straight edge of the piece C , fitting into a groove in B to hold them steadily on each other; and the two pieces B and C are fixed together by the pins FF , which are firmly screwed into the piece C , and passing through corresponding holes in the other piece into the openings DD , are fixed by keys driven through them; the whole eccentric is then fixed upon the axle, so as to make them turn round together by driving the key G into a groove in both. The brass ring HH , one inch thick in the middle, is put in the groove round the eccentric; being made in two pieces in order to enable it to be put into the groove, and the ends connected by flanches II . KK is the eccentric rod, forked at the end; the ends of the fork being three-quarter inch screws, which pass through the flanches of the brass rings H , and hold them together by nuts upon the screws. The other ends of the eccentric rods $e''e'''$ and $f''f'''$, (Plates XC. and XCI.,)

are carried on towards the smoke box; and when the axle *A* revolves, the eccentric *BC* revolving with it, turns round inside of the brass ring *HH*, which is prevented from revolving by the eccentric rod that is fixed to it. The groove of the eccentric and the brass ring are both turned exactly to fit, allowing the eccentric to turn freely and steadily within the ring. As the eccentric projects from the axle more on one side than the other, the ring is pushed out farther from the axle on that side; and in revolving with the axle, the ring is pushed out from the axle on each side in succession, causing the eccentric rod to be moved in each direction from its central position as much as the projection or the eccentricity, which is an inch and a half, or three inches total motion or throw.

The action of the eccentric is precisely similar to that of a crank an inch and a half long; and the eccentric is in fact a crank with a very large crank pin, this pin being ten inches in diameter, and reaching beyond the axle itself; and the eccentrics are used instead of cranks, to avoid the necessity of making so many small cranks in the axle, though there is considerable loss of power attending the use of them from the friction being increased by their large size. Eccentrics are used for working the slide valves in almost all steam engines, because of their convenience and steady action; they are also readily capable of adjustment, by altering the position in which they are keyed on the axle. They cannot be cast in one piece as the cranks are forged with the axle, and the eccentrics have, therefore, to be put on in two halves.

SLIDE-VALVE GEAR.—A side elevation of the eccentric rods and levers for working the slides is shewn detached in figs. 2 and 3, (Plate XCI.,) in two different positions, with a cross section through the eccentric rods, shewing a back elevation of the levers, &c., in fig. 4; and a plan of them is given in Plate XCI., in their position in the engine. The two eccentrics *E'* and *E''*, are for working the slides when the engine is running forward; *E'* being for the slide of the right hand cylinder, and *E''* for that of the left cylinder, and the ends of the eccentric rods, *e'' e'''*, are formed into large vertical forks, *g'' g'''*, having a notch in the bottom of each; the section in fig. 4 (Plate XCI.) is taken through the notches. These notches take hold of steel pins, with shoulders to hold the eccentric rod steadily, which are fixed into the lower ends of the levers *h'' h'''*, by means of nuts screwed on at the other side. The levers *h'' h'''* are keyed on to the ends of the horizontal shafts or weigh-bars *i'' i'''*, turning in brass carriages, *k'' k'''*, fixed on to the frame of the engine, and made in two pieces, the upper part being loose and held down upon the weigh-bar by bolts, allowing it to be tightened up as it wears. Upon the weigh-bars *i'' i'''*, and standing above, are fixed the levers *l'' l'''*, of the same length as the bottom levers, *h'' h'''*; and two horizontal links, *m'' m'''*, are attached

to the ends of each of these levers by a steel pin passed through them, with a small pin and washer at the end, to prevent its getting loose; the other ends of the links $m'' m'''$, being attached in a similar manner to a socket on the valve spindle l' , which is guided at its end by an eye in a small pillar fixed on to the boiler.

The eccentric rods $e' e'''$, taking hold of the bottom levers $h'' h'''$, make them move backwards and forwards with the eccentrics; and the top levers $l'' l'''$, connected with them by the weigh-bars $i'' i'''$, communicate the motion to the valve spindles by means of the links, $m'' m'''$; the levers h'' and l'' being of the same length, the motion of the slide valves is the same as the throw of the eccentrics, or three inches, as before stated. The links allow for the oblique action of the top levers which move in an arc of a circle, instead of a straight line as the valve spindle. The pins and eyes of the levers are all of steel, to diminish the wear, and are fitted very accurately, so as not to allow any shake when the motion is rapidly reversed at the end of each stroke, and that the slide may be moved the full three inches. The eccentrics E' and E'' are placed at right angles to each other, that they may be both in the same relative position to the respective cranks; and they are fixed in such a position with regard to the crank, that the port is full open, or the slide at the end of its motion, when the piston is at half stroke, as shewn in Plate XC. The eccentrics are therefore at right angles to their respective cranks, and they have to be fixed a quarter of a revolution behind the cranks, in order to move the slides as much in advance of the pistons; because the levers h'' and l'' reverse the motion, so that when the slide has to be pulled back, the eccentric rod must be pushed forward.

REVERSING GEAR.—The eccentrics, $E' E''$, are placed so as to work the engine forward; and when the crank is down, as in Plate XC., to cause the piston to be pushed back, and pulled forward when above the axle, and thus cause the wheels to turn round in the direction of the arrow, and propel the engine forward. In order to make the engine run in the opposite direction, two other eccentrics, F' and F'' , are necessary, which are placed exactly in opposite directions to the former ones, or at the extreme back position when the former ones are at their greatest throw forward; their rods, $f'' f'''$, have forks at the ends, similar to the other eccentric rods, and levers, $n'' n'''$, corresponding to them are fixed on the other ends of the weigh-bars $i'' i'''$, exactly like the levers $h'' h'''$. The four eccentric rods have pins fixed into them below the forks, and attached to the suspending rods, $o'' o''$, $o''' o'''$; the two middle rods, $o'' o''$, for the working eccentrics, $E' E'$, being connected at the top to a cross head at the end of the horizontal lever p'' , and the other two, $o''' o'''$, for the reversing eccentrics, forked at the top, and attached to the levers $p''' p'''$,

which extend in the opposite direction to the lever p' . The lever, p'' , is keyed upon the cross shaft q'' , and the other two, $p''' p'''$, upon another shaft q''' , both extending to the side of the engine, and turning in carriages, like the weigh bars $i'' i'''$, and having the vertical levers $r'' r'''$ fixed upon their outer ends. The levers $r'' r'''$ are connected by the link s'' attached to both; and one of them, r'' , extends above the joint, and is attached to the end of the long bar t'' , extending to the back of the engine, and connected to a similar lever, u'' , upon a short shaft, v'' , which is fixed on the frame at the side of the fire-box. On the outer end of this shaft, v'' , and close to the hand railing of the engine, is fixed the long handle w'' , which moves between guide plates attached to the hand rail; the outer guide having a notch in the middle to hold the lever w'' in a vertical position, and another at each extremity of the passage between the guide plates.

In Plates LXXXIX., XC., and figs. 1, 3, and 4, Plate XCI., the lever w'' is shewn pushed over into the forward notch, pulling the levers $r'' r'''$ forward also, by the bar t'' and link s'' ; causing the lever p'' to be raised by the means of the cross shaft q'' , and to pull up the ends of the eccentric rods $e'' e'''$, by the suspending rods $o'' o'''$, making the notches in them take hold of the pins in the bottom levers, $h'' h'''$, of the weigh-bar. The two forward working eccentrics, $E' E''$, are thus put into gear, and made to work the slides of the two cylinders, and cause the engine to be propelled forwards. The other two lifting levers, $p''' p'''$, are at the same time lowered by the lever r''' being pulled forward, letting down the rods $f'' f'''$ of the reversing eccentrics by the suspending rods $o''' o'''$, so that their forks clear entirely the pins in the levers, $n'' n'''$; leaving them free to move with the weigh-bar, and in exactly opposite directions to the eccentric rods $f'' f'''$ below them.

When the hand lever w'' is placed in the centre notch of the guides, or in a vertical position, as shown in fig. 2, (Plate XCI.,) the side levers $r'' r'''$ are brought upright, and the lifting levers $p'' p''' p'''$ made horizontal; so that the ends of the middle eccentric rods are let down, and the notches in them escape from the pins in the bottom levers of the weigh-bars: and the outside eccentric rods, $f'' f'''$, are only raised into a similar position, and are still not in contact with the levers of the weigh-bars. The slides will therefore cease to be worked, although the eccentric rods continue moving, and the engine will not be propelled any more, as the steam continues pressing upon the same side of the pistons.

But when the hand lever w'' is pulled quite over into the back notch of the guides, the positions of the eccentric rods are reversed; the outside lifting levers, $p'' p''$, being raised into the same position that the other lever, p' , had before, and drawing up the ends of the rods $f'' f'''$ of the reversing eccentrics $F' F''$, to catch the pins in the levers $n'' n'''$ of the weigh-bar upon one of the inclined planes of

their forks, and force them into the notches in the bottom of the forks. The reversing eccentrics, $F' F''$, are thus brought into gear, and made to work the slides, causing the motion of the pistons to be reversed by the steam being admitted on the opposite side of them, and making the engine run in the opposite direction to its former course; the middle eccentric rods, $e'' e'''$, are at the same time lowered, as the outside ones were before, allowing the forks upon them to clear the pins of the levers $l' h''$. The engine can then be propelled forward again by putting the hand lever over into its front position; dropping the rods of the outer reversing eccentrics out of gear, and drawing up the inner rods of the forward working eccentrics to force the levers of the weigh-bars into the opposite positions by their forks, and take hold of the pins in them.

The engine can thus be made to run either forward or backward, by merely pulling the hand lever w'' forward or back; and the handle is placed close to the engine man, who stands behind the fire-box, so as to be readily moved; it is fixed so as to drop into the notches, and requires pulling out of them to shift its position, in order to prevent its jolting loose. The suspending rods, $o'' o'''$, that support the ends of the eccentric rods, have to be moved with the eccentric rods in working, causing some friction to the engine; those rods that are in gear have to be held close up to the pins on the levers of the weigh-bars, that they may not get out of the notches in the eccentric rods; and their motion does not exactly correspond with that of the pins in the levers of the weigh-bars, from the suspending rods taking hold below the notches of the eccentric rods, and moving in an arc of a rather larger circle, causing a little additional friction from the sliding of the pins in the notches, though the amount of it is very small. To obviate this, the eccentric rods are placed in some engines above the pins in the levers of the weigh-bars, with the forks and notches inverted, so as to drop down upon the pins and rest upon them when in gear; allowing the suspending rods to have a loose hold of them, as they do not require support. This plan is liable to the objection, that if the eccentric rods should accidentally get loose by the pins jolting out, they would all fall into gear and cause the breaking of the machinery, as they move in opposite directions; but with the other arrangement the eccentric rods would in this case merely fall upon a rod that is fixed under them across the engine.

This plan of reversing has been but lately introduced, having been first used by Messrs. Stephenson, and since adopted with different modifications by other makers. The plan in many locomotives is, to have the four eccentric rods suspended above the levers of the weigh-bars in a similar manner to the last, but with notches only in their under side, so that they cannot take hold of the lever pins until they have moved along, and the notches coincide with the pins; the

slides and levers being moved to the right position by means of two starting handles fixed on to the fire-box, and connected by rods and levers with the two weigh-bars, and these starting levers are always moving with the slides. This plan is inferior to the other with the forked eccentric rods, as the slides have to be set by the starting handles, as well as the eccentrics reversed, in order to reverse the engine; though when the engine is running, the first is not required, but a considerable strain is then caused by the eccentric rods suddenly catching hold of the pins and bringing them into motion. The starting handles are used to enable the engine to be moved very steadily or for a small distance by working the slides by hand, the eccentrics being thrown out of gear; but a good regulator renders them unnecessary for this purpose, as the steam can be admitted very gradually to the cylinders. Considerable friction is also caused by their being continually in motion with the slides, and to avoid this, another handle has been added in some cases, by means of which they can be thrown out of gear when not required; but that adds to the complexity.

The plan of driving the slides that has hitherto been most universally adopted, and is still much used, is by means of two eccentrics only, fixed together at right angles to each other, and placed loose upon the centre of the cranked axle; their rods being connected with the weigh-bars, as in the other plans; and a driver with a projecting stud is fixed on the axle on each side, just clearing the eccentrics, a hole being made in each side of the eccentrics to fit the studs. The eccentrics can be shifted along the axle to either side by means of a lever, to make the stud in the driver on that side drop into the hole in the eccentric when it comes opposite to it in revolving, and cause the eccentric to turn with the axle and work the slides. The stud of the other driver is put on the opposite side of the axle to the corresponding hole in the eccentric; so that when the eccentrics are shifted to the other side by the lever, they have to stop for half a revolution before that driver catches hold of them, and are then fixed exactly opposite to their former position, and reverse the engine; in their intermediate position, when they touch neither of the drivers, they are stationary and cease to work the slides. This plan is inferior to those with four eccentrics, as it is not so certain in its action, and does not keep in order so well.

WORKING OF SLIDES AND PISTON.—As the slides are worked by eccentrics, they are not suddenly reversed in position at the end of each stroke, in order to let the steam on to the other side of the piston, and keep the steam port full open throughout the stroke; but are always in motion, and commence returning as soon as they have arrived at the end of their stroke. From this cause they are obliged

to have some travel, in order that the port may be full open for some time; and after having fully uncovered the port, the slides move or travel a little farther, not beginning to close the port again until they have returned over the travel. The motion is very varying as the eccentric drives the slide most quickly at the middle of its stroke; corresponding to the ends of the strokes of the piston, where the quickest motion is wanted, to admit the steam for the next stroke; the velocity of the slide diminishing rapidly towards the ends of its stroke, where it stops and retrogrades. Many contrivances have been tried in stationary engines for working the slides more suddenly, either by striking the spindle with tappets or projections on a moving rod, or by means of different kinds of cams or eccentrics of irregular shapes; with these plans travel of the slide would not be necessary, the port being full open nearly all the stroke. But in a locomotive no plan can well be adopted for working the slides which has a more sudden or irregular motion than an eccentric, because of the very great rapidity with which the strokes have to be made; which would soon cause the machinery to be deranged.

The piston and slides make two reciprocations or changes of motion during one revolution of the driving wheels, and as these are five feet in diameter, they make nearly 4 reciprocations per second when the engine is running at the rate of 20 miles an hour, and 8 reciprocations in a second when running at a little more than 40 miles an hour; the ordinary rate of working is about five reciprocations per second. This extreme rapidity causes every change of motion to produce a violent blow to the machinery, requiring that all the parts should be very well made and fitted together, in order that they may stand the work; the greatest strain is produced upon the fixing of the piston rod into the piston, and upon the joints of the piston rod and connecting rod. The brasses in the crank end of the connecting rod are not keyed up quite tight, but a very little play is left, allowing them just to shake when worked backwards and forwards; in order to prevent their heating by the great rapidity of the motion, and expanding by the heat together with the crank pin, making the joint very tight; they have sometimes expanded so much from the heating in consequence of being keyed too tight, that the engine has been nearly stopped by the great friction occasioned, and the brasses have been broken to pieces.

All the moving parts require a constant supply of oil to diminish the friction; and oil cups are fixed for this purpose upon all the principal moving parts, such as on the ends of the connecting rods over the bearings, on each of the piston rod guides, and over the piston rod and the slide valve spindle; the piston is oiled by pouring oil into the cylinder by the cock in the cylinder cover, the bent end of

the cock turning round for the purpose. An oil cup is shown one quarter the full size in figs. 26, 27, and 28. Fig. 26 is a side elevation of it; fig. 27, a section through the centre; and fig. 28, a plan of the top. The cup *A* is made of brass, and the cover *B* has a piece projecting from it turning upon a pin in a socket *C* at the side of the cup *A*, and square at the end, resting upon a small spring at the bottom of the socket to hold it either open or shut. An iron tube *D*, is fixed into the foot of the cup, extending to the top, and projecting through the bottom, where it is screwed, for the purpose of fixing the cup on to the part which has to be oiled.

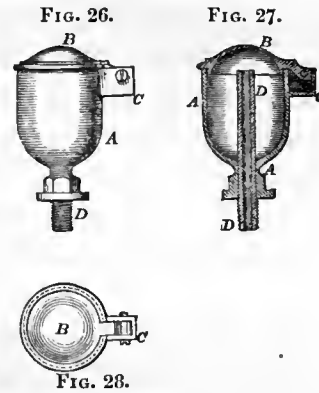

The hole into which the cup is screwed runs through to the rubbing surface; and some cotton thread is put through the tube, dipping into the oil in the cup, and the other end touching the moving part; the thread acts as a syphon, and continually drops the oil upon the rubbing surface. The oil cups were made at first without the tube or cotton thread, but the oil was found to run out too quickly, and could not be kept supplied; loose cotton was then put into the cup to prevent the oil running out so fast, but the syphon cup acts much better as it supplies the oil uniformly and gradually. The oil cup on the crank end of the connecting rod has so violent a motion, that it is almost impossible to keep the cover shut without the spring is very strong; the covers are sometimes detached and screwed on, but they are then very liable to be lost; and the best cup for that purpose is one without a loose cover, but with only a small hole in the top to pour in the oil, and made funnel-shape inside to prevent the oil jolting out of the hole.

The faces of the slide valves and the outside piston rings are subject to considerable wear, from the pressure upon them and the rapidity of their motion; but the wear is very much increased when the boiler is supplied with dirty water, priming much in consequence; as the water which gets over into the cylinder carries particles of sand with it, which grind the rubbing faces very quickly. The slides in the engine shewn in the engravings have just been removed, having lasted two years; the old ones were worn down to less than a quarter of an inch thickness of flanch. The piston rings are not yet worn out; they usually last about three years. In another engine that had run upon a part of the works where the water was very bad and sandy, the piston rings were worn down to one eighth of an inch thick in four months. The cylinders get worn uneven in time by the friction of the pistons, and require reboring; about one eighth of an inch is taken off by the boring, and they are bored out generally two or three times before they are worn out; they wear usually

for four years, before requiring to be rebored, but the time varies much with the quality of the metal, it being necessary sometimes much sooner.

A larger passage for the entrance of the steam is required in a locomotive than in a stationary engine, in proportion to the size of the cylinders; as the piston moves quicker, and the steam has to be admitted proportionally quicker. The best velocity for the piston of a steam engine is given by Watt as 220 feet per minute; and the area of the steam port, so as to admit the steam to move the piston at that velocity with its full pressure, he gave as one twenty-fifth of the area of the cylinder. In this locomotive, the velocity of the piston when the engine is running at 20 miles an hour is 350 feet per minute nearly, and at 40 miles an hour, nearly 700 feet per minute; the usual velocity being about 440, or double of the velocity in stationary engines. The size of the ports is one fourteenth of the cylinder, or rather less than Watt's proportion, which would be one twelfth and a half, as the piston moves twice as fast; the steam ports in some locomotives are made as large as one eleventh, and in others only one seventeenth of the cylinder, but one fourteenth appears to be a very good proportion.

The slide begins to open the steam port a little before the commencement of the stroke of the piston, so that the steam is shut off from the piston and let on to the opposite side for the commencement of the next stroke, a little before the end of each stroke; acting for this interval in opposition to the motion of the piston. This is called the lead of the slide, and it is made generally about a quarter of an inch, being produced by fixing the eccentrics a little in advance of the position at right angles to the cranks. It is found necessary to let the steam on to the opposite side of the piston before the end of the stroke, in order to bring it up gradually to a stop, and diminish the violent jerk that is caused by its motion being changed so very rapidly as five times in a second. The steam, let into the end of the cylinder before the piston arrives at it, acts as a spring cushion to assist in changing its motion, and if it were not applied, the piston could not be kept tight upon the piston rod. A little lead of the slide is also necessary that the steam may be admitted through the port into the cylinder, and be completely ready to begin the next stroke when the piston is at the end of the cylinder; but so much is not necessary for this.

The principal advantage gained by giving lead to the slide is in beginning to get rid of the waste steam before the commencement of the stroke; so that when the piston commences its stroke there is but little waste steam before it to resist its progress, the steam beginning to be let out of the cylinder before it has driven the piston to the end of the stroke. This is a very important point in a locomotive, as the resistance or negative pressure of the waste steam upon the piston is very considerable; from

the rapidity of the motion, which allows very little time for it to escape, and from the use of the blast pipe, which obstructs its passage. The area of the extremity of the blast pipe is only five square inches, while that of the steam port is eight square inches, requiring the velocity of the steam in the blast pipe to be considerably greater than in the cylinder. The average negative pressure of the waste steam throughout the stroke is 6 lbs. per square inch when running at the usual rate of 25 to 28 miles an hour; and at greater velocities the negative pressure has been found to increase to double that amount and even more. The effective pressure of the steam upon the piston at such high velocities is considerably below the full pressure of the steam in the boiler; as the steam cannot be supplied to follow up the piston so quickly with the full pressure, and the regulator has to be only partially opened, so as to throttle the steam and check its passage into the cylinders; which diminishes its pressure, as it has still to occupy the same space. The negative pressure of the waste steam amounts, for this reason, to 30 or 40 per cent. of the positive pressure of the steam upon the piston when the engine is running very fast, and the power of the engine is diminished nearly one half.

For this reason an advantage is obtained by letting out the steam before the end of the stroke; and the steam still exerts a very considerable pressure on the piston to the end of the stroke, so that the whole power during the stroke is very little diminished though the steam begins to be let out before the end, and the resistance of this pressure of the waste steam during the next stroke is saved; the lead given to the letting out the steam, or the eduction lead, is often made greater than the steam lead, to increase this effect. The steam is shut off a little before the end of the stroke in consequence of the lead of the slide, and acts expansively for that portion, saving so much of the steam, but diminishing the total power a little; the extent of this action is, however, very limited, as the piston is less than a quarter of an inch from the end of its stroke when the steam is shut off. In stationary and marine condensing engines the steam has usually very little or no lead; but it is shut off at two-thirds or three-quarters of the stroke, giving a great amount of expansive action; and the eduction has a great deal of lead, the port being nearly full open at the commencement of each stroke.

FEED PUMPS.—The feed pumps, K K, (Plates LXXXIX., XC., and XCI.) are fixed by means of flanges to plates which are bolted on to the frame of the engine; they are fixed on the outside of, and a little below the piston rods, and exactly parallel to them. Each pump is worked by an arm, G G, fixed on to the piston rod; it has a socket at the end, fitted on the piston rod, and fixed by a small pointed screw tapped into it and bearing against the piston rod; the arm is inclined obliquely downwards, so as to clear the guides of the piston rod as it is moved backwards and forwards by the

piston rod, and attached at the outer end to the plunger of the pump. One of the pumps is shewn in section in fig. 29, to three times the scale of the engraving, or $2\frac{1}{4}$ inches to a foot. The barrel of the pump, *AA*, is made of cast-iron, $1\frac{3}{4}$ inches in

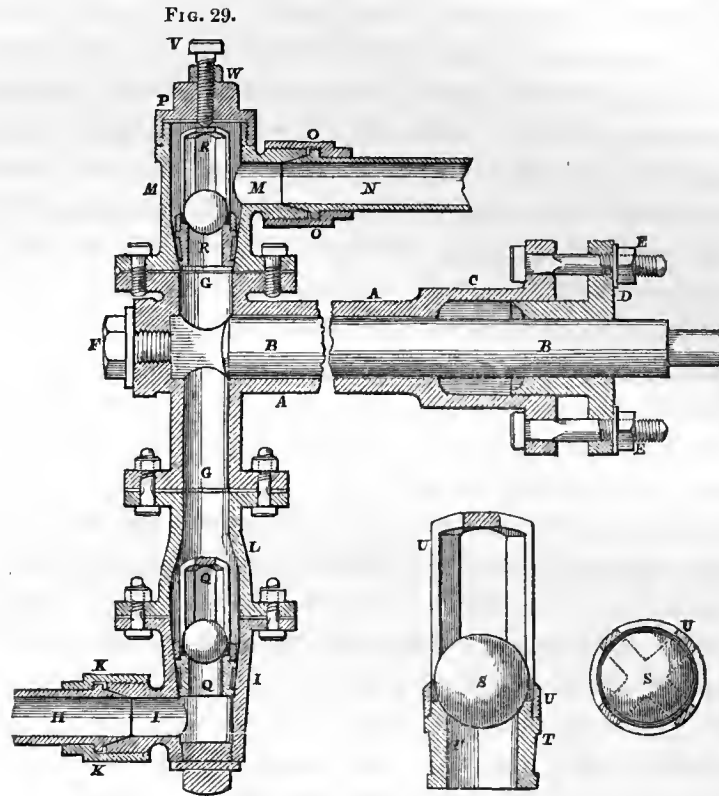

FIG. 30.

FIG. 31.

diameter inside, and three-eighths of an inch thick. *BB*, is the plunger, $1\frac{5}{8}$ inches in diameter, and made of a wrought iron tube for the sake of lightness, plugged up at the inner end, and having a short rod keyed into the other end, which is fixed into the socket in the driving arm by a nut screwed on the end. The plunger *B*, passes through a stuffing box, *C*, at the end of the pump barrel *A*, with a brass gland, *D*, attached by screws, *EE*, to the flanch of the stuffing box. The plunger is turned truly cylindrical, to move water-tight through the stuffing box, but the inside of the barrel of the pump is not bored, as the plunger does not touch it.

A plug, *F*, is screwed into the other end of the pump to afford a passage quite through for the convenience of fixing. Two short pipes, *GG*, are cast upon the end of the barrel *A*, to the lower one of which is bolted the tube *L*, having the piece *I* fixed below it; both are of brass, and the piece *I* has a short tube cast on its side, with a screw made upon its outer end. *H* is the copper suction pipe, having a brass

collar soldered upon it with a thin conical end, which is fitted into the tube *I*, and held water-tight by the socket *K*, screwed on to the tube and bearing against the collar of the suction pipe.

The piece *M*, which is bolted upon the upper pipe *G*, is closed at the top by a cap, *P*, screwed upon it, and has a tube cast on it like the bottom piece, *I*, into which the end of the delivery pipe, *N*, is fixed by the screwed socket *O*, exactly similar to the suction pipe, *H*. The delivery pipe is bent round backwards, as shewn in Plate LXXXIX., extending to the fire box, where it is fixed into a valve box, in the same manner as the other end is fixed; the pipe has to be bent in this way that the ends may be turned in the same direction to allow them both to be screwed into the sockets instead of having the screws at the two ends pulling against each other. This box contains another valve like those in the pump, and is fixed on to the fire box, communicating with the inside. The suction pipes, *K'K'*, (Plates LXXXIX., XC., XCI., and XCII.,) pass under the fire box, and are connected at the end to the pipes that bring the water from the tender, being suspended by stays, *s's*, from the fire box.

In the pieces *L* and *M*, are fixed the valves *Q* and *R*, which are shewn to double the scale in figs. 30, and 31, where *T* is the valve seat, made conical and with a groove outside to hold packing for fitting it water-tight when driven into its place in the pump. The valve *S* is a ball, turned and ground truly spherical, fitting water-tight into its seat in every position; it is guided by the piece *UU*, screwed upon the valve seat, and cut into four bars to allow passage for the water. A pin, *V*, is screwed through the cap *P*, bearing upon the guide of the valve *R*, and fixed by a set nut, *W*, to hold down the valve seat and prevent its being raised out of its place by the force of the pump; the lower valve seat does not require holding, as the pressure is above it.

The plunger *B*, fig. 29, is worked in and out of the barrel of the pump *A*, a distance of 18 inches, by the piston rod at each stroke; leaving a space behind it when drawn out equal to its bulk, which is supplied with water through the suction pipe and lower valve, and the water again forced out through the upper valve and delivery pipe into the boiler when the plunger is pushed in. The internal diameter of the suction and delivery pipes, and of the water way in the valve seats, is one inch. The pump would force a quantity of water into the boiler at each stroke equal to the bulk of the plunger for 18 inches in length, if the suction pipes were kept open; but the quantity is regulated according to circumstances by means of the cocks *t't'* fixed in the suction pipes, the handles of which extend upwards through the foot board on which the engine man stands so as to be within his reach; and the closing these cocks causes the plunger to leave a partial vacuum behind it, and as the

water cannot enter to fill it up, so much less water is forced into the boiler. In small force pumps a plunger is preferable to a piston, because the barrel does not require boring out, as would be the case if a piston were used; and the packing of the stuffing box upon the plunger is much more easily kept in order than the packing of a piston.

The additional valve in the delivery pipe acts in a similar manner to the upper valve of the pump, and it is used as a security in case the other valve should get out of order from any dirt getting on its seat and preventing its closing. The valves first used for the feed pumps were mitre valves similar to the safety valves; but ball valves are now used instead, and are found to be much superior, as they are more free and certain in their action from requiring no spindle to guide them, and keep in better order. The plungers of the feed pumps are sometimes attached to the cross heads, which are prolonged outside of the guide blocks for the purpose, instead of being worked by an arm fixed on the piston rod; but in both plans a considerable strain is caused as the pumps are so much on one side of the piston rod. To prevent this strain they have been worked by eccentrics fixed upon the axle in some large engines; in which plan additional friction is produced by the eccentric, but the friction caused by the strain is quite avoided, and perhaps more than compensates for it.

THE WHEELS, FRAMING, ETC., OF THE ENGINE.

WHEELS.—The wheels are of two kinds; the two driving wheels, $D'D'$, which are fixed on the crank axle C' , are 5 feet diameter and are flat on the edge; the other four wheels $L'M'$, two of them, L' , placed towards the front just behind the smoke box, and the other two, M' , at the back behind the fire box, are 3 feet 6 inches diameter, and have a projecting rim or flanch upon their edges which runs against the inner side of the rails. Each pair of the small wheels is fixed upon an axle, $L''M''$, as well as the large wheels; they are three inches and five eighths diameter, and the outer ends project beyond the wheels, turning in brasses in the frame of the engine. Upon these brasses the whole weight of the engine rests through the medium of the springs above them; and all the weight is thus suspended by springs except that of the wheels and axles themselves, for the purpose of deadening the shocks that are caused by the rapid motion of the engine. It is necessary for all wheels of railway carriages to be fixed upon the axles and have the axles turn with them, instead of turning loose upon the axles as in carriages upon common roads, in order that they may be held quite steady and upright; for if they were to get nearer together they would run off the rails, though in common carriages it would be of no consequence, as they would still have as firm a bearing. Also when the wheels are fixed upon the axle

there is the leverage of the whole length of the axle to keep them upright, but when they are loose there is only the hold of the thickness of the nave.

The construction of the wheels is shewn in figs. 32, 33, 34, and 35, to a scale of an

FIG. 32.

FIG. 34.

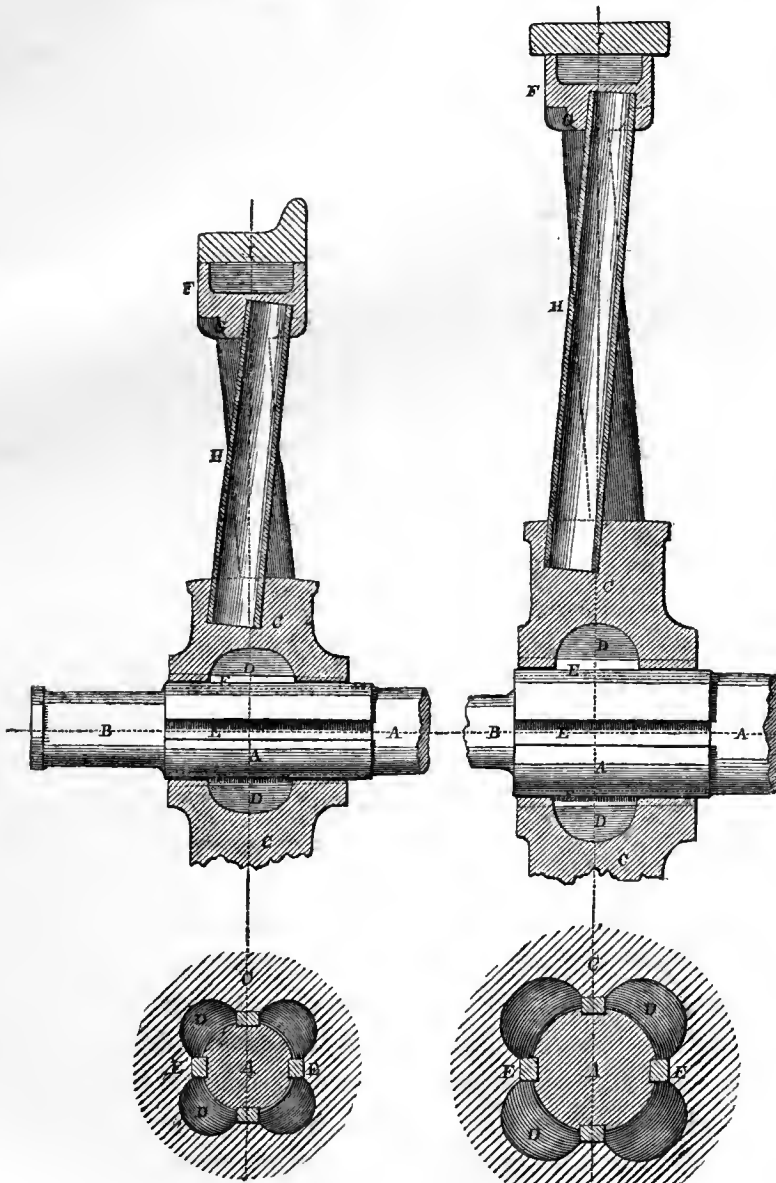

FIG. 33.

FIG. 35.

inch and a half to a foot, or double the size of the engravings. Fig. 32 is a section through the centre of one of the small wheels, and fig. 33, is a cross section through

the axle and nave; figs. 34 and 35, being similar sections of one of the driving wheels. *AA* is the axle of each wheel, the large one is $5\frac{1}{4}$ inches diameter inside the wheel, and the small one is enlarged to 4 inches; the outside bearing, *B*, of both, are of the same size. *CC* are the naves of the wheels, made of cast iron; the large one is 18 inches diameter and the small one 13 inches; the length of both in the centre where they are fixed to the axle is $7\frac{1}{2}$ inches, and they are fixed by four keys, *EE*, each, driven into grooves cut in the axles and inside the naves. The wheels are entirely supported and held by these keys, as the naves do not touch the axle; and by this means a firm and uniform bearing can be obtained, and the wheels can also be fixed truly at right angles to the axle and at the proper distance from each other. Hollows, *EE*, are cast in the naves between each of the keys to diminish the metal.

The rims of the wheels, *FF*, are of cast iron, four inches and a half wide and two inches and a half deep; they are cast with a groove round them on the outer side to diminish the weight; bosses, *GG*, are cast on the inner side, where the spokes are inserted. The spokes, *HH*, are wrought iron tubes one quarter of an inch thick and tapering from two inches and a quarter to two inches in diameter, and they are cast in the nave and rim. The spokes are inclined to the plane of the wheel, so as to come nearly to one face of the nave and the opposite face of the rim; and they are inclined alternately in opposite directions, as shewn in the figure, for the purpose of increasing the lateral strength of the wheels, and preventing their bending and getting out of the vertical position with the great strains to which they are subjected. The spokes are laid in the moulds in which the wheels are cast, and the metal cast round them, the ends of the spokes being first plugged up; and the spokes are covered at the ends with a composition of borax, which causes them to partially melt when the metal is poured in, forming so close and firm a joint that they never get loose. The rims of the wheels are cast first, and allowed to remain for about three quarters of an hour before the naves are cast, because they contract much more in cooling than the naves, being of a much larger diameter, tending to force the spokes nearer to the centre; and if the naves were cast at the same time, the spokes would be prevented from approaching the centre, and there would consequently be a very great strain upon them, and the metal in the rims would not set firm from cooling in a state of tension, and would be liable to break with any blow; but by allowing the rims to set before the naves are cast, this action is prevented.

II are the tires of the wheels; they are made of wrought iron rolled into the required shape, with the ends welded together; the plain one for the driving wheels is $5\frac{3}{4}$ inches wide, and the flanch tire for the small wheels $4\frac{1}{2}$ inches wide. Sections

of the two tires are given in figs. 36 and 37, half of the real size ; they are both made slightly conical, being tapered from $1\frac{3}{8}$ inch to $1\frac{1}{2}$ inch thick ; and the flanch projects one inch and a quarter, and is three quarters of an inch thick at the edge and an inch thick at the base. The rims and tires are both turned, and the tires are heated when put on, and contract on cooling so as to hold firmly on the wheel ; great care is required in fitting them, that they may not be loose upon the wheels nor shrunk too tight, so as to injure their texture. They are held in their places by three bolts with countersunk heads in the tires and nuts screwed on against the inner side of the rims. The tires are turned when fixed on the wheels to make them truly circular, and to make the two in each pair exactly alike.

The flanch wheels, like the wheels of all railway carriages, require to be made a little conical, in order to prevent the flanches being continually in contact with the rails and rubbing against them, which would cause a great deal of friction ; as a wheel, when running towards one side and bringing the flanch in contact with the rail, will bear upon a larger circumference than the other wheel, and will tend to run towards the opposite side and make the wheels central again ; the flanches are thus hardly required on a straight line, and only necessary upon sharp curves to keep the wheels from running off the line. The rails are laid inclined a little, so as to fit the conical wheels, and for this reason the driving wheels have to be made also conical, although they have no flanch. The driving wheels are made without flanches that they may always have firm hold on the rails, as a flanch on the inner one, when the engine is turning round a curve, would be forced against the inner rail, and would interfere with the bearing of the wheel and cause friction ; and flanches upon the front and hind wheels are sufficient to keep the engine upon the rails. For the improvement of making the middle driving wheels without flanches, Mr. Stephenson has a patent.

The wheels of the first engines were made entirely of cast iron, but it was found difficult to make them sound in consequence of the unequal contraction in cooling, and they were too brittle to bear the shocks produced in running fast ; the cast iron was also found to be too soft and to wear in a groove on the edge with running on the

FIG. 36.

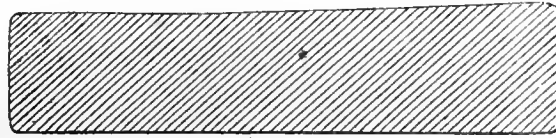
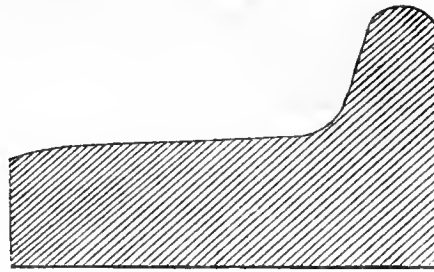

FIG. 37.

rail, and the driving wheels could not be case-hardened, as the others were, from its diminishing the adhesion upon the rails. Wheels with wooden spokes and rims and wrought iron tires, were tried on the Liverpool and Manchester Railway, and found to wear better, being more elastic; and flat wrought iron spokes were then tried. The wheels with tubular spokes, and cast iron rims with wrought tires, are now very generally used, and wear very well, lasting two or three years; the driving wheels being subject to the most wear, in consequence of the slipping to which they are liable. The tires squeeze out at the sides as they wear, and when worn out are replaced by new ones; they are now made wider, the flanch tires being six inches, and those of the driving wheels seven inches, in order to prevent squeezing out at the sides, which is the greatest cause of their wearing out. The cast iron rims are rather objectionable from their brittleness, as they have to run with so great a velocity; and to obviate this, some engines have wheels with wrought iron rims, to which the spokes are fixed by rivets, having the tires shrunk upon them; this construction is considerably more expensive, though very durable.

All the earlier locomotives on the Liverpool Railway, and many of the present ones, have been made with only four wheels, *D'L'*; the third pair of wheels, *M'*, placed behind the fire box, has been added but lately; but six-wheeled engines are now coming into more general use, and on several railways none others are used. In the earlier engines the fire-box was considerably smaller than the present size, and that end of the engine behind the crank axle was but little heavier than the other end before the front axle, so that the engine was nearly balanced upon the axles and ran steadily along. But the weight of the hind end of the engine has been so much increased, by increasing the fire-box, that it has a considerable preponderance, and the present engines are far from balanced; in the engine shown in the engravings, the weights at the wheels, *D'L'*, supposing the hind wheels, *M'*, removed, are six tons at the large wheels, *D'*, and only four tons at the front wheels, *L'*, including the weights of the wheels. This excess of weight behind the wheels causes in the four-wheeled engines a pitching motion, which makes them rise on the springs of the front axle, and is considered dangerous when running very fast. The pitching of the engine causes also great injury to the rails, as the wheels are made continually to strike upon them with very great force.

The hind wheels in the six-wheeled engines support the fire-box, and prevent this action; the springs over their axle are hung very light, so that in the ordinary state of the engine they only just bear against the frame, and take scarcely any weight away from the driving wheels; but they serve to catch the weight in the oscillations of the engine, and prevent that overbalancing which causes the pitching motion. The weight on the rails at these wheels is therefore only that of the wheels and axle, or

about a ton and a quarter, when the engine is empty; and when filled for working, the weight is about two tons, making the total weight of the engine twelve tons when full. The weight of the engine when empty is ten tons; and that of the driving wheels and axle is about a ton and three quarters, of which the cranked axle has nearly a quarter of a ton.

When an engine is required for heavy work, as for carrying goods, and the adhesion of four wheels must be made use of for propelling it, the front wheels, L' , are made of the same size as the driving wheels, and coupled with them. The cylinders have then to be placed lower, and inclined upwards towards the cranked axle, in order that the piston rods and guides may clear the front axle, L'' , as that is raised up to a level with the cranked axle C' and the former position of the piston rod, by the wheels D' and L' being of equal size. The driving wheels are in this case sometimes made less than five feet, in order to increase the power of the engine, as the diminishing of the diameter of the wheels diminishes the leverage of the load upon the engine, or increases the leverage of the engine in moving the load. But the speed of the engine is diminished in the same proportion, as the smaller wheels will advance a less distance than the larger ones in the same number of revolutions; but this is not material in the carrying of heavy goods, as so great a speed is not required for them. In order to enable the engines to run faster without having to make more strokes in the same time, the size of the wheels has been increased, and a great many are now making with six feet driving wheels; the size of the cylinders has also to be increased to supply the increased power that is required, and they are made 13 inches diameter with the same stroke, 18 inches. Wheels have been tried lately of double the size, or ten feet diameter, and even larger in some instances, for the purpose of still more reducing the velocity of the piston, and diminishing the loss of power from the resistance of the waste steam, which is the great difficulty in locomotive engines. But it appears very questionable, whether the disadvantages arising from the use of such large wheels do not more than compensate for their advantages in diminishing the velocity of the piston; as there is a serious objection to them in their great weight, which, together with that of the cranked axle, also proportionally increased, is necessarily unsupported by the springs, and therefore the violent shocks produced by the rapid motion cannot be eased by them. A certain velocity of the piston is also required for the effective operation of the blast, and the velocity should for this reason be, probably, not less than 300 feet per minute. Cog wheels, worked by the connecting rods, have also been tried, doubling or trebling the velocity of the driving wheels; but they are objectionable, from their jarring action with so rapid a motion.

OUTSIDE FRAMING, &c.—The principal or outside frame, $N'O'P'$, (Plates LXXXIX., XC., XCI., and XCII.,) is placed along the sides of the engine outside the wheels, and

across the ends, serving to support the whole engine, which is firmly fixed to it. It is made of good tough ash plank, the side pieces $N' N'$ are three inches thick and seven inches deep, and covered on both sides with sound wrought iron plates, a quarter of an inch thick, fixed on by a number of iron bolts; the best plates are termed Low Moor plates. The side pieces are morticed into the end pieces, $O' P'$, of the frame; that in front of the engine, O' , being five inches thick, and thirteen deep; angle pieces of iron are bolted on to strengthen the corners inside and out. The outside length of the frame is 17 feet, and the width 6 feet 4 inches. The boiler, fire-box, and smoke-box, are fixed to the side frames, $N' N'$, by strong wrought iron stays, $u' v'$, four inches and a half wide and half an inch thick. The stays, $u' u'$, for the smoke-box and fire-box, consist of a horizontal piece, (see Plate XCII.,) bent downwards at right angles at the inner end, and riveted to the side plate of the fire-box or smoke-box, and resting at the other end upon the side frame; the other inclined piece is welded on to it at the outer end, the two being bolted down to the frame, and it is riveted like the other piece at the upper end to the plate; the inner ends of both that are riveted to the fire-box and smoke-box are made T shaped and twelve inches wide. The stays, $v' v'$, for the boiler are made and fixed in a similar manner; they are longer, as shewn by the dotted lines in fig. 4, (Plate XCII.,) in order to reach the boiler, and have a ring of the same sized iron inserted in them, touching the horizontal and inclined pieces of the stays and the sides of the boiler, and riveted to each of them.

$Q' Q' Q'$ are wrought iron plates, seven-sixteenths of an inch thick, bolted on to each side of the frame at the axles, and called the axle guides; serving to hold steadily the boxes that contain the brasses bearing on the axles, and to guide them when they slide up and down from the play of the springs. A piece $4\frac{1}{2}$ inches wide is cut out in the middle of each for the axle box to slide in. These axle guides have to resist all the strain of the wheels, and those of the driving wheels have to bear the whole force of the engine, which is moved along by the axle of the wheels. They are therefore strengthened by $1\frac{1}{4}$ inch rods, $w' w'$, fixed between each of them, with sockets across their ends, fitting between the two axle guide plates, and fixed to them by bolts passed through both; the extreme rods are fixed to the end frames of the engine, as in Plates LXXXIX. and XC.; the axle guides for the small wheels have also bolts fixed through the bottom.

$R' R' R'$ are the axle boxes in which the axles turn; they are all alike, and are shewn to three times the scale, or $2\frac{1}{4}$ inches to a foot, in figs. 38, 39, and 40. Fig. 38 is a section along the centre of one of them; fig. 39 is a cross section; and fig. 40, a plan of the top. AA is a cast iron box, open at the bottom and the inner side, and $4\frac{1}{2}$ inches wide, so as to fit into the opening in the axle guides. A hollow, BB , is cast in the top of the box AA , for the purpose of holding oil to

supply the bearing, and in it is cast the socket *C*, in which the end of the spindle attached to the spring rests. The inside of the box is octagonal at the top, as shewn in fig. 39, and has the brass piece *DD* fitted into it; which is turned out in the inside to fit the end of the axle, reaching down to the centre, and having a small projection, *E*, on each side, which fits into a corresponding notch in the sides of the box *AA*, and serves to hold the brass steadily. Two thin brass tubes, *FF*, are screwed into the brass, and pass through holes in the top of the box *A*, projecting up into the hollow *B*, containing oil; and cotton thread is put into them, dipping

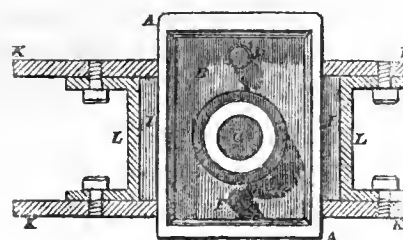
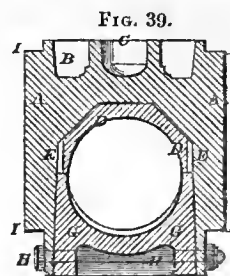
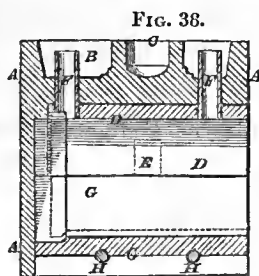

FIG. 40.

into the oil and touching the axle at the other end, acting like a syphon in furnishing a constant supply of oil to the axle, as in the oil cups before described. The bottom is closed by the cast iron piece *GG*, made tapering to fit closely to the sides of the axle box, and held in by the bolts *H*; and hollowed in the inside so as to clear the axle, the position of which is shewn by the dotted lines. A piece, *II*, is cast on each side of the box, projecting half an inch, which fits exactly between the two axle guide plates, and slides between them; as shewn in the plan, fig. 40, where *KK* is a horizontal section of the axle guides; *LL* are pieces of iron plate bent so as to fit accurately between the plates *KK*, and bolted to them, as shewn in Plate XCII.; the faces of the pieces *II* bear against them, and they are both made true and smooth, so as to allow the axle box to slide up and down easily and without shaking. The top of the box is covered by a piece of sheet iron, with a hole in it for the spindle of the spring, in order to protect the oil.

S'S'S' are the springs, made as usual of separate steel plates; those for the driving wheels, *D'*, are the strongest, consisting of thirteen plates, 4 inches wide, and five sixteenths of an inch thick; the other springs are 3 inches wide, the front ones having twelve plates and the hind ones eight. The four small springs are placed under the outside frame, and their ends rest in sockets *x'x'*, fixed to the frame, and are kept in by bolts put through the sockets. The larger springs are turned over at the ends and take hold of short bolts, having the links *y'y'* fixed on them; the lower ends

of which are fixed to cross heads on bolts, which are put down through holes in the side frame and fixed by nuts underneath. A square iron socket is fitted on to the centre of each spring, and has a steel pin z' , $1\frac{1}{8}$ inch in diameter, fixed into its under side, the lower end of which rests in the socket on the top of the axle boxes, (*C*, figs. 38, 39, and 40,) and thus the frame $N'N'$, which bears the whole weight of the engine, is supported by the ends of the springs, which rest at their centres upon the axles of the wheels. The bearing pins z' of the middle springs pass through holes in the side frame, which serve to steady them when playing up and down; other pins are fixed in the upper side of the sockets on the other springs, which pass through holes in the frame above for the same purpose.

At the ends of the part of the frame O' , in front of the engine, are fixed the buffers $T'T'$; they are strong leather cushions stuffed with horse-hair, and are placed there for the purpose of deadening the shock of any collision with another carriage. Buffers are fixed upon each end of carriages of every description that run upon a railway, being all fixed at the same height and distance apart, in order that they may be the only parts of the carriages that ever touch each other; those on the engines are sometimes made with a large spiral spring inside, that their action may be more perfect. In the centre of the end frame O' , is fixed a strong chain and hook, a'' , for attaching the train of carriages when the engine is running backwards; a small iron plate being placed on each side of the frame for the bolt that holds the chain to be fixed against. A strong staple is also fixed into the frame on each side of the chain, as an additional means for attaching the train. The foot-board U' , upon which the engine man stands, rests upon cross pieces of wood that are fixed to the piece of the outside frame P' , at the back of the engine, and supported at the other end by the plate b'' ; a hand-rail is fixed on each side of the foot-board as a guard, and to one of these the guides for the hand lever w'' are attached. $b''b''$ are two pieces of iron plate placed across the back of the fire-box, and bent at right angles along one side, forming a flanch which is riveted to the back plate of the fire-box; they are also fixed at the ends to plates which are riveted on to the sides of the fire-box. Through the centre of the plates $b''b''$ is put the draw-pin V , $1\frac{1}{2}$ inch diameter, resting by its head on the top plate, and held by a key put through it under the bottom one; a socket is fitted on to it having a pin projecting from it on each side, on which is fixed one of the links $W'W'$, which are attached in a similar manner at the other end to another socket, connected to iron bars fixed on the tender by a pin, X' , passed through them all; this pin is held by a key underneath, and is taken out when the tender is required to be disconnected from the engine. The socket on the draw-pin V' is supported by a small ring fixed by a set nut; and the link W' can by this means be readily adjusted level,

so as to pull without side strain when the height is altered from the use of another tender or other cause. The draw links $W'W'$ are left free to move in any direction, in order to allow for the play of the springs of the engine and tender, and the oblique direction of the pulling round a curve; when they are disconnected from the tender they can also drop down upon the edge of the plate b'' . The draw-pin V' is required to be strong to resist the great strain to which it is subjected; it is most strained when running down a considerable inclination, as the engine is not then constantly pulling, but the train often pushes against it, and a continued succession of violent jerks on the pin are produced in opposite directions; instances have occurred of the draw-pin breaking under these circumstances in engines where it was not made strong enough for its length.

Splashers, $d''d''$, are fixed over each of the wheels to catch the dirt thrown up by them; those for the middle wheels are of brass and are ornamented, the others of sheet iron, and they are fixed by small stays on to the boiler and the outside frame.

INSIDE FRAMES.—Four wrought iron frames, $Y'Y'$, (Plates XC. and XCI.,) are fixed between the smoke-box and fire-box; to afford additional strength to the engine by securing firmly the back plate of the smoke-box, in which the cylinders are fixed, and which has to bear the whole strain of the working of the engine. These inside frames have also bearings in them for the cranked axle, and hold it steadily against the action of the connecting rods, by which it is strained alternately in opposite directions. The frames $Y'Y'$ are $3\frac{1}{2}$ inches deep, and three quarters of an inch thick; they are attached to the smoke-box and fire-box by means of T shaped pieces of iron, which are riveted on to their inner and side plates, and are bolted to the ends of the frames; the two middle frames are made to approach each other, and are welded together at the back end, so that there are only three bearings on the cranked axle. On to the four frames are fixed the piston rod guides, $A'A'$, by means of pieces of angle iron, as before explained. The frames have to be inclined upwards towards the fire-box, in order to pass above the cranked axle.

The construction of the inside bearings of the cranked axle is shown in figs. 41, 42, 43, and 44, to double the scale, or $1\frac{1}{2}$ inch to the foot. Figs. 41 and 42 are side and end elevations; fig. 43 is a horizontal section through the centre of the bearing; and fig. 44, a plan of the top. The frame, AA , is increased at the bearing to $2\frac{1}{4}$ inches thick, the upper part, B , is $11\frac{1}{2}$ inches wide, and the lower part is formed into a fork, CC , 10 inches long, the sides tapering an inch and a quarter in width. A tube, DD , is fitted between them, having a bolt passed through it by means of which the two sides of the fork are held firmly together. Two iron wedges, EE , are fitted accurately to the sides, so that their inner faces are parallel

to each other, and will remain parallel when moved up and down. Each side, *CC*, has a small projection on its inner side, fitting into a corresponding groove in each wedge, as shown in fig. 41, to guide it when moved; and a bolt, *F*, is carried upwards from each of the wedges *E*, through the upper piece *B*, having a nut screwed upon it at the top; the holes for the bolts are made oblong to allow for the lateral motion of the wedges when they are screwed up. The two brass bearings, *GG*, are inserted between the wedges, having flanges on each side fitted on the faces of the wedges; they are three inches wide, and bored out to five inches diameter, to fit the cranked axle. One of the brasses, *G*, overlaps the other, which is fitted steadily into it, but not quite touching at the ends. They are made to close upon the axle by screwing up the two wedges *EE*, thereby forcing the two brasses nearer together; and they are then free to slide up and down between the wedges to allow for the play of the springs, which affects the engine only and not the axle; and are readily tightened up as they wear from friction, by screwing up the wedges farther.

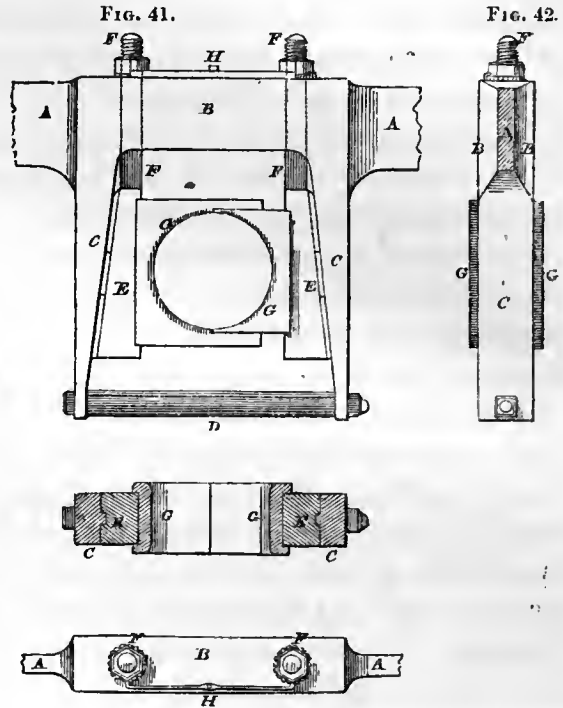

FIGS. 43 and 44.

The cranked axle is thus steadied against the horizontal force of the connecting rods, which is the greatest strain that it is subjected to; but it can have no vertical support in consequence of the play of the springs. A shoulder is made on the bottom of the nuts on the bolts *F*, and cut into teeth, as shewn in the plan, fig. 44, which catch the ends of a small spring *H*, fixed by a screw in the middle. This prevents the nuts from turning round and getting loose with the great jolting to which they are subject, the spring having to be forced out from each tooth in succession to let the nut turn; and though this does not impede the screwing up of the nuts, it is sufficient to prevent their getting loose. The same contrivance is applied to all the nuts in the engine that are used for the adjustment of some moveable part, as those in the glands of the piston rod and slide valve spindle; as these nuts are not screwed hard up so as to keep them fast.

Some engines with four wheels are made without the outside frame, and also

have not the inner ones; and instead of them a strong iron frame is placed immediately within the wheels, bearing upon the axles, and having the whole engine resting upon it; this gives the engine a lighter appearance, as the wheels are quite on the outside. But the outside frame adds considerably to the stiffness of the engine, and is of great utility in that respect, particularly when the engine gets thrown off the line, as happens occasionally; when the outside frame serves materially to protect the machinery. It has also an advantage in enabling the engine man to have access to any part of the engine whilst it is working, as the wheels and the space between them are covered over by the splashers, and can be readily passed over; this is very useful, as the working parts frequently require examining and replenishing with oil whilst running. The friction is less when there is no outside frame, as there are but two bearings on the cranked axle instead of five; but they have to be the full size of the axle, as they are inside the wheels, which much increases the friction of each, and renders the whole but little less than in the other plan; the axle is also not held so steadily as with the middle inside bearings.

WHISTLE.—Z' (Plates LXXXIX., XC., and XCII.,) is a steam whistle used for the purpose of giving warning of the approach of the engine when running; the construction of it is shewn to one quarter size, or four times the scale of the engravings, in figs. 45 and 46. It is all of brass, and the foot, *A*, is cast hollow, with a flanch, *B*, at the bottom to bolt it upon the fire-box; it has a cock, *C*, placed in it, with the handle *D*, and screw *E*, to keep it tight, the handle projecting out to allow firm hold to be taken of it. The cup *F*, is fixed upon the foot *A*, by screwing the piece *G*, upon it, and both are turned truly at their outer edges, leaving a very narrow passage, *II*,

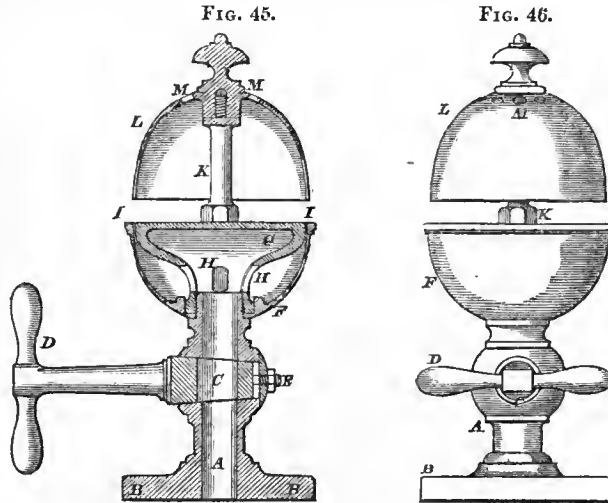

four inches diameter, between them all round. The piece *G* is hollow, having holes, *H*, in its sides; and a pillar, *K*, stands upon its centre, on which is screwed the bell *L L*, the thin edge of which is brought just over the opening *I*, and half an inch above it. When the cock is opened, the steam enters the cup *F*, through the holes *H*, and rushes out at the narrow slit *I*, striking the thin edge of the bell *L*, in a similar manner to the action in organ pipes, and producing an exceedingly shrill sound; some holes, *M*, are made in the top of the bell, to allow the steam to pass

freely through, which improves the sound considerably. The cock is required to be steadily opened to adjust the quantity of steam, so as to produce the clearest sound. The steam whistle is very effective, and its sound can be heard at a great distance.

THE TENDER.

The tender is attached behind the engine and close to it; it contains a tank of water for supplying the boiler, and has a space in the middle filled with coke for feeding the fire. A side elevation of it is shewn in Plate LXXXIX., a longitudinal section in Plate XC., and a plan in Plate XCII.

FRAMING.—The side frames, A" A", are made double, with diagonal bracing pieces inside them, and are connected by strong pieces at the ends. The floor is supported by diagonal and cross pieces, dotted in the plan, which are fixed into the sides and ends; and the joints of these pieces are strengthened by iron plates; the plate in the centre is shewn at x", extending along each of them. An iron bar, B" B", is fixed upon the bottom along the centre, and another bar bolted to it underneath at the front, the two projecting beyond the front, and having holes in their ends through which the pin X' is passed to connect the socket at the end of the drawing links W' of the engine. A chain and hook, y", is fixed on to the other end of the draw bar B", for the purpose of attaching the train of carriages; in this end of the bar a large square socket is made, and is fitted upon the middle of the long spring C". D" D" are the buffers faced with leather cushions, and fixed upon iron spindles which pass through holes in the centre of two blocks of wood, z" z", that are bolted upon the end of the frame; and the spindles have sockets in the outer ends in which the ends of the spring C" rest, and when the buffers strike against those of another carriage they press against the spring C", which yields and reduces the shock of the collision.

WHEELS.—The tender runs upon four wheels, G" G", three feet diameter, which turn in the space between the pieces of the side frames; they are made with flanches, and are similar to the small wheels of the engine. The wheels are keyed upon the axles, which are $3\frac{1}{2}$ inches diameter, and turn at their outer extremities in axle boxes similar in principle to those of the engine; the axle guides consist only of a single plate, each three quarters of an inch thick, bolted on to the inside of the outer pieces of the frame, and the axle boxes have grooves cast in their sides, into which the edges of the axle guides are fitted. The springs H" H" are fixed down upon the top of the axle boxes by two bolts made each into a large eye at the upper end, which fits upon the spring, and the ends of the springs rest in sockets fixed upon the under side of the outer piece of the frame. The tenders for the largest engines are often placed upon six wheels, to diminish the weight upon each wheel.

TANK.—I" I" is the water tank, made of wrought iron plates one-eighth of an inch thick, riveted together and joined at the corners by angle iron; it is of a horse-shoe shape, 9 feet long, $6\frac{3}{4}$ feet wide, and $2\frac{1}{4}$ feet deep. It is supported upon the side and end frames and a cross piece in the middle, and is held in its place by pieces of strong angle iron fixed on to the frame and standing up to hold the front and back ends. The top of the tank is covered with the board K", having sides of iron plate fixed upon it; and a raised part, N", is made at the back, divided into three portions, covered with lids on hinges; the middle one containing an opening, O", into the tank, twelve inches square, surrounded by iron plate brought up to the top, for the purpose of supplying the tender with water. The other spaces on each side are used as tool boxes for holding the different articles that are constantly in requisition in the engine. A copper pipe, P", is fixed underneath each end of the tank, communicating with it, and passing through the floor, having a cock in it to close the pipe when disconnected from the engine. The hose pipes Q" Q", that are attached to the suction pipes K' K', for the feed pumps of the engine, are connected with them by screwed sockets or union joints, which can be readily unfastened when the tender has to be separated from the engine. The hose pipes are made of leather or Indian rubber cloth, with a spiral spring inside to keep them open like the suction pipes of fire-engines; a flexible pipe being necessary to allow for the variations of motion between the engine and tender. There is used sometimes, instead of the flexible hose, a metal pipe with a double ball and socket and a sliding joint, to allow motion in every direction; this has the advantage of not requiring repairs so often as the hose.

COKE.—The middle space of the tender, R" R" R", is occupied with coke, the front end being made level with the foot-board of the engine, and a board, S", fixed inclining from thence down to the floor, for the convenience of taking up the coke with a shovel to throw it upon the fire; the bottom and sides are covered with sheet iron.

The BRAKE for stopping the wheels is shewn in Plate LXXXIX., and consists of two wrought iron frames hung by pins from the side frame of the tender, and having blocks of wood fixed on to them, that are cut to fit the circumference of the wheels. A flat iron wedge fits into grooves in the two frames and is continued up by a rod to the top of the tender, passing through a strong iron piece, W", and having the double handle X" screwed upon it. By screwing down the handle the wedge is drawn gradually up, and the two brakes are separated from each other, pressing the wood of each very forcibly against the wheels until they are stopped, if necessary. This brake is used to stop the engine and train quickly, and others are also used on the wheels of some of the carriages in the train;

the brakes are of many different constructions, but this one is very simple and convenient and has great power. A step and a handle are fixed on to the tender on each side for the convenience of getting upon it or upon the engine.

The tender weighs, when empty, $3\frac{1}{4}$ tons, and about 7 tons when filled with water and coke. The tank holds about 700 gallons of water, and the quantity of coke that is carried is about 8 cwt.; these are sufficient to supply the engine for running from thirty to forty miles, according to the load taken; but the tender is seldom run farther than twenty miles without being refilled.

The power of a locomotive engine cannot readily be estimated in the same manner as that of other engines, by taking the actual force upon the piston, and the velocity of its motion; for it is very difficult to ascertain the effective pressure of the steam upon the piston, in consequence of its differing often very considerably from that of the steam in the boiler, and because of the large amount of the resistance of the waste steam, owing to the great velocity with which the piston moves. The power is also different at different velocities, as these circumstances vary with the velocity. The only correct means therefore, of ascertaining the power of a locomotive, is by deducing it from the work that it is capable of performing.

This engine has drawn a load up an inclined plane that was equivalent to 220 tons gross weight upon a level, (including engine and tender,) at a velocity of 14 miles an hour; which appeared to be about the extent of the power of the engine with the steam at the usual pressure of 50 lbs. on the square inch, in the boiler. The force required to perform this, is about 2050 lbs. moving at that velocity; which is equal to 77 horse power. The effective pressure on the piston, or the actual force with which it was propelled, must therefore have been $47\frac{1}{2}$ lbs. per square inch, instead of 50 lbs., which was the pressure of the steam in the boiler; the difference being the power that was lost by the resistance of the waste steam, and by the diminution of the pressure of the steam, in consequence of the throttling or wire drawing that takes place in passing through the ports of the cylinders, and which was in this instance very inconsiderable.

The horse power of an engine is less when drawing a lighter load at a greater velocity, as the loss of power from the throttling and the waste steam is then increased; and it would cease altogether at a certain speed, varying according to the proportions of the engine, when the velocity of the piston became as great as that with which the steam can enter into the cylinder, or the waste steam escape. This engine has drawn 40 tons at 35 miles an hour, which is equivalent to 40 horse power; in which case the ef-

fective pressure on the piston must have been only 10 lbs. on the square inch, or but one fifth of that of the steam in the boiler. This shews the great loss of power in working the engine so quickly; the loss at 14 miles an hour having been very little. This loss of power is lessened by making the wheels larger, the velocity of the piston being by that means diminished; and they are consequently made as large as is practicable.

The power of a locomotive engine is limited only by the evaporating power of the boiler, or the number of cylinders' full of steam that can be supplied in a given time, by which the velocity of the piston is determined; while in other steam engines the size of the cylinders is the limit to the power, as a sufficient quantity of steam to supply them can be readily obtained by increasing the size or number of the boilers, which cannot be done in a locomotive. This engine is capable of evaporating 77 cubic feet of water per hour, or eight gallons in a minute; and the large amount of this power causes its great superiority to the old locomotives, which could evaporate only about 16 cubic feet per hour.

The consumption of fuel per mile for every ton of the gross load is about a quarter of a lb., and that of the water is rather less than a quarter of a gallon; the consumption increasing to nearly one half, according as the engine is less fully loaded, being proportionally greater with a light load; the consumption of water, when working with a full load, is a cubic foot per hour for each horse power, which is also the usual proportion in stationary engines although they condense the steam. About 8 lbs. of fuel is required to evaporate a cubic foot of water, being nearly the same as in stationary engines; but in the old locomotives as much as 18 lbs. was required, in consequence of their having so small a heating surface, which was only about two and a half square feet for each foot of water evaporated per hour; the proportion in the present one being five and a half square feet, and in stationary engines as much as eight.

The great perfection of the present locomotives, and their superiority to the old ones, is caused not so much by the application of new inventions to them, as by the combination of many former ones, and the uniting together several plans which, separately, would be but of small value. Their great power and velocity, for example, could not have been obtained without the rapid means of generating steam afforded by the use of the tubes; and the tubes would have been useless, without the powerful draught produced by the blast, which increases in intensity with the velocity, and with the necessity for its increased action.

PLATE XCIII.

This plate contains drawings of the Comet, the first steam boat in Europe, constructed by Mr. Henry Bell, of Glasgow, for the Clyde River. To some of our readers the following circular respecting this boat may be interesting.

“STEAM PASSAGE BOAT, THE COMET, BETWEEN GLASGOW, GREENOCK, AND HELENSBURGH, FOR PASSENGERS ONLY.

“THE subscriber having, at much expense, fitted up a handsome vessel to ply upon the river Clyde, between Glasgow and Greenock, to sail by the power of wind, air, and steam, he intends that the vessel shall leave the Broomielaw on Tuesdays, Thursdays, and Saturdays, about mid-day, or at such hour thereafter as may answer from the state of the tide; and to leave Greenock on Mondays, Wednesdays, and Fridays, in the morning, to suit the tide.

“The elegance, comfort, safety, and speed of this vessel require only to be proved, to meet the approbation of the public; and the proprietor is determined to do every thing in his power to merit public encouragement.

“The terms are, for the present, fixed at four shillings for the best cabin, and three shillings the second; but beyond these rates, nothing is to be allowed to servants or any other person employed about the vessel.

“The subscriber continues his establishment at Helensburgh Baths, the same as for years past, and a vessel will be in readiness to convey passengers in the Comet from Greenock to Helensburgh.

“Passengers by the Comet will receive information of the hours of sailing, by applying at Mr. Houston’s office, Broomielaw; or Mr. Thomas Blackney’s, East Quay Head, Greenock.

“Helensburgh Baths,

“Aug. 5, 1812.”

“HENRY BELL.”

Mr. Bell presented this new method of navigation to the British government at three different times, viz., in 1800, 1803, and 1813, when, after all his exertions, it was thought to be of no utility to government. After it was denied him in 1803, he thought it very hard that such a discovery should lie dormant, and on that account he sent a description of the method of applying steam, in propelling vessels against wind and tide, to all the emperors and crowned heads in Europe, and also to America, which last government put it in practice in the year 1806.

PLATE XCIV.

VIEW OF THE PACHA'S STEAM VESSEL OF WAR, THE NILE, AT SEA,
IN THE NILE.

The construction of this vessel is shewn in Plates CIV. to CVII., and full particulars respecting her will be found in the description of those plates.

PLATES XCV. AND XCVI.

THE HONOURABLE EAST INDIA COMPANY'S STEAM VESSEL BERENICE.

This beautiful vessel, which is of 680 tons, was built in the Clyde by Messrs. Wood; and her engines, 230 horse power, were manufactured by Mr. Robert Napier, of Glasgow.

From the log of her voyage from Falmouth to Bombay by the Cape of Good Hope, performed between the middle of March and the middle of June 1837, the results expressed in the following Table have been derived :—

Voyage performed.	Distance in nautical miles.		Time occupied, in days and hours.	Rate per hour in miles.		Coal expended.		Oil expended, in gallons.	Tallow expended.	Work of a ton of coals, in miles.
	Measured.	By log.		Meas. dist.	Log. dist.	tons.	cwts. per hour.			
Falmouth to Teneriffe..... }	1430	1572	d. h. 7 7	8·2	8·9	127	14·5	124	380	11·2
Teneriffe to Mayo B. Vista..... }	840	952	4 9	8·0	9·0	84	16·2	17	240	10·0
Mayo B. Vista to Fern. Po..... }	2180	2272	11 5	8·1	8·4	155	11·4	39	1770	14·1
Fernando Po to Cape Good Hope. }	2340	2594	14 5	6·8	7·6	267	15·6	52	1614	8·1
Cape Good Hope to Mauritius..... }	2290	2692	13 0	7·3	8·6	246	16·2	48	578	9·3
Mauritius to Bombay..... }	2520	2847	13 18	7·6	8·6	197	11·9	55	—	14·4

The boilers are three in number and of copper; they are blown out every two hours. There is no gauge on the steam-chest, or for the steam; and there are nine

fires. The wheels, which are of the common kind, are about 22 or 23 feet in diameter, and the boards 9 feet wide. The cylinder is 56 inches, and the stroke 5 feet 6 inches.

Plate XCV. presents a view of the vessel at sea, off Bombay; and Plate XCVI. shews the sheer draught, lines of bottom, &c.

GENERAL OBSERVATIONS UPON THE CONSTRUCTION OF STEAMERS.

The construction of the draught should be made with very strict attention to the weight of the hull, fittings, stores, engines, coals and cargo, (if required to take goods,) reducing as much as possible the component parts of the hull, and giving that form which is best adapted for velocity.

It should be particularly considered, as stated by Sir Robert Seppings, that the strength of any fabric consists in the disposition of the materials, (in the connection and security of its several parts,) and that "*the strength of a vessel, let its construction be what it may, can never exceed that of its weakest part;*" or that "union is strength," i. e. giving the required strength with the least quantity of wood, copper, iron, &c.; keeping every part of the fabric as tight as is consistent with safety, equal to contend with the violent action and impulse it will be subject to at sea. The fastenings recommended, (and which have been so extensively introduced,) are those laid down in "The New Principle of Ship Building," by Sir Robert Seppings; a system of trussing and diagonal ties of iron. (Vide the Philosophical Transactions.)

The form should be, in midships, nearly a square with the corners rounded off, or "a long, flat floor" gradually rising to an acute angle at the extremes, or fore and after bodies, similar to the water lines or horizontal sections of those renowned and celebrated schooners of America called "Clippers." The dead wood or extreme fineness abaft being done away, as shewn in the following diagram:

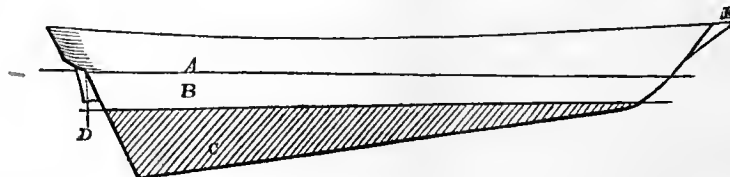

A, The water or horizontal *load* line.

B, The new line of keel, the dead wood shewn by the shaded part to be done away with.

C, The old line of keel.

D. The new line of post, with the rake taken out and brought perpendicular to the new line of keel, *B.*

E. The stem to have a flare or flam to correspond with the bow.

To prevent rolling as much as possible and falling to leeward, two deep bilge keels to be fastened to the bottom plank, with bolts clinched on the inside. (These keels have been well tested in certain vessels belonging to the Honourable East India Company, in Bengal.)

The fore and after bodies of the American schooners (applied as just described) have been proved to be the best suited for velocity, the sharp flaming bow dividing the fluid with the greatest facility, and the fineness of the run allowing it to pass to the stern with the utmost rapidity.

This improved form is obtained by giving a great proportion of length to breadth, which has been so successfully adopted in the construction of all recently constructed steamers (particularly those built by private companies or individuals). It is recorded in the translation of Chapman's celebrated work by Dr. Inman: "Care must be taken to shape the fore and after bodies, the former so that the fluid may be cloven with facility, and at the same time the displaced fluid dispersed and transmitted towards the stern with as much ease as possible." Velocity in steam vessels is, therefore, obtained by a light draught of water, and keeping the fore and after bodies sharp, and giving the least proportion of length to breadth with reference to the *required* stability, viz. for sea-going steamers, six times the breadth for the length at the load water line; in vessels for inland or river navigation, the length has been carried to ten times the breadth in some of the American boats. Vide Stephenson's late work on American Engineering.

PLATE XCVII.

DRAUGHT OF THE FORBES STEAMER, CONSTRUCTED AT CALCUTTA,
BY ALEXANDER HENDERSON, ESQ.; CHINESE RIGGED.

This plate presents a sketch of the masts and sails of the steamer Forbes, as fitted when she towed a ship of 380 tons from Bengal to China against the monsoon in 1830, with the fore-sail and main-sail; the plan of the Chinese sail was adopted as best suited to the purposes of a steamer, giving the greatest spread of canvas, with the least weight of mast and rigging; the stretchers or yards in the body of the sail, by dividing the strain on the mast, are useful to reduce the weight aloft and require little rigging;

besides facilitating the working and reefing of the sail. These sails act best sailing by the wind; and there being no depôt of coals in China, to return to Singapore with a fair wind, a fourth mast was fitted in an iron step or trunk immediately in front of the boilers; with a square-sail, top-sail and topgallant-sail, with their studding-sails. While steam power was used, this mast was lowered fore and aft, as shewn by the ticked lines.

PLATE XCVIII.

HERNE BAY STEAM PACKET RED ROVER.

The engines, two 60 horse power, are by Messrs. Boulton and Watt, and the vessel was built by Messrs. Fletcher, Son, and Fearnall, London; launched 28th March, 1835, for the Herne Bay Steam Packet Company.

PRINCIPAL DIMENSIONS OF THE HULL.

	Ft.	In.
Length between the perpendiculars	154	0
Breadth to the outside of the bottom plank	22	4
Depth at shaft from top of floor timber to the under side of deck	10	4

Burthen in tons, $376\frac{3}{4}$ (builders' measurement).

This vessel was constructed for the conveyance of passengers and luggage to and from London to Herne Bay with the greatest possible dispatch, and comparing her displacement and power with other similar vessels, was and continues the fastest running out of the Thames. This superiority of speed was chiefly effected by a novel mode of building, a mode combining the fourfold advantages of increased buoyancy, a more uniform diffusion of strength, prevention of rot by exclusion of surfaces, and affording the greatest possible facility to repairing.

The bottom, or that part of it on which the engines and boiler were fixed, was composed of stout floor timbers going from bilge to bilge, placed close together and dowed and bolted to each other, and planked externally with the best well seasoned four-inch Dantzic deals, fastened in the usual manner; but above, before, and abaft this part of the bottom so wrought, the timbers of the frame used in common were omitted, and the plank continued of the same thickness to the top of

the sides, having the edges grooved and tongued, and secured to each other by $\frac{3}{4}$ bolts driven through the edges in a diagonal direction at about 15 inches apart ; in addition to which, long diagonal iron plates, 4 inches broad by $\frac{5}{8}$ ths of an inch thick, placed at an angle of 65° , and 2 feet 6 inches from each other, were worked each on a Dantzic fir plank $2\frac{1}{2}$ inches thick and 9 inches broad, the whole secured by a through bolt in each outside strake, having a screw point and nut setting up on the diagonal plate inside the vessel.

It must be obvious to all persons acquainted with the nature of shipbuilding, that the hull of a vessel so built would offer the greatest advantages to the caulking, requiring but half the usual quantity of oakum, and that stopped from being driven through the seams by a strong oak tongue bedded in white-lead uniting the edges of the planks. The uniform strength of the entire hull has very far exceeded all expectation, and in the opinion of those acquainted with its nature this method is admitted to be superior to any yet practised.

PLATE XCIX.

DIAMOND COMPANY'S STEAM PACKET RUBY.

This plate represents a drawing of the Ruby steamer, which belongs to the "Diamond" Company, plying between London and Gravesend, and is unquestionably the fastest boat on the Thames. We do not make this assertion upon mere hearsay, having had frequent opportunities of satisfying ourselves of the fact. It would be entering too much into detail to give a statement of the progressively improving character of the various steam boats which have plied between London and Gravesend during the last ten years ; it is enough for our present purpose to state that the "Diamond" and "Star" Companies keep up an establishment, upon an average, of a dozen boats, of a very superior description, every thing connected with their appointments being upon a most liberal scale. The vessels belonging to the "Diamond" Company are, the Diamond, Pearl, Gem, Brilliant, Topaz, and Ruby ; and those belonging to the "Star" Company are the Mercury, Star, Comet, Planet, and Vesper, one of the boats, Medway, having been burnt by accident during the summer of 1837. Until the beginning of the year 1837 (at which time the Ruby was placed on the station) the Star was considered to be equal in speed to any of the above ; indeed it may be said that no vessel that navigated the Thames could

equal her, except perhaps the Diamond, and the City of Canterbury, (running from London to Herne Bay and Margate;) with these exceptions it is admitted that in velocity the Star was unrivalled.

Vessels of the greatest speed will always command a decided preference; hence it is to the interest of proprietors to apply to the most skilful naval architects and engineers, to procure vessels which shall combine speed with strength and durability.

The Ruby built by the "Diamond" Company, at Mr. Wallis's ship yard, Blackwall, in the early part of the summer of the year 1837, possesses the above essential qualities in an eminent degree, which has induced us to solicit the favour of her plans for publication.

Mr. O. W. Lang, who designed the Ruby, has obligingly presented us with the lines, and put us in possession of many particulars respecting her.

Her length is 155 feet between the perpendiculars; 141 feet $9\frac{1}{2}$ inches on the keel for tonnage; breadth for tonnage 19 feet, moulded 18 feet $5\frac{1}{2}$ inches; depth in hold 10 feet 2 inches; and burthen 272 tons. She is propelled by two engines of 50 horse power each, made by Messrs. Seaward and Company, of which the following are some of the most important particulars:—diameter of cylinder 40 inches; length of stroke 3 feet 6 inches; number of strokes per minute 30; diameter of paddle wheel 17 feet 6 inches; length of paddle board 9 feet 2 inches, and depth 15 inches; dip or immersion 15 inches. The practical construction of the vessel is upon a principle recommended by Mr. O. W. Lang, and invented many years since by Mr. Johns, a clever practical officer of Plymouth Dock-yard. It consists of an outer surface of plank, placed horizontally in the usual manner, but of an inch and a quarter only in thickness, the timbers being substituted by two other thicknesses of plank, laid diagonally to the keel, but at right angles to each other, with felt introduced between the layers, the whole three being fastened together by nailing, in the same manner as a clench work boat. Vessels built in this manner have been found to be far less expensive (at least 20 per cent.) than vessels built in the usual way; they also possess greater strength, and judging from the trials that have been made of ships' launches and other large boats for the Navy*, for several years past, there can be no doubt of their durability. The comparative lightness of vessels built in this manner is also a great recommendation. The Ruby, when launched, was found to displace only 65 tons of water. Her draught, with her engines and fuel on board, complete in all respects, was only 4 feet 8 inches abaft, and 4 feet 1 inch forward; her displacement 170 tons, and the area

* The boats built for the Navy are only of *two* thicknesses, the outer (fore and aft) planking being deemed unnecessary. They are well known as Mr. Johns' double bottomed diagonal built boats, and are held in high estimation.

of her midship section 63.2 feet; under these circumstances her speed through the water has been ascertained by careful trials to be 13.5 miles per hour, no other vessel having yet exceeded the rate of 12.7.

PLATES C. TO CIII.

DESCRIPTION OF HER MAJESTY'S STEAM VESSEL OF WAR MEDEA, CONSTRUCTED AND BUILT BY OLIVER LANG, ESQ., MASTER SHIPWRIGHT, ROYAL DOCK YARD WOOLWICH;—

Shewing the mode of putting her frame together so as to obtain and produce the greatest combination of strength in connecting the various parts of the ship, and distributing the fastenings equally throughout the fabric.

		Light.		Deep.	
		Feet.	In.	Feet.	In.
Draught of water	{ afore	.	.	7	0
	{ abaft	.	.	9	1
Displacement in tons	.	.	.	502	81
Area of midship section	.	.	.	168	84

The keel was made secure on his principle of the "safety keels;" the inner or solid one, fitted to the floor timbers in midships, and to the deadwood afore and abaft, with dowels on the upper or faying part, connecting the floors, deadwood and keel together; the under side of the keel projecting a few inches only beyond the bottom, protected by a longitudinal piece of timber, fitted all fore and aft on each side, substituting the chocks usually brought on the heels of the timbers, to fashion them at that place, and of sufficient size not only to make good the said chocks, but likewise the plank of the bottom (commonly called the garboard) in one solid substance; those pieces are placed one on each side of the inner keel, with felt between the faying surfaces, dowelled and connected together by bolts, driven athwartships through all and clenched on a ring at the outer sides of the longitudinal pieces, and likewise in an up and down direction, through the frame timbers, similarly clenched; the inner or solid keel as before described, is previously dowelled and bolted in a vertical direction through the floors, deadwood and keelson, in addition to those longitudinal pieces or side keels, the ends of the bolts being well clenched on rings, thus

making the base of the fabric perfectly secure and strengthening the most important part of the ship. Vide section, Plate CII.

The timbers composing the frame of the lower part of the ship, are strengthened by solid fillings caulked and made water-tight from the keel to about four feet above the turn of the bilge, so that if the vessel should by accident at any time take the ground, and disturb the outer or false keel with such part of the planking on the lower part of the bottom as might by any possibility come in contact with the rocks, yet she would be perfectly safe, as the inner or solid keel could not be removed but only ground away in such places as bore against the shore, it being firmly attached to the fabric.

The lower part of the stern post (vide Plate C.) is united to the after end of the solid keel, by a knee piece scarphed and grooved at the after end, and scarphed and dowelled at the fore end, bolted through and securely clenched on a ring at the end of each bolt, instead of the old method, a mortice and tenon, as generally adopted by shipbuilders in this and all other countries, which insufficient mode has caused the loss of many vessels. The lower piece of stem is scarphed to the foremost piece of keel horizontally, and not with a vertical or side scarph in a square boxing,—that dangerous system so long practised in vessels of all descriptions,—but on the contrary, forming no projecting butt, to the fore end of the keel; should the gripe be carried away by the ship striking the rocks, the remaining surface of the keel and bottom would offer no resistance to the cable after such an accident, but would retain a similar shape to the original form of the ship when in its perfect state.

The whole frame is connected together by iron braces on the inside, placed in a diagonal direction, let into the timbers about half their thickness, and having one bolt passing through every timber for their security, and a wood trussing of four-inch plank in the opposite direction, to prevent the hull of the vessel from hogging or altering her form; between the wood trussing, the timbers are covered by board of one inch and a half thick, secured at the ends on a cant two inches square, so that the board may bear only on the cants, and allow a current of air to pass throughout the ship.

The upper deck beams are secured to a shelf or thick clamp, which extends all fore and aft on both sides of the ship and embraces every timber; the beams are dowelled and bolted to the said clamp, their ends extending without over the top-side to connect the sponcing, being scored and let into the sponcing timbers, dovetailed, and bolted in a fore and aft direction; a thick strake is then worked on the outside on the ends of the beams against the timbers forming a sheer strake, scored half way between the said timbers to meet the thick water-way, which is scored in like man-

ner to meet the sheer strake from inside; felt is placed between the joint vertically, the whole bolted together with bolts driven horizontally and well clenched on a ring at each end; the under side of the water-way is scored dovetail about one inch and a half over the beam; on the upper part of the sheer strake and water-way, felt is laid, and on that a plan sheer or gunwale placed, which is bolted through the water-way and plan sheer in a vertical direction and clenched with a ring on each end of the bolt to keep it down and make it firm. The sponcing timbers run up to the rough tree rail, their heels stepping on a thick strake worked in the side of the vessel and well bolted, forming a rabbet which receives the planking, making a secure artificial topside in addition to the common topside of the ship. Vide section, Plate CII.

The engine bearers are dowelled and bolted firmly through the bottom, scored on the under part to receive the nuts for securing the hold down bolts which prevent their passing through the outside plank and creating danger.

Plate CI. shews the plans of the upper and lower decks, under which there is a fore and after platform, exclusive of her store-rooms and magazine; on these platforms there is provision made for berthing in hammocks 145 men in addition to her ship's company, which are berthed in like manner on the lower deck, the fore side of the engine-room; on the aft side the officers' cabins are shewn; the planks of the lower decks, both afore and abaft, are laid athwartships, rabbeted into the sides of the beams, which are considerably less in number than if the deck were laid in a fore and aft direction on beams as usually done; the beams are secured to the side by iron knees.

The upper deck is laid in a fore and aft direction on substantial beams, made particularly strong on the fore and aft parts with carlings well pillared under the deck in wake of the great guns, which are both of ten inches calibre, and worked on a carriage and slide with pivots, which admits of their being turned in any direction that may be required; the bulwarks above the plan sheer are light, the fore and aft parts fitted to drop in several pieces by iron stanchions, forming a hinge, so that the whole or any part required can be let down clear to admit of the guns being run well out, that their muzzles may not interfere with the side of the ship when firing.

Her tiller is under the upper deck that it may not obstruct the working of the guns; an iron plate is attached to the head of the rudder, with three holes, one in the centre and one on each quarter; an iron plate is fitted on the head of the stern-post, and when the rudder is required to be secured in midships, a pin is dropped into the centre hole of the plate on the rudder, which passing through this and the plate on the post, fixes the rudder immediately in midships; the same may be done by re-

moving the pin to one of the other holes, when the rudder may be placed on the quarter on either side if at any time it may be required to lay the ship to, to shift the tiller, or to reeve new ropes to the wheel. The heel of the mainmast is fitted in an iron crutch with a strong pillar, in order to bring the mast nearer its proper position for sailing, which otherwise would be prevented by the boilers.

In corroboration of the foregoing facts we shall here state a most extraordinary circumstance. Her Majesty's frigate, the *Pique*, of thirty-six guns, built with Mr. Lang's safety keels, had the misfortune to run on the rocks near the strait of Belle Isle, on the 22d of September, 1835, and tore off her false, and likewise her outer main keel all the way fore and aft, and ground away, in four different places, the inner or solid keel, and the longitudinal pieces at those parts forming the garboard connected thereto, which being so firmly attached to the ship bore the violent friction of such ponderous weight, the frigate with her guns, stores, &c., in contact with the rocks without being displaced, and the vessel was got off, preserved from shipwreck, and brought to England in safety, although encountering very severe gales of wind on her passage. Several instances have occurred of other ships fitted with the safety keels getting off the rocks without admitting any water. We shall now mention two cases, not only to prove the safety of vessels fitted with the keels in question, but to shew the strength of the fabric of ships built like the *Medea*; those alluded to are the *Lightning* and *Flamer* steamers, constructed by Mr. Lang, and built under his superintendence. The former vessel, the *Lightning*, on her first proceeding to sea, ran ashore a little below Sheerness, on the Spaniard shoal, fell over on her side where she lay dry at low water; she floated again at high water, and it was found she had sustained no damage. As she was entering Dover harbour, soon after, she ran full speed against the pier and struck her fore-foot or gripe, knocking it over on one side, but made no water; on being docked at Portsmouth after this, her gripe was replaced and no other injury appeared. The next important occurrence happened when at Jersey: being aground alongside the pier, and a rope made fast to her mast-head, secured to the shore to keep her upright, the water having left her dry above one hundred and fifty feet, the rope broke and she fell violently down on her side; this shock was severely felt in the engine-room, but she sustained no injury in the hull nor machinery by the fall; at high water she righted again and sailed across the Channel to the Downs, where she was run into, just abaft the starboard paddle-box, by a loaded collier, which did the *Lightning* but little harm in her top-side and sponcing, but the collier, by the concussion, stove in her bows, ran on shore to save her from sinking, and became a wreck.

In the heavy gale of wind in February, 1833, the *Lightning* was in the Irish Channel on her way to Dublin, with the *Erin*, a large steam vessel, when the latter

foundered in the gale, and the Lightning had the misfortune to run on shore, but was got off with the loss of part of her keel and gripe; notwithstanding, she made the voyage in safety, continued at sea for two months after the accident, and did not leak in any part, was taken into dock, her keels and gripe replaced, and damages made good.

In the month of December following the Lightning sailed from Falmouth on the same day as her Majesty's steamer Columbia; in the course of the day she passed her, the wind blew very hard and increased to one of the most tempestuous gales that had been known for several seasons; so severe was the wind that the Columbia was obliged to put back, and from the situation in which she left the Lightning, considered the latter had foundered; but the Lightning proceeded on till she arrived at Corunna, and from thence to Lisbon. On her way to the latter place, when about forty miles distant from it, she discovered a vessel in distress under the rock firing guns, being on a lee shore; the Lightning immediately went to her assistance, and found her to be H. M. brig Plover, of ten guns, which had sailed from Falmouth eight days before the Lightning; she towed her off from the land, and leaving her with a good offing continued on for Lisbon, there delivered her dispatches to the admiral, and returning to the Plover, again took her in tow and conducted her safely into port.

In October, 1834, the Lightning ran over the Coal Rock, near Elsinore, going between eight and nine knots; this had about a foot less water over it than her draught, but she was brought up against and hung by the middle upon another rock, where she remained ten hours, dropping and rising head and stern successively. The consequence was that her gripe, part of the fore piece of keel, and midship piece, by which she was hung on the rocks, were carried away, the whole of her keel all fore and aft about two or three inches from the under side against the rocks; after getting off in this injured state, she experienced a heavy gale of wind, which lasted four days, and from which she sought shelter at Heligoland, but there she parted both her cables and was driven to sea; although the sea was running as high as her funnel, she shipped nothing but spray; at the same time the Superb, a common built steamer, was lost. It was observed by those on board the Lightning, that while on the rocks and in the gale she did not work or strain in any part; not a seam or a butt opened, nor was even the pitch broken in any place; no sign whatever of altering her form but remained perfectly tight. On repairing the keel it was found, on removing the damaged part, that it was quite dry within, and no water had penetrated into the hull of the vessel; the calking of the seams and wood ends, notwithstanding the heavy shock in dislodging the gripe and keel, was hard and sound and not started in the least, thus proving the strength of the

fabric; since which she has been on shore on the coast of Spain, while employed on that service in January 1837, rubbed off the copper from her keel, and in February 1838, at Holyhead, she had the misfortune to run on the rocks, and struck off her gripe and foremost piece of keel, immediately after which she encountered a very severe gale of wind for three days, and did not strain or leak in the smallest degree. This vessel has also performed many difficult voyages in various parts of the world, viz., Mediterranean, Spain, Portugal, France, Holland, Denmark, Sweden, Russia, Scotland, Ireland, &c., and experienced very bad weather. She was at the battle of Algiers, and was very useful in towing and placing the ships in order of battle, and towing from under the batteries such vessels as drifted within the reach of the enemy's guns.

The Flamer went on shore on the rocks at Zante in the Mediterranean, going nine knots, and ran up two feet less than her draught of water; she remained on shore twenty-two hours, carried away her fore piece of keel and gripe, tore off the copper from her bilge, and injured the plank of her bottom; she was lightened and got off, came to England safely; previously she was run into by a Spanish ship just abaft the paddle box, which stove in the sponcing at that place without affecting the Flamer in any other part; the Spaniard received much damage in running foul, and on getting clear left the knee of her head behind, which was broken off in the Flamer and brought home. When taken into dock about six weeks after, the calking was found hard and sound, even close to those parts of the keel that were carried away, and the ship shewed no appearance of straining, or having suffered in her fabric by the violence of the blows she sustained in running on shore, or by being struck by the Spaniard. On this principle of strength Mr. Lang commenced the construction of sea-going steamers, having designed and built the first for sea service, an experiment at that time considered impracticable.

The steam vessels he has constructed for her Majesty's service are the Comet, 237 tons, engines 80 horse power, for towing men-of-war from one port to another; Advice (late Vixen), 185 tons, engines 80 horse power, for the Post Office service between Holyhead and Dublin; Lightning and Meteor, 296 tons each, engines 100 horse power, for towing ships and any sea service required; Pluto, 365 tons, 100 horse power, for the suppression of the pirates on the Bahama Banks, armed with two long eighteen pounder guns, one afore and one abaft, on a carriage and slide to traverse on a sweep; Flamer, 492 tons, 120 horse power; Firebrand, 492 tons, engines 120 horse power, Mediterranean packets; the Firebrand has since become the Admiralty yacht; Medea, 843 tons, engines 220 horse power, war steamer; Firefly, 549 tons, engines 140 horse power, and Spitfire, 553 tons, engines 140 horse power, Mediterranean packets; and Ionia, 263 tons, engines 90 horse power,

packet for the Ionian Islands; all which are built on the same mode of security as the Medea, and have proved to be excellent sea boats, possessing speed, ease, and comfort combined with superior strength of fabric.

PLATES CIV. TO CVII.

CONSTRUCTION OF THE NILE STEAM SHIP, BUILT FOR THE BASHAW OF EGYPT.

That steam vessels will become of more and more importance, as well in a commercial point of view as in warfare, is a point now generally admitted; and though they may never entirely supersede the vessel impelled with sails, it is likely they will ultimately be employed in all services for which sailing vessels are now used—except that of the service for which ships of the line are employed. In carrying on experiments for the general improvement of steam navigation, there must necessarily be failures; but the advantages and particular interest the introduction of an extensive steam navigation involves, must ultimately engage the energies of every nation at all interested in maritime pursuits, and desirous of the benefits that an extensive application offers.

The use that these vessels are found to be in towing ships in and out of harbours, and carrying mails, is now evident; and the advantages proposed by them in warfare are too great to suffer the neglect of any experiment that may bear any evidence of improvement. With a proper rig, they may be rendered effective for almost every purpose for which sailing vessels are employed; while their disadvantages on comparison are small. The liability of their machinery to be destroyed by shot, and the space and weight of machinery required for impelling the vessel, are the greatest objections that can be urged against them:—and may be particular objects for the attention of engineers.

In the construction of the Nile these were subjects particularly attended to, without speculating beyond what was warranted by experiment: to reduce the consumption of fuel by her engines, bad conductors of heat were placed over her boilers, &c., such as felt and cement; and from their construction and position, a greater space than common was obtained for the coals. To ensure, as far as possible, the protection of the engines in the event of her being engaged in warfare,

wings were formed on both sides that might be filled with such light substances as would resist shots when required—as cork, bags of flax, &c., or if required, the seamen and soldiers' beds. With the protection that may thus be afforded, the Nile could be rendered quite as efficient in every respect as a sailing vessel; for with the security thus obtained, the only parts unprotected would be the paddle wheels and chimney, which probably would not offer more exposure to shot than the masts and yards of sailing vessels: while with the paddles and chimney injured, the Nile has still her masts and yards, which are equal for the performance of a voyage. This was clearly proved on her taking troops from Syria to Alexandria;—when from the number of troops on board, and delays occasioned by them, the fuel was exhausted, and the only resource left was her sails.

This vessel was rigged with three masts as a brigantine or ketch forwards, and two masts as a schooner abaft, as may be seen by reference to Plate XCIV.; added to which, when not steaming, several large staysails were set flying from the main to the foremast, so that she could be impelled in strong winds, when close hauled, from eight to nine knots, and off the wind, from ten to eleven knots. When steaming head to wind, the yards could be lowered one on the other pointed to the wind, as low as that when the foremost gun was required to be fired, the explosion would not affect them; and the topmast was then lowered to the deck, being of a length, that when struck, it could be lashed between the trestle-trees, on the fore side of the foremast, so that her mast and yards did not oppose any great resistance when steaming head to wind.

NILE STEAM SHIP.

DIMENSIONS OF SAILS.						DIMENSIONS OF MASTS AND YARDS.							
	Head.		Foot.		Middle.	Leech.	Mast luff, or Stay.			Diameter.			
	Ft.	In.	Ft.	In.	Ft.	In.	Ft.	In.	Ft.	In.	Inches.		
Jib	35	0	...	62	0	84	0	Main mast.....Hounded	84	0	24	
Second jib	30	0	...	48	0	60	0	Headed	14	0		
Fore staysail	36	0	...	36	0	53	0	Main topmast.....Hounded	52	0	13 $\frac{1}{2}$	
Fore course.....	58	0	68	0	40	0	44	0	Pole	10	0		
Fore topsail.....	38	0	59	6	37	0	37	0	Fore mast.....Hounded	70	0	25 $\frac{1}{2}$	
Fore top gallant sail...	29	0	39	6	19	0	21	0	Head	14	0		
Fore top gaff sail.....	39	0	48	0	...	64	0	38	0	Fore topmast to rigging.....	40	0	14
Main gaff sail	34	0	43	0	...	73	0	53	0	Fore top gallant mast to do	19	0	
Main gaff topsail	13	0	38	0	...	41	0	56	0	Sky sail	8	0	
Mizen gaff sail.....	27	0	44	0	...	54	0	40	0	Mizen mast.....Hounded	68	0	18 $\frac{1}{2}$
Mizen gaff topsail.....	10	0	29	0	...	32	0	40	0	Head	10	0	
									Mizen topmast.....Hounded	38	0	7 $\frac{1}{2}$	
									Pole	7	0		
									Bowsprit	43	0	20	
									Jib boom	41	0	10	
									Fore yard	63	6	15 $\frac{1}{2}$	
									Arms	2	0		
									Fore topsail yard	53	6	10 $\frac{1}{2}$	
									Arms	7	0		
									Fore top gallant yard	33	0	6 $\frac{1}{2}$	
									Arms	1	6		
									Main yard	60	0	11 $\frac{1}{2}$	
									Arms	1	6		
									Main topsail yard	38	0	7 $\frac{3}{4}$	
									Arms	1	6		
									Fore gaff	42	6	10	
									Without the cleats	2	6		
									Main gaff.....	37	6	9 $\frac{1}{2}$	
									Without the cleats	2	6		
									Mizen gaff.....	32	0	8	
									Without the cleats	4	0		
									Mizen boom	47	6	10	
									Without the cleats	2	6		
									Fore storm gaff.....	28	0	9	
									Main storm gaff.....	25	0	8 $\frac{1}{2}$	
									Mizen storm gaff.....	21	0	7 $\frac{1}{2}$	

AREAS OF SAILS.		Square feet.
Jib		1036·8
Second jib		729·6
Fore staysail		693·0
Fore course		2566·24
Fore topsail.....		1823·58
Fore top gallant sail.....		684·86
Fore top gaff sail.....		2136·72
Main gaff sail		2303·62
Main gaff topsail		1107·2
Mizen gaff sail		1617·2
Mizen gaff topsail		640·52

EXPLANATION OF THE PLATES.

MOMENTS OF SAILS.

SPECIES OF SAILS.	In relation to the load water line.			In relation to a section passing through the middle of the water line.		
	Areas.	Height of the centre of gravity.	Moments.	Distance from the middle.	Moments before.	Moments abaft.
Jib	1036·8 ×	50·0 =	51840·0	108·0	111974·4	
Second jib	729·6 ×	39·2 =	28600·32	92·6	67560·96	
Fore staysail	693·0 ×	32·4 =	22453·2	68·6	47539·8	
Fore course.....	2566·24 ×	37·2 =	95464·12	51·4	131904·73	
Fore topsail.....	1823·58 ×	76·4 =	139321·51	50·8	92637·86	
Fore top gallant sail.....	684·86 ×	108·0 =	73964·88	50·4	34516·94	
Fore gaff sail.....	2136·72 ×	40·8 =	87178·17	26·6	56836·75	
Main gaff sail.. ..	2303·62 ×	47·0 =	108273·14	53·2		122552·58
Main gaff topsail.....	1107·2 ×	98·0 =	108505·6	47·6		52702·72
Mizen gaff sail.....	1617·2 ×	37·8 =	61130·16	91·2		147488·64
Mizen gaff topsail	640·52 ×	75·2 =	48167·1	85·2		54572·3
	15339·34		824898·20		542971·44	377316·24
Height of the Centre of Effort.....				$\frac{824898}{15339}$	= 53·77	
Distance of the Centre of Effort before } the middle of the Water Line				$\frac{542971-377316}{15339}$	= 10·7	
DIMENSIONS OF RIGGING, ANCHORS, &c.						
Fore shrouds, 5 pair.....	8	Mizen shrouds, 3 pair	5			
Fore stay.....	8½	Mizen dead eyes, diameter	8			
Fore bob stay.....	6			Cwts.		
Fore topmast shrouds.....	4½	Anchors } Bowers	19			
Fore topmast stay	5	Iron stock } Stream.....	12			
Fore dead eyes, diameter	11	Kedge.....		5		
Main shrouds chain, 4 pair.....	5¼			Inches.		
Main stay chain, short link.....	1¾	Cables, bower, 3 N., 100 fathoms each	1¾			
Main topmast stay	1½	Stream, 75 fathoms	1¼			
Main dead eyes, diameter.....	11					

The armament of the Nile consisted of two guns of large calibre and long range, with a view to choose a proper position to windward, so as to be effective

while without the reach of the enemies' guns; and in the event of being disabled, or at close quarters, twenty short guns of large calibre could be mounted, to offer a proper defence; and to produce effect when landing troops may be required, she was made to carry on her platform 500 troops.

In the construction of the Nile, every care was taken to give a suitable degree of strength, and she was built in every respect equal, both in the quality of the materials and in the scantling and dimensions given to her timbers, to any of the armed steam ships heretofore built; while in the equipment of this vessel, every thing was done that skill and experience could devise or expense accomplish, towards making her as effective as possible.

The engines of the Nile were by Boulton and Watt: two of 110 horse power each, and which appear to have been most effective, from the manner in which this vessel made her passage out to Alexandria; and acted when contending against a strong gale and a heavy head sea. From the size of this vessel it might for the sake of velocity have been considered proper to give greater power; but in determining them, the power given was considered the best suited for making a voyage, when the consumption of fuel must be an object of the first consideration: and the experiment proved, that to accomplish a voyage and to gain the greatest distance in the shortest time, her power was properly proportioned.

The disposition and particulars of her engines will be best explained by reference to the Plates.

In determining the elements, and giving the principal dimensions of the Nile, for her construction, the dimensions, &c., of several fast steam vessels were taken to compare with; but as it was considered of the first importance in the construction of this vessel, that she should be able to carry sufficient sail to keep company with convoys when not steaming, and to make a reserve of her coals whenever practicable, it was thought desirable to give a greater breadth than common, so that her length was about 5·5 of her breadth instead of from 5·8 to 6·8, the breadth as given to some of the fast boats; and the proportion of the area of the load water section to the circumscribing parallelogram formed by the length and breadth was considerably more than is commonly given,—keeping the area of the greatest transverse section about the same in relation to the circumscribing parallelogram formed by the draught of water and the breadth; as it was found impossible to reduce this element much, on account of the displacement required being more than common, from the great weights she was intended to carry. Something might have been obtained, as to displacement, and possibly in the area of the midship section, by making the rise of the floor something less; but in doing this the resistance occasioned by the adhesion of the fluid would have been considerably increased; probably more than

could possibly have been obtained in the direct resistance, by this alteration of the form of the body.

In giving the general form to the body, she was not so sharp forward as to be according to the opinion of the day ; but the form and adjustment of the body were such as to ensure her being easy against a heavy head sea, and with it as little direct resistance as could be obtained without endangering other essential qualities on which the general efficiency of the vessel depends.

To determine the elements that relate to the form, and are essential to the resistance the body will meet in passing through the water, considerable difficulty is involved, and it yet remains for the progress of knowledge to develope ; and in a great degree this subject must rest on mere opinion, as the theories laid down do not notice clearly the different forces that materially affect the motion of bodies ; as the pressure on the anterior part of the body, the minus pressure on the posterior part, with the resistance that arises from friction, as well as the adhesion of the fluid. The writings of several authors on this subject, as Bouguer, Euler, &c., we find the theory is laid down by Newton, and applied by them to the motion of ships is of little practical utility. Euler has, however, given his theory in a very general manner, without enforcing the correctness of his conclusions in practice. M. Romme, in his *Art de la Marine*, gives some interesting experiments, as made by himself at Rochfort ; and with a general expression for the resistance of ships drawn from these experiments, and from the Newtonian theory ; but we find the Academy of Science did not consider his experiments sufficiently numerous, or on a scale sufficiently large to be conclusive. And the experiments made by the British Society for the Encouragement of Naval Architecture have, in a degree, set aside his conclusions ; especially on one material point, viz., that while the midship section remained unaltered, the form forward and abaft would not greatly affect the velocity, which appeared not to be the case ; only that this element materially influenced the resistance of the body.

In the theory, as laid down by Chapman, the Swedish ship-builder, an expression has been investigated on small parts of the surface, partly by the Newtonian theory, and partly from experiments of his own ; and which he applied in calculating the resistance applied to a vessel ; which method, although the results may not be strictly true, is still very useful, as giving the relative plane of direct resistance very nearly, and was used in constructing the Nile ; and is, in most cases, as the form of steam boats varies in terms of the area of the midships, applicable in comparing their direct resistance, instead of the area of midship section, which is now often taken by constructors of steam boats to determine the velocity likely to be obtained by any power given.

The direct resistance, as obtained for the Nile, was estimated according to the rule given by Chapman in his *Architectura Navalis*, Inman's Translation, Chapter IV., was found equal to the resistance of a plane of sixty-two square feet moving perpendicularly through the fluid. This quantity, when examined with power and speed, appears to give results more satisfactory than in taking the area of the midship section; and we find by taking this quantity in relation to the midship section, and comparing it with the results of steam boats, it in general agreed better with the experiments than taking the whole area of the midship section, and would appear sufficiently near for all practical purposes. In some cases, when the plane of direct resistance was obtained for different boats, as for the Nile, they only varied from .124 to .132 of the area of this section. It may, however, be proper to observe, that in any case it can only be an element by which to determine nearly the power required for different steam vessels; as from the friction and adhesive influence of water, the loss of power by the paddle wheels, &c., it would be impossible, with our present knowledge, to give a correct rule; and we have no experiment that will shew how the resistance varies in different degrees of velocity, only that it is in a higher power than the square of the velocity when the velocity is great.

The following are some of the principal elements of construction:—

- Length on the range of deck, 180 feet.
- Breadth, extreme, 33 feet.
- Draught of water,—afore, 13 feet; abaft, 14 feet.
- Weight of hull, 530 tons.

Weight of machinery, water in boilers, coal, &c., as follows:—

	Tons.	cwt.	qrs.	lbs.
Weight of engine	135	0	3	1
Ditto of boilers	65	7	3	13
Ditto of coal boxes	10	0	0	0
Ditto of water	44	11	1	14
Ditto of coal	320	0	0	0
Total	575	0	0	0

Weight of mast, rigging, ordnance stores, provisions, &c., 347 tons.

Total displacement, 1452 tons.

Area of load water line, 5086 square feet.

Area of the greatest transverse section, 360 square feet.

Distance of the centre of gravity of displacement before the middle of the length on the water line, taken from the fore part of the stem to the after part of the stern post, 3 feet.

EXPLANATION OF THE PLATES.

Depth of centre of gravity of displacement below the load water line, 5 feet 25 inches.

UNDER WHAT CIRCUMSTANCES.	Number of strokes per minute.	Velocity of vessel.	Velocity of wheels.	Multiple of the speed of vessel equal that of the wheel.
	Number.	Miles per hour	Miles per hour	
In a moderate breeze, going free, with half the sails set	22	12	18	1.5
Moderate breeze, wind ahead	18	9.75	14.7	1.5
Ditto, head sea.....	16	8.25	1.6
Strong breeze, wind ahead, and head sea	12	5.5	9.18	1.66
In a fresh gale ahead, and a heavy head sea	9	4.25	7.3	1.71

	Feet.	Inches.
Diameter of cylinder	5	0
Length of stroke	5	2
Diameter of air pump	3	0
Length of stroke	3	0
Diameter of paddle wheel	22	0
Breadth of ditto	9	7

Average consumption of coals, 18 cwt. per hour.

It would be impossible to deduce any rule to shew the exact relation between the velocity of the vessel and that of the wheel, for the want of some instrument that would mark accurately the speed of the vessel. With this multiple, however, we may determine nearly the relative perfection of different steam vessels, when the surface and position of other floats are in the same relation to each other; and by a proper register of these numbers, the relative perfection of paddles on the same vessel may be determined by bringing her under the same circumstance as to draught of water, &c.

SCANTLINGS, ETC.

	No.	Feet.	Inches.		No.	Feet.	Inches.
KEEL. Elm. Moulded.....	1	3		Scarphs, long	5	0	
{ Midships	1	2		Bolted copper	8	0	1
Sided { Forward	0	10		FALSE KEEL. Elm. Thick	0	4	
{ Aft	0	10		STEM. Oak sided at the head	1	3	
Below the rabbet.....	0	11		Moulded	1	2	1/2

SCANTLINGS.—CONTINUED.

	No.	Feet.	Inches.		No.	Feet.	Inches.
Scarp, long	3	5		THICK STRAKE on the floor-heads (of African } oak, in midships) thick	0	5	
Bolts, copper	8	0	1				
STERN POST. Oak. Square at the head	1	2		FIRST FUTTOCKS (African oak, in midships), } thick	0	4	
Inner post, fore and aft, at the keel	1	3					
Ditto, at the head	0	9		SECOND ditto ditto	0	4	
DEADWOOD. Oak. Sided	1	3		THIRD ditto ditto	0	3	
FRAME. Oak, except top timbers and timbers } forward and aft; are of Riga fir where curve } would admit.				TRUSSES (African oak, in midships), thick.....	0	4	
CROSS TIMBER. Sided midships	0	11		Fore and aft, fir, thick	0	3	
Forward and aft	0	10		Broad	0	9	
Moulded at the cutting down	1	1		FILLINGS between timbers. Oak. Thick.....	0	2½	
Moulded at the head	0	11½		IRON PLATES for trusses. Thick	0	0½	
HALF FLOORS. Oak. Sided midships	0	11		Broad	0	5	
Forward and aft	0	10		CIRCULAR COAK in each strake opposite the } abutment of each truss	0	2½	
Moulded at head	0	10					
FIRST FUTTOCKS. Oak. Sided midships ...	0	9½		SHELF PIECES. Upper deck oak. Deep	0	8	
Forward and aft	0	9		Wide } Forward	1	1	
Moulded at the head	0	9		} Aft	0	10½	
SECOND FUTTOCKS. Sided in midships	0	9		Scarphs, long	4	6	
Forward and aft	0	8		Circular coaks in ditto	2	0	2
Moulded	0	7½		BOLTS, six inches from the side of each beam, } or from 18 to 20 inches apart	0	1	
THIRD FUTTOCKS, and TOP TIMBERS. } Sided in midships	0	8½		BEAMS. Oak sided			0
Forward and aft	0	7½		Moulded	0	8	
Moulded	0	6¾		Round up	0	7½	
TOP TIMBERS. Riga fir, excepting wake of } paddles, oak. Sided in midships	0	8		Secured to the shelf with one circular coak...	0	2½	
Forward and aft	0	7½		And two bolts	0	0½	
Moulded at the deck	0	6		IRON KNEES in wake of engine-room, and } three aft and two forward (see Section).	5	0	0½
Roughtree	0	4		BOLTS in up and down arm			3
FLOORS made of Oak, with crosstrees and two } half floors. Circular coaks in each floor ... }	7	0	3	DITTO, in beam arm	1	5	
Bolts ditto				6	0	1	PADDLE, or main beams. Sided
KEELSON. Oak. Square in midships	1	2		Moulded at the middle	0	8	
Forward and aft	0	11		DECK and BREAST HOOKS. Wood. Sided...	13	0	
Bolts, copper, one through each floor	0	14		Long	10	0	1
STEMSON. Oak. Square at the upper part ...	0	11		Bolted copper	10	0	1
Bolts, copper from 18 to 20 inches apart ...	0	1½		HOOK below, iron. Long	2		
STERNSON. Oak. Square at the head	0	11		Bolted	10	0	1
Bolts, copper, from 18 to 20 inches apart ...	0	1½		CRUTCHES	10	0	1
THICKNESS OF PLANK. Wales (oak). Thick, } three strakes	0	6		Long	10	0	
DIMINISHING PLANK. Four strakes of oak, } upper edge of upper strake				10	0	1	
Lower edge of lower strake	0	4		Bolted, copper	10	0	1
PLANK OF BOTTOM. English oak to light } water mark, thick	0	4		Cross BOLTS in keelson to pass through the } double futtocks, and two between each hook } and crutch	0	1	
Oak strake above the wale, lower edge thick				0			5½
Upper edge thick	0	5		DITTO, platform forward and aft. Thick.....	0	2½	
SHEER STRAKE. Oak. Thick	0	4		SHELF. Deep	0	7	
TOPSIDE (Riga fir). Thick above the wale....	0	4½		Broad	0	10	
Thick under sheer strake	0	3		BEAMS. Moulded	0	7	
PLANSHEER	0	4		Sided	0	8½	
TOPSIDES, size above these strakes	0	2		BOLTS, copper through side and shelf.....	2	0	0½
ROUGH TREE RAIL. Deep	0	5		WATERWAY to upper deck. Thick	0	10	
Broad	0	6		Broad	1	1	
INSIDE PLANKING. Clamps, oak in two } strakes, upper strake thick	0	6		WINDLASS BITTS. Knees.....	2		
Lower ditto, ditto				0	5		CARRICK BITTS. Thick.....
				RUDDER. Pintles.....	5		
				Braces	5		
				COUNTER, STERN, and QUARTERS. Oak. }	0	4	
				Lower counter, thick.....			0
				Backing of stern.....	0	2½	

PLATES CVIII., CIX., AND CX.

HIS IMPERIAL MAJESTY'S ARMED STEAM VESSEL COLCHIS.

This vessel, and likewise the Jason, was built for the Russian Government by Messrs. Joseph Fletcher and William Fearnall, and was principally designed by the latter gentleman. The plan of construction, with the various dimensions and descriptions of material, are exhibited in the following specification appended to the original contract, from which it has been carefully extracted:—

“ THE SCHEDULE OR SPECIFICATION REFERRED TO BY THE
FOREGOING CONTRACT.

“ DIMENSIONS.

	Feet	In.
Length from the part of the stem to the aft part of the stern post, at the rebate of the keel	156	0
Breadth, extreme	24	0
Moulded.....	23	6
Depth in hold	13	8
Burthen in tons.....	433	$\frac{78}{94}$

“ SCANTLINGS, ETC.

		Ft.	In.	Material.	Diameter of bolts.
KEEL in midships	sided	0	11	English elm
Forward and aft	ditto
Scarphs to be	deep	0	11
Bolted with 6 bolts of.....	long	3	6
To be below the rebate.....	0	4	$\frac{7}{8}$
False.....	deep	0	$2\frac{1}{3}$
STEM, at the head	sided	0	$10\frac{1}{2}$	English oak, or African
At the keel	0	$9\frac{1}{2}$
Before the rebate.....	moulded	1	1
Scarphs to be	0	6
Bolted with 6 bolts of.....	long	3	6
APRON to be sided, same as stem	$\frac{7}{8}$
STEMSON, scarphed upon the fore end of the keelson...	moulded	0	8
The upper ends.....	square	0	$9\frac{1}{2}$
STEMSON, scarphed upon the fore end of the keelson...	ditto	0	8
STEMSON, scarphed upon the fore end of the keelson...	0	$10\frac{1}{2}$
Fore and aft on the keel.....	1	6
Abaft the rebate at wing transom	0	7
Ditto on the keel.....	1	0	1

SCHEDULE continued.

		Ft.	In.	Material.	Diameter of bolts.
INNER POST, to run up to the under part of the wing transom, fore and aft at head.....	0	7
Ditto on the keel.....	1	0
WING TRANSOM	sided	0	9
In midships	moulded	1	3
Secured at each end with an iron knee—the fore and aft arm to have four bolts, and thwartship arm three.....	1
The stern post to be bolted through the transom with two bolts.....	1
Not to have any transoms below the wing, but all the timbers to be dowelled at their heads to the under side of the wing transom, and bolted at their heels through each other across the deadwood with bolts	1
DEADWOOD, to be sided same as keel, and wrought sufficiently high for the security of the heels of the cant timbers, and bolted at every two feet with bolts.....	1
The lower piece may be.....	elm
All above.....	English oak
KEELSON, in midships.....	square	0	10 $\frac{1}{2}$	African
At the fore and after ends	0	9 $\frac{1}{2}$
Scarphs to be	long	4	4
And to be 6 feet clear of the masts and scarphs of the keel.	1 $\frac{7}{8}$
To be bolted through every floor and the keel, with bolts of
FASHION PIECES, to be double the foremast, one to run up above the wing transom	2	6
And to be dowelled to its end; the after one to run up to the under part of the wing transom, and to be dowelled into it.	sided	0	8 $\frac{1}{2}$
KNIGHTHEADS, sided at the head	0	10 $\frac{1}{2}$
To be bolted to the stem and apron with.....	$\frac{7}{8}$
HAWSE PIECES, to have three on each side	sided	0	10
To run up to within 1 foot of top of knighthead, the hawse holes to be fitted with cast iron hawse pipes of.....	diameter	0	9
ROOM AND SPACE, to be the whole length of engine } room.....	2	0
To be increased	2	2
Forward and abaft, as per drawing	2	3
CROSS PIECES, or short floors, in engine room	sided	0	10
Forward and abaft	ditto	0	9
At the butting down, clear of chocks, to be.....	moulded	0	11
At the head	ditto	0	9
HALF FLOORS, in engine room	sided	0	9
Forward and abaft	ditto	0	8 $\frac{1}{2}$
At the heads.....	moulded	0	8
LOWER FUTTOCKS, in engine room.....	sided	0	8 $\frac{1}{2}$
Forward and abaft.....	ditto	0	7
At the heads	moulded	0	7

SCHEDULE continued.

		Ft.	In.	Material.	Diameter of bolts.
SECOND FUTTOCKS, and Top Timbers, in engine room	sided	0	7 $\frac{1}{2}$
Forward and abaft	sided	0	7
At the gunwale	moulded	0	4 $\frac{1}{2}$
FRAME, all the frame to be.....	English oak, or African
The timbers to be put together, close joints up to the lower futtock head, with dowels uniting their heads and heels, and bolted together sidewise with 2 bolts	5
In each scarph, and all the openings, to be fitted in solid with.....	English oak
From the keel to 2 feet above the turn of the bilge, and to be calked;—adhesive felt to be put in between the faying parts of both timbers and fittings.					
MAIN WALES, in 3 strakes together	broad	2	3	English or African
To have 1 strake above.....	thick	0	5
	thick	0	4
	broad	0	9
Two below the main wales.....	thick	0	4
Together	broad	1	6
TOPSIDES, three strakes	thick	0	3	English oak
SHEER STRAKES, two	thick	0	4	African, or English oak
Together	broad	1	3
BOTTOM PLANK, from the garboard strake to the turn of the bilge	American elm
From thence to the strake below the wales	thick	0	3	Oak, or Dantzic
Garboard strake	ditto	0	4	American elm
To be bolted through the keel and opposite strake, and up and down through the bottom at every third timber with.....
All the bolts through the butts.....
Short bolts
Counter :—plank.....	thick	0	2 $\frac{1}{2}$
Plansheer.....	thick	0	3 $\frac{1}{2}$	African

WITHINBOARD.

THICK STRAKES, one at futtock head.....	thick	0	4
	broad	0	9
One above and one below	thick	0	3
	broad	0	9
ENGINE BEARERS	African
To have two on each side, well dowelled into the timbers, and bolted, the length of engine room, through every other timber with	Copper	1 $\frac{1}{2}$
Forward and abaft with.....
Scarph	long	4	6
And placed clear of each other	sided	1	0
And deep as may be required by the engineer.					

SCHEDULE continued.

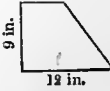
		Ft. in.	Material.	Diameter of bolts.
<p>SHELF PIECES, to receive the ends of the beams, of size as per margin, not to be dowelled, but scored over every timber, and bolted through every timber with</p> 	$\frac{7}{8}$
CLAMP, to have 2 strakes.....	thick	0 4	African or Eng.
together.....	broad	1 6
DIAGONAL IRON PLATES, to be laid at an angle of 70°...	broad	0 4
	thick	0 0 $\frac{1}{2}$
Scored into the timbers their whole thickness, to be placed apart	3 0
And in length from the under part of the shelf-piece to the outside of the outer bearers to be bolted through every timber with bolts	$\frac{3}{4}$
In the middle they are to cross each other.				
DIAGONAL PLANK, in midships	thick	0 2 $\frac{1}{2}$	Oak or African
	broad	0 10
To be placed apart in the engine room.....	2 6
Forward and abaft.....	3 0
All the fastenings of the bottom to be driven through and additional bolts added where required, and between the planks to be fitted in with 1 $\frac{1}{4}$ deal flush with the diagonal plank, all fore and aft.				
CABIN PLATFORMS, beams	square	0 6	Baltic fir, or red pine
Secured to the side by an angular shelf with 1 bolt in each beam end	$\frac{3}{4}$
Flat of platform	thick	0 2	Fir
To build a magazine and such store rooms as may be required under and upon the platforms.				
PADDLE BEAMS	sided	1 1	African
In midships	moulded	1 4
Reduced at the ends to	1 1
IRON KNEES to PADDLE BEAMS, withinboard, Side arm	long	5 0
Beam arm	ditto	3 10
	broad	0 3 $\frac{1}{2}$
In the throat	thick	0 3 $\frac{1}{2}$
At the ends	ditto	0 1 $\frac{1}{2}$
Bolted with	1 $\frac{1}{4}$
DITTO, withoutboard, Side arm	long	5 0
Beam arm	ditto	5 0
	broad	0 3 $\frac{1}{2}$
In the throat	thick	0 3 $\frac{1}{2}$
At the ends.....	0 1 $\frac{1}{4}$
Bolted with.....	1 $\frac{1}{4}$
IRON STAYS, to paddle beam	diagonal	0 3
SPRING BEAM, to support paddle shaft.....	sided	0 10	Oak or African
And deep as may be required.				
PADDLE CASES, to be properly framed and covered with good seasoned deal of two thicknesses, to be rebated, the lower one half an inch thick, wrought fore and aft, the upper one an inch and a half thick. The hinges to the flaps to				

SCHEDULE continued.

		Fl. in.	Material.	Diameter of bolts.
be of copper or mixed metal. A bridge board to be fitted for a gang-way between the paddle boxes.				
UPPER DECK BEAMS, to round in 4 feet	0 1
The hatchway and mast beams	sided	0 8 $\frac{1}{2}$	African
	moulded	0 7
The remainder	sided	0 8 $\frac{1}{2}$	Red pine
	moulded	0 7
WATERWAY	broad	0 10	Dantzic fir
	thick	0 4
DECK. Flat	ditto	0 3	Dantzic deal
ROUGH-TREE TIMBERS, at the gunwale	sided	0 7
	moulded	0 4
Rail to be	broad	0 5
	deep	0 4
Height from upper side of deck to top of rail.....	4 2
Bulwarks rebated, deal	thick	0 1 $\frac{1}{2}$
TOWING TIMBERS, two on each side	sided	1 0
	moulded	0 7
BREAST-HOOKS, upper deck, sided	0 7
One between that and platform to be	broad	0 3 $\frac{1}{2}$	Iron
In the throat	thick	0 3 $\frac{1}{2}$
At the ends	ditto	0 1 $\frac{1}{4}$
Length.....	11 0
HOOK, at the platform deck	sided	0 7
Bolts to be 1 foot apart.....	1 $\frac{1}{8}$
IN THE HOLD, one	broad	0 3 $\frac{1}{2}$	Iron
In the throat	thick	0 3
At the ends	ditto	0 1 $\frac{1}{4}$
Length.....	10 0
CRUTCH. Aft, one of iron for the security of the heels of the timbers, of size and bolted the same as lower hook.				
WINDLASS. To have a patent one of African or English oak, fitted with wheel pinion and winch handles, and to receive chain cables	diameter	1 3	African
PAWL BITT	square	0 10
CARRICK BITTS.....	sided	0 6
CAT HEADS	sided	0 9
	moulded	0 8

DAVITS. To have proper ones for the boats of iron, two on each side.

ROTIER. To be fitted with metal braces and pintles, Lihour's patent.

PUMPS. To find and fix two cast iron pumps with gear complete.

HEAD, STERN, AND QUARTER GALLERIES. To be built and elegantly finished, with suitable mouldings, carved works, etc.

MAST AND BOWSPRIT, PARTNERS, COMINGS, COMPANIONS, AND SKYLIGHTS. To be properly fitted, as may be shewn in the profile and plans.

STEERING-WHEEL, TILLER, OR YOKE. The wheel to be handsomely wrought with brass plates; the tiller to be of iron, and fitted as may be directed.

CHAIN CABLE LOCKERS. To fit lockers for the reception of chain cables, and a box on wheels on deck for the stream cable, as may be directed.

ENGINE ROOM BULK-HEADS. At the after part of the engine room to be double of 1 $\frac{1}{2}$ inch, rebated deal on each side of a 4 inch stanchion,—at the fore part to have a single bulk-head; to fit a bench and cupboards or lockers for the engineer.

- COPPER.** The vessel to be docked, and the bottom coppered with 32, 28, and 24 oz.
- CALKING.** The whole of the calking to be done in a proper manner, the oakum to be good and sound. The bottom to be plyed over with tar, and well prepared to receive the copper.
- JOINER'S WORK.**—To emboss the vessel within and without board in a proper manner; build all accommodations for passengers in the saloon under the main deck; the doors to be mahogany, and the sides of the cabins to be panelled with mahogany. To build accommodation on the fore platform with deal as may be directed by the plans designed for that purpose.
- PLUMBERS, GLAZIERS, PAINTING.** To lead the taffrail under the quarter galleries, cheeks of the head, and all air scuttles; fix all scuppers; find and fit two of Downton's water-closets abaft, and one common hopper on deck; the skylights, scuttles, and lights in the stern to be glazed with the best crown glass. The whole of the weather work and under part of the deck to have three coats of good oil colours; the fore cabin to be painted in common colour.
- MASTS, YARDS, BLOCKS, &c., &c.** To supply and fit all masts, yards, and blocks, one suit of sails, and bend them to the yards, two best bower anchors, one stream anchor, one kedge, and one grapnel, two one and one sixteenth chain cables, 90 fathoms each; one seven-eighths stream cable, 90 fathoms. Supply and fit all chain rigging, stays and cordage, necessary to rig the vessel, fit tarpaulings to the hatchways, awning stanchions, and one awning to quarter-deck; supply a buoy and buoy-rope; two boats with one set of oars, and a canvass cover. Supply a fire-hearth to cook for 100 men; iron tanks to contain about 2,000 gallons of water; a patent binnacle, and a double lamp in the saloon.
- SPONCINGS.** To be two inches thick, of Baltic fir; the timbers of English oak sided 6 inches, and bolted in the heel through the side, with one bolt of three quarters of an inch in diameter. A thick strake of Baltic fir let on one half of the moulding of the sponcing timber to meet the water-way, a piece of felt being first placed in the joint, and bolted through each other, with one bolt between every timber five-eighths diameter, with a ring well clinched on each end; the beam ends secured to the strake by a drawtort dog bolt secured with a bolt and one nail.

For a Description of the Engines, see Plates XLIII. to XLVI.

PLATES CXI., AND CXI. A.

ENGINES OF THE STEAM SHIP TIGER.

The engines of this vessel were manufactured by Edward Bury, Esq., and fitted with Hall's patent condensers, and the description of the parts will be understood by reference to that of the engines of her Majesty's steam ship Magæra, Plates XLIX. and L.

The Tiger is a Hull built vessel, and belongs to the St. George Steam Packet Company; her burthen is 800 tons; her engines are of 300 horse power; she is at present stationed between Hull and Hamburgh; and her equipment, in every respect does the highest credit to the port of Hull and to the owners. The following extracts from Captain Knocker's journal will show the leading points of her passages:—

EXPLANATION OF THE PLATES.

EXTRACT from the Journal of the St. George Steam Packet Company's steam ship the Tiger, from HULL to HAMBURGH.—Draught of water 13 feet 3 inches aft, 11 feet 10 inches forward. 100 tons coals; 15,000 feet measurement goods.

DEPARTURE.	TIME.	WINDS.	REMARKS.
July 14. Weighed from Hull Roads...	H. M. 9 30 P.M.	SW.	Strong wind and rain;—detained by the pilot, going down the Humber full an hour.
15. Passed new Sand Light.....	1 5 A.M.	SW.	Fresh wind and plenty of sea.
Passed Borkum	10 0 P.M.		
16. Passed Elbe Light	3 57 A.M.	SW.	Fine weather.
Cuxhaven.....	5 20		
Arrived at Hamburg.....	10 10 Hull time.		Squally, with rain.

The passage from river to river—Humber to Elbe—was performed in 26 hours 50 minutes: the distance run being about 300 miles. The whole passage from Hull Roads to Hamburg, including a delay of an hour in the Humber, was made in thirty-six hours and a half.

FROM HAMBURGH TO HULL.

DEPARTURE.	TIME.	WINDS.	REMARKS.
July 22. Started from Hamburg.....	H. M. 2 40 A.M.	NW.	Strong gales and heavy rains.
Passed Cuxhaven	8 40		Continued gales, and heavy rain.
Light ship.....	11 30	N NW.	Left the French steamer for Havre, wind bound.
Heligoland NNE.	1 50 P.M.		
23. Anchored in 6 fathoms water	10 0 P.M.	N.	Strong gales and clear.—Thick, with heavy rain.
24. Weighed	1 0 A.M.	NE.	Strong gales and clear.
Arrived at Hull.....	4 0		

The voyage home was performed in 49 hours—three of which at anchor; the weather being so bad that the French steamer kept her port, and the first-class steam ships from London to Hull—even the Wilberforce—exceeded their average passage by ten hours.

PLATE CXII.

THE ADMIRALTY YACHT FIREBRAND.

We shall have occasion to say but little of this vessel, as her qualifications are comprehended in what has been already said of the Medea. The Firebrand is on the

same principle, with the exception of the fittings for war, being armed with only 10 brass swivels, one pounders; she was constructed by Mr. Lang for the packet service between Falmouth and Malta, and built under his superintendance by Messrs. Curling and Young; was employed in that service at first, about nine months, under the command of Lieutenant Baldock; she was afterwards fitted as a yacht for the Marquis of Anglesea, at Dublin, since which, on the Marquis leaving Dublin, she has been employed as the yacht for the Lords Commissioners of the Admiralty to perform their sea duties; her dimensions are as follow:—

		Feet.		Inches.	
Length between the perpendiculars	155	0		
Ditto on the keel for tonnage	136	9 $\frac{1}{4}$		
Breadth, extreme	26	1		
Ditto, moulded	25	7		
Depth in engine-room	14	9 $\frac{3}{4}$		
Burthen in tons	494 $\frac{8}{9}$			
		LIGHT.		LOAD.	
		Feet.	Inches.	Feet.	Inches.
Draught of water	{ Forward	6	6	10	2
	{ Aft	7	10	11	0
Displacement in tons	288·9		642·0	
Area of midship section, in square feet	117·64		215·0	

Her two engines are 60 horse power each, made by Messrs. Maudslay; her paddle-wheels by Mr. Morgan; her performance is considered to be superior to any vessel of her size in proportion to the power of her engines, which are very small for a vessel of such dimensions; her velocity has been proved in several instances where she has beaten her opponents; one vessel of 237 tons, two engines of 50 horse power each*; one vessel of 400 tons, two engines of 90 horse power each†; another, 700 tons, two engines 150 horse power each‡; one of 237 tons, two engines of 50 horse power each§, &c. She behaves well at sea in bad weather, and is a good sea-boat under canvass alone; she is rigged with three masts, similar to the Medea. Nothing further need be said by way of description of the vessel, as her form, method of fastenings, fittings, &c., are all exhibited in the drawings.—Vide the Plate.

* Escape, of Holyhead.
 ‡ City of Aberdeen.

† Victory, of Bristol.
 § Dragon, of Holyhead.

PLATE CXIII.

PORTRAIT OF THE LATE MR. WATT, THE CELEBRATED INVENTOR AND
IMPROVER OF THE STEAM ENGINE.

PLATE CXIV.

PORTRAIT OF THE LATE MR. TREDGOLD.

PLATES CXV., CXVII., AND CXVIII*.

These drawings are designed to illustrate the state of steam navigation in America, in reference to Professor Renwick's paper on that subject, inserted in the Appendix, page 101.

* Plate CXVI unfortunately not having reached us, we have reluctantly been compelled to abandon it.

APPENDIX.

I.—ON MARINE BOILERS.

BY MR. J. DINNEN,

ASSISTANT ENGINEER, HER MAJESTY'S DOCKYARD, WOOLWICH.

1. THE paucity of information connected with steam navigation,—a subject, it must be allowed, of great national importance, and which has assumed a prominent feature in her Majesty's naval service,—suggested the investigations from which the following practical essay on marine boilers has resulted. The incrustrated state of the boilers of all steam vessels returning from the Mediterranean with mails, in the early stage of their employment, was calculated to impress the observer with the impracticability of making such voyages without submitting to like effects; no experiment having been made, or correct data furnished, at that period, to counteract the notion, so universally entertained, that the water of the Mediterranean holds more marine deposit in solution than that of the Channel. It is probable that Dr. Halley's experiments on the evaporation of water from the surface of the sea assisted materially in the formation of this general opinion.

It is calculated that the Mediterranean evaporates no less than 5,280,000,000 tons daily: and this quantity far exceeds that evaporated from any other surface of equal extent, being entirely encircled by land; but it does not follow from this that the water is salter. Whoever has been in the Mediterranean is aware that the dews there are exceedingly heavy, and that they begin to descend some time before the sun has set: in still evenings indeed the dew descends where it has arisen; and no doubt much is precipitated on the land; but it must be borne in mind, that land gives forth exhalations at all temperatures, as well as the sea. Again, the visible current always runs into the Mediterranean, in addition to the great rivers Nile, Danube, Rhone, &c., to supply that portion of water which the land may carry off. Experiments do not show the specific gravity to exceed that of other waters; and hence the general opinion alluded to must have been conjectural, and not founded on the result of investigation.

2. It cannot be too generally known that the thermometer is a good practical test of the concentration of a boiling solution of salt; of which the following is offered in illustration.

Some years since, experiments were tried by Messrs. Maudslay and Field, and an apparatus adapted to marine boilers, the purpose of which was, that the water of the boilers should at all times be maintained at the same temperature and at the same degree of concentration; and I am not aware of any experiments for such an object prior to these. It resulted from their investigations, that sea water boiling under a pressure of $2\frac{1}{2}$ lbs. on the square inch, (the usual low pressure standard,) will arrive at 226° Fahrenheit in 24 hours, at 230° in 48 hours, and 232° in 60 hours, &c.; at which period it will contain $\frac{11}{32}$ of its bulk of salt. At 232° saturation takes place, and salt (muriate of soda) will be crystallized and deposited; the concentration having progressed from 222° , the temperature exhibited at the commencement of the experiment. The boilers of course receive only the necessary supply of water for evaporation; in the above instance 16 gallons per minute. These experiments I have frequently repeated under varied circumstances with corresponding results.

Sea water containing $\frac{1}{32}$ of its bulk of salt, and the quantity evaporated being entirely fresh or distilled water, it is evident that all the salt injected remains in the boilers: the specific gravity of the water is thus constantly increased, and the salt, now more tenacious of its water of solution, requires an increase of heat to separate it; so that with an uniform heat evaporation would proceed proportionally slower; but the necessities of the engines requiring that it should proceed at all times equably, the fires must be urged accordingly. The temperature thus increasing (under the same pressure) with the saturation, a thermometer becomes a practical register of the density of the water; of the waste of fuel, to a certain extent; and a certain index of the danger to which the furnaces are exposed.

3. A particular arrangement was adopted in the above experiments: a thermometer was applied to the front of the boilers, ranging from 210° to 250° or 300° Fahrenheit, the bulb of which was immersed in mercury, contained in an iron box, protruding into the water of the boilers through the front thereof, so as invariably to partake of the same temperature; and so that its state could always be known by inspection. To apply the thermometer to boilers generally, it would be necessary to graduate it to suit the particular pressure on the safety valve, the boiling point varying accordingly. An objection may be offered, that the thermometers thus applied are very liable to get out of order. To prevent errors of this kind, a common Fahrenheit's thermometer may be employed without reference to the pressure on the safety valve, by immersion in water drawn from the boilers at regular intervals, and boiling under the pressure of the atmosphere; which, if possible, should be noted when nice observations are required.

Now, as muriate of soda is an exception to the general law of the solution of salts in water,—as scarcely any more is taken up at a boiling heat than at a moderate temperature,—it is clear that this boiling in the air exhibits the exact state of the brine, whether from a high or a low pressure boiler; the thermometer alike showing its specific gravity, and of course acting near enough for this purpose as a hydrometer. In this way the experiments referred to in this paper have been made.

4. An essential part of the apparatus alluded to for equalizing the concentration of salt in the boilers, was a pump, technically called a brine pump, the particular office of which was to extract from the lowest part of the boilers, at each stroke, a certain aliquot part of the water supplied by the feed pump. One-fifth of the quantity injected was found to be that

necessary to be withdrawn, four-fifths being the amount required to be evaporated for the supply of the engines. It having been before observed that the water evaporated is fresh or distilled water, that remaining being specifically heavier than sea water in proportion to the quantity evaporated, it is evident that without a change the saturation would increase till the boiler became a common salt pan. The operation of the brine pump however maintained the water uniformly at about 226° , at $2\frac{1}{2}$ lbs. pressure per square inch ; at which temperature it contained $\frac{5}{32}$ of its bulk of salt : hence, as much salt was extracted by the pump, in a gallon of brine, at $\frac{5}{32}$ concentration, as was injected by the feed pump in 5 gallons of sea water containing $\frac{1}{32}$ salt : thus maintaining the condition required, which being within the prescribed limits of saturation, viz. 232° , sulphate of lime only could be deposited ; but at this period the deposition of muriate of soda was the evil sought to be averted, and this arrangement did it effectually. The lime remains to be considered, of which more hereafter. The brine pump has given place to the indefinite operation of blowing out ; but, from my knowledge of its advantages at sea, I should recommend its use in all *land* engines where fresh water cannot be obtained ; an opportunity being afforded of recovering nearly all the heat abstracted from the boilers with the water thus withdrawn.

5. The incrustated state of the boilers, to which I have referred, appeared at variance with observations made by me in the North Sea, Channel, &c. on the influence of sea water on the interior of marine boilers. To determine the fact, I carefully noted the degree of saturation of the water of the boilers at various periods each day, as indicated by Fahrenheit's thermometer immersed in a portion drawn therefrom, and boiling under the pressure of the atmosphere, on my first voyage, in 1831, from Falmouth to the Mediterranean and back ; the result of which was, that having blown out a portion of water from the boilers (which were of copper) every two hours during the passage, they were on each successive examination found perfectly clean and free from marine deposit, with the exception of a slight film ; the thermometer being at 215° , and not having varied in excess throughout the voyage. This circumstance was without precedent ; no mud-plate having been removed, or men employed in the boilers during the voyage.

From extensive experiments of Dr. Davy, (brother to Sir Humphrey,) to ascertain the relative saltness of the sea in various situations, its specific gravity was found to vary very little, except when influenced by the influx of large rivers ; and this conclusion is corroborated by other scientific men, with whom I have conversed on the subject, in the Mediterranean.

From the coincidence of the above experiments, therefore, it may be inferred that the water of the Mediterranean is not, in its effect, salter than that of the Bay of Biscay or the Channel,—that boilers hitherto incrustated must have contained a solution saturated to a much higher degree than that exhibited in the case alluded to,—and that marine boilers are not more subject to incrustation during a voyage to the Mediterranean, than on any other voyage of similar duration. Also from recent examinations of boilers returned from the West Indies, and the reports from the 'Atalanta' and 'Berenice' steam ships sent out by the East India Company, I am led to the same conclusion as regards the waters of the Tropics.

6. The specific gravity of the water of the boilers, as indicated by the thermometer remaining uniformly at 215° , and its not having indicated a higher degree of concentration on either passage, the delay of blowing completely out on the voyage became unnecessary, and

this was justified on each arrival ; hence no time was thus wastefully consumed. The order for laying-to every three or four days, to blow the boilers entirely out, at sea, is still in force in the navy, and forms part of the instructions to officers commanding her Majesty's steam vessels ; but how far this is necessary, the fact of having never blown off entirely at sea will explain : I believe the practice is now rarely resorted to, although some are still inclined to think it necessary.

7. I am also decidedly of opinion, that it is unnecessary to prescribe any specifics for the prevention of deposit or chemical action in copper boilers affixed to marine engines, such as the introduction of large masses of iron, &c. ; the same effects exhibiting themselves in iron as well as copper boilers, when submitted to the influence of a highly concentrated solution of saline matter, &c. in a constantly boiling state,—viz. deposition of the salts, &c. and ultimate destruction of the boilers. As a proof of the fallacy of such applications, the incision I made in a copper boiler with a chisel was not obliterated or sensibly diminished by the action of the water alone, at the end of three years ; the boilers, during the time, being employed in the North Sea and Channel, and free from incrustation, except a film with which the tubes were whitened. After the experiments before alluded to, the boilers were constantly employed in the Mediterranean, and on the Lisbon service ; and were not in any way submitted to the form of cleaning out, till the expiration of the third year : a very slight scale was then removed, leaving the surfaces scaled, precisely as when rolled.

8. The remarkable preserving influence these calcareous matters possess over copper and other metals has recently been exhibited in the bronze guns, raised by the enterprising Mr. Deane from the Royal George at Spithead ; which properties, if generally known, might be available for some useful purpose. I give the notice extracted from the 'Mechanic's Magazine':—"The guns are incrustated with a coat of lime about the twentieth of an inch thick, to which several oysters have attached themselves ; but these, as well as the calcareous coating, separate very easily from the metal, leaving the gun perfectly clean and sharp in its castings." It observes also, "that the rings of wrought iron attached to the breech were totally decayed, the cast iron shots and wads being in a perfect state of preservation." The preservation of the shot is easily accounted for, being pent up by its wad ; but the galvanic agency of the iron, exposed to the water, neutralized its destructive effects on the gun ; and hence the calcareous formation, which, when the existence of the iron should totally cease, would certainly defend the bronze from all attacks of the sea. The adhesion of oysters favours this view of the circumstance.

Since noting the above in the Mediterranean, I have seen in the arsenal at Woolwich several of the guns alluded to, which in every respect confirm what is stated in the extract. The condition of these guns is a fair specimen of the interior of a boiler after a few voyages to sea, except that in the case of the boiler the surfaces are incrustated more uniformly : the coating however in both instances equally protects the surfaces from the destructive attacks of the sea water ; but the causes of deposition are different : in one case it is effected by galvanic influence ; in the other by depriving the water of a component part, by the simple operation of boiling.

9. The experiments of Davy on copper sheathing induced many to attempt the application of the principle to other purposes, and marine boilers (copper) proved to be a *failure* of this description ; for the electric action which was induced by the application of cast iron,

zinc, &c. to copper sheathing, favoured marine vegetation, and the adhesion of shell-fish, lime, &c. to the ship's bottom; a disadvantage greater than the evil it was intended to obviate. Iron placed in a copper boiler, for the object alluded to, was speedily decayed, without apparent effect: in fact, it was treating the boilers for a distemper which existed only in imagination. Hence no calculable diminution of weight is sustained in copper boilers, from the action of salts, &c. when held in solution, at sea: but when the interior becomes incrustated with laminae of insoluble calcareous matter, which firmly adheres to the surfaces of the flues, and fire places, and thus certainly protects them from chemical action, and frequently fills the interstices or water-ways of the boilers, it requires violent mechanical means to extract it. In removing these masses, the boilers are much injured; quantities of rivet heads imbedded in the deposit, and portions of the metal, being alike separated by the instruments used for the purpose. These facts obtain alike in iron and copper boilers.

10. An evil, however, most sedulously to be avoided, is the accumulation of soot, salt, &c. in the flues; the chemical action of which is very destructive to boilers. Water, whether cold or boiling, filters through numerous apertures insignificant in dimensions, and almost inseparable from the intricacy of the construction, and mixes with the soot, forming a combination which corrodes the material very rapidly. The heat of the boilers, when employed, evaporates the water, and leaves the salt, &c. in a concrete state; which, when cold, is again dissolved, and recommences its action more formidably.

On a voyage to the Mediterranean in the months of September and October, 1835, the stay at Malta, on the passage to Corfú, being too short to clean out the flues or to inspect the interior of the boilers, these duties were necessarily delayed till the arrival at Corfú out, and thence to Gibraltar home; and in both instances there appeared an unusual quantity of soot, &c. in the flues. The congeries of salt, soot, and water was thrown out upon the iron plates of the engine room flooring, where in both instances it remained for nearly two days (the time occupied in properly sweeping); when removed and the plates well washed, a pretty and novel phenomenon was exhibited. The iron plates had precipitated the copper from the solution which covered them, exhibiting a permanent metallic surface of copper. This is a valuable practical corroborative of the observation just made concerning the great transmission of the metal, when such solvents are not removed at frequent intervals. I was first attracted to the fact at the above period, have had many opportunities of seeing it repeated since, and have collected the water, to amuse others by the experiment of the precipitation of copper by iron, from an acid having a greater affinity for the latter.

The leaks whence the salt resulted, on careful examination, were found so unimportant, that the usual measures to stanch them could not be attempted without the risk of increasing the evil; particularly as this voyage immediately succeeded a general caulking of the flues in parts requiring it, when numbers of screwed rivets were substituted for defective ones.

11. Now, as the defects exist exclusively in the angle pieces and rivets of the bottom of the flues, the top and sides being invariably tight, I have applied a fillet of Parker's or Roman cement in these cases, so as to completely inclose the angle pieces, with their defects, and have thus succeeded in checking the destructive effects of these otherwise trivial, but numerous and incorrigible channels. I have recommended its adoption in other steam vessels,

with equal success and satisfaction ; and from three years' experience of its advantages, when applied to the cleaned surfaces of the defective parts, I suggest its use under similar circumstances in iron boilers ; although inconveniences here alluded to are less frequent and more easily checked in these boilers, by the usual method of chincing, &c. It must be understood that I here confine myself entirely to cases where mechanical skill is found to be ineffectual ; the cement need be resorted to only when every other means has failed.

I also conceive that copper boilers experience more deterioration than iron from these deposits ; the bottom flue plates of a copper boiler, upwards of $\frac{3}{8}$ of an inch in thickness, (where water was present, as before described,) being totally decayed in twelve months ; the side of the plate exposed to the action of the salt water alone being unimpaired ;— a fact which I never witnessed in an iron boiler under similar circumstances. Hence the rapid decay of boilers if these deposits are allowed to remain in the flues an unwarrantable space of time. The only mode, of course, to obviate this, is to sweep the flues as often as convenient ; and the boilers, it should be provided, are to be kept perfectly dry when not employed.

12. To keep those parts of the boilers clean which are exposed to the influence of the boiling salt water, it appears to be absolutely necessary to hold the salts in solution, since deposits are separated from the water some considerable time before salt is formed, and at a much lower temperature ; 220° having been esteemed a limit (under the pressure of the atmosphere) at which a boiler begins to incrust, while my experiments have shown that 215° should be the maximum. Professor Faraday's experiments on sea water appear to confirm these observations : 1000 parts of sea water being evaporated, 825 parts of steam could be drawn off before any deposition commenced ; but then the *sulphate of lime* was deposited ; and proceeding till 110 parts remained, the common salt began to crystallize and deposit till $35\frac{1}{2}$ parts remained only ; when the muriatic acid, from the decomposition of the muriate of magnesia, began to separate. About $\frac{3}{8}$ ths of the water may be raised in steam before the salt is deposited.

13. To obtain the required condition, I recommend that the practice of blowing-out should be periodically and promptly attended to in the Channel as well as at sea, so as to effectually expel the earthy matters while agitated, and prevent induration. I also suggest the expediency of engineers strictly examining their boilers prior to a long voyage, in order to ascertain that their blow-out cocks and pipes are in perfect order. A due circulation of the water in the respective boilers should likewise be attended to, that the blowing-out may equally influence the whole ; and blow-out cocks especially should be so arranged and adjusted, that their use may be quite practicable on all occasions at sea ; as the due performance of the boilers, and consequently the certainty of a passage, materially depends on attention to these particulars.

14. The construction and arrangement of the blow-off cocks and pipes of most vessels in her Majesty's service were formerly very defective : in some instances, four or five men were summoned to attend when the boilers were blown off, in order to shut the cocks, which were often jammed by expansion ; in other instances, the boilers were blown off through the hand pump, to obviate the risk of the cocks jamming. The boilers, in consequence, were insufficiently attended to ; the construction not admitting these duties to be performed at all

times with safety. Independently of these difficulties, the pipes through the ship's bottom were frequently of cast iron, and were often severely attacked by bilge water between the cocks and the sea ; and thus the safety of the vessel depended on the slightest tenure.

These remarks still apply to existing arrangements on board many vessels.

15. The safety valve and pipe lately invented by Mr. John Kingston is so constructed that a conical valve, fitted in the pipe which is introduced through the bottom of the vessel, opens outwards to the sea, and is attached to a copper rod under the control of the engineer : thus, in case of any difficulty arising with the blow-out cocks, the valve can be immediately closed ; and being entirely within the thickness of the ship's bottom, is always protected from accident ; while in case the pipe within the vessel were broken, the pressure of the sea would maintain the valve firmly in its place.

It is not generally known, except to those practically acquainted with engineering, that a steam vessel's bottom is perforated with many large holes, each equal to sink a ship in a very short space of time, particularly when it is understood that they are for the most part pierced close to the keel, where the pressure of water is greatest. It would give additional confidence to every one crossing the seas by steam, if all these holes were rendered as secure as the blow-out pipes now are by Kingston's safety valve : and from the necessity of frequently examining and grinding the sea cocks, the adoption of valves would obviate the necessity of docking for these purposes alone, and is a strong inducement to their general employment in every steam vessel not confined to the limits of river navigation.

16. Instances are not rare of boilers being permanently injured, and sometimes totally ruined, in a first voyage, whether iron or copper ; occasioned alone by neglect of proper precautions. Incrustation, which is certain, strongly opposes the efforts of the men to generate steam, the combustible portion of the fuel being consumed in heating the plates of the boiler ; and the heat must necessarily pass through strata of *stone*, (if I may be allowed the comparison,)—a very bad conductor of heat,—before it is given out to the water ; which being highly saturated, requires an additional, instead of a diminished, supply of caloric, to separate its aqueous and volatile portions from those that are fixed, which are constantly subsiding on the tubes. It requires no argument to show that the fire places and flues thus subjected to intense heat, become nearly red hot, and consequently expand much beyond their usual limits ; while the stay bolts and other ties, holding them with immense force, either break or cause the plates to crack in the weakest place, which is generally in the wake of the stays, joints, or bends,—parts, of course, the most heated from the increase of mass ; sometimes even the tubes collapse, the powers of expansion resisting all opposition.

Serious delays and many inconveniences arise from the evils here described, since in most cases immediate repair is absolutely necessary, and can only be effected at the expense of great physical exertion. In fact, from observations on sea water, and its effects on marine boilers, for many years, I am convinced that it is absurd to expect to make a voyage with success if blow-out pipes are choked or otherwise disordered ; or even that at the end of three days, without a change of water, the boilers will not be incrustated to a considerable extent.

17. The injury sustained by some boilers, either from the above cause or from the neglect of blowing-off uniformly at sea, has by some been erroneously attributed to the

intensity of the draught, which they supposed to cause incrustation by burning the material. A tolerable draught appears however to be preferable, and not injurious to a boiler, being always under control ; moreover, I have invariably observed, that boilers with insufficient draught expend more coals, with a considerable addition of labour, than others adapted to engines of equal power where the draught is capable of extracting the whole of the combustible matter of the coal, and vitrifying the residue ; for a great waste attends the former, from the constant necessity of clearing the bars. I am also of opinion, that no serious deposit can be formed, if change of water is duly attended to and the evaporation constantly supplied ; and that the sound plates will not experience injury if water alone is in immediate contact and the essentials of construction properly observed : for when the fires are in a state of active combustion, the iron or copper rapidly absorbs the caloric from the fuel, and as speedily transfers it to the water, which is accordingly in a greater or less state of ebullition, and not of incrustation, the temperature of the plates not very much exceeding that of the water.

18. In iron boilers it is difficult to insure the duration of the plates, for various reasons. Boiler plates are often on inspection apparently sound and of good quality ; but when submitted to the heat of the furnaces, films of the metal opposed to the fire, where adhesion was not perfect, become separated in the form of blisters or cracks, (according to the nature and situation of the latent defects,) which are on examination frequently found to exist through the whole plate, to an extent often exceeding half its thickness. On testing plates of various kinds for experiment, by heat, punching, breaking, &c., those of the most perfect exterior were often found to be much laminated ; and those parts of boilers which have been previously heated and bent to form the bridges, and on which (when constructed) the fire incessantly impinges, will, if defective, most readily afford opportunity of detection. I have known boilers to run for some months on occasional service in the Channel during the existence of defects, which did not exhibit themselves till the plates were overheated ; no doubt, through partial incrustation, experienced on a voyage to the Mediterranean, immediately succeeding.

19. Instances seldom occur of copper plates cracking, unless from causes already described ; a material difference existing between the manufacture of copper and iron plate, which renders it incompatible that they should display similar effects from the cause of heat alone. The former, after certain refining processes, is cast in open iron vessels, forming convenient cakes, and of course solid and free from air and extraneous matters, prior to being heated and rolled ; while the latter, in masses prepared from scraps, or slabs, is raised to a welding heat, with its heterogeneous accompaniments, then submitted to pressure under the rolls ; on the judicious observance of which processes a perfect union of the parts and consequent solidity mainly depends.

ADDITIONAL OBSERVATIONS AND GENERAL REMARKS.

20. ENOUGH has been stated to show that muriate of soda is crystallised subsequently to the deposition of the sulphate of lime; and from further observations, I conclude that the sulphate of lime *will* deposit and indurate at any temperature from 212° upwards, and at any degree of concentration; the more limited this is, of course the less deposit; so that a person having the care of marine engines on a station cannot be too much on the alert to meet the various mechanical difficulties which may interfere with prescribed arrangements for the good conduct of the boilers; which arrangements are not always disposed so as to effect the desired purpose, particularly when boilers are composed of many parts. Engineers do not give that attention, at all times, to the due circulation of the water in the respective boilers, which their necessities require: not unfrequently I have known three or more boilers communicating freely above the furnaces, and by *side* pipes beneath: the pipes often become choked; consequently in blowing off the front boiler, the water equally descends in the whole, the after-boilers yielding their quota from the surface, (where they communicate freely,) while the earthy matters, and common salt even, are permitted to subside in receptacles whence they cannot be removed.

If there were even three or more cocks in such case, it would not be possible, day and night, nor would it be safe, to open all at the same time; and if one boiler is blown off at the end of two hours, as recommended, each boiler remains six hours before the operation is repeated. The descent of the water should be equal and simultaneous from all the joining boilers if possible; which, if not effected, will often permit one boiler to be perfectly clean, whilst its neighbour is thickly incrustated. Very recent examples of the neglect of *proper* arrangements for circulation of the water in the respective boilers, and of injury thereby sustained, have induced me rather to enlarge on this matter; but still I fear that nothing but the use of distilled water will ever thoroughly obviate the evils to which marine boilers are subject on very long voyages, although at the end of five or six years in active employ a copper boiler may not be liable to injury if properly attended to; while it is notorious that the fire-places of iron boilers of similar construction, employed between Falmouth and Corfú, require repair, almost invariably, at the conclusion of every voyage. I believe that four voyages to the Straits are the most that have been made prior to a general repair of the boilers.

I have stated that the African was three years employed before it was deemed necessary to detach the scales: on the sides this is extremely difficult to manage, the waterways seldom exceeding four inches, and rarely being so wide.

I was led to imagine, from the appearance of the boilers after the first voyage, that they could have been employed indefinitely without any considerable scale; but experience has shown, that to a certain extent it must be expected: in the sixth year, the vessel being actively employed in the Mediterranean, the boilers were scaled about once in three months; the number of entire days at sea in that time being from sixty to seventy. The tops of the tubes were not always cleaned, attention being paid to remove all scales that might be partially detached from the sides: no time was wasted in removing the scales by scraping or chiselling them in minute portions, the loose or easily detached pieces only being attended to.

The sides of the fire-places have seldom more than patches adhering to them here and

there, and of course are easily cleaned. By the above operation it will be readily seen that the surfaces of the flues would be constantly approaching their original state; that is, each scale of five or six years' formation leaves the copper bare; and the more frequently the boilers are scaled, the greater opportunity is afforded the parts to detach themselves.

I should recommend that boilers employed beyond a limited period, regulated by the incrustations, should be scaled once a month while actively employed; the operation would then be simple, and would not occupy above two or three days to do it effectually: no violent measures need be adopted, for reasons already given; and, the matter removed always exceeding that deposited, the condition of the flues, as before observed, would be constantly improving, as regards the parts which are exposed to the water.

ON THE CONSTRUCTION OF COPPER BOILERS.

21. Copper boilers, to a certain extent, have fallen into disrepute, three or four sets having been cut up after employment in the government steam vessels. The fire-places were exceedingly good, as well as the top and side plates of the flues, except in some instances where permanent injury was sustained by incrustation, the result of negligence.

Now, in every instance the destruction of the bottom plates of the flues was the prominent cause of their disuse. Hence, after much inquiry and observation, I suggest that more care and attention, than that usually paid in the construction of iron boilers, should be observed in fitting the bottom of the flues and shell of copper boilers; in fact, too much pains cannot be taken in the first place, as it is amply repaid in the sequel. The rivet holes through the lower "angle irons" and plates should exactly coincide, and the rivets properly fit them. One of the greatest present nuisances is the defects of rivets; many of them actually bend in the disfigured holes in the act of clenching; they certainly cannot fill a hole of a different figure. The riveting merely swells the point, and not the body to any extent, as I have witnessed in many instances: the result is, that water arrives at the clench of the rivet immediately, which, if not well worked, seldom prevents the water from oozing through. The rivets should, in these places, be well worked in the style observed by coppersmiths. The junctions of the "angle irons" should be carefully fitted; for neglect of this is almost irremediable: and the caulking or chincing should be eventually executed with the greatest nicety, as no opportunity is afforded, after construction, of properly making good any defects consequent on neglect, or want of sufficient care in this stage of the manufacture.

22. In IRON BOILERS, when water is first admitted after construction, hundreds of "weeps" or channels in the plates and rivets, whence water oozes, are totally disregarded; the most important only being stopped mechanically; the rest are stanchd merely by the rust the water has formed in its passage, and the bulk of the oxide being greater than that of the original metal, lingers where it is formed, and thus becomes a perfect iron cement, and the boilers are tight: not so the COPPER BOILERS; for the water, attacking the metal in its passage through, forms the carbonate of copper, a clear transparent solution, which is not crystallised till deposited on and spread over the bottom of the flues, where it continues its work of destruction. The track of the water, as exhibited in defective rivets, precisely resembles the tortuous operation of the worm in fruits or wood; being partly in the plates and partly in the rivets, so as in almost every case to require the hole to be much enlarged, in order to remove the defect prior

to the substitution of screwed rivets, which at the best are a poor substitute for a rivet of the original kind.

I have found, that when sufficiently acted on chemically, the above observations equally apply to the joints of the plates with the "angle irons," the apertures formed between them being sometimes entirely in the plate, which is thus decayed so as to receive copper pins of considerable size. This is the worst state of the evil; for the water by its pressure, in addition to that of the steam, acts mechanically as well as chemically in forcing its passage, which, if not timely stopped, will certainly eat transversely through the plate. It is also worthy of note, that the flues are found perfectly tight over-head and along the sides; the lower parts and the "angle iron" of the bottoms only, and that in spots difficult of construction, yielding to the action.

After a lapse of six years of active employment, I can safely pronounce the parts above the bottom of the flues and fire-places, exposed to the constant action of the fire and water, to retain nearly their original thickness; I say nearly, because the deficit cannot be actually observed or estimated unless by weight. From the line, however, which the usual length of voyage permitted the salt to accumulate downwards to the bottom of the flues, that is, to the extent of thickness of salt deposited, corrosion has evidently taken place, so much as to threaten the security of parts originally well manufactured, even in the face of caulking, &c. This evil necessarily continued in action for some months in the Mediterranean, when employed between Malta, Egypt, and Syria, on an average of twenty to twenty-four days per month at sea, in the total absence of Roman cement; which, when procured, again kept the flues tight and dry. The advantages of the cement, here exhibited, suggest its use not only when a boiler is defective, but when perfectly new.

I should propose, that when tried and found perfect, the flues should be well cleaned, and a flooring of cement applied by proper persons, so as to include the "angle irons;" tiles should then be imbedded nicely, forming a perfect surface from the chimney to the furnace, or, which was the method I adopted, a fillet should be applied all round the "angle irons," with a flooring beneath the funnel. Thus the water from the chimney, impregnated with the matters of the soot, would be entirely prevented, in the beginning, from acting on the bottoms of the tubes; and any spot beneath, being disposed to "weep," would be prevented till it had been permanently filled with sulphate of lime or other matter, which, on the contrary, would be forced onwards into the bottoms of the flues if water could freely pass. It would have another advantage,—it would afford facility in sweeping the flues, and would occupy the intricate parts, from which the soot is never thoroughly cleaned. No very material loss of heat would be sustained by this application, the fires not being calculated to reverberate downwards to a great extent: on the contrary, I have often sent wood into the flues, which has been withdrawn, merely charred; a proof that the bottoms of the flues,—those leading directly from the furnaces excepted,—contribute little to steam generation, even before any deposition of soot has taken place.

I think it probable, that "weeps" in the tops and sides of the flues, before alluded to, are first checked by the intensity of the fire acting on the water as it oozes, when the lime subsides and hardens to cement; for there is no reason why "weeps" should not have existed in equal abundance in these places, as well as in the bottoms; but it is certain that none have been exhibited.

The bottom and lower parts of the shell of the boiler should be treated with as much care in construction, as it has been suggested to pay to the bottom of the flues ; and the chimneys should invariably be made of *iron*, to step on a cast-iron ring fitted to the top of the boilers. The cast-iron ring does not seem to be affected by the copper ; its situation accounts for it.

23. COPPER FUNNELS have been a complete failure, in every instance of their adoption ; they are rapidly corroded within the air casing, so as in one or two instances to have been crushed by the effects of a gale of wind. IRON FUNNELS decay principally in the parts on which the waste steam operates, and these plates require renewal more frequently than the rest ; therefore it is better to carry the waste-pipe level with the top of the funnel : coal tar, or red lead, or a mixture of both, is the best varnish I have known to be adopted for funnels, which with care may last five or six years.

In conclusion, I confidently express my opinion that COPPER BOILERS are very far superior to Iron for marine purposes ; and that if the necessary precautions in construction be observed, they will run for a considerable time without giving trouble of any kind. Tinning the bottom plates, lately observed by Messrs. Maudslay and Field, I should certainly recommend ; it will remove the chance of decay to a certain extent. Large pieces of iron have frequently been sent into the flues by me, which have been completely decayed in a short time ; no doubt with some good effect to the copper, but without the possibility of being estimated. If the cause be removed by attention to the suggestions on construction, a patch will seldom be required ; consequently delays will be seldom experienced on account of the boilers. The original cost is nearly as three to one on the iron ; this ought not to deter companies, or the proprietors of foreign steam vessels, where the means of repair is not at hand : besides, when unfit for further use, they will always make a good return as old copper ; an old iron boiler being, in general, worth little more than the cutting up. Copper, again, is a better conductor of heat than iron ; and if the advantages of incasing marine boilers with non-conducting matter were properly considered and availed of, boilers might be reduced in capacity, weight, and expense, to the obvious account of the proprietor, and to the increased stowage of fuel. More might be said, but the above, coupled with the fact that the shell will scarcely ever be injured or decayed, will be sufficiently demonstrative ; when iron boilers frequently require extensive repairs of the shell or casing, either from water passing by the funnel on the top of the boiler, or from the unavoidable leaks of the deck and comings around the steam-chest ; also the shell is decayed, from the salt, &c. on the line of stoke-hole plates or flooring, as well as in the neighbourhood of most of the stay-bolts on the back and sides,—the bottoms being often totally decayed ; and these are parts which, from their situation, cannot be attended to conveniently. The above facts are notorious in iron boilers, when in many instances no other defect has existed ; indeed, copper boilers appear to be almost invulnerable in those situations where in iron boilers, whether employed or not, the work of decay is constantly going on. Many cases of delay and incapacity could be mentioned from these causes alone, when important public service was most urgent, not to mention that of individuals.

It is a common practice in many vessels to throw water into the ash-holes, to cool the cinders prior to sending them up ; the salt, which adheres to the ash-pit in consequence, has sometimes destroyed the bottom plates, when every other part of the boiler was sound. I have seen some instances recently, where the water discharged from the gauge cocks is

conducted there by tubes : the men avoid being scalded by this arrangement, at the risk of the destruction of the ash-pits by the brine there deposited. Water in ash-pits has a cooling and draught-exciting property on account of the evaporation ; but it ought on no account to occupy the ash-place of an iron boiler, unless a cistern, constructed for that purpose, was appropriated for its use. In copper boilers I have disregarded the water arising from " weeps " in the ash-pits, no chemical action taking place here, when employed at sea, on account of the frequent removal of their contents. The intrusion, however, of sea-water into the ash-holes, no matter from what cause, ought by no means in any boiler to be encouraged.

My object having been to show by comparison the advantages of copper over iron boilers for marine purposes, and to set in a proper point of view the deposition of salts, their effects, and the means of avoiding the same in boilers, as now adapted and arranged, I think that for the future, as regards these matters, all vague speculation, with practical men, may be laid aside ; the evils complained of having been shown to arise, in *all cases*, both from want of sufficient care in construction, and in the ultimate management.

CIRCULATING PIPES, DAMPERS, &c.

24. Circulating pipes, that is, pipes of communication between boilers when more than one is used, are generally fitted with a small bonnet for the purpose of cleansing. The situation of these pipes generally is such as to deprive the engineer of examining them at all times : the pipes on the sides are concealed by the coal-boxes ; those abaft and forward being usually at hand.

Now, in many instances, the feed, or water for the supply of evaporation, is injected into the front boiler or boilers, those abaft depending mainly on the condition of these pipes, through which they are intended to be supplied. Instances occur where the flues have been much burnt and injured from incrustation, while the fire-places situated in the front boilers were in perfect order. The pipes have been choked, and of course a sufficient supply could not be maintained in the after boilers ; hence the deposit and permanent injury. The coal-boxes, therefore, and other obstructions, should be so modified and cut, as to afford convenience for examination ; which should take place *at least* on the return from every voyage, the small bonnet being removed from each pipe, and its condition strictly looked into. If duties be ever so pressing, commanders should always afford time for, and engineers strictly fulfil, this most important one.

Circulation of the water through all the boilers should never depend entirely upon the pipes, but should be maintained moreover by free communication above the flues ; and these communications should be cut as near the surface of the flues as possible, in order that the blowing off one boiler may to a certain extent affect the condition of the water in the rest. The ' Flamer ' and some other of the government steam vessels have lately been fitted with two tiers of connecting pipes, the upper ones three inches below the level of the flues, and thereby favoring the circulation desired. Cutting the passages through the joining boilers, for sea-going vessels, sixteen or eighteen inches above the flues, has been deemed necessary to prevent the water from leaving the flues of the side boilers when rolling : experience shows this precaution to be unnecessary, the temporary inclination of the ship never exposing the flues to injury, when rolling simply ; and no extraordinary angle is to

be anticipated, such as canvass would effect, it being sufficiently understood by commanders who have the least acquaintance with steam vessels, that the sails are a disadvantage when they give the lee-wheel too much depression. A single boiler may be at least eight feet wide without any risk, with the ordinary quantity of water above the tubes ; indeed nearly twice this width may be trusted safely, as instanced in front boilers containing four fire-places of considerable size. A wash plate fitted into the middle of the after boiler, fore and aft, upon the flues as high as the water line, would answer every purpose of preventing the water from entirely leaving the wing flues, on taking a lurch : the same arrangement may be adopted in a front boiler ; but it is not absolutely necessary, the water above the tubes having a greater depth, generally, than that of the other boilers.

25. Boilers for steam vessels of great or considerable power are necessarily constructed in two, three, or more parts : these parts are best arranged when they are the entire length of the boiler fore and aft, their ends forming the front and back of the whole : thus the longitudinal boiler precludes the inconvenience liable to connecting pipes in the coal-boxes, and to the heavy rolling of the vessel causing the water to recede from above the flues. Each boiler can then be entirely distinct from its neighbour, having its own feed and blow off pipes, and containing its own fire-places and flues ; the smoke and heated air arriving at the upper surface of the boiler, to the chimney, before it mixes with that from the other boiler or boilers. The base of the chimney in the case of three boilers, placed side by side, may be of an elliptical or oblong, instead of cylindrical figure, covering the mouths of the flues, which should *each* be furnished with a damper, fitted directly on the boiler, and quite distinct from the funnel ; having a communication by levers with the engine-room in front of the boilers, and thus being at all times under the control of those below.

When a DAMPER is fitted in the chimney, it will inevitably be carried away with it in case of accident, and the ship exposed to fire : a recent instance occurred in the 'Thames' Irish steamer, in the Channel, where the vessel was nearly on fire from the sudden loss of the funnel by a ship running on board her in the night. I have seen funnels carried away in harbours, by getting athwart hawse of other vessels. Accidents are not uncommon at sea, particularly when the funnels are of copper, which, decaying rapidly within the air casing, is less calculated to resist a gale than iron. I have frequently been surprised that funnels stand so well as they do ; preventer stays are often necessary : therefore, fitting dampers in the chimney should by no means be adopted.

To complete the arrangement, each steam pipe should have a COMMUNICATION VALVE ; or a valve should be fitted on top of the steam chest of each boiler, where they join the common steam pipe ; so that either of the boilers may be employed, without at all depending on its neighbour ; the safety valves, as usual, having one common waste steam pipe. The advantage of this mode of construction is obvious, when it is understood that in a gale of wind, or in the case of a ship of war cruising with a squadron by steam, not half the power can be employed with effect ; then one boiler or two can be dispensed with, according to necessity, with a saving of fuel, almost in a ratio to the consumption of the boilers unemployed ; I say almost, because a certain portion of heat will be lost by radiation, and by the absorption of the contiguous boiler. In going head to wind the above advantages are most felt ; for the number of revolutions at full speed, of *sea-going* steam vessels, varying from thirty to twenty-two per minute in smooth water, within the limits of 80 and 200 horse power inclusive, and when contending with a strong gale ahead, the speed being reduced to eight or nine

revolutions per minute in most cases, it will be seen that the demand for steam is wonderfully less in the latter, than in the former case. There being two engines employed, and each making two strokes to effect a revolution of the wheel, four cylinders full of steam are consumed in the same time, though of a pressure less than that on the safety-valve: independently of expansion, the pressure of the steam is diminished by condensation in the passage through the steam pipes and jackets, which, by the bye, is very considerable in those vessels fitted with the cylinders forward. Now, the loss of heat by radiation from the steam pipes, cylinders, and slide casings being constant at all speeds, the saving, by dispensing with the use of one or more furnaces, will fall short of the expectations raised by their temporary disuse, inasmuch as the remaining furnaces require to be urged. A furnace cannot be thrown out of use with economy, when the fuel contained in the remainder must be disturbed often before it is fairly consumed; and this must be the case, unless the mouth of the furnace unemployed be closely covered in, the in-draught of cold air through the same being a great drawback on the effect of the other furnaces: hence the greatest effect will be produced when an entire boiler is thrown out of use. When one furnace only of a boiler could be dispensed with, I have often found it most economical to burn the ashes of the rest therein, mixed with a little coal; and when too dirty, or the draught too much impeded by clinker, another furnace performed the same office, while it was thoroughly cleared out, and became an active furnace; and so on in turn with the rest.

26. Since it has been shown that the consumption of fuel, on principle, should be expected to be in proportion to the revolutions of the wheel, but that in practice it is found to be much greater,—the masses of the boilers, cylinders, pistons, &c. &c. having at all speeds to be maintained by the *steam* at its own temperature,—it follows that the less these parts are exposed, the better; and if radiation were prevented by completely covering the boilers, steam-pipes, and cylinders with non-conducting materials, the saving of coals only would soon amply return the cost,—particularly in sea-going vessels, where gain cannot at all times be effected by bearing up for a port, but where the gale must be struggled with for many days together,—not to mention the constant injury sustained by bulk-heads, comings, and decks, by the overpowering heat to which they are submitted. The frequent repairs and renewals of these parts only, amount to no small cost per annum in Her Majesty's steam vessels on foreign stations.

Economy of fuel on long voyages has not, I am prepared to say, met with the attention it deserves: stokers consult their own convenience; and as long as they keep *plenty* of steam flying off to waste, they are seldom called to account: as to myself, I have found the greatest difficulty in obliging them to keep the fires uniformly. In a gale of wind, and then only, when the labour was little on the fires, and when it became a consideration with every one, both on deck and below, to eke out the means of arriving at the destined port in safety, the fires were minutely attended to, and the fullest effect obtained at the least possible expense: a few *clinkers* only, and *no ashes*,—which should never, in iron boilers, be allowed to remain longer than two hours in the ash-pits, or in contact with the boilers on the stoke-hole plates,—were thrown overboard twice in twenty-four hours, when such discipline was observed, and this with the Welch coal. How much greater would the gain be *at all times*, if the oppressive heat, which drives the fireman from his quarters now, were removed, so as to permit him to dispose a *less* portion of fuel to a wonderfully increased advantage? These considerations are by no means visionary; the people in Cornwall understand them well, and

profit thereby to a considerable amount. I have, on a summer's day, found it sensibly cooler in an engine-house closed, containing a cylinder eighty inches in diameter, and ten feet stroke, while the steam-gauge indicated thirty-four lbs. per square inch on the safety-valve, than I experienced without: the boiler-house nearly the same. Is not economy in fuel as loudly called for in marine engines, without reference to stowage, health, and the labour and dirt of shipment?

The advantages above proposed are now carried into effect to a certain extent in Her Majesty's steam vessels, by coating the boilers, whether of iron or copper, with "felt," laid on a thick covering of a mixture of white and red lead; the same treatment has been observed with regard to the sides of the respective boilers where they come together, when smoke-joints do not interfere: the advantage of this does not consist only in the preservation of these sides, so liable to decay from the water which descends there leaving its salt adhering to the plates, but it operates to prevent the heat of one boiler from being transmitted to another when not employed; indeed, the practice of coating boilers of marine engines was observed as far back as 1818 in the 'Caledonia,' Mr. Watt's private steam vessel, and also in the 'James Watt' in 1823:—the cylinders of the former were also coated in the same manner and covered with reeded mahogany. By combining the arrangements before mentioned, so as to have the respective boilers and flues distinct, smoke-joints may be entirely dispensed with: these are generally dangerous, although often unavoidable, both from the size to which the boilers are required to be carried, to meet the power of the engines, and from the necessity which sometimes exists of adapting them to the peculiar construction of the vessels.

27. From the frequent necessity of opening the furnace doors, when under weigh, to replenish and arrange the fires, a large portion of cold air is allowed to pass through the flues; this ready passage for the air checks its entrance through the bars of the adjoining furnace or furnaces, and in most instances throws them for the time nearly out of use: thus the boilers are not only deprived of the effect of the open furnace, but, to a great extent, of all others connected with the common flue: this is so certain, that boilers having four furnaces joining in one flue, as formerly fitted to vessels of 100 horse power and upwards, have been supplanted by others in which two furnaces only discharge their fire into a flue which meets that of the other two furnaces at the chimney, having traversed the water separately before they meet. The former plan of boiler is always remarkable for a bad or indifferent draught; it requires more area of heated surface to generate sufficient steam, occupies of course more space, contains a larger quantity of water, and is, in addition, considerably heavier than the latter style of boiler, which is distinguished for its power in producing steam, and for the ease of working it. Hence it follows that the more distinctly furnaces perform their work, the greater the effect obtained; but this has its limits; for if a flue is too direct, a great portion of heat passes up the chimney without effect, the fire not having traversed sufficiently through the water to be absorbed by it. In land engines this defect is not experienced, the fire passing around as well as through the boiler; while in vessels the fire must be entirely confined to the flues, which are surrounded with water.

Some of the best judges of the construction and working of marine boilers recommend that the fire should be divided by as many furnaces as possible within certain limits, in order that the feeding a fire should not occupy too much time, and that it might be performed more frequently, and in consequence more regularly; and, it is presumed, with better effect, on

account of a less portion of cold air being permitted to pass through the flue at a time. When *three* such furnaces are employed instead of two, (for it has been observed that four are decidedly objectionable,) which communicate with a common flue, it is evident that there are always two furnaces in action, while the third is being entirely cleared out; an operation which at sea must be performed at least, in turn, once in two hours, the fire-door being open during the operation, and a considerable quantity of cold air afterwards passing through the grate until the relay of coals is in a proper state of combustion. Here the three furnaces have a decided advantage over two of the same area collectively, in maintaining the power of the engines during the disuse of one of the number: but if the two furnaces be managed properly, want of steam during the above operation will rarely be felt. Of course these observations are referred to vessels of such power, as to have, at least, two distinct boilers, or two distinct sets of furnaces and flues in the same boiler, so that you have the full effect of one or more boilers or sets of furnaces, without any drawback, at all times. From the necessities of construction, *three* furnaces cannot *directly* discharge their fire into a flue, whose width is less than that of either of the furnaces individually: the fire having, in one furnace at least, to cross, to a certain extent, that of another before it can enter the flue, this furnace is least active when either of the other furnace-doors are open, the cold air directly entering the flue retarding its effect: the fire of this furnace moreover, when all are in full force, acts directly on the side plates of the cross flue opposite, before it passes with that of the other furnaces into the common flue; the consequence is, that if the boilers are partially incrustated, these plates must be the first to give out, next to those of the furnaces, of which there are many instances. Hence when three furnaces are employed, the flue should be deflected as much as possible, to accommodate each of them.

28. From an extensive examination of the boilers of long sea voyage, I am led to the opinion that the fires act more destructively on the sides of narrow furnaces, than of those under similar circumstances of greater width; it may arise in a great measure from the fuel being heaped up more thickly in the former than the latter: the air not being able to penetrate the mass well in the middle, then passes up the sides, urging an intense flame to act thereon; this cannot take place so effectually in a wider furnace. A furnace that is very long cannot be properly managed by the firemen at sea: it has every chance of being overcharged, more particularly if the boilers keep steam easily, because then they require less attention, and are charged so as to last as long as possible for the accommodation of the man; and this practice cannot well be overruled night and day, unless engineers neglect other duties; for it would be necessary to be constantly in a stoke-room for the purpose. I should say, that if a furnace be six feet in length, it should not be much less than three feet in breadth, to afford a fair chance for firing with as little injury to the side plates as possible, and with the means of keeping the fires in the required condition for the greatest effect: furnaces should not be carried beyond this length more than can be avoided; it is not necessary that they should ever be wider than three feet, indeed it would be inconvenient: but the nearer it is approached in width *for various powers*, I think, the better. By adopting short and wide furnaces, short firing-tools become necessary, and of course short stoking-room, thereby gaining on the entire section of the ship for the stowage of coals abaft. The crowns of the furnaces, whether of iron or copper, never decay, and rarely alter their figure, if arched, unless the water is allowed to descend below them. In some of the most neglected and most injured boilers that I have seen, the crowns of the fire-places have remained perfect, when every other part has been attacked by the fire: it

can be accounted for by the ready transmission of the heat, which is obstructed more on the sides, from the accumulation of scales and the increased difficulty of removing them.

29. In the arrangement of *plates in the furnaces*, perpendicular seams are bad, and in long voyages are certain of injury from the fire; the quantity of metal at the joinings or seams causing an unequal expansion, and retarding the transmission of heat. Plates the entire length of fire-place may be employed, having their seams beneath and in the direction of the bars; the upper seam, when the furnaces are large, being as much above the fire as possible; but, on this subject, opinions are divided, some still preferring the former method of construction. Plates of copper may be manufactured with certainty of the entire size required for the sides, in 50 horse boilers; but iron plates of such dimensions could not be depended on. Iron plate for furnaces should be manufactured of the best material that can be obtained; additional expense for such would be amply repaid. The plate used for furnaces mostly owes its premature destruction to the great thickness usually employed: it thus conducts heat more slowly, and is necessarily more heated than thinner plate; besides it is much less likely to be sound than the latter, although of an excellent exterior, which conceals the defects of manufacture. I some time since examined, in a foreign port, an excellently constructed boiler of a 200 horse marine engine, and of the very best material, which had been comparatively seldom employed during eighteen months after construction: the interior of the boilers evidenced the greatest care and attention, but the side plates of the fire-places, from the bars upwards, required to be replaced, from no other cause than that of being too thick. These cases are very common, as before observed, in Her Majesty's steam vessels between Falmouth and the Mediterranean, as likewise those employed on other stations, which need repairs in these places several times before the boilers are required to be taken out, from actual decay.

Many have been formerly misled as to the cause of injured boilers. I have witnessed ingenious expedients of negligent persons to account for the same, in the presence of eminent engineers, who, not having an opportunity of watching proceedings on a long sea voyage, were obliged, to a great extent, to take plausible reasons as their guide; viz. saltiness of the Mediterranean, &c.: allowing water to become too low in the boilers is too frequently the real cause, which, if copper, will soon exhibit the consequence. Thicker plate has been adopted, probably to resist the tendency to bend, but it only increases the evil. Plates for the sides of fire-places then should not, in the largest boilers above the bars, be more than three-eighths of an inch thick; and in smaller boilers a less thickness would be preferable, as no oxidation takes place here, or even throughout the flues, of any consequence, above the mass of soot therein deposited. This fact is decidedly opposed to the *notion* generally propagated, that the iron rapidly imbibes oxygen from the cold air admitted, when the fire-doors are opened to replenish fuel: no more injury is experienced *practically* from this cause, than that found to be sustained by the exterior of a common culinary boiler, the plates not being sufficiently heated to imbibe a destructive portion of oxygen.

The lower part of the sides, and the bottom of the fire-place, should be thicker in all cases, the better to bear up against oxidation, which here takes place to a great extent, as likewise along the bottom and lower part of the flues; and the bottom of the boiler, and the lower portion of the sides, should be stouter than the crown, particularly in the wake of the stoke hole flooring, where, as has been before observed, decay very rapidly takes place.

It has sometimes occurred that boilers of good construction have suddenly failed in generating the necessary quantity of steam for the engines, although the fires have been urged as usual: this unaccountable circumstance, after the strictest investigation, has been cleared up by the appearance of steam at the top of the chimney, instead of at the waste steam head. The UPTAKE, or portion of the flue which rises through the water of the boilers to join the chimney, has been found defective, so that the steam escaped above the water line, through the rent it made, directly into the funnel or chimney, the boilers in every other respect performing their duty properly: the uptake, therefore, should be thicker than the other portion of the flue, and should at frequent opportunities be perfectly cleaned and coated with some anti-corrosive: coal tar mixed with red lead, and applied hot, I should recommend.

The SHELL OR CROWN of the boiler, and STEAM CHEST, suffer most from accumulation of dirt, and leakage from above. Steam vessels are necessarily much more subject to be extremely dirty than other vessels; in fact, it is periodical every sixth or seventh day on foreign service, and sometimes oftener, to be completely covered with coal dust in every part exposed. Water is, and can never be entirely prevented from being, thrown over every part of the ship: it is this, and the every-day work of dashing water over the decks, that achieves the destruction of the parts above mentioned, more than any other cause; the rain and spray certainly assist. Hence too much care cannot be taken in rendering every part of the deck, or other covering of the boilers, as tight as possible. Waste and feed pipes rather interfere; but they can be, and are generally fitted now, beneath the deck, so as to be entirely out of the way of accident, in case the funnel be carried away.

The AIR CASING around the base of the funnel, in most vessels in Her Majesty's service, has been surmounted by a hood water-tight, so as to prevent the water passing in that direction completely, the flanch of the casing being made tight on deck; and the bottom cants of the coal-boxes are fixed two or three inches clear of the sides of the boilers, so as to permit dirt, which may not be intercepted by the pieces of wood, fitted between the crown and the coal-boxes fore and aft for that purpose, to be washed into the ship's bottom, whence it can be removed, thus preventing its accumulation between the coal-boxes and the boiler sides. If it could be afforded, sufficient space should be allowed for a passage around the boilers, by which they may be kept perfectly clean.

As little wood as possible should be used around the upper parts of boilers, in addition to the covering of the deck. Thin sheet iron, properly riveted and chinned, should take the place of comings, &c. which, with the carlines which support them, are frequently set on fire. Coals and wood, *not* directly in contact with the air casing, have often been fired in a very short space of time *on deck* when exposed, as likewise when contained in bags in the same situation. More than one air casing should invariably be fitted around the funnels of sea-going steam vessels, the air freely passing between them, so as not only to remove the risk of fire in a great measure, but also the oppressive heat which is experienced in still weather in warm climates, when passing or standing in the neighbourhood of the same. The outer casing, whenever the construction of boiler will permit, should have a large flanch fitted *on deck*, which should be cut round as far as possible from the casing, the flanch being made perfectly tight, which can never be attained by the pitch and oakum joints of comings, or the hatches or platforms they support. Corrugated iron is a neat substitute for wood to surround the parts of boilers

projecting above the decks, in vessels which cannot conceal them beneath ; but when the deck is sufficiently above the boilers, projections of hatches and scuttles should be avoided, the deck being more easily kept tight by being often wet, and occasionally caulked.

WATER-WAYS of marine boilers, to economise space, are often made much too narrow ; so that the crust, in falling from the sides of the flues, is intercepted with other matters left in the boilers by oversight or neglect ; thus forming convenient shelves on which the calcareous matters repose and continue to accumulate. It is then inevitable, that the side plates will be "drawn" or bent towards each other by the fire, in its passage through the flues : not unfrequently, in such cases, the flues are so obstructed as to become impassable. The fire in its zig-zag course now attacks the bends or extremities of water-ways, which turn its direction into the joining flues ; cracks and openings are soon made, through which the water and non-conductors are forced ; in these places, patches are with difficulty fitted, and, from their situation, are exposed to be speedily injured from the increase of mass. Water-ways in no instance should be less than four or five inches wide, and in those between the fire-places something more ; the ebullition being so rapid here, that the water is more likely to be repelled, and the plates exposed to injury, which a sufficient quantity of water would obviate to a certain extent. If it be found convenient to make the spaces six, seven, or even eight inches, which is more than necessary in the largest boilers, no increased expense of fuel will be felt in practice, after the bulk of water is once heated : this fact is quite established. Too much space beneath the flues, in the lower class of vessels having little depth of hold, is not necessary ; it takes away from the room above, requisite for scaling, and adds to the gross weight unnecessarily, by the increased stowage of water. A rectangular trunk or trough, extending the entire length of the bottom of each boiler, with a man-hole at both ends, is the plan most desirable ; and being fitted between the sleepers, it descends beneath the other portion of the bottom, and becomes a receptacle for all the scales which may fall from the tubes. From the bottoms of these trunks the blow-off pipes, well protected by a grating, should proceed : thus the necessary space is gained, without too great an increase of weight or height.

Boilers that have been much incrustated, and the water-ways in many places choked, have in some instances, when blowing off could at all be effected, been perfectly clear beneath the flues ; that is, the scales have not combined into a mass : therefore, the space in addition to the trunk need not be much more than that pointed out for the water-ways between the flues, except in large vessels, where a space beneath the entire bottom of the flues is desirable for repair ; and for the purpose of affording means of keeping the bottom of the shell perfectly *dry* when not employed,—a very necessary precaution on a foreign station. The accumulation between the tubes is much to be guarded against ; to meet which a sufficient number of man-holes should be cut through the upper parts of the boilers, so as to permit a due ventilation for the men employed in scaling the boilers, (a material object in a warm climate,)¹ as well as to afford convenience of repairing fire-places, and removing the scale, which I am persuaded has been often negligently permitted to fall between the tubes, by the people employed in scaling, to avoid the increased labour imposed by neglect of proper arrangements for removing the same, it not being at all times in the power of engineers to look after them : much time will be gained, as well in repairs as in cleaning, by anticipating these difficulties.

¹ Keeping the safety-valves open greatly assists in cooling the boilers.

The great preparation necessary for cleaning and scaling a boiler, and the number of hands required to attend with buckets, &c. to remove the crust, frequently prevent an engineer from entering willingly on the task, unless he can calculate on sufficient time for the same ; it is in proportion to the convenience afforded, that these duties may be expected to be fulfilled.

FLUES need never be wider than to allow convenience for repair and sweeping, without reference to the magnitude of the boiler, so that much gain may be obtained in heated surface in large boilers by the introduction of an additional flue, when the breadth will permit ; that is, the increased horizontal surface due to the dimension of a boiler for large engines over that of smaller ones will, with nearly the same water-ways, afford sufficient space for the flue as above, instead of increasing the width of the others to occupy the said space ; thus the surface of two additional sides is gained for steam generation. Fifteen or sixteen inches may be taken as a good standard for width ; it ought not to be much less, and need not be much greater.

30. As the safety of boilers must always be entrusted to the engineers, whose duty requires them to blow off a part of the water therein contained every two hours, it has often occurred, that from neglect, or from having their attention suddenly withdrawn from this momentous operation, the water has been allowed to descend below the flues and fire-places ; this, though rarely, might happen from a defect in the feeding-pump or some of its apparatus : the burning of fire-places and flues is inevitable, and almost immediate, *no notice being given till the injury is effected* ; and much greater mischief might take place, under the circumstances, from explosion even, when the water of the feeding-pump is violently repelled, and flashed into steam of a high degree of expansibility, by the red-hot metal on which it is injected. The above neglect, and its partial consequences, I have witnessed several times ; and it will and must be expected to occur again unless some arrangement is made, in order that the blow-off cocks or valves shall be closed, and the blowing off cease, when the water has descended to a certain limit consistent with the safety of the flues. In fact, I have considered blowing off, at all times, so important and dangerous an operation, that I never permitted it to be performed without the attendance of one fireman at least, with the engineer of the watch, whose undivided attention was directed to trying the gauges, till the moment prescribed for shutting the cocks : so valuable a part of the machine as the boiler should not be left entirely to the discretion of men who may or may not look properly after it.

A "DETECTOR PIPE," as now fitted in some of Her Majesty's steam vessels, will effectually give notice of the approach of danger, in case the water is allowed to become low, as well as in cases where the action of the safety-valves becomes obstructed from any cause whatever, of which we have lately had alarming instances. This pipe is bent like a syphon ; one leg of which, two inches in diameter, to avoid becoming foul, descends beneath the water of the boilers to a point above the flues, where they are perfectly safe. From the bend, the height of which should be above that due to the pressure of steam in the boilers, a smaller leg descends to the engine-room ; the bottom being directed towards the ash-holes, with stop-cocks at hand, to be used when the boilers are entirely blown off on arrival, and so arranged that the cocks must always be open when the levers or spanners are removed. A hole is made, or a tube inserted, in the upper part of the bend, so as to prevent the "detector" on the inclination of the ship, or otherwise, from acting as a syphon. The steam rushing

violently through the apertures into the engine-room, when the water is below the mouth of the pipe, will not only arouse the attention of those below, but will alarm the people who are at all times on watch on deck : there could then be no false account of the neglect, which would thus be publicly made known. Time will thus be afforded either to shut the valves or cocks, or to haul out the fires, when the boilers will be safe.

Instances have often occurred of cocks being re-opened by the engineer instead of shut : now in vessels, as fitted by some engineers, cocks may be shut when turned half round, and by others, with the common two-way cocks, which are shut only when turned one quarter of a circle ; thus, by force of habit, a person may inadvertently, in a strange vessel, re-open instead of shut a cock, and think all secure ; it is the work of a moment, and this I have seen take place.

Mr. Kingston, by a very simple contrivance, applicable to any of the ordinary blow-off cocks, entirely prevents this occurrence. A fork, or two horns, are fitted to the bottom of the common socket-spanner, which project so as to meet the pipe or shell of the cock, when it *must* be either open or shut, an opening of the figure of the socket and its horns being made in a plate which covers the cock, for that purpose. When the cock is open, the horns are beneath the plate, and of course the spanner cannot be withdrawn ; so that a general order being given by the chief engineer to every person connected with the engine-room, that the spanner is on no account to be left in its place, it is clear that any one removing it must leave the boilers safe ; and its situation being generally in the middle of the stoke-hole, if an engineer's attention by day or night should happen to be called off, a fireman will, on observing it, be aware that all is not right, and will act accordingly. By adopting these precautions, which should be general in sea-going vessels, and are attainable at little cost, accidents which they are immediately intended to ward off will rarely be heard of ; they scarcely could occur without the grossest neglect under such arrangements.

Glass water-gauges are useful, to show by inspection the height of the water in the boilers ; but unless treated with great care, they will get out of order, and cease to be of service. *Copper floats* are much to be recommended, with an index to each appearing in the front of the boilers, the oscillation of which can be well observed night and day by every one below, and generally from the deck as well : floats seldom get out of order if properly made and attended to. Many boilers have owed their safety to the timely warning of the floats when feeding-pumps have ceased to act, and I am not acquainted with any real practical objection to their general use. I have known the feed to be regulated for days together, *at sea*, by floats, with great nicety ; but this office I should not recommend, the levers requiring to be adjusted according to the varying state of the weather and speed of the engines. These ostensible indicators of the quantity of water in the boilers should be fitted to every vessel without exception ; their just performance depends entirely on the care of the engineers.

Reverse valves, for the admission of air into the boilers when the vapour has less force than the atmospheric pressure, should never be less than four inches in diameter, and should be carefully cleaned and set in order prior to each voyage ; as (for they are rarely tight) the dirt and salt congeal around the spindles and gear to such an extent as to soon render them useless in case of need : I have never seen them act spontaneously, even when the steam-gauge has been an inch below zero ; and recent injury, to a great extent, by the collapsing of a boiler

from this inefficiency of the valves, points out the necessity of observing the above precautions strictly, and not of *fixing* them to their places, which has been done occasionally, to avoid the nuisance of leakage, by those not duly estimating their probable utility.

31. Ultimately, the *fixing of boilers* in their places requires particular attention, the bottoms often giving out before any other part of the shell. All copper bolts, securing the sleepers to the ship's bottom, should be clenched beneath the surface of the sleepers, and then covered with wood let in flush with the same: or plank may be brought on each of the sleepers, when fixed, of the entire length of boilers, and secured with iron nails; for, if a copper bolt-head comes in contact with any part of the bottom of an iron boiler, a hole will inevitably be eaten through in a short time in that spot, the most difficult of any to be repaired in place.

When the angle iron projects beyond the bottom of the boiler, in the manner of Messrs. Boulton and Watt, it is customary to fill the space inclosed, with wood nicely fitted and coated with white lead; so that, when in place, the bottom is well supported and protected from corrosion: but this method does not so well apply to other constructions of boiler; in bedding which, platforms laid across the sleepers should cautiously be employed. If a leak should exist in *any* part of the bottom, which is almost certain, the water, not being able to make its escape, flows beneath the bottom of the boilers, covering the surface of the platform, which supports them at the seams or stays only: this water is imbibed by the wood, which is thereby speedily rotted, the salt remaining in contact with the boilers, to effect their destruction. Boilers then, when not too near the bottom, may rest on the sleepers only, which should be thickly covered with some anti-corrosive, such as white and red lead; and when fixed in their proper places, some one should be sent beneath, to fill up spaces in such parts as the irregularity of the bottom has prevented from coming in contact. The vapour arising from the bilge-water does not at all affect the parts of the bottom exposed to its influence. Boilers that have been in use for some years, placed as above, (the application of red lead excepted,) have, when taken out, been found decayed in such parts of the bottom only as *rested on the sleepers*, with the exception of a few defects arising from bad workmanship or straining; the common lead-coloured paint remaining on the *plates exposed*, as when first applied by the manufacturer. But when the boilers by necessity are placed too near the wash of the bilge-water, their bottoms, which are soon covered entirely with salt, are rapidly and completely decayed: here platforms well covered with white and red lead must be resorted to.

32. The most important parts of marine boilers, and those on which opinions have not generally agreed, having been considered, from the facts, apparent on a strict examination of their details, when employed, and when totally dismembered after service, I have to observe, that if the boilers be constructed distinctly from each other, or so as to permit each series of flues to act on distinct bulks of water, the steam of each being under control, they will not only have all the advantages before described, but, as the efficiency of our steam marine is of paramount importance, and steam vessels are essentially ships, and liable to encounter the thousand casualties to which all ships are exposed,—a shot through one boiler would then by no means, after the escape of steam or water, prevent a vessel from continuing her way from an enemy, in the case of a merchant-ship; and if a steam-frigate, there would still be an opportunity afforded to manœuvre, while a single shot meeting boilers which are not distinct, would leave the ship a certain prize to the enemy. These considerations are not trifling, when it is recollected that steam vessels have already been extensively engaged for warfaring purposes in

Portugal, Spain, and elsewhere ; and although no shot has yet penetrated a boiler, the paddle-boxes and other parts have borne strong testimony of the risk to which they are liable.

The increase of expense to effect all suggested, is not worth mentioning as an item in the value of a steam-engine.

To illustrate the construction of marine boilers those of the 'Medea' and 'African' steam ships are represented in Plate XXII.

REMARKS ON ATLANTIC STEAM NAVIGATION.

33. In Atlantic steam navigation the fullest effect should be brought out with the engines and boilers as now constructed, the necessities being greater than that of any other effort of steam as a propeller.

WASTE OF FUEL FROM CYLINDERS.—I have alluded to the advantages of non-conductors ; this should be carried as far as possible in these ships. Cylinders, slide casings, as well as boilers, should be completely incased. The following facts will remove all question of the propriety.

In the 'African' the cylinders are about 5 feet 3 inches distant from the boilers : there are no hatches *immediately* over them, and the short steam-pipes are covered with fear-nought, &c. The quantity of distilled water produced from the belts of 50 feet square surface which girt the cylinders (there are no jackets surrounding them) in the Mediterranean, was constantly about 270 gallons in 24 hours ; that is, a quantity of fuel was lost by radiation from the belts of the cylinders in 24 hours, equal to that which would raise 270 gallons of water, at a boiling temperature, into steam.¹

From experiments made on board the 'African' in December, 1831, moored in still water, without the influence of tides, 306 cubic feet of fresh water (measured) were required to maintain the engines at an uniform velocity of 12 revolutions per minute for 6 hours, at an expense of 24 cwt. of Heaton Main coal ; one boiler or two furnaces only being employed ; a certain portion of heat being abstracted by the joining boiler, which was in all respects distinct from that employed : now 270 gallons = about 44 cubic feet of water produced in 24 hours from the belts of the cylinders ; and 306 cubic feet \times 4 = 1224 cubic feet of water evaporated in 24 hours by 24 cwt. \times 4 = 96 cwt. of coals, according to the experiment above noted.

$$\text{Hence } \frac{96 \text{ cwt.} \times 44 \text{ cubic feet}}{1224 \text{ cubic feet}} = 3.45 \text{ cwt. of coals as a dead waste,}$$

required in 24 hours to maintain the temperature of the belts alone.

Here the tops and other portions of two cylinders of 38 inches in diameter only, and slide casings, are not at all taken into consideration. The loss here recorded is rather under than over rated. The water thus procured was constantly appropriated to the use of passengers and the ship's company ; and, when on the Alexandrian station, *no other* water was made use of in the ship, 10 tons only excepted, being the greatest quantity received at Malta, the absence from which port being never less than 18 days.

In the steam frigates, the quantity of distilled water produced at sea in 24 hours, by the

¹ The steam pipes, although covered, no doubt contributed in some measure to the loss above stated.

jackets of the cylinders, of 162 feet square surface, amounts to upwards of 4 tons! equal to 143.36 cubic feet.

Now, according to the foregoing,

$$\frac{143.36 \text{ cubic feet.} \times 96 \text{ cwt.}}{1224 \text{ cubic feet}} = 11.24 \text{ cwt. of coals in 24 hours, to meet the radiation of heat}$$

from the jackets of the cylinders; and when they are placed forward, and at a considerable distance from the boilers, the expense is much greater.

The saving of fuel and comfort in the engine-room would be, on the whole, very considerable, particularly in 400 horse engines, were the loss, before estimated, prevented by clothing.

34. WASTE OF HEAT FROM BOILER.—As to the waste of heat from the boilers, from experiments I made in the coal-boxes, I found that when the thermometer ranged from 50° to 59° on deck during five days, it increased to 116° in the boxes, the thermometer being suspended from the beams in the neighbourhood of scuttles, which were left open more or less night and day, and through which the heated air was constantly escaping from the coal-boxes; this heat was radiated through a space of 6 or 7 inches, at which the coal-boxes were distant from the boilers, a large hatch directly over the boilers being at the same time kept open for ventilation. The thermometer, when the bulb was applied to the coal-box plates, two-thirds of their depth from the deck, varied from 138° to 148°; and when applied to the front plates of the boilers, the temperature indicated was 169°, not very greatly exceeding that of the coal-box plates.

One important fact was elicited on these experiments, that when the surface of the coals was removed, and the thermometer introduced amongst the lower portion, it was raised 36° above the temperature of the air in the boxes, vapour being given out from the surface exposed; that coal which was immediately in contact with the coal-box plates appearing as if dry distilled. From this I was led to judge, that the lower portion of the coal being pressed upon by the superincumbent mass, and constantly receiving heat from the moment of getting the steam up, maintained this heat embodied in the form of vapour; which, not being able to escape through the mass, assisted in extracting the gaseous portion of the coal, tending to produce spontaneous combustion; which I have witnessed in several instances, although these consequences are mostly found to be brought about by defective smoke-joints. The injurious effect of this heat on the constitution of the coal trimmers, and the great amount of fuel wasted by this channel, clearly demand every attention from those interested in the Atlantic voyage.

From the data furnished by the loss of fuel from the jackets of the cylinders, all other circumstances being the same, an approximation may be arrived at of the waste by radiation from the boilers; thus, the entire external surface of the boilers and steam-chests of the 'African' amounts to 855 feet square; and the area of the belts being 50 feet square, effecting a loss of 3.45 cwt. of coals per day, we have, $\frac{3.45 \text{ cwt.} \times 855 \text{ sq. ft.}}{50 \text{ sq. ft.}} = 58.99 \text{ cwt., or } 2.95$

tons of coals required in 24 hours to meet the loss from radiation in these comparatively small boilers: in this calculation, the surface of the bottoms of the boilers is included; the loss from which, it should be observed, is trifling when shielded, by platforms, from exposure to the bilge water.

The boilers, on the whole, are certainly less exposed than the cylinders, but, from their greatly reduced thickness, they transmit the heat more readily.

When one boiler only is employed, the side next its neighbour, by giving out heat thereto, is another source of loss. The side of either of the 'African's' boilers has 123 feet square surface. Then, as before, $\frac{3.45 \text{ cwt.} \times 123 \text{ sq. ft.}}{50 \text{ sq. ft.}} = 8.48 \text{ cwt.}$ of coals expended in maintaining the temperature of the contiguous boiler. I think this falls short of the actual waste by this channel in 24 hours.

'Dee' steam-frigate, 200 horse power; area of jackets, 162 feet square; external surface of boilers and steam-chests, 1783 square feet. Now, the actual waste by her jackets per day,¹ as before estimated, is 11.24 cwt. of coals; and $\frac{11.24 \text{ cwt.} \times 1783 \text{ sq. ft.}}{162 \text{ sq. ft.}} = 123.7 \text{ cwt.}$, or 6.18 tons of coals loss in 24 hours by radiation from the exposed surface of the boilers; the surface of the bottoms being included.

Again, the area of the sides of one set of boilers opposed to their neighbours in the same vessel amounts to 263 feet square. And $\frac{11.24 \text{ cwt.} \times 263 \text{ sq. ft.}}{162 \text{ sq. ft.}} = 18.25 \text{ cwt.}$ of coals loss in 24 hours from absorption, when one set of boilers alone is employed. If the above is considered as a fair estimate of the loss from radiation in 200 horse vessels, it must of course be proportionally greater in vessels of double the power.

35. ECONOMY IN THE EXPENDITURE OF COALS.—In order to obtain a correct idea of the number of days' fuel which a vessel can carry, an important consideration in vessels of long voyage, it should be estimated what amount the boilers consume at full speed in still water, (the greatest expenditure takes place under these circumstances,) making allowances for clearing out fires alternately, after having been some time under weigh: under every other circumstance, the consumption is rather less than greater. During strong gales the consumption may be very considerably reduced: I have seen seven days' fuel protracted to eleven, by working such of the furnaces only as were adequate to the wants of the engines.

I subjoin one or two extracts from my journal of a Mediterranean voyage, which will show to a certain extent the advantages of this practice, labouring under the drawbacks of radiation before detailed.

1st Experiment. 10 hours with Welch coal. Consumption, 9½ bushels per hour with 4 fires. Revolutions, 25 per minute. Speed of vessel, 7 knots per hour by log. Vessel deep; smooth water.

2nd. Strong winds a-head. Put out one fire, and closed the furnace-mouth. Consumption, 8 bushels per hour with 3 fires. Revolutions, 18½ per minute. Speed of vessel, 5 knots.

3rd. Strong gales a-head. 2 furnaces, or one boiler only employed (being robbed now by that in disuse). Consumption, 6 bushels per hour. Revolutions, 11 per minute. Speed of vessel, 4 knots.

These extracts of actual work will give the best idea of what might be further gained by a better arrangement than sea-going steam vessels are usually prepared with.

36. SWEEPING FLUES, &c.—Persons not practically acquainted with the working of

¹ The steam pipes were clothed.

marine boilers on long voyages, are liable to form erroneous notions of the accumulation of soot and its consequences. In the first place, soot cannot exist in the furnaces, when the plates of which they are formed, with the best management, are constantly giving out from the intense heat they sustain. The accumulation in the flues is principally on the bottoms, as will presently be shown. The chimney or funnel never *absolutely* requires to be swept, even in the worst cases of draught. In some vessels the practice is resorted to simply as a matter of course: in the 'African' it was *never* done, except to prevent the dust from falling on those repairing the flues immediately beneath, when it was previously beaten only on the outside for that purpose: again, the vessels in the Mediterranean packet service are never detained on their voyage of 1000 miles, no matter how long the time occupied thereon, to sweep the flues.

The 'African' eight or nine years since, when in the colonial service, made the passage from England to Malta direct, nearly 2000 miles. On the third day after her departure a fair wind sprang up, the wheels were unconnected, and the vessel put under canvass: it was thought a favourable opportunity of setting the machinery in order; the flues were swept at the same time, in order to profit by any advantage arising therefrom: after having sailed two days, they proceeded by steam at full power and fine weather for the nine succeeding days, at the end of which time no lack of steam was apparent. And recently she went from Malta to Alexandria, 820 miles,—thence to Beyrout, 320 miles,—back to Alexandria, and thence to Malta, without sweeping the flues,—a distance of 2200 miles; the necessity of arriving at Malta with the Indian mails, preventing the vessel from remaining a sufficient time at either of the posts for the purpose of sweeping the flues.

The sweeping of the flues consists simply in removing the soot and burnt fuel carried over by the draught from the lower part of the flues; the upper portions, which are available for steam generation, having merely a thin coating of soot, which by no means amounts to a formidable non-conductor.

After the long voyage of the 'African' above alluded to, I was curious to know the condition of the flues, more particularly as the steam was generated in abundance, without any apparent increase either of labour or fuel, immediately before arrival; a blue lambent flame (carbonic oxide) constantly appearing some feet above the chimney, as was usual after being a day or two under weigh: it appeared that the flame had reverberated downwards, so as to act on the lower parts of the first or main flue of each boiler: the soot was deposited on the bottoms of the other flues to a greater extent; and beneath the chimney, the soot was swept, so as to leave an opening about one foot clear, out of 4 feet 6 inches, the entire depth of flue; the voyage having occupied, with stoppages at Alexandria and Beyrout, about twenty days.

Shortly afterwards, a voyage was made from Malta to Corfú, of between four and five days; the flues were then swept, and, to my surprise, as much soot was withdrawn as on the occasion last described: it then became quite evident, that after a certain quantity of fine cinder and soot had been carried over and deposited, the surface, being swept by the flame and heated air, was rendered so light as to be carried up the chimney, and driven away at the same rate as its formation; and this conclusion was confirmed by the quantity of burnt soot which was strewed over the decks, at night in particular, after the awnings were furled, being sensibly crushed by the feet on pacing the decks. Again, having examined the flues of the same vessel, after being employed on experiments, &c. for twenty-five days, during the months of June and

July, 1837, (coals used principally, West Hartly,) the steam was generated abundantly at the conclusion, and the flues contained far less soot than I had calculated, which I attribute to less urgent firing: the sides and tops of the interior of the flues were comparatively clean. From this it may be inferred, that were sufficient coals on board, a vessel with boilers of *good construction* might continue to steam for an indefinite time or distance, so far as the accumulation of soot is concerned. It should be observed, that the coal employed in the two former cases was not all Welch coal; a quantity of Newcastle and Beyrout coal having been procured at Alexandria.

The flues of marine boilers are rarely on fire; I never saw but one instance, when the ignited soot was carried through the chimney in a shower which lasted nearly an hour, on board a merchant steam vessel which had only made the voyage from Ireland to St. Andero, and back to Falmouth. I have questioned several engineers of long experience at sea, who have never witnessed any other appearance than that which is common to all steam vessels after being some days at sea; viz. the flame of carbonic oxide flickering at the top of the chimney, and perceived only at night. The burning of a vast quantity of smoke, and its consequent soot, is to be referred to the great admixture with the air introduced through the fire-doors during the operation of feeding: this has been often exemplified by leaving the doors slightly ajar, when the smoke is most completely consumed.

37. FRESH WATER.—Charging ordinary boilers with fresh water, prior to starting for a long voyage, is certainly to be recommended; it cannot be too frequently done, if at no very great expense and labour of a ship's company. I think, however, its advantages have been generally too highly rated: it was rarely done in the 'African;' but from its probable tendency to loosen scale, as well as to prevent the formation of the same to a certain extent, till totally displaced by the salt water, it has its advantages.

From experiments before detailed, the engines of the 'African' were maintained at twelve revolutions per minute, with an evaporation of 306 cubic feet of fresh water in six hours, by two furnaces, or one boiler, a certain portion of heat being abstracted by the adjoining boiler: now with both boilers in use, the engines are abundantly supplied with steam at twenty-eight or thirty revolutions, a surplus flying to waste; so that we may reckon that at all times double the above quantity will be evaporated with both boilers.

That is, 306 cubic feet \times 2 boilers = 612 cubic feet evaporated in 6 hours; and $612 \times 4 = 2448$ cubic feet = 68.3 tons of fresh water required in 24 hours to meet the necessities of the engines at full speed; and this is more than treble the contents of both boilers when charged: so that during twenty-four hours the fresh water will have been displaced by more than treble its quantity of salt water: therefore the advantages of fresh water are limited, and a boiler may keep at sea for a considerable time, exclusive of accident, depending alone on the system of change usually adopted in vessels of long voyage.

Hence the only question of a vessel's continuance at sea, for any consistent period of time, is—the fitness of the engines,—the conduct of the boilers,—and the quantity of fuel which she can stow, compared with her consumption. Consequently the probable capacity of a steam vessel for the Atlantic or any other voyage, so far as her machinery is concerned, may be fairly estimated before she finally sets out for her destination; the contingencies of weather on the particular service being duly considered.

PADDLE WHEELS.

38. The arms, segments, and bolts of paddle wheels immersed below and in the neighbourhood of the water line, in the Mediterranean and between the Tropics, are found to decay very rapidly, much more so than I ever observed in the Channel or North Sea. Having to remove several segments, arms, and bolts at Malta, in order to substitute new in their places, after having been a long time in use, the oxidation exhibited in twenty-four hours on those new ones which were turned unprotected into the water was astonishing: large blotches of rust were distributed over the surfaces of the iron, which, when rubbed off, left corresponding holes, eaten to a considerable depth. On strict examination, I was led to attribute it mainly to the effect of the *wash* or spray dashing on the wheels when in harbour, a ripple or ground swell being generally felt in the finest weather, causing them alternately to dip into the water: the great heat of the sun speedily evaporating a portion of the water, which I have often taken at 81° Fahrenheit, leaves either brine or crystals of salt adhering to them, which of course becomes powerfully corrosive.

We must look, however, to another agent as the principal cause of destruction, when under weigh as well as in harbour. Some months after the above, I observed in the mole at Gibraltar, where the water is so clear that the bottom of the ship can be distinctly seen from alongside, that marine vegetation, barnacles, and lime were existing in great abundance in the neighbourhood of the paddle wheels, while every other part of the bottom was comparatively clean: this I pointed out to a friend, who immediately crossed with me to examine the opposite side, where the same appearances were presented, no part of the wheel being nearer than a foot or eighteen inches to the ship's side.

Hence I concluded, that to the galvanic influence of the copper sheathing was this effect owing, which became thus protected at the expense of the various parts of the paddle wheels: this influence has before been suspected, allusion being made to it in the instructions for Her Majesty's steam vessels; but its effects, I believe, had never been demonstratively exhibited hitherto. The circumstance was rendered still more remarkable, from the fact of the vessel having just arrived from a voyage of eight days; the water in this particular place being agitated more, and driven with a greater velocity, than on any other part of the bottom.

It was remarked often in the Mediterranean, by persons in the paddle wheels, which were the constant bathing-machines in harbour, that the ship's bottom must be very foul; in which opinion I was a party: to this was attributed any falling off in the speed of the vessel; and a "hog," or cleansing machine, was obtained to clear the same: but the bottom, when the vessel was taken into dock at Woolwich, was found, as before noted, to be kept sufficiently clean by constant employment at sea, no weeds or barnacles being found, except in the vicinity of the wheels.

Since the above observations, I have examined at Woolwich the wheels and bottoms of all Her Majesty's steam vessels that have returned from the Mediterranean and West India station; the bottoms being clean, except the parts immediately abreast the wheels, which were thickly covered with large barnacles, &c.; and in one instance in particular, the teredo worm had nearly bored his way through the ship's side *in this spot only*; the copper sheathing

not being carried sufficiently above the load water line : thus placing the inference beyond a doubt ; the activity of employment by no means interfering with the chemical action induced. The wheels and sides of those vessels employed in the Channel only do not exhibit the above effects to such an extent as those employed in the Mediterranean and Tropics.

Since the accumulation of matters on the ship's side *abreast the wheels* must be submitted to, I suggest that protectors, on Sir H. Davy's principle, be applied to all steam vessels in this particular place, in order to prevent the wheels operating as such.

Thus it is probable that the influence of the sea water only will have to be encountered with. I have found coal tar, heated by a shot plunged in to drive off the naphtha, when applied to such parts as were chafed, or otherwise left unprotected, to be a very good varnish for paddle wheels ; the wheels being examined, and covered in such places on the arrival from *every* voyage : by this treatment, a paddle wheel may resist the action of the sea water for several years.

Wood floats, as usually applied, directly on the arms, are constantly becoming more compressed thereon ; so that in a short time they are cut partly through, and of course are much weakened in these places : this is not all ; the portion of the arms impressed are eaten away by the moisture retained by the wood, long before any other part of the arm is decayed. From these causes, the bolts, which secure the floats to the arms, are constantly getting loose at sea, and are frequently lost before an opportunity is afforded to secure them ; the boards in consequence become slack on the arms, to the imminent risk of other parts of the wheels : to remedy this, iron plates not less than three or four inches broad, and three-eighths to half an inch thick, may be advantageously applied above and beneath the boards, across the entire breadth, in order to compress the board between the two. When the plates are defective, they may be thrown aside, and new ones substituted, the arms remaining perfect, and the bolts less liable to be lost : indeed in the Mediterranean packet service from Falmouth to Corfú, bolts are required to be replaced or secured at the end of each trip of six or seven days, in the common paddle wheels.

Boards, if possible, should never be carried out beyond the inner edge of the segments, or extreme ring of the wheel ; for no protecting coat can be applied within the slot made in the board ; and, of course, the board being always moist on both sides of the segments, they are eaten through in a very short time, while apparently in very good condition. Segments thus decayed often give way at one end, being whirled about the other in a flail-like manner, cutting the beams which carry the wheels, very destructively. In a sea-way this can rarely be remedied, and they must consequently be permitted, in such case, to come in collision till completely broken adrift.

II.—A FORM OF STEAM JOURNAL,

WITH

REMARKS ON THE NECESSITY OF KEEPING A PROPER RECORD OF THE OPERATIONS
OF THE ENGINES IN ALL STEAM VESSELS,

AND DIRECTIONS FOR MARKING THE STEAM JOURNAL,

&c. &c. &c.

BY THOMAS BALDOCK, LIEUT. R. N., K. T. S.

IN order to obtain any USEFUL information of the comparative working of steam engines, it is indispensable to ascertain the positive resistance which has been overcome, or the weight that has been lifted; but as this is a quantity which is ever varying when the engine is employed in propelling ships, it is absolutely necessary to obtain a just estimate of the retarding causes, and their occasional fluctuations.

The action of a steam vessel's engines, supposing them in good order, will be found to be diminished, and the speed of the ship retarded, according to the influence; first, of the wind; secondly, of the waves; and thirdly, according to the immersion of the ship in the water, from her lading: if therefore a scale be formed of the proportionate power of these obstructing causes, and a just record of their influence duly kept, together with an account of the coal used, a tolerably correct estimate may be obtained of the comparative duty performed, in proportion to the fuel consumed.

To effect this object, and to afford a permanent record of the operations of the engines, it is proposed, independent of the usual ship's log, to keep a steam journal ruled after the annexed form, in which the force of the wind may be expressed by numbers, according to a scale invented by Captain Beaufort, and intended for adoption in the navy, a copy of which will be found attached to the directions for marking the steam journal. It is also proposed, that the height of the wave above the trough of the sea may be estimated and marked in yards, with occasional letters to express whether it be a *long* and *easy*, or a *short*

and *chopping* sea ; thus, 1, waves under one yard high ; 2, waves under two yards high, &c. Ch, chopping ; L, long ; R, rough cross sea ; S, smooth water ; Sw, swell. The draught of water should be observed on all possible occasions. Draught or float gauges for this purpose were formerly in use in the British navy, but have long since been discarded ; though it is believed that all French ships of war are still fitted with them, and their use fully acknowledged. The usual form of float gauges consisted of tubes communicating with holes through the bottom ; one near the stem, another near the stern post ; the water flowing to the same height in these tubes as outside the ship, and thus indicating her degree of immersion : but as it is very inconvenient to increase the number of holes through the bottom, of which there are unavoidably so many in steam vessels, it is recommended that two horizontal pipes of small dimensions should be inserted,—one in the bow, the other in the stern,—about a foot below the light draught water line, and at a few feet from the stem and stern post, choosing some convenient spot on the round of the bow, directly over or vertical to the scarf of the stem, for the foremost hole, and placing the after one over the mortice of the stern post ; each of the pipes to be fitted with a cock, and communicating in some place easy of access with a glass vertical tube, the tubes having graduated scales corresponding with the ship's draught marks. On either cock being turned, it is evident the water will flow to the same height inside as out ; and the ship's immersion may, in a tolerably smooth sea, be read off with great facility and correctness, making it a rule always to stop the vessel a few minutes for the observation : and when it is recollected the frequent slight stoppages which a steam vessel makes on a long voyage, for the purposes of adjusting screws in the machinery, paddles, &c. &c., which may always be seized as opportunities of observing the immersion, the delay will hardly be objected to ;¹ at all events, whether the gauge is used or not, the draught of water should be observed on all possible occasions, and marked in the journal, with the addition of the letters F or E, to denote the boilers being full or empty : and as a very little experience will soon inculcate an adequate knowledge of the effect on the ship's trim, produced by the consumption of fuel and provisions, the draught may be estimated when it cannot be observed, and entered each day at noon in the proper column.

This habit of continually inserting the immersion, and observing the effects produced as the draught varies, will draw the attention of the officer to the important necessity of keeping his vessel in trim, by the judicious arrangement of coals or other weights, and tend to make him familiar with her qualities ; the judgment necessary to be exercised, in applying the proper symbols to express the state of the wind and sea, recording at the same time the rate of the engine, and the vessel's progress under every variety of circumstance, will engender a large portion of useful practical knowledge ; and the steam journal will become a valuable record of incalculable use, in promoting the science of steam navigation.

A table has been calculated, showing the rotary length of the path formed by the extremity,

¹ The plane of flotation of a vessel at rest, and the same vessel in rapid motion, is very different, even though the sea be quite smooth ; it is consequently impossible to obtain the statical immersion of any ship when sailing or steaming, either by actual observation or the use of any description of float-gauge ; though the immersion so obtained, if it could be observed, would have more immediate reference to the actual resistance experienced by the vessel in passing through the water.

or any defined spot on the radii of the paddle wheel, with the object of pointing out the difference between the velocity of the paddle, which by its reaction on the water propels the ship; and the speed of the vessel thereby produced. As it would be unreasonable to use for this purpose the extreme periphery of the wheel, which is so much immersed, so also it is not deemed proper to take that point on the radii which corresponds with the water line; but it is proposed that the velocity of the paddle shall be understood to mean the velocity due to the rotation of the wheel, of that point on the paddle about which all the propelling force is concentrated in the various positions it assumes, from its entering to its leaving the water, which may be called "the Mean Centre of Effort." The variable immersion of the paddle in each rotation of the wheel, together with other conditions that should be taken into consideration, render it extremely difficult to ascertain the exact distance, from the outer edge of the paddle, where the mean horizontal effort is collected, and the question involves the most abstruse mathematical investigation; it is however near the centre of percussion; and, as an approximation, we may, for practical purposes, assume it to be in Morgan's wheel at the centre of the paddle, and in the radial or old wheel at one-third of the board from its outer edge: thus in the latter case, supposing a wheel of 16 feet diameter, having boards 18 inches wide, the centre of effort may be assumed to be 7 feet 6 inches from the axis; and on reference to the table, we shall find that if a wheel of the above dimensions be making 21 revolutions per minute, the centre of effort is, in reference to the revolution of the wheel, travelling at the rate of $9\frac{3}{4}$ miles an hour; the difference between which and the speed of the vessel would be uniform, if the resistance was unvaried. It is proposed to note hourly, in a column next the "Knots," the rotary progress of "the Centre of Effort" in miles, derived from inspection of the table.

It is necessary to make a few observations with reference to the throttle-valve, which, as its use is to controul the admission of steam to the cylinders, is supposed by most steam seamen to do this so effectually, that a record of its partial closing or opening forms a just estimate, in all cases, of the power acting on the engine; but that this is not the case, may be exemplified by the two following hypotheses. First, supposing the ship in good trim, the weather calm, and the sea smooth, the throttle-valve being quite open, the engines will attain the maximum velocity, which may be assumed at 22 revolutions per minute, and the speed of the ship at 10 knots an hour. Secondly, the vessel's trim may be the same, the valve still open, but the violence of the wind and the sea may have so increased, that the rate of the engine is reduced to 11 revolutions a minute, and the speed of the ship to 4 or 5 knots an hour: it is now evident that the consumption of steam in equal times is about half what it was in the former case; it would be exactly half, except for the additional waste in the cylinder, and other slight causes. It is also evident, that if the valve be half closed, it would not diminish the quantity of steam used in the cylinder, or the power of the engine; thus, supposing a repetition of the first case when the ship is at full speed, it will be found that the valve must be nearly closed to effect any material reduction of the velocity.¹

¹ When an engine meets with any sudden increase of resistance, the steam will at first be spent at a higher pressure and greater density, even if the safety valve acts freely; but as on the occurrence of such cases at sea, the draught is always diminished by the damper, and the fires slackened, this effect must soon cease, and it will not be

It is however expedient to keep a statement of its operations, the benefit of which will be, that the officer will gain a practical knowledge of the effect produced by the partial opening or closing of the valves, when, in a high sea, the ship may be overpressed with steam power,— a consideration of the utmost importance; which, if leading to judicious management, may prevent incalculable mischief in the rapid deterioration of the hull and machinery, besides the possibility of immediate danger. The steam journal will form a permanent record of the way this duty has been attended to.

The course of the ship, her progress, and the direction of the wind, should also be entered in the journal, as the angle between the first and third will indicate the proportionate degree of resistance which the wind affords; while the numerical symbol in the column of "Force" marks its power, and the variation in the rate of progress forms the estimate of the effect.

If the table before described is used, a column should be ruled next the "Knots" for the purpose of marking the progress of the "Centre of Effort," the variations between which and the vessel's speed will form the basis of considerations most useful in estimating the effective duty of the engine. As the measure of *USEFUL effect or duty* of the marine engine is, in fact, the rate at which the vessel, under given circumstances, is moved through the water, the area of the paddle should be such as to displace the fluid (when acted upon by the maximum speed of the engine in still water at the mean trim of the ship) at that rate most favourable to propulsion by its reaction. A few experiments in each vessel would decide the proportion which the speed of the ship should bear to that of the "Centre of Effort;" these experiments of course being made under circumstances of known and unvaried resistance, in considering which particular reference should be had to the ship's immersion in the water. In closing this subject, it is necessary distinctly to state, that the position previously given for the "Centre of Effort," and also stated at the foot of the table, is only to be considered as an approximation, which may indeed be too far from the truth to admit of that appellation; still it is presumed that for practical purposes it is sufficient, though by no means meant as an absolute datum.

found materially to alter the assumption offered above; neither can it affect the principle, *that the power is not lessened in the same proportion as the aperture of the throttle is diminished*; although it still affords the means, if nearly closed, of using steam of low pressure in the cylinder when it is desirable to decrease the power.

S T E A M J O U R N A L .

Hour.	Knots.	Course.	Wind.		Imper- sion.			Revolutions.	Coal in Bushels.	Mean Height of			Boilers.				Initials of Engineers.			
			Direction.	Force.	Waves.	Abaft.	Forward.			Throttle valve.	Sail.	Steam Gauge.	Baro- meters.		Thermometer.	1.		2.	3.	4.
													L.	S.						
A.M. 1																				
2																				
3																				
4																				
5																				
6																				
7																				
8																				
9																				
10																				
11																				
12																				
Remains of Coal the		Tons.	Cwt.	Tallow.	lbs.	Oil.	Gals.	Qts.	Oakum.	lbs.	Coal used raising Steam bushels.									
Total used to day											For other purposes, bushels.									
Remains																				
P.M. 1																				
2																				
3																				
4																				
5																				
6																				
7																				
8																				
9																				
10																				
11																				
12																				

Report and General Remarks
of Engineer, the of 18 .

DIRECTIONS FOR MARKING THE STEAM JOURNAL.

In the column of "Winds," the strength will be expressed in the figures invented by Captain Beaufort to denote its force.

In the column marked "Waves," the height of the wave above the trough of the sea is to be estimated and expressed in yards, with occasional figures, to denote whether it be a long and easy, a short and chopping, or a cross confused sea: thus, 1, waves under one yard high; 2, under two yards, &c.; Ch, chopping; L, long; R, rough confused sea; S, smooth water; Sw, swell.

The draught of water is to be taken on all possible occasions, particularly at noon each day, and marked in the column of "Immersion," with the addition of the letter F or E, to denote the boilers being full or empty: when circumstances will not admit its being measured, it is to be estimated.

The operations of the throttle valve are to be noted thus: S signifies it is shut; 1 that it is $\frac{1}{2}$ open; 2, its being $\frac{1}{3}$ open; 3, that $\frac{2}{3}$ of the apertures are open; and O, that it is quite open.

The column "Sail" will show, by the insertion of the letter S or N, whether or not sail be set.

The average number of revolutions per minute for each hour, and the consumption of coals during the same period, are to be entered in the proper columns.

In addition to the mean height of the engine barometers, that of a thermometer is to be registered each hour: the latter should be permanently fixed in some part of the engine room where it cannot receive the radiated heat from the fire-places.

The sub-divisions of the general column relating to the "Boilers" will apply to the several boilers on board; and a note should be made in the first page of the journal, stating which boiler is expressed in each particular column. The partial blowing-off should be done at the discretion of the engineer, as the water approaches saturation; but in all voyages extending beyond one day, a portion should be blown off at least every two hours: the letter P will indicate that this duty has been performed, and the letter W will show when the whole is blown out.

The column of "Remarks" is to contain an account of every particular occurrence; as, when the fires are lighted (noting the minute at which the steam is raised), when extinguished, when banked up, &c.; also, any variation in the number of fires, when the engines or boilers are connected or unconnected, stopped, or set at work, &c. An entry is also to be made of every particular operation performed on the boilers or engine, noting when the flues are swept, boilers chipped,—stating the quantity of soot taken from the former, and the weight of calcareous or other matter from the latter; also when the connecting parts of the engine are examined, the wheels turned in harbour, or the paddles reefed; and prefixing to each day's remarks the description of coal then in use, noting any change thereof. The engineer is also to state the number of artificers employed in effecting repairs which may be beyond the power of the ship's engineers, particularly noting what work they are upon.

At noon each day a calculation is to be made of the expenditure of coals, oil, tallow, and

oakum, noting the remains ; an entry is also to be made of the coal used in raising the steam, as well as what is consumed for other purposes in the ship ; but the whole is to be included in the total stated to be used on that day. Although the coal is supplied in tons measurement, it is more convenient that the hourly expenditure should be calculated in bushels ; and it can easily be transferred to tons on totalling the account.

It would be interesting if an account was kept of the temperature of the hot-well, and of the quantity of water distilled from the cylinder jacket ; but it is not indispensable.

FIGURES TO DENOTE THE FORCE OF THE WIND.

- 0 — Calm.
 - 1 — Light Air . . . Or just sufficient to give steerage way.
 - 2 — Light Breeze . . .
 - 3 — Gentle Breeze . . .
 - 4 — Moderate Breeze . . .
 - 5 — Fresh Breeze . . .
 - 6 — Strong Breeze . . .
 - 7 — Moderate Gale . . .
 - 8 — Fresh Gale . . .
 - 9 — Strong Gale . . .
 - 10 — Whole Gale . . . Or that with which she could scarcely bear close-reefed main top-sail and reefed foresail.
 - 11 — Storm . . . Or that which would reduce her to storm stay-sails.
 - 12 — Hurricane . . . Or that which no canvas could withstand.
- Or that in which a well-conditioned man-of-war, with all sail set, and clean full, would go in smooth water, from . . .
- { 1 to 2 }
 { 3 to 4 } knots.
 { 5 to 6 }
- Or that to which she could just carry in chase, full and by . . .
- { Royals, &c.
 Single-reefed topsails and top-gallant sails.
 Double-reefed topsails, jib, &c.
 Triple-reefed topsails, &c.
 Close-reefed topsails and courses.

F. B.

A Table showing the Velocity of the Centre of Effort of Steam Vessels' Paddles and at various velocities; intended, by comparing the results with the

Distance of the centre of effort from axis of wheel, in feet and inches.		Number of revolutions required to make a geographical mile.	Number of revolutions per minute and corresponding miles per hour.		Distance of the centre of effort from axis of wheel, in feet and inches.		Number of revolutions required to make a geographical mile.	Number of revolutions per minute and corresponding miles per hour.	
			Revolutions per minute.	Velocity of centre of effort in miles per hour.				Revolutions per minute.	Velocity of centre of effort in miles per hour.
10	3	94.41	10	6.35	9	6	101.86	10	5.89
			11	6.99				11	6.48
			12	7.63				12	7.07
			13	8.27				13	7.66
			14	8.90				14	8.25
			15	9.53				15	8.83
			16	10.17				16	9.42
			17	10.80				17	10.01
			18	11.44				18	10.60
			19	12.08				19	11.19
			20	12.71				20	11.78
			21	13.35				21	12.37
			22	13.98				22	12.96
			23	14.62				23	13.55
			24	15.25				24	14.14
25	15.89	25	14.72						
10	0	96.77	10	6.20	9	3	104.62	10	5.73
			11	6.82				11	6.31
			12	7.44				12	6.88
			13	8.06				13	7.46
			14	8.68				14	8.03
			15	9.30				15	8.60
			16	9.92				16	9.18
			17	10.54				17	9.75
			18	11.16				18	10.32
			19	11.78				19	10.90
			20	12.40				20	11.47
			21	13.02				21	12.04
			22	13.64				22	12.62
			23	14.26				23	13.19
			24	14.88				24	13.76
25	15.50	25	14.34						
9	9	99.25	10	6.04	9	0	107.52	10	5.58
			11	6.65				11	6.14
			12	7.25				12	6.70
			13	7.86				13	7.25
			14	8.46				14	7.81
			15	9.07				15	8.37
			16	9.67				16	8.93
			17	10.28				17	9.49
			18	10.88				18	10.04
			19	11.48				19	10.60
			20	12.09				20	11.16
			21	12.69				21	11.72
			22	13.30				22	12.28
			23	13.90				23	12.83
			24	14.51				24	13.39
25	15.11	25	13.95						

N.B. The centre of effort in the radial wheel is about one-third of the paddle from its outer edge, and in the vertical wheel it is about the centre of the paddle.

According to the number of revolutions; calculated for wheels of different diameter's speed and fuel consumed, to show the proportionate duty performed.

Distance of the centre of effort from axis of wheel, in feet and inches.		Number of revolutions required to make a geographical mile.	Number of revolutions per minute and corresponding miles per hour.		Distance of the centre of effort from axis of wheel, in feet and inches.		Number of revolutions required to make a geographical mile.	Number of revolutions per minute and corresponding miles per hour.	
			Revolutions per minute.	Velocity of centre of effort in miles per hour.				Revolutions per minute.	Velocity of centre of effort in miles per hour.
8	9	110.25	10	5.43	8	0	120.96	10	4.96
			11	5.97				11	5.46
			12	6.51				12	5.95
			13	7.05				13	6.45
			14	7.60				14	6.94
			15	8.14				15	7.44
			16	8.68				16	7.94
			17	9.22				17	8.43
			18	9.76				18	8.93
			19	10.31				19	9.42
			20	10.85				20	9.92
			21	11.39				21	10.42
			22	11.94				22	10.91
			23	12.48				23	11.41
			24	13.02				24	11.91
25	13.56	25	12.40						
8	6	113.85	10	5.27	7	9	124.87	10	4.80
			11	5.80				11	5.29
			12	6.33				12	5.77
			13	6.85				13	6.25
			14	7.38				14	6.73
			15	7.91				15	7.21
			16	8.43				16	7.69
			17	8.96				17	8.17
			18	9.49				18	8.65
			19	10.01				19	9.14
			20	10.54				20	9.61
			21	11.07				21	10.09
			22	11.59				22	10.57
			23	12.12				23	11.05
			24	12.65				24	11.53
25	13.18	25	12.01						
8	3	117.30	10	5.11	7	6	129.03	10	4.65
			11	5.63				11	5.12
			12	6.14				12	5.58
			13	6.65				13	6.05
			14	7.16				14	6.51
			15	7.67				15	6.97
			16	8.18				16	7.44
			17	8.70				17	7.91
			18	9.21				18	8.37
			19	9.72				19	8.84
			20	10.23				20	9.30
			21	10.74				21	9.76
			22	11.25				22	10.23
			23	11.76				23	10.69
			24	12.28				24	11.16
25	12.79	25	11.62						

III.—ON THE MOTION OF STEAM VESSELS.

BY P. W. BARLOW, Esq., CIVIL ENGINEER.

THE benefits which this country has derived from the application of steam power to navigation by its certainty and rapidity, as well as safety of communication, must be too generally felt to require any remark in this place. In fact, the success which has in every instance attended the employment of steam power is such, that its extent is rapidly increasing, and voyages of much greater length are now about to be performed, among which may be mentioned those to America and to the East Indies.

The circumstances under which steam vessels are rendered available as a means of communication differ widely from each other; some being employed in river navigation, others at sea: in some, the voyages are of great length, and exposed to tempestuous and adverse weather; and in others, comparatively short and free from these disadvantages: in some, speed is the principal object to be attained; in others, great length of voyage. Under each of these circumstances, vessels of a particular construction, power, and tonnage, are best adapted to attain the specific object in view; and it is very desirable to ascertain as near as possible what these should be, which we think can be in a great measure accomplished by the examination and comparison of the results of what has already been attained.

Impressed with the general importance of the subject, and the advantages which may be derived from such inquiries, and my former residence at Woolwich having afforded me the opportunity of attending many experiments and collecting much information on the subject, I beg to offer to the public the following pages on the motion of steam vessels, in the hope that they may prove of utility to those interested in the progress of steam navigation.

The power of the steam engine, when employed in propelling vessels, being applied through the medium of a fluid by the reaction of the paddle wheel, there results an unavoidable loss of a large portion of the power of the engine. To construct a wheel by which this loss will be reduced as much as possible, is an important point to be aimed at, and many inventions have appeared with the view of effecting this object. We therefore propose, in the first place, to enter into a comparison of such of these wheels as have come into general use, and to endeavour to illustrate the nature of their action.

ON PADDLE WHEELS.

The construction of the ordinary paddle wheel is so simple as scarcely to need description: it consists of a circular framework of iron, supporting paddles at equal distances round the rim, and radiating from the centre: these wheels are attached to a strong shaft passing through the vessel, to which the motion of the engine is conveyed by cranks placed

at right angles to each other : the revolution of the floats or paddles in the water creates a resistance upon them, and the corresponding reaction on the main shafts produces the force by which the vessel is propelled.

It is evident, that in this construction of wheel two kinds of lost power must exist : first, by the action of the paddle being oblique, or at an angle with the horizontal direction of the vessel in every position except the vertical one, by which of course only a portion of the power exerted on the paddle becomes effective ; and secondly, by the receding of the wheel in the water necessary to create a resistance equal to the force applied by the engine. This may perhaps be best illustrated by the case of a locomotive engine : if the friction between the wheel and the rail be such that the former does not slip, the motion of the carriage will be the same as that of the circumference of the wheel ; the whole power of the engine is employed in propelling the carriage, and consequently there is no lost power : but if the friction be not sufficient, the wheel will slip back some quantity ; the same steam will be consumed in the revolution of the wheel, but the carriage will not be advanced as before, and there will be a loss of power proportional to the skidding or receding of the wheel : so also in a steam vessel all that the centre of pressure actually goes back in the water, or all that its circumferential velocity exceeds that of the vessel, is comparatively lost power ; the expense of the steam being proportional to the former, and the effect to the latter.

This source of lost power must of course exist in all paddle wheels, whatever their construction, from the resistance being created in a fluid ; but that kind first described being owing entirely to the radiation of the paddles, a great number of inventions have been proposed to remedy the evil, by causing them to keep a vertical position by the aid of machinery during their progress through the water. These wheels, although they possess much superiority over the ordinary construction in a sea, or where the wheel is deeply immersed, by obviating the loss of power from the obliquity of action and back water, are subject to evils of another description ; and it is a question of doubt, whether the common radiating wheel does not admit of a construction, which, in average of weather and circumstances attending a sea voyage, might lead to as little loss of power as the vertical wheel, and at the same time possess the advantage of less liability to derangement.

The first vertically acting wheel which has been employed to any extent in this country is that commonly known as Morgan's Wheel. The original patent for this construction was granted to Elijah Galloway, and sold by him to Mr. William Morgan ; but has since that time undergone considerable improvements in its structure and arrangement, and is now extensively adopted by Government in the Admiralty steamers.

Fig. 1. and 2. are a plan and elevation of the improved wheel : *a a a a* are paddles, which turn upon spindles having a bearing on the framework, *c c c*, and of the wheel, which is of a polygonal figure, having as many sides as it is required to have paddles. The inside frame or polygon is alone attached to the shaft of the engine, which does not continue beyond the side of the vessel ; and the outer one has an independent bearing on a centre attached to the paddle box, so that it derives its motion entirely from the arms or angles of the polygon ; the space between the two frames of the wheels being left quite free. *A* is a crank fixed to the paddle box, upon which the outer polygon revolves ; it projects in an inclined direction in the open space between the sides of the wheel, but to a point considerably excentric with it. Each paddle has a crank attached to it at an angle of about 70° , and arms *a a*, &c. connect the extremity

of the cranks with a moveable boss, which revolves upon the fixed centre A. One of these arms is fixed to the boss, and is termed the dividing arm.

It will thus be seen, that in consequence of the point A being situated out of the centre, the paddles will assume different positions during the revolution of the wheel, which positions can be so arranged as to differ very little from the vertical wheel, while passing the lower part of the revolution, or that part where the action of the paddle takes place.

In the year 1837, Messrs. Seawards fitted a vertically acting wheel to the 'Levant' steam boat, in which the positions of the paddles are similar to the above, but are brought about by a different arrangement of machinery. This wheel formed the subject of a charge of piracy, on the grounds of being a colourable evasion of the patent of Elijah Galloway. The Vice-Chancellor having given judgment against granting an injunction, the parties tried an action at law, in which they were also unsuccessful; and Messrs. Seawards have now the privilege of making these wheels.

Fig. 3. and 4. is a representation of Seawards' wheels.—A A is the shaft of the engine, to which the two frames or polygons B B, C C are attached. D D D D are the paddles, which revolve in bearing in the two frames. E E is an enlarged axle fixed to the side of the vessel excentrically with the shaft, and answers the same purpose in giving the requisite positions to the paddles as the cranked axis A in Morgan's wheel. F F is a rim of iron, which is caused to revolve on the enlarged axle by an arm G attached to the inner polygon of the wheel: from this rim proceed arms or rods H H H, to the bent cranks I I I, attached to the paddle boards.

It will here be seen, that the paddles will in like manner, by the motion of the wheel, take up positions similar to those of Morgan's, entering and leaving the water nearly in a vertical position. The main difference in the construction of the two is the excentric, which by being fixed at the side of the vessel, instead of in the centre of the wheel, is less adapted to giving motion to the paddles, from acting at one end of them, but has the advantage of allowing the shafts to be continued through the wheel, which certainly adds to its strength.

EXPERIMENTS ON PADDLE WHEELS.

For the purpose of instituting a comparison and explaining the action of these wheels, I have given the following set of experiments on her Majesty's vessels, fitted out at Woolwich, some of which are provided with Morgan's wheels, and others with the radiating wheel. Each vessel is submitted to accurate experiment, sometimes when light, and sometimes laden. The exact amounts of their cargoes are known, their registered and actual tonnage, area of paddle, and every other particular which can serve as a guide to such an inquiry.

EXPERIMENTS ON PADDLE WHEELS.

TABLE I.—Experiments on the Speed of the Admiralty Steamers fitted out at Woolwich.

Name of the vessel.	Tonnage.	Horse power.	Quantity of coals in chaldrons.	Quantity of stores.	Diameter of wheel.	Length of paddle board.	Depth of paddle board.	Dip of paddle board.	Strokes per minute.	Speed in English miles.	Diameter of piston.	Length of double strokes.	Number of strokes per minute, full power.	Remarks.
Alban	294	100	14	None	Ft. In. 13 0	Ft. In. 9 0	Ft. In. 1 6	Not known	27	8.84	Inches. 40	7	30	Government Vessel.
Messenger	730	200	60	Channel service	19 4	10 0	2 0	—	20½	9.75	53½	10	22	Do.
Messenger	730	200	130	Do.	19 4	10 0	2 0	—	18	8.00	53½	10	22	Do.
Pluto	365	100	14	None	14 4	9 0	1 10	1 9	26½	10.15	40	7	30	Do.
Hermes	730	140	130	Channel service	17 6	9 0	2 0	Not known	18	6.3	44	9	24	Do.
Meteor	296	100	8	Do.	13 0	9 0	1 6	1 6	32	9.0	40	7	30	Do.
Firebrand	494	140	10	None	17 0	9 0	2 0	2 4	24	10.15	44	9	24	Do.
Firebrand, } Morgan's wheel }	494	120	12	Channel service	14 6 (Polygon)	—	—	2 11½	28	10.55	42	8	27½	Do.
Flamer	494	120	15	None	13 0	—	—	3 11½	27	10.9	42	8	27½	Do.
Flamer, } Morgan's wheel }	494	120	112	Channel service	13 0 (Polygon)	—	—	5 6	24	9.57	42	8	—	Do.
Carrou	294	100	8	None	13 0	9 0	1 6	1 6	28	9.15	40	7	30	Do.
Dee	710	200	30	Do.	19 4	10 0	2 0	1 6	23	10.62	53½	10	22	Do.
Rhadamanthus	820	220	46	Do.	20 4	9 0	2 6	Not known	20	10.39	55½	10	22	Do.
Salamander	820	220	210	Channel service	20 4	9 0	2 6	Not known	15	8.15	55½	10	22	Do.
Firefly	550	140	152	Do.	17 6	9 0	2 0	3 4	20	8.3	44	9	24	Do.
Magnet	360	140	6	None	16 0	10 0	1 6	1 8	29½	11.75	44	9	24	Private.
Phoenix	820	220	12	Do.	20 4	9 0	2 6	2 6	21	11.7	55½	10	22	Government Vessel.
Medea, } Morgan's wheel }	835	220	15	Do.	21 0 (Polygon)	in the basin	—	Upper edge 4 inches above water line.	12½	one wheel	55½	10	22	Do.
Columbia, } Morgan's wheel }	360	100	80	Channel service	14 0 (Polygon)	—	—	4 10	24	8.5	40	7	30	Do.
Firebrand, } Morgan's wheel }	494	120	40	Do.	14 6 (Polygon)	—	—	3 7	27	10.1	42	8	27½	Do.
Medea, } Morgan's wheel }	835	220	2	None	21 0 (Polygon)	—	—	3 11	22½	11.33	55½	10	22	Do.
Monarch	872	200	—	—	21 0	10 0	2 0	3 6	20½	10.72	—	10	22	Private.
Monarch	872	200	—	—	21 0	10 0	2 0	3 6	20½	10.50	—	10	22	Additional weight
Monarch	872	200	—	—	21 0	10 0	2 0	3 6	21	11.02	—	10	22	on safety valve.

Since the above experiments, a comparison of the speed of the Medea, Dee, and Salamander, was made in the River Medway, at which the Lords of the Admiralty attended: each vessel was laden with nearly her full cargo of coals, stores, &c. amounting in the Medea and Salamander to 200 tons, and in the Dee to a quantity proportional to the tonnage. The exact speed of each was not ascertained, for want of a measured mile on the banks of the river; but the result was entirely in favour of the Medea, whose speed amounted to nearly ¾ths of a mile per hour beyond that of the other two vessels,—their speed being as nearly as possible the same.

With the aid of these experiments, and the data given with them, I have been enabled to calculate in each case the relative velocity of the wheel and vessel, the actual pressure upon the vertical paddle, the area of paddle per horse power, and other facts; by the comparison of which with the velocity, tonnage, &c., a just conception may be formed, not only of the action of each paddle wheel, and the manner in which the power of the engine is expended, but also the amount of surface, proportion of the paddles, dip of immersion, &c., which are required to enable an engine to produce the greatest useful effect.

The manner of obtaining these calculated results will be at once evident from the heads of the columns, except the last five, which relate to the velocity of the vessel as compared to the wheel, and the amount of pressure exerted by the engine on the vertical paddle.

As the resistance opposed to the paddle is distributed over a considerable depth of paddle board, it is necessary, in comparing the relative velocity of the wheel and vessel, to find that point in which, if all the resistances were concentrated, they would have equal effect in propelling the vessel: this point is termed *the centre of pressure*, and its exact position becomes a question of very intricate calculation, as it changes according to the depth of immersion, the diameter of the wheel, and other circumstances, which vary in different boats. It was necessary therefore to assume a point which would meet the ordinary cases; and this has been decided upon from the following considerations.

ON THE CENTRE OF PRESSURE OF A PADDLE.

It is very evident, that in every case the resistance upon different parts of the paddle is as the square of the distance from the centre of motion, because the resistance of a fluid varies as the square of the velocity: this ratio is however always increased more or less in consequence of the extremity acting for a greater length of time than the inner part.

In the case of a wheel in motion in a vessel at rest, if the length of the arc described by the outer extremity of the paddle exceed that described by the inner edge, in the ratio of the larger radius to the smaller, the resistance upon any part of the paddle would vary exactly as the square of the radius; but this can only occur when the wheel is either totally immersed, or up to the centre of motion: in every other circumstance it is evident that the arc described by the extremity will exceed that of the inner edge in a greater ratio, depending upon the degree of immersion, radius of wheel, &c.; consequently, the resistance upon any part of the paddle will increase in a greater ratio than the square of the distance from the centre of motion. It is moreover evident, that the position of the centre of pressure will not only vary with every change of immersion, but will continue to ascend from the moment the paddle enters the water until it is immersed below the surface, when it becomes constant, and continues so until the upper part of the paddle again leaves the water.

As these experiments are made entirely with vessels in motion, it is not necessary to enter into a calculation of this precise point; the above case being alluded to merely with a view of facilitating the investigation of the more complicated question of the centre of pressure of the paddle when the vessel is in motion.

Here it will be seen, that as the revolution of the paddle resembles a circle rolling on a plane, every part of it will describe a cycloid. That point whose rotary velocity is equal to that of the vessel will move through a simple cycloid; points within that circle, in prolate cycloids;

and points without, in curtate or contracted cycloids. In Fig. 5. is represented the position of the float of a paddle wheel in different parts of its revolution. The circumference, whose velocity is equal to that of the vessel, is here equal to two-thirds of that which passes through the extremity of the paddle, which is about a medium case in practice.

It will be readily seen, that the effect of the vessel being in motion will be to roll the circle $abcd$ on the line ef , so that the inner edge of every paddle will move through the cycloid ghi , whilst the extremity moves through the cycloid $klmno$, as shown by the dotted lines in the figure.

As the centre of pressure varies at every angle of the paddle, in order to come at the true position it becomes necessary to find the relative velocity of the two extremes of the floats, or the distance moved in the two cycloids, at every instant of time: this would, however, lead to a calculation of greater labour than the nature of the present investigation demands; and as the circumstances upon which such calculations would be founded vary in every experiment, according to the diameter of the wheel, depth of immersion, &c., two points have been assumed, one of which is intended to meet the ordinary cases of slightly immersed, and the other that of deeply immersed paddles. It appears, again, referring to the figure, that whilst the extremity of the paddle is moving through the part of the curtate cycloid below the level of the water, a point P in the radius of the wheel, which is situated in the circumference of the rolling circle, has scarcely moved in the simple cycloid apr . The difference of the curves during the lower part of the motion amounts nearly to what is due to an arc described with a radius equal to the difference of the extreme radius of the wheel, and that of the circle of equal velocity with the ship.

It therefore appears, that the resistance on any part of the float varies nearly as the square of its distance from the rolling circle; and having at the same time taken into consideration the greater length of time of the action of the extremity than of the inner edge of the paddle, I find, from the examination of several experiments, that in the case of slight immersion the assumption of the resistance on any point varying as the cube of the distance from the rolling circle, and in deep immersions as the 2.5 power, will approximate very nearly to the truth.

Having thus assumed the law of resistance with respect to the radius, we readily find the position of the centre of pressure by the following equation.

Let r be the difference of the radius of the rolling circle and that of the wheel, n the power of the resistance in relation to the radius, b the depth of the paddle, x any variable distance from its upper edge, and y the distance of the mean centre of pressure, also from the upper edge; then the integral of $(r+x)^n dx$ will be the sum of all the resistances, and $(r+y)^n b$ the expression to which it is to be equal.

We have therefore, when $x = b$,

$$\frac{1}{n+1} (r+b)^{n+1} = (r+y)^n b;$$

which, when $n = 3$, gives

$$y = \left(\frac{(r+b)^4}{4b} \right)^{\frac{1}{3}} - r;$$

and, when $n = 2.5$,

$$y = \left(\frac{2(r+b)^{\frac{7}{2}}}{7b} \right)^{\frac{2}{5}} - r.$$

From these equations the diameters to the centre of pressure of the common wheel (given in column 16 of the following table) have been calculated.

In the new wheel the centre of pressure will be nearly in the centre of gravity, when the paddle is totally immersed, the motion of the paddle being nearly vertical; but in consequence of the lower part coming sooner into and continuing longer in action, it must be taken some distance below the centre of gravity.

It is not easy to determine this by calculation; but by a comparison of all circumstances bearing upon this question, an allowance of one-eighth of the paddle has been made on this account.

It may be proper to observe, that in these wheels there is no relation between the diameter of the polygon and the diameter to the centre of pressure, the paddles being differently hung and differently shaped in the several vessels,—particulars it has not been thought necessary to introduce into the table.

The diameter to the centre of pressure, or effective diameter of the wheel, being known, we at once deduce the excess of the velocity of the wheel over that of the vessel, or that at which it recedes in the water to produce the resistance necessary for propelling the vessel. The rule for ascertaining the amount of this resistance or pressure on the vertical paddle, is to multiply the square of this velocity by the area of the paddle board and by $62\frac{1}{2}$ (the weight of a cubic foot of water in lbs.), and divide by $64\frac{1}{2}$; the pressure upon a surface moving in a fluid being equal to the weight of a column of water whose base is the area of the surface, and altitude that through which a body must fall to acquire the velocity. This number, multiplied by the velocity of the wheel, will express the power expended on the vertical paddles; and this divided by the whole power of the engine, will give the proportion consumed on the vertical paddle given in column 18.

In estimating the parts of the power of the engine exerted in any case, the number of strokes made in a minute is compared with the actual number of strokes which ought to be made for the engine to perform its whole duty.

TABLE II. — Exhibiting the Ratio of the Velocity of the Wheel and Vessel, the whole Pressure upon the Vertical Paddle, and other results calculated from the preceding experiments.

Name of the vessel.	Tonnage.	Horse power.	Quantity of coals in chaldrons.	Diameter of the wheel.	Length of the paddle board.	Depth of the paddle board.	Number of paddles.	Dip of the extremity of the paddles.	Strokes of the engine per minute.	Number of strokes per minute for full power.	Speed of the vessel in English miles.	Area of the paddle per horse power.	Tons per horse power.	Velocity of the vessel, that of the wheel being 1.	Diameter of rolling circle.	Diameter to centre of pressure.	Pressure upon the vertical paddle in lbs.	Proportion of the power of the engine expended on the vertical paddles.
1. Messenger . . .	730	200	60	19 4	10 0	2 0	16	—	20½	22	9.75	.200	3.65	.754	13.31	17.65	838	.154
2. Messenger . . .	730	200	130	19 4	10 0	2 0	16	—	18	22	8.00	.200	3.65	.706	12.45	17.63	926	.171
3. Dec	710	200	30	19 4	10 0	2 0	16	1 6	23	22	10.61	.200	3.55	.717	12.91	18.00	1089	.195
4. Rhadamanthus . . .	820	220	46	20 4	9 0	2 6	16	—	20	22	10.39	.204	3.73	.791	14.54	18.36	695	.121
5. Salamander	820	220	210	20 4	9 0	2 6	16	5 6	15	22	8.15	.204	3.73	.828	15.21	18.36	257	.082
6. Phoenix	820	220	12	20 4	9 0	2 6	16	2 6	21	22	11.7	.204	3.73	.829	15.60	18.36	464	.151
7. Monarch	872	200	21	0	10 0	2 0	18	3 6	20½	22	10.72	.200	4.36	.757	14.62	19.31	976	.197
8. Monarch	872	200	21	0	10 0	2 0	18	3 6	20½	22	10.50	.200	4.36	.756	14.60	19.31	952	.193
9. Monarch	872	200	21	0	10 0	2 0	18	3 6	21	22	11.02	.200	4.36	.760	14.69	19.31	998	.200
10. Alban	294	100	14	13 0	9 0	1 6	14	1 9	27	30	8.81	.270	2.94	.777	9.15	11.77	354	.119
11. Pluto	365	100	14	14 4	9 0	1 10	14	1 9	26½	30	10.15	.330	3.65	.823	10.71	13.01	308	.114
12. Hermes	730	140	130	17 6	9 0	2 0	—	—	18	24	6.3	.257	5.21	.645	9.80	15.86	1138	.294
13. Meteor	296	100	8	13 0	9 0	1 6	—	—	32	30	9.0	.270	2.96	.671	7.87	11.70	1083	.362
14. Firebrand	494	140	10	17 0	9 0	2 0	14	2 4	24	24	10.15	.257	3.53	.733	11.88	15.38	691	.173
15. Firefly	550	140	152	17 6	9 0	2 0	14	3 4	20	24	8.3	.257	3.93	.733	11.60	15.81	673	.174
16. Magnet	360	140	6	16 0	10 0	1 6	—	—	29½	24	11.75	.214	2.57	.756	11.16	14.72	882	.213
17. Carron	294	100	8	13 0	9 0	1 6	—	—	1 8	24	9.15	.270	2.94	.777	9.15	11.77	385	.129
18. Medea	835	220	20	21 0*	4 10†	3 11	11	3 11	22½	30	9.15	.172	3.79	.627	13.79	22.03	3024	.666
19. Flamer	494	120	15	13 0	5 9	2 9	9	3 11½	27	27½	10.9	.266	4.11	.683	11.30	16.55	1715	.625
20. Flamer	494	120	112	13 0	5 9	2 9	9	5 6	24	27½	9.57	.266	4.11	.674	11.16	16.55	1441	.526
21. Firebrand	494	120	12	14 6	4 6½	2 10	9	2 11½	28	27½	10.55	.212	4.11	.667	10.50	15.73	1508	.526
22. Firebrand	494	120	40	14 6	4 6½	2 10	9	3 7	27	27½	10.10	.212	4.11	.666	10.48	15.73	1404	.476
23. Columbia	360	100	80	14 0	3 11	3 0	9	4 10	24	30	8.5	.237	3.60	.654	9.91	15.15	1008	.454
1.	2.	3.	4.	5.	6.	7.	8.	9.	10.	11.	12.	13.	14.	15.	16.	17.	18.	

* Polygon. † Mean length.

DEDUCTIONS FROM THE TABULAR NUMBERS.

The amount of resistance on the vertical paddle, and proportion of the power of the engine expended upon them, will be found to differ considerably in the different cases given in the table, and might, if unexplained, throw an appearance of doubt upon the accuracy of the experiments. These discrepancies are evidently attributable to the result depending upon the square of the difference of two velocities; so that the slightest inaccuracy in either of the observations is greatly magnified. There is no doubt, however, with so many experiments made at different times and under different circumstances, that the means obtained in the table are sufficiently near the truth for all practical purposes.

In examining column 18, a striking difference is seen in the proportion of the power of the engine expended on the vertical paddle in Morgan's wheel and in the common wheels, the mean of the former being $\cdot 546$, and of the latter $\cdot 151$ and $\cdot 197$. The difference arises from the nature of the action: *in the new wheel the vertical position is the most effective in propelling the vessel, and in the common wheels the least so*;—a fact which, although little known among the projectors of paddle wheels, and even among engineers, who are constantly witnessing their daily performance, it is very essential should be understood before any calculation or judgment can be formed of the construction and proportion of wheels best adapted to steam vessels, under the different circumstances and various kinds of duties in which they are employed: we beg therefore to call the attention of the reader particularly to this point.

The difference of action which caused this unexpected result will be understood by examining Fig. 5., which exhibits the positions of each paddle, at equal intervals of time, in a vessel in motion: it will there be seen, that the progress made through the water by the radiating paddle, while passing the vertical position, is considerably less than in the preceding equal interval of time. After first entering the water, and as the resistance opposed varies as the square of the velocity or space passed through, it is evident that the resistance in passing from A to B will greatly exceed that of passing from B to C; and it may be readily demonstrated, that in ordinary cases it exceeds it so much, that the portion of it which when resolved is in a horizontal direction, or effective in propelling the vessel, is greater than the whole action at the vertical position, although this latter is attended with no loss from oblique action. This effect will be illustrated very clearly by assuming the extreme case of the paddle wheel being immersed to the axle: here the floats will enter the water at the whole velocity of the wheel; but this velocity will diminish until they arrive at the vertical position, when it will be only the difference of the velocity of the wheel and vessel, which is generally not more than one quarter of the whole.

On the contrary, if we examine the position of the vertically acting paddles of the new wheel in the same equal intervals of time, we find that the space B C, in passing the vertical position or bottom of the arc, greatly exceeds that of the preceding interval of time A B: in fact, the motion of the vertical paddle in entering the water is scarcely perceptible, but it gradually increases until it has passed the bottom of the arc; and hence arises one of the greatest advantages of this construction of wheel, by totally avoiding the shock or blow on the paddle entering the water, which is experienced in the common construction, and which is not only injurious to the engine and unpleasant to the passengers, but productive of a serious loss of power, particularly at sea, or when the vessel is deeply immersed.

The actual amount of effective pressure at any angle may be ascertained in the following manner. Let A B, Plate xxv. Fig. 7., be any position of the paddle board of a vessel in motion; V being the velocity of the wheel, and v that of the vessel, and ϕ the angle of inclination of the paddle board with a vertical line. Let C D represent the velocity V at right angles to the paddle, and E C that of the vessel in a horizontal direction. Then it is evident, that C F, which is the resultant of these velocities, will represent the velocity and direction of motion of the paddle with respect to still water. Resolve F C into the two velocities F G, C G, one at right angles to, and the other in the direction of, the paddle; of which the latter is lost, while the former will represent the velocity with which the paddle meets the water in a direction at right angles to its face: then C G or H F = E F — E H = V — $v \cos. \phi$; consequently, $(V - v \cos. \phi)^2$ will represent the whole resistance which the paddle opposes to the engine at any angle ϕ .

In order to get an expression for the resistance in a horizontal direction, or that part which is effective in propelling the vessel, C G must be resolved into the two resistances C T, G T, one in a horizontal, and the other in a vertical direction. G T or the effective propelling force will therefore be $(V - v \cos. \phi)^2 \cos. \phi$: and it will be found in all cases which occur in practice, that the velocities V and v are such that this expression is greater than $(V - v)^2$, or that of the resistance on the vertical paddle.

In the case of the new or vertical wheel at any angle ϕ of the paddle rod, the resistance will be $(V \cos. \phi - v)^2$; so that in this wheel, when the angle is such that $V \cos. \phi$ is equal to v , no resistance is opposed to the engine; and when it is less, (a case I have witnessed in practice,) it opposes a resistance in a contrary direction, or is a direct impediment to the motion of the boat when first entering the water. It is, however, sufficiently obvious, that the resistance opposed to the engine in this case is less than when in its lowest position, while in the old wheel it is every where greater: it will also be readily seen, with such velocities V and v , as usually occur in practice, that not only is the resistance to the engine greater in the oblique paddle, but that more effect is produced by them in propelling the vessel, unless the immersion of the wheel is very great, as is sometimes the case in stormy weather, when of course the angle may be such that the resistance is almost entirely in a vertical direction. The angle when the effective resistance is the greatest may be found as follows:

$(V - v \cos. \phi)^2 \cos. \phi$ is the maximum when

$$V^2 d \cos. \phi - 4 V v \cos. \phi d \cos. \phi + 3 v^2 \cos. \phi^2 d \cos. \phi = 0;$$

$$\text{whence} \quad \cos. \phi^2 - \frac{4 V \cos. \phi}{3 v} = - \frac{V^2}{3 v^2};$$

$$\text{and} \quad \cos. \phi = \frac{V}{3 v};$$

hence, with the velocities such as form the limit of practice, viz.

V = 5,	v = 4,	ϕ , or angle of greatest effect, is	. . .	65°	33'
4	3	63	37
3	2	60	0

It should be stated, however, that although an increased propelling power is obtained at the above angles, it is not to be understood that so great an angle is practically advan-

tageous: the amount of vertical resistance or lost power is here increased to a considerable amount, and the shock by the paddles striking the water at so great an angle is highly injurious.

EXPLANATION OF THE MANNER IN WHICH THE POWER OF THE ENGINE IS
EXPENDED IN THE TWO WHEELS.

As the preceding formulæ enable us to calculate the degree of resistance on the paddles at any angle of inclination, we may readily find the whole power exerted by the engine, either by obtaining the sum of all the resistances of one paddle in passing through the water, and multiplying by the number; or by finding the mean resistance of one paddle while in action, and multiplying by the number acting at the same time, and the circumference passed through by the centre of pressure. This latter mode is preferable, being arrived at by a less complicated calculation, and as it represents more truly the real action of the resisting medium, which, from there being several paddles in the water at the same time, is in fact equivalent to that of an uniform weight acting at the distance and velocity of the centre of pressure.

Not having the dip of immersion in all the experiments in the table, a separate calculation is not given for each, but a dip of 3 ft. 6 in., equivalent to an entrance angle for the centre of pressure of 44° , is assumed as the average in the first class, which, from the experiments being generally made after the engines were fitted, and before the vessel had taken in her cargo of coals, must be very nearly the truth.

The general expression for the tangential resistance with the COMMON WHEEL is $(V - v \cos. \phi)^2$; the mean resistance will therefore be the integral of $(V - v \cos. \phi)^2 d\phi$ divided by ϕ ; or it may be obtained sufficiently near, arithmetically, by calculating the resistance at equal intervals or angles, and dividing their sum by the number, for the mean.

Assuming $V = 4$ and $v = 3$, which is very nearly the mean ratio of the velocity of the common wheel and vessel, we find the mean resistance of the paddle passing through the whole arc to be to the resistance of the vertical one as 1.75 to 1. Now, as the whole circumference contains sixteen paddles, and the arc passed through is 88° , three paddles and a half may be considered to be acting: this will make the whole resistance to the engine to be 6.12 times that opposed by the vertical paddle, or the proportion of the power of the engine exerted on the vertical paddle to be = .163, while the mean obtained from the experiments is .151.

In the second class, the paddle wheels, though smaller, being proportionally immersed, will enter the water at the same angle of inclination, so that the same mean resistance will result from it, viz. 1.75. The number of paddles, however, being less in the small wheels, there are not more than three of them effective; which gives the proportion of the power of the engine exerted on the lower or vertical paddle .190, the mean obtained from the experiments being .193. We are thus able to account in the radiating wheel for a power exerted on the paddles equal to the whole nominal power of the engine, which not only speaks strongly as to the accuracy of the principles adopted in the preceding calculations, but also that the supposed loss from back water cannot be much.

It now remains to account for the power of the engine in the NEW WHEEL, where we have found the horizontal resistance to the paddle to be $(V \cos. \phi - v)^2$. The power of the engine

necessary to overcome this resistance will be $(V \cos. \phi - v)^2 \cos. \phi$, as may be shown as follows :

Let GB , Plate xxv. Fig. 8., represent the horizontal resistance or force on the paddle ; it is to be ascertained what force in the direction FB will overcome it. Resolve GB into the two forces HG , HB , one at right angles to, and one in the direction of, the radius rod. The effect to turn the line AB about the point A will be the force HB alone ; the force GH , which is in the direction of the line AB , having no power to turn it, its whole action being on the axle of the wheel. It therefore follows, that the force FB at right angles to the radius rod required to retain the point B in equilibrium, or to exert a force in a horizontal direction equal to GB , is $GB \cos. \phi$ (because the angle $GBH = BAI$) and consequently equal to $(V \cos. \phi - v)^2 \cos. \phi$, as already stated.

Having assumed in this case the same angle of 44° when the paddle begins to act, the mean of the horizontal resistances on the paddle, viz. $(V \cos. \phi - v)^2 = GB$ will be $\cdot 547$, and the mean of the forces necessary to create these resistances or $(V \cos. \phi - v)^2 \cos. \phi$ will be $\cdot 522$ (the force on the lower paddle being 1) ; which, multiplied by $2\frac{3}{4}$, the number of paddles acting, makes the whole power of the engine employed $1\cdot 436$ times that exerted on the vertical paddle ; or the proportion of the power of the engine employed on the lower paddle $\cdot 696$; the mean given by the experiments being $\cdot 546$: there is therefore a deficiency of $\cdot 150$ of the power of the engine to account for, which I suppose partly due to the greater friction of this wheel, and partly to the paddles not being quite perpendicular in every position in the water, as has been assumed in the preceding calculations.

COMPARISON OF THE LOST POWER IN THE VERTICAL AND IN THE COMMON WHEEL.

In the action of the common wheel there arises, as we have before described, two kinds of lost power,—one from the retrograding of the wheel, and the other from the oblique action of the paddles ; and we are now enabled to estimate the amount of each of them with considerable accuracy, and thus draw a comparison of the efficiency of the two constructions of wheel in different states of immersion.

The expression $(V - v \cos. \phi)^2$ represents the whole mean pressure exerted on the paddle ; this, multiplied by the velocity or space passed through by the centre of pressure in a given time, will express the whole power of the engine. In the same way, by the expression $(V - v \cos. \phi)^2 \cos. \phi$, the resolved horizontal resistance, we may obtain the mean effective pressure acting on the vessel ; which, multiplied by its velocity, will express in the same manner the proportion of the whole power which is useful in propelling the vessel. These numbers are computed and arranged within all practical limits in the following table, the original engine power in each case being assumed to be 1.

In the vertical paddle wheel, as there results no loss of power from oblique action, the ratio of the useful to the whole effect will be that of the velocities of the wheel and vessel :¹ this ratio, as will be seen from the experiments, is 3 to 2, or the proportion of effective power is $\cdot 666$ of the whole power.

¹ See the note at the end of this paper.

TABLE III.

Angle at which the centre of pressure of the paddle entered the water.	Proportion immersed of the radius of the wheel.	Effective power, that of the engine being 1.		Lost power, that of the engine being 1.		Mean effective resistance, the resistance of the vertical paddle being 1.		Mean resistance opposed to the engine, that of the vertical paddle being 1.		Remarks.
		Common wheel.	Morgan's wheel.	Common wheel.	Morgan's wheel.	Common wheel.	Morgan's wheel.	Common wheel.	Morgan's wheel.	
35°	·252	·660	·666	·310	·333	1·298	·702	1·457	·674	} Vessel very light, the immersion to the top of the paddle.
44	·350	·645	·666	·355	·333	1·510	·547	1·750	·522	
50	·430	·620	·666	·380	·333	1·628	·504	1·971	·482	} Very deep immersion.
60	·550	·553	·666	·447	·333	1·850	·425	2·510	·404	

From an examination of the above table, we arrive at several important conclusions. In the first place it is seen that when the wheel is slightly immersed, little or no advantage is gained from the vertically acting paddle, the loss from the additional velocity required to obtain the necessary resistance or receding of the wheel being fully equal to that of oblique action in the common wheel. The only remedy for such an evil is the increase of the number and dimensions of the paddles, both of which are difficult to accomplish in Morgan's wheel: we may therefore very fairly conclude, that in the navigation of rivers or smooth water, where generally little variation is required in the degree of immersion of the vessel, the common wheel, if properly proportioned, is preferable to the vertically acting wheel, in consequence of its admitting of a larger surface of paddle board.

In the case of deep immersion the effect is very different: here the loss from oblique action in the common wheel becomes very serious, so that the total loss of the engine amounts to ·447 of that expended, while the loss from Morgan's wheel remains nearly the same. It therefore appears, that the latter has great advantages over the common wheel for sea purposes or long voyages, where the immersion of the vessel is constantly diminishing by the exhaustion of the coals and other stores required at the commencement of the voyage. The loss from the oblique action of the paddles must also be very great in rough weather, from the degree of immersion to which the wheel is subject; in addition to which, the paddles entering the water with so great a velocity, receive a reaction or blow which has the effect of nearly bringing up the engine, and there in consequence results a loss, in addition to that of oblique action, from the power required to put the mass of machinery again in motion. The advantages which the common wheel possesses in still water, of presenting a larger surface of paddle board, does not now exist, as a large surface has a tendency to bring up the engine, and throw all the work on the oblique paddle, which is in every case disadvantageous. In fact, the desideratum that has to be aimed at in every wheel, is to throw as much work as possible on the vertical paddles, where there is no loss from oblique action, which can be accomplished in the ordinary construction when the immersion does not exceed one-fourth of the radius, and a large surface of paddle board taken advantage of; but at sea it can only be effected by reducing the number

and surface of board, which is at a great sacrifice of speed when the vessel is in still water,—a condition to which the same vessel is of course liable ; and hence arises the disadvantages and loss of power of the ordinary wheel for sea purposes.

CYCLOIDAL WHEELS.

The vertical wheel, although possessing in its action the advantages we have pointed out, is however attended with several serious practical objections. To effect the vertical position of the paddles, considerable complication is necessary in the construction, and a great number of moving parts are required, which are not only attended in the commencement with a great outlay, but require continual repairs, and are liable to derangement.

These objections have led to attempts to improve the action of the common wheel by a different arrangement of the paddle boards, which have been so far successful in the cycloidal wheel, that its use is very likely to become general and supersede that of Morgan, from its superior strength and simplicity, while it does away with most of the evils to which the common wheel is subject. A patent for a cycloidal wheel was first taken out by Mr. Galloway, in August, 1835 ; but as it appears that a similar wheel was employed by Mr. Field, in a vessel on the Thames, in the year 1833, and a model of a cycloidal wheel exhibited to the Lords of the Admiralty in the same year, (see 'London Journal,' December, 1835,) we conceive that the credit of the invention rests with the latter gentleman.

The principle of this contrivance consists in dividing the paddle into a number of parts, which are placed upon the wheel in the curve of a cycloid, so that they enter the water at the same spot, and follow one another so rapidly as to cause little resistance to the engine on entering the water ; and afterwards separate, so as to afford full scope for their action in passing the centre, and in coming out allow the water to escape readily from them. A drawing of the cycloidal wheel, fitted by Messrs. Maudslay and Field to the Great Western steam ship, is given in Plate xxvi. Fig. 9. The dotted circle is that which I have termed in the preceding investigation the rolling circle, the velocity of its circumference being equal to that of the vessel : the action of the paddles will be truly represented by the motion of this circle on the horizontal line. The paddles are placed in the direction of the curve A B, which is a portion of a simple cycloid described by the point A in the circumference, or by a fixed point at B during the rolling of the circle along the line, and must therefore enter the water at the same spot. When immersed, they no longer follow a common direction of motion, but gradually separate, so that in passing the vertical position they do not in any way interfere with each other's action, and resemble so many small radiating paddles. After passing the centre, they still continue to separate in their direction of motion, and consequently leave the water very freely, and without the back water to which the common wheel is subject. To enable the reader to understand the beautiful action of this wheel, we have drawn the positions of the paddles in a vessel in motion, at equal intervals of time, (Fig. 10.) as has already been shown in the common wheel, from which will be seen its great superiority both in entering and leaving the water : it enables an engine in any weather to make a greater number of strokes, by throwing more work on the bottom paddles ; and reduces considerably the shock on entering the water, which is not only productive of a loss of power, but is very unpleasant to the passengers.

In river navigation, where there does not exist the necessity of deeply immersing the wheels, and the common paddles can be made much broader without inconvenience, the advantages of this construction will not be so much felt: at the same time, it may always be employed beneficially, and will occasion less lost power than the common wheel.

ADDITIONAL EXPERIMENTS ON PADDLE WHEELS.

The results of the preceding investigations have been fully borne out by a very interesting and complete set of experiments made by Mr. Field, (most of which I attended,) with the view of comparing the effect of the cycloidal and Morgan's wheel with the common one, with different proportions, number, and arrangements of paddles.

The apparatus, by which the experiments were made, consisted of a vertical shaft, which was hung so as to revolve freely in the centre of a circular reservoir. The wheel was suspended in a horizontal arm attached to this shaft, and was put in motion by a descending weight, which caused the wheel to revolve and carry the horizontal arm, with a small plate attached to it to represent the resistance or vessel, round the reservoir. The weight was wound up to the same height at each experiment, to cause the wheel to make an equal number of revolutions; and the time employed by the weight in descending, and the number of circuits made, were accurately observed. The different states of immersion of the wheel were produced by altering the level of the water in the reservoir. The column describing the effect is calculated by multiplying the square of the velocity by the number of circuits and the area of resistance.

EXPERIMENTS ON PADDLE WHEELS.

TABLE IV.—Experiments on Paddle Wheels made at Messrs. MAUDSLAY and FIELD'S Manufactory, April, 1837.

Proportion of the diameter of the wheel immersed.	Area of Re-sistance.	1		2		3		4		5		6		7		8		9		1	
		Velocity.	Effect.	Velocity.	Effect.	Velocity.	Effect.	Velocity.	Effect.	Velocity.	Effect.	Velocity.	Effect.	Velocity.	Effect.	Velocity.	Effect.	Velocity.	Effect.	Velocity.	Effect.
.066	{ 14.2	397	7454	390	7818	395	8893	402	7805	387	7485	393	7287	385	5142	389	7187	381	7417	381	7417
	{ 28.5	273	5574	269	5846	270	6517	273	5305	270	5525	267	5117	264	3721	271	5273	265	5632	265	5632
.085	{ 14.2	395	7957	394	8817	394	9127	393	7705	394	8504	387	7423	384	5719	382	7646	385	8285	385	8285
	{ 28.5	275	6201	271	6668	272	6939*	270	5919	272	6436	267	5458	265	4212	263	5658	267	6358	267	6358
.104	{ 14.2	392	8205	390	9095	384	9068	387	8113	388	8698	384	7871	387	6377	381	8303	383	8948	383	8948
	{ 28.5	275	6349	274	7342	265	7008	266	5928	267	5671	266	5617	265	4577	263	6239	267	7142	266	6593
.123	{ 14.2	396	8640	385	9086	379	9307	380	8187	379	8716	378	7853	381	6369	371	8230	372	8607	377	8630
	{ 28.5	277	6951	268	7254	262	7125	263	6003	265	6853	259	5540	265	4801	259	6439	256	6788	263	6916
.142	{ 14.2	393	8695	378	9073	374	9371	376	8350	373	8735	371	7870	377	6193	363	8248	347	8067	372	8604
	{ 28.5	273	6975	266	7411	257	7093	258	6096	262	6735	253	5491	257	4622	255	6032	249	6906	260	6989
.160	{ 14.2	385	8463	377	9380	365	9192	370	8378	370	8871	365	7885	372	6561	359	8428	339	7987	361	8470
	{ 28.5	272	7013	263	7594	251	7110	254	6367	258	7148	249	5542	256	4731	251	6678	244	6750	252	8070
.179	{ 14.2	384	8552	368	9141	352	8996	368	8584	361	8704	355	7628	367	6528	347	8151	328	7606	352	8425
	{ 28.5	265	6741	258	7574	242	6793	250	6200	253	7104	242	5457	252	4618	247	6796	236	6416	250	7089
.198	{ 14.2	384	8626	363	9197	342	8690	361	8534	352	8524	348	7641	358	6328	335	7878	296	6509	342	8140
	{ 28.5	268	7096	251	7257	234	6548	246	6196	247	6893	237	5417	248	4619	242	6734	217	5866	243	6885
.217	{ 14.2	380	8562	348	8610	330	8319	350	8158	341	8099	339	7457	353	6292	327	7763	—	—	329	7739
	{ 28.5	261	6812	245	7022	227	6338	239	5917	243	6801	232	5349	242	4485	236	6572	—	—	234	6526
.235	{ 14.2	365	7993	332	8022	319	7967	340	7953	332	7884	328	7159	344	6068	316	7509	—	—	312	7183
	{ 28.5	259	6775	234	6537	221	6173	232	5715	232	6342	227	5255	236	4343	225	6125	—	—	224	6171
.254	{ 14.2	367	8175	323	7905	298	7148	331	7719	319	7576	317	6797	336	5910	305	7237	—	—	296	6667
	{ 28.5	256	6710	224	6160	214	6008	228	5655	221	5880	218	4847	232	4294	219	5928	—	—	214	5770
.273	{ 14.2	356	7730	309	7466	285	6701	322	7445	307	7303	304	6330	330	5286	291	6774	—	—	278	6043
	{ 28.5	252	6629	217	6007	200	5320	223	4450	220	6030	212	4691	226	4146	214	5935	—	—	206	5559
.292	{ 14.2	351	7576	293	6918	271	6213	314	7137	294	6845	294	5980	320	5539	285	6709	—	—	266	5674
	{ 28.5	250	6612	212	5887	193	5028	214	5036	213	5700	204	4385	220	3959	208	5693	—	—	200	5680
.310	{ 14.2	342	7251	287	6728	264	5700	300	6621	286	6616	275	5285	309	5232	272	6140	—	—	250	5081
	{ 28.5	243	6235	203	5504	184	4658	208	4845	205	5395	193	3962	212	3721	201	5357	—	—	190	4844
.330	{ 14.2	332	6844	268	5949	245	5330	290	6290	276	6200	263	4855	301	5028	—	—	—	—	233	4457
	{ 28.5	241	6133	195	5102	176	4336	202	4618	197	5012	187	3740	206	3538	—	—	—	—	180	4384

NOTE.—The dimensions of the paddles given above, are those of the actual wheels; the models being all to one scale: the diameter of the wheel is 17.83 feet.

DEDUCTIONS FROM THE PRECEDING EXPERIMENTS.

In experiments such as the preceding, made on a small scale, there frequently arises a difference of action, and consequent effect, at variance with the true practical results: it therefore becomes important, before drawing conclusions from such experiments, to examine into the causes, which will operate differently on the large and small scale. In the model of Morgan's wheel the friction will be proportionally greater than in the actual wheel: the model was however made so perfect, that it could not have been much greater, although some allowance should be made.

The cycloidal wheels lost much of their effect from being on the small scale: the intervals between the paddles were so small, that the water could not escape, owing to its natural adhesion, which would have no sensible effect in practice: the loss from this was evidently so great, as could be seen by examining the motion of the wheel, that no just comparison can be made of its effect as compared with the others. These considerations will not, however, affect the comparison of the same wheel in different states of immersion, from which we learn the nature of its action; nor will it affect the comparison with the common wheel with different number and surface of paddles; so that many conclusions of practical utility may be derived by an examination of the preceding table of experiments.

The most direct comparison of the action of Morgan's with the radiating wheel, is with the last experiment, No. 10., which is in fact the same wheel with the paddles fixed radiating. Here, in the small immersions, the effect of Morgan's wheel is less than the radiating,—the mean of the three first immersions of the former being 6990, and of the latter 7156; which is owing to loss, as we have before pointed out, from the additional receding of the wheel: this is rendered strikingly evident from the *velocity* (in the experiments) on Morgan's wheel being at the same time greater than in the other.

In the deep immersion, Morgan's wheel has considerably the advantage, not only in velocity, but in effect,—the mean of the three last observations on the former being 6790, and the latter 5003; the loss from oblique action operating in this case very much against the common wheel.

In examining the other experiments, we find that a less deep paddle with a greater number of boards gives a better effect throughout. In comparing the best radiating wheel with Morgan's, we find it is completely superior in the small immersions, and continues to be so until a greater proportion than $\frac{1}{4}$ of the diameter of the wheel is immersed. In the experiments an allowance should be made for the loss of effect from the greater friction of the model; at the same time, there is little doubt that a well-proportioned common wheel will be superior to Morgan's in small immersions.

The experiments on the cycloidal wheels were not so satisfactory as could have been wished, from the loss of effect evidently produced by the adhesion of the water in coming out,—a difficulty that could not exist on the large scale: they however show a greater equality of effect throughout the different states of immersion than any of the wheels; and, in fact, in the deep immersions are superior to most of the wheels; which are important points in favour of this construction, and leave little doubt that the deficiency in the light dips, from the cause above named, was very great.

These experiments also very satisfactorily confirm the preceding calculations of the lost power with different immersions of the radiating wheel. The effective power in the calculated table with the immersion $\cdot 252$ of the radius is 660, and with the immersion $\cdot 550$ of the radius it is 553. In the experiments with immersion $\cdot 123$ of diameter or $\cdot 246$ of radius, the effect is 9086, (radiating wheel, No. II.); and with immersion $\cdot 273$ of diameter or $\cdot 546$ of radius, the effect is 7466, which will be found to have nearly the same ratio as the two calculated numbers; and the same will hold good with all the experiments in the table.

EXPERIMENTS TO ASCERTAIN THE EFFECT OF FIXING THE PADDLE-BOARDS
AT AN ANGLE WITH THE RADIUS OF THE WHEEL.

In the radiating wheel as commonly constructed, the arms radiate to the centre, and the floats being attached to the faces of them, make an angle with the true radius, which has the effect of causing the paddles to enter the water more obliquely, and thereby increasing the concussion. To obviate this, Messrs. Maudslay and Field have constructed wheels, so that the arms radiate to points at such a distance from the centre, that the faces of the floats are in the true line of the radius, which is found to have a beneficial effect.

The object of the following experiments was to ascertain how far an advantage would be gained by giving the floats an angle in a contrary direction, (viz. so that they radiate when entering the water to a point forward of the centre of the wheel,) and thereby causing them to enter less obliquely.

The experiments were made with the same apparatus as the preceding; and they were repeated in some immersions with the wheel inverted, so that the motion was in a contrary direction, to represent the effect of angling the paddles aft of the centre. The remaining four columns of each division of the table represent, 1st, The number of circuits or revolutions made in the reservoir; 2nd, The time of the experiment in seconds; 3rd, The relative velocity obtained by dividing the circuits by the time; and 4th, The useful effect calculated, as we have before described, by multiplying the square of the velocity by the circuits, which is doubled for the double area.

APPENDIX.

TABLE V.—Experiment to ascertain the effect of fixing the paddle-boards at an angle with the radius of the wheel.

Proportion of Diameter immersed.	Area of Resistance.	Paddles Radiating.					Paddles Angled 5°.					Paddles Angled 10°.								
		Circuits.		Time.	Relative Velocity.	Relative Effect.	Circuits.		Time.	Relative Velocity.	Relative Effect.	Effect reversed action.	Circuits.		Time.	Relative Velocity.	Relative Effect.	Effect reversed Action.		
		Time.	Relative Velocity.				Time.	Relative Velocity.					Time.	Relative Velocity.						
.125	14.2	Paddles Angled 15°.																		
		6-04	172	351	7441	6-18	170	363	8146	6-36	181	351	7835							
		5-12	209	245	6146	5-23	209	250	6537	5-56	220	253	7116							
		6-47	196	330	7045	6-71	200	335	7528	7-05	211	334	7860							
		5-63	228	247	6868	5-71	230	248	7023	5-91	238	248	7269							
		14.2	210	326	7274	7-00	213	328	7532	7-15	227	315	7094							
		28.5	210	239	6545	5-80	239	242	6798	5-98	255	231	6881							
		5-73	223	307	6455	7-08	230	308	6716	7-37	266	277	5654							
		6-83	223	218	6455	6-11	273	224	6130	6-32	294	215	5842							
		14.2	269	281	5588	7-58	261	290	6376	7-81	294	265	5484							
.185	14.2	Paddles Angled 20°.																		
		6-09	285	213	5524	6-36	294	216	5932	6-49	328	201	5244							
		7-30	265	279	5752	7-72	280	275	5838	7-73	319	221	3797							
		6-28	310	202	5124	6-61	325	203	5444	6-77	381	177	4242							
		7-67	298	157	5066	7-97	416	191	2907	—	—	—	—							
		14.2	340	189	4604	6-70	464	145	2816	—	—	—	—							
		.205	14.2	Paddles Angled 15°.																
				6-62	203	326	7037	5-35	237	293	5966									
				5-87	234	251	7356	5-83	260	224	5851									
				7-13	230	310	6852	7-00	355	197	2712									
28.5	255			242	6383	5-90	398	149	2619											
14.2	275			261	4898	7-16	469	152	1654											
28.5	294			205	5068	6-18	494	125	1928											
6-03	294			205	5068	7-12	536	133	1259											
14.2	310			247	4551	6-22	557	119	1875											
28.5	336			193	4849	7-08	594	119	1002											
.145	14.2	Paddles Angled 20°.																		
		7-50	384	105	2861	6-27	610	103	1329											
		6-45	408	158	3219	6-08	697	958	613											
		28.5	443	144	2382	6-39	745	857	938											
		14.2	465	160	2017	—	—	—	—											
		28.5	491	131	2509	—	—	—	—											
		14.2	513	181	2509	—	—	—	—											
		.165	14.2	Paddles Angled 15°.																
				6-03	294	205	5068	6-18	494	125	1928									
				7-46	310	247	4551	7-12	536	133	1259									
14.2	336			193	4849	6-22	557	119	1875											
28.5	366			138	4849	7-08	594	119	1002											
6-51	384			105	2861	6-27	610	103	1329											
14.2	408			158	3219	6-08	697	958	613											
28.5	443			144	2382	6-39	745	857	938											
14.2	465			160	2017	—	—	—	—											
28.5	491			131	2509	—	—	—	—											

ON THE RELATION BETWEEN THE DIAMETER OF THE WHEEL, AREA OF THE PADDLE,
AND THE VELOCITY OF THE VESSEL.

When the area of the float of a paddle-wheel is so adjusted to any given diameter that the engine is capable of performing its whole duty, it is evident that the same duty might also be performed with a less paddle and larger wheel, or with a smaller wheel and larger paddle, but the velocity of the vessel will not be the same in the two cases; and the question therefore is, to determine what change must be made in the area of the paddle, and what change would take place in the speed of the vessel, with a given change in the diameter of the wheel, so that the engine in both cases may perform its whole duty.

Let d = diameter of the first wheel,
 V = its circumferential velocity,
 a = the area of paddle,
 v = the velocity of vessel,
 $r d$ = the diameter of the second wheel,
 $r V$ = the circumferential velocity,
 a' = the required area of paddle,
 v' = the new resulting velocity of the vessel,

all of which quantities are given except a' and v' , which may be determined from the following considerations, viz.—

1st, That the whole duty of the engine is exerted in both cases, consequently,

$$(V-v)^2 Va = (rV - v')^2 r V a'.$$

2nd, That the resistance on the paddle in each case is equal to that of the vessel, and therefore proportional to the squares of the two velocities, v' and v , that is,

$$(V - v)^2 a : (rV - v')^2 a' :: v^2 : v'^2.$$

From these two equations we find

$$v' = \frac{v}{\sqrt{r}} \text{ and } a' = \frac{(V - v)^2}{(r^{\frac{3}{2}} V - v)^2} \times a.$$

From the first it appears that the two velocities are to each other inversely as the square roots of the radii. And by the second, the new area of paddle will be found to increase and decrease so rapidly, that generally little practical advantage can be taken of the condition of the first equation.

It appears from the above, that there are two different diameters of wheel, with dependent area of paddles, that will allow the full power of the engine to be developed. And when from circumstances of loading, &c., the whole power of the engine cannot develop itself: there are two ways in which this effect can be insured; the one by reducing the paddle, and the other by reducing the diameter of the wheel: by the former it will be seen that the speed of the vessel will remain the same, but by the latter it will be increased as the cube root of the power developed in the two cases.

We have seen that $(V - v)^2 Va$ expresses the whole amount of the power exerted, which, in the case we are now supposing, is less than the engine is capable of exerting.

Let the power, or, which amounts to the same thing, the number of strokes made in the two cases be as 1 to m .

Now supposing, in the first place, the diameter to remain the same, the velocity V will become $m V$; and we may find a' and the resulting velocity v' from the equations,

$$(V - v)^2 V a : (m V - v')^2 m V a' :: 1 : m,$$

and

$$(V - v)^2 a : (m V - v')^2 a' :: v^2 : v'^2;$$

that is, by making the whole power in the two cases as 1 to m , and the resistances on the paddles as v^2 to v'^2 .

From these equations it appears that $v' = v$, or that no increase of velocity will be given to the vessel by reducing the paddle, so as to bring out the full power of the engine.

But if the diameter of the wheel be changed, the paddle remaining the same, both the velocities V and v will be changed. Let the former become $p V$, and the latter $n v$; our equations are therefore,

$$\begin{aligned} (V - v)^2 V a' : (p V - n v)^2 p V a :: 1 : m, \\ (V - v)^2 a : (p V - n v)^2 a :: 1 : n^2, \end{aligned}$$

which reduced, give $p = n$, and each equal to the $\sqrt[3]{m}$; that is, the velocity of the vessel will be increased in the ratio of the cube root of the powers expended.

We see, therefore, that when an engine is not able to perform its whole duty, the diameter of the wheel ought to be reduced, and *not*, as is usually done, the area of the paddle; for in the former case the velocity is increased in the ratio of the cube roots of the number of strokes, while in the former it remains the same as when the less power was developed.

To find the change in the diameter required to produce this effect, we know the circumferential velocities are $V : V \sqrt[3]{m}$, or as 1 : $\sqrt[3]{m}$; we know also that these velocities are as the number of strokes multiplied by the radii of the wheels; putting therefore r and r' for the two radii, the velocities are as $r : m r'$, or $r : m r' :: 1 : \sqrt[3]{m}$, whence

$$r' = \frac{r}{m^{\frac{2}{3}}}$$

the required radius of the paddle.

In the case of the Salamander, from the great immersion of the paddles, the engine could only make 15 strokes instead of 20, its full duty.

We may now find what increase of speed would have been given to the vessel by reducing the wheel so as to allow the engine to perform its whole duty.

We have $m = 1.33$, whence $r' = .8264 r$; and $n v = 1.100 v$; if therefore the diameter of the wheel of the Salamander had been reduced in the ratio of 1 to .8264, the speed of the vessel would have been increased in the ratio of 1 to 1.100; that is, by reefing each paddle about 19 inches, the speed of the vessel would have been increased about $\frac{1}{10}$ ths of a mile.

In these calculations a similar action of the paddles has been assumed, with every variation of diameter, which in reality is not strictly true, as every change of the position of the floats will vary the angle at which the centre of pressure enters the water. This variation will

however be so small in the greatest extent of reefing ever required, that it is not necessary to introduce it into the calculation. As far as its effect extends, it is favourable to the reefing, as thereby the obliquity of action is diminished, and consequently the loss of power.

ON REEFING PADDLES.

In the commencement of a long voyage, a steam vessel is necessarily very deep in the water, from the quantity of coals required for the consumption of the engine. This would have the effect of diminishing the speed in a small degree, were the engine capable of exerting its full power; but from the wheel being also necessarily more immersed, there results a great loss of the power of the engine, not only from the increased oblique action, but from the number of strokes being reduced; and having at the same time to combat with a greater resistance, a very considerable loss of speed is the consequence.

In the experiments given in Table I, the speed of two of the vessels is given both when light and laden, from which the great amount of this loss will be seen. The first is the Messenger with common wheels of 730 tons burden, and 200 horse power. Her speed with 60 tons of coals on board is 9.75 miles, and with 130 tons 8.00 miles an hour.

Her sectional area of resistance could not have been increased in a greater ratio than 6 to 7, so that the speed, if the whole power of the engine was brought out in the two cases, ought not to have been reduced in a greater ratio than the cube root of these numbers, or from 9.75 to 9.25 miles per hour; hence there is a loss of 1.25 miles an hour from the bad action of the wheels, and from the engine not being able to make its full number of strokes.

The second experiment alluded to is the Flamer of 494 tonnage, and 120 horse power, fitted with Morgan's wheels. Her speed with 15 tons of coals was 10.9, and 112 tons, 9.57 miles per hour; the section of resistance would not be increased more than as 4 to 5, so that the speed should not have been reduced to less than 10.12 miles; the remaining loss of 0.55 miles per hour is therefore due to the diminished power of the engine, which, although much less than in the common wheel, is still very serious.

A similar comparison can be made between the Phoenix and the Salamander, which are vessels of the same tonnage and horse power, and have nearly the same speed under similar circumstances. The speed of the Phoenix light was 11.7, and the Salamander laden 8.15. Allowing a difference of section in the ratio of 11 to 15, which is the extreme between a light and laden vessel, the reduced speed ought to have been 10.55, and there is therefore a loss from the combined effect of the bad action of the wheel and reduction of the strokes of the engine, of 2.4 miles per hour.

This serious loss of speed in a laden vessel, although greatly reduced by the use of Morgan's wheels, as seen from the second experiment, as I have no doubt it will be in nearly an equal degree by the cycloidal wheel, would be more effectually saved by reefing the paddles, by which the whole power of the engine might be brought out, and the loss from oblique action very much reduced.

A ready method of reefing appears at present to be attended with some practical difficulties, from the alterations that are made being required while the vessel is at sea. The advantages which would be derived from it, particularly where speed is of importance, are evidently so great, that I hope still to see it accomplished; but should it ultimately be found im-

practicable, the best remedy is the use of the vertically acting or cycloidal wheel, and keeping the diameter as large as possible, by increasing the length of the stroke of the engine, so that more or less immersion will make comparatively less difference in the action of the wheel; the larger the vessel the less will be the loss, because the diameter of the wheel increases in a greater ratio than the degree of immersion. In the Victoria, which is fitted with the cycloidal wheels, it is proposed to remove the outer paddles before starting, and to replace them during the voyage when the vessel is sufficiently light, which, if it can be effected, will be attended with considerable advantage; but much less than if a ready method of reefing could be devised, so that the surface of the paddle-board should be at the constant command of the engineer.

EXPERIMENTS TO ASCERTAIN THE RATIO OF THE SPEED OF A STEAM BOAT
TO THE POWER.

By the preceding investigations we learn, that the speed of a vessel varies theoretically as the cube root of the power effectively developed. In vessels destined for long voyages, where a great number of miles has to be travelled before a fresh supply of coals can be taken on board, it becomes of importance to ascertain by experiment how far this law is consistent with practice. The attention of Professor Barlow, as one of the Commissioners appointed by Government to report upon the communication to America by steam boats from Valentia, was directed to this subject, and he obtained the permission of the Admiralty to make some experiments on her Majesty's ships Echo and Lightning,—the results of which, with the reports accompanying them, are as follows.

TABLE VI.—Experiments on her Majesty's ship Lightning, to ascertain the difference of speed due to different amounts of steam power; taken in successive hours by Massey's Patent Logs, between 8 h. A. M. and 3 P. M., November 15th, 1836.

Time of heaving the log.	Three Patent Logs.			Mean velocity.	Pressure by Steam Gauge.	State of the vacuum.
	Larboard, No. 4529.	Midship, No. 4530.	Starboard, No. 4532.			
H. m. s. 9 18 56 Taken up, 10 18 56	Miles. 0 0 0 8-19	0 0 0 —	Full steam. 0 0 0 8-34	} 8-26	3½	27
10 45 0 Taken up, 11 45 0	0 0 0 8-03	0 0 0 —	Reduced steam. 0 0 0 8-05			
11 53 0 12 53 0	0 0 0 7-44	0 0 0 7-42	Head to wind, reduced steam. 0 0 0 7-63	} 7-53	1	27½
1 4 0 2 4 0	0 0 0 7-92	0 0 0 7-91	Full steam. 0 0 0 7-90			

Mean of number of strokes, full steam	. 24½	Mean speed	. 8·08 miles.	
Do.	do. reduced steam	23	Mean do.	. 7·78
			Difference	. 0·3

Steam used at full pressure.		Reduced steam.	
Atmosphere	. 14¾ lbs.	Atmosphere	. 14¾ lbs.
Above do.	. 3¼	Above do.	. 1
	<hr/>		<hr/>
Total	. 18		15¾
Number of strokes	24½	Number of strokes	23
	<hr/>		<hr/>
Products	. 441		362

Powers employed nearly as 11 to 9, speed 25 to 24.

FIRST REPORT ACCOMPANYING THE EXPERIMENTS ADDRESSED TO
SIR JOHN BARROW.

“ SIR ;

Woolwich, Nov. 15, 1836.

“ On the next page I have given the result of my experiments yesterday, on his Majesty’s steamer Lightning, from which it will appear, that reducing the steam pressure from 3¼ to 1 lb., makes a difference in the speed, when going with the wind, of only about ⅓th of a mile per hour ; and with her head to the wind, of less than ⅕ths mile per hour ; at a medium ⅓ths mile per hour ; the reduction of the steam power being between ⅓th and ⅕th : that is, by allowing a reduction of less than ⅓rd of a mile per hour, or 8 miles per day, a vessel which can now carry only ten days’ fuel, would, with this reduction of speed, carry twelve days’ fuel, and perform a voyage longer by nearly 330 miles,—i. e., 2330 miles, instead of 2000.

“ There are different ways in which this reduction may be effected ; viz. either by reducing the pressure, as I have done,—by using an engine of less power,—or by causing the steam to act more expansively : which will be the best is a question for the decision of an engineer,—all I intended to show by the experiments was, that the questions of going quickest and going farthest were different.

“ I beg to return my best thanks to my Lords Commissioners of the Admiralty for the facilities they have afforded me of confirming by experiment a result which is perfectly consistent with theory.

“ I have the honour to be, Sir, your obedient servant,

(Signed) “ PETER BARLOW.”

SECOND REPORT, ADDRESSED TO CHARLES WOOD, ESQ.

“ SIR ;

Woolwich, March 2nd, 1837.

“ In compliance with the request of Sir Charles Adam, I beg to forward a concise abstract of my experiments on his Majesty’s steamers Echo and Lightning, and the conclusions I draw from them, although perhaps they require to be confirmed by one or two other experiments.

" It is well known, that the resistance of water to a body moving in it increases much more rapidly than in the proportion of the velocity, and therefore, that the quantity of fuel requisite to increase the speed from any given velocity,—as for example, from 9 miles to $9\frac{1}{4}$ miles,—would be much more than in the latter proportion : in fact, by being content with the former speed, the same fuel would in some cases carry the vessel 100 or 200 miles farther than with the latter.

" This was my theoretical view of the subject ; and by permission of the Lords Commissioners I put it to the test of experiment in the two vessels above named ; and the result was, that by reducing the power, and therefore the expenditure of fuel, *one-sixth*, the speed was reduced only one twenty-fourth : and this result is in a great measure confirmed by the prior experiments of Captain Oliver on his Majesty's steamer *Dee*.

" I consider, therefore, that it would be desirable, that the captains in command of his Majesty's steam vessels should be made acquainted with the facts, and that they should be recommended, when their vessels are employed in services which do not require the greatest speed (at all cost), and when wind and weather are favourable, to work with their steam gauge at a less pressure above the atmosphere than at present.

" This may be done by allowing their fires to act with less energy, without requiring any other change ; and the full power will be always at command if any circumstance should require it.

" There can, I think, be no doubt, that this practice in such cases as I have supposed, would allow the same distance to be run at 9 miles per hour, with $\frac{1}{6}$ th less fuel, than if the speed were forced all the voyage to $9\frac{1}{4}$ or $9\frac{1}{2}$ miles per hour.

" I have the honour to be, Sir, your obedient servant,
(Signed) "PETER BARLOW."

The experiments on her Majesty's ship *Dee*, alluded to in this Report as confirming those on the *Echo* and *Lightning*, are as follows.

TABLE VII.—Experiments on relative speed and power of his Majesty's ship *Dee*, on her passage from Portsmouth to the Downs.—Tonnage, 705 ; power, 200 ; boilers, iron ; pressure on the safety valve, $3\frac{1}{2}$ lbs. ; wheels, radiating ; manufacturers, Maudslay and Co.

Date or hours.	Knots.	Course.	Winds.		Immersion.				Coals.		Number of fires.		Barometer.		Remarks.	
			Direction.	Force.	Waves.	Aft.	Forward.	Throttle valve.	Sail.	Revolutions.	Consumption.	Quality.	Steam gauge.	L.		S.
1832	8	-	calm		-	13.4	12.2	0	„	16	Bush ^{1c} .	6	$3\frac{2}{10}$	28	$28\frac{2}{10}$	Full power, six fires.
	7.2	-		1	-	„	„	„	„	16	15	4	$2\frac{1}{2}$	„	„	} Fires in each boiler, banked up.
	6.4	-	head	4	-	„	„	„	„	14	15	4	—	„	„	
	6.2	-		4	-	„	„	„	„	$12\frac{1}{2}$	10	3	$2\frac{1}{2}$	„	„	

Maximum speed, full power 8.2 knots.
 One fire banked up under each boiler 8.0 ,,
 The same, with more head wind, and fires banked up under one set, and full
 fires under the other 6.2 ,,
 Thus, $\frac{3}{4}$ speed with $\frac{1}{2}$ fuel ; ship deep.

TABLE VIII.—Her Majesty's ship Phoenix.—Tonnage, 815 ; power, 220 ; boilers, iron ; pressure on the valve, $3\frac{1}{2}$ lbs. ; wheels, radiating.

Date.	Knots.	Course.	Winds.		Waves.	Immersion.		Sail.	Revolutions.	Coals.			Barometer.		Remarks.
			Direction.	Force.		Aft.	Forward.			Consumption.	Quality and weight.	Number of fires.	L.	S.	
1834										Bushls.					
July 25	8.4		head	1					16 $\frac{1}{2}$	15		6	28	28	
July 25	8.6			4					17	17					
May 28	8.6	W. to N.	W.E.	5					17	15		4			
May 24	9.	N.W.	N.E.	5				sail	16	15					
May 25	9.2	W. by N.	East	6					18	15					
May 27	3.6	E. by S.	E. by S.	6	chop				10	15		6			
May 27	5.6	E.S.E.	S.E.	6					12	14		6			
May 29	8.2	E. by N.	N.E.	4					16	15		4			
June 20	9.2				smooth			sail	18	15		6			
June 20	9.				calm										
July 6	7.2	E. by S.	E.S.E.	4	chop	13.9	13.2		15	15		6			{ Royal George yacht in tow.
July 9	6.2	W. by N.	W. by N.	5					15	16 $\frac{1}{2}$		6			
Aug. 15	4.6		head	6					12	16 $\frac{1}{2}$		6			{ Royal George yacht in tow.
Aug. 18	8.4	W. by N.	N.E.					sail	17	16 $\frac{1}{2}$		6			

With full power 8.4 8.6, 6 fires, 15, 17 bushels. Moderate, and fine weather.
 Reduced 8.2 8.6, 4 ,, 15 ,,
 Sails set 9.0 9.2, 4 ,, 15 ,,
 Full power 3.6 5.6, 6 ,, 14, 15 ,, Fresh, and strong head wind.

YACHT IN TOW.

Full power 9.2 knots, 6 fires, 15 bushels, Sails set, five.
 7.2 ,, 6 ,, 15 ,, Head wind, moderate.
 4.6 ,, 6 ,, 15 ,, Do. do., fresh.

No satisfactory record of speed by one boiler alone. Welsh coal a saving of $\frac{1}{3}$ th over Scotch, though not the best quality. Two revolutions approximate to the knot ; and the table formed on propositions of Lieut. T. Baldock.

(Signed) ROBERT OLIVER.

The results of these experiments, although they do not sufficiently coincide to establish the exact law of the ratio of speed to the effective power, agree in showing, that the last mile or half mile of velocity is obtained at a very great expense of fuel, and that in circumstances

where from the length of a voyage there is a difficulty in carrying a sufficient supply of fuel, great economy will be effected by the sacrifice of some speed.

This, perhaps, with the present engines, cannot be more effectively done than by the mode adopted by Mr. Barlow, in his experiments on the Lightning; viz. working the steam at a very little pressure above the atmosphere: this, in fair weather, when the engine can make nearly its full number of strokes, will produce a very small diminution of speed; and in circumstances when any additional power may be required for the safety and management of the vessel, it can be at once effected by the addition of a weight to the safety valve.

By referring to the experiments on the Lightning, it will be seen, that the increase of speed by the additional pressure of steam in the boiler is much less in proportion to the fuel consumed, than the theoretical law would give it, chiefly owing, probably, to the vacuum in the condenser being so much less perfect in this case, so that the effective power is less than in the proportion of the consumption of steam: this is an additional argument in favour of working at a low pressure in sea boats; and there will be, besides, less wear of the engine and less liability to get out of order.

It is however a very commonly received opinion, totally at variance with the above results, that by increasing the power in proportion to the tonnage, less fuel would be consumed in a voyage of a given length. In fact, Dr. Lardner, in his work on the Steam Engine, states, "that the results of experience obtained in the steam navigation of our channels, and particularly in the case of the Post Office packets on the Liverpool station, have clearly established the fact, that by increasing the ratio of the power to the tonnage, an actual saving of fuel in a given distance is effected;"—which anomaly he accounts for by the diminution of the draught of water produced by the additional speed.

The question of the most economical ratio of the power to the tonnage being one of the highest importance in vessels destined for long voyages, we have endeavoured to obtain as many facts and experiments as possible, of the times of making sea voyages of various vessels, with the tonnage and horse power; and, it is found, in every instance, that the consumption of fuel is less the smaller the power in proportion to the tonnage.

To illustrate the above, we give the following table, from the Parliamentary Reports on Steam Navigation to India, of the times of the voyages of Her Majesty's Admiralty steamers to Corfú and Patras, and back, a distance of 5200 miles, made by nine different vessels, varying in tonnage and horse power. These voyages being so extensive, and made in every variety of weather, we have chosen them as furnishing the best possible data by which to ascertain the truth of the above question.

The columns of the table, 1, 2, 3, 4, 5, and 7, are abstracted from the Parliamentary Report as they stand; the remaining columns are calculated. Column 6 is the number of tons per horse power, obtained by dividing the measured tonnage by the nominal horse power. Column 8 is the time of steaming in each voyage, obtained from column 7 by subtracting the time of stoppages from that of the whole voyage. Column 9 gives the means of the preceding. Column 10 is the actual consumption of coals during the voyage, calculated at the rate of 8 lbs. per horse power per hour; which (as stated by Mr. Field in his examination) is found to be very nearly the average of all engines. Column 11 is obtained by dividing the whole consumption by the tonnage, and gives the weight per ton consumed during the voyage, and consequently expressing the relative economy of each vessel.

TABLE IX.—Performances of Her Majesty's Admiralty Steam Packets since the extension of their voyages to Corfú and Patras, together with their respective tonnages and powers, with calculated deductions therefrom.

1.	2.	3.	4.	5.	6.	7.	8.	9.	10.	11.	12.
Date of departure from Falmouth.	Name of vessel.	Measured tonnage, including engine room.	Nominal power of the engine.	Description of the wheel.	Number of tons per horse power.	Period of voyage, including 12 days for detention at the several ports of arrival.	Number of days steaming.	Mean time of steaming of each vessel.	Consumption of coals, calculated at the rate of 8 lbs. per horse power per hour.	Bushels of coals consumed during the voyage, per ton.	Remarks.
August, 1832	Firebrand	496	140	Radiating	3.54	45	33	33	887,040	1788	Fine weather. Variable.
September, 1832	Columbia	360	120	Do.	3.00	54	42	42	967,680	2688	
July, 1833	Columbia	360	100	Morgan's	3.60	43	31	34	652,800	1813	Fine weather, but boilers gave out, and put into Brest: lost 5 days, included in the 48. Strong breezes, for and against. Variable and rough.
December, 1833	Columbia	360	100	Do.	3.60	46	34				
March, 1834	Columbia	360	100	Do.	3.60	49	37	39	599,040	2140	Strong gales of adverse weather generally. Variable.
October, 1832	African	280	80	Radiating	3.50	51	39				
November, 1832	Flamer	496	120	Morgan's	4.13	50	38	31.8	732,670	1477	Variable, bearing N.W. home from Gibraltar.
March, 1833	Flamer	496	120	Do.	4.13	43	31				
June, 1833	Flamer	496	120	Do.	4.13	45	33	29			Very boisterous; was run foul of, and put back to Gibraltar, and thereby lost 11 days, included in the 52.
November, 1833	Flamer	496	120	Do.	4.13	52	33				
April, 1834	Flamer	496	120	Do.	4.13	40	28	42	1,128,960	1544	Strong breezes and gales from westward. Strong gales, adverse in general, except run from Gibraltar with S.S.W. Variable.
December, 1832	Hermes	730	140	Radiating	5.21	56	44				
April, 1833	Hermes	730	140	Do.	5.21	52	40	42	1,612,800	2209	Strong gales, adverse in general, except run from Gibraltar with S.S.W. Variable.
September, 1833	Hermes	730	140	Do.	5.21	54	42				
January, 1834	Messenger	730	200	Do.	3.65	54	42	7	1,004,400	3722	Strong gales, adverse in general, except run from Gibraltar with S.S.W. Variable.
January, 1833	Alban	294	100	Do.	2.94	69	57				
February, 1833	Firefly	560	140	Do.	4.00	57	45	35.66	938,540	1711	Light winds up to Gibraltar; on return with S.W. was all but 6 days under sail Variable and rough. Moderate and variable.
May, 1833	Firefly	560	140	Do.	4.00	48	36				
August, 1833	Firefly	560	140	Do.	4.00	44	32	29			
October, 1833	Firefly	560	140	Do.	4.00	41	29				
February, 1834	Firefly	560	140	Do.	4.00	53	41	31			
July, 1834	Firefly	560	140	Do.	4.00	43	31				

In examining this table, it will be seen that vessels with similar wheels, whose tonnage is large in proportion to the horse power, in every case consume less fuel per ton during the voyage: for instance, in the *Hermes*, which has the largest proportional tonnage, viz. 5·21, the consumption per ton is 1544 lbs.; being less than half that of the *Alban*, viz. 3722, the tonnage of which is the least (viz. 2·94) per horse power.

In the vessels with Morgan's wheels the largest proportional tonnage is the *Flamer*, being 4·13 per horse power; the consumption per ton is 1477. In the *Columbia*, the tonnage per horse power is 3·60, and the consumption per ton 1833.

The most direct comparison in the table is between the *Hermes* and the *Messenger*, being vessels of equal tonnage and similar wheels, but with different power,—the former being 140, and the latter 220 horse. The consumption of the *Hermes* is not more than $\frac{2}{3}$ rds that of the *Messenger*.

As an additional confirmation of these results, I have given the following table of the mean time of performing several voyages, between Liverpool and Kingstown, of Her Majesty's Post Office packets, *Comet*, *Etna*, *Thetis*, and *Dolphin*, between January and June, 1837; with the quantity of coals consumed, and the same calculated columns as in the preceding table.

TABLE X.—Performances of Her Majesty's Post Office Packets
between Liverpool and Kingstown.

Name of the vessel.	Tonnage.	Horse power.	Tons per horse power.	Mean.	Mean speed.	Consumption of coals per hour.	Consumption of coals during the voyage.	Coals per ton consumed during the voyage.	Remarks.
				Hours. Min.	Miles.	Lbs.	Lbs.	Lbs.	
<i>Comet</i> .	437	190	2·3	13 32½	8·86	2632	35,640	81·5	{ Mean of six voyages each way.
<i>Etna</i> . .	365	150	2·43	14 26	8·31	1904	27,480	75·3	Do. do.
<i>Thetis</i> .	391	160	2·47	12 47	9·38	2000	25,560	65·4	Do. do.
<i>Dolphin</i> .	331	166	2·00	12 18	9·75	2255	28,105	64·9	{ Mean of two voyages each way.

These results, it will be seen, confirm those of the Mediterranean packets; the consumption being less per ton during the voyage, when the tonnage of the vessel is largest in proportion to the horse power.

We may therefore fairly conclude, that the idea of a saving of fuel being effected by increasing the power of a vessel is erroneous. Under particular circumstances it may happen, that an additional power may effect a saving; but, generally speaking, it may be assumed, that a great economy of fuel will be obtained by diminishing the power of the vessel as much as possible, provided there is sufficient at command for the safety and management of the vessel, should circumstances require it.

ON THE POWER AND TONNAGE OF STEAM VESSELS BEST ADAPTED TO LONG VOYAGES.

The proposed employment of steam communication in voyages of greater length than has hitherto been accomplished, and particularly in the voyage to America, a distance of 3000 miles, renders the question of the vessel best adapted to such purpose of great interest, both in this country as well as in America. In fact, a voyage of such length has been hitherto considered beyond what can be obtained by steam power alone, from the difficulty of carrying a sufficient quantity of coal for the consumption of the engine: the improvements, however, which have gradually been introduced, and the success which has attended what has yet been attempted, have given confidence to a sufficient number of individuals to embark in this undertaking, and vessels for the purpose are now being constructed both at London and at Bristol,¹ which will be ready to launch in a few months.

The voyages which have already been performed, not being of such length that the supply of coals for the engine has been a matter of difficulty, the attention of engineers has been directed rather in giving the greatest speed, than in the greatest capabilities for distance: such vessels must therefore not be looked upon as a criterion of what may be performed: their consumption, speed, &c., will however serve as data by which we may estimate the capabilities of vessels of tonnage and power better adapted to the purpose.

The larger the vessel, every thing being in proportion, the greater will be her capabilities both for speed and length of voyage: this I will illustrate in a few words theoretically, and then compare it with the practical results.

The means of stowage of any vessel (which is proportional to the tonnage) will increase as the cube of the linear dimensions, but the sectional area or resistance will increase only as the square; consequently, if the power be made proportional to the tonnage, an increased speed will be given to the vessel, and consequently the consumption of fuel in a voyage of a given length will be decreased, or length of voyage increased, in the same ratio.

If the power of the engine be only increased proportionally to the resistance, or immersed section, or the same velocity given to the vessel, the consumption of coals per hour being increased in a less proportion than the means of stowage, it is obvious the fuel will last much longer, and the length of the voyage, both in time and distance, will be proportionally increased.

To ascertain numerically the amount of the saving in the two cases, let the contents, power, sectional area, and velocity, of any existing vessel, be represented by c , p , a , and v ; and let it be required to find the velocity of a vessel, c' , whose power, sectional area, and velocity, we will call p' , a' , and v' .

Assuming the case of the powers being in the ratio of the tonnage,

$$p' = \frac{c'}{c} p ;$$

and as the section is increased as the square of the linear dimensions, and the tonnage as the cube, we have

¹ This vessel (The Great Western) is now launched, and is arrived in the Thames.

$$a' = \left(\frac{c'}{c}\right)^{\frac{2}{3}} a.$$

Again, the resistance in the two cases being as the area into the square of the velocity, we have

$$r' : r :: \left(\frac{c'}{c}\right)^{\frac{2}{3}} a v'^2 : a v^2;$$

but the power expended and overcome in a given time is as the resistance into the velocity; therefore the power expended is as

$$\left(\frac{c'}{c}\right)^{\frac{2}{3}} a v' : a v;$$

but the force expended by the engine in a given time is a representation of its power; therefore,

$$p' : p :: c' : c :: \left(\frac{c'}{c}\right)^{\frac{2}{3}} v' : v,$$

$$\text{or, } c'^{\frac{1}{3}} : c^{\frac{1}{3}} :: v' : v,$$

$$\text{whence, } v' = v \left(\frac{c'}{c}\right)^{\frac{1}{3}}.$$

Then, if we take $c' = 2c$, or double tonnage, we find the ratio of the areas $1 : 2^{\frac{2}{3}}$, or $1 : 1.587$; and the ratio of the velocities $1 : 2^{\frac{1}{3}}$, or $1 : 1.08$: or a decrease of about $\frac{1}{13}$ th in the time of making a given voyage, and of course a corresponding increase in the capability of the vessel for distance.

If, instead of increasing the power in proportion to the tonnage, it is only increased in proportion to the resistance, or the same speed is given to the vessel, then the power required will be as the section, or as 1 to 1.587,—or not much more than half as much again; and, consequently, a voyage of more than one-and-half times greater length can be performed, while the spare room for cargo will be in the same ratio as the increase of the vessel, or as 1 to 2; and the vessel will have the same power to contend with adverse weather, as the smaller one with the larger proportion of power.

These results may be said to be theoretical, but the examination of our present voyages show that they are perfectly consistent with practice. Referring to the performances of Her Majesty's Mediterranean packets, it will be seen, that in the smaller vessels, where the power is large in proportion to the tonnage, and consumption of coals large per ton, the speed of the vessel is generally less than in the larger vessels with a smaller proportion of power, and consequently small consumption of coals per ton.

It may also be seen to obtain throughout the experiments on Her Majesty's steam vessels at Woolwich, where the larger vessel generally gives a greater speed, although the proportion of power is less than in the small ones.

To exhibit the difference more fully, I have given the following table of the average speed and consumption of coals of nine of the most recently constructed of Her Majesty's steam vessels, and have calculated what speed the largest, viz. the *Medea*, should make, by the rules given above from each of the other vessels, having Morgan's wheels. I have compared those with the radiating wheels with the largest of that class, viz. the *Dee*.

TABLE XI.—Giving the Speed and Consumption of Coals of nine of the most recently constructed of Her Majesty's Steam Vessels.

Name.	Tonnage, new register.	Horse power.	Description of paddle wheel.	Average speed in nautical miles.	Average consumption of coals per hour per horse power.	Number of hours steaming the average is deduced from.	Speed of the Medea, calculated from each of the vessels having Morgan's wheels.	Speed of the Dee, calculated from each of the vessels having the common wheel.
Medea	807	220	Morgan's	7·8	Lbs. 8·3	1176	7·8	
Flamer	414	120	Do.	6·0	10·7	780	7·3	
Blazer	410	100	Do.	6·9	10·3	1645	7·7	
Tartarus	410	100	Do.	5·5	10·7	914	6·15	
Pluto	295	100	Do.	6·5	9·7	986	6·8	
Confiance	246	100	Do.	6·2	10·	2279	6·2	
Dee	639	200	Radialing	6·5	8·3	1161		6·5
Firefly	473	140	Do.	6·25	10·7	2206		6·5
African	246	90	Do.	5·13	10·9	3895		5·5

It will here be seen, that the speed both of the Medea and the Dee exceeds that obtained from the smaller vessels; which clearly shows that the advantages of increased tonnage are even greater than the theory gives it: the consumption of coals per horse power is also less in these vessels; which shows that there are several practical advantages in their favour, which are not embraced in the theoretical view of the case. One of which is, that the diameter of the wheel increases in a greater proportion than the variation of immersion of the vessel, and is consequently proportionally less buried in the water when the vessel is laden, which is a cause of great loss of the power of the engine, as we shall explain more particularly in another part of this article.

There is another advantage in a large engine, from its increased momentum, which causes it to act as a fly wheel, and is, I am satisfied, of more importance than is generally supposed. One often hears of the motion of the vessel acting as a fly wheel to the engine; which is quite an erroneous idea, as the action of a fly wheel is that of a reservoir of power, receiving it at one time from the engine, and exerting it at another on the machinery to be put in motion: now as the paddle wheel is always exerting a force, although a variable one, on the water, it cannot possibly receive any assistance from the motion of the boat, which therefore cannot act as a fly wheel to it. It certainly so far assists it, as by its velocity through the water to allow the engine to make a greater number of strokes, and increases the momentum produced by its weight; but this is all it does, and this effect is greatly increased by giving more weight to the paddle wheels.

The above observations are given merely to show, that the advantages of the increased tonnage of steam vessels, which have been calculated theoretically, are fully borne out in practice. I shall now proceed to calculate with the data, which the performances of some of our sea-going vessels afford, what may be accomplished by others, whose power and tonnage are better adapted to making a long voyage.

The Medea, the largest of Her Majesty's steamers, is 835 tons' burden, and has engines of 55½ inches cylinder, and 220 nominal horse power. The average speed at sea is 7·8 nautical

miles per hour, and she consumes 8·3 bushels of coals per horse power per hour, or about 20 tons per day. She is capable of carrying 360 tons of coals, or sufficient for 18 days, and consequently of making a voyage of 3370 miles.

Let us inquire what will be the capabilities of another vessel of the same model, and of 1670 tons in point of distance; supposing, 1st, her power to be increased proportionally to tonnage; and 2ndly, that it is increased proportionally to the sectional area or resistance.

To double the tonnage of a vessel preserving the same model, her linear dimensions will be increased as

- - - 100 to 126

Consequently, her section or area of resistance - 100 to 158

And her stowage as - - - 100 to 200.

Now, in the first case, the power being as 200, and the resistance to which it is opposed being only as 158, the increased force per square foot of the section will be as 158 to 200, and the resistance being as the cube of the velocity, the speed will be increased in the ratio of $158^{\frac{1}{3}}$ to $200^{\frac{1}{3}}$, of 1 to 1·08, or, which is the same thing, 1 to $2^{\frac{1}{3}}$; and the capabilities of the vessel for distance will be increased in the same proportion, viz. from 3370 to 3640 miles.

In the second case, viz. increasing the power of the engine only in proportion to the section, the velocity will remain the same as in the former vessel; but proportional consumption of coal will be less in the ratio of 200 to 158, and consequently the length of the voyage will be increased as 158 to 200, or from 3370 to 4266 miles.

The splendid steam ship, Victoria, now being built by Messrs. Curling, Young, and Co., for the American voyage, is 1825 tons' burden, and has engines of 76 inches cylinders, or nominal power of 412 horses. The speed of this vessel, if the engines bore the same proportion to the tonnage as the Medea's, viz. 481 horse power, would be increased in the ratio of 1 to $\left(\frac{1825}{835}\right)^{\frac{1}{3}}$, or 1 to 1·091, or from 7·8 to 8·5 knots per hour; but as the engines are but of 412 horse power, her actual speed will be reduced in the ratio of the cube root of 481 to the cube root of 412, or from 8·5 to 8·08, being an actual increase of velocity above the Medea from 7·8 to 8·08 knots.

Or we may arrive at the speed differently, as follows: to give the Victoria the same speed as the Medea, the power must be increased as 1 to $\left(\frac{1825}{835}\right)^{\frac{2}{3}}$, or 1 to 1·684, or from 220 to 370 horse power; but as the actual power is 412, the speed will be increased above the Medea as the cube root of 370 to cube root of 412, or from 7·8 to 8·08 knots per hour, the same as before.

The Victoria is estimated to carry 750 tons of coals in addition to her cargo: allowing 8·3 lbs. per horse power per hour, or $36^{\frac{1}{2}}$ tons per day, to be her consumption of fuel, she is well able to perform a voyage of $20^{\frac{1}{2}}$ days, and traverse a distance of 3960 miles without a fresh supply of coals. Now as the voyage from Cork does not exceed 3000 miles, and will be accomplished in average weather in eighteen days, she will have above $2^{\frac{1}{2}}$ days' fuel to spare.

In this calculation I have assumed the same consumption of fuel per horse power as in the Medea, making no allowance for the economy of the larger engines; besides which the Victoria

is fitted up with Hall's Patent Condenser, which is stated upon good authority to produce a saving of at least one pound per horse power per hour. Allowing the consumption to be reduced to 7 lbs. from this cause, and from the greater economy of the larger engines, the voyage will be made with a consumption of 565 tons, being 185 tons less than the vessel is capable of carrying; and she will perform a voyage of 4690 miles.

There is no doubt, therefore, that this vessel will, in average weather, accomplish the voyage with facility: and I should expect, with the power she possesses, under the most unfavourable circumstances; for although in a very severe gale of wind the most powerful steamers will make little headway, yet such gales are never of sufficient duration to effect in a great degree the time of a voyage, if we may judge from the voyages of the Mediterranean, Liverpool and Kingstown Post-Office Packets, &c., which, although comparatively small vessels, the time of their voyages rarely exceeds one-fifth of the average time. This in the *Victoria* will still leave spare fuel for two days, supposing the engines to work at full power the whole time; which need not be the case in adverse weather, for as the engine does not make its full number of strokes, it does not require its full allowance of steam.

We have hitherto spoken of a vessel as a steamer only, but it is to be presumed she will gain much by the power of her sails. Captain Austin states, that the sailing rate of the *Medea*, when on a wind in a strong single-reefed topsail breeze, and smooth water, is 8 knots per hour, and in a moderate quarterly gale, $11\frac{1}{2}$ knots. Her tacking may be depended upon in strong breezes in a sea way fully equal to a sailing vessel of war, and in light winds when she has steerage way. He also states, that while cruising with the squadron, in treble-reefed topsail breezes, he has found her to weather considerably upon them; showing the advantage of the great quantity of canvas spread in the fore and aft sails.

Should it therefore happen that the fuel is exhausted in the outward American passage, or any accident happen to the machinery, which, if ever, will be a rare occurrence, recourse may be had to the sails, and she will still be upon a par or nearly so with the sailing packets: in fact, a vessel properly constructed and rigged, may, under many circumstances, derive great benefit in the use of sails, not only in the economy of fuel, but in saving the wear and tear of the machinery.

If the *Victoria* had been fitted with engines of power only in proportion to the increased section, viz. 373 horse power, she would have the same speed and power to contend with a gale of wind as the *Medea*; and calculating the same consumption of 7 lbs. per horse power per hour, she would carry twenty-eight days' coal, and would perform a voyage of 5240 miles, without allowing for the weight saved of the engine, which would carry her 300 miles further, or 5540 miles, being a voyage of 850 miles longer than she is now able to perform. There is no doubt, however, that she is able, with her present engines, to accomplish the voyage; and if the proportion of tonnage assigned for merchandise is as much as is required, the additional power will certainly give greater security and management to the vessel. It appears, moreover, that her engines (which are building by Mr. Napier) are constructed so as to work with five pound steam more or less expansively; and as a great economy of fuel is obtained with a small diminution of speed, it is strongly advisable not to urge her, when circumstances permit, to the utmost of her speed. In voyages when the quantity of coals required does not form a large proportion of the tonnage of the

vessel, the advantages of such economy is not felt; the more particularly as passengers are chiefly what is conveyed, the competition of other vessels renders speed of such value, as to be obtained at any cost. On the contrary, with vessels destined for long voyages as that of America, the greater portion of the vessel must be devoted to coals, and the less merchandise can be carried, when it will probably form a more important consideration. The speed will be bought at greater expense, although less valuable; and when it becomes the interests of commanders to increase the capability of their vessels for distance, instead of giving them the greatest possible speed, much will be effected by the management of the working power of the engine, combined with the use of sails in the varied circumstances a vessel must have to contend with, in a voyage of such length.

The above calculations of the length of voyage, that may be performed by a vessel of large power and tonnage, are founded upon the performances of Her Majesty's ship *Medea*, which I have preferred, from this vessel being of the largest class, and from its speed, consumption of fuel, &c. being accurately recorded, but more particularly from its having been employed by Dr. Lardner as data in similar calculations; by which he appears to demonstrate the impracticability of making a longer voyage than 2000 miles.

The more recent private vessels built expressly for the purpose of making a long voyage, give results completely superior to the *Medea*, as may be seen particularly in the voyages of the Honourable East India Company's steamers *Atalanta* and *Berenice* to Bombay, by the Cape of Good Hope.

The *Atalanta* is of 630 tonnage and 210 horse power; she made the voyage from Falmouth to the Cape of Good Hope, a distance by the log of 6935 miles, having much adverse weather to contend with, in 37 days 16 hours, steaming, at an average speed of 7.67 miles per hour; her consumption of coals being 14 tons 11 cwt. per day, or at the rate of less than $6\frac{1}{2}$ lbs. per horse power per hour: she performed the voyage from Fernandez Po to the Cape of Good Hope, a distance by log of 2373 miles, in one stage in 14 days 10 hours, with a consumption of 213 tons of coals.

The *Berenice*, which is of 680 tons and 230 horse power, made the voyage from Falmouth to Fernandez Po, 4796 miles in 22 days 22 hours, or at an average rate of 8.72 miles per hour, and at an average consumption of coals of 16 tons 3 cwt. per day, or 6.56 lbs. per horse power per hour. She is able to carry 330 tons of coals, and therefore, if steaming, a distance of 4290 miles. In fact she performed the voyage from Bonavista to Fernandez Po, a distance by log of 2272 miles, and consumed less than half her cargo of coals.

The results of these voyages are indeed so favourable, as to set the question at rest as to the practicability of the American voyage: the consumption of fuel has been so reduced by the superior construction of manner of working the engines, that these vessels, although comparatively small, are enabled to perform a voyage much exceeding that to New York; and consequently the American Steam Company's vessels, whose capabilities for distance are greater in the ratio of 7 to 9, from the superior tonnage and power, must perform the voyage under any circumstances, with the greatest facility.

ON IRON STEAM BOATS.

It is necessary to mention, among the improvements which are likely to add to the capabilities of steam vessels for making long voyages, the introduction of iron as the material

of construction, the use of which has been attended with complete success, in every instance in which it has been tried. The advantages of iron vessels are stated to be, that they do not weigh one-half that of a timber sea-going vessel, and they therefore draw considerably less water, and give a greater speed with equal power; greater safety, in consequence of being divided into water-tight compartments by iron bulkheads; and greater economy, as they do not require so many repairs. The capacity is also increased for passengers and goods: a wooden vessel of 30 feet beam is only 27 feet 6 inches inside, while an iron vessel would be 29 feet 6 inches; consequently a saving of two feet is produced throughout the whole length of the vessels.

They besides possess the advantage in hot climates, of being cooler, more free from vermin, and in consequence more healthy. In fact, the advantages seem to be generally acknowledged. The only difficulty that has at present stood in the way of their employment, in sea voyages, has been the effect of the iron on the compass: and this has been successfully overcome in the late voyage of *L'Egyptien* to Alexandria; in which the compass was fixed under the direction of Professor Barlow, and has been found to work with the same accuracy as in an ordinary vessel.

We have no doubt, therefore, that iron vessels will in a short time become very general, and add greatly to the facilities and extension of steam navigation.

COMPARISON OF THE RESISTANCE OF A STEAM VESSEL WITH THAT OF A PLANE SURFACE.

The resistance of vessels being a subject which has of late much engaged the attention of engineers, we have been induced to add the following comparison of the resistance of a steam vessel with that of the paddles,—a calculation which can be arrived at with the aid of the preceding experiments and investigations with considerable accuracy.

Let V the velocity of the wheel, v that of the vessel, s its sectional area immersed, and a the area of a paddle whose action is horizontal and effect equal to the sum of all the paddles: the resistance being as the square of the velocity, $(V - v)^2 a$ will express the resistance on the paddle, and $v^2 s$ would be the resistance of the vessel if it were a plane surface; but the real resistance being $(V - v)^2 a$, the fraction of the resistance compared with a plane will be

$$\frac{(V - v)^2 a}{v^2 s}$$

The value of a has been obtained by knowing the depth of immersion, so as to ascertain the angle at which the centre of pressure entered the water, and thence the number of times the whole effective action exceeds that of the vertical paddle: this, multiplied into the area of the paddle, gives the whole surface above denoted by a .

In the following table is given the effective pressure exerted by the engines in every experiment where the dip or immersion of the paddle is given; but the comparison of the resistance of the vessel with a plane is of course limited to those experiments only in which the area of the immersed section could be ascertained.

TABLE XII.

Name of the vessel.	Tonnage.	Horse power.	Effective pressure exerted by the engine.	Velocity of the vessel, that of the wheel being 1.	Velocity of the vertical paddles through the water, that of the wheel being 1.	Area of the paddle board.		Area of a vertical paddle equal in effect to all the paddles.	Immersed sectional area of the vessel.	Ratio of the resistance of the vessel to that of a plane surface of the same section.
						Feet.	In.			
Medea	835	220	Lbs. 4536	·627	·373	19	0	54·00	263	} $\frac{1}{17}$
Flamer	491	120	2814	·683	·317	16	0	52·44	174	
Flamer	494	120	2593	·674	·326	16	0	57·60	218	
Firebrand	494	120	2472	·667	·333	12	9	38·56	200	
Firebrand	494	120	2527	·666	·334	12	9	42·00	214	
Columbia	360	100	1807	·654	·346	12	0	43·10	202	
Salamander	820	220	2150	·833	·167	22	6	398·70	359	
Dee	710	200	2531	·732	·268	20	0	69·00	209	
Firefly	550	140	3808	·733	·267	18	0	201·00	275	
Firebrand	404	140	2474	·772	·228	18	0	128·61	200	
Pluto	365	100	985	·823	·117	16	6	105·23	116	
Monarch	872	200	7167	·748	·252	20	0			
Monarch	872	200	6976	·746	·254	20	0			
Monarch	872	200	7002	·756	·244	20	0			
Magnet	360	140	3672	·763	·237	15	0			
Meteor	296	100	4320	·671	·229	13	6			
Carron	294	100	1731	·777	·323	13	6			
1.	2.	3.	4.	5.	6.	7.	8.	9.	10.	

It thus appears contrary to the results of all experiments hitherto made on the small scale, that the resistance of a well-shaped vessel does not exceed $\frac{1}{17}$ th part that of a plane of the same sectional area.

The above mean, being founded on several experiments, must be very near the truth ; although in each so much error may exist, from the want of minute attention to the number of strokes of the engine, as to afford no test of the best shaped vessel.

As, however, the results are very extraordinary, it may be well to submit them to a totally independent mode of estimation. In the above investigation, the mean number of acting paddles, with their corresponding velocities and areas, are compared with the sectional area of the vessel and its velocity ; but we might have made the calculation in another way,—that is, by comparing the force necessary to urge a plane section equal to that of the vessel with the velocity at which it passes through the water, with the actual power of the engine employed to propel the vessel,—which ought to give nearly the same fraction as the other method.

Of the whole power of the engine, we have seen that with the vertically acting paddle one-third is lost by the retrograding of the wheel : in the Medea, therefore, the power employed in propelling the vessel is two-thirds of 220 = 146 horse power : now the velocity of the vessel having been 11·33 English miles per hour, or 16·62 feet per second, the resistance in feet of water is $\frac{(16\cdot62)^2}{64\frac{1}{2}}$, and in lbs. $\frac{(16\cdot62)^2}{64\frac{1}{2}} \times 62\frac{1}{2}$, on each square foot. The number of feet in the section is 263, and the velocity in feet per minute is 997 ; the whole force, therefore, expended in a minute, is 70,796,970, which, divided by 33,000, gives 2150 horse power for the force necessary to urge a plane section of 263 feet through the water at the rate of 11·33 miles per hour : but the vessel itself is urged with that velocity by the power of 146 horses ; the resistance to a vessel is therefore to that of a plane section of the same area as

146 to 2150, or as 1 to 15 very nearly, which exactly agrees with the number given in the table. The agreement is equally close in the Flamer; and the mean obtained this way from the whole set of experiments is very nearly the same as that given in the above table.

In this calculation the actual power of the engine is assumed equal to the nominal power; but it may slightly exceed it, but the degree will not be much when the loss from the air, friction, &c., are deducted.

The valuable experiments on resistances made by the late celebrated Colonel Beaufoy, and presented to his scientific countrymen, in a truly liberal manner, by his son, Henry Beaufoy, Esq., enable us to put a third test upon the accuracy of the preceding deductions; and it is very satisfactory to be able to confirm those extraordinary results on the authority of his tables.

It has been found above, that to urge a plane section 263 feet area at the rate of 11·33 English miles, or 9·84 nautical miles, per hour, through still water, would require 2150 horse power. According to Colonel Beaufoy's results, it would require a power of 2444 horses, which would give a still less fraction than a fifteenth; but compared with a cylinder with flat ends, the number of horses power is 2275, and the fraction greater than one-sixteenth, but less than one-fifteenth,—a confirmation which one could scarcely have hoped to have obtained.

These results are deduced as below. According to Colonel Beaufoy's experiments, (Table 1. Part III.,) it requires a force of 203·79 lbs. to urge a plane of one square foot through still water at the rate of eight nautical miles per hour, or 810 feet per minute: now the *Medea* moved with a velocity of 11·33 miles per hour, or 966 feet per minute; it would therefore require, according to Colonel Beaufoy, (the resistance being as the square of the velocity,)

$$810^2 : 996^2 :: 203\cdot79 \text{ lbs.} : 308 \text{ lbs.}$$

Now the section being 263 feet, the resistance per foot 308 lbs., and the velocity 996 feet per minute,

$$\frac{308 \times 996 \times 263}{33,000} = 2444,$$

the number of horse power requisite to urge a plane section of this area at the given rate: but if, instead of a mere plane, we take Colonel Beaufoy's experiments for a cylinder with flat ends, we obtain the number of horse power 2275, as above stated.

If the results of Colonel Beaufoy's experiments had been made use of throughout the preceding investigations, the numbers in column 17. of Table II., and in column 4. of Table XII., would have been increased by about one-seventh; and in estimating the power exerted on the paddles it would have been found to exceed the nominal power of the engines,—which proves that engines work above the nominal power.

[NOTE. In the paragraph at the foot of page 51, the author of this excellent paper appears to have disregarded the inclination of the paddle-board with the radius, as far as it affects the power developed by the engine, and this will have some degree of influence on several of his results. This was suggested to the author when the sheet was in the press, and some explanatory remarks are appended at his request. If the tangential resistance to the motion of the wheel were equal to the resistance to the transmission of the vessel, the ratio of the useful to the whole effect, would be precisely that of the velocities of the vessel and wheel. But the resistance on the vessel is equal to the lateral pressure on the wheel, and the tangential force by which the engine overcomes it, as the author shows at the top of the same page,

is of less magnitude in the proportion of the cosine of the inclination (ϕ) of the radius with the vertical; so that the power employed is less than $\frac{2}{3}$ of the effective power, or, which is the same, the effective power is more than $\frac{3}{2}$ of the whole power.

To state the case in symbols, we have the pressure of the engine necessary to overcome resistance $= \cos \phi (V \cos \phi - v)^2$, as stated in pages 50 and 51; and hence the whole power employed $= \Sigma V \cos \phi (V \cos \phi - v)^2 = V \Sigma \cos \phi (V \cos \phi - v)^2$, where Σ is supposed to include the same expression for each of the paddles immersed at the same time. But the horizontal pressure on the paddles $= \Sigma (V \cos \phi - v)^2$, which being also the resistance on the vessel, the effective power is $v \Sigma (V \cos \phi - v)^2$. It therefore follows that the proportion of the effective power is,

$$\frac{\text{effective power}}{\text{whole power}} = \frac{v}{V} \cdot \frac{\Sigma (V \cos \phi - v)^2}{\Sigma \cos \phi (V \cos \phi - v)^2},$$

which is necessarily greater than $\frac{v}{V}$.

Instead of the terms under Σ , we may substitute the equivalent mean pressures for one paddle, viz. $\frac{\int d\phi (V \cos \phi - v)^2}{\phi}$, $\int \frac{d\phi \cos \phi (V \cos \phi - v)^2}{\phi}$, and then,

$$\frac{\text{effective power}}{\text{whole power}} = \frac{v}{V} \cdot \frac{\int d\phi (V \cos \phi - v)^2}{\int d\phi \cos \phi (V \cos \phi - v)^2}.$$

If we assume $v = \frac{2}{3} V$, as stated in the paragraph referred to, the proportions of effective power at the four immersions of Table III., page 52, calculated accurately in this way, come out .696, .701, .701, .690; Mr. B. gives them all .666. When the immersion of the wheel is so much as to cause $\cos \phi$ to become less than $\frac{v}{V}$, which occurs in the two latter cases, it should be particularly remarked in taking the integrals, or calculating in any way from these formulæ, that the factor $(V \cos \phi - v)^2$ should be accounted negative, as long as $V \cos \phi - v$ is so, since under such circumstances the paddle retards both the wheel and the vessel.—EDITOR.]

IV.—TIME AND TRAVERSE TABLE,

Calculated to show the advantage of sail on large SEA-GOING steam-vessels in extended voyages, masted and rigged on the principle of spreading the greatest quantity of canvas with the least possible resistance from masts and yards when steaming.

BY CAPTAIN ROBERT OLIVER, R. N.

In well proportioned steam-vessels, under steam and sail, (being capable of making a 4 point course good, and from that to $5\frac{1}{2}$ points, according to the extent and force of the sea,) the rate of speed is very considerably increased by sail, and great relief is thereby given to the engines and vessel.

It therefore becomes a consideration, when reduced to low rates under steam alone, by the resistance of wind and sea, if by the assistance of sail and consequent increase of speed a given point to windward cannot be made in equal or less time. For example, if the speed from the above causes, in a direct distance of 2300 miles, be reduced to 3 knots per hour, 767 hours will be occupied in the performance; but by making sail and a 4 point course, (thus increasing the speed to $4\frac{1}{2}$ knots,) the same position will be gained in 723 hours, running over a traverse distance of 3253 miles.

Again, should the wind enable the vessel to lay up 2 points from the direct course, at the same increase of speed, it will be accomplished in 668 hours, running over a traverse distance of 3005 miles.

Other speeds also afford relative advantages in the same manner; and with the use of the following table, they may be roughly estimated by inspection.

It being decidedly ascertained that H. M. steam-vessels of war, with wheels disconnected, can work within 11 points of the wind, making 8 knots, consequently a 6 point course becomes a free wind. When at and beyond that, the sails will frequently impel the vessel beyond her maximum engine speed, whereby the whole expenditure of fuel, wear and tear, can be saved.

These advantages are more applicable to long runs, where the wind is rarely right ahead for any considerable distance, but veers so as to enable a long line to be made on one tack or the other. For illustrations, see Plates XXVII. and XXVIII.

TRAVERSE TIME TABLE, for the purpose of showing the comparative advantage obtained with a steam-vessel when upon an oblique course and assisted with canvas, over the same vessel upon a direct course, without canvas, and with a diminished velocity.

	Distance per log run through upon the course.	Rate per hour in nautical miles.														
		3	$3\frac{1}{2}$	4	$4\frac{1}{2}$	5	$5\frac{1}{2}$	6	$6\frac{1}{2}$	7	$7\frac{1}{2}$	8	$8\frac{1}{2}$	9	$9\frac{1}{2}$	10
		Hours.														
Direct distance . . .	Miles. 2300	767	657	575	511	460	418	383	354	328	307	287	271	256	242	230
1 point from the course	2705	902	773	676	601	541	492	451	416	386	361	338	318	301	285	270
2	3005	1002	858	751	668	601	546	501	462	429	401	376	354	334	316	300
3	3190	1063	911	797	709	638	580	532	491	456	425	399	375	355	336	319
4	3253	1084	929	813	723	651	591	542	501	465	434	407	383	361	342	325
5	4140	1380	1183	1035	920	828	753	690	637	591	552	517	487	460	436	414

V.—MEMOIR OF HER MAJESTY'S STEAM SHIP THE MEDEA,

DURING A SERVICE OF NEARLY FOUR YEARS.

BY THOMAS BALDOCK, LIEUT. R.N., K.T.S.

HAVING been enabled to lay before our readers a set of plan drawings of the splendid steam ship of war *Medea*, we annex a brief memoir of facts connected with that vessel, and her performance under a variety of circumstances, which may we trust be interesting to those who take into consideration the extraordinary revolution which the steam engine is accomplishing in nautical affairs; not only in abridging time and space, and thus bringing distant nations into close communion with each other, but in its scarcely less important application, when allied to our fleets as a powerful auxiliary in war: and although the philanthropist will not view these consequences with the same complacency, that attends the contemplation of the benefits which the agency of steam confers upon mankind, yet this subject may be favourably considered, under the conviction, that the most effectual way of preserving peace, is to be prepared at all times for war. The change, therefore, which the steam engine must effect, in the tactics of naval warfare, cannot be viewed with indifference in a country whose "best bulwarks are her wooden walls."

Previous to the year 1830 the Government only possessed a few small steamers, which were principally employed for the purpose of towing ships in and out of harbour, and other trifling services on the coast, with an occasional voyage to Lisbon or Gibraltar. These vessels were built very strong; and although it became necessary, in the first instance, to employ them in the conveyance of the Mediterranean mails, on the adoption of steamers for that service, they were removed to other duty as soon as more competent vessels could be built expressly as packets.

About the year before mentioned, the Admiralty having judiciously determined to add a small squadron of steam cruizers to the navy, gave directions for the construction of a steam ship of war, at each of the king's dockyards,—the form, scantling, and internal arrangements, being left in a great measure to the judgment and skill of the master shipwright of the yard at which each vessel was designed and built; well considering, that although many private steamers then existed, even of the size suitable for war purposes, which vessels, from the ex-

cellence of their performance, appeared to realize the perfection of what we may call the art of steam navigation in its then state of advancement, yet that the necessary qualifications for an armed ship of any sort, particularly for distant cruising and extended voyages, with a powerful armament and large crew, differed so essentially from those of a merchant vessel, as to render it extremely dangerous to follow without variation even the most approved plan of any commercial steamers, whose sole object was the conveyance of passengers and cargo on coasting voyages, never at that time extending beyond four or five hundred miles, and throughout the whole of which route, they generally had some port of refuge, to which they might have recourse, either in extremely bad weather, or for a supply of fuel if necessary.

In carrying into effect this plan of building a few war steamers, it became important that they should be so constructed as to be able to cruize, and make long passages under sail alone; it being obvious that if a war steamer is to be dependent on the power of her engines for every movement, she will in all probability exhaust her resources, before arrival at her scene of action. To accomplish this end, therefore, became of vital importance, and it was considered unavailing for them to possess good steaming qualities, without they were in all respects quite competent to act as sailing ships of war.

Although it is unnecessary to state here all the particulars in which the construction of ships of war differs from that of merchant vessels, there are some important features which so much affect steamers, and have so great an influence on their character as such for velocity, when competing with passenger vessels or packets, that we deem it necessary to advert to them here.

The war steamers being armed with the heaviest description of guns, one of which, weighing, together with its carriage, more than six tons, is placed at each extremity of the vessel, with others of somewhat less weight on the sides, it becomes necessary to afford the proper support, not only when steaming in an upright position, with the centre of gravity of the displacement in the plane of the keel, but perhaps engaging when under sail, with a considerable inclination, and the whole weight of ordnance probably on the lee or depressed side. It is necessary, we say, from these considerations, and others connected with the ponderous appurtenances of war ships, among which may also be named the additional number and weight of the anchors, which are always carried on the ship's side, that all the superstructure, or the whole fabric above the water, should be very much stronger, and therefore heavier, than is required in any steam vessel carrying passengers, or even a heavy description of cargo, which being always stowed below, admits of the upper works being slight. It is also indispensable that the war vessel should have a high and strong bulwark or "berthing," to afford shelter to the crew in time of action: and, above all, it is necessary that the form of the ship should vary considerably from that most calculated to insure velocity, when, as in the case of steamers, it is derived from a self-contained motor, instead of being dependent on the influence of the wind, on sails attached to the lofty and weighty masts, &c. of a sailing vessel, the oblique action of which in most instances tends as much to depress the ship, as to propel her on the line of keel. Thus, any vessel intended to act either as a sailing ship or steamer, must, to insure her being a good sea boat, have greater stability, and more breadth of beam, than is required for one

dependent entirely upon the engines. It is scarcely necessary to add the conclusions to which this argument leads, or to state that these important essentials must considerably diminish the steaming speed of a war steamer.

We should not have thought it requisite here to refer to these peculiarities of construction, were it not for the many aspersions which have been cast upon what we may presume to call the architectural qualities of the Government steam marine, by those who apparently have never taken into account the matter to which we have alluded, and who have generally been in the habit of estimating the qualities of steamers entirely from the rate at which they would, in an upright position, be propelled by the engines,—omitting in a great degree the consideration, that the sharp narrow vessels in which the greatest steaming speed is obtained, are not well adapted for general ocean navigation, and that although they may succeed for a long time in making favourable passages, they must, in the event of any failure of the engine, or the supply of coals in a gale of wind, become unmanageable logs on the water. We need not advert to facts in verification of this opinion, which must be allowed by all seamen; though we are quite prepared to prove that the case to which we have just adverted, has occurred to some of the best and fastest commercial steam vessels, and yet to admit that they have been and are likely to be of rare occurrence, as in such vessels the engines are examined, and, if necessary, refitted at the termination of every passage they make; and thus incipient defects are checked or remedied, and their frequent access to a depôt for coal renders the failure of fuel improbable. Thus their plan of construction may be proper for the service to be performed, however unfit it is for steam ships of war.

In pursuance of the Admiralty arrangement to which we have referred, the *Dee*, *Phœnix*, *Salamander*, *Rhadamanthus*, and *Medea*, were constructed. The first-named four vessels appear to have answered well; but there is no doubt that the *Medea*, designed and built by Mr. Lang of Woolwich dockyard, is the most perfect of this flotilla, not only having evinced admirable qualities when impelled by steam, (under which circumstances she is equal to the best sea-going steamers,) but shown her capability under sail, to keep company with any squadron of Her Majesty's ships, either in blockading an enemy's port or making a passage across the ocean,—being thus enabled to convey her energies unimpaired to the most distant part of the world, and always ready to put forth that giant force, which the agency of steam affords, when occasion may require it.

Few seamen would believe, when looking at a steamer, with her lumbering paddle-boxes, wheels, and apparently jury-rigging, that this can be the case. We have, however, ample proof, that the *Medea* has, under sail alone, with the wheels revolving loosely in the water, beat several of our best ships of war.

The *Medea* fell under the control of an officer (commander, H. Austen) whose talent and perseverance have rendered evident all those good qualities of the ship, which under less able management might not have been so obvious; and has proved, that the naval superiority this country so justly boasts, is not likely to suffer either in the construction or tactics of our steam marine.

This ship was launched at Woolwich in September, 1833, and immediately fitted with two engines of 110 horse power each, by Messrs. Maudslay and Field, who had supplied those

to the other four war steamers, and who had succeeded by their adaption of boilers, &c. in producing the best possible effects with the least proportion of fuel then known; the wheels being according to the plan of Mr. Morgan, with the revolving vertically acting paddle, of which a full description is given in another part of this work.

The masts, sails, and rigging, as well as the internal fittings, were principally proportioned by the constructor, assisted by such modifications as the skill and experience of Capt. Austen, and Mr. Peacock, the able master of the vessel, suggested. It will not be uninteresting to our nautical readers to state, that the *Medea* has three masts,—the foremast being rigged nearly as that of a brigantine; the mainmast and mizenmast having each a lower gaff-sail and gaff-topsail; the arrangement of the standing and running rigging being so adapted, that the upper masts, yards, &c., may be lowered to the deck with the greatest facility, and again reinstated with little labour,—thus affording the least possible resistance when steaming head to wind, and yet spreading a large quantity of canvas, when under sail, and all the gear in its place.

The armament consists of two guns of great calibre, capable of carrying heavy shot further than the range of the largest guns in use in sailing ships of war, and also calculated to throw shells: besides these heavy pieces of ordnance, which are mounted on pivots, one before the foremast, and the other abaft the mizenmast, she has less guns of considerable weight, intended to be “transported” about the deck as occasion may require, with a full proportion of small arms for a crew of 120 men, for the purpose of repelling boarders, should unforeseen and improbable circumstances place her in close contact with a heavy vessel of war,—the obvious tactics of a war steamer being to keep out of range of an enemy's guns, which she may always do by maintaining a position in the wind's eye of an opponent, and assailing her adversary with very little chance of receiving any damage in return,—a good steamer having no difficulty in keeping to windward of the best sailing ships, even in strong winds: and it is quite evident that in a calm the steam vessel may take any position she pleases.

By the seaman this will be well understood and admitted; but we may be excused in digressing to inform those less acquainted with nautical affairs, that, during the late wars, particularly in the Baltic and Straits of Gibraltar, much serious damage was done to some of our largest ships of war by the attacks of gun-boats during calms; and the writer of this article was once in a corvette, mounting eighteen guns, that was assailed, in a moderate breeze, by a small schooner with only one long gun, which vessel being enabled by her superior sailing to keep out of range of the corvette's carronades, maintained for some hours a most destructive action, in which the latter lost a lieutenant and twelve seamen, without having the power of inflicting the slightest punishment on her pigmy and audacious opponent.

Previous to entering into any particulars connected with the performance of the *Medea*, we shall give the dimensions of the ship and engines, together with the immersion or draught of water, the proportion of fuel carried and consumed in given times and distances, and such other facts as appear to have reference thereto.

Expence in money, (English prices,) of coals and engine stores, (say tallow, &c.)	£.	s.	d.
			24 hours' steaming 16 12
„ „ „ „ „ „			per mile, about . 1 7½
„ „ (Malta prices,)¹			24 hours . . 24 10
„ „ „ „ „ „			per mile, about . 2 4¾
Rate of steaming, with 320 tons of coal and war equipment on board, in a calm, 8¾ knots per hour.			
„ „ when lightened by the expenditure of one-third the fuel	9¼	„	„
„ „ „ „ of two-thirds „	10	„	„
She will therefore go at 8½ knots an hour about	1190		
„ „ at 9 knots an hour „	1258		
„ „ at 10 knots an hour „	1360		

Thus accomplishing the distance of 3808 knots, or geographical miles.

Each rate being attained by a gradual progression, as the ship lightens from the expenditure of coals, and as the latter part of the distance may be at a speed even above ten knots ; some addition should be made to the gross amount above stated : it must however be observed, that the experiments from which the foregoing data are taken, were all made in calm weather ; but, as the consumption of fuel is by a judicious arrangement of the dampers, and by slackening the fires, considerably lessened as the speed is diminished from the violence of the wind or sea, we may safely state, that the Medea is competent to undertake any voyage of at least 3000 miles, except a westerly passage across the North Atlantic in the winter season ; at which period of the year the ocean between England and America is swept with scarce an intermission by violent westerly gales, creating waves which, even supposing the temporary cessation of the wind, must oppose an effectual barrier to the favourable operations of any steamer. We by no means presume to state that the voyage cannot be made, or these difficulties safely overcome, by a powerful vessel with a large supply of fuel ; but her progress at times must be very slow ; and though, no doubt, in such a case she might cross the Atlantic in much less time than a sailing ship under similar circumstances, it would be at a speed far below the usual rate of steaming voyages.

It is proper to state, with reference to the coal carried by the Medea, that the weight of the armament and war *materiel* is quite equal to 50 tons, and consequently, that if disarmed, she could carry fuel without being further immersed in the water, or her progress thereby impeded, sufficient for a voyage the extent of which may be at least 500 miles more than the distance before stated : she might therefore be sent to the West Indies with despatches, or even troops, at a few hours' notice, almost with a certainty of reaching Barbadoes, or any other of the windward islands, in nineteen, or at most twenty, days, under the average circumstances of weather usually experienced in that voyage.

Speed of the Medea with the wheels detached from the engine, and revolving by the reaction of the water as the ship is impelled by the influence of the wind on her sails.

Blowing strong, smooth water, close hauled "within" 6 points	8¼ knots
Blowing strong wind on the quarter	11¼ „

¹ Including cost of conveyance to, and stoppage at, Malta.

Before entering into any particulars of this vessel's service, from the time she was first commissioned in February, 1834, until she was dismantled in October, 1837, we think it important to state, that during the three years of this time which were spent in the Mediterranean, neither the engines nor boilers underwent any other repairs than such slight work as was effected by the engineers of the ship, without any extraneous assistance whatever: and moreover, that on her being paid off, as before referred to, (having been in commission rather a longer time than is usual for ships of war in peace,) the machinery and boilers were found in such excellent condition as to require very little refitting,—a circumstance not less creditable to the original constructors than to the engineers on board, and to the able system and management of the commander and officers, who thus maintained the vessel on a distant station for a long space of time always ready, and frequently performing important services, though left entirely to their own resources.

During the early part and summer of 1834, she was principally employed on various duties on the coast of England, and in performing one voyage to Bilboa and Corunna. On the 5th of October of that year the *Medea* left Plymouth to join the squadron in the Levant, and accomplished the voyage out to Malta in ten days and five hours, the wind being generally contrary during the passage, and for two days having to contend against a fresh gale ahead, —the other eight days being for the most part moderate. On this occasion five hours were lost by a stoppage to effect certain adjustments in the engines and boilers, and two hours from circumstances unconnected with the engines or vessel. The distance of 2100 miles from Plymouth to Malta was thus effected at the average rate of 8·82 geographical miles per hour, under circumstances by no means favourable, the ship having coals enough on board at the termination of this run for a voyage of 1000 miles additional; fully corroborating the statement we have before made, of her ability, with a full armament on board, to steam at least 3000 miles under ordinary circumstances without any additional supply of fuel.

After completing the coal at Malta, the *Medea* proceeded to join the fleet under Sir Josias Rowley, then assembled at Vourla Bay, in the neighbourhood of Smyrna, and at once took her place as a cruising ship in the squadron, performing under sail all the evolutions usual to ships of war, either when proceeding from place to place, or cruising, and maintaining a position as in front of an enemy's port. To effect this object, and yet to enable the vessel to resume her service as a steamer at short notice, it became necessary that the engineers and their assistants should be well exercised in the duty of connecting, and detaching the paddle-shaft, in order that the wheels should be free to revolve when the ship was under the influence of sail alone, and speedily re-attached if necessary. The particular arrangement by which the cranks are united to the machinery in the engines constructed by Messrs. Maudslay and Field, rendered this operation more facile than where a different modification is adapted; and after some practice on board the *Medea*, it was found, that the wheels could be detached under favourable circumstances in five minutes, and united again to the engines in a scarcely longer time.

We should however observe, with reference to this part of our subject, that the wheels with the paddle-boards in place, must tend in a great degree, in light winds particularly, to lessen the speed at which the vessel would attain under canvas, if the boards were displaced, besides effecting the concomitant evil of considerable wear, and consequent deterioration,

more especially to the machinery of the vertical paddle; and although the experiment of this vessel fully proved, that the resistance which the paddle-boards afforded, did not prevent her from keeping company with the squadron, and, in some instances beating them, yet it is evident, in making long passages under sail, that it is desirable at least the lower float boards should be removed; and we have the authority of Captain Ramsay,¹ late commanding Her Majesty's steam vessel *Dee*, (which vessel is fitted with the old radial wheel,) for stating, that "in common weather the paddle-boards could be shipped in about an hour, and unshipped or detached in half that time." It was found in the *Dee* that under canvas, with the paddle-boards removed, her best point of sailing, as compared with other ships, was during light winds; whereas in the case of the *Medea*, with the boards in place, the velocity of the ship in very light airs, being insufficient to overcome the friction of the wheels, they did not revolve, and consequently in most such instances, she was in the rear of the squadron.

We have no reason to believe, that the floats of Mr. Morgan's vertically acting paddle require a very much longer time for removal, than those of the old construction; although it is proper to observe, that, if removed, the heavy iron work composing the revolving apparatus would oppose a greater resistance to the ship's progress, than the naked framing of the radial wheel. Still as the *Medea's* disparity of rate was so small with the boards in place, it is most probable that if they had been removed, she would have been quite as equal to sailing ships in light airs, as she evidently was, (even with their obstruction,) in fresh winds. And as the steam could never be raised from cold water in so short a time as that stated by Captain Ramsay, to be occupied in unshipping the paddle-boards, we might from these premises come to the conclusion, that in all cases when a steam vessel is required to act under sail, the paddles ought to be removed. We are, however, very doubtful, that it would be proper to establish this as a general rule under all circumstances, particularly when the service of the ship is such that she may be required, at the shortest possible notice, to resume her steaming duties. It must be quite obvious to the seaman, that cases may occur in which it would be extremely difficult, if not absolutely impossible, to re-attach the boards; and whenever the ship has any considerable motion from the waves, it must always be done at some degree of risk to the men employed on the duty; whereas, under similar circumstances, the wheels can always be connected with the engine, in less time than would be occupied in getting up the steam.

As the vertical paddle is more effectual in propelling, so also it does not offer so much resistance when revolving freely in the water, being easily set in motion when the ship's movement, under the influence of the wind, opposes its surface to the fluid. As the advantages, therefore, of detaching the boards from these wheels, is less than in the old ones, and the difficulties of doing so (though in a very slight degree) greater,² the propriety of their removal in all cases becomes more doubtful; and we are quite sure that the plan would

¹ Vide Nautical Magazine, Jan. 1838, page 49.

² Captain Ramsay states, in the paper above referred to, that "the *Medea*, having Morgan's wheels, the removal of the paddle-boards was almost out of the question, as the iron work left would have produced nearly as much resistance." We are induced to attribute his objection as much to the difficulty he conceives attendant on their removal, as to the resistance the iron work affords; it being quite evident, that as the iron work cannot obstruct the

have been adopted in the *Medea*, had its benefits been commensurate with the inconvenience.

The first trial of sailing after the *Medea* joined the squadron was on the 3rd of November, in company with Her Majesty's ships *Scout*, *Childers*, and *Columbine*. These vessels being ordered on some detached service, it was considered a good opportunity, as the wind blew directly into the Bay of Smyrna, for the steamer to test her qualities of "beating" to windward with such fast-sailing ships; and we accordingly find that, although labouring under all the disadvantages of a first experiment, which the seamen will not fully appreciate, she was, with wheels revolving loosely in the water, nearly equal to both the first-named vessels, and only beaten in any very decided degree by the *Columbine*, built by Sir William Symonds, the present Surveyor of the Navy. Having gained the outside of the bay, the ships proceeded towards their destination, and the *Medea* remained for some hours exercising the crew, in performing the evolution of "tacking," and in developing such modifications as might be applicable in the performance of her duties as a sailing ship of war, of which she had hitherto had no practice. It was ascertained that, with the moderate breeze then blowing, she made nearly a straight course at five points from the wind, and meeting with two Greek polaccas, well known to be fast vessels, she joined company, beat them both "on a wind," and returned to the anchorage at Vourla.

Several trials of sailing were afterwards made in company with the squadron, and on the 20th of November and 16th of December the *Medea* beat through the narrow entrance of Smyrna harbour, against a strong wind in both cases; in the first instance alone, and on the second occasion, in company with Her Majesty's ships *Beacon* and *Mastiff*, both of which she considerably outsailed, and "weathered" upon.

On the 8th of January, 1835, the whole squadron left Vourla, and gained the open sea by "tacking" out of the bay, and on that day the following entry appears in the steamer's log-book:—"Tacked occasionally—find we both 'weather' and 'fore-reach' on every ship in the squadron," the wind at the time being moderate. During the passage to Malta it was thought necessary, in order to preserve her exact position in the order of sailing, in light winds particularly, to use the steam from one boiler, with one wheel occasionally. The connecting and disconnecting of the paddle-shaft with the machinery occupied in no instance more than twenty minutes, and on some occasions as little as five; the expense of coal when at work being somewhat less than three bushels an hour, and while the fires were "banked up," (*i. e.* sufficient fire retained under the boiler to keep the water nearly at boiling heat, ready to generate steam at short notice,) half a bushel per hour sufficed. The whole quantity of coals expended during this voyage of eleven days was sixteen tons, about one-third of which quantity was used in keeping the water warm while the steam was not in operation.

ship's progress, so much as the boards would do, their being displaced must therefore, to a certain extent, be beneficial; yet it is but fair to state, on the authority of Mr. Morgan, that "it will occupy about the same time for the removal of each board from the patent wheel, as the common one; and as the patent wheel has fewer paddles, they can of course be sooner removed." To the above we may add the opinion of Captain Austen: "The radius rods and principal working machinery of Morgan's wheel may be displaced or reinstated with great ease;" in which case the bare skeleton would afford less resistance than the naked framing of the common wheel.

It was found that in adopting this clever expedient of working only one wheel with such an insignificant expenditure of fuel, very little inclination of the helm was required to preserve the line of the ship's course. In steady breezes on this passage she frequently, under sail alone, beat the large ships "on a wind;" and during a moderate gale on the "quarter," without any assistance from the steam, she averaged ten knots for twenty-four successive hours, the only vessel having an advantage over her being the Columbine, which ship out-sailed her in a slight degree. On arriving near Malta on the 18th of January, the fleet were becalmed about ten or twelve miles from the port, when the Medea, having "got the steam up," took the ships successively in tow and brought them into the harbour, towing the Caledonia at the rate of three and a half, and the two-decked ships four miles an hour, the speed being much impeded by a heavy north-west swell. We may here state that in a calm, with smooth water, the Medea could tow a line-of-battle ship at the rate of six miles an hour; but the influence of the slightest wave on the hull of a large ship caused a more than corresponding diminution of progress.

The squadron now remained at Malta until the 8th of February, when intelligence arrived from the Levant of such a nature as to render it expedient that the fleet should forthwith proceed to sea. The wind, which had been violent from the north-east, was still blowing freshly up the harbour, and the heavy swell, which, rolling in from the Mediterranean, spread over the whole surface of the narrow entrance, rendered it impracticable for the ships to "beat" through. Thus if an enemy's force had been outside the port, it would have been impossible for the most able officer or skilful tactician to have suggested any means by which the British fleet could have been extricated from their land-locked position, and they must of necessity have been idle spectators of any devastation, which a squadron, possibly of inferior force, might have been committing outside the harbour. Here then an important case occurred, in which was to be proved how far the agency of steam would be effectual, in rendering assistance to large ships of war under some of those peculiar circumstances, to which, by casualties, or the nature of their service, they are not unfrequently exposed.

It was nothing new for steam-vessels to tow ships in and out of port under ordinary circumstances, and most naval officers had contemplated the advantages that a fleet would derive in a general action, from the co-operation of a few steamers; still it was doubtful if it would be possible to tow a first-rate ship against any considerable force of wind and wave, or that it would have been in the power of any steam-vessels to have prevented the calamitous wrecks which occurred after the battle of Trafalgar. The facts, however, we have now to state fully prove that, had three or four such ships as the Medea been attached to Lord Nelson's fleet, most of those prizes which in their dismantled state were either wrecked in the neighbourhood of Cadiz, or recaptured by drifting within its bay, would have reached a British port as proud trophies of that eventful day. All required was the removal of the disabled hulks to such a distance from the land as to place them in safety during a temporary refitment, and to afford time for rigging jury-masts, &c.; which service might therefore have been effectually rendered to three or four ships successively, by one steamer.

In thus referring to the co-operation of steam-vessels in a sea-fight, we have supposed them to be kept aloof during the action, prepared only to give assistance afterwards, either by securing prizes or rendering aid to disabled ships; but the history of our naval warfare affords many instances in which the presence of a few steamers might have changed the whole tide

of battle,—for instance in light winds, as in the action of Trafalgar,—by bringing up the sternmost vessels of the fleet, or afterwards, during the continuance of the engagement, removing a disabled ship from a perilous position. Thus had a steamer been lashed alongside the Prince, of 98 guns, she might have been brought up to the fight, in which she could, from the lightness of the wind, unfortunately take but little part; and the same facility being rendered to the other sternmost ships, they might, in a greater degree, have participated in that glorious day, whilst the steamer, being sheltered by the larger hull of a line-of-battle ship, would have been in little danger. The statement we have thus made, however, includes but a small portion of the beneficial co-operation of steam power in such instances; and it would be foreign to our purpose to enter upon the subject at large; although we are induced to allude to the case of the Belleisle and Bellerophon in that great sea-fight, particularly the former vessel, which, after she was dismasted, lay an unmanageable log upon the water, for some time exposed to the attack of four ships, each her superior in force; and though, in the service of extricating this ship from the position in which she was so nobly defended, the steamer would have been in a situation of greater peril, yet the intrepidity of British seamen would not have failed to accomplish it.

The squadron, assembled at Malta on the 8th of February, and which it was deemed necessary should at once proceed to sea, consisted of one first-rate and five eighty-gun ships. The Medea, having been rapidly prepared and the steam “raised,” was attached to the Caledonia of 120 guns, and the ship cast loose from her moorings: the sea at this time was beating nearly over the turreted battlements of St. Elmo, and throwing its spray into the opposite fortress of Ricassoli; while further up the harbour the half-spent surge rolled into the embrasures of the low batteries of St. Angelo, causing the ships to ride uneasy even at their secure and sheltered moorings. Expectation was raised to its highest pitch, and the enthusiastic population of La Valette flocked to its ramparts as they were wont to do, when, in the olden time, the proud soldiers of the Cross proceeded forth in their galleys, arrayed in all the panoply of war, to chastise the marauding infidel. Many were the doubts raised as to the possibility of the Medea towing this immense fabric against the fresh wind and beating sea which opposed her egress, particularly when, on reaching the narrow part of the entrance, the Caledonia was seen to pitch heavily, as she encountered the full force of the wave, which rolled in from the open Mediterranean. Still they kept on at a rate never less than two miles and a half an hour; and in seventy minutes from the time that this heavy vessel was loosened from her moorings, the steamer cast off, and, having thus left her sufficiently distant from the land to be safely navigated under sail, returned into harbour for another ship. In this manner all the fleet were taken out, the whole being effected in four hours and ten minutes, after which the fires were extinguished on board the Medea, and she pursued her course as a sailing vessel in company with the squadron; the whole cost of coals and other engine stores expended on this occasion amounting only to £3. 6s.¹

¹ Although it is not our purpose to give a history of the Government steam marine, we are induced to record another instance in which the efficiency of an Admiralty steamer was fully tested.

In March, 1832, on the first alarm of cholera in this country, the transport-ship, William Forbes, of 600 tons, left the river with convicts to proceed to New South Wales, and put into Plymouth Sound, in consequence of some cases of

The ships now proceeded towards Vourla, where they arrived on the 14th of February, the steam not being used on board the Medea during the passage, she having sailed 186 miles in one day, for 19 hours of which a straight course was made within 6 points from the wind.

It is worthy of observation, that on the crew becoming expert in "working" the ship, and as the various modifications incidental to her new character as a sailing ship were adopted by the skill of the commander and officers, she improved in all points; and thus we find, on this, her second passage of any length with the sailing ships, it was not found necessary to light the fires at all, although they met with every variety of weather from a calm to near a gale, and contrary as well as fair winds were experienced.

During the return voyage with the admiral to Malta, which occupied from the 7th to the 20th of March, an attempt was made to navigate the ship with the lower paddles removed, without unconnecting the shaft; and in light winds some advantage was perceptible. They were, however, re-attached before the end of the passage, and the wheels allowed to revolve as heretofore.

On the 12th of May the fleet again left Malta and proceeded to Salamis. During the light winds that occurred on this route, the Medea was not able to keep up with the sailing ships, and at times lost sight of them, the "way" of the vessel being insufficient in several instances, from the faintness of the wind, to cause the revolution of the wheels. On this occasion, as also on many others, she went to sea with her full complement of coals and stores on board, and was consequently much immersed in the water, which would considerably influence her sailing qualities, particularly in light winds. It appears that her best sailing trim was, (as in the trial of the 6th July, 1837, to which we shall afterwards refer,) when about 100 tons short; and if we consider how easily this or even a much larger quantity of coals would, without inconvenience, be carried in bags distributed among the large ships of a squadron, it will hardly be said she is unable to accompany a fleet on distant service without using steam. Thus, for instance, she certainly might have attended Lord Nelson on his celebrated chase to

that epidemic appearing on board. Immediately on the arrival of the ship being known, she was ordered by the authorities to proceed to the lazaretto either at Standgate Creek or Milford, it being contrary to law, for any vessel having a malignant disease on board, to remain in a port unprovided with such an establishment. The wind was blowing so strong from the south-west, and causing such a high sea, that it was impossible for the ship to "beat" out of the Sound for the purpose of proceeding to either of the above-mentioned places; but the inhabitants of the town and neighbourhood were so much alarmed that the port-admiral was requested to afford a steamer, in order that, if possible, she might be towed to sea, though the force of the wind and waves rendered the experiment extremely doubtful. The only government steam-vessel at that time in Plymouth harbour was the Firebrand, a new Mediterranean packet; and although this vessel was at the time undergoing some refitment at the dock-yard, the case was considered of such importance, that she was immediately prepared for service, the fires were lighted, and in a very short time she was anchored in the Sound about half a cables' length a-head of the transport's buoy, the sea at that time making a fair breach over the bows of the latter vessel. The steamer having been veered tolerably near to the ship, proper ropes were attached, and the paddles being set in motion, she was thus assisted up to her anchor; both vessels weighed at the same time, and though the progress was at first so slow that near an hour elapsed before the breakwater was passed, yet in little more than four hours the ship was towed a sufficient distance from the land to enable her to prosecute her voyage under sail alone, and the steamer returned into port. It is proper to state that the Firebrand is a vessel of 550 tons, and had at that time engines of only 140 horse power, constructed by the Butterly Company, and was then fitted with the old radial wheel, which is certainly not so well adapted for towing ships as the vertically-acting paddle invented by Mr. Morgan.

and from the West Indies without occasioning any delay, and would always have been ready, at short notice, to have been detached to the distance of at least 3000 miles, and have required only an hour and a half's preparation, to render her powerful assistance on the day of battle.

On the 28th of May the *Medea* went into the Piræus, received the King of Greece on board, and conveyed him to the French, Russian, and English squadrons, then at anchor in the Gulf of Salamis, returned with his Majesty to the Piræus, and again rejoined the admiral, with whom and the rest of the ships she proceeded on the 6th of June to Naussa, in the island of Paros; and on this occasion beat most of the squadron.

After cruising for about a month in the Archipelago and visiting many of the islands, the steamer was detached on the 1st of July to Zante, with despatches. When the signal was made to the *Medea*, at 5h. 30m. P.M., "prepare to steam," she was carrying a press of sail going eight knots. The fires were lighted, and the ship still kept on her course until 6h. 55m., when she was hove-to, the wheels connected in 17 minutes, and the engine "put on" at full power. Here, then, is an instance fully corroborating what we have before said of this war steamer's ability to keep company under sail with a fleet proceeding to distant service, and of the short notice required to make her steaming qualities available. We find the weather stated as "fresh winds and squally;" therefore, as the situation of the ship was such that she had no shelter from the land, she was exposed to the full force of the waves, which a wind that would drive the whole squadron, as well as herself, eight knots an hour, must occasion; proving that the shaft could in the worst of weather always be connected with the machinery in far less time than would be required to "get the steam up:" as we find in the foregoing case, the course was continued under sail for 1 hour and 25 minutes after lighting the fires, and they were only hove-to for 17 minutes.

After leaving Zante, the *Medea*, under sail, rejoined the admiral on the 7th of July, at the gulf of Kalamata in the Morea, and started for Malta on the following day with the fleet in company. On the 10th of July the wind being very light, this vessel, still without steam, beat the whole squadron in an extraordinary degree, which (to use the words of the log-book) "is accounted for by the *Medea* not feeling the short 'swell' in the same proportion of disadvantage as the shorter and heavier vessels." We are, however, inclined to attribute this success in some degree to her being without her usual full quantity of coals, as the resistance which the paddles afforded in light winds must greatly have impeded her progress. Still the fact is most extraordinary; and as she had upwards of 200 tons of coal on board, it cannot be said that her efficiency as a steamer was in any considerable degree impaired by her being thus rendered more perfect as a sailing vessel.

We next find the *Medea* visiting the Ionian Islands, and cruising for nearly two months under sail with the fleet in the neighbouring seas and on the coast of the Morea: in all the various evolutions incidental thereto, she acquitted herself well.

On the 10th of October the squadron proceeded on their return to Malta, and encountered during a considerable part of the passage from Cephalonia strong contrary winds. The first day the steamer under canvass "fore-reached" and "weathered" so much upon the whole of the ships, that towards the evening it was judged necessary to shorten sail in order to keep company with the Admiral. Still, however, the means that were thus taken to ensure

her remaining with the fleet did not prevent her outsailing them in the night, and the next morning they were out of sight. The vessel now prosecuted her voyage alone, and reached Malta on the 14th, two days before the rest of the ships. We have said that the wind was strong and contrary during a considerable part of the route: the fact is therefore extraordinary that a steamer should thus, under sail, with paddles revolving loosely in the water, beat a fleet of good sailing ships of war two days out of a passage of only six, over a distance of little more than 300 miles; and although from her light draught of water the former had a slight advantage in being able to "tack" closer into the Italian shore than the large vessels would venture, yet in the open sea, on which the greater part of the voyage was made, this was against her; and the performance is altogether so extraordinary that nothing short of the testimony before us would give it the character of truth. Nor can the success of the *Medea* be attributed to her having got into a different vein of wind than that encountered by the squadron, as we find, on the first day, the steamer shortened sail to keep company, and only lost sight of the ships by her superior sailing on a dark night. It is fair to add, that on this occasion she had not above 150 tons of coal on board, which, however, was sufficient to work the engine for eight days, and might have carried her over 1600 miles of a steaming voyage.

We now proceed to give an account of the most interesting cruize performed by this ship during her services in the Mediterranean.

The king of Bavaria, having contemplated a visit to his son Otho, who occupied the throne of Greece, and had recently removed the seat of government from Nauplia de Romania to Athens, requested fit means of transport on board an English vessel of war from Ancona to the shores of Attica. In order to show as much honour as possible to the father of the young sovereign, whom the British power had been so mainly instrumental in raising to his eminent yet difficult position, the *Portland*, of 52 guns, was directed to proceed to the coast of Italy to receive the King on board, and the *Medea* was ordered to the same destination to attend the frigate in the performance of this service.

The *Portland*, being at Corfú, received the directions of the Admiralty, by an over-land despatch, sufficiently early to enable her to leave that island two days before the *Medea* could proceed from Malta, to which place her orders were conveyed by steam-packet from England, yet, although the voyage was of double length, she reached Ancona three days before the frigate, having steamed the whole distance against a continued contrary wind at the rate of eight miles an hour. The King of Bavaria at once determined on making the passage in the steamer; but being aware that the *Portland* had been despatched on purpose to receive him, awaited her arrival, and on the evening of the 3rd of December embarked on board that ship, thus affording a better opportunity for a display of the pomp and ceremony usual on such occasions. The *Medea*, having taken the frigate in tow, proceeded out of the harbour, and immediately both ships were clear of the land the King removed into the steamer, which then prosecuted her voyage alone.

The mild autumnal weather which so frequently prevails in the Levant, then shed its influence over the whole of that region, and scarce a ripple disturbed the surface of the Adriatic or *Ægean* seas.

The first and second night, and also the intermediate day, were passed on the broad waters

of the Adriatic, with an occasional glimpse of the coasts of Italy and Dalmatia on either side, as the steamer gallantly pursued her rapid course towards the Acroceraunian promontory, the thunder-riven mount of ancient lore, which, like another Calpe, projects its bold front into the wave between the Adriatic and Ionian seas.

“ Morn dawns, and with it stern Albania’s hills,”

and at noon on the 5th of December the ship entered the narrow strait between the ancient cities of Buthrotum and Cassiopea, and passed into that magnificent sheet of water, which, like some great inland sea, extends in a south direction for more than thirty miles, bounded to the west by the contiguous islands of Corfú and Paxo, and opposite by the Albanian hills, indented all around by many a fair and tranquil bay, fringed on the Ionian side with olives and the clustering grape; while, on the more rugged coasts of the main land, “dark Suli’s rocks,” the mountains rise abruptly from the sea-shore towards the summits of the Pindean range, which, clothed in the snow of ages, terminate the prospect eastward.

The *Medea* glided over these placid waters at a rate never less than ten miles an hour, and shortly arrived in front of the sea-girt fortress and town of Parga. The dark and bitter Acheron, “bleak Pindus and Acherusia’s lake,” were next passed; and another hour’s steaming brought the ship in front of the Ambracian estuary.

Pursuing their rapid course, and passing between Ithaca and Cephalonia, in front of the Corinthian Gulf, the vessel skirted the fair and fertile coasts of Zante; and early on the 5th of December entered the harbour of Navarino. Having made a circuit of its bay among the wrecks, which still remain as sad mementos of the Moslem’s fate, she pursued her navigation close to the Morea, reached the promontory of St. Angelo, and entered the Ægean sea. The passage to the Isles of Hydra was soon effected, and the next morning’s dawn showed them “Colonna’s neighbouring height,” Egina, Hymettus, and the shores of Attica; and in eighty-two hours from the time of leaving Ancona, they were safely anchored in the Piræus; having thus accomplished the distance of 760 miles at an average rate of nine and a quarter geographical miles per hour.

We have already digressed too much to admit of our tracing, however briefly, the various cruizes and excursions made by the *Medea* with the royal guest on board, during the four months she remained in attendance on the King of Bavaria: it will suffice to say, that they visited most of the places of note on the coast of Asia Minor, and nearly all the Grecian islands in the Archipelago, having, from the time King Louis first embarked at Ancona on the 3rd of December, until he ultimately arrived at the same place on the 31st of March, 1836, gone over a distance of 3000 miles, at an average rate of more than nine knots an hour, though the wind in many cases was strong and contrary; indeed we have the authority of Mr. Peacock, the master of the *Medea*, for stating, that “during the last cruize, which lasted fifteen days the *Medea* averaged ten knots an hour the whole cruize, though strong head winds were experienced most of the time.”¹ We presume, however, she had but few coals on board, and was consequently in better trim than when complete; such, however, was not the case on the passage from Ancona, which, as before stated, was at the rate of nine and a quarter miles an hour.

¹ Nautical Magazine, page 305. May, 1836.

After landing King Louis of Bavaria, the *Medea* returned to the Piræus, and on the 10th of May received the king of Greece on board, to convey him to Ancona, where His Majesty proceeded to meet his bride, and ultimately returned to Athens in H. M. S. *Portland*.

In prosecuting this voyage the *Medea* conveyed the Grecian King close along the shores of such parts of his dominions as bordered on the sea, and thus made a circuit of the whole Peloponnesus, from the Gulf of Egina to that of Lepanto, stopping at every place of note, at all of which the young sovereign of this resuscitated state was most enthusiastically received by his Hellenic subjects.

From the gulf of Lepanto, near the entrance of which the King landed, at the ancient town of Patræ, now the commercial emporium of Greece, they proceeded to Missolonghi, and viewed the sad memorial of him who devoted his best talents and his latest energies in the cause of Grecian independence, and fell a victim at the shrine of that liberty he loved so well.

From Corfú, where the steamer stopped a few hours, the voyage was continued to Ancona, at the rate of ten knots an hour, though the wind was mostly contrary, and for the last 100 miles fresh against her.

Thus ended these most interesting yachting cruizes of the *Medea*, throughout the whole of which she acquitted herself to the admiration of all, and worthy of that country whose standard was borne in unison with the royal banners, either of Bavaria or Greece.

The ship now returned to Malta, and steamed the whole distance from Ancona at the rate of nine and a half knots per hour, the wind being ahead, with occasional fresh breezes for one-third the passage. On the 10th of June she rejoined the fleet at Corfú, to which place she was navigated under sail; and having cruized about the Ionian Islands, and off the coast of the Peloponnesus; anchored with the rest of the ships close to the shore of Attica, immediately in front of the old Athenian havens of Phaleron and Munychia.

Leaving the squadron at this anchorage on the 10th of August, the *Medea* sailed round to Zante to meet the English packet, and beat up the west coast of the Morea at the rate of six and a half knots an hour, against a fresh north-westerly breeze, making nearly a straight course at five points from the wind. From Zante she returned to the Ægean sea under steam, and on the 21st rejoined the admiral, then at anchor off the island of Syra,—after a passage of thirty hours; thus accomplishing this circuitous and intricate navigation of 290 miles at an average of nine and two-thirds knots per hour, the wind having been directly ahead, but moderate during the first half of the run: and although for the latter part it was mostly on the “beam” and “quarter,” the waves which it created were by no means favourable to her progress. On the 26th a Turkish ship of war was driven in a gale of wind close to the rocks on the windward side of the island Gutherize, near Syra, and obliged to anchor close to the reefs. The *Medea* proceeded to her assistance, and extricated her from her perilous position by towing her off-shore against the gale. On the 28th she again proceeded to Zante with the admiral's despatches, and arrived in twenty-seven hours, at a mean rate of more than ten and a half miles each hour.

There being no necessity of expedition on her return to the fleet, the passage was made, in accordance with her usual custom on such occasions, without the aid of steam. It is worthy of remark, with reference to the *Medea*'s frequent voyages under sail, that she invariably beat the trading vessels which were met with; and it is well known that the commerce

of the Mediterranean, particularly the Levant, is pursued generally in ships second in their sailing qualities to the mercantile marine of no country in the world.

After rejoining the admiral and fleet in Vourla Bay, she was despatched on the 11th of September again to Zante for the mails from the English packet; and made the voyage under canvass in six days, encountering light winds throughout, principally in a direction contrary to her course; and on this occasion she beat an Austrian ship of war. The return to Vourla under steam was at an average rate of eight and a half miles an hour, the wind being contrary during the whole passage, and for more than half of it very strong.

On the 7th of October the ship returned to Malta, and from thence she proceeded by steam on the 20th towards Constantinople, with a messenger and despatches for the British minister; but not being allowed to enter the Dardanelles, she remained at anchor in Basika Bay, on the coast of Asia Minor, close to the plains of Troy. On the 2nd of November, when returning, they experienced in the neighbourhood of Lemnos a heavy gale of wind, in which the vessel behaved remarkably well and suffered no damage, except the loss of a few sails (it being always expedient, when the steam is used in a gale of wind, to set as much sail as may conveniently be carried, in order to steady the ship). As the wind was very strong ahead on nearly all the route to Malta, the passage was made at a slower rate than usual, the speed being in some instances, during the height of the gale with a heavy swell, reduced as low as three and a half knots; yet, even under these untoward circumstances, the average rate was six knots an hour.

The next voyage was on the 26th of December, from Malta to and from Zante, Patras, Cephalonia, and Corfú; in this instance performing the duty of a packet. The run to Corfú was at a mean rate of near nine miles an hour, the wind being variable, and having experienced as far as the islands a heavy swell, of course always unfavourable to the progress of a steamer. On the 2nd of January, 1837, she left Corfú, at 4 p. m. again called at the places above-mentioned, (being detained eight hours at Patras,) and reached Valette at 6 p. m. on the 5th, making the whole distance at an average of nine miles an hour, though the wind was mostly contrary, and in some instances strong ahead.

After this voyage the *Medea* remained at Malta until the 20th of March, when she started for Toulon with some important despatches, and also to receive on board Sir Charles Vaughan, lately appointed Ambassador Extraordinary to the Porte. This passage was effected by steam in four days, at a mean rate of seven and a half knots, having for more than twenty-four hours of this time experienced a heavy gale of wind from the westward, with a tremendous sea, so high that at one time the ship was nearly thrown on her "beam-ends," the lee paddle-box immersed, and a boat which was secured to "davits" far above the "gunwale" much damaged.

As the wind still continued westerly, it was favorable for the return passage so far as the straits of Bonifacio, and the rate was nine and a quarter miles an hour, though the coals were so bad as to make it difficult to keep the steam up, and the ship's motion, from the waves, was very unfavorable to her progress. On the coast of Sardinia the wind changed to south, with a continued high sea; yet her speed against it was not below nine knots, and she continued on the remainder of the route to Malta, with an incessant breeze ahead, at nearly the same average, and reached the port on the 30th of March.

Having received a full supply of coal on board, she again departed, with an officer of the diplomatic corps on board, on the evening of the 1st of April, reached Basika bay in ninety-two hours; and, after remaining eight days, returned to Malta, where she arrived on the 16th of April. During this voyage more than one gale was experienced, and the first 400 miles, being the passage between Valette and Cape Matapan, was against a strong Levanter, besides which she encountered contrary winds both going up and coming down the Archipelago; yet the average rate of steaming, from leaving until the return to Malta, was near eight miles an hour.

Nothing extraordinary occurred in this vessel's service till she was ordered, early in June, to convey Sir Charles Vaughan from Malta to Venice, and she accordingly left the former place on the evening of the 18th. Although some part of the passage was against a violent head-wind, the speed was never reduced below five knots and a half, and the average rate of the whole was above eight. Towards the close of day on the 22nd, the *Medea* passed the Lido, entered the narrow canals of Venice, and moored to the quay opposite the Basilica of St. Mark, precisely in the spot once occupied by the far-famed Bucentaur, fit palace for a sovereign whose chief dominion was the wave,—who was wont, in the by-gone days of Venetian glory, to receive in these his floating halls the honoured great who flocked from distant lands to view the wealth of Adria's Queen; and which served to convey him, on the magnificent ceremony of Ascension-Day, to the bridal of that wave over which his empire has passed away.

The *Medea* also visited Trieste, Pola in Istria, and Ancona, making a rapid passage between each place, and on the 1st of July reached Malta; the steaming rate from leaving the last-named place being nine knots and three-quarters.

On the 4th of July she proceeded on a cruize under canvass in company with the squadron, and succeeded on all occasions in keeping her station in the "order of sailing" without difficulty. On the 6th of July the trial of sailing was made, of which we publish a delineation in a diagram, when it appeared that she was equal in speed to all, except the new ship *Vanguard*, of 80 guns, (built by Sir William Symonds,) and that she gained much to windward of the *Caledonia*. We also find that during this cruize, which lasted till the 15th, the steamer had frequently to bear up and run to leeward into her station in consequence of her very extraordinary "weatherly" qualities; and that in no one instance did the ships shorten sail for her.

Being detached from the fleet on the last-named day, the *Medea* "beat" into Malta harbour against a fresh wind; and having received a few coals, she quitted Malta for the last time, rejoined the admiral, received despatches, and forthwith proceeded towards Gibraltar; where she arrived in 113 hours, being at a rate of nine knots, having encountered about an equal proportion of fair and contrary winds during the passage.

Between the time of her arrival at Gibraltar and the day she reached England, in September, she made two passages to and from Port Mahon, and on one occasion towed the *Princess Charlotte*, of 120 guns, and the *Vanguard*, to sea against a light breeze. She also visited Valencia and Barcelona on the coast of Spain, and Tetuan in Africa; and being at Gibraltar at the time the *Don Juan* steam-packet was wrecked at Tariffa, the *Medea* proceeded at once to the spot, where she was mainly instrumental in saving much property and stores, and afterwards

carried the mails to England. During this time,—namely, from the 20th of July until her arrival at Falmouth on the 24th of September,—she steamed 3660 miles, of course experiencing great varieties of weather, at an average rate of more than nine miles an hour.

The novelty of navigating a steamer under sail would naturally suggest to intelligent officers such modifications of marine tactics as might appear suited in the particular cases of steam-vessels to the varied and ever-changing circumstances which the seaman encounters in the prosecution of his eventful duties; and we have now to advert to a contrivance adopted on board the *Medea*, which, though productive of very beneficial consequences during the services of that ship, and worthy of imitation in all war-steamers, would be quite inapplicable to commercial vessels, and worse than useless if attempted.

Our naval readers are well aware of the inconvenience that sometimes arises to a cruising squadron, generally sailing in “close order” or “line of battle,” when in calm weather the ships involuntarily approximate each other, and the consequent labour of towing by boats to prevent accidents by collision. The *Medea*, when acting as a sailing vessel, was of course liable to be placed in these circumstances; and as it was impossible by boats to produce velocity enough to set the wheels in motion, that usual resource, if not quite unavailing, was, from the resistance which the paddles afforded, attended with as much labour; and as much force was required as to tow the largest ship of war. To light the fires and “get the steam up” at once put an end to the difficulty; but this caused an expenditure of coal, and the great object was to perform all the duties of cruising without invading those resources on which her great power and efficacy depended.

Much inconvenience had also been experienced during the varied services of this vessel from the difficulty of changing her position in harbour when required to move towards a coal depôt; and it was found, as before stated, that as many boats were required to move her even a short distance as would suffice to “transport” a first-rate ship of war, and the obstacles to effecting the same object by using “warps” were of equal magnitude. Although the fuel could generally be renewed in cases similar to the above, yet, if the steam was used, an expense would be incurred even in the performance of such insignificant duties, particularly when occurring on a foreign station to which the coals are conveyed at a considerable cost; and the boilers, &c. would undergo some deterioration, however slight it might be. The small quantity of coal consumed on board this ship, although she steamed full 30,000 miles, and the excellent state of her machinery and boilers after a service of nearly four years, fully prove how excellent was the system which led to such results.

“To obviate the difficulties attending the removal to a short distance,” writes Mr. Peacock, the master of the *Medea*,¹ “I hit upon the following simple contrivances, which were fitted to the *Medea*’s wheels by *our own resources*:—To the inner side of the inner arms, between the outer polygons, a set of iron lugs, shaped like the letter V, are riveted on, large enough to take a three-and-a-half inch hawser. Two iron fair-leaders, with rollers in them a foot apart, project from the inside the paddle-box immediately over the shaft, and are of such a height and distance from the side as to insure the lugs alternately catching the hawser, and prevent

¹ Vide Nautical Magazine, p. 731, November, 1837., to which we would refer our readers for a more elaborate description of this contrivance, and its probable benefits,—of which those only who tried the experiment can be competent judges.

the possibility of the arms or lugs coming in contact with them when the wheel springs in a sea way steaming, which every steam-vessel's wheels are more or less liable to. A hole two inches in diameter, nicely leaded, is bored in one of the steps at the fore and after part of the paddle-box, through to the inside, at a convenient height for a man to pull from, in a horizontal position, and at an angle sufficient to prevent the inner end of the paddle-boards picking up the bight of the hawser in its rotatory progress; which angle also guides the position for the two leading blocks, one of which hooks on to a timber-head on the forecastle, and the other at any convenient length abaft the wheel, according to the number of men who are to clap on the hawser, which is a three-and-a-half cable, cut to a convenient length, and has an 'Elliott eye' spliced on each end. This hawser is rove as follows:—one end is first passed through the after-hole, then through the foremost fair-leader over the iron lugs alternately, then through the aftermost fair-leader, (crossing the feeding part between the fair-leaders,) and brought out through the foremost hole, where it is lashed with small line to the other end, which in the mean time has been rove through the after and foremost leading blocks, and brought to the foremost hole in readiness. When the lashing is secured, the after leading block is braced taught with a jigger—the larboard and starboard watches man their respective messengers, the band strikes up, and off she goes."

It may perhaps to our non-professional readers simplify the description thus given by the inventor of the plan, if we state, that the wheels were set in motion by a rope acting, and resting on certain fixtures attached to the radii at a regulated distance from the periphery; and that this endless rope, being extended to and passed over fixed pulleys near each extremity of the vessel, presented to the crew a continuous line on which their labour could be expended as they walked or ran along the deck, and produced the rotatory action much in the same way as distant machinery receives its impulse by a band connected with some steam-engine or other prime-mover.

Thus the Medea was occasionally moved, when the shortness of the distance, or other circumstances rendered it inconvenient to use steam, and in one instance proceeded through the entrance of Malta harbour against a light breeze, at the rate of two knots an hour.

We have now laid before our readers such facts connected with this vessel, (the only government steamer that has been for a lengthened period on a foreign station, or extensively employed as a sailing vessel,) as we think may be interesting to those who would form a correct estimate of the means which have been adopted for the benefit of the public service in thus creating a novel description of war vessel, to accord with a new era in navigation.

T. B.

Trial of Sailing between H. M. Ships Caledonia, Asia, Vanguard, and Medea,
made on 6th July, 1837, off Malta.

At 10^h 15^m A. M. commenced to try rate of sailing; close hauled on the larboard tack; a fresh breeze and little head sea; ships under courses, single-reefed topsails, top gallant sails, jib and spanker, being as much as each could well carry. Wind W. by N., Caledonia's rate, 5 knots. Vanguard passed under Asia's stern, and soon shot ahead of her; and upon her weather bow passing to windward of Medea, (which latter bore up to enable her to do so) 30. At the time of commencement 10 15, the respective ships bore from Caledonia as follows:

At 10 15 Vanguard S. S. W. $\frac{1}{4}$, W. $\frac{3}{4}$ mile: Asia S. S. W. $\frac{1}{4}$, W. $\frac{3}{4}$ and 120 fms: Medea W. by S. $\frac{1}{4}$, 175 fms. from 10 15 to 11 Caledonia averaged a north course $4\frac{1}{2}$ knots, wind from W. by N. to N. W. by W.

At 11, Vanguard W. by S. $\frac{1}{2}$ S. $1\frac{1}{2}$: Asia S. W. $\frac{3}{4}$, S. $1\frac{3}{4}$ 20 fathoms: Medea S. W. $\frac{1}{2}$, W. $1\frac{1}{4}$, 125 fms; from 11 to 12 Caledonia averaged a N. by E. $\frac{1}{4}$ E. course, 4 knots 4 fms.

At 12, Vanguard N. W. $\frac{3}{4}$, W. $3\frac{1}{4}$, 172 fms: Asia W. by S. $\frac{1}{2}$, S. $2\frac{1}{4}$, 31 fms: Medea W. by S. $\frac{3}{4}$, S. $2'$, 220 fms. At noon the wind freshened, Asia and Vanguard took in royals and F. Jib. at 12 30, came up to N. by W. Average course from 12 to 1, N. by W. $\frac{1}{4}$, W. $4\frac{5}{8}$ knots.

At 1, Vanguard N. W. $\frac{3}{4}$, N $4\frac{3}{4}$, 110 fms: Asia W. S. W. $2\frac{1}{2}$, 50 fms: Medea W. by S. $2\frac{1}{4}$, 200 fms. Trial continued from 10 15 A. M. to 1 P. M., being 2 h. 45'— course made good by Caledonia, N. 13', in which time each ship gained as follows:

	<i>To windward.</i>	<i>Fore-reached.</i>		<i>To windward.</i>	<i>Fore-reached.</i>
Vanguard of Asia,	$2\frac{1}{4}$ —	4' 184 fms.	Asia of Caledonia,	$1' \frac{3}{4}$	
„ of Caledonia,	4' 135 fms.	$3\frac{1}{4}$	„ of Medea,	75	125 fms.
„ of Medea,	$2\frac{1}{4}$ 185 fms.	$4\frac{1}{4}$	Caledonia of Asia,	—	$\frac{3}{4}$ 209 fms.
Medea of Caledonia,	$1\frac{1}{2}$ 180 fms.		„ of Medea,	—	1' 150

N. B. During this as well as former trials, Vanguard has done exceedingly well, and again proved her great superiority, both in speed and stability; and had the wind remained steady, she would have shown it still more, as the changes were always to her disadvantage. The Medea also (considering her small spread of canvas) has again proved her superiority in going to windward, having beaten Caledonia considerably, and kept away with Asia during the whole time of trial.

(Signed) C. P. BELLAMY,
Master H. M. S. Caledonia.

VI.—ON THE STEAM BOATS OF THE UNITED STATES OF AMERICA.

BY JAMES RENWICK, LL.D.

PROFESSOR OF NATURAL EXPERIMENTAL PHILOSOPHY AND CHEMISTRY IN COLUMBIA COLLEGE,
NEW YORK.

THE application of the steam engine to the purposes of navigation attracted the attention of many persons in the United States at an early period. No sooner had Watt's improvements become known, than the circumstances of the population of that country, and its very geographical character, pointed out the propulsion of vessels, as the most important of the many uses to which that powerful agent may be made subservient. The Atlantic coast, with the exception of the extreme north eastern part, is either intersected by deep bays, or covered by islands. By these means a navigation parallel to the coast might, at small expense, be extended from New York to the southern limit of Georgia; and in the opposite direction, the Hudson River and Lake Champlain pointed out the means of extending the water communication to the frontiers of Canada. These natural advantages have been improved by artificial means, and at the present moment, an internal navigation exists from the boundary of the British possessions to the sounds which line the coast of North Carolina.

The parts of this navigation which have required no artificial improvement, are large and deep rivers, lakes, sounds, and arms of the sea. In these, although transportation was secure from the storms and waves which affect the open sea, yet this very security was gained at the expense of time, so long as the currents of the atmosphere were the only power which could be applied.

The accession of the vast territory known under the collective name of Louisiana, but now divided among many states and territories, opened a still wider field for navigation by steam. The Mississippi and its innumerable branches comprise navigable waters of many thousands of miles in extent, but which, from the rapidity of their currents, are almost inaccessible from the Gulf of Mexico, either by sails or oars. The population of the territories traversed by these streams is sparse and scattered, almost wholly devoted to agricultural pursuits, and yet feeling the wants, and desiring the luxuries of the highest civilization. To supply these wants, and furnish these luxuries, rapid methods of transportation, as well as great foreign importations, are demanded; and there are no means yet discovered by which these purposes could have been effected, except by the steam boat.

Influenced by such considerations, attempts to apply steam to the purposes of navigation were made in the United States, even before Watt had succeeded in giving a double action to his engine. The earliest enterprises of this sort were those of Fitch and Rumsey, which both bear the date of 1783. Both were founded upon the original form of Watt's engine, and both

failed, rather from the inherent defects of that instrument, in its power of general application, than from any want of ingenuity or mechanical skill in the projectors themselves.

John Stevens, of Hoboken, commenced his experiments on steam navigation in 1791, and for sixteen years devoted much time, labour, and money, to this object. In this pursuit he sometimes acted alone, at other times had the aid of associates. Among these may be named Chancellor Livingston, and Roosevelt. This association, among other persons, called to their aid Brunel, since celebrated as the engineer of the tunnel beneath the river Thames. The appointment of Chancellor Livingston to the post of minister to the consular government of France, dissolved this association, at a moment when hopes of at least partial success might reasonably have been entertained.

In the year 1801, a remarkable experiment was performed at Philadelphia, by Evans. This engineer had been employed by the corporation of that city, to construct a dredging machine, for the purpose of removing obstructions in the Delaware river. He proposed to work the dredging apparatus by the high pressure engine, which he had invented some years before. Constructing the vessel and engine at his shops, distant a mile and a half from the water, he mounted the whole upon wheels, to which he gave motion by the engine, and thus exhibited the earliest instance of locomotion. The vessel being thus transported to the water, and launched, he next placed a paddle wheel at the stern, and connecting it with the engine, made it the means of conveying the vessel to the place where the work of dredging was to be performed.

Livingston, on reaching Paris, became acquainted with Fulton, and discovered that he had also studied in what way the steam engine might be applied to the purposes of navigation. Struck with the soundness of his views, Livingston induced him to enter into a course of experiments, for the purpose of testing them practically. These experiments were performed at Plombieres, and were subsequently repeated on a larger scale, upon the Seine, near Paris.

The results of these experiments were so satisfactory, that Livingston forthwith undertook to provide the funds for building and equipping a steam boat of large size, in the United States. As the workshops of that country could not, at that time, be depended upon for furnishing an engine of good construction, it was agreed that those of Watt and Bolton should be resorted to. From a variety of circumstances, delays were not to be avoided, and the engine constructed by Watt and Bolton did not reach New York until 1806, nor could the vessel be prepared to receive it before the summer of 1807.

The engine which was used in this final and successful experiment, and which was constructed from the draughts made by Fulton, in France, in the year 1803, had a marked influence upon the forms of those subsequently constructed for this purpose, both in England and the United States. The cold water cistern of Watt's engine was dispensed with, and in order to supply its place the diameter of the condenser was doubled; its capacity thus became half that of the cylinder, instead of one-eighth, as had before been customary. The water of injection was supplied by a pipe passing through the bottom of the vessel. A parallel motion seems to have been sent out as a part of the engine, but for reasons which cannot now be discovered, a cross head, adapted for another purpose to the piston rod, was made to work in guides. This cross head was added for the purpose of bearing two connecting rods or straps, by which two working beams were, as it were, suspended. The working beams were necessarily two in number, in order to include the cylinder between them; and Fulton being aware

of the difficulty which would exist in uniting an engine constructed at one place with a vessel built at another, had a double provision for uniting the beams to the cranks. The former were therefore made of the form of an inverted **L**, giving him the choice of taking off the motion either from the horizontal or the vertical branch. The latter was found most expedient, and thus the working beam became, in its primitive use, a bell-crank. The connecting rod was therefore extended horizontally to meet the crank.

We may here state that this very form of engine, with the exception that the beams had the usual shape, and the motion was taken off by a connecting rod directed upwards, was adopted by Bell in the vessel which he constructed upon the Clyde in 1812; and that from this latter, as the original model, all the engines used in the British steam boats have been derived.

The paddle wheels of Fulton's first steam boat were attached to the axles of the cranks, and the latter also bore spur wheels which drove pinions; upon the axles of the pinions was placed a heavy fly wheel. The latter was of essential use, so long as the velocity of the paddle wheels themselves was not great; but, at the speed which is now customary, they cease to be of value, as the paddle wheels themselves act as regulators. Fly wheels are, in consequence, no longer to be seen in American steam boats.

The object proposed by Fulton, in the mode we have described, of connecting his water wheels with the engine, was unquestionably that of enabling him to change their diameter, and to raise and lower their axis of motion, until he should, by experiment, ascertain the size and position most advantageous in practice. In conformity with this view of the subject, it is known that the position of the axis was more than once changed; and it is believed that the diameter of the wheel was also altered, before the first steam boat was considered by him as completed. In constructing his second steam boat, 'The Car of Neptune,' Fulton, being no longer compelled to feel his way by experiment, made very important changes in the form of his engine. The piston rod was still directed by a cross head, moving in guides, but the working beams were suppressed altogether, and two cranks, adapted to two separate axles, were attached directly to the cross head by connecting rods. A fly wheel was still used, driven by wheels and pinions, and in the slow rate of motion to which he restricted himself, was found of great value. This form of engine is still much used, with the omission, however, of the fly wheel. Two views of such an engine, with a boiler of a favourite form, are given in Plate cxv.

In his first steam boat, Fulton was satisfied with endeavouring to attain the speed of four miles per hour, which had been made the condition of his obtaining an exclusive right to navigate the waters of the state of New York, by an Act of the Legislature of that state. By alterations suggested in the experiments of the first summer, and which consisted principally in raising the axle and increasing the diameter of the water wheels, the velocity of the first successful steam boat was carried up to six miles per hour.

The first voyage of Fulton upon the Hudson was performed in the summer of the year 1807; and in the year 1808, the same vessel, much improved in convenience, began to ply as a passage boat between the cities of New York and Albany.

In his subsequently constructed steam boats, Fulton aimed at, and succeeded in attaining, a greater degree of speed; but, even in the last which he constructed, he limited himself to nine miles per hour, which, by the application of theory, derived from the best published experiments, he considered as the greatest velocity which could be advantageous.

Three steam boats were constructed by Fulton for the navigation of the Hudson. These were all flat bottomed. He also constructed a vessel intended for the navigation of Long Island Sound. This had a keel, and although of little depth of hold, approached in figure, in other respects, to the usual form of a fast sailing ship. He also drew the plan of another, which was left unfinished at his death, and which was intended for the navigation of the ocean.

The success which attended the vessel intended for the navigation of the Sound, but which, in consequence of the presence of an enemy's fleet, had been restricted to the Hudson, seems to have caused Fulton to doubt the propriety of the first model which he had adopted; and, in consequence, the last vessel which he planned for the navigation of the Hudson, and which was also left unfinished at his death, had a keel. It is, however, a remarkable fact, that after innumerable trials, the present model of the most rapid steam boats has returned nearly to the proportions originally adopted by Fulton. They have a keel indeed, but the floor timbers have but a few inches of dead rise, and thus the bottom is nearly flat. Besides vessels intended for the conveyance of travellers upon the Sound and the Hudson, Fulton constructed several ferry boats, intended for the transportation of loaded carriages, and a formidable ship of war. He also furnished plans for vessels intended for the mixed purposes of carrying freight and passengers upon the Mississippi.

The elder Stevens of Hoboken, whom we have mentioned as having made experiments on steam navigation, resumed his attempts at the very moment that Fulton was about to put his plan in operation; and it was only a few weeks after the first successful voyage of the latter, that he also had a steam boat in motion. The speed of this was at least equal to that of the first steam boat of Fulton. It plied for a time as a ferry boat from New York to Hoboken, and, when excluded from the navigation of the Hudson by the exclusive grant to Fulton, Stevens sent this boat round to the Delaware by sea, and was in consequence the first to navigate the ocean by steam.

The form of engine adopted by Stevens differed less from the original form of that of Watt, than the form chosen by Fulton. The parallel motion and working beam were both retained in their usual form and proportions; the connecting rod was increased somewhat in length, and the axle of the crank produced on both sides, in order to form the axle of the paddle wheels; the enlarged conductor, as a substitute for the cold water cistern, was also used by him.

These forms of engines, thus brought into use by Fulton and Stevens, have directed the practice of American engineers. The fly wheel used by Fulton has been laid aside as unnecessary at high speeds; the parallel motion has been superseded even in the engine with a lever beam by a cross head and slides. Upon the Mississippi, and in a few instances in the Atlantic States, horizontal engines have been employed; and the description of engine called high pressure, in contradistinction to condensing, is much used in the Western waters.

New York and its vicinity may still be considered as furnishing the most successful instances of steam navigation. When the monopoly granted to Fulton by the state of New York was decided to be unconstitutional by the Supreme Court of the United States, the navigation of the Hudson was thrown open to competition. The number of passengers then conveyed upon that river had already become enormous, and presented inducements of the most powerful kind to the proprietors of steam boats. The boats of Fulton's Company had performed the

passage between New York and Albany, a distance once estimated at 160, but not exceeding 145 miles, in fifteen or sixteen hours; but, for all useful purposes, a whole day might be considered as expended in this voyage. It was now attempted to perform the passage between sunrise and sunset. A vessel called the 'Sun' was the first to undertake this, but was not able to make her average passages in less than fourteen hours, and thus could fulfil the desired object only during the longest days of summer. The engine of the 'Sun' was on the plan of Woolf, having two cylinders, in one of which the steam acted by its pressure, in the other expansively, and was condensed on leaving the second. The boilers were cylindrical, and as there were no return flues, and the fuel employed was pine wood, a great loss of heat ensued. Flame, in fact, issued from the chimnies, to the distance of six or eight feet.

It was at this moment that Robert L. Stevens, the son of the Stevens who had devoted so much time and labour to the early experiments on steam navigation, placed upon the Hudson a vessel which he had constructed for the navigation of the Delaware, on which river an active competition had been kept up, while all opposition had been excluded from the former river by the exclusive grant to Fulton. This vessel far exceeded the 'Sun' in speed, and made the passage easily in twelve hours.

The possibility of leaving New York after sunrise, and reaching Albany before sunset, for the greater part of the season in which navigation is practicable, being thus established, several other vessels were immediately constructed to fulfil the same object; and the steam boats planned by Fulton himself, or constructed in direct imitation of them, were driven from the river, or applied to the purpose of towing barges.

Among the vessels which replaced them a strong rivalry existed, and contests of speed took place daily. These contests involved more than mere reputation; for the way passengers, who often form the majority, were in the habit of entering the vessel which first reached their place of embarkation. It thus happened that vessels which were frequently defeated were sure to be losing speculations; and even some of great speed, but which were not backed by a sufficient capital, were also withdrawn, in consequence of the unprofitable prices at which the passages were often given.

In the course of these contests, changes were made in existing vessels, and these changes were copied in the construction of new ones. These changes consisted principally in an increase of the stroke of the piston, and therefore in the length of the crank, and in cutting off the steam at half stroke. The first object was accomplished, in existing vessels, by adding an additional piece to the cylinder. Even some of the older vessels were improved in these respects, and again replaced upon the navigation, and competed, with tolerable success, with those of the improved description. The old vessels, thus improved, took their places in what is called the night-line. The transportation of passengers on the Hudson is adapted to two distinct classes, those who travel for business, and those who travel for pleasure. The former are best accommodated by vessels performing their passage during the night; for thus business may be transacted in New York on one day, and in Albany the next. No real advantage is gained to these passengers by reducing the time of transit below twelve hours; and the old boats, thus improved, were enabled to effect this. On the other hand, every minute saved in the passage by day light was considered of advantage.

It appears probable that the use of a valve, cutting off the steam at half stroke, had at first no other object in view than a saving of fuel. The person who first ascertained, as a practical

result, that a greater speed might be attained in a given vessel by using steam expansively, was Adam Hall, at that time the director of the workshops of the West Point Foundry Association. He, at all events, entered very fully into the practical investigation of this subject, and drew up a paper exhibiting his views, which was communicated to the writer of this essay. The same views had been previously exhibited theoretically by the writer in a public course of lectures delivered in February and March, 1830. These were soon after made public in a treatise on the steam engine, which it is believed had some influence in the improvements that have since been made in navigation by steam. It was therein demonstrated, that the power of a given engine might be doubled by loading the safety valve with 57 lbs. per square inch, and cutting off the steam when one-eighth of the cylinder had been filled, and a saving of two-fifths of the fuel effected at the same time.

In the subsequent improvements of which we shall hereafter speak, the excellent workmanship of the West Point Foundry, with which, however, Mr. Hall ceased to be connected, and the high scientific attainments of the Messrs. Kemble, its president and agent, had a very important influence.

While the contests of which we have spoken were going on, Stevens was busily engaged in building a new steam boat, to which he gave the name of the 'North America.' As this vessel embodied all the improvements either in the original structure, or derived from experience in his former steam boat, we shall give a concise description of her form and arrangements.

The dimensions of the 'North America' were as follow :

Beam	30 feet.
Draught of water	5 feet.
Diameter of water wheel	21 feet.
Length of bucket	13 feet.
Depth of ditto	2 feet, 6 inches.

The engines were two in number, and with the boilers, were placed upon the wheel guards, thus leaving the deck free from incumbrance from stem to stern. The cabins beneath could also be opened, so as to afford a clear view from the sternpost to the cutwater. The engines worked with beams, and had the following dimensions :

Diameter	44½ inches.
Length of stroke	8 feet.
Strokes per minute	24

The steam was usually raised to a tension, over and above an atmosphere, of 10 lbs. per inch, and was cut off at half stroke. The velocity through the water, as ascertained from the average of a great number of passages, was 19·8 feet per second, or about 13½ English miles per hour. The relative velocity of the outer circumference of the wheel was 6·6 feet per second.

Another vessel, intended for a different navigation, namely, that from New York to Newport R. I., was built shortly after the 'North America,' and was considered as successful an application, taking the difference of circumstances into account, as that steam boat. In this navigation it is necessary not only to pass the wide and often stormy æstuary, known as Long Island Sound, but to enter the open ocean. It was therefore considered expedient to sacrifice speed, for the purpose of rendering the vessel more fit for the navigation of agitated and tempestuous waters.

This vessel was called the 'President ;' the particulars of her structure, &c. were as follow :

Breadth of beam	32½ feet.
Draught of water	9 feet.
Diameter of water wheels	22 feet.
Length of bucket	10 feet.
Depth of ditto	3½ feet.
Engines, in number,	2
Diameter of cylinders	4 feet.
Length of stroke	7 feet.
Number of revolutions	21 per minute.

The average velocity was 17·6 feet per second, or about 12 English miles per hour, and the relative velocity of the circumference of the wheel was 6½ feet per second.

On one occasion it became necessary for the 'President' to make a passage with only one of her wheels and engines in action. In this passage the velocity of the boat was diminished to 13·8 feet per second, but the relative velocity of the wheel fell but little short of that acquired when both wheels were used, being 6·3 feet per second. The constancy which thus appeared to exist in the relative velocity of the circumference of the wheel, in two boats of very different form and structure, and in the same boat, when propelled by forces, differing as much as in the ratio of 2 : 1, is a remarkable fact, and appears wholly irreconcilable with the ordinary mathematical expression of the relation between the two velocities of the wheel and the vessel. It had been deduced by a course of reasoning, which has been received without question, that the velocity of the vessel bears a constant proportion to that of the wheel, while in the instances we have cited they differ by a constant quantity.

Without attempting to question the skill in analysis of the distinguished mathematicians, both French and English, who have investigated this problem, we may venture to state that this appears to be a case in which the formula of Parent is applicable, and that the velocity of the circumference of the paddle wheel through the water ought to be constant, and equal to one-third of the greatest velocity at which a flat surface can be propelled through that fluid, in a direction perpendicular to its plane. Assuming this to be twelve nautical, or 13·8 English miles per hour, we have for the proper constant relative velocity of the circumference of a paddle wheel 6½ feet per second. On examination of the performance of a great number of American steam boats, some of which we shall hereafter cite, it has been found that the relative velocity of their paddle wheels has always been nearly this quantity. This fact is thrown out for the present, for the purpose of drawing the attention of the scientific world to it; and should it be found to be universal, it will probably furnish a basis for the mathematical theory of steam boats, whose results will be more applicable to the cases which occur in practice, than those which are now set forth, but which are of little or no use to the engineer or ship builder.

As the speed which has been stated for one of the vessels, which, from their having been long attentively observed by the writer, have been chosen as instances, is far beyond that which has been attained in Europe, it may be well that we should cite the facts whence this statement has been derived. The distance from New York to Albany has been measured by the late Surveyor-General of the State of New York, in straight lines joining the extreme points of the several reaches of the river, and amounts to 145 miles. The average passages of

the 'North America,' before the further improvements we shall mention, were performed in 10hrs. 48min., after deducting stoppages.

The circumstances of the tide in the river caused the curious result, that among the passages whence the above average was deduced, those which were performed in the shortest time were upwards, or in opposition to the fall of the stream. The Hudson is affected by the tide beyond Albany, but in the higher parts the flood is rarely attended by a strong current, and at times no other effect is produced by it than a variation in the velocity. But the wave which causes the tide reaches Albany in about eighteen hours; and thus, a vessel leaving New York soon after low water carries the flood tide with it, and if it perform the passage in ten or twelve hours, feels its full influence for the whole of the way. In descending, the vessel meets at least two successive waves, and thus has the tide alternately favourable and unfavourable.

At New York the water of the Hudson at high water is usually nearly as salt as that of the ocean; but there have been two or three instances within the memory of man, when it was so fresh at low water that outward-bound ships have filled their supply of water from it. At a distance of seventy-five miles from New York the water is always perfectly fresh, and is rarely perceptibly brackish above the highlands, which are fifty miles from New York. For the latter distance the channel for the largest ships is never less than 1000 yards in width, and is in many places seventy feet in depth. Ships drawing fifteen feet water have a good beating channel at all times of tide as high as the city of Hudson, 120 miles from New York: the remaining twenty-four miles are comparatively shallow and narrow.

The writer made in the 'New Philadelphia' one of the most remarkable passages ever performed. Leaving New York at five o'clock P.M. with the first of the flood, he landed at Catskill, distant 111 miles, a quarter of an hour before midnight. As passengers were landed and taken in at seven intermediate points, the rate at which the passage was performed was not less than eighteen English miles per hour. Now, as the current in no case exceeds four miles per hour, the absolute velocity through the water must have been at least fourteen miles.

It may be here remarked, that the demonstration which attempts to prove that the absolute velocity of a vessel propelled by steam in a current differs when the direction of the motion is with the stream, from that with which it may be moved against the stream, is at variance with the facts. Upon examination, this demonstration will be found to rest upon false premises: the conditions laid down are not those which actually exist. In order to view the subject in a proper light, let us suppose that a steam boat is abandoned to the current: in this case it must speedily acquire the velocity of the stream, and be at rest in relation to the water on which it floats.¹ When the machinery begins to act, no difference of circumstances can arise from the direction in which the prow of the boat is turned, and all the motions in reference to the mass of fluid will be performed exactly as if that mass were not in motion. In moving with the current, then, the rate of progress by the land will be the sum of the ordinary rate of the boat's motion, and the velocity of the stream; in moving against the current, the rate of progress will be the difference between these two velocities.

In obtaining these velocities of thirteen miles and upwards per hour, it does not appear

¹ Here the particles of the fluid are supposed to move in parallel straight lines, and with the same velocity at all depths.—Ed.

that the force of the engines employed exceeded that which had been used in some American vessels which had far less speed. Neither was the relation of the power of the engine, estimated in the usual manner, to the tonnage of the vessel, greater than that found in European steamers, whose velocity does not appear, at that time, to have exceeded ten miles per hour. Besides, it cannot be denied that the advantage in the finish and workmanship of the engines was on the side of the European vessels. We may therefore inquire to what circumstances it was owing, that a rate of speed, which a high British authority has very recently declared to be incredible, should be actually obtained. We ascribe this chiefly to the great difference in the principles which governed the structure of the engines in the two different countries. In the modifications of the original form of the engine of Fulton, the English engineers, whose efforts were principally directed to the navigation of stormy seas, thought it indispensable that the machinery should be included beneath the deck of the vessel. The stroke of the piston and the length of the crank were therefore diminished below the proportion originally chosen by Watt. In America, the vessels being principally intended for the navigation of rivers, no such change occurred; and when it became necessary to make the 'New Philadelphia' compete with vessels driven by more powerful engines, Stevens increased the length of the stroke and of the crank. The new relation between the diameter and length of the cylinder thus obtained, was followed, or even exceeded, in all subsequent engines. No change was made in the dimensions of the boiler, but the additional force was obtained by causing the steam to act expansively. The latter method was attended by an anomaly, which is however readily explained, when it is considered that the relative velocity of the circumference of the wheel is constant. It was not found that the steam, although cut off, at first at half stroke, was much increased in tension. The most obvious effect of the method was an increase in the velocity of the piston, by which the steam was prevented from accumulating.

When we consider the wheel as a body revolving on an axis, and which meets with a resistance, whose resultant is applied to a point at no great distance from its circumference, it will be obvious that there will be a point, to which, if the crank be applied, the whole force of the engine will be exerted to overcome the resistance; but if the crank be applied to any other point, a part of the force will be wasted upon the axle itself. Now, even in the long stroke usual in the modern American engines, it does not appear that the crank extends as far as this most favourable point; but in the short stroke of the English engines a large proportion of the whole power is lost.¹ This advantage is, however, at present less sensible in the American steam boats; for the principle of using cylinders of great length having been introduced, the next step was to increase the diameters of the wheels. The object intended to be gained by the latter change was an increase in the velocity of the circumference of the wheel, for the constructors of steam boats seem to have reached the conclusion that every addition to this velocity would add as much to that of the vessel. In one instance the diameter of the water wheels has been increased to thirty feet, and the stroke of the piston to twelve feet.

As an additional means of obtaining high velocities in the piston, the dimensions of the valves and steam pipes of the American engines have been increased beyond the proportion used by Watt. The flow of the steam from the boiler is thus rendered more rapid, and the

¹ The author must here allude to the friction caused by the pressure on the shaft: no loss of power can otherwise result from the mechanical arrangement.—Ed.

velocity of the piston increased in like degree. We have already stated that the steam is cut off, and thus caused to act expansively: the advantage thus obtained is analogous to that derived from the same method in the pumping engines of Cornwall.

As an accessory, and one of no little importance, we may mention the form of paddle wheel originally introduced by the younger Stevens, but now universally adopted. The form of this may be readily understood, by supposing a common paddle wheel to be cut into three parts, by planes perpendicular to its axis; that one of these being supposed to remain at rest, the second is moved through one-third, and the third part through two-thirds of the space intervening between two contiguous paddles.

It seems to be conclusively shown by the researches of Barlow, that the modifications of paddle which have been tried in Great Britain, are, upon the whole, inferior to the common paddle wheel. The triple wheel of Stevens does away the principal objection which can be opposed to the latter, namely, the long interval between the successive strokes of the wheel against the water, and their violence.

In vessels of small dimensions the same principle is applied, but the wheel is only double, instead of being triple.

The velocity of the pistons of engines used for manufacturing purposes is about 200 feet per second. In the 'North America' this velocity was carried up to 384 feet, and the rate is now exceeded in many of the newer vessels. Thus, in the steam frigate 'Fulton,' the velocity of the piston is 450 feet, and in the 'Cornelius Vanderbilt' and 'Highlander,' as much as 600 feet per second.

We have enlarged upon the performances of the 'North America,' not from their being unsurpassed, but in consequence of their forming an era in the history of steam navigation. It was easily seen that the important part of the resistance, and which in fact seemed to oppose an absolute barrier to all velocities beyond a certain limit, arose from the wave raised in front of a vessel in rapid motion.

Don George Juan estimates, that this cause of resistance increases with the fourth power of the velocity. It was attempted to lessen this part of the resistance, by altering the form of prows. False prows were therefore adapted to the vessels in use; and, as the cavity left behind the sternpost causes a similar resistance, false sterns have also been applied. These attempts have been eminently successful, and in some instances no visible wave appears on the water, before the entrance of the extreme breadth of the vessel. This is remarkably the case in some of the newer steam vessels, in which the form has been derived from that obtained experimentally by the addition of false prows and sterns. The latest model of this description is that adopted in the new steam frigate 'Fulton,' a draught of whose water lines accompanies this paper.—(Pl. CXVI.)

A section of a vessel (the 'North Carolina,' Pl. CXVII.) of similar form, but of less draught of water, is also appended; with a view of a third intended for sea navigation.

In the models of this new class of vessels, although built with keels, there is only a few inches dead rise in the midship section, and the floor extends, horizontally, nearly the whole length of the keel. This form will be better understood from the draught of the steam frigate 'Fulton.'

A long flat floor had been used before in the 'North America,' 'Dewitt Clinton,' and several other vessels, but differed from that of the new models in being nearly rectangular, so that

the prow and stern resembled conoids applied to a parallelopiped. In the new models all the water lines are continuous curves, except at the place where the water wheels are applied, where the sides of the vessel are vertical. The prows of the new models are wedges with curved surfaces, instead of being conoidal, and the general character of their models appears to be borrowed from the fast rowing boats, used by the Whitehall boatmen, in the harbour of New York.

The first steam boat in which the new structure was adopted, was the 'Lexington.' This vessel was planned by Captain Vanderbilt, a very enterprising and intelligent owner, and commander of steam boats. The undertaking, considering the circumstances, was one of great boldness, for this vessel was at once placed upon Long Island Sound, where it was exposed occasionally to high waves. The experiment was so successful, that the passage to New Port and Providence, R. I., was attempted; and from the rapidity with which the voyages of the 'Lexington' were performed, the proprietors of the old class of vessels were compelled to withdraw them, and substitute others designed upon the new model. So far as this particular passage is concerned, the greater part of which is inland, and within reach of safe and convenient harbours, the experiment, although bold, is not to be considered as involving any notable danger. But it has unluckily happened, that this apparent success has led to the attempt to navigate the ocean in vessels of the same species of model. We cannot believe that these vessels are to be considered as perfectly safe. Their length is as much as eight times their breadth of beam, and the form of their prows and sterns extremely acute: hence the tendency to *hog*, and break their backs is great; and one instance has already occurred, where a new vessel has gone to pieces by mere stress of weather. It may be possible, by trussing, or by diagonal ceilings, to lessen the danger arising from this source; but vessels of this model will be still exposed to being washed from stem to stern by the waves.

We do not class among the objections to steam boats of the new model as sea-going vessels, the fact that the cylinder is wholly raised above the level of the deck. It might at first sight appear that the vessel would in this way be rendered, in nautical language, too crank. But when we consider that the heavy masts and sails with which ships are loaded, are dispensed with altogether in steam boats intended for the navigation of rivers, and may be replaced in those intended for the navigation of the sea by spars of the lightest description, we shall see that the centre of gravity in the latter case, need not be more elevated than it is in ships. Now it is a well known principle in the stowage of ships, that stability is increased for a time by raising the centre of gravity; nay, that were it so low as to coincide with the centre of the part immersed, the condition of equilibrium would be indifferent.¹ It is also a well known fact, that a ship may be rendered more easy, and therefore more safe at sea, by raising the centre of gravity beyond the point at which the greatest degree of stability is attained. May we not, then, question whether the anxiety of the British engineers to keep the weight low has been founded upon correct principles? At any rate, although the American engineers may perhaps have erred on the other extreme, their practice is not as inconsistent with safety as some of their own countrymen have imagined.

One prominent mistake, however, appears to have been committed in the vessels recently constructed for the navigation of the ocean in the United States. Departing from the practice,

¹ We cannot assent to this principle.—ED.

which had become sanctioned by successful usage, of employing two engines placed upon the wheel guards, a single one has been substituted. This being necessarily placed in the plane of the keel, the rolling of the vessel is rendered more rapid, and more likely to be injurious. It is indeed another well known principle in the stowage of vessels, that the rolling is to be rendered less violent by placing the weights at the greatest possible distance from the plane of the keel, as well as at the greatest height which is consistent with stability.

The use of a single vertical engine of long stroke is attended with another difficulty, namely, that it requires a large opening to be left in the deck of the vessel, which cannot be sufficiently defended from the influx of the sea; for the bulkheads which surround it, cannot be rendered strong enough to resist a violent wave.

After all, the main objection to the present model of American steam boats, when considered in their fitness for the navigation of the ocean, is the weakness inherent in the great proportion which their length bears to their breadth and depth. To remedy this defect is not beyond the power of a skilful application of the principles of carpentry. We have already indicated the most obvious method which these principles would suggest, namely, the adoption of the diagonal framing of Seppings, either in the form of trusses, or in the ceiling planks.

This defect being overcome, no doubt can exist that vessels combining great safety with an average speed of at least twelve nautical miles per hour, can be constructed. Such vessels might make the passage from New York to Liverpool in less than twelve days; and with such a speed there can be no reason to doubt that they might carry, in the form of coal, more than a sufficient supply of fuel. A direct passage will be absolutely indispensable to success; for should it be found necessary to make intermediate ports, as for instance, Valentia, or Cork, Halifax, or the Western Islands, the delay consequent on making a harbour, and in taking in fuel, will prevent the passage being performed in a time much less than the average passages of good ships. As the expense of the steam boats will be vastly the greatest, they would not be able to compete with the existing packet ships. On the other hand, in a direct passage performed with the speed of the American steam boats, the saving in time will more than compensate the excess of the daily expense of steam navigation.

Since the preceding paragraphs were written, an experiment has been made with the British steamer, the 'Great Western,' which renders the successful navigation of the Atlantic, between New York and England, without stopping at an intermediate port, no longer a matter of inference, but a fact established by experience. This vessel has carried more than a sufficient supply of coals for the passage; and although having an average speed of no more than nine nautical miles per hour, has been no more than fifteen days in making her harbour. On examining this vessel, and comparing her performance with that of American steam boats, it is easy to perceive that her speed might be very materially increased without making any important change in her engines, and probably with a saving of fuel. It would be necessary to modify the boilers so as to convert a less quantity of water than they now do into steam, but to furnish it of a tension of 20 or 30lbs, instead of $3\frac{1}{2}$, which they now carry. Nor, when the boiler is of sufficient strength, need any increase of danger be apprehended from using steam of this medium pressure. It is now well established that the mere pressure of the steam is among the least important causes of danger, and that such as are most to be apprehended are as likely to occur in using steam of a single atmosphere as that of ten or twelve.

The arrival of the 'Great Western' in New York was preceded by that of the 'Sirius,'

although only by a few hours. The competition for the honour of successfully accomplishing this voyage, between the respective owners and commanders of these vessels, involves less of reputation than is generally believed. It is nearly twenty years since the 'Savannah,' a steam boat built and equipped in the port of New York, made a voyage to Europe and returned. If then new honours are to be awarded, it is to the parties concerned in the 'Great Western' that they are due; for the mere practicability of the enterprise is not the point on which well informed persons have ever hesitated; but the doubt has been whether it can be made certain within given limits of time, and whether these limits will be less than the average passage of packet ships. This point, which the arrival of the 'Sirius' would have left in doubt, is decided by the voyage of the 'Great Western.' The question of the relation between the cost of the enterprise, and the freight, is still undecided. We do not doubt, however, that this will be such as to yield a profit.

The 'Savannah' proceeded from New York to Liverpool without stopping at any intermediate port; from Liverpool to St. Petersburg, touching at Copenhagen. In returning thence this vessel entered the port of Arendal in Norway, and then crossed the Atlantic a second time to New York, without making any intermediate port. Steam, however, was not used during the whole voyage, but the use of the engine was intermitted whenever the wind was such as to enable the vessel to lay her course without deviation. No record appears to remain of the time in which steam alone was used, but the two passages across the Atlantic were each made in twenty-five days.

A year or two after the voyage of the 'Savannah' a splendid vessel was built in New York, intended as a packet between that city and New Orleans. This vessel was 600 tons burthen, rigged as a ship, and propelled by a powerful steam engine. Several voyages were performed successfully by this vessel, but the number of passengers was not found sufficient to defray the expenses, and the vessel was laid up. This vessel had sufficient burthen to have carried fuel for an entire passage to Europe, but the public mind was not prepared for the experiment. The navigation between New York and Charleston S. C. has been for some years partially carried on in steam vessels. These have generally been of small size, and the engines of inferior workmanship to those used upon the Hudson and Long Island Sound. The first attempt to introduce a vessel of larger dimensions and greater cost was unfortunate. The vessel was so weak, in consequence of her extreme length, and the desire to render her buoyant, that in the second voyage she became a perfect wreck at sea, and was with difficulty brought to the land. This was an unfortunate enterprise, not only in the loss of life with which the wreck was attended, but in the check it gave to the spirit of enterprise which was about to be directed to the navigation of the Atlantic.

For three years past, steam packets have plied regularly between Norfolk in Virginia and Charleston S. C., passing the most dangerous part of the southern coast of the United States, the shoals of Cape Hatteras.

At the present time, and for some months back, a steam vessel called the 'North Carolina,' has been employed in the conveyance of passengers between Charleston S. C., and Wilmington N. C. A gentleman who recently travelled by this route informs us that the passage occupied $15\frac{1}{2}$ hours. The distance by sea is 120 nautical miles, to which is to be added the distance of the two places from the ocean.

The performances of some of the American vessels of the new model have been very

extraordinary. The following facts, in relation to two of them, have been derived from a communication of Mr. Haswell, an engineer in the service of the United States, to whom the construction of the machinery of the steam frigate 'Fulton' was confided.

Steam Boat 'Cleopatra.'

Diameter of wheel	.	.	23 feet.
Length of bucket	.	.	11 $\frac{1}{4}$ feet.
Breadth of do.	.	.	2 feet, 8 inches.
Revolutions per minute	.	.	24
Velocity of wheel per second	.	.	28·8 feet.
——— of vessel	.	.	22·6 feet.
Relative velocity of wheel	.	.	6·2

Steam Boat 'Lexington.'

Diameter of wheel	.	.	24 feet.
Length of bucket	.	.	11 feet.
Breadth of do.	.	.	2 feet, 8 inches.
Revolutions per minute	.	.	23
Velocity of wheel per second	.	.	28·8
——— of vessel	.	.	22·5
Relative velocity of wheel	.	.	6·3

These velocities would carry up the speed of the vessels to 15 English miles per hour, and it appears that in many instances such a rate has been attained for a short time. But we have no evidence to adduce that the ordinary average performances of the most recently constructed boats have amounted to more than fourteen English miles per hour. The average passages between New York and Albany do not yet fall much short of eleven hours; and if we allow no more than half an hour for stoppages, the rate is less than fourteen miles.

A speed almost equal is attained in the passage between New York and Providence, Rhode Island. This passage, as we have partly stated, is performed upon the arm of the sea, called at New York the East River, and for its greater extent, Long Island Sound. On leaving this, the open sea is entered, and the voyage, after passing through an open and wide bay, terminates in a narrow river. In its circumstances of alternate shelter and exposure, it may be likened to the passage from London to Calais. The distance, as measured on a good chart, is 160 nautical or 184·3 English miles. We have obtained the records of a voyage performed between the two places, by the steam boat 'Massachusetts,' the circumstances derived from which, with the dimensions of the vessel, are given beneath:—

Length of vessel	.	.	200 feet.
Breadth of beam	.	.	29 $\frac{1}{4}$ feet.
Draught of water	.	.	8 feet, 5 inches.
Diameter of wheel	.	.	22 feet.
Length of bucket	.	.	10 feet.
Depth of do.	.	.	2 feet, 4 inches.
Diameter of cylinder	.	.	3 feet, 8 inches.
Length of stroke	.	.	8 feet.

Number of revolutions	26
Velocity of vessel per second	19·95 feet.
Relative velocity of wheel per second	6·3 feet.
Whole velocity of wheel	26·25 feet.

The passage whence the above data were derived, was performed in thirteen hours and a half, and does not differ materially from the average of those now usually performed.

It would thus appear that no very great increase of speed has been gained in the steam boats used in river navigation since the construction of the 'North America.' As to those which navigate the Sound, the improvement in velocity is considerable, but seems to be attended with a loss of good qualities in other respects. But we are not to estimate the value of the new models from speed alone. It is in the duty of the engines, or the effect produced by a given quantity of fuel, that the newly constructed vessels manifest their superiority. Not only is the size and nominal power of the engines used in boats of given dimensions lessened, but the fuel consumed in the passages is diminished in a still greater ratio. Thus the 'Erie' and 'Champlain,' boats of a newer construction than the 'North America,' but modelled after her, have each two engines 44 inches in diameter, and 10 feet stroke; while the 'Rochester,' 20 feet longer than either, and of two feet less beam, has no more than one engine of the same dimensions. In comparative speed the 'Rochester' has the advantage over the others. The two vessels belonging to the Port of New York, which have the highest reputation for speed, are the 'Passair,' and 'Cornelius Vanderbilt.' The former was constructed by the younger Stevens, and the latter is said to be as near a copy of her dimensions and model, as could be constructed without direct reference to the original moulds. The 'Passair' has not come into direct competition with the vessels which navigate the Hudson, but the 'Cornelius Vanderbilt' exceeds them all in speed. The superiority of this vessel, however, rather consists in the capacity of arriving first at the several landings, in the case of a trial of speed, than in any great reduction of the average time of passage. In fact, to gain several miles in the course of a passage amounts to no more than a saving of a very few minutes of time.

Our view of the subject would be incomplete, did we not refer to a vessel which has been for some months in preparation in the port of New York, for the purpose of running between that city and Liverpool. In this vessel a new form of boiler has been introduced, the principle of whose action is, that the combustion shall be maintained by air forced into a furnace without a chimney, and that the air, after acquiring, by the joint effect of compression and elevated temperature, a tension equal to that of the steam, shall open a valve by which it may join the steam in its passage to the valves of the engine. A sufficient number of experiments have been performed with this boiler, to show that it will produce a given effect at a vast saving of fuel, but various practical difficulties seem to oppose its perfect success.

In conclusion it may be stated, that in respect to speed the steam boats of the Hudson exceed any others, have attained a velocity which is hardly believed to be possible in Europe, and are for the navigation of rivers unequalled. The same principles, modified according to the circumstances of the case, may be applied to give a greater velocity to vessels intended for the navigation of the ocean than has yet been attained by the English steamers. On the other hand, the vessels constructed in the United States for speed, want some of the essential properties of good sea boats. In the competition and honourable rivalry between the engineers and naval architects of the two countries, which the voyage of the 'Great

Western' is likely to call forth, the advantages of the methods which difference of circumstances has brought into use in England and the United States will probably be combined. We may therefore hope to see the rapid motion of the American vessels planned for river navigations, united with the strength, safety, and seaworthy qualities of the British steamers. By such an union the ports of the British channels, and the mouth of the Hudson, will be brought within twelve days' passage of each other, and the time of transit diminished one half. It is difficult to appreciate the advantages which will be mutually derived from such speedy and easy communication, not only to the ports between which it shall be carried on, but to both nations.

LIST OF STEAM VESSELS OF THE LATEST CONSTRUCTION BELONGING TO THE
PORT OF NEW YORK.

Names of vessels.	Length on deck.	Breadth of beam.	Draught of water.	Diameter of wheel.	Length of bucket.	Depth of bucket.	No. of engines.	Diameter of cylinder.	Stroke.	Number of revolutions.
	Feet.	Feet.	Feet.	Feet.	Feet.	Inches.		Inches.		
Steam Frigate Fulton*	181·5	34·5	10	22·4	11·5	36	2	50	9	25
Massachusetts	200·	29·5	8½	22	10	28	2	44	8	26
Narragausett				25	11	30	1	60	12	
Swallow	232·8	22·5	3¾	24·2	11	30	1	46		27
Rochester	200·	25	3¾	23·5	10	24	1	43	10	28
Utica	200	21	3½	22	9½	24	1	39	10	
N. Cobb	176	18	4	20	10	22	2	35	6	
Clifton	135	18	3¾	18·7	7	24	1	25	9	25
Erie	180	27	5½	22	15	34	2	44	10	27½
Champlain										
Belle	190	26	4½	24·5	11	26	1	50	10	25
New York	230	22	4	24	11	30	1	50	10	
Boston	150	28	7½	19	9	30	2	40	7	23
Highlander	181	24	4·3	20	10	30	1	41	10	30
Dewitt Clinton	230·	28	5·5	21	13·7	36	1	65	10	29
Olive Branch, (Ferry boat),	90	23	4¾	15·3	6	22	1	25	8	30
Arrow										
Bolivar	120	24	4	15	5·5	22	1	30	4	30
Fulton, (Ferry boat),	95	25	4·7	15	7	24	1	30	8	25
Neptune, (Charles- ton packet),	220·7	25	7·5	25	9·4	36	1	50	11·5	
Home, (lost on the coast of North Carolina)										
Echo	117	15	3	15	6·5	16	1	20	6	32
Cornelius Vanderbitt	175	24	5·3	22·2	10	24	1	41	10	30

* We are indebted to Lieut. Lynch, of the United States frigate 'Fulton,' for the following additional particulars :—

Tonnage of the United States steam frigate 'Fulton' 875 American tons.

Depth of hold 12 ft.

Power of engine (mean average of steam) 500 H. P.

(Made by Mr. Kemble, agent for the West Point Foundry Association.)

The cylinders are laid nearly horizontal, with a very slight upward inclination.—Ed.

VII.—ON PADDLE WHEELS.

BY ARISTIDES A. MORNAY, ESQ.

UNTIL within the last few years the construction of paddle wheels, although by no means an unimportant part of the machinery of steam vessels, met with little or no attention from men capable of investigating the action and estimating the qualities of this description of machinery; and even now we have but few works on this subject, and those generally of a superficial character, by far the most complete being Mr. P. W. Barlow's paper *On the Motion of Steam Vessels*, published in the Philosophical Transactions for 1834; which, with some important additions, is inserted in another part of this work.

It is well known that the common paddle wheel, which has been almost universally used from the time when the steam engine was first applied to the purpose of propelling vessels, is very defective in its action, owing to the great obliquity of the floats; the immediate consequence of which is the loss of a considerable portion of the power applied, from the reaction of the water not taking place in the direction in which the useful effect is produced. This is what is understood by *oblique action*. Another disadvantage arising from the above cause is the shock received by each float on entering the water, the resistance being the greatest at that instant, when also the smallest proportion of it is beneficially employed, the obliquity of the floats being greater at the beginning and end than at any other part of the stroke. The rapid succession of shocks so produced causes an unpleasant tremulous motion in the vessel, and occasions a further loss of power by checking the motion of the wheel, and thus impairing its effect as a fly wheel. Another bad effect of the great obliquity of the floats is the *back water*, or the water thrown up by the floats as they leave the water, and projected towards the stern of the vessel.

To remedy these defects many different plans have been devised, but few of them have attracted serious attention; the greater number having been erroneous in principle, and frequently extremely inconvenient in practice.

One of the earliest of these inventions is that of Mr. Robertson Buchanan, for which he took out a patent in the year 1813. In his wheel the floats are made to maintain the vertical position during the whole revolution, and consequently there is no oblique action; but during the first and last portions of the stroke the floats impinge upon the water with their front surfaces, thus opposing an additional resistance to the progress of the vessel. For this reason Buchanan's wheel has not come into use, although not very complicated in its construction. This wheel, with a very slight modification, was again patented in 1828 by Mr. A. Bernhard.

Several wheels were so contrived that each float entered the water edgewise, and was then made to turn on an axis radiating from the centre of the wheel until it took the same position as a

float of the common wheel, and so passed the middle of the stroke; after which it was again made to turn on the same radial axis, so as to come out of the water in the same manner as it went in. In these the shock and back water are, no doubt, in a great measure avoided, but the loss of power from oblique action is still greater than in the common wheel; the contrivances also for causing the floats to take the required positions are all very objectionable in a mechanical point of view; so that no advantage has been found to result from the use of wheels constructed on this principle. A wheel of this description was patented in the year 1828 by Messrs. W. and J. Stead, another by Messrs. W. and A. Symington in 1834, and a third was invented in 1829 by Mr. A. Heilbronn, of New York.

In the wheel invented by Lieutenant Skene, R.N., in the year 1828, each float was suspended on a horizontal axis, and its lower part loaded with metal, so as to cause it to enter the water in a vertical position; by the time it had reached the middle of the stroke, a projection on each side had come in contact with the arm of the wheel, causing it then to act precisely as a common radial float to the end of the stroke. It was tried on the 'Sons of Commerce' Gravesend steam boat, and the performance was found to be better when the floats were lashed to the arms, than when free to act as intended by the inventor.

In some wheels the floats have been fixed obliquely, so as to enter and leave the water more gradually, in order to diminish the shock and back water; but the action is more oblique than that of the common wheel. A patent was obtained by Mr. S. Hall in 1836 for a wheel of this description. Mr. J. Perkins proposed to place both the floats and the shafts obliquely; and other arrangements, too numerous to be detailed here, have been proposed, mostly with the object of reducing the shock and back water, without regard to the oblique action.

In 1827, Mr. J. Oldham took out a patent for a very ingenious method of giving each float exactly half the inclination of the radius passing through its centre. By this means the shock and back water, as well as the loss of power from oblique action, were very much reduced; but the objection in practice to the use of spur wheels, by means of which the feathering of the floats was effected, has prevented this wheel from being generally adopted. Several other modes of producing the same effect have been contrived, but similar objections apply to them all.

A wheel which has been employed to a considerable extent is that generally known as Morgan's wheel. In this the floats may be made to enter and leave the water at any required angle, which is therefore regulated in each wheel according to the relative velocities of the wheel and the vessel; and the machinery for this purpose does not appear to have been attended with any serious inconvenience in practice. Since 1829, the date of the patent, a considerable number of government and private steam vessels, both English and foreign, have been fitted with wheels of this construction. In the year 1829, Mr. Poole took out a patent for a wheel in which the action of the floats is the same as in Morgan's wheel; this effect is however produced by means of a very different contrivance, which is attended with several disadvantages. Another wheel, very similar to Morgan's, was invented by Mr. Cavé, engineer at Paris, in 1827, but the action of the floats was much less uniform in consequence of a difference in its construction.

A modification of the common wheel was tried in the year 1833 by Mr. Jos. Field, the object of which was to reduce the shock and back water, without impairing the effect of the

wheel; but it does not appear to have answered Mr. Field's expectations at that time, for it did not come into public notice until 1835, when Mr. E. Galloway, ignorant of what had been previously done by Mr. Field, took out a patent for the same arrangement, since which time it has been applied to a considerable number of private steamers and to a few government vessels; but the experiments hitherto made have not established its superiority over the other kinds of wheel with which it has been compared.

In order to facilitate the following investigation, we will divide the different kinds of paddle wheels into two classes:

I. Paddle wheels with fixed floats.

II. Paddle wheels with feathering floats.

Before, however, proceeding to the examination of each kind of wheel in particular, we will offer some preliminary observations on the motion and action of paddle wheels in general.

ON THE MOTION OF PADDLE WHEELS.

If the paddle wheels of a steam vessel be made to revolve, the vessel being at rest, which is always the case at first starting, any given point of one of the wheels (if of the first class) will describe a circle; but as soon as the vessel has acquired a certain velocity, its path will be lengthened out into a curve, which has been called a *curtate cycloid*; this continues to lengthen as the vessel gains velocity, and becomes *the common cycloid* when the velocity of the vessel is equal to the *circumferential velocity* of the given point. If the speed of the vessel go on increasing, the given point will describe a curve called a *prolate cycloid*.

By *circumferential velocity* is understood the velocity of any point of the wheel relative to the centre of the shaft, or, in other words, what its absolute velocity would be if, the centre being stationary, the wheel made the same number of revolutions in the same time.

It is evident that when the vessel has attained her maximum speed, there will be a series of points in each wheel, situated at an equal distance from its axis, which will describe *common cycloids*: the projection of these points on a plane perpendicular to the axis of the wheel is called the *rolling circle*. All points situated within the circumference of the rolling circle describe *prolate*, and all those without the same *curtate cycloids*.

To illustrate the motion of paddle wheels, we will refer to Plate LXXIV, where Fig. 1 is a diagram of the common wheel as fitted to Her Majesty's steam vessels 'Phœnix' and 'Salamander.' C is the centre of the shaft; r, r, r , represent the arms; and A B, A B, A B, the floats. L L is the water line at the light immersion of the 'Phœnix,' and L' L' at the deep immersion of the 'Salamander.' The extreme radius CA is 10 ft. 6 in.; the depth of the floats 2 feet 6 in.; their breadth 9 ft.,¹ and number 16. The floats are here drawn radiating from the centre, which is not strictly the case in practice, as they are generally fixed on one side of the arms of the wheel; the deviation is, however, so trifling, that it is of no importance. Fig. 2 is intended to show the path of one of the floats according to the result of the mile trial of the 'Phœnix' made at Woolwich to ascertain her speed. The number of strokes per minute

¹ We have since learned that the breadth of the floats of the 'Salamander's' wheels is only 8 ft. 9 in.

made by the engines is stated to have been 21, the speed of the vessel 11·7 statute miles per hour, and the greatest immersion of the floats 2 ft. 6 in., or exactly their own depth. $L L$ (Fig. 2) is the water line, C the centre of the shaft, $D D D$ the circumference of the *rolling circle*, $A B$ the float, and $C A$ the radius, at the commencement of a revolution of the wheel; $C C'$ is the line described by the centre during one revolution, which is equal to the distance traversed by the vessel during the same time; $D' D' D'$ is the position of the rolling circle, and $A'' B''$ that of the float at the end of the revolution. The *curtate cycloid* $A A' A''$ is the line described by the outer edge of the float, and $B B' B''$ that described by its inner edge; and the various positions of the float are shown at intervals of one sixteenth of a revolution. In order to render the motion of the float through the water more distinct, the node has been drawn on an enlarged scale in Fig. 3, where $A a' A''$ is a part of the curve described by the outer edge of the float, and $B b' B''$ a part of that described by its inner edge, $L L$ the water line, $a b$ the position of the float at the instant of entering the water, $a b$ its position soon after the immersion of the lower edge, being the end of one of the intervals mentioned above, $a' b'$ at the end of the next interval, $a' b'$ in the middle of the stroke, and so on, $a'' b''$ being its position at the instant of leaving the water. Figs. 4 and 5 relate to the performance of the 'Salamander' at the mile trial, when the greatest immersion of the floats is stated to have been 5ft. 6 in., the number of revolutions 15, and the speed 8·15 statute miles per hour.

It has already been observed, that every point of a common paddle wheel situated on the circumference of the *rolling circle* describes a common cycloid: let $C A$ in the annexed diagram represent a radius of the wheel, intersecting the circumference of the *rolling circle* at the point B , and let $D E$ be the vertical diameter of the *rolling circle*. On $C D$ as a diameter describe a circle intersecting the radius $C A$ at the point F . The arc $F D$ of this circle is equal to the arc $B D$ of the *rolling circle*, being the measure of twice the angle measured by the latter in a circle of half the radius; therefore if the two circles $E B D$, $C F D$, roll simultaneously along the horizontal straight line $H K$, so as to preserve the same relative positions, the points B and F will coincide at some point G on that line, and will describe two cycloidal

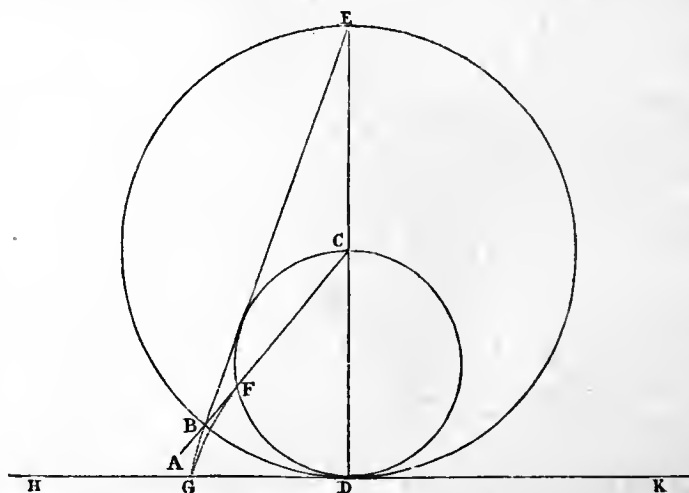

arcs, to the latter of which the radius $C A$, or its production on the opposite side of the centre, will always be tangent at its intersection F with the circumference $C F D$; this point

is, therefore, in any given position of the radius moving in the direction of the radius itself, which consequently has no angular velocity at this point. The whole radius may thus be conceived to move in its own direction, and at the same time to revolve about the point F. If we call ρ the radius of the *rolling circle*, and ϕ the angle A C D contained between the given radius and the vertical, the distance C F is equal to $\rho \cos. \phi$.

ON THE ACTION OF PADDLE WHEELS.

Every paddle wheel may be regarded as a series of levers, coming successively into action. Each lever is represented by one of the arms of the wheels, at the extremity of which a float is attached: the fulcrum is obtained by means of the reaction of the water on the paddle board; the resistance to be overcome is that of the water to the motion of the vessel acting at the centre of the wheel and in the direction of the vessel's course; and the power is that of the engine, applied at the extremity of the crank, which thus forms a bent lever with each arm of the wheel. Now, since the fulcrum is obtained, as above stated, by means of the reaction of the water on the float, and there can be no reaction unless the surface of the float move through the water, it follows that the true fulcrum is situated at that point, on which, if immersed, there would be no reaction. This is the point F found above; for, as it moves in the direction of the surface of the float, it can meet with no resistance from the water. A certain expenditure of power is therefore necessary to force the floats through the water, in addition to that required to propel the vessel.

It is evident that the mean horizontal pressure on the floats of a steam vessel must be equal to the resistance opposed to the motion of the vessel; therefore the motive power must be equal to the mean product of the total pressure on the floats by their velocity perpendicular to their surface, plus the product of the mean horizontal pressure by the velocity of the vessel. This sum in the common wheel is equal to the mean product of the total pressure on the floats by their *circumferential velocity*; for let C A in the annexed figure represent a radius of the wheel, C D a vertical line, and A a point of the surface of the float; also let A B, perpendicular to C A, represent the *circumferential velocity* of the given point, and the horizontal line B G the velocity of the vessel. Join A G, and draw G E parallel to C A. The motion of the given point is in the direction of the line A G, the length of which represents its velocity. Let p be the pressure on the point A in the direction B A, perpendicular to the surface of the float; the pressure in the direction G A will be $p \sin. A G E$, and the power required to overcome that resistance at the velocity A G will be $p \sin. A G E \times A G = p \times A E$. The horizontal pressure is equal to $p \cos. A B G = p \times \frac{B E}{B G}$, which, multiplied into the velocity of the

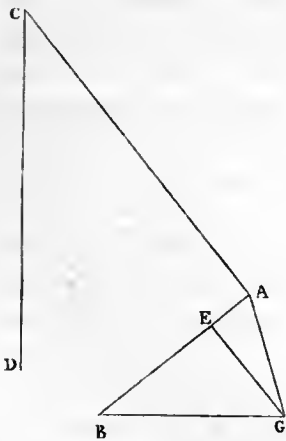

vessel, gives $p \times B E$ for the propelling effect. The sum of these two quantities is $p [A E + B E] = p \times A B$, which is the product of the total pressure on the given point by its *circumferential velocity*, as was to be proved.

This is true only for wheels with radiating floats: in all other cases the *velocity* perpendicular to the surface of the float which the given point would have if the axis of the wheel were stationary, must be substituted for the *circumferential velocity*, and, as in the common wheel the motion of each float is perpendicular to its surface when the axis is at rest, these two velocities are identical.

In order to be able to calculate the absolute amount of power required to produce a given effect, it is necessary to be acquainted with the laws which govern the resistance of fluids to the motion of solid bodies in them, which are generally admitted to be based on the following theorem.—Prop. 1. If a plane surface move at a given velocity through a fluid at rest in a direction perpendicular to itself, the resistance is proportional to the density of the fluid and to the square of the velocity of the plane, or it is equal to the weight of a column of the fluid, whose base is equal to the area of the surface, and altitude equal to the height through which a body must fall by the force of gravity to acquire the given velocity; which, if v denote the velocity of the surface in feet per second, a its area in square feet, and w the weight of a cubic foot of the fluid, is equal to $a w \frac{v^2}{2g}$, the altitude due to the velocity v being $\frac{v^2}{2g}$.

It is assumed that the resistance to a plane moving in a fluid at rest is equal to the pressure of the fluid on the plane at rest, the fluid moving at the same velocity and in the contrary direction to that of the plane in the former case; on which hypothesis the ratio of the square of the velocity is explained in two very different ways. The first is, that “the resistance must vary as the number of particles which strike the plane in a given time, multiplied into the force of each against the plane; but both the number and the force are as the velocity, and consequently the resistance is as the square of the velocity.” The second explanation is, that “the force of the fluid in motion must be equal to the weight or pressure which generates that motion, which, it is known, is equal to the weight of a column of the fluid, whose base is equal to the area of the surface, and altitude the height through which a body must fall to acquire the given velocity.”

These explanations are extracted from Dr. Gregory's Treatise on Mechanics, in which he states that they are founded on the hypothesis that “the particles of the fluid move freely without disturbing each other's motions, and that it flows in behind as fast as a plane body moves forward, so that the pressure on every part of the body is the same as if the body were at rest,” which is well known to be incompatible with the nature of any fluid with which we are acquainted.

In what precedes, only one plane has been mentioned, namely, that which strikes the fluid, the after surface of a body being supposed, by the hypothesis, to have no influence on the resistance; but we know that the pressure on the after surface must decrease as the velocity increases, for if the body were suddenly abstracted, so as to leave a void, the water which had been pressing on the after surface could only move to fill it with the velocity due to its depth below the surface of the fluid; so that, if the body moved forward with a greater velocity, the fluid would cease to be in contact with it, and could not therefore exert any pressure upon it,

much less the same as if the body were at rest. We have not yet met with any explanation of the law according to which this pressure decreases, but we suggest the following.

Let A be a reservoir of fluid, which we will suppose to be water, but the reasoning will apply as well to any other fluid, and let BC be a bent tube communicating with the reservoir by means of the aperture *a*, at a depth *d* below the level of the water in the reservoir, which is supposed to be maintained constant, the part B being horizontal, and the part C vertical and open at the extremity *c*, which is situated at a height *h* above the level of the aperture *a*. It is evident that, neglecting the effect of friction, the water will issue from the orifice *c* with the velocity due to the head *d*—*h*, or, calling *v* the velocity of

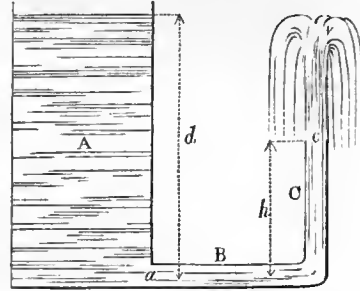

the water, $v = \sqrt{2g(d-h)}$; and, if the sectional area of the tube B be equal to the area of the orifice *c*, the water in it will have the same velocity; so that, if a solid piston were fitted into the tube B, and made to move forward towards the branch C with the above velocity, the pressure on both sides of the piston would be equal, or if the branch C were removed, the pressure of the water in the reservoir on the after surface of the piston would be equal to the weight of a column of water, whose altitude is equal to h or $d - \frac{v^2}{2g}$. Or it may be explained other-

wise, thus: Let a solid body, terminated by a plane at its stern end, move through water in a direction perpendicular to that plane with a given velocity *v*. The water in immediate contact with the surface must evidently have the same velocity if it remains in contact with it; to generate which velocity in the water a pressure is required equal to the weight of a column, whose altitude is $\frac{v^2}{2g}$; this pressure cannot produce any effect on the surface, its force being already expended in producing the motion of the water, and must therefore be deducted from the weight of the total column of water pressing upon the surface when at rest.

Applying this to the case of a prismatic body terminated at both ends by planes perpendicular to its axis, moving through water in the direction of its axis, which is supposed to be horizontal, with a certain velocity *v*, we find for the pressure on an indefinitely small portion ϵ of its after surface, situated at a depth *d* below the level of the water, $\epsilon [d - \frac{v^2}{2g}]$; so that if we suppose the pressure on the head end of the body to be the same as if the body were at rest, i. e. ϵd on an element of the front surface equal and opposite to that on the after surface, the excess of pressure on the former will be $\epsilon [d - (d - \frac{v^2}{2g})]$ or $\epsilon \frac{v^2}{2g}$, which is equal to the whole resistance as generally assumed. There seems to be no reason to suppose the head pressure to increase with the velocity; so that the only addition to be made to the above resistance would be that produced by the cohesion of the particles of water.

Another theorem, founded on the preceding, and applicable to paddle wheels, is the following:—

Prop. 2. If a plane surface move with a given velocity through a fluid in a direction not perpendicular to itself, the resistance is equal to the weight of a column of the fluid, whose

base is equal to the area of the surface, and height that due to the given velocity, multiplied into the cube of the natural sine of the angle of incidence.

Let $A B$ in the annexed figure be the horizontal projection of the given plane, which we suppose to be vertical, and moving in the direction, and with the velocity $B C$; and draw $C D$ perpendicular to $A B$. The pressure on the given surface is by the former theorem proportional to the square of its velocity through the fluid in a direction perpendicular to itself: this velocity is here represented by the line $C D$, for the pressure is precisely the same as it would be if the surface moved in the direction of that line, and with a velocity equal to its length. Thus, calling v the velocity $B C$, i the angle of incidence $A B C$, and p the pressure on the surface perpendicular to its plane, $p = a \frac{v^2 \sin. i^2}{2 g}$, and the resistance in the direction $C B$, which is equal to $p \sin. i$, $= a \frac{v^2 \sin. i^3}{2 g}$.

The power required to overcome this resistance with the velocity v , being equal to the moment of the resistance or the pressure multiplied into the velocity, is $a \frac{v^2 \sin. i^3}{2 g} v$ or $a \frac{v^3 \sin. i^3}{2 g}$, which is the same as if the surface moved perpendicularly to itself with the velocity $v \sin. i$. This may therefore be called the *effective velocity* of the surface.

These two propositions form the basis of all the calculations contained in the present paper.

CLASS I. PADDLE WHEELS WITH FIXED FLOATS.

1. The Common Wheel.

The construction of this wheel is so simple and so well known, that a description of it here would be superfluous, having already referred to the diagram Pl. LXXIV. Fig. 1, which is sufficient for our present purpose; we shall therefore proceed at once to investigate the action of the floats (which, for the sake of simplicity, we shall suppose to be perfectly radial) during their motion through the water.

Let R be the extreme radius of the wheel, r the radius to the inner edge of the floats, a the height of the axis above the level of the water, ϕ the angle which the surface of one of the floats makes with the vertical at any given instant, x the distance of a given point of the surface from the axis, V its *circumferential velocity*, and v the velocity of the vessel, all the measurements being given in feet, and the velocities in feet per second. The velocity of the given point through the water in a direction perpendicular to the surface of the float, which we have called its *effective velocity*, is equal to $V - v \cos. \phi$; for, in the figure page 121, A being the given point, its effective velocity is $A E$; and, the angle $A B G$ being equal to $A C D$ which is equal to ϕ , and $A B$ being equal to V and $B G$ to v , we have

$$A E = A B - B E = V - v \cos. \phi.$$

Let n be the number of revolutions of the wheel per minute, and ρ the radius of the *rolling circle*; the distance travelled by the vessel in a minute = $60 v = 2 \pi \rho n$, whence $v = \frac{\pi \rho n}{30}$.

In like manner $V = \frac{\pi x n}{30}$. These values being substituted in the expression of the *effective velocity*, it becomes

$$\frac{\pi n}{30} [x - \rho \cos. \phi].$$

The factor $x - \rho \cos. \phi$ is the distance of the given point from the point F (V. Fig. page 120).

Let b be the breadth of the float, then $b \cdot dx$ will be the area of an element of its surface extending from one side to the other, and the resistance opposed to its motion, according to the theory already laid down, will be equal to

$$\frac{\pi^2 n^2 bw}{900 \times 2g} [x - \rho \cos. \phi]^2 dx,$$

w being the weight of a cubic foot of water.

If we multiply this expression into the *circumferential velocity* of the element of surface, we have already shown that the product will be the power expended upon it, or the differential of the power expended upon the surface of the float while in the given position. We have therefore, calling p this latter quantity,

$$dp = \frac{\pi^3 n^3 bw}{27000 \times 2g} [x - \rho \cos. \phi]^2 x dx;$$

and supposing the upper edge of the float not to be immersed below the surface of the water, in which case the limits of the values of x are R and $\frac{a}{\cos. \phi}$,

$$p = \frac{\pi^3 n^3 bw}{27000 \times 2g} \int_{\frac{a}{\cos. \phi}}^R [x - \rho \cos. \phi]^2 x \cdot dx$$

$$= \frac{\pi^3 n^3 bw}{27000 \times 2g} \left(\frac{1}{4} R^4 - \frac{2}{3} R^3 \rho \cos. \phi + \frac{1}{2} R^2 \rho^2 \cos. \phi^2 - \frac{1}{4} \frac{a^4}{\cos. \phi^4} + \frac{2}{3} \frac{a^3 \rho}{\cos. \phi^2} - \frac{1}{2} a^2 \rho^2 \right).$$

If we call P the mean power expended on the float during a whole revolution, on the supposition that it is never immersed above its upper edge, and α the angle at which it enters and leaves the water, we shall have

$$P = \frac{\pi^3 n^3 bw}{324000 \times 2g} \int_0^\alpha [3 R^4 - 8 R^3 \rho \cos. \phi + 6 R^2 \rho^2 \cos. \phi^2 - \frac{3 a^4}{\cos. \phi^4} + \frac{8 a^3 \rho}{\cos. \phi^2} - 6 a^2 \rho^2] d \phi.$$

By integration we find, after simplifying,

$$P = \frac{\pi^3 n^3 bw}{324000 \times 2g} \left([3 R^4 + 3 R^2 \rho^2 - 6 a^2 \rho^2] \alpha - [8 R^3 \rho + R^3 a + 2 R a^3 - 3 R a \rho^2 - 8 R a^2 \rho] \sin. \alpha \right).$$

In cases where the upper edge of the float is immersed during a part of the stroke to a certain depth below the surface of the water, the above value of P includes the power which would be expended on a paddle-board extending from the upper edge of the actual float to the surface of the water at the deepest immersion of the radius. This quantity, which is to be deducted from the former, is found by substituting in the value of P , r for R , and β for α ,

β being the angle at which the upper edge of the float enters and leaves the water. The difference multiplied by $2m$, the number of floats in the two wheels, will express the power expended upon them in lbs. raised one foot per second, which is reduced to horse powers by multiplying by 60, the number of seconds in a minute, and dividing by 33000. We find thus for the general expression of the power of the engines of a steam vessel transmitted to the paddle wheels,

$$\text{H.P.} = \frac{\pi^2 n^3 b w m}{89100000 \times 2g} \left\{ [3R^4 + 3R^2\rho^2 - 6a^2\rho^2]\alpha - [8R^3\rho + R^3a + 2Ra^3 - 3Ra\rho^2 - 8Ra^2\rho]\sin.\alpha \right. \\ \left. - [3r^4 + 3r^2\rho^2 - 6a^2\rho^2]\beta + [8r^3\rho + r^3a + 2ra^3 - 3ra\rho^2 - 8ra^2\rho]\sin.\beta \right\} \dots (1)$$

To find the portion of this power which is effective in propelling the vessel, we must first find the mean horizontal pressure on the floats, which, multiplied into the velocity of the vessel, will be equal to the effective power required.

The horizontal pressure on one of the floats in any given position is equal to the product of the total pressure by the cosine of its inclination, or

$$\frac{\pi^2 n^2 b w}{900 \times 2g} \int_{\frac{a}{\cos.\phi}}^R [x - \rho \cos.\phi]^2 \cos.\phi dx.$$

This is equal to

$$\frac{\pi^2 n^2 b w}{900 \times 2g} \left(\frac{1}{3} R^3 \cos.\phi - R^2 \rho \cos.\phi^2 + R \rho^2 \cos.\phi^3 - \frac{1}{3} \frac{a^3}{\cos.\phi^3} + a^2 \rho - a \rho^2 \cos.\phi^2 \right),$$

the mean value of which during an entire revolution is,

$$\frac{\pi n^2 b w}{2700 \times 2g} \int_0^{\alpha} \left(R^3 \cos.\phi - 3 R^2 \rho \cos.\phi^2 + 3 R \rho^2 \cos.\phi^3 - \frac{a^3}{\cos.\phi^3} + 3a^2 \rho - 3a \rho^2 \cos.\phi^2 \right) d\phi.$$

Integrating and simplifying, we find the mean horizontal pressure on one of the floats, supposed to extend to the surface of the water, to be equal to

$$\frac{\pi n^2 b w}{5400 \times 2g} \left\{ \left(6a^2 \rho - 3R^2 \rho - 3a \rho^2 \right) \alpha + \left(2R^3 + 4R \rho^2 - 3Ra\rho - 2Ra^2 - a\rho^2 \cos.a \right) \sin.\alpha \right\}.$$

The quantity to be deducted in cases where the float is immersed above its upper edge, is found in the same manner as it was done for the total power, and the remainder, which then expresses in lbs. the mean horizontal pressure on one of the floats, multiplied into the velocity of the vessel, which is equal to $2\pi\rho n$, in feet per minute, will give the propelling effect due to the float in lbs. raised one foot per minute. We have thus,

$$\text{E.P.} = \frac{\pi^2 n^3 b w \rho}{2700 \times 2g} \left\{ \left(6a^2 \rho - 3R^2 \rho - 3a \rho^2 \right) \alpha + \left(2R^3 + 4R \rho^2 - 3Ra\rho - 2Ra^2 - a\rho^2 \cos.a \right) \sin.\alpha \right. \\ \left. - \left(6a^2 \rho - 3r^2 \rho - 3a \rho^2 \right) \beta - \left(2r^3 + 4r \rho^2 - 3ra\rho - 2ra^2 - a \rho^2 \cos.\beta \right) \sin.\beta \right\}.$$

Multiplying by $2m$, and dividing by 33000, we find, for the general expression of the effective power, or that portion of the power of the engines which is employed in propelling the vessel,

$$\text{H.P.E.} = \frac{\pi^2 n^3 b w \rho m}{44550000 \times 2g} \left\{ (6a^2\rho - 3R^2\rho - 3a\rho^2)\alpha + (2R^3 + 4R\rho^2 - 3Ra\rho - 2Ra^2 - a\rho^2 \cos. a)\sin. \alpha \right. \\ \left. - (6a^2\rho - 3r^2\rho - 3a\rho^2)\beta - (2r^3 + 4r\rho^2 - 3ra\rho - 2ra^2 - a\rho^2 \cos. \beta)\sin. \beta \right\} \dots (2)$$

The mode of applying these formulæ will be illustrated by the following example:—

The wheels of Her Majesty's steam frigate 'Salamander' are 21 ft. in diameter, the paddleboards 8 ft. 9 in. broad, and 2 ft. 6 in. deep, and there are sixteen on each wheel. Thus $R = 10.5$, $r = 8$, $b = 8.75$, and $m = 16$. When tried at Woolwich, the greatest immersion of the floats was 5 ft. 6 in., the number of strokes made by the engines was 15, and the speed 8.15 statute miles per hour. We have therefore $a =$ the height of the axis of the wheel above the surface of the water $= 5$, $n = 15$, and $\rho = \frac{88 \times 8.15}{2 \pi n} = \frac{358.6}{\pi n}$. The angles α and β and their sines are easily found in tables of logarithms, knowing that $\cos. \alpha = \frac{a}{R}$ and $\cos. \beta = \frac{a}{r}$.

We will first apply the formula (1) to find the total power transmitted to the wheels, which is most conveniently done by means of logarithms. We find,

Log. $R = 1.0211893$	Log. $\pi = 0.4971499$
Log. $r = 0.9030900$	Log. $n = 1.1760913$
Log. $a = 0.6989700$	Log. $b = 0.9420081$
Log. $\rho = 0.8813691$	Log. $m = 1.2041200$

We have assumed $w = 64.125$, which is the weight of a cubic foot of sea water, and $2g$, which is the velocity of a falling body at the end of the first second, is equal to 64.38. We find therefore,

$$\text{Log. } w = 1.8070274, \\ \text{Log. } 2g = 1.8087510,$$

Log. $\cos. \alpha = \text{Log. } a - \text{Log. } R = -1.6777807$, and the corresponding angle given in the table of sines and cosines is $61^\circ 33' 47''.2$, and the logarithm of the sine of this angle is found to be equal to -1.9441579 . The length of the arc α is equal to 1.074479 , radius being taken as unity, and its logarithm is consequently 0.0311979 . In the same manner we find by subtracting $\log. r$ from $\log. a$, $\cos. \beta = -1.7958800$, whence $\beta = 51^\circ 19' 4''.14 = 0.8956649$, and $\log. \beta = -1.9521455$, also $\log. \sin. \beta = -1.8924424$. We shall first find the value of the sum of the terms included between the brackets, and then perform the multiplication, by means of logarithms.

Log.	3	=	0.47712				Log.	6 a ² ρ ²	=	3.93883			
„	R ⁴	=	4.08476	„	α	=	0.03120						
„	α	=	0.03120										
„	3 R ⁴ α	=	4.59308	3 R ⁴ α	=	39181	„	6 a ² ρ ² α	=	3.97003	6 a ² ρ ² α	=	9333
„	3	=	0.47712				„	8	=	0.90309			
„	R ²	=	2.04238				„	R ³	=	3.06357			
„	ρ ²	=	1.76274				„	ρ	=	0.88137			
„	α	=	0.03120				„	sin. α	=	-1.94416			
„	3 R ² ρ ² α	=	4.31344	3 R ² ρ ² α	=	20580	„	8 R ³ ρ sin. α	=	4.79219	8 R ³ ρ sin. α	=	61970

Log.	2909	=	3.46377
,,	π^2	=	0.99430
,,	n^3	=	3.52827
,,	b	=	0.94201
,,	w	=	1.80703
,,	m	=	1.20412
,,	$\frac{1}{89100000}$	=	-8.05012
,,	$\frac{1}{2g}$	=	-2.19125

Log. H.P. = 2.18087 H.P. = 151.66.

The nominal power of the engines is 220 h. p. at 22 revolutions per minute, therefore the nominal power with only 15 revolutions is 150 h. p., so that in this case the calculated power surpasses the nominal power by very little more than one per cent. In this calculation some of the resistance has been neglected, viz., that on the arms and the edges of the floats, to which should also be added the effect of the back water and the shock, the amount of which we cannot at present estimate; but as the engines are supposed to work above their nominal power, and it is not known by how much, the above result may be very near the truth.

The following is the calculation of the effective power according to the formula (2).

Log.	6	=	0.77815		Log.	3	=	0.47712	
,,	a^2	=	1.39794		,,	R^2	=	2.04238	
,,	ρ	=	0.88137		,,	ρ	=	0.88137	
,,	α	=	0.03120		,,	α	=	0.03120	
,,	$6 a^2 \rho \alpha$	=	3.08866	$6 a^2 \rho \alpha = 1226.5$,,	$3 R^2 \rho \alpha$	=	3.43207	$3 R^2 \rho \alpha = 2704.4$
,,	2	=	0.30103		,,	3	=	0.47712	
,,	R^3	=	3.06357		,,	a	=	0.69897	
,,	$\sin. \alpha$	=	-1.94416		,,	ρ^2	=	1.76274	
,,	$2 R^3 \sin. \alpha$	=	3.30876	$2 R^3 \sin. \alpha = 2035.9$,,	α	=	0.03120	
,,	4	=	0.60206		,,	$3 a \rho^2 \alpha$	=	2.97003	$3 a \rho^2 \alpha = 933.3$
,,	R	=	1.02119		,,	3	=	0.47712	
,,	ρ^2	=	1.76274		,,	R	=	1.02119	
,,	$\sin. \alpha$	=	-1.94416		,,	a	=	0.69897	
,,	$4 R \rho^2 \sin. \alpha$	=	3.33015	$4 R \rho^2 \sin. \alpha = 2138.7$,,	ρ	=	0.88137	
,,	3	=	0.47712		,,	$\sin. \alpha$	=	-1.94416	
,,	r^2	=	1.80618		,,	$3 R a \rho \sin. \alpha$	=	3.02281	$3 R a \rho \sin. \alpha = 1053.9$
,,	ρ	=	0.88137		,,	2	=	0.30103	
,,	β	=	-1.95215		,,	R	=	1.02119	
,,	$3 r^2 \rho \beta$	=	3.11682	$3 r^2 \rho \beta = 1308.6$,,	a^2	=	1.39794	
					,,	$\sin. \alpha$	=	-1.94416	
,,	$2 R a^2 \sin. \alpha$	=	2.66432	$2 R a^2 \sin. \alpha = 461.7$					

Log.	3	=	0.47712	Log.	a	=	0.69897					
„	a	=	0.69897	„	ρ^2	=	1.76274					
„	ρ^2	=	1.76274	„	cos. α	=	-1.67778					
„	β	=	-1.95215	„	sin. α	=	-1.94416					
„	$3 a \rho^2 \beta$	=	2.89098	$3 a \rho^2 \beta$	=	778.0	„ $a \rho^2 \cos. \alpha \sin. \alpha$	=	2.08365	$a \rho^2 \cos. \alpha \sin. \alpha$	=	121.2
„	3	=	0.47712	„	6	=	0.77815					
„	r	=	0.90309	„	a^2	=	1.39794					
„	a	=	0.69897	„	ρ	=	0.88137					
„	ρ	=	0.88137	„	β	=	-1.95215					
„	sin. β	=	-1.89244	„	$6 a^2 \rho \beta$	=	3.00961	$6 a^2 \rho \beta$	=	1022.4		
„	$3 r a \rho \sin. \beta$	=	2.85299	$3 r a \rho \sin. \beta$	=	712.8	„	2	=	0.30103		
„	2	=	0.30103	„	r^3	=	2.70927	„	sin. β	=	-1.89244	
„	r	=	0.90309	„	$2 r^3 \sin. \beta$	=	2.90274	$2 r^3 \sin. \beta$	=	799.4		
„	a^2	=	1.39794	„	4	=	0.60206					
„	sin. β	=	-1.89244	„	r	=	0.90309					
„	$2 r a^2 \sin. \beta$	=	2.49450	$2 r a^2 \sin. \beta$	=	312.2	„	ρ^2	=	1.76274		
„	a	=	0.69897	„	sin. β	=	-1.89244	„	$4 r \rho^2 \sin. \beta$	=	1446.5	
„	ρ^2	=	1.76274	„	Sum of negative terms	=	8542.8					
„	cos. β	=	-1.79588	„	Sum of positive terms	=	8654.0					
„	sin. β	=	-1.89244	„								
„	$a \rho^2 \cos. \beta \sin. \beta$	=	2.15003	$a \rho^2 \cos. \beta \sin. \beta$	=	141.3						
	Sum of positive terms	=	8654.0									
											111.2	

Log.	111.2	=	2.04610
„	π^2	=	0.99430
„	n^3	=	3.52827
„	b	=	0.94201
„	w	=	1.80703
„	ρ	=	0.88137
„	m	=	1.20412
„	$\frac{1}{44550000}$	=	-8.35115
„	$\frac{1}{2g}$	=	-2.19125

Log. H.P.E. = 1.94560

H.P.E. = 88.23.

Thus a power of 88·23 horses is sufficient, if applied immediately to the vessel; but 151·66 horse powers are required to be applied to the wheels to produce the same propelling effect, the proportion of the effective to the total power being as 0·582 to 1. This shows the loss of power at deep immersions to be very great, even without considering the effects of the shock and back water: it amounts in the above example to more than 63 h. p., or about 41·8 per cent. of the whole power transmitted to the wheels.

It is obvious, that at light immersions, when the upper edge of the float is never under water, all the terms in which β or $\sin. \beta$ enters as a factor disappear, and only one-half of the number of terms remain; and even if the float is immersed a few inches above its upper edge at the middle of the stroke, the amount of those terms is so small, that they may be neglected without causing any material error in the result. For example, if $a = \frac{15}{16}r$ and $\rho = \frac{7}{8}r$, the error is about one per cent.; but if $\rho = a$, then the error is only about one-third per cent. Thus, the diameter of the wheel being 20 ft., the depth of the floats 2 ft., and their greatest immersion 2 ft. 6 in., or 6 inches above their upper edge, the resistance would not be more than one per cent. less than if the floats were made 2 ft. 6 in. in depth, so as to reach the surface of the water. We here suppose the radius of the *rolling circle* to be 7 ft.; if it were only 6 ft. the error would be a little more considerable, but not much, for if the immersion were 3 ft. and the radius of the *rolling circle* 6 ft., the error would not exceed 2 per cent.

If we calculate the power of the 'Phœnix' from the data which we possess, which coincide exactly with those given in Mr. Barlow's tables, except in the diameter of the wheels, which is 21 ft., and not 20 ft. 4 in. as he has there given it, we shall find but 110 h. p. for the power of the engines, or not much more than one-half of the nominal power. It is however very probable that there were some slight errors in the observations; for the dip of the floats is measured before starting, when it is generally not the same as when the vessel is in motion: there is a wave on each side of the vessel, travelling along with it, caused by the displacement of the water, and varying in its position according to the form of the bows: this is sometimes situated directly under the paddle shaft, and then naturally increases the dip of the floats. The mean speed may be a little too great, a difference of a few seconds in the time of running a mile making a difference of half a mile an hour in the speed; it is also next to impossible to know the exact mean number of revolutions made by the wheels in a minute without counting the whole number made during the run. If, during the trial of the 'Phœnix,' the immersion of the floats was 2·8 ft. instead of 2·5 ft., the mean speed 11·23 miles, instead of 11·7, and the mean number of revolutions $21\frac{3}{4}$ instead of 21, we should find for the power of the engines $203\frac{3}{4}$ h. p., which is about 6 per cent. below their nominal power, and it is probable that the dip of the floats was still more considerable.

We have been informed by a gentleman who cannot well be mistaken, that no copy of the official account of the mile trials of Her Majesty's steam vessels at Woolwich has hitherto been published, and we know that some of the dimensions in Mr. Barlow's table are incorrect, so that we cannot rely upon the other figures contained in it; although they coincide with a table which we have obtained from another quarter. Wishing to have authentic data to reason upon, we applied to the Lords Commissioners of the Admiralty for permission to obtain a copy of the official returns, but their lordships declined acceding to our request, and no information is to be obtained at Woolwich dock-yard on this subject. We are at a loss to

conceive the object of so much secrecy: it can hardly answer any useful end, whereas it would be a certain benefit to the nation if the public were made acquainted with all facts relating to steam navigation. We have ascertained the diameters of the following paddle wheels, which differ from those given in Mr. Barlow's table:—'Messenger's,' 20 ft.; 'Dee's,' 20 ft.; 'Rhadamanthus,' 'Salamander,' and 'Phoenix,' each 21 ft.; 'Firefly's,' most probably 18 ft., and the depth of the floats of 'Medea's' wheels, 3 ft. 8 in.

The power expended on the wheels of a steam vessel would be found much more readily if we knew the position of the *centre of pressure*, but we are not aware of any direct method of finding that point.

By *centre of pressure* is understood a point on the surface of the paddle-board at such a distance from the axis of the wheel, that if the whole surface of the board were concentrated in that point, or in the horizontal line passing through it, the mean resistance would not be affected by the change; it does not however follow that the effective resistance would remain unaltered, so that this point is only the centre of total pressure, and not of effective pressure; nor is it the centre of pressure of the float in any given position, but the mean for all the positions taken by the float during its passage through the water, and should therefore, strictly speaking, be called the mean centre of pressure; but as it is already known as the *centre of pressure*, we will retain this expression for the sake of brevity. The position of this point being known, we can find the power in the following manner.

Let y be the distance of the *centre of pressure* from the axis of the wheel, θ the angle at which it enters and leaves the water, a, b, ρ, n and m , the same as in the former calculations, and f the depth of the float. The pressure on the float at any angle ϕ is equal to the product of its area $b f$, by the square of its *effective velocity* and the weight of a cubic foot of water, divided by $2 g$. The *effective velocity* of the float is equal to

$$\frac{\pi n}{30} [y - \rho \cos. \phi],$$

so that the pressure is equal to $\frac{\pi^2 n^2 b f w}{900 \times 2 g} [y - \rho \cos. \phi]^2$,

and the moment of the resistance to $\frac{\pi^3 n^3 b f w}{27000 \times 2 g} [y - \rho \cos. \phi]^2 y$.

The mean value of this expression is equal to the definite integral

$$\frac{\pi^2 n^3 b f w}{27000 \times 2 g} \int_0^\theta [y - \rho \cos. \phi]^2 y. d\phi,$$

which is $\frac{\pi^2 n^3 b f w}{54000 \times 2 g} \left\{ [2 y^3 + y \rho^2] \theta + [a \rho^2 - 4 y^2 \rho] \sin. \theta \right\}$.

This multiplied by $2 m$, and reduced to horse powers, becomes,

$$\frac{\pi^2 n^3 b f w m}{14850000 \times 2 g} \left\{ [2 y^3 + y \rho^2] \theta + [a \rho^2 - 4 y^2 \rho] \sin. \theta \right\} = \text{H.P.} \dots (3)$$

The first member of this equation being equal to the second member of the equation (1) (page 126), it is evident that the sum of the terms between the brackets in the former, multiplied by $6 f$ must be equal to the sum of the terms between brackets in the latter, or, calling S that sum in formula (1), and S'' the sum in formula (3), we must have

$$S'' = \frac{S}{6 f}.$$

Having first found the value of S , and assumed a value of y not very far from the truth, we can prove it with very little trouble by the above formula. If we find too great a value for S'' , we take off a little from our assumed value of y , and if the second result differ still from the true value of S'' , we make a proportion of the differences; the third result will be as near as can be desired, if the differences are small. In this manner the following tables were calculated, in which the extreme radius of the wheel has been assumed equal to 10, or, which is the same thing, one-tenth of the radius has been taken as unity. The immersion is given in the upper line, and the radius of the rolling circle in the first column on the left: the decimal fraction corresponding to the given immersion and radius of the rolling circle, expresses the portion of the depth of the float included between its upper edge and its *centre of pressure*. Thus, if the immersion be 4, and the radius of the rolling circle 7.4 (see Table I.), the *centre of pressure* will be situated at a distance of 0.557 of the depth of the float from its upper edge.

TABLE I.—Extreme radius = 10; Depth of float = 2.

Radius of the Rolling Circle.	DIP OF THE FLOAT.														
	2.00	2.25	2.50	2.75	3.00	3.25	3.50	3.75	4.00	4.25	4.50	4.75	5.00	5.25	5.50
8.0	0.607	0.599	0.593	0.587	0.582	0.577	0.573	0.569	0.566	0.563	0.560	0.557	0.555	0.552	0.550
7.9	0.603	0.596	0.590	0.584	0.579	0.575	0.571	0.567	0.564	0.561	0.559	0.556	0.554	0.551	0.549
7.8	0.599	0.593	0.587	0.582	0.577	0.573	0.569	0.566	0.563	0.560	0.557	0.555	0.553	0.550	0.548
7.7	0.595	0.589	0.584	0.579	0.574	0.570	0.567	0.564	0.561	0.558	0.556	0.554	0.552	0.549	0.547
7.6	0.592	0.586	0.581	0.576	0.572	0.568	0.565	0.562	0.559	0.557	0.555	0.553	0.551	0.548	0.546
7.5	0.588	0.583	0.578	0.574	0.570	0.566	0.563	0.560	0.558	0.556	0.554	0.552	0.550	0.548	0.546
7.4	0.585	0.580	0.576	0.572	0.568	0.565	0.562	0.559	0.557	0.554	0.552	0.550	0.549	0.547	0.545
7.3	0.582	0.578	0.574	0.570	0.566	0.563	0.560	0.557	0.555	0.553	0.551	0.549	0.548	0.546	0.544
7.2	0.580	0.575	0.571	0.567	0.564	0.561	0.559	0.556	0.554	0.552	0.550	0.548	0.547	0.545	0.544
7.1	0.577	0.573	0.569	0.566	0.563	0.560	0.557	0.555	0.553	0.551	0.549	0.547	0.546	0.544	0.543
7.0	0.574	0.570	0.567	0.564	0.561	0.559	0.556	0.554	0.552	0.550	0.548	0.546	0.545	0.544	0.542
6.9	0.572	0.568	0.565	0.562	0.560	0.557	0.555	0.553	0.551	0.549	0.547	0.545	0.544	0.543	0.541
6.8	0.570	0.566	0.563	0.560	0.558	0.556	0.554	0.552	0.550	0.548	0.546	0.545	0.543	0.542	0.540
6.7	0.568	0.564	0.561	0.559	0.557	0.555	0.553	0.551	0.549	0.547	0.545	0.544	0.543	0.541	0.540
6.6	0.565	0.562	0.560	0.558	0.556	0.554	0.552	0.550	0.548	0.546	0.544	0.543	0.542	0.540	0.539
6.5	0.563	0.561	0.559	0.557	0.555	0.553	0.551	0.549	0.547	0.545	0.544	0.542	0.541	0.540	0.538
6.4	0.561	0.559	0.557	0.555	0.553	0.551	0.550	0.548	0.546	0.545	0.543	0.542	0.541	0.539	0.538
6.3	0.559	0.557	0.555	0.553	0.552	0.550	0.549	0.547	0.546	0.544	0.543	0.541	0.540	0.538	0.537
6.2	0.558	0.556	0.554	0.552	0.551	0.549	0.548	0.546	0.545	0.543	0.542	0.540	0.539	0.538	0.536
6.1	0.556	0.554	0.553	0.551	0.550	0.548	0.547	0.545	0.544	0.542	0.541	0.540	0.539	0.537	0.535
6.0	0.554	0.553	0.551	0.550	0.549	0.547	0.546	0.544	0.543	0.542	0.541	0.539	0.538	0.536	0.535

TABLE II.—Extreme radius = 10 ; Depth of float = 2·5.

Radius of the Rolling Circle.	DIP OF THE FLOAT.												
	2·50	2·75	3·00	3·25	3·50	3·75	4·00	4·25	4·50	4·75	5·00	5·25	5·50
7·5	0·607	0·601	0·596	0·591	0·587	0·583	0·579	0·576	0·573	0·570	0·567	0·564	0·562
7·4	0·604	0·599	0·594	0·589	0·585	0·581	0·577	0·574	0·571	0·568	0·565	0·563	0·561
7·3	0·601	0·596	0·591	0·587	0·583	0·579	0·576	0·572	0·569	0·566	0·564	0·562	0·560
7·2	0·598	0·593	0·589	0·585	0·581	0·578	0·574	0·571	0·568	0·565	0·563	0·561	0·559
7·1	0·595	0·590	0·586	0·582	0·579	0·576	0·573	0·570	0·567	0·564	0·562	0·560	0·558
7·0	0·592	0·588	0·584	0·581	0·578	0·574	0·571	0·568	0·566	0·563	0·561	0·559	0·557
6·9	0·590	0·586	0·582	0·579	0·576	0·573	0·570	0·567	0·564	0·562	0·560	0·558	0·556
6·8	0·587	0·583	0·580	0·577	0·574	0·571	0·568	0·565	0·563	0·561	0·559	0·557	0·555
6·7	0·585	0·581	0·578	0·575	0·572	0·569	0·567	0·564	0·562	0·560	0·558	0·556	0·554
6·6	0·583	0·579	0·576	0·573	0·570	0·568	0·565	0·563	0·561	0·559	0·557	0·555	0·553
6·5	0·580	0·577	0·574	0·571	0·569	0·566	0·564	0·562	0·560	0·558	0·556	0·554	0·552
6·4	0·578	0·575	0·572	0·570	0·567	0·565	0·563	0·560	0·558	0·557	0·555	0·553	0·551
6·3	0·576	0·573	0·570	0·568	0·566	0·563	0·561	0·559	0·557	0·555	0·554	0·552	0·551
6·2	0·574	0·571	0·569	0·566	0·564	0·562	0·560	0·558	0·556	0·554	0·553	0·551	0·550
6·1	0·572	0·569	0·567	0·565	0·563	0·561	0·559	0·557	0·555	0·553	0·552	0·550	0·549
6·0	0·570	0·568	0·566	0·563	0·561	0·560	0·558	0·556	0·554	0·552	0·551	0·549	0·548
5·9	0·568	0·566	0·564	0·562	0·560	0·558	0·557	0·555	0·553	0·551	0·550	0·548	0·547
5·8	0·566	0·564	0·562	0·560	0·559	0·557	0·556	0·554	0·552	0·550	0·549	0·548	0·546
5·7	0·564	0·562	0·561	0·559	0·558	0·556	0·555	0·553	0·551	0·549	0·548	0·547	0·546
5·6	0·563	0·561	0·560	0·558	0·557	0·555	0·554	0·552	0·550	0·548	0·547	0·546	0·545
5·5	0·562	0·560	0·559	0·557	0·556	0·554	0·553	0·551	0·549	0·547	0·546	0·546	0·545

The following is a type of the calculation of the power by means of the *centre of pressure*. Let it be required to find the power exerted by the engines of the 'Salamander' in the case proposed at page 127.

The radius of the paddle wheels being 10ft. 6in., the position of the centre of pressure cannot be found immediately by referring to either of the preceding tables, in which the radius is assumed equal to 10 ; we must therefore first find the numbers which represent in the tables the depth and immersion of the floats, and the radius of the rolling circle. The depth of the float is represented by the number 2·38, the immersion by the number 5·238, and the radius of the rolling circle by 7·247. The depth of the float being intermediate between those assumed in the tables, we must first enter Table I. ; and in the column under the immersion 5·25, and opposite to the numbers 7·2 and 7·3, in the first column on the left, we find the numbers 0·545, 0·546, of which we take the mean, 0·5455 ; then in Table II. we do the same,

and find 0.561 and 0.562, of which we take the mean, 0.5615. The difference between 0.5455 and 0.5615, or 0.016, corresponding to a difference of 0.5 in the depth of the float, we find the difference corresponding to 0.38 by the proportion 0.5 : 0.016 :: 0.38 : 0.012, sufficiently near for our purpose, and this added to 0.5455 gives 0.5575 for the proportion of the depth of the float contained between its upper edge and the centre of pressure: the distance of this point from the axis of the wheel, or y , is therefore equal to 9.3937 ft.

Log.	a	=	0.6989700
„	ρ	=	0.8813691
„	y	=	0.9728367
„	θ	=	0.0041126
„	$\sin. \theta$	=	- 1.9276647

Whence,

Log.	$2 y^3 \theta$	=	3.2236527	$2 y^3 \theta$	=	1673.60
„	$\rho^2 y \theta$	=	2.7396875	$\rho^2 y \theta$	=	549.15
„	$a \rho^2 \sin. \theta$	=	2.3893729	$a \rho^2 \sin. \theta$	=	245.12
						2467.87
„	$4 \rho y^2 \sin. \theta$	=	3.3567672	$4 \rho y^2 \sin. \theta$	=	2273.88
						S'' = 193.99

Log.	S''	=	2.2877771
„	π^2	=	0.9942998
„	n^3	=	3.5282738
„	b	=	0.9420081
„	f	=	0.3979400
„	w	=	1.8070274
„	m	=	1.2041200
„	$\frac{1}{2g}$	=	- 2.1912490
„	$\frac{1}{14850000}$	=	- 8.8282735

Log.	H.P.	=	2.1809687
------	------	---	-----------

H.P. = 151.69.

The calculation of the effective power would be abridged in the same manner by means of an analogous point, which we would call the *centre of propelling effect*. This point is so situated, that, if the whole surface of the float were concentrated there, the propelling effect would remain the same; so that, calling z the distance of this point from the axis of the wheel, and ζ the inclination of the float when its centre of propelling effect enters and leaves the water, the propelling effect of a pair of wheels may be found in the following manner:

We know the total pressure on one of the floats at the angle ϕ to be equal to

$$\frac{\pi^2 n^2 b f w}{900 \times 2 g} (z - \rho \cos. \phi)^2,$$

whence the horizontal or effective pressure is equal to

$$\frac{\pi^2 n^2 b f w}{900 \times 2 g} [z - \rho \cos. \phi]^2 \cos. \phi,$$

the mean value of which is

$$\frac{\pi n^2 b f w}{900 \times 2 g} \int_0^{\zeta} [z - \rho \cos. \phi]^2 \cos. \phi. d \phi,$$

or,

$$\frac{\pi n^2 b f w}{2700 \times 2 g} \left\{ [3 z^2 + 2 \rho^2 + \rho^2 \cos. \zeta^2 - 3 a \rho] \sin. \zeta - 3 \rho z \zeta \right\}.$$

The mean effective pressure on the two wheels, which is equal to the resistance opposed to the motion of the vessel, is therefore

$$\frac{\pi n^2 b f w m}{1350 \times 2 g} \left\{ [3 z^2 + 2 \rho^2 + \rho^2 \cos. \zeta^2 - 3 a \rho] \sin. \zeta - 3 \rho z \zeta \right\}.$$

Multiplying this by $\frac{\pi \rho n}{30}$, the velocity of the vessel in feet per second, we find the propelling power in lbs. moved through one foot in a second to be equal to

$$\frac{\pi^2 n^3 b f w m \rho}{40500 \times 2 g} \left\{ [3 z^2 + 2 \rho^2 + \rho^2 \cos. \zeta^2 - 3 a \rho] \sin. \zeta - 3 \rho z \zeta \right\},$$

which, reduced to horse powers, becomes

$$\frac{\pi^2 n^3 b f w m \rho}{22275000 \times 2 g} \left\{ [3 z^2 + 2 \rho^2 + \rho^2 \cos. \zeta^2 - 3 a \rho] \sin. \zeta - 3 \rho z \zeta \right\} = \text{H.P.E.} \dots (4)$$

The first member of this equation being equal to the second member of the equation (2) (page 127), the sum of the terms between the brackets in the former, multiplied by $2 f$, is equal to the sum of the terms between brackets in the latter; or, calling S' that sum in the equation (2), and S''' that in the equation (4), we have

$$S''' = \frac{S'}{2 f}.$$

The following tables were constructed, like the two former, by assuming values for z until the equations (2) and (4) gave the same value of S''' .

TABLE III.—Extreme radius = 10; Depth of float = 2.

Radius of the Rolling Circle.	IMMERSION.														
	2·00	2·25	2·50	2·75	3·00	3·25	3·50	3·75	4·00	4·25	4·50	4·75	5·00	5·25	5·50
8·0	0·595	0·586	0·579	0·573	0·568	0·564	0·560	0·556	0·553	0·550	0·548	0·546	0·544	0·542	0·540
7·9	0·590	0·582	0·576	0·570	0·565	0·561	0·557	0·554	0·551	0·548	0·546	0·544	0·542	0·540	0·538
7·8	0·586	0·578	0·573	0·568	0·563	0·559	0·555	0·552	0·549	0·547	0·545	0·543	0·541	0·539	0·537
7·7	0·582	0·575	0·570	0·565	0·560	0·556	0·553	0·550	0·547	0·545	0·543	0·541	0·539	0·538	0·536
7·6	0·578	0·572	0·567	0·563	0·558	0·554	0·551	0·548	0·546	0·544	0·542	0·540	0·538	0·536	0·535
7·5	0·574	0·569	0·565	0·560	0·556	0·552	0·549	0·546	0·544	0·542	0·540	0·538	0·537	0·535	0·534
7·4	0·571	0·567	0·562	0·558	0·554	0·550	0·547	0·545	0·543	0·541	0·539	0·537	0·536	0·534	0·533
7·3	0·568	0·564	0·559	0·555	0·552	0·549	0·546	0·543	0·541	0·539	0·537	0·536	0·535	0·533	0·532
7·2	0·565	0·561	0·557	0·553	0·550	0·547	0·544	0·542	0·540	0·538	0·536	0·535	0·534	0·532	0·531
7·1	0·562	0·558	0·555	0·551	0·548	0·545	0·543	0·541	0·539	0·537	0·535	0·534	0·533	0·531	0·530
7·0	0·559	0·556	0·552	0·549	0·546	0·544	0·541	0·539	0·537	0·536	0·534	0·533	0·532	0·531	0·530
6·9	0·557	0·553	0·550	0·547	0·545	0·542	0·540	0·538	0·536	0·535	0·533	0·532	0·531	0·530	0·529
6·8	0·554	0·551	0·548	0·546	0·543	0·541	0·539	0·537	0·535	0·534	0·532	0·531	0·530	0·529	0·528
6·7	0·552	0·549	0·546	0·544	0·542	0·540	0·538	0·536	0·534	0·533	0·531	0·530	0·529	0·528	0·528
6·6	0·550	0·547	0·545	0·542	0·540	0·539	0·537	0·535	0·533	0·532	0·530	0·529	0·528	0·528	0·527
6·5	0·548	0·546	0·543	0·541	0·539	0·538	0·536	0·534	0·532	0·531	0·530	0·529	0·528	0·527	0·527
6·4	0·546	0·544	0·542	0·540	0·538	0·537	0·535	0·533	0·531	0·530	0·529	0·528	0·527	0·526	0·526
6·3	0·544	0·542	0·540	0·538	0·537	0·536	0·534	0·532	0·530	0·529	0·528	0·527	0·526	0·526	0·525
6·2	0·542	0·541	0·539	0·537	0·536	0·535	0·533	0·531	0·529	0·528	0·527	0·526	0·526	0·525	0·525
6·1	0·540	0·539	0·538	0·536	0·535	0·534	0·532	0·530	0·529	0·528	0·527	0·526	0·525	0·525	0·524
6·0	0·539	0·538	0·537	0·535	0·534	0·533	0·531	0·530	0·528	0·527	0·526	0·525	0·525	0·524	0·524

TABLE IV.—Extreme radius = 10; Depth of float = 2·5.

Radius of the Rolling Circle.	IMMERSION.												
	2·50	2·75	3·00	3·25	3·50	3·75	4·00	4·25	4·50	4·75	5·00	5·25	5·50
7·5	0·592	0·585	0·579	0·574	0·569	0·565	0·562	0·559	0·556	0·553	0·551	0·549	0·547
7·4	0·588	0·582	0·576	0·571	0·567	0·563	0·560	0·557	0·554	0·552	0·549	0·547	0·545
7·3	0·585	0·579	0·573	0·569	0·564	0·561	0·558	0·555	0·552	0·550	0·548	0·546	0·544
7·2	0·581	0·576	0·571	0·566	0·562	0·559	0·556	0·553	0·551	0·548	0·546	0·544	0·543
7·1	0·578	0·573	0·568	0·564	0·560	0·557	0·554	0·551	0·549	0·547	0·545	0·543	0·541
7·0	0·575	0·570	0·566	0·561	0·558	0·555	0·552	0·550	0·547	0·545	0·543	0·542	0·540
6·9	0·572	0·568	0·563	0·559	0·556	0·553	0·551	0·548	0·546	0·544	0·542	0·540	0·539
6·8	0·569	0·565	0·561	0·557	0·554	0·552	0·549	0·547	0·545	0·543	0·541	0·539	0·538
6·7	0·567	0·563	0·559	0·555	0·553	0·550	0·548	0·546	0·544	0·542	0·540	0·538	0·537
6·6	0·564	0·560	0·557	0·554	0·551	0·548	0·546	0·544	0·542	0·541	0·539	0·537	0·536
6·5	0·562	0·558	0·555	0·552	0·549	0·547	0·545	0·543	0·541	0·540	0·538	0·536	0·535
6·4	0·559	0·556	0·553	0·550	0·548	0·545	0·543	0·542	0·540	0·538	0·537	0·535	0·534
6·3	0·557	0·554	0·551	0·549	0·546	0·544	0·542	0·540	0·539	0·537	0·536	0·534	0·533
6·2	0·555	0·552	0·549	0·547	0·545	0·543	0·541	0·539	0·538	0·536	0·535	0·533	0·532
6·1	0·553	0·550	0·548	0·545	0·543	0·541	0·540	0·538	0·537	0·535	0·534	0·532	0·531
6·0	0·551	0·548	0·546	0·544	0·542	0·540	0·539	0·537	0·536	0·534	0·533	0·532	0·531
5·9	0·549	0·546	0·544	0·542	0·541	0·539	0·538	0·536	0·535	0·533	0·532	0·531	0·530
5·8	0·547	0·545	0·542	0·541	0·539	0·538	0·537	0·535	0·534	0·533	0·531	0·530	0·529
5·7	0·545	0·543	0·541	0·539	0·538	0·537	0·536	0·534	0·533	0·532	0·531	0·530	0·529
5·6	0·543	0·541	0·539	0·538	0·537	0·536	0·535	0·534	0·532	0·531	0·530	0·529	0·528
5·5	0·541	0·540	0·538	0·537	0·536	0·535	0·534	0·533	0·532	0·531	0·530	0·529	0·528

Let us now apply these tables to the case of the 'Salamander,' for which the calculation by the other method is given in pages 129 and 130. The depth of the floats, reduced to the scale of the tables, becomes 2·38, the immersion 5·238, and the radius of the rolling circle 7·247, as at page 134. In Table III., under the immersion 5·25, and opposite to the numbers 7·2 and 7·3 in the first column on the left, we find 0·532 and 0·533, of which we take the mean 0·5325, and in Table IV. we find the numbers 0·544 and 0·546, of which the mean is 0·545. The difference being 0·0125, we make the proportion $0·5 : 0·0125 :: 0·38 : 0·0095$, which, added to 0·5325, gives 0·542 for the proportion of the depth of the float contained between its upper edge and the centre of propelling effect, so that the distance of this point from the axis of the wheel, or z , is equal to 9·355 ft. We have thus,

Log.	a	=	0.6989700
„	ρ	=	0.8813691
„	z	=	0.9710438
„	ζ	=	0.0029913
„	$\sin. \zeta$	=	-1.9269519
„	$\cos. \zeta$	=	-1.7279262

Whence,

Log.	$3 z^2 \sin. \zeta$	=	2.3461608	$3 z^2 \sin. \zeta$	=	221.902
„	$2 \rho^2 \sin. \zeta$	=	1.9907201	$2 \rho^2 \sin. \zeta$	=	97.886
„	$\rho^2 \cos. \zeta^2 \sin. \zeta$	=	1.1455425	$\rho^2 \cos. \zeta^2 \sin. \zeta$	=	13.981

Sum of positive terms = 333.769

„	$3 a \rho \sin. \zeta$	=	1.9844123	$3 a \rho \sin. \zeta$	=	96.474
„	$3 \rho z \zeta$	=	2.3325255	$3 \rho z \zeta$	=	215.043

Sum of negative terms = 311.517

S''' = 22.252

Log.	S'''	=	1.3473691
„	π^2	=	0.9942998
„	n^3	=	3.5282738
„	b	=	0.9420081
„	f	=	0.3979400
„	w	=	1.8070274
„	m	=	1.2041200
„	ρ	=	0.8813691
„	$\frac{1}{2g}$	=	-2.1912490
„	$\frac{1}{22275000}$	=	-8.6521823

Log. H.P.E. = 1.9458386

H.P.E. = 88.275.

When a steamer is heavily laden, the wheels, from their excessive immersion, act less advantageously, besides reducing the number of strokes of the engines by the great number of floats immersed at once, and their great obliquity, which increases the resistance. Under these circumstances the speed of the vessel is naturally diminished, and it may in some cases be desirable to bring out the full power of the engines, as it is called; that is, to enable them to make the full number of strokes they were calculated for, in order to prevent so great a loss of speed. We know but one mode of effecting this, and that is by reefing the floats, or shifting them from the circumference nearer to the shaft. This method is attended at present with too much difficulty and danger to allow of its being put into general practice; but we

do not presume to say that a means may not be found to facilitate the operation, so as to render it practicable.

It is very clear that the desired effect could not be produced by reducing the size of the paddle boards, except inasmuch as the centre of pressure is thereby brought nearer to the axis of the wheel: suppose, for example, that a piece has been cut off from the end of each board; the consequence will naturally be that the circumferential velocity of the wheel will be increased, until the mean pressure on the floats becomes equal to what it was before they were reduced. The pressure being restored, the horizontal pressure will be so too, but cannot surpass what it was before, since the ratio of the horizontal to the total pressure is independent of the breadth of the floats. The speed of the vessel must therefore remain the same, although the expenditure of fuel is increased in the ratio of the increased velocity of the engines. If, on the other hand, we suppose the floats to be reefed, then the engines will not only move so much faster that the floats shall experience the same resistance, but their velocity will increase until the mean pressure on the floats is to the former mean pressure as the former radius to the *centre of pressure* is to the new one. The total pressure being thus increased, the horizontal pressure will be so in a greater proportion, because, the angles of the floats being less oblique, the ratio of the horizontal to the total pressure will be greater; consequently the vessel will go faster. We can only come to this general conclusion at present, as there is no method yet known of finding the precise effect of reefing the floats.

2. Field's Paddle Wheel.

This is what Mr. Field calls the *Cycloidal Wheel*; but as we do not consider that appellation at all suitable, we prefer that adopted at the head of this chapter, Mr. Field having been, to the best of our knowledge, the first inventor of this variety of paddle wheel. It was tried on the 'Endeavour,' a passage steamer, in the year 1833, but was abandoned immediately.

The construction of this wheel is thus explained by Mr. Field in the 'London Journal' for December, 1835:

"Each board is divided into several parts, or narrower boards, and arranged in, or nearly, such cycloidal curves, that they all enter the water at the same place in immediate succession, thus avoiding the shock produced by the entrance of the common board, so unpleasant to passengers, injurious to the vessel, and wasteful of the power. As the acting face of each board is radiating, it propels while passing under the centre in the ordinary way, and when it emerges, the water escapes simultaneously from each narrow board, and consequently cannot lop-up."

Mr. Galloway describes his invention to be exactly the same thing, but goes into geometrical details, which are not mathematically correct.

Fig. 1. Plate LXXV. is a diagram intended to elucidate the construction of this kind of wheel. Not having any data at the time this plate was engraved, we contented ourselves with the same dimensions as those of the common wheel in Plate LXXIV., and supposing the same performances as with the latter, merely with the view of comparing their modes of action. Each board is divided into four narrow boards, *a*, *b*, *c*, *d*, respectively, six, seven, eight, and nine inches in depth. Figs. 2 and 4 show the path of one set of boards at the light and load draught, and Figs. 3 and 5 the nodes, enlarged to four times the scale on account of the complication resulting from the number of boards in the set. On inspecting the two latter

figures, the peculiarity of action arising from this disposition of the paddle boards becomes evident, but more particularly in Fig. 5, where the floats are immersed for a longer time. One set of floats is there seen entering the water at a, b, c, d, the position of which is shown at a', b', c', d', after an interval of one-sixteenth of a revolution; and it is apparent that, while the outer board, a, is moving to the position a', the next board, b, almost follows the track of the former to arrive at b'; in the same manner the third follows the second, and the fourth the third, until they arrive at the middle of the stroke, when they diverge so as to perform the last half of the stroke independent of each other's motions, and emerge from the water at such a distance from each other, that the water which is not thrown off with violence can run off more readily than from the broad float of the common wheel. It thus appears that very little more effect is produced during the first half of the stroke of one set of boards than would be produced by the outer board alone, and during the second half the effect is about equal to that of a common float equal in size to the sum of those which form a set. We conclude, therefore, that the shock received by the floats on entering the water must be reduced nearly to that of the outer board, but that this advantage is gained at the expense of a considerable portion of the effect, in consequence of which the wheels must require a greater surface of paddle board than common wheels. There may also be a little advantage in the manner the floats leave the water, but that, if any, must be very trifling. It is evident that no theoretical calculation can be made of the effect of this wheel, its action being precisely similar to that of the common wheel, except that all but the outer boards move during a considerable part of their stroke in troubled water, whereby a loss of resistance is sustained, the amount of which cannot be computed. It remains, therefore, to be decided by experience whether the disadvantages of this wheel are overbalanced by the advantages which it seems to possess.

It is remarkable that since the adoption of this wheel, when Mr. Galloway made them with six or seven *bars* in each set instead of the ordinary paddle boards, this number has been very much reduced: those now used in Her Majesty's service have only two boards in a set, every reduction having been found to be attended with advantage; they cannot, however, carry their improvements any farther without annihilating the principle of the wheel altogether, and returning to the *common wheel*.

It should here be observed, that in the summer of the year 1837, before these wheels were adopted in Her Majesty's service, a numerous series of experiments were made at Woolwich on Her Majesty's steamer 'African,' under the superintendence of Mr. Ewart, inspector of steam machinery, some with the common wheel, and some with Field's, in order to ascertain the comparative merits of the two wheels. The results of these experiments were not allowed to be publicly known, because *they were not complete*; but Mr. Ewart was so well satisfied with the success of the trials, that Her Majesty's steam vessels 'Rhadamanthus,' 'Dee,' 'Tartarus,' and 'Meteor,' were immediately fitted with Field's wheels, each with two boards in a set. From what we have been able to learn from persons who were present at the experiments alluded to, some very anomalous results were obtained, such as *less velocity of the engines and greater speed of the vessel with less float*, all other circumstances being the same.¹

¹ This is a proof that the accuracy of the mile trials cannot be implicitly relied on, at least as they have been made till now; perhaps they might be made more practically useful, if greater attention were paid to the various circumstances which affect the results.

A few trials were subsequently made with Her Majesty's steam vessel 'Tartarus,' which may throw some light on the relative qualities of the wheel under consideration, and Morgan's wheel. This vessel formerly had a pair of the latter wheels with two fifty horse engines; she has now a pair of wheels with the divided floats, which have been made to go into the old paddle boxes, and two seventy horse engines. When she was tried with the former, she was ready for sea, drawing 12 ft. 2 in. mean, and having an immersed midship section of about 254 square ft.; the steam pressure in the boiler was $2\frac{3}{4}$ lbs., and the vacuum 27 inches. Under these circumstances a mean speed of 8.508 statute miles was obtained, the wheels making 22 revolutions per minute. When tried in February, 1838, with Field's wheels, the mean draught was 9 ft. 11 in., making her immersed midship section about 176 square ft.; the steam pressure was $5\frac{1}{4}$ lbs., and vacuum 28 inches. The mean speed was 11.11 statute miles, with 32 revolutions per minute.

She was tried again on the 11th of March, with her lower masts and shrouds, having provisions and 130 tons of coal on board; she drew about 11 ft. 8 in., and the speed obtained was 8.44 miles, with 24 revolutions: the radius of the *rolling circle* was consequently 4 ft. 11 in., the extreme radius of the wheels being 8 ft. 5 in., so that the *slipping through* of the floats on both these trials was quite extraordinary, and can only be accounted for by the loss of resistance in the first half of the stroke, and the want of a sufficient surface of paddle board, which cannot be given without far surpassing the dimensions required by Morgan's wheels.

Plate LXXXIII. represents the performance on the February trial: it has been drawn on a very large scale, in order to make it less confused than it would otherwise have been; but there have been too many lines inserted that were not absolutely necessary, so that it is still not so distinct as we could have wished. C is the centre of the wheel, of which a part is shown on the right of the plate, as well as a part D D D of the *rolling circle*, at the commencement of a revolution; A A' A'' is the curve described by the extreme edge of the outer board, and B B' B'' that described by the inner edge of the inner board of one set, and C C' the distance travelled by the vessel, during a revolution; at the termination of which the *rolling circle* has arrived at the position D' D' D'. The radius C D of the *rolling circle* is about 4 ft. $10\frac{1}{4}$ in., so that the distance C C' is about 30 ft. $6\frac{1}{2}$ in. Towards the middle of the plate part of the wheel has been drawn, showing the floats which are immersed at the same time with the nodes of their respective *cycloids*, in order to give a more perfect idea of the action. The set 1, 1, which is that of which the whole *cycloid* is given, is near leaving the water; of the next set 2, 2, which has just passed the middle of the stroke, the outer board is about to enter the path which the first set has just traversed, and the inner board has just left the path of the outer one; and of the third and fourth sets the inner boards are following in the very track of the outer ones. It is obvious that the resistance to the floats must be very much diminished by the naturally disturbed state of the water in which they move. Plate LXXXII. *b* represents the above-mentioned performance with Morgan's wheel; it has been drawn on the same scale as the former, for the purpose of comparing the two. It will there be seen that no one of the floats ever enters the path of another, and that the water in which they move cannot be so much troubled as in the former case. The radius of the rolling circle is 5 ft. 5 in., and the distance travelled in one revolution of the wheels consequently 34 ft. The quantity of steam consumed was nearly in the ratio of 5 to 7, and the body to be propelled through the water more considerable, the draught of water being greater, so that

more work was done at much less expense with Morgan's wheels than with the new ones. The dip of the floats in the former case was 5 ft. 8½ in., and the height of the axis above the water only 3 ft. 1½ in.; in the latter case the dip was 3 ft. and the height of the axis above the water 5 ft. 5 in.

The new steam frigate 'Gorgon,' of 1100 tons, has lately been fitted with a pair of Field's wheels, and was tried a short time ago without her masts, drawing 13 ft. 6 in. mean. The wheels made 20½ revolutions per minute, and a mean speed of nearly 10¾ miles was obtained, which gives about 7 ft. 4 in. for the radius of the *rolling circle*, the extreme radius of the wheel being 13 ft. 3 in. The paddle boxes here were also made for Morgan's wheels, so that sufficient width could not be given to those afterwards made for the vessel. This disadvantage must, of course, be taken into account in estimating the value of a wheel. This wheel being now very extensively employed, experience will soon show whether there is any advantage in it or not. Among the principal vessels fitted with these wheels, besides those already named, are the 'Great Western' and the 'British Queen' American packets, and the 'Hermes,' a government steamer of 730 tons.

3. Paddle Wheels with oblique floats.

Such wheels have been tried at various times and under various forms, some of which have been patented. Among these may be named, as the most simple, that for which Mr. Samuel Hall obtained a patent in June, 1836. In this wheel the paddle boards, instead of standing at right angles to the rims and parallel to the axis of the wheel, as in wheels of the ordinary construction, are placed obliquely to the rims and to the axis of the wheel. The subject of the patent is not, however, the use of oblique floats, but the making of one-half of them to enter the water in one diagonal direction, and the other half to enter it in the reverse diagonal direction, or in large paddle wheels, making the boards change their direction of entering the water four times instead of twice. We do not think that any effect can be produced by giving the floats different positions, but that the action would be about the same as that of the ordinary paddle wheel with oblique floats, in which they all incline the same way; and it has been found by experience that this requires a greater surface of paddle board than the common wheel to produce the same effect, which can also be demonstrated theoretically in the following manner:—

The *circumferential velocity* of any given point of a float of the common wheel being V , and the velocity of the vessel v , we have already seen that its *effective velocity* is $V - v \cos. \phi$, and that the pressure upon it is proportional to $[V - v \cos. \phi]^2$; but, with the same given velocities, the *effective velocity* of a point of an oblique float, situated on the radius which passes through the middle of the float, and at the same distance from the axis as the given point in the common wheel, is only $[V - v \cos. \phi] \cos. \alpha$, if α is the angle which the surface of the float makes with the axis of the wheel. The corresponding pressure is therefore proportional to $[V - v \cos. \phi]^2 \cos. \alpha^2$; and, the width of the wheels being the same in both cases, the ratio of the tangential pressure on the oblique float to that on the common float is $\frac{\cos. \alpha^2}{1}$, supposing the whole of the former to radiate from the axis, which is only true for the middle part; but that will not affect the reasoning, as it might easily be shown that there

is rather a disadvantage than otherwise in the float not being radial. The *effective pressure* in the common wheel is proportional to $[V - v \cos. \phi]^2 \cos. \phi$, and in the other to $[V - v \cos. \phi]^2 \cos. \alpha^2 \cos. \phi$. Thus the resistance overcome, and power required to overcome it with the oblique floats, are to the resistance and power required with the common wheel (the dimensions of the wheels and velocities being the same, except that the quantity of float in the former is to that in the latter as 1 to $\cos. \alpha$) nearly in the ratio of $\cos. \alpha^2$ to 1. But if it be required to determine what *circumferential velocity* would be necessary to give the same vessel the same speed as with the common wheel and the *circumferential velocity* V , let V' be the required velocity; then we must have

$$\begin{aligned} [V' - v \cos. \phi]^2 \cos. \alpha^2 &= [V - v \cos. \phi]^2, \\ \text{or } [V' - v \cos. \phi] \cos. \alpha &= V - v \cos. \phi, \\ \text{whence } V' &= \frac{V - v \cos. \phi (1 - \cos. \alpha)}{\cos. \alpha}. \end{aligned}$$

It will be at once observed that this is not a rigorous calculation, and that the above result is not yet determined, as it contains the variable quantity $\cos. \phi$, for which we ought to substitute its average value. Assuming this to be $\frac{9}{10}$, a probable value, and $\cos. \alpha = \frac{3}{4}$, which makes the obliquity less than that preferred by Mr. Hall, viz., 45° , the value of V' becomes

$$V' = \frac{V - \frac{9}{10}v}{\frac{3}{4}} = \frac{50V - 9v}{40}.$$

Assuming v to be equal to $\frac{3}{5}$ of the mean value of V , we find by substitution,

$$V' = \frac{11}{10}V,$$

and, as the resistance overcome is now equal to that overcome with the common wheel at the velocity V , it follows that the former requires about $\frac{1}{10}$ more power than the latter to produce the same effect.

We repeat that the above calculation is not rigorous, but it is obvious that whatever probable values are substituted for α , ϕ , and v , V' will always be found greater than V , which is a sufficient indication of the inferiority of this wheel.

It is superfluous to add, that the same effect would be produced, without altering the velocity of the wheels, by increasing their breadth in the ratio of $\cos. \alpha^2$ to 1, but that would nearly double the weight of the wheels under the circumstances assumed above.

It is evident that, whichever method be adopted, the shock cannot be very much reduced, and, the loss of power from *oblique action* being greater than with the common wheel, the oblique floats are not likely to supersede the ordinary ones.

We shall now briefly notice a modification of this wheel invented by Mr. Jacob Perkins, which we will therefore call *Perkins's paddle wheel*.

4. Perkins's Paddle Wheel.

Mr. Perkins took out a patent for this wheel in the year 1829: it differs materially from all others, although the floats are fixed, as in the preceding, at an angle with the shaft; but that angle is essentially 45° , and the shafts, instead of traversing the vessel in the usual manner, are carried in a sloping direction towards the stern, and meet in the plane of the keel, making with it an angle of 45° , and with each other a right angle. On the extremities of the

shafts farthest from the paddle wheels are fixed bevel wheels, which act upon each other, or are both acted upon by an intermediate bevel wheel in connexion with the steam engine or first mover.

By this arrangement the surface of each float when under the centre is perpendicular to the vessel's course, so that the whole pressure is at that moment effective, and, when over the centre, it is parallel to the course of the vessel, so as to cause the least possible useless resistance.

The *circumferential velocity* of any given point of a float being V , and the velocity of the vessel v , the *effective velocity* of the given point when under the centre is $\frac{V}{\sqrt{2}} - v$, which shows that the upper edge of the float would back water in the middle of the stroke, if the ratio of the velocity of the vessel to the *circumferential velocity* of the inner edges of the floats exceeded $\frac{1}{\sqrt{2}}$.

It is already well established that the more the *circumferential velocity* of the floats of a paddle wheel exceeds the speed of the vessel, the greater is the waste of power; and Perkins's wheel requires a rather large excess, so that this quality, together with the great weight of the wheels compared with that of common wheels of equal effect, the use of bevel wheels to turn the shafts, which must be longer than they usually are, and the inconvenient position of the wheels, which makes it very difficult to support them, and exposes them very much to the action of the winds and waves; all these circumstances are so conclusive of the disadvantage of the system, that it is unnecessary to carry the investigation any farther. An additional argument against the utility of this wheel is, that it has not been adopted in practice.

Several other varieties of paddle wheels with oblique floats have been invented and tried, but without success, and, as there is neither ingenuity nor novelty of invention in any of them, we shall pass them over.

CLASS II.—PADDLE WHEELS WITH FEATHERING FLOATS.

This class may be subdivided into,

- A. Paddle wheels with floats turning on radial axes, and
- B. Paddle wheels with floats turning on horizontal axes or spindles.

A. *Paddle Wheels with floats turning on radial axes.*

Of these very little need be said, as they have not yet been, and are not likely ever to be, adopted. The action of all of them is nearly the same: the floats either enter or leave the water, or both, in the direction of their surface, or at a very acute angle with it. The action is therefore generally *very oblique*; besides which, the mode of feathering the floats is so objectionable, that that alone would be sufficient to condemn the system. The floats are fixed to spindles radiating from the axis of the wheel, each of which is furnished with a crank at its inner extremity, through the medium of which the spindle is made to turn by means of

a groove or other guide fixed to the side of the vessel (as in Symington's wheel), or in the interior of the wheel itself (as in Steed's, &c.). Time will not permit us to give a full description of any of these wheels, nor to enter into any calculation of their effect, which must, however, be quite unnecessary; for a machine tried under such favourable circumstances as Symington's wheel must certainly have been adopted, if it had any claim to preference. A wheel, on a similar principle, with the paddle cranks guided by cams in the interior of the wheel, was tried some years ago in a small boat on the Thames; but the friction was so great, that three or four men could scarcely prevent the boat from being carried down by the tide, although they could easily have rowed her at a moderate speed. The friction of the feathering machinery must in all cases be very considerable; so that, however beautifully it may work at the beginning, there is no doubt that its action would soon be impaired by wear, and it would, perhaps, not require a long time to be entirely destroyed.

B. *Paddle Wheels with floats turning on horizontal axes or spindles.*

1. Buchanan's Wheel.

The principle of this wheel is described by the patentee in his specification in the following manner:

“ In the first place, my said invention is established upon a mathematical theorem, which may be enumerated in the words here underlined, namely: *If two equal rings or circular lines be conceived to revolve, each upon its respective centre in its own plane, with one and the same uniform velocity, and in the same direction with regard to parts of the lines or rings alike situated, and any point be taken in one of the rings or lines, and a right line be drawn from that point parallel to a line supposed to join the centres, until it meets the other line or circle, then I say the right line so drawn will be equal to the line of distance between the centres, and will continue equal and parallel to that line of distance during the whole of every revolution so made.*”

Fig. 1. Pl. LXXVI. is a diagram of Buchanan's wheel, which has been drawn of the same dimensions, and with the same number of floats as those of the 'Phoenix' and 'Salamander.' From the centre of a framing similar to that of the common wheel, and called by the patentee the *Pitch wheel*, r, r, r , are the radii or arms; S, S, S , spindles, working in bearings in the circumference of the Pitch wheel; each spindle is attached to a float, represented in the diagram by the straight line $A B$, which is divided into two equal parts by the spindle, one end of which passes through the Pitch wheel, and is furnished with a lever or crank $S G$. The extremity G of this lever is bent at right angles to $S G$, and works in a bearing on the circumference of a flat wheel or frame $G G G$, called by the patentee the *Connexion wheel*, which turns on an axle fixed to the ship's side, excentrically with respect to the Pitch wheel, its centre being situated at a different point. This axle is made sufficiently large to admit of the shaft passing through it. The crank $S G$ is equal in length, and constantly parallel to the line that joins the two centres.

The float, being fixed to the crank, must evidently remain constantly parallel to a fixed straight line during the whole of each revolution of the wheel, nor can any alteration in the

proportions of the parts cause it to change its position; indeed it would be impossible to make the wheel revolve, if any other length or position were given to the crank or lever S G. This essential property of Buchanan's wheel is amply sufficient to distinguish it from another, known by the name of Morgan's wheel, which we shall treat of in a future part of this paper. We mention this because some persons have confounded these two wheels together from ignorance of their respective properties, although they are widely different both in principle and construction.

Fig. 2. Pl. LXXVI. shows the path of one of the floats of the wheel represented in Fig. 1, under the same circumstances as those of the 'Phoenix' in Fig. 2. Pl. LXXIV. Fig. 3 is the enlarged node. Figs. 4 and 5 correspond with Figs. 4 and 5, Pl. LXXIV., which relate to the trial of the 'Salamander.' In both these cases the floats back water, or move forward in the same direction as the vessel, but most considerably at the deep immersion. We will not, however, investigate the action of the wheel under such circumstances, but suppose the velocity of the wheel to be such that the floats, at their immersion and emersion, shall move in a vertical direction.

In the adjoining figure let C S represent the radius, A B the float, and S the spindle, at the instant the lower edge of the float enters the water, C D a vertical line, A D the water line, and S H a horizontal line, passing through the spindle S and intersecting the line C D at the point H. Let C S = R, C H = a, A B = f, and the breadth of the float = b; let ϕ = the inclination of the radius at any given instant, and its inclination at the instant its lower edge enters the water, or the angle S C D, = α ; also let S E, perpendicular to the radius C S, = the *circumferential velocity* of the float, = V, and v = the velocity of the vessel.

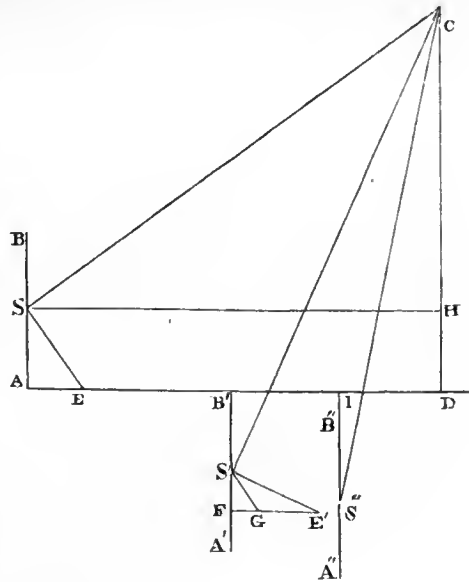

In order that the above-mentioned condition may be satisfied, it is evident that there must exist the following relation between v and V,

$$v = V \cos. \alpha;$$

for v must be equal to A E, which is equal to S E cos. S E A; but the angle S E A = the angle S C D = α ; therefore $v = V \cos. \alpha$; and ρ , the radius of the *rolling circle*, = $R \cos. \alpha = a$.

The *effective velocity* of the float in any given position is $V \cos. \phi - v$. For let A' B' be the given position of the float, the angle S' C D being equal to ϕ , and let S' E', perpendicular to the radius C S', = V, and the portion E' G of the horizontal line E' F, which intersects A' B' at the point F, = v; the straight line S' G will represent the motion of the float both in direction and velocity, and F G, which is perpendicular to its surface, will be equal to its *effective velocity*. Now we have E' F = S' E' cos. S' E' F = $V \cos. \phi$, and E' G = v, therefore *effect. vel.* = F G = E' F - E' G = $V \cos. \phi - v$, or, substituting for V and v their respective values, viz., $V = \frac{\pi R n}{30}$ and $v = V \cos. \alpha = \frac{\pi R n}{30} \cos. \alpha = \frac{\pi a n}{30}$,

$$\text{Effect. vel.} = \frac{\pi n}{30} [R \cos. \phi - a].$$

The corresponding pressure on the float (which is all effective) is equal to the product of its immersed area by the square of its *effective velocity* and the fraction $\frac{w}{2g}$. The immersed area, supposing the float to extend to the surface of the water, is equal to the product of its dip, B' A', by its breadth b , and the dip is, in general, equal to $R \cos. \phi - a$; therefore the pressure is

$$p = \frac{\pi^2 n^2 w b}{900 \times 2g} [R \cos. \phi - a]^3.$$

The moment of resistance due to the given float, being equal to the sum of the products of p by the *effect. vel.* of the float, and by the velocity of the vessel respectively, is equal to $p [F G + G E'] = p. F E' = p V \cos. \phi$, or substituting for p and V their values,

$$\frac{\pi^3 R n^3 w b}{27000 \times 2g} [R \cos. \phi - a]^3 \cos. \phi.$$

The mean value of this expression for the whole revolution of the wheel is equal to the definite integral

$$\frac{\pi^3 R n^3 w b}{27000 \times 2g} \int_0^\alpha [R \cos. \phi - a]^3 \cos. \phi. d \phi,$$

which is

$$\frac{\pi^3 R n^3 w b}{216000 \times 2g} ([3 R^3 + 12 R a^2] \alpha - [13 R^2 a + 2 a^3] \sin. \alpha).$$

This is on the supposition that the float extends to the surface of the water during the whole stroke. If otherwise, let A' B' be the position of the float at the instant its upper edge enters the water, and let the inclination S' C D = β ; we shall then have $R \cos. \beta = a + f$, which for simplicity we will call k . Let A'' B'' (see the figure) be one of the positions of the float, in which its upper edge is immersed to a certain depth I B'' below the surface of the water. In this case we must deduct from the above resistance the portion due to an area of float, whose length is equal to b , and breadth to I B''. Now I B'' = $R \cos. \phi - k$, so that the required area is equal to $b [R \cos. \phi - k]$, and the moment of resistance due to this area is

$$\frac{\pi^3 R n^3 w b}{27000 \times 2g} [R \cos. \phi - a]^2 [R \cos. \phi - k] \cos. \phi.$$

Its mean value is equal to the definite integral

$$\frac{\pi^3 R n^3 w b}{27000 \times 2g} \int_0^\beta [R \cos. \phi - a]^2 [R \cos. \phi - k] \cos. \phi. d \phi,$$

which, after integrating and substituting for $\cos. \beta$ its value $\frac{k}{R}$, becomes

$$\frac{\pi^3 R n^3 w b}{648000 \times 2g} ([9 R^3 + 12 R a^2 + 24 R a k] \beta - [32 R^2 a + 7 R^2 k + 12 a^2 k - 8 a k^2 + 2 k^3] \sin. \beta).$$

The general expression of the moment of resistance due to one of the floats is therefore

$$P = \frac{\pi^2 R n^3 w b}{648000 \times 2g} \left\{ [9 R^3 + 36 R a^2] \alpha - [39 R^2 a + 6 a^3] \sin. \alpha \right. \\ \left. - [9 R^3 + 12 R a^2 + 24 R a k] \beta + [32 R^2 a + 7 R^2 k + 12 a^2 k - 8 a k^2 + 2 k^3] \sin. \beta \right\},$$

and the number of horse powers exerted through the medium of the two wheels with m floats on each,

$$H. P. = \frac{\pi^2 R n^3 w b m}{178200000 \times 2g} \left\{ [9 R^3 + 36 R a^2] \alpha - [39 R^2 a + 6 a^3] \sin. \alpha \right. \\ \left. - [9 R^3 + 12 R a^2 + 24 R a k] \beta + [32 R^2 a + 7 R^2 k + 12 a^2 k - 8 a k^2 + 2 k^3] \sin. \beta \right\} \dots (1)$$

The *effective pressure* being in this wheel equal to the *total pressure* on the floats, or p , and the moment of effective resistance being equal to the product of this quantity by v or $\frac{\pi a n}{30}$, the moment of effective resistance due to one of the floats in any given position, its upper edge not being immersed, is equal to

$$\frac{\pi^2 a n^3 w b}{27000 \times 2g} [R \cos. \phi - a]^3,$$

the mean value of which is equal to

$$\frac{\pi^2 a n^3 w b}{27000 \times 2g} \int_0^\alpha [R \cos. \phi - a]^3. d\phi,$$

or

$$\frac{\pi^2 a n^3 w b}{162000 \times 2g} \left\{ -[9 R^2 a + 6 a^3] \alpha + [4 R^3 + 11 R a^2] \sin. \alpha \right\}$$

The quantity to be deducted for the over-immersion of the float is

$$\frac{\pi^2 a n^3 w b}{27000 \times 2g} \int_0^\beta [R \cos. \phi - a]^2 [R \cos. \phi - k]. d\phi,$$

or

$$\frac{\pi^2 a n^3 w b}{162000 \times 2g} \left\{ -[6 R^2 a + 3 R^2 k + 6 a^2 k] \beta + [4 R^3 + 6 R a^2 + 6 R a k - R k^2] \sin. \beta \right\};$$

so that the general expression of the moment of effective resistance due to one of the floats is

$$E. P. = \frac{\pi^2 a n^3 w b}{162000 \times 2g} \left\{ -[9 R^2 a + 6 a^3] \alpha + [4 R^3 + 11 R a^2] \sin. \alpha \right. \\ \left. + [6 R^2 a + 3 R^2 k + 6 a^2 k] \beta - [4 R^3 + 6 R a^2 + 6 R a k - R k^2] \sin. \beta \right\};$$

and the number of horse powers effectively employed, or the propelling effect of the two wheels,

$$H. P. E. = \frac{\pi^2 a n^3 w b m}{44550000 \times 2g} \left\{ -[9 R^2 a + 6 a^3] \alpha + [4 R^3 + 11 R a^2] \sin. \alpha \right. \\ \left. + [6 R^2 a + 3 R^2 k + 6 a^2 k] \beta - [4 R^3 + 6 R a^2 + 6 R a k - R k^2] \sin. \beta \right\} \dots (2).$$

To find the formula for the *centre of pressure*, let x be the distance of that point from the

lower edge of the float, and θ the inclination of the radius when it enters the water; we shall have

$$\text{Cos. } \theta = \frac{a+x}{R}.$$

The moment of resistance due to the float in any given position is found by substituting, in its former value, the depth of the float f , for the immersion $R \cos. \phi - a$, which gives for its mean value

$$\frac{\pi^2 R n^3 w b f}{27000 \times 2 g} \int_0^\theta [R \cos. \phi - a]^2 \cos. \phi. d \phi,$$

and, after integrating and substituting for $\cos. \theta$ its value, we get

$$\frac{\pi^2 R n^3 w b f}{81000 \times 2 g} \left\{ -3 R a \theta + [2 R^2 + a^2 - a x + x^2] \sin. \theta \right\},$$

which, multiplied by $2 m$ and reduced to horse powers, becomes

$$\text{H. P.} = \frac{\pi^2 R n^3 w b f m}{22275000 \times 2 g} \left\{ -3 R a \theta + [2 R^2 + a^2 - a x + x^2] \sin. \theta \right\} \dots (3)$$

The moment of effective resistance is found in the same manner as above; and if we call z the distance of the *centre of propelling effect* from the lower edge of the float, and ζ the inclination of the radius when that point enters the water, its mean value is

$$\frac{\pi^2 a n^3 w b f}{27000 \times 2 g} \int_0^\zeta [R \cos. \phi - a]^2. d \phi,$$

which, after integrating and substituting for $\cos. \zeta$ its value, $\frac{a+z}{R}$, becomes

$$\frac{\pi^2 a n^3 w b f}{54000 \times 2 g} \left\{ [R^2 + 2 a^2] \zeta - [3 R a - R z] \sin. \zeta \right\}.$$

This gives for the number of horse powers effective, or propelling effect,

$$\text{H. P. E.} = \frac{\pi^2 a n^3 w b f m}{14850000 \times 2 g} \left\{ [R^2 + 2 a^2] \zeta - [3 R a - R z] \sin. \zeta \right\} \dots (4)$$

We regret not having the time to construct tables for these two points, although they would be more interesting than useful, as Buchanan's wheel is not used; we will, however, apply the two first equations to a case that will serve in a measure as a comparison of this with the common wheel.

Let it be required to find the breadth of the floats, and the power of the engines necessary to give the 'Salamander' the same speed under the same circumstances, as on the trial with the common wheels alluded to in a former part of this paper: the extreme diameter of the wheels, the depth of float, and the height of the shaft above the water, being the same; the radius of the *rolling circle*, however, being limited by the condition explained above, the number of revolutions is thereby fixed. All the necessary data will be found at page 127.

The condition that the same effect is to be produced, requires that the value of H. P. E. should be equal to 88.23, as found, page 130, for the common wheel; and, b being the only quantity not yet determined, its value may be found by substituting the value of H. P. E. in the equation (2), which we will now proceed to solve with the assistance of logarithms.

We have $R = 9.25$ ft., $a = 3.75$, $\cos. \alpha = \frac{3.75}{9.25}$, $k = 6.25$, $\cos. \beta = \frac{6.25}{9.25}$, and, since $\rho = a$, we have $n = 30.439$.

Log. $R = 0.96614$	Log. $k = 0.79588$
„ $a = 0.57403$	„ $\beta = -1.91851$
„ $\alpha = 0.06197$	„ $\sin. \beta = -1.86758$
„ $\sin. \alpha = -1.96101$	

Substituting these values, we find,

Log. $4 R^3 \sin. \alpha = 3.46149$	4 $R^3 \sin. \alpha = 2893.9$
„ $11 R a^2 \sin. \alpha = 3.11660$	11 $R a^2 \sin. \alpha = 1308.0$
„ $6 R^2 a \beta = 3.20297$	6 $R^2 a \beta = 1595.8$
„ $3 R^2 k \beta = 3.12379$	3 $R^2 k \beta = 1329.8$
„ $6 a^2 k \beta = 2.64060$	6 $a^2 k \beta = 437.1$
„ $R k^2 \sin. \beta = 2.42548$	$R k^2 \sin. \beta = 266.4$

Sum of positive terms = 7831.0

Log. $9 R^2 a \alpha = 3.52252$	9 $R^2 a \alpha = 3330.6$
„ $6 a^3 \alpha = 2.56221$	6 $a^3 \alpha = 364.9$
„ $4 R^3 \sin. \beta = 3.36806$	4 $R^3 \sin. \beta = 2333.8$
„ $6 R a^2 \sin. \beta = 2.75993$	6 $R a^2 \sin. \beta = 575.4$
„ $6 R a k \sin. \beta = 2.98178$	6 $R a k \sin. \beta = 958.8$

Sum of negative terms = 7563.5

Sum of positive terms = 7831.0

267.5

Log.	267.5	= 2.42732
„	$\frac{\pi^2 a n^3 w m}{44550000 \times 2 g}$	= -1.57217
„	$\frac{\text{H.P.E.}}{b}$	= 1.99949
„	H.P.E.	= 1.94560
„	b	= -1.94611

$b = 0.8833$ ft. = 10.6 inches.

The other question to be solved is, what is the power necessary to produce the required effect. This is found by substituting, in formula (1), the value of b just obtained, as well as those of all the other quantities which enter into it. This operation is in substance as follows:—

Log.	$9 R^3 \alpha$	=	3·91463	$9 R^3 \alpha$	=	8215·4
„	$36 R a^2 \alpha$	=	3·73247	$36 R a^2 \alpha$	=	5401·0
„	$32 R^2 a \sin. \beta$	=	3·87904	$32 R^2 a \sin. \beta$	=	7569·0
„	$7 R^2 k \sin. \beta$	=	3·44084	$7 R^2 k \sin. \beta$	=	2759·6
„	$12 a^2 k \sin. \beta$	=	2·89070	$12 a^2 k \sin. \beta$	=	777·5
„	$2 k^3 \sin. \beta$	=	2·55625	$2 k^3 \sin. \beta$	=	360·0

Sum of positive terms = 25082·5

Log.	$39 R^2 a \sin. \alpha$	=	4·05838	$39 R^2 a \sin. \alpha$	=	11438·8
„	$6 a^3 \sin. \alpha$	=	2·46125	$6 a^3 \sin. \alpha$	=	289·2
„	$9 R^3 \beta$	=	3·77117	$9 R^3 \beta$	=	5904·3
„	$12 R a^2 \beta$	=	3·11189	$12 R a^2 \beta$	=	1293·9
„	$24 R a k \beta$	=	3·63477	$24 R a k \beta$	=	4312·9
„	$8 a k^2 \sin. \beta$	=	2·93646	$8 a k^2 \sin. \beta$	=	863·9

Sum of negative terms = 24103·0

Sum of positive terms = 25082·5

979·5

Log.	979·5	=	2·99100
„	$\frac{\pi^2 R n^3 w b m}{178200000 \times 2 g}$	=	- 1·30853
„	H. P.	=	2·29953
	H. P.	=	199·31.

In this example the ratio of the effective to the total power is only 0·443, which shows that the principle of vertical paddles is in this case fallacious. We do not think it necessary here to enter into the practical objections that may be raised against this wheel, but proceed at once to the next kind that claims our attention, which is,

2. Oldham's Paddle Wheel.

The principle of this wheel will be perfectly understood by conceiving the axis of the excentric in Buchanan's to revolve round the main shaft in the same direction as the latter, and with half its angular velocity. This is effected by fixing a spur wheel on the shaft close to the vessel's side; another on an independent axis fixed to the vessel's side, working in the former; a third on the same axis as the second, and fixed to it, but of a different size; and a fourth fixed to the excentric, or guiding frame, concentrically with the main shaft, working in the third; the dimensions of all being so proportioned that the last shall make one revolution to every two of the first. It follows from this, that as each paddle-crank or lever must of necessity be constantly parallel to the imaginary line which joins the two centres, and as

this line is constantly changing its position, the cranks must be set at different angles with the surface of their respective floats, in order that the latter may all have the same inclination when at the same point of the circumference. Fig. 1. Pl. LXXVII. will explain this arrangement: C is the centre of the wheel, and E that of the guiding frame, $r r r$ the radii or arms; the polygon, or outer frame of the wheel, F F F, is made sufficiently large to include the whole of the floats, in order to have a bearing for cross-stays, which traverse the wheel from one side to the other at the points F F F, &c.; S, S, S, &c., are the spindles with the cranks S G, S G, S G, &c., exactly as in Buchanan's wheel, except that each crank, S G, makes an angle with its float, differing from that of the next on either side by half the angle included between the respective arms of the wheel; g, g, g , &c., are the arms, and G, G, G, the periphery of the guiding frame. The positions of the paddle-crank are easily found by drawing the wheel without the floats with the guiding frame in any arbitrary position (in the figure its centre is immediately over the shaft, but any other position would do as well); the line C E being given, all the cranks must be parallel to it, and the floats radiate from the highest point of the circumference which passes through the spindles; each float being then fixed to its crank, will evidently radiate from the same point during the whole of every revolution of the wheel, and its inclination will consequently always be half that of the radius.

The action of this wheel is theoretically very good, the pressure on the floats being nearly uniform throughout the stroke; but the great friction, liability to get out of order, and other difficulties attending its construction, have hitherto overbalanced its theoretical advantages. The wheel represented in the figure is of the same dimensions as those in the preceding plates, and the same speed and number of revolutions in each of the Figures 2 and 4, as in the corresponding figures in the other plates. In comparing the nodes, Figs. 3 and 5, with those of the other wheels shown in Plates LXXIV., LXXV., LXXVI., the superiority of Oldham's wheels is manifest: the float strikes the water, on entering, less violently than that of the common wheel, having at that moment less *effective velocity*, and there is throughout less loss from *oblique action*, from its inclination being always less: the whole immersed surface of the float is always effective, which gives it another advantage over the divided float of Field's wheel; and the radius of the *rolling circle* is not limited, as with Buchanan's, which causes a great proportion of the power to be spent simply in turning the wheels.

To investigate the action of the floats, let LL be the water line, C the centre of the wheel, S' S'' its vertical diameter, CS one of the radii, AB the float, and S the spindle. Let $R =$ the radius CS; $f =$ AS, the half depth of the float. Produce AB until it meet

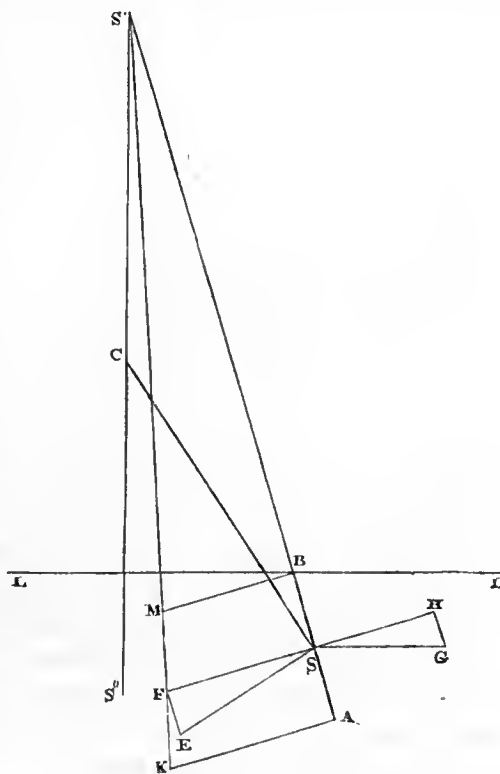

the vertical diameter at the point S' , and let $\delta =$ the angle $S S' S''$ contained between the surface of the float and the vertical. Let $S E$, perpendicular to $C S =$ the *circumferential velocity* of the spindle $= V$, and the horizontal line $S G =$ the velocity of the vessel $= v$. Through the point S draw a straight line $F H$ perpendicular to $A B$, and from the points E and G draw $E F$ and $G H$ perpendicular to $F H$, and meeting it at the points F and H ; the difference between $F S$ and $S H$ will be the *effective velocity* of the spindle. Now, the angle $E S F$ being equal to the angle $S S' S''$ or δ , we have $F S = V \cos. \delta$, and, because the angle $G S H = \delta$, we have also $S H = v \cos. \delta$; therefore, the *effective velocity* of the spindle $= (V - v) \cos. \delta$, which is always positive, for the speed of the vessel is always less than the *circumferential velocity* of the spindle. Through the points S' and F draw a straight line $S' K$, and from any point A of the line $A B$ draw another straight line $A K$ parallel to $S F$, and intersecting the former at the point K ; $A K - S H$ will be the *effective velocity* of the point A : for, since the float always radiates from S' , we may consider that point as the centre of revolution, in which case $S F$ would represent the *circumferential velocity* of the spindle, and consequently $A K$ that of the point A . Now, if we combine this with the horizontal velocity $S G$, and resolve the resultant into two others, one perpendicular and the other parallel to $A B$, the former, which is the *effective velocity* of the given point, will be found to be equal to $A K - S H$. Let $z =$ the distance of the given point from the spindle, taken positively towards the lower edge of the float, and negatively towards its upper edge; then we shall have

$$A K : S F :: A S' : S S',$$

or,

$$A K : V \cos. \delta :: 2 R \cos. \delta + z : 2 R \cos. \delta,$$

whence,

$$A K = \frac{V}{2 R} [2 R \cos. \delta + z],$$

and, deducting $S H$, we shall find the *effective velocity* to be

$$\frac{V}{2 R} [2 R \cos. \delta + z] - v \cos. \delta,$$

or, putting for V and v their values,

$$\text{Effective velocity} = \frac{\pi n}{60} [2 (R - \rho) \cos. \delta + z].$$

From this equation it appears that the difference between the *effective velocities* of any two points on the surface of the float is constant during the whole of the stroke, and that the *effective velocity* of the spindle increases in the same ratio as $\cos. \delta$, therefore the *effective velocity* of any point, and consequently the pressure upon it, increases from the moment it enters the water until it arrives at the middle of the stroke, and then decreases again until it leaves the water. This property causes the shock to be much less than with the common wheel, of which the floats experience the greatest resistance at the beginning and end of the stroke.

A curious property of this wheel is that the *effective resistance* is always equal to the *tangential resistance* at the spindle, which is the resistance to be overcome by the engines; so that the *propelling effect* is to the power employed as the radius of the *rolling circle*, or ρ , is to the radius of the wheel R , which ratio has not been attained by any of the foregoing varieties of wheel. To demonstrate this property, let $p =$ the pressure on any float $A B$ perpendicular

to its surface, that is, in the direction F S; the *tangential pressure*, which is of course in the direction E S perpendicular to C S, is equal to $p \cos. \delta$, since the angle E S F = δ , and the moment of resistance due to the given float is equal to the product of this pressure by the *circumferential velocity* of the spindle, or $p V \cos. \delta$. Now the angle G S H being also equal to δ , we have also the *effective pressure* = $p \cos. \delta$, and $p v \cos. \delta$ = the moment of effective resistance due to the given float; therefore, since in any position of the float the *effective* is to the *total resistance* as v is to V , or as ρ to R , the same proportion must hold good for the sum of all the resistances on the different floats through the whole revolution of the wheels.

The ratio of the speed of the vessel to that of the wheel is even less limited than with the common wheel, or, what is still better, the floats may be made of a greater depth without the upper edge backing water; for it is evident that when the upper edge of a float enters the water, as at B, if the velocity of the vessel be to that of the spindle as B M to S E, or as S' B to S' S, or putting for the two latter their values, as $2 R \cos. \delta - f : 2 R \cos. \delta$, the upper edge of the float will move in the direction of its surface, and will consequently have no *effective velocity* until it has passed that position. Assuming this ratio of velocities, we have

$$\rho : R :: 2 R \cos. \delta - f : 2 R \cos. \delta,$$

whence,

$$\rho = R - \frac{f}{2 \cos. \delta}, \text{ or } f = 2 (R - \rho) \cos. \delta.$$

If the dip of the float in the middle of the stroke be equal to its depth, $\cos. \delta = 1$, and we may have

$$\rho = R - \frac{f}{2}, \text{ or } f = 2 (R - \rho),$$

in which case the *rolling circle* would extend to $\frac{1}{4}$ the depth of the float; and if the velocity of the vessel were to the *circumferential velocity* of the spindles as 11 to 12, we should have

$$f = \frac{R}{6},$$

or the depth of the float one-third of the radius of the wheel. If at the immersion of the upper edge of the float $\cos. \delta = \frac{3}{4}$, which requires a very great immersion, we should have

$$\rho = R - \frac{2f}{3}, \text{ or } f = \frac{3}{2} (R - \rho).$$

Assuming again $\rho = \frac{11}{12} R$, we find

$$f = \frac{R}{8},$$

or the depth of the float = one-fourth of the radius of the wheel.

Thus, in principle, Oldham's wheel is very superior, but in a practical point of view so exceptionable, that unless some much better method of carrying the principle into execution be devised, it never can be made to succeed. It is, however, perfectly useless to attempt the improvement of this wheel, since the one we are about to describe possesses the same theoretical advantages in a still higher degree, and is as simple in construction as can reasonably be expected.

3. Morgan's Paddle Wheel.

This wheel being of some importance on account of the extent to which it has already been employed and its decided superiority over all others that have hitherto been used, and having been very much misrepresented, we feel it necessary to be explicit in showing its peculiarities of principle and construction. The Plates LXXXII. and LXXXII. *a*, are the plan and elevations of the wheel of Her Majesty's steam frigate 'Medea,' of which the principal dimensions are indicated; but, as there are no letters of reference in these plates, we will refer to Fig. 1. Pl. LXXVIII., which is a diagram of Morgan's wheel intended merely to explain its principle, and as a comparison with the other kinds of wheel of which similar diagrams are contained in the preceding plates. The proportions of the parts are not such as are given them by the manufacturer, Mr. William Morgan, being the same as those of the common wheels in Pl. LXXIV. The elevations of the 'Medea's' wheel will give the best notion of Morgan's wheel, as made at present.

This wheel is composed of the following parts: an iron frame-work, forming each side of the wheel, consisting of a *boss*, represented in Fig. 1. Pl. LXXVIII. by the larger of the two circles described with the centre C, (the smaller one is the section of the *shaft*), in the circumference of which are keyed the *arms*, represented by the radial lines *r, r*, &c., and these are united at their outer extremities by a *polygon*, S S S, made of round iron for the sake of lightness; there is also a smaller *polygon*, which is indicated in the figure but without letters, and in large wheels two smaller *polygons*, as in 'Medea's' wheel; these serve to render the frames more compact and firm. The two frames are united together at the angles of the outer polygons, as at S, by means of spindles firmly keyed to the frames, and by *diagonal stays* of iron from the alternate angles of the smaller polygons, in small wheels, to points situated on the opposite arms between the two polygons, so that, if one *diagonal stay* departs from one of the angles of the polygon in the outer frame, and joins the inner frame at a point between the two polygons, the next shall depart from the next angle of the polygon in the inner frame, and meet the outer frame at a point on the opposite arm between the two polygons, and so on alternately. In large wheels, where there are three polygons in each frame, the *diagonal stays* are made in the form of a cross, joining all the angles of the four smaller polygons two by two diagonally, as is seen in the plan of 'Medea's' wheel, Pl. LXXXII. *a*. Each paddle-board is bolted to a kind of frame of iron, called the *stem* (originally the *bent stem*), of which the lever S G forms a part, and which is furnished with two steel *bushes*, made to turn on steel collars fixed on the spindle, which are accurately turned and polished. The *stem-lever* S G is fixed at any angle with the surface of the float which may be most convenient, that, as well as its length, having very little influence on the motion of the float, and none at all, within certain limits, on its inclination as it enters and leaves the water. In order to leave room in the interior of the wheel for the machinery which is to guide the floats, the shaft is only fixed to the *boss* of the inner frame, and does not pass through as in other wheels; this does not, however, much affect the solidity of the wheel, for the *diagonal stays* make it nearly as strong, if not equally so, with no more weight of metal than there would be in the piece of shaft which is dispensed with: in practice, at least, no deficiency of strength has been experienced on that account. The guiding machinery consists of a *crank*,

whose axis is fixed to the spring beam in a line with the main shaft, and passes through the centre of the outer *boss* of the wheel; the *crank head* is shown at E, abaft the axis of the wheel, and slightly elevated above it; on this revolves a *collar*, round the circumference of which are *pin-jointed* the *guide rods*, *h, h, h, &c.*, each of which is pin-jointed at its other end to the extremity G, of one of the *stem levers*. One of the *guide rods*, *g*, is an exception, being keyed, and not pin-jointed, as the others are, to the *revolving collar*, and is called the *driving rod*, because by its means the *collar* is driven, or made to revolve at the same time as the wheel. It acts upon one of the floats in the same manner as the other *guide rods*.

The object of this combination is evidently to regulate the inclination of the floats by alternately increasing and diminishing the distance between the spindles and the excentric centre E, to obtain which centre is the sole intention of the crank; but, as it was found impracticable to make all the *guide rods* as well as the driving rod radiate from that centre, the *revolving collar* was added in order to obtain excentric centres for the rest of the *guide rods*, and this collar ought to be as small as it can conveniently be made, for a large one would cause a variation in the action of the different floats.

There is a great advantage in the mode of hanging the floats in this wheel, which cannot be applied to Buchanan's or Oldham's, viz., that the spindles, being fixed in the frames of the wheel, contribute greatly to its solidity, and the *stem levers*, being situated in the centre of the floats, to which they are firmly fixed, are much more efficient instruments to guide the floats than the cranks in the two other wheels, which, besides being on one side and at a considerable distance from the floats, have very weak bases in consequence of their axes having to turn in bearings in the framing of the wheel, and are thus very liable to ring, which must be very injurious to the action of the wheel, as all the floats are guided by one single piece.

It is astonishing that Morgan's wheel should ever have been for a moment confounded with Buchanan's, the principle and construction of the two differing from each other so widely as they do. The difference of principle has been already pointed out (see page 147), and in construction they differ materially: in Buchanan's wheel the *pin-jointed guide rods* are entirely wanting, and the *revolving collar* is enlarged to the size of the principal framing of the wheel; the levers by means of which the floats are feathered *must* be equal in length, in Buchanan's wheel, to the distance between the centre of the wheel and that of the excentric, while in Morgan's they *never* are; in Buchanan's wheel the spindles *revolve* uniformly in their bearings, for which reason the cranks must be outside the wheel, as otherwise they could not pass, while in Morgan's the floats *vibrate* on their spindles, which motion allows of the stem levers being situated in the interior of the wheel.

Oldham's wheel is still more distinct from Morgan's in construction, by reason of the gear for causing the excentric axis to revolve; it resembles it, however, much more in effect, as the floats are constantly changing their inclination, but the fixed law, that this must always be exactly half that of the radius, allows of no deviation, while in Morgan's wheel there exists no fixed relation between the inclination of the float and that of the radius.

We shall presently have to describe another wheel, which has been declared to be the same as Morgan's, which it resembles very much; namely, that invented by M. Cavé, engineer, at Paris, to whose kindness we are indebted for a drawing of his wheel. In this all the *guide-*

rods are *pin-jointed*, the *revolving collar* being driven by a different instrument from the *driving-rod, g*, in Morgan's wheel, which is not so uniform in its action.

We feel called upon here to correct a statement in Mr. P. W. Barlow's paper "On the motion of Steam Vessels," page 42 of this Appendix, relating to the case of Morgan and another, *versus* Seaward and others. Mr. Barlow states that "The Vice-Chancellor having given judgment against granting an injunction, the parties tried an action at law, in which they were also unsuccessful; and Messrs. Seaward have now the privilege of making these wheels." Now, the state of the case is this. It is necessary before an injunction can be granted that the validity of the patent should be established by an action at law. To this, therefore, the plaintiffs had recourse, in full confidence of success, and they obtained a verdict on the following heads:—

1. That defendants' wheels were only a colourable evasion of plaintiffs' patent, and the former were therefore guilty of infringement;
2. That the specification was sufficient;
3. That the invention was novel and useful;
4. That the wheel was an improvement, but that the engine, which was coupled with it in the same patent, although new, was useless.

The jury, however, under the judge's direction, found for defendants on the ground of previous sale; but it was afterwards decided by the judges in Banco that the alleged sale was no sale at all; nevertheless, as the jury had found that the engine was useless, the judgment must be for defendants, because plaintiffs had coupled in one patent two distinct things, and had therefore committed a fraud on the Crown,¹ thus imposing on them the necessity of pronouncing the patent inoperative. They added, however, that "they had the satisfaction of knowing that this decision would not destroy the patent, as it might be rendered valid by disclaiming the engine before the Attorney-General." We understand that steps are about being taken to effect this object.

Figs. 2 and 4, Pl. LXXVIII., show the path of one of the floats of the wheel represented by Fig. 1, with the same relative velocities as those relating to the common wheel in Pl. LXXIV. Figs. 3 and 5 are the nodes enlarged. It will be seen at once that both the upper and lower edges of the float are nearly tangent to their respective *cycloids* at the time of entering the water, so that there can be no perceptible resistance at that time, and consequently no *shock*; at its emersion the float is also nearly tangent to its course, so that there is no *back water*: the float only raises as much water as adheres to its surface. We have observed, when on board a vessel with Morgan's wheels, which did not act exactly as they ought to have done on account of the draught of water being greater than was intended, that each float, as it left the water, could be easily distinguished through the spray, which must therefore have been very inconsiderable, and that the surface of the water behind the wheels was perfectly level. Whoever has seen the common wheels in action cannot fail to have observed the hillocks or waves formed by the *back water*, which make it sometimes dangerous for little boats to be brought up along side without stopping the engines, and show at the same time that a

¹ Query? Are there no other patents in which two distinct things are included? If there are, have the patentees committed a fraud on the Crown? and if so, why are patents granted in such cases?

considerable amount of power must be spent in raising water. In the vessel alluded to there was also no vibration whatever, so that a gentleman sitting in the cabin was quite surprised to hear that she was not stopping, but going at full speed. Thus the defects, so much complained of in the common wheel, are here quite obviated; nor is it necessary for this, as it is with Buchanan's wheel, to give the wheels an unusually great excess of velocity over that of the vessel: indeed, the inclination of the floats may be regulated to suit any required ratio of velocities. It is to be remembered that the proportions of the parts in the figure referred to above are not such as would be chosen by the manufacturer: there would be fewer floats, but they would have a greater depth, as may be seen in the elevation of 'Medea's' wheel, Pl. LXXXII., and in the diagram of the Trinity yacht 'Vestal's' wheel, Fig. 1, Pl. LXXIX.

Fig. 2 represents a performance of that vessel, from data furnished by the engineer on board. The wheels made 23 revolutions per minute, and the speed was 12·16 statute miles an hour; one revolution, therefore, carried the vessel forward 46 ft. 6½ in., and the diameter of the rolling circle was 14 ft. 9⅓ in., or nearly *eight-ninths* of that of the wheel between the spindles.

It will be observed that the floats are not vertical, as Mr. Barlow repeatedly calls them, notwithstanding that he himself has made a drawing of one (see Fig. 2, Pl. xxiv.), which we presume to be that of His Sardinian Majesty's steam vessel 'Gulnare,'¹ from its resemblance to a lithograph we have seen of that wheel, and in which the floats are evidently *not vertical*. But Mr. Barlow not only calls them vertically acting floats, but calculates the proportion of effective power as if they were really so, and, even on that supposition, his calculation would not be correct, as the Editor has shown in a note at the end of the paper. In Buchanan's wheel the floats are essentially vertical, which we have shown to be rather detrimental to their action than otherwise, particularly at deep immersions, when the loss of power is excessive; and this distinction constitutes the principal advantage which Morgan's wheel possesses over Buchanan's.

But, although the floats are not perfectly vertical, they approach nearer to that position than those of Oldham's wheel; therefore a rather greater proportion of the pressure is effective, and a smaller proportion re-acts upon the arms of the wheel, the former being proportional to the cosine of the angle included between the float and the vertical, and the latter to the cosine of the angle between the float and the radius; therefore the *propelling effect* bears a greater proportion to the *power applied* than the velocity of the vessel to the circumferential velocity of the spindles, which is about the proportion of effective power with Oldham's wheel. Thus

¹ The following particulars relating to this vessel, which we have from an authentic source, may not be uninteresting to the reader. She left Blackwall in the month of April, 1835, and steamed to Sheerness in 3 hours 15 minutes, or at a speed of about 13·5 miles an hour, then proceeded, against a rather strong head wind, to Falmouth, where she arrived after a voyage of 36 hours 30 minutes, making sometimes 10¾ knots, and generally from 9½ to 10 knots an hour, the speed of the engines being maintained between 25 and 27 revolutions per minute. She made the voyage from Falmouth to Lisbon in 75 hours 40 minutes, the sea being so rough that she had almost constantly one of her wheels immersed to the shaft, and the other scarcely touching the water. In the following year she towed a 60 gun frigate, without any assistance, at the rate of 6 knots an hour, her engines making 18 revolutions per minute. Her usual speed was from 10 to 10·5 knots, and the number of revolutions between 28 and 29. In February, 1838, after nearly three years of hard service, we learn that they were repairing the wheels at *Genoa*, with some improvements, which had been introduced in the construction since the 'Gulnare' left this country.

The diameter of the wheels between the spindles is 15 ft., and if we take 9·75 knots as the mean speed between Sheerness and Falmouth, and 26 as the number of revolutions, we find the diameter of the *rolling circle* to have been 12 ft. 2 in., or a little more than *four-fifths* of the diameter of the wheel, which must be rather below than above the ratio of the effective to the total power, exclusive of friction.

in the example of the 'Vestal,' quoted above, more than *eight-ninths* of the power developed by the engines (exclusive of friction) appears to have been effectively employed.

The superiority of Morgan's over the common wheel is shown in a striking manner by the 14th and 21st experiments in Mr. Barlow's table, page 47 of the Appendix. They were both made with Her Majesty's steamer 'Firebrand,' the former with the old wheels, and a pair of 70 horse engines, the latter with Morgan's wheels and a pair of sixties, both light. In the former case her speed was 10·15 miles, and in the latter 10·55, being improved by four-tenths of a mile with one seventh less power. The common wheels had each 14 floats of 18 square ft. area, and Morgan's only 9 floats of less than 13 square ft. area, which proves that the latter kind of wheel does not *require* so much float as *is given* to the former, to produce an equal effect. The economy of fuel arising from the use of Morgan's wheels is also proved by Mr. Barlow's table, page 67, which is merely intended to show the economy of using little power in proportion to the tonnage. This economy exists certainly with the same kind of wheels, but if we compare Morgan's with the common wheel, we find an exception in favour of the former. For example, of the 'Flamer' and 'Hermes,' the latter ought to consume the smallest quantity of coal per ton during the voyage, for two reasons: 1st, because she has much less power in proportion to her tonnage than the former; and 2ndly, because, being a much larger vessel, even with the same ratio of power to tonnage, she ought to consume less fuel per ton by going faster;—the reverse is, however, the case, as is shown by the numbers in column 11. As another example, we may compare the 'Columbia' (Morgan's wheels) with the 'Messenger' (common wheels); here the difference ought to be more than in the foregoing example in favour of the common wheels, whereas it is still more in favour of Morgan's.

The superiority of Morgan's over Field's wheel with divided floats, as the latter has hitherto been used in the Royal Navy, is demonstrated by the trials of the 'Tartarus' (see page 142, and the diagrams, Pl. LXXII. *b*, and LXXIII).

We have now before us a pamphlet published in 1834, containing testimonials of the *beautiful action, strength, and durability* of Morgan's wheels, as well as the increased *safety, economy and comfort*, attending their use, signed by most of the officers who had at that time commanded government steamers fitted with them, as well as by Admiral Sir T. Byam Martin, Vice-Admiral Sir George Cockburn, O. W. Lang, Esq. of Woolwich Dock Yard, and by Charles Russell, Esq., as chairman of the Committee of the Trieste and Venice Steam Navigation Company. Examples of economy are afforded by the experiments on the 'Firebrand' quoted above, and by the voyages of the 'Columbia' and 'Flamer' (see the last mentioned table, page 67). We have also received a letter from Captain Austin, who commanded Her Majesty's steam frigate 'Medea' during her late service of nearly four years.¹ He states that

¹ For the particulars of her performances during that period, see the interesting memoir of Lieut. Baldock, R.N., page 80 of this Appendix, particularly page 86, where her average speed from Plymouth to Malta is shown to have been 8·82 knots an hour, under circumstances by no means favourable, which compare with her average speed as stated by Mr. Barlow, page 71, page 90, respecting her towing the squadron out of Malta harbour; compare also the speed of 9·25 to 10 knots, page 94, and 9·5 knots from Ancona to Malta (against a head wind), page 95, &c. Lastly, see the end of the last paragraph but one in page 98, where the author speaks of the excellence of the machinery, which must apply in a great measure to the wheels, as the engines are no better than in many other steam vessels. The author of this memoir has adopted Mr. Barlow's error of calling the paddles of 'Medea's' wheels "vertically acting paddles."

whether at light or load draught, in smooth water or high sea, he found the action of her wheels to be uniform, causing but very little, if any tremulous motion in the vessel, or jerk to the engines. As regards their durability, he considers that a vessel, if stationed abroad, taking with her a small proportion of "spare spindles," as now fitted, with a spare set of "steel collars" for the spindles, and "bushes" for the stems, she would be fully equal to continue her service for *any* period (with the mechanical powers they might possess in the engine department) that her *engines* might enable her to do. He states that owing to the twisting of the spring beams, the crank head in the wheel lowered considerably, and altered the angles of the floats; but that was of course not to be attributed to any want of solidity in the wheels themselves, nor did it do them any injury. There was no twist owing to the break in the shaft, as has been supposed to be the case, on account of the inner frame only being immediately driven by the engine, for the paint was not disturbed in the joints where the spindles are united to the frames, which must otherwise have been the case. In conclusion, Captain Austin expresses his opinion that if the part of the vessel alluded to (the spring beams) were properly secured, Morgan's wheels would be, as *sea propellers, most valuable and perfect.*

4. Cavé's Paddle Wheel.

Plate LXXXI. Fig. 1., is an elevation of the first wheel made by M. Cavé on his improved construction: it is reduced from a drawing on a larger scale, which that gentleman had the kindness to send from Paris, with a note stating it to be the drawing of the wheels fitted by him in the year 1827, to the iron steam boat 'La Seine.' P, P, P, &c. is the *polygon*; r, r, &c. the *arms*; C the *shaft* in the centre of the *boss*; A, A, &c. are the *floats*; D, D, &c. the *stems*; h, h, &c. the *guide rods*; B the *excentric axis* fixed to the side of the vessel, of which the centre is at E, and which is sufficiently large to allow the shaft C to pass through it; F the *revolving collar*, turning on the excentric B; and g the *driving rod*, fixed to the revolving collar, and passing between two friction rollers k, k, attached to the polygon; L L is the water line. Now, since the point of contact between the roller and the driving rod must move nearly in the circumference of the dotted circle, which is sometimes nearer and sometimes farther from the excentric centre E, there results a difference in the velocity with which the revolving collar is driven round: in the wheel represented in the figure the maximum velocity is nearly double the minimum. This causes the great variations in the position of the different floats and their guide rods, shown by the dotted lines in the figure: the floats are numbered on the outer ring of the revolving collar, close to the pins by which their respective guide rods are jointed to it; the numbers on the excentric axis show the positions which the corresponding pins take, and those at the extremities of the lower floats, the positions of the respective floats when their spindles arrive at the same positions. These variations must cause a great irregularity in the action of the floats, and it is evident that only one or two can take approximately the required positions during their motion through the water. Fig. 2. represents a wheel on Morgan's construction of the same dimensions as the former, in which it was attempted to show, as in the other, the various positions of the different floats, but it was found to be impracticable, the only variation sensible on this scale being that of the guide rod Number 4, of which the positions are shown by dotted lines passing through the three lower guide rods; the variations of the float were, however, imperceptible. The only

difference which has been made in the dimensions, in order to convert Cavé's wheel into Morgan's, is that the excentric collar F has been made much smaller than it was possible according to the other construction, and this diminution tends to equalize the motion of the floats; but what equalizes it still more is that a driving rod of a constant, and always greater length, has been substituted for one which was always varying. Another difference, which could not appear in the figures, and which, in our opinion, operates in favor of Morgan's wheel, is that the excentric in Cavé's is outside, and in Morgan's inside the framing of the wheel.

Some remarks on Mr. P. W. Barlow's calculations, &c.

Very little can be said regarding his mode of determining the *centre of pressure* of floats, since he has *assumed*, and not calculated its position; or rather, he has assumed an empirical rule (see page 45), which facilitates the calculation very much, but clearly cannot suit all cases. In the following page he assumes the *centre of pressure* in Morgan's wheel to be situated at one-eighth of the depth of the float below its centre. We think he allows too much for the lower part acting during a longer period than the upper; for until the point which he considers as the *centre of pressure* enters the water, the power expended on the immersed portion has amounted to scarcely any thing. This trifling quantity being neglected, the resistance in the ensuing portion of the stroke is increased materially, being considered as equal to what it would be if the whole surface of the float were acting at the *centre of pressure*, while at first only three-eighths of it are actually immersed; and as the difference between the *effective velocities* of different parts of the float is not great, it appears that much more resistance is added after the *centre of pressure* has entered the water, than was neglected at the commencement of the stroke. We do not, indeed, deem it improbable that the *centre of pressure* is situated as high, or even higher than the centre of the float.

The method of finding the whole power exerted by the engines adopted, (page 50), can seldom, if ever, give a correct result; for the number of floats acting at one time varies very much in different wheels, and in the same wheels at different immersions; that is, the mean number varies, for there may be in two cases sometimes three, and sometimes four in the water at the same time, and yet the mean number may be different: in one case it may be $3\frac{1}{4}$ and in the other $3\frac{3}{4}$; and, as Mr. Barlow assumes it either at $3\frac{1}{2}$ or 4, the error may be $\frac{1}{12}$ or $\frac{1}{15}$ of the true power exerted, of which the mean number of floats acting at the same time is a factor. Such an error cannot surely be considered of no consequence, particularly as errors of observation are inevitable in such experiments as those made to ascertain the speed of steam vessels. A fact which proves Mr. Barlow's calculations of power to be inaccurate, is that the proportion of the power expended on the vertical paddle in the experiment of the 'Salamander,' differs from the calculated proportion by more than 72 per cent. This is the very example we have worked out (page 127), and found the calculated to agree with the nominal power in a remarkable degree, although calculated according to the same theory as that adopted by Mr. Barlow, but without any arbitrary assumptions, which are probably in a great measure the cause of the discrepancies observed by him, and of his being unable to account for the whole power with Morgan's wheel, though this is, perhaps, principally to be attributed to his confounding it with Buchanan's.

The experiments, of which the details are given in Table IV., page 55, having been made with small models, it is impossible to place any confidence in the results, or of course in any conclusions drawn from them.

In the second paragraph, page 71, we presume that the word "engine" has been used for "paddle wheels;" for the engine itself cannot act as a fly wheel, since its momentum is destroyed at the end of every stroke; but the paddle wheels are allowed by the motion of the vessel to act as such, as they retain their momentum as long as the engines continue in action.

In comparing a steam ship of war, such as the 'Medea,' with others, whose destination is either to carry goods or passengers, it should be remembered that the latter are susceptible of much greater capabilities for speed than the former for the reasons assigned by Lieutenant Baldock, page 81. Besides this, the power of the 'Berenice' being greater, and her tonnage less, than that of the 'Medea,' it would not be at all surprising if the speed of the former were greater than that of the latter, as it appears in page 74; but experience shows 'Medea's' mean speed to be much more than 7·8 knots; indeed, from Lieutenant Baldock's Memoir, her mean speed in all weathers, principally with adverse winds, seems to have been about 9 knots an hour. Her rate of steaming with 320 tons of coal, and war equipment 50 tons more, most probably also water and provisions for 120 men for 4 months, on board, in a calm is (page 85) $8\frac{1}{2}$ knots, and with one-third the quantity of fuel, 10 knots.

We have now investigated the action of the principal kinds of paddle wheels which have been seriously expected to supersede the common wheel, and we find Morgan's wheel to excel the others in all points except simplicity, in which, of course, it must cede to all those with fixed floats, but it is not more complicated than is absolutely necessary to produce the desired effect; for what can be more simple for a feathering float than the float itself suspended on a spindle in the circumference of the wheel, with an arm or lever fixed to it, and a simple link connecting the extremity of the lever with an excentric centre, which has merely a ring or collar revolving on it in order to receive the extremities of all the connecting links, or *guide rods*, one of which is connected immediately to the excentric centre itself, being fixed in the *revolving collar*. We are fully justified in this opinion both by theory and experience, and we sincerely hope, as well for the benefit of the public as for that of the patentee, to whose talent and perseverance are due the great improvements which have been made in the construction of the wheel since the date of the patent, that the eyes of the public will at length be opened to the advantages which Steam Navigation will receive (and has received as far as experience has gone) from the increased *safety, economy, and comfort* attending the use of Morgan's wheels.

Some persons have been deterred from using Morgan's wheels on account of the prime cost being so much greater than that of the common wheels; but that argument, when examined into, falls to the ground, the difference in the cost of the engines, which with Morgan's wheels may be considerably less than with the common wheels, being an ample compensation for the difference in the cost of the wheels; besides which, the constant economy of fuel and the increased stowage are advantages not to be despised.

Note 1. In illustration of what is observed in the first paragraph on the motion of paddle wheels (page 119), the author of this paper has been prevailed upon by some of his friends to consent to the insertion of Fig. 4, Plate LXXIX., which was drawn merely as a curiosity, and not with any intention of having it engraved. The largest of the concentric circles in the centre of the figure represents that described by one of the points of a paddle wheel, before the vessel has any velocity, and the curves extending farther and farther on both sides represent the *curtate cycloids* described by the same point, when the vessel has acquired the respective velocities represented by the dotted horizontal lines extending from the middle of one node of the curve to that of the next, the last being the *simple cycloid* described when the velocity of the vessel is equal to the *circumferential velocity* of the point; the first-mentioned circle is then the *rolling circle*, and the dotted circles those corresponding to the respective *curtate cycloids*, the largest circle, considered as a *curtate cycloid*, having, of course, no *rolling circle*.

Note 2. We have omitted to mention the six figures in Plate LXXX., which are intended to show the distance between the nodes of successive floats in the different kinds of wheel. Fig. 1 refers to the deep trial of the ‘Salamander’ with the *common wheel*, Fig. 2 to Field’s *cycloidal wheel*, Fig. 3 to Buchanan’s, Fig. 4 to Oldham’s, and Fig. 5 to Morgan’s wheel, (all these corresponding to Fig. 4 in the Plates LXXIV. to LXXVIII. inclusive), and Fig. 6 to the performance of the ‘Vestal,’ Fig. 2, Plate LXXIX. In these figures it will be observed that the distances between the nodes of the feathering floats are always greater than with fixed floats, particularly those of the *cycloidal wheel*; and that the nodes are most distant with Morgan’s wheel, as actually made, is seen in Fig. 6, although the wheel is much smaller than the others.

* * * We have been favoured with a sketch of what we consider to be a very desirable improvement in the mode of connecting Morgan’s wheel with the engine.

To appreciate the improvement it must be borne in mind that the wheel, as hitherto constructed, has *three* main bearings in which it revolves,—viz., one on the engine frame, one on the ship’s side, and the third on the spring beam. Experience has proved the great difficulty of maintaining *three* bearings in a right line; and has also shown a great increase in friction, and in wear and tear, where any one of the three bearings has got, as workmen express it, “much out of truth.”

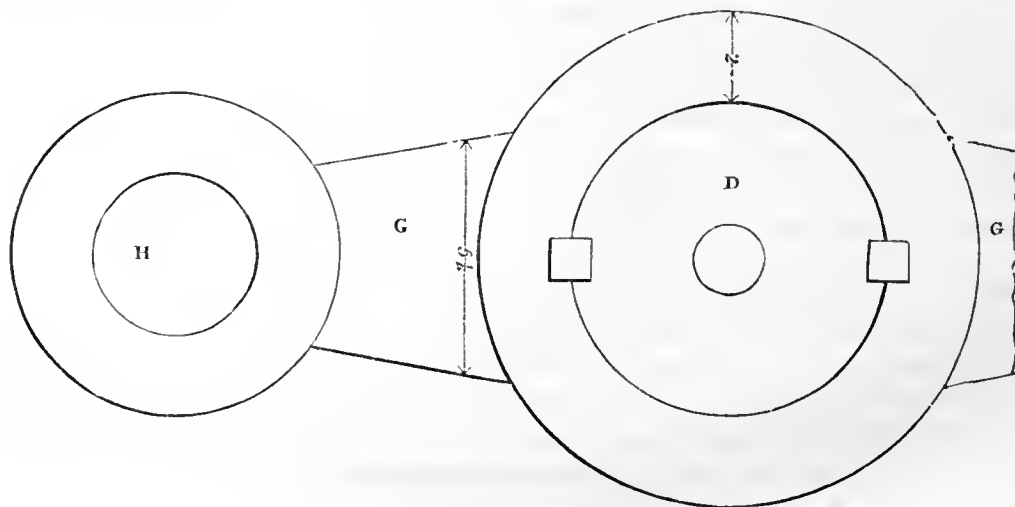

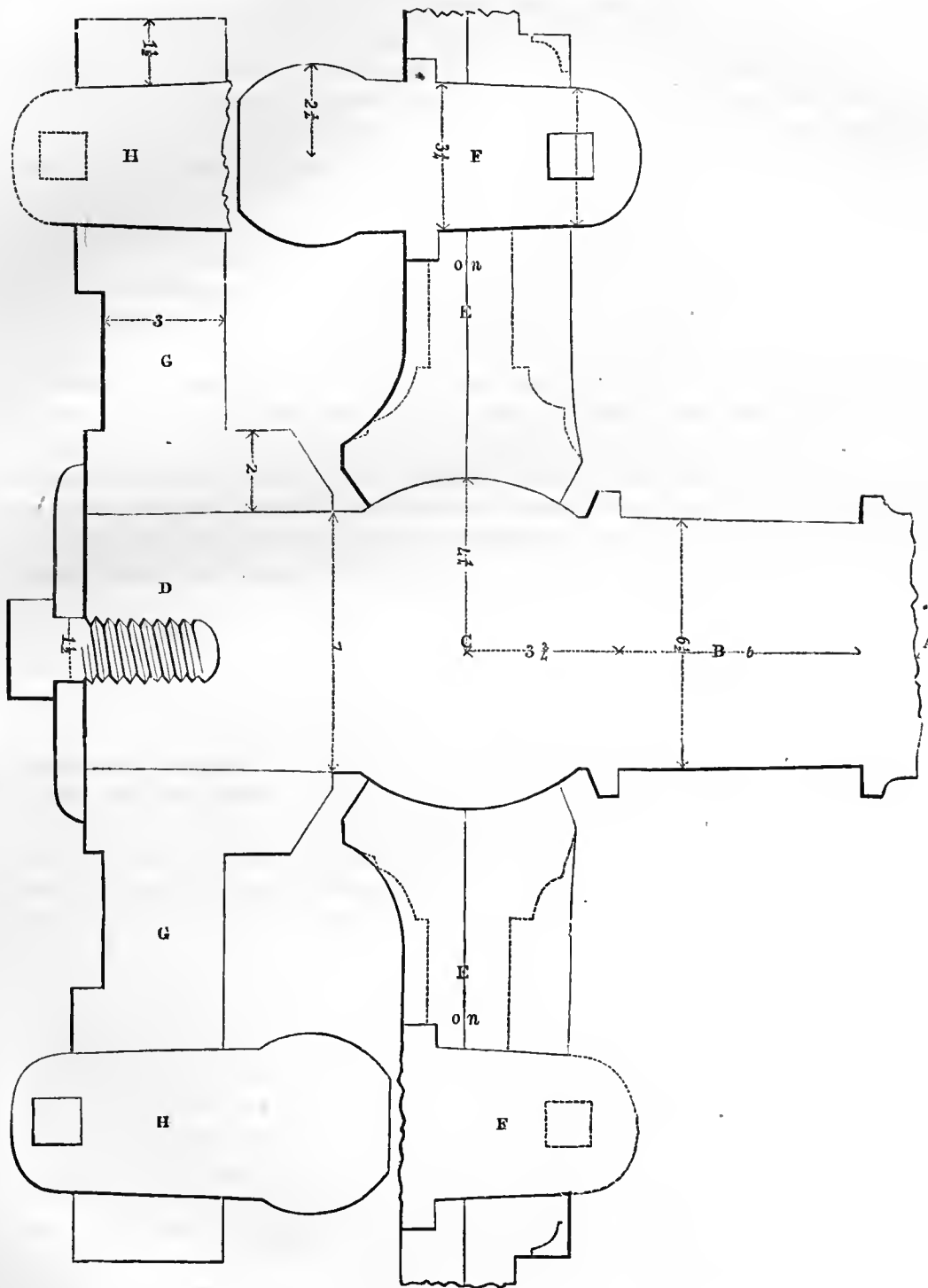

The accompanying diagrams represent,

- A. A part of the outer crank-shaft of a pair of marine engines.
- B. The journal, bearing on the ship's side.

C. A portion of a sphere, forged on the shaft and turned to truth.

D. The end of the shaft projecting into the wheel.

E E. Part of the wheel centre, or nave, made in two parts, *o* and *n*, truly faced, bolted to each other, and turned to fit the sphere on the shaft: the part *n* is again constructed in two parts, for the convenience of removal when needful, and joined together by bolts through two flanches across the nave. The radii of the wheel are clipped between *o* and *n*, in recesses purposely cast for them.

F F. Two crank-pins with spherical ends.

G G. A double driving arm fixed on D.

H H. Two crank-pins, also with spherical ends, and respectively connected by drag-links, with the pins in the nave, in the same manner as Boulton and Watt have usually connected their marine engine cranks.

This arrangement obviously acts as a universal joint, and admits a deviation in the line of bearings much beyond the limits of any thing required in practice.

It is due to J. B. Humphreys, C.E., who has applied it to an IRON VESSEL constructed by him for the Rio Doce Navigation Company, to state that our attention is attracted to his practice by our knowledge of his long experience in these matters, he being well known as the founder of steam navigation in Prussia so early as the year 1814.—ED.

VIII.—ON THE INDICATOR.

BY JOSEPH GLYNN, ESQ., C.E., F.R.S., &c.

ALTHOUGH the construction and application of the indicator has been described in such a manner that most persons conversant with the mechanical contrivances of the time, and with the steam engine as now manufactured, have a general idea of its form and use, yet it seems to have been regarded rather as an ingenious invention, among many others, of the late Mr. Watt—fitted more for the philosophical lecturer than for the practical engineer; as a curious instrument by means of which the action of the steam in the cylinder, and that of the vacuum or atmospheric pressure upon the piston, might be delineated, and its varying force represented by a curve, as it was at one time the fashion to represent every thing; even the arguments and statements of the political economist were drawn out in curved lines and figured in a diagram.

But the indicator shows not only the relative action of the vacuum and pressure of the steam upon the piston of an engine, but their absolute force and effect; it shows how much of that force is taken to overcome the friction of the machine, and produce the change of motion in its parts, and how much is available for useful purposes; it exhibits, if we may so say, the disposable force of the steam engine, and the perfection or imperfection of its construction or condition at the time of making the trials. The indicator, in its most simple and best form, is shown in the engraving (see Pl. XVI). The cylinder, or tube of the instrument, should be truly bored, and the piston ground into it, so that the workmanship should be as far as possible perfectly accurate. The piston should fit the tube without packing, so that it may be made air-tight by pouring olive oil upon it when it is in use. Its area should be exactly 1, $1\frac{1}{4}$, $1\frac{1}{2}$, $1\frac{3}{4}$, or two square inches, and a loop or an eye should be fixed in the under side of it, so that by means of a cord and weights attached to it, the extension of the spiral spring with each lb. upon the square inch may be proved, and a scale of extension formed, up to 14 lbs., ruling parallel lines for each lb. from the line of rest, which may be marked with a cipher. The compression of the spring from the line of rest may also be tried, by attaching the cord to the loop at the top of the piston rod which holds the tracing pencil, and hanging the weights over a pulley. To insure accurate observations, it is best to prove the spring of the indicator every time the instrument is used, and form the scales for the occasion: it is almost needless to say that it should be cleaned and oiled afresh for each trial; but unless this be done, it may cause great discrepancy in the results, and much time may be wasted in trying to reconcile apparent differences arising only from a little stiffened oil. These observations

may seem minute and trifling, but serious errors may occur from the neglect of them, when from a piston of $1\frac{1}{2}$ inches area and 3 inches stroke, we judge of another of 3 feet in diameter and 8 feet stroke.

Those manufacturers who use the indicator have the lower part of the stop-cock formed into a plug, which can be unscrewed at pleasure, and made to fit in the place of the plug or barrel of the grease cock on the cylinder cover. It is to be presumed that in most engines of the best makers, the action on both sides of the piston is the same; but if this be matter of doubt, it is easy by means of a pipe bent at right angles, and screwed into the cylinder at the bottom, to apply the indicator there also. The apparatus being fixed, and the stop-cock closed, the point of the tracing pencil should be carefully adjusted on the line of rest. The sliding table carrying the ruled paper may then be put in motion by attaching the cord to it, which has already been fastened to some convenient moving point of the engine; then, observing that the pencil makes its mark on the line of rest, open the stop-cock, and so set the piston of the indicator in motion. The pistons of the instrument and the steam engine now move simultaneously, but in opposite directions, the force of the steam driving them asunder, and the vacuum bringing them, as it were, together, at the same time that the horizontal motion of the sliding table represents the vertical motion of the larger piston; consequently, on the indicator, the horizontal motion shows the stroke of the steam engine piston, and the vertical motion shows the pressure upon it. The preceding explanation is requisite to enable the general reader to understand the annexed diagram of a trial which we made on a steam engine applied to drive a rolling mill for the manufacture of iron. This engine had a cylinder of 36 inches in diameter, and a stroke of 7 feet, making 16 strokes per minute (that is to say, 16 revolutions of the crank shaft); the fly wheel, as in most rolling mill engines, was on the second motion making 64.6 revolutions per minute; it was 20 feet in diameter, and weighed about 25 tons, serving to accumulate the engine power, as well as to regulate its motion, and thereby overcome any sudden resistance, as the passing a mass of iron between the rolls of the mill. Such irregular application of power made this engine peculiarly eligible for exhibiting the use of the indicator in delineating its varying action. The instrument being fixed as before stated, and the steam engine in its usual order having been at work for some hours before the experiment was made, it was stopped, and all the machinery detached; the condenser was cleared of air and water by blowing the steam through it, and the engine started in the usual manner, when the pencil of the indicator described the curvilinear figure marked A (see the annexed figure), showing the force required to put the engine into motion from a state of rest. This figure gradually diminished until the engine acquired a uniform speed, which was maintained and regulated by the governor at the proper rate of going, namely, 16 revolutions per minute, for a considerable time, and the pencil of the indicator continued to trace the curve marked B, showing the force expended in overcoming the constant friction of the engine, in changing the motion of its parts, and in working the air-pump, &c. The principal machinery of the rolling mill was now attached to the engine, and set in motion; it consisted of a pair of rollers for the puddled iron, a pair of boiler plate rollers, a pair of rolls for making small bars, a pair of shears for cutting them to the proper length, and a large lathe used for turning the rollers. The above machinery in motion, but without performing any work, produced the figure C on the tablet of the indicator. When this had been continued for some time, the small rolls were kept at work making bars (small squares), and the figure D was

A DIAGRAM

Showing the practical application of the Indicator to ascertain the effective power of a steam engine, a fac-simile of that traced by the instrument.

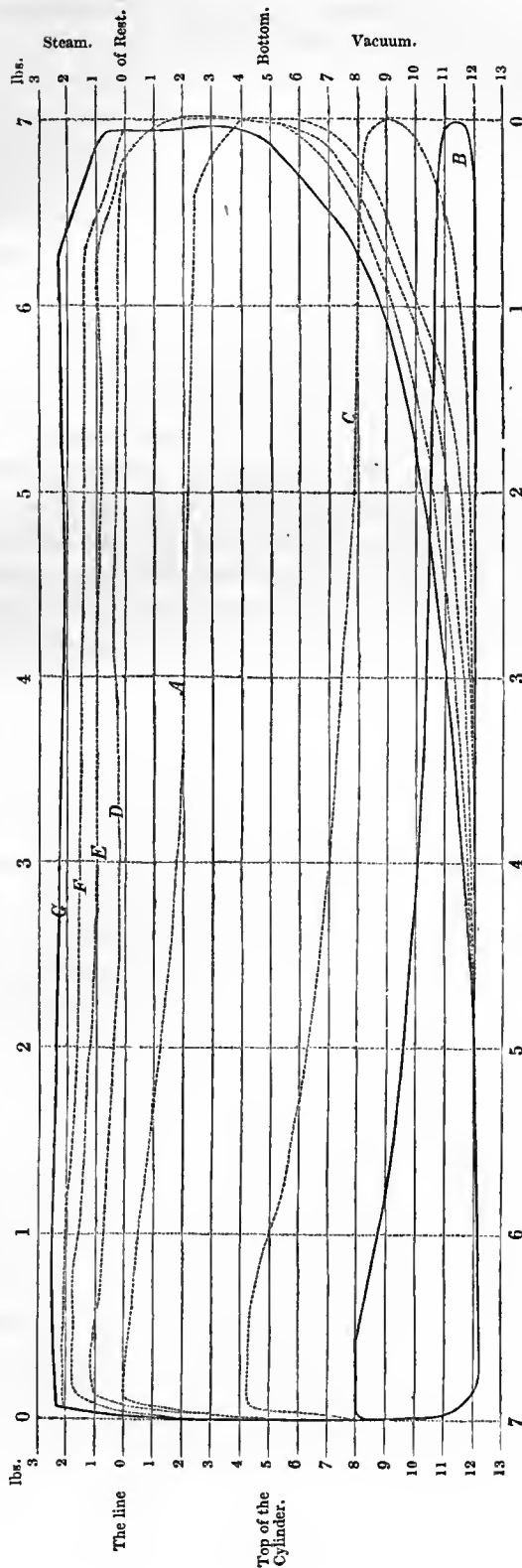

The figures in the vertical columns show the pressure in lbs. per square inch upon the piston; the horizontal figures show each foot in the length of the engine's stroke, the Indicator being fixed in the cylinder cover.

described ; the lathe was then applied to turn a case-hardened roller for rolling boiler plates, and the pencil traced the figure E. The merchant-bar rolls were now set in motion, in addition to the above (these rolls are for making the ordinary square and round bar iron), but they were not employed in rolling it: the additional power required to keep them going increased the figure to F. The puddled ball rolls, the small rolls, the heavy lathe, and the shears were kept in full work, and the engine being fully loaded, the figure G was delineated. The diagram shows that the engine was doing its duty, and it was proved that an engine of larger power must be employed if the merchant rolls and the plate rolls be required to be kept in work, rolling iron at the same time with the other machinery. During this experiment the safety valve of the boiler was loaded at 3 lbs. upon the square inch above the pressure of the atmosphere ; and it will be seen by the diagram, which is an exact copy of that actually made by the instrument, what mechanical force was taken in each case, and at each point of the piston's course. It has been noticed that the stroke was 7 feet ; the steam was cut off about 9 inches from the end of the stroke, as the diagram shows ; and the action of the governor may be discerned, as regulating the supply of steam, a little farther from the cylinder top every time the engine's load is increased. The effective or disposable force of the engine will be found to be about 10 lbs. on each square inch of the piston, the area of which is 1017·8 inches, which makes the actual power of the engine about 69 horses, reckoning 33,000 lbs. raised one foot high in a minute each horse power ; whereas, the nominal power of the engine was only 55 horses, as indeed it would be called by most of the engine-makers.

IX.—HOWARD'S METHOD OF VAPORISATION.

THE principle of Mr. Howard's apparatus, which is of recent date, may be gathered from the following description, which is abstracted from the specification of his patent.

In the ordinary method of generating steam by means of boilers, a body of water is exposed to a large surface of metal, presenting to it a comparatively low degree of heat; and the temperature of the water bearing a constant relation to the density or pressure of the steam, the rapidity of evaporation is limited thereby. In my process of VAPORISATION the power of the engine is derived from the vaporisation of the least possible quantity of water on a small surface, heated to and maintained at such temperature (about 400° Fahrenheit) as will vaporise the water with the utmost rapidity; the steam so formed having a high temperature, but relatively a low density or pressure. And by the interposition of mercury, or other medium of the like effect, the surface exposed to the fire is preserved from the injury that would otherwise arise from a strong local heat; and the deposit of salts or other impurities on the vaporising surface is prevented by the continued use of the same water. And in my engine other liquids, as alcohol for instance, may be substituted for water.

A circular, or otherwise formed wrought-iron plate, is fixed horizontally over a fire constructed to burn coke, anthracite coal, or other fuel of the like nature, and urged by a blowing machine subject to regulation. The area of the grate is about a fifth of a square foot per horse power of the engine. The area of the plate exposed to the action of the fire need not exceed three-fourths of a square foot per horse power. A second plate is fixed above this, and has securely fitted into it, and throughout its surface, a number of thin wrought-iron cups or short cylinders, about two inches in diameter, closed at bottom, and reaching to within a little distance of the interior of the lower plate, by which means the upper surface is increased to about four times the lower. Both plates are slightly curved downwards. A true and secure joint is formed at the circumference of the plates, by bolting them to a strong ring about three inches deep, and which fixes them at a corresponding distance apart. The intermediate space (being under and around the cups) is entirely filled with mercury or a soft amalgam. A small box of iron communicates with it to allow of its expansion when heated, and the steam being admitted to this portion of the mercury, the pressure is equalized above and below the upper plate and cups. A thermometer indicates the temperature of the mercury, which must never be permitted to rise much above five hundred degrees Fahrenheit, nor should it be allowed, while the engine is at work, to fall below three hundred and fifty degrees, the fire, or the quantity of water injected (as presently described) being regulated accordingly. A nose or rose, constructed to disperse the water as equally as possible, is fixed above the upper plate, and, by means of a pump, throwing at intervals, a small quantity

of water is withdrawn from the condenser, or hot-water cistern, and projected through the nosle over the upper plate and cups, when it is instantly and completely vaporised. The pump has a cock or valve by which to adjust the supply of water, and a hand-pump is provided to start the engine, and increase the facility of commanding it. Before arriving at the nosle the water is heated, in a pipe or vessel exposed partially to the fire, in order that it may not diminish the elasticity of the steam already formed, and that it may more readily vaporise. The heat from the fuel that has not been absorbed by the mercury passes around a steam chamber, by which means the steam is heated and expanded considerably after its formation, and thence proceeds from the upper part of the chamber to the cylinder valves in the usual manner. This exterior or flue casing is covered by a non-conducting substance, as are also the steam pipes, cylinder, &c. The above construction is expressly intended for working the steam expansively, the pressure being in general about ten lbs. per square inch above the atmosphere, and the steam cut off from the cylinder at about a third of the stroke. The acting machinery of the engine is on the ordinary construction, and the packing of the piston and valves are metallic.

The process of CONDENSATION consists in abstracting the heat from the water of injection, by bringing it in contact with a sufficient surface of metal, exposed externally to cold water in any efficient manner, and re-injecting the water thus cooled amidst the steam.

The air-pump withdraws the warm water from the condenser into the hot cistern in the usual manner, and the water is passed from thence by the pressure of the atmosphere (a partial vacuum existing in the condenser) into a copper pipe or worm, exposed to cold water in a cistern constantly supplied by a pump or otherwise. The refrigerating pipe terminates within the condenser, and the water having been previously cooled by its *gradual* progress through it, enters into *immediate* contact with the steam, and instantly reduces it to the liquid state. A valve is placed at the end of this pipe within the condenser, and is connected by a rod and lever to a float in the hot cistern, which prevents all the water from being drawn out of the latter at any time, and which valve also serves to disperse the water amidst the steam. It is further adjustable by hand. Before starting the engine, a sufficient quantity of water is provided to ensure the circulation, by entirely filling the refrigerating pipe and part of the hot water cistern. The surface of this pipe (or other vessel substituted for it), when the condenser is employed with the vaporiser before described, and the steam worked expansively, should be about four square feet per horse power.

A still is provided to furnish a supply of pure water, to replace any loss by leakages, and is attached to the flue of the vaporiser, in which latter the use of water containing salt or other impurities is inadmissible.

This process of condensation is equally applicable to the ordinary engine with boilers.

X.—ON THE GENERAL THEORY OF THE STEAM ENGINE.

BY THE EDITOR.

THE mechanical relations of the steam engine, or the principles upon which the power is transmitted from the cylinder, are of a simple and elementary nature. To discuss them it is only necessary to have recourse to the properties of the crank and the well understood mechanical powers, the lever, the wheel and axle, and the inclined plane. In every combination of the ordinary mechanical powers, supposed to be divested of friction, the transmission of force follows the well-known law that the efficient power is of precisely the same value at each point, understanding the efficient power to be the force of resistance multiplied into the velocity. Thus the effect produced, or the effective power, is measured by the weight moved, or resistance overcome, multiplied by its velocity: the moving power is similarly measured by its force multiplied by its velocity; and these powers would in all cases be equal, were it not for the effects of friction. To preserve distinctness, we shall designate the pressure by the term *pressure* or *force*, and the effect produced, or the force multiplied into the velocity, by the term *power*; the former of these may likewise be called the *statical*, and the latter the *dynamical* value of the force. These terms being agreed upon, it follows that in every machine composed of the ordinary mechanical powers, the quantity of power developed, or the dynamical effect of the force, would be the same at all points; that the power, by such arrangement, is transmitted without any change in its value, except it be such as is caused by the loss resulting from friction. It would be easy to show that this principle is universal, or, in other words, that it applies to every possible combination of machinery; but this is quite unnecessary for our present object, though it may perhaps not be out of place to make a few observations on the nature of the crank, in addition to what has been stated in the present work at page 228.

I. ACTION OF THE CRANK.

In the annexed figure let $CD = r$ be the length of the connecting rod; $OD = \rho$ the radius of the crank; the angle $(DOE) = \alpha$; the velocity at $C = v$; the velocity of $D = v'$, and the distance $(AC) = x$. Then, the perpendicular $DG = \rho \sin. \alpha$; $CG = \sqrt{r^2 - \rho^2 \sin.^2 \alpha}$; $OG = \rho \cos. \alpha$; $CO = \sqrt{r^2 - \rho^2 \sin.^2 \alpha} + \rho \cos. \alpha$; $AO = r + \rho$, and therefore the value of AC , or $AO - CO$, is

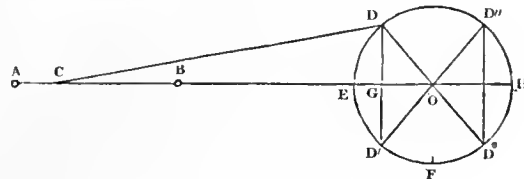

$$\begin{aligned}
 x &= r + \rho - (\sqrt{r^2 - \rho^2 \sin.^2 \alpha} + \rho \cos. \alpha) \\
 &= \rho (1 - \cos. \alpha) + (r - \sqrt{r^2 - \rho^2 \sin.^2 \alpha}) \dots (1).
 \end{aligned}$$

By differentiating this expression of the distance traversed by C, we obtain the velocity of the extremity C, viz. :

$$\frac{dx}{dt} = \frac{\rho}{d} \frac{d\alpha}{dt} \sin. \alpha \left(\sqrt{\frac{\rho \cos. \alpha}{r^2 - \rho^2 \sin.^2 \alpha} + 1} \right); \text{ that is,}$$

$$v = v' \sin. \alpha \left(\sqrt{\frac{\rho \cos. \alpha}{r^2 - \rho^2 \sin.^2 \alpha} + 1} \right) \dots (2).$$

But if P denote the moving force acting at C, in the direction CB, P' the effective force of D, and $r = n\rho$, it has been shown at page 229 of the present work, by means of the resolution of the forces, that $P' = P \sin. \alpha \left(\sqrt{\frac{\cos. \alpha}{n^2 - \sin.^2 \alpha} + 1} \right)$, or, replacing n by $\frac{r}{\rho}$,

$$P' = P \sin. \alpha \left(\sqrt{\frac{\rho \cos. \alpha}{r^2 - \rho^2 \sin.^2 \alpha} + 1} \right) \dots (3).$$

Equation (2) hence reduces to $v = v' \frac{P'}{P}$, and therefore

$$Pv = P'v' \dots (4);$$

that is, the moving *power* at C is always equal to the effective power at D.

The moving force P being nearly uniform, the force P' expressed by the equation (3) will be materially different at different positions of the crank, and the velocity of the engine will, in consequence, be subject to small fluctuations in the course of each revolution. To ascertain the law of these variations, it will be necessary to have recourse to the usual equation of rotatory motion. Let R denote the real moment of the resistance, including friction, reduced to the point D, or the force which uniformly applied along the circumference ED would just suffice to preserve the mean velocity of the engine without any variation. Then P' being the force actually applied, the effective accelerating force, or the part tending to produce acceleration, will be $P' - R$; and where this is negative, the velocity $\frac{d\alpha}{dt}$ must be retarded instead of accelerated. If we now multiply the force $P' - R$ by ρ , the leverage at which it acts, the product $\rho(P' - R)$ is its moment or tendency to generate angular motion. Hence, if M designate the moment of the inertia to be overcome, and if we neglect, as comparatively insignificant, the slight variations of the resistance R due to the small changes of velocity, and suppose it to continue uniform, we shall have,

$$M \frac{d^2 \alpha}{dt^2} = \rho (P' - R).$$

Multiply by $\frac{2}{d} \frac{d\alpha}{dt}$, and

$$\begin{aligned} M \frac{2}{d} \frac{d\alpha}{dt} \frac{d^2 \alpha}{dt^2} &= 2 P' \rho \frac{d\alpha}{dt} - 2 R \rho \frac{d\alpha}{dt} \\ &= 2 P' v' - 2 R \rho \frac{d\alpha}{dt} \\ &= 2 P v - 2 R \rho \frac{d\alpha}{dt} \\ &= 2 P \frac{dx}{dt} - 2 R \rho \frac{d\alpha}{dt} \end{aligned}$$

Consequently, by integration,

$$M \left(\frac{d\alpha}{dt} \right)^2 = 2 (Pc + Px - R\rho\alpha)$$

$$\therefore \frac{d\alpha}{dt} = \sqrt{\frac{2}{M} (Pc + Px - R\rho\alpha)} \dots (5).$$

Now, the engine being supposed to have acquired her permanent speed, there can be no progressive acceleration; the same velocity must recur at the period of each revolution. The velocity at E is obtained by putting $x = 0, \alpha = 0$, and is,

$$\left(\frac{d\alpha}{dt} \right)' = \sqrt{\frac{2}{M} Pc} \dots (a).$$

Also, the velocity at H is obtained by putting $x = 2\rho, \alpha = \pi (= 3.14159)$, and is,

$$\left(\frac{d\alpha}{dt} \right)'' = \sqrt{\frac{2}{M} (Pc + 2P\rho - R\rho\pi)} \dots (b).$$

Again, it is to be observed that the preceding investigation equally applies to the returning motion along HD° , provided, in that case, the symbol α represents the angle HoD° , and x' , which is accentuated for distinction, the retrograde distance BC. If therefore, $\alpha x'$ being each nought, the velocity at H be,

$$\left(\frac{d\alpha}{dt} \right)'' = \sqrt{\frac{2}{M} Pc'} \dots (c),$$

when $\alpha = \pi, x' = 2\rho$, the recurring velocity at E will be,

$$\left(\frac{d\alpha}{dt} \right)''' = \sqrt{\frac{2}{M} (Pc' + 2P\rho - R\rho\pi)} \dots (d).$$

Thus it appears that the squares of the three velocities $\left(\frac{d\alpha}{dt} \right)', \left(\frac{d\alpha}{dt} \right)'', \left(\frac{d\alpha}{dt} \right)'''$ are in arithmetical progression, and that this progression would go on indefinitely if the resistance R did not augment so as to destroy the common difference $2P\rho - R\rho\pi$, and cause the same velocity to recur at each period. It hence follows that so long as the smallness of R renders $2P\rho - R\rho\pi$, or $2P - R\pi$, positive, the engine will be acquiring additional speed; and that when R becomes such that $2P - R\pi = 0$, the power will just be capable of maintaining unaltered the periodical movement, and the general speed will not admit of any further increase. For permanent speed we must therefore have,

$$R = \frac{2}{\pi} P \dots (6).$$

This result shows that the general effect of the moving force P acting obliquely on OD at D is the same as if $\frac{2}{\pi} P$, or very nearly $\frac{1}{1.57} P$, were always applied perpendicularly at the same point; and this again is the same as if the force P itself were continually applied perpendicularly at a distance of $\frac{1}{1.57}$ ths of the radius ρ . This last distance is therefore the effective leverage of the crank.

It is not to be inferred from this that the effect of any portion of the power is lost. The quantity of power developed by a constant force is measured by the force multiplied into the

distance through which it has acted. In a semi-revolution, the power developed by P is hence $P \times 2\rho$; that expended by R would similarly be $R \times \pi\rho$; and, according to the equation (6), it appears that the expenditure would be the same in both cases, and that no loss is sustained through the obliquity of the action of the crank, except that which arises from the additional friction caused by the stress on the shaft.

Substitute the value of R by (6) in (5), and, for permanent speed, the angular velocity of the shaft of the engine at any period of the stroke is,

$$\frac{d\alpha}{dt} = \sqrt{\frac{2P}{M} \left(c + x - \frac{2\rho}{\pi} \alpha \right)} \dots\dots (7);$$

and for any position D from E to H, if β denote the angle E O D, this becomes,

$$\omega = \sqrt{\frac{2P}{M} \left(c + \rho(1 - \cos.\beta) - \frac{2\rho}{\pi}\beta + (r - \sqrt{r^2 - \rho^2 \sin.^2\beta}) \right)} \dots\dots (8).$$

For a point D° in the returning half stroke from H to E, if β denote the angle H O D°, the value of AC' is obtained by substituting $\pi - \beta$ for α in the value of x expressed by equation (1), and is therefore,

$$AC = \rho(1 + \cos.\beta) + (r - \sqrt{r^2 - \rho^2 \sin.^2\beta});$$

and, if we deduct this from the whole distance AB = 2ρ , we get the expression for BC or x' , viz.

$$x' = \rho(1 - \cos.\beta) - (r - \sqrt{r^2 - \rho^2 \sin.^2\beta}) \dots\dots (9).$$

Therefore by equation (7) the velocity at D° is,

$$\omega^\circ = \sqrt{\frac{2P}{M} \left(c + \rho(1 - \cos.\beta) - \frac{2\rho}{\pi}\beta - (r - \sqrt{r^2 - \rho^2 \sin.^2\beta}) \right)} \dots\dots (10).$$

The velocities ω' ω'' at D' D'' will now be determined by substituting $\pi - \beta$ for β in equations (10) and (8); thus we find,

$$\omega' = \sqrt{\frac{2P}{M} \left(c - \rho(1 - \cos.\beta) + \frac{2\rho}{\pi}\beta - (r - \sqrt{r^2 - \rho^2 \sin.^2\beta}) \right)} \dots\dots (11),$$

$$\omega'' = \sqrt{\frac{2P}{M} \left(c - \rho(1 - \cos.\beta) + \frac{2\rho}{\pi}\beta + (r - \sqrt{r^2 - \rho^2 \sin.^2\beta}) \right)} \dots\dots (12).$$

To put these in a more simple form for comparison, let (ω) denote the velocity at E, as expressed by equation (a), and assume,

$$\left. \begin{aligned} A &= \rho \left(\frac{2}{\pi} \beta - 1 + \cos.\beta \right) \\ h &= r - \sqrt{r^2 - \rho^2 \sin.^2\beta} \end{aligned} \right\} \dots\dots (13)$$

Then, the angular velocities at any four corresponding points D° D D' D'' are,

$$\left. \begin{aligned} \omega^\circ &= \sqrt{(\omega)^2 - \frac{2P}{M} (A + h)} \\ \omega &= \sqrt{(\omega)^2 - \frac{2P}{M} (A - h)} \\ \omega &= \sqrt{(\omega)^2 + \frac{2P}{M} (A - h)} \\ \omega'' &= \sqrt{(\omega)^2 + \frac{2P}{M} (A + h)} \end{aligned} \right\} \dots\dots (14);$$

which are here arranged respectively in the order of their magnitudes, that at D° being the least, and that at D'' the greatest.

These expressions may be put in a more convenient form by neglecting the higher powers of the small variations. We shall then have,

$$\begin{aligned} \omega^\circ &= (\omega) - \frac{P}{M(\omega)} (A + h), \\ \omega &= (\omega) - \frac{P}{M(\omega)} (A - h), \\ \omega' &= (\omega) + \frac{P}{M(\omega)} (A - h), \\ \omega'' &= (\omega) + \frac{P}{M(\omega)} (A + h). \end{aligned}$$

But for h we may now substitute $\frac{\rho^2}{2r} \sin.^2\beta$; therefore,

$$\left. \begin{aligned} \omega^\circ &= (\omega) - \frac{P}{M(\omega)} \left(A + \frac{\rho^2}{2r} \sin.^2\beta \right) \\ \omega &= (\omega) - \frac{P}{M(\omega)} \left(A - \frac{\rho^2}{2r} \sin.^2\beta \right) \\ \omega' &= (\omega) + \frac{P}{M(\omega)} \left(A - \frac{\rho^2}{2r} \sin.^2\beta \right) \\ \omega'' &= (\omega) + \frac{P}{M(\omega)} \left(A + \frac{\rho^2}{2r} \sin.^2\beta \right) \end{aligned} \right\} \dots\dots (15);$$

in which the values of A in parts of ρ are by (13) found to be as follows :

β	A	β	A	β	A
0°	0·0000	$30^\circ +$	·1994	$60^\circ +$	·1667
5 +	·0518	35	·2080	65	·1448
10	·0959	40	·2105	70	·1198
15	·1326	45	·2071	75	·0922
20	·1619	50	·1984	80	·0625
25	·1841	55	·1847	85 +	·0316
30 +	·1994	60 +	·1667	90	0·0000

From these last expressions we conclude that the velocity (ω) which occurs at E and H is the *mean velocity*, and that the greatest and least velocities occur in the quadrants of D'' and D° , at the points where $A + \frac{\rho^2}{2r} \sin.^2\beta$, or $\frac{2}{\pi} \beta + \cos. \beta + \frac{\rho}{2r} \sin.^2\beta$, attains its maximum value. If we assume these points to be in the middle of the respective quadrants, so that $\beta = 45^\circ$, which will be very nearly the case with all the proportions observed in practice, and cannot sensibly affect the accuracy of the results, the greatest and least velocities will be

$$(\omega) \pm \frac{P \rho}{M(\omega)} \left(\frac{\rho}{4r} + 0\cdot207 \right) \text{ and the deviation from the mean value will be,}$$

$$\frac{P \rho}{M(\omega)} \left(\frac{\rho}{4r} + 0\cdot207 \right).$$

Again, by substituting the values of P', R, the force P' - R, which at each position tends to accelerate the motion, is found to be,

$$P' - R = P \left\{ \sin. \alpha \left(\frac{\rho \cos. \alpha}{\sqrt{r^2 - \rho^2 \sin.^2 \alpha}} + 1 \right) - \frac{2}{\pi} \right\} \dots \dots \dots (16).$$

It hence appears that the motion is,

$$\left. \begin{array}{l} \text{accelerated} \\ \text{retarded} \end{array} \right\} \text{when } \sin. \alpha \left(\frac{\rho \cos. \alpha}{\sqrt{r^2 - \rho^2 \sin.^2 \alpha}} + 1 \right) \text{ is } \left\{ \begin{array}{l} \text{greater} \\ \text{less} \end{array} \right\} \text{ than } \frac{2}{\pi} \text{ or } 0.63.$$

Values of this expression are shown in the table given at page 230 of the present work.

In the preceding investigation we have only considered the action of a single crank ; but it will be found to apply, with a slight modification, when the rotary force of the shaft is maintained by the action of any number of cranks making given angles with each other. We have only to substitute, in place of P', in the right-hand member of the equation of motion, the sum of the forces P' arising from the several cranks ; and, by following out the same process, the equation (5) will become,

$$\frac{d\alpha}{dt} = \sqrt{\frac{2}{M} \left\{ P c + \Sigma (P x) - R \rho \alpha \right\}},$$

in which $\Sigma (P x)$ includes the same term for each crank. Let (ω) denote the value of this angular velocity when $x = 0, \alpha = 0$, and the expression, for any other position, will hence be,

$$\omega = \sqrt{(\omega)^2 + \frac{2}{M} \left\{ \Sigma (P x) - R \rho \alpha \right\}} \dots \dots \dots (17).$$

By attending to the nature of the integration, it is evident that this equation applies generally from any assigned position throughout the entire period of each revolution of the shaft, if we give to the symbols $x \alpha$ the following signification, viz.

x , the <i>entire</i> distance travelled over by the extremity C, for each crank ; α , the angle described by the revolution of the shaft ;	}	each being estimated from that position in which the velocity was (ω) .
---	---	--

Let us take the practical case, in which the revolution of the shaft is maintained by a pair of equal engines, and in which the equal arms of the two cranks are placed at right angles, so that each of them may be in full action when the other is "on the centre." If we suppose one entire revolution to be performed, the distances x traversed by the extremity of each connecting rod will be 4ρ , the angle α described will be 2π , and the velocity will become

$$\omega = \sqrt{(\omega)^2 + \frac{2}{M} (4 P \rho + 4 P \rho - 2 R \rho \pi)} = \sqrt{(\omega)^2 + \frac{4 \rho}{M} (4 P - R \pi)}.$$

When the engines have attained their regular speed, this velocity must correspond with (ω) , since precisely the same motions must recur in successive revolutions ; we must hence have $4 P - R \pi = 0$,

$$\therefore R = \frac{4}{\pi} P \dots \dots (18).$$

This value is the same as $\frac{2}{\pi} (2 P)$ in which $2 P$ is now the moving power, and we observe that it corresponds with the expression (6) for the single crank.

To find a more convenient expression for the velocity at any position, let x be the distance

traversed by the connecting rod of that crank which takes the lead in the direction of rotation, and y the corresponding distance traversed by the connecting rod of the other crank which follows it. Then, substituting the value of R , &c., in (17), we have,

$$\omega = \sqrt{(\omega)^2 + \frac{2 P}{M} \left(x + y - \frac{4 \rho}{\pi} \alpha \right) \dots (19).$$

Now, referring to the figure on page 2, we shall suppose the advancing crank to proceed from the point E with the angular velocity (ω) , and to pass over to the four successive positions D, D'', D°, D' , equidistant from the diameter $E H$. The other crank will proceed from the point F , and always be 90° or $\frac{\pi}{2}$ behind the former. Let β denote the arc $E D$ or $H D''$, and assume,

$$\left. \begin{aligned} h &= r - \sqrt{r^2 - \rho^2 \sin.^2\beta} \\ k &= r - \sqrt{r^2 - \rho^2 \cos.^2\beta} \\ m &= r - \sqrt{r^2 - \rho^2} \end{aligned} \right\} \dots (20).$$

Then we shall have, for the point $D, x = \rho (1 - \cos. \beta) + h,$
 $y = \rho + m - \rho (1 - \sin. \beta) - k;$ for the point $D'', x = \rho (1 + \cos. \beta) + h,$
 $y = \rho + m + \rho (1 - \sin. \beta) + k;$ for the point $D^{\circ}, x = 4 \rho - \rho (1 + \cos. \beta) - h,$
 $y = \rho + m + \rho (1 + \sin. \beta) + k;$ and for the point $D', x = 4 \rho - \rho (1 - \cos. \beta) - h,$
 $y = \rho + m + 4 \rho - \rho (1 + \sin. \beta) - k.$ Hence the sum of the distances $x + y$ takes the following values,

$$\begin{aligned} \text{at } D, \quad x + y &= \rho (1 - \cos. \beta + \sin. \beta) + m + h - k, \\ \text{,, } D'', \quad \text{,,} &= \rho (3 + \cos. \beta - \sin. \beta) + m + h + k, \\ \text{,, } D^{\circ}, \quad \text{,,} &= \rho (5 - \cos. \beta + \sin. \beta) + m - h + k, \\ \text{,, } D', \quad \text{,,} &= \rho (7 + \cos. \beta - \sin. \beta) + m - h - k. \end{aligned}$$

Also, for these four points the angles described are respectively $\beta, \pi - \beta, \pi + \beta,$ and $2 \pi - \beta,$ which must likewise be severally substituted for α in (19). Performing these substitutions, and making,

$$A = \rho \left(\frac{4}{\pi} \beta - 1 + \cos. \beta - \sin. \beta \right) \dots (21).$$

we find, for the four respective points just enumerated,

$$\left. \begin{aligned} \omega &= \sqrt{(\omega)^2 + \frac{2 P}{M} (m - A + h - k)} \\ \omega'' &= \sqrt{(\omega)^2 + \frac{2 P}{M} (m + A + h + k)} \\ \omega^{\circ} &= \sqrt{(\omega)^2 + \frac{2 P}{M} (m - A - h + k)} \\ \omega &= \sqrt{(\omega)^2 + \frac{2 P}{M} (m + A - h - k)} \end{aligned} \right\} \dots (22).$$

These expressions may be considerably simplified by disregarding the powers of the small variations above the first. In the first place we immediately obtain,

$$\omega = (\omega) + \frac{P}{M(\omega)} (m - A + h - k),$$

$$\omega'' = (\omega) + \frac{P}{M(\omega)} (m + A + h + k),$$

$$\omega^\circ = (\omega) + \frac{P}{M(\omega)} (m - A - h + k),$$

$$\omega' = (\omega) + \frac{P}{M(\omega)} (m + A - h - k).$$

But the values of $h k m$ in (20) will now become $h = \frac{\rho^2}{2r} \sin.^2\beta$, $k = \frac{\rho^2}{2r} \cos.^2\beta$ and $m = \frac{\rho^2}{2r}$. We have finally, therefore,

$$\left. \begin{aligned} \omega &= (\omega) + \frac{P}{M(\omega)} \left(\frac{\rho^2}{r} \sin.^2\beta - A \right) \\ \omega'' &= (\omega) + \frac{P}{M(\omega)} \left(\frac{\rho^2}{r} + A \right) \\ \omega^\circ &= (\omega) + \frac{P}{M(\omega)} \left(\frac{\rho^2}{r} \cos.^2\beta - A \right) \\ \omega' &= (\omega) + \frac{P}{M(\omega)} (A) \end{aligned} \right\} \dots\dots (23).$$

The expression (21) gives to A the following values in parts of ρ for every fifth degree of the arc β :-

β	A	β	A	β	A
0°	0·0000	30°	+ 0·327	60°	- 0·327
5	+ 0·201	35	0·234	65	0·393
10	0·334	40	+ 0·121	70	0·421
15	0·404	45	0·0000	75	0·404
20	0·421	50	- 0·121	80	0·334
25	0·393	55	0·234	85	0·201
30	+ 0·327	60	- 0·327	90	- 0·0000

On examining the values (23) we observe that the greatest velocity takes place in the quadrant of D'' , and at the point where A attains its greatest positive value, viz., at 19° from H ; we also perceive that the least velocity occurs in the quadrant of D' and at the point where A attains its greatest negative value, viz., at 71° from E ; and that the mean angular velocity is $(\omega) + \frac{P}{M(\omega)} \cdot \frac{\rho^2}{2r}$. We have therefore,

$$\left. \begin{aligned} \text{Maximum} \\ \text{Minimum} \end{aligned} \right\} \text{value of } \omega = \begin{cases} (\omega) + \frac{P\rho}{M(\omega)} \left(\frac{\rho}{r} + 0\cdot042 \right) \\ (\omega) - \frac{P\rho}{M(\omega)} (0\cdot042) \end{cases}$$

Position when the velocity is greatest.

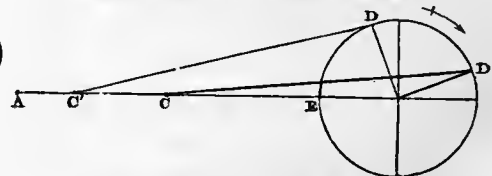

Position when the velocity is least.

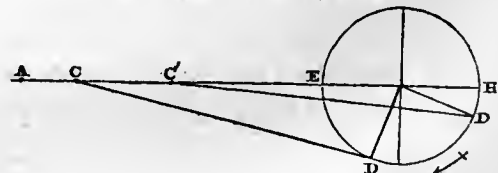

$$\left. \begin{aligned} \text{Greatest deviations} \\ \text{from mean value} \end{aligned} \right\} = \frac{P\rho}{M(\omega)} \left(\frac{\rho}{2r} + 0\cdot042 \right)$$

and these occur in the positions represented in the figures annexed. For only one engine and crank we have before found the greatest deviation from the mean angular velocity to be $\frac{P' \rho}{M(\omega)} \left(\frac{\rho}{4r} + 0.207 \right)$ in which, for the moment, we accentuate the symbol P, because in this case it represents the entire acting power, whereas in (25) it represents only the power of one of the two engines; and, under like circumstances, we have $P' = 2 P$, so that the latter expression becomes $\frac{P \rho}{M(\omega)} \left(\frac{\rho}{2r} + 0.414 \right)$. Comparing this with (25) it appears that the variation of velocity with a single engine and one crank, and the variation of velocity with a pair of engines and two cranks, are to each other in the ratio of $\frac{\rho}{r} + 0.818$ to $\frac{\rho}{r} + 0.082$, which ratio varies from about 3 to 1 up to that of 10 to 1.

These results are of much value in pointing out the effects to be produced by varying the radius of the crank, the length of the stroke, and the diameter of the cylinder. All other circumstances being the same, the values $P \rho, M, (\omega)$ will be constant; and therefore the extreme variation of velocity will always be proportional to $\frac{\rho}{r} + 0.828$ for one crank, or

$\frac{\rho}{r} + 0.084$ for two cranks acting alternately in the usual way. Hence it follows, that by diminishing the radius of the crank and increasing the length of the connecting rod, the irregularity of the movement will be materially diminished, more particularly when two engines are employed. It is on this account highly desirable to have as long a connecting rod as convenient, in proportion to the radius of the crank; while, on the other hand, it adds another to many important objections¹ against the adoption of the American proportions recommended by Professor Renwick at page 109, viz., to employ a crank of large radius and a long cylinder, since the disagreeable and destructive jolting, experienced in the working of engines, is principally due to the irregularity of action here alluded to.

We have gone thus far into an investigation of the motion of the crank, as it forms one of the most important instruments of the steam engine, and has hitherto met with very little attention from scientific writers. It is, doubtless, the most simple, and perhaps the most efficient, contrivance that can be devised to convert a reciprocating action into a rotatory motion; and in this respect we cannot be surprised that it has not been superseded by any one of the numerous inventions that have been proposed with the view of dispensing with it. We are compelled, however, at the same time, to admit that this beautiful simplicity is accompanied by corresponding inconveniences in the inequalities of motion, pressure, friction, and consequent wear. The mechanical defects of engines constructed on the rotatory principle appear to be of greater magnitude, and the disadvantages and difficulties that stand in the way of their application to the most important uses, are of a very formidable nature. This is much to be regretted, as we conceive a perfectly equable motion to be a great desideratum in the steam engine, and the only hope we can have of succeeding in obtaining it is in the exclusive employment of rotary action. On this head we may refer our readers to an instructive paper, entitled "On the Fallacies of the Rotatory Steam Engine," by John Scott

¹ See pages 365, 366, of the present work.

Russell, Esq., a gentleman to whom practical science is much indebted. One of the leading objects of this paper, which is printed in the Edinburgh New Philosophical Journal for January 1838, is to show that no loss of power is sustained by the intervention of the crank; but, in doing this, it should be remarked, that the author has throughout his paper discussed only the particular case in which the moving power acts on the crank in parallel lines, or in which the connecting rod is supposed to be of infinite length; and that this necessarily reduces many of his statements into mere approximations, when the subject is generally considered. Mr. Russell has, however, handled the subject with considerable power, and his remarks are, perhaps, sufficiently precise for the object he had in view, viz., to dispel the delusion under which many practical men labour with respect to the nature of the crank, that it is attended with a loss of nearly one-third of the power. It is well known that persons are to be found who have been the subjects of this delusion, as well as inventors who have been its victims, but we cannot concur with Mr. Russell that "some eminent standard writers on the steam engine have advanced the same doctrines." Most writers who are accustomed to treat these matters scientifically have doubtless considered that no reasonable dispute could possibly be entertained, and have thought it unnecessary to make any declaration on the point in question. We may, however, be allowed to refer to one exception. At page 137 of "Hann and Dodd's Mechanics for Practical Men," the very question is taken up, and comprehensively disposed of, in the following paragraph:—

"In the crank, as applied in the steam engine, the effect which is produced, is to the effect, were the force to act perpendicularly on the crank all the way round, as twice the diameter of a circle is to the circumference; in consequence of which, many practical men have considered that there is a corresponding loss of power by using a crank; without ever considering that the piston, or moving power, only moves through twice the diameter of the crank's orbit, while the crank moves through its whole circumference. For here the same principle holds good as in all other mechanical contrivances, viz., the power multiplied by the space which it passes over, is equal to the weight or resistance multiplied by the space which it passes over."

These statements have since found their way into other mechanical works of more recent date; and it is certainly of some moment that practical men who have not the means of following out theoretical investigations of these subjects, should be thus guarded from an error by which many of them have been so widely misled. That no power is gained or lost by the use of the crank has already been established on dynamical principles at the commencement of this paper. We are not, however, to conclude that this principle is at all peculiar to the crank. It is well known to apply to every combination of the five elementary powers, and by the principle of virtual velocities it may easily be shown that it is an universal property of mechanical arrangement, *that with every possible mechanical combination, no power can be gained or lost, if we except the resistances occasioned by friction.*

II. PRINCIPLE OF LIVING FORCES.

The quantity of power expended in the production or maintenance of any effect is, however, most simply determined by the general principle of living forces. This principle, which is immediately deducible from that of virtual velocities, is applicable to every possible motion of terrestrial bodies, and may be enumerated as follows :

At any instant let each particle of the system be multiplied into the square of its velocity, and the product will be the living force of the particle. The aggregate of all these products will measure the total amount of impetus or living force of the system.

Let each force Q , acting at a particular point, be multiplied into the small distance dy traversed by that point, in the direction of the line in which the force acts, during an elementary instant of time dt , and the product will measure the expenditure of power during that instant. In this measurement, the forces or pressures arising from the connexion of the parts will be neglected, because no motion can at any instant be produced in the direction of such pressures, and they consequently can have no share in the generation or consumption of living force ; but the resistances of friction, which are proportional to the pressures on the parts, and act in the direction of the motion, must be regarded. In the cases where the point moves in the direction of the force, the effect will be to increase the living force ; but in the cases where the point moves in the contrary direction, the effect will be to diminish the living force, and all resistances are of this latter description.

Now, if from double the total expenditure towards the increase of the living force we deduct double the total expenditure towards its diminution, each being so estimated, the difference will always accurately express the variation that takes place, during the instant dt , in the above-defined value of the living force of the system.

The sum of the variations through successive instants will express the total variation that takes place in a finite time. When the forces are variable, this summation must be effected by the integral calculus ; but when the forces are constant, it will only be necessary to multiply each into the whole distance traversed by its point of application in the direction of its action, to get its effect in any given time or space.

When the motion is permanent and the velocities recur at stated periods, the whole variation of living force through the extent of each period must evidently be zero ; and hence in this case the expenditure of the moving powers must be precisely equal to that of the resistances throughout an entire period.

This principle, though exceedingly general, is of very easy application, and it will readily be perceived how the preceding theories of the action of the crank, or indeed of any other action, may be immediately deduced from it.

It may be here worthy of remark, that in the case of steam employed at a given temperature, the density being inversely as the pressure, the expenditure of the moving power of the piston will be proportional to the quantity of steam consumed or the effective quantity of water evaporated.

III. TRANSMISSION OF EFFECT FROM THE CYLINDER.

The principle that no power can be gained or lost in its transmission by means of mechanism, enables us without much difficulty to trace the effective working of an engine due to a given pressure in the cylinder.

Let a denote the diameter of the cylinder in inches.

l „ the length of the stroke in feet.

τ „ the temperature of the steam in the cylinders.

P „ its mean pressure in lbs. per square inch.

F „ the entire friction, estimated on the pistons, in lbs. per square inch.

For high pressure engines this must include the pressure of the atmosphere.

R „ the resistance, in lbs., overcome at the extremity of the two wheels connected with the shaft.

n „ the number of strokes per minute.

u „ the velocity of the piston in feet per minute.

V „ the velocity of the circumference of the wheel in feet per minute.

π „ 3.14159, &c.

Then if Q denote the force on the pistons which would just overcome the resistance R , we shall have, equating their powers, $Q u = R V$; and therefore $Q = \frac{V}{u} R$. The area of the

two pistons being $\frac{\pi}{2} a^2$ square inches, the pressure per inch just sufficient to overcome the resistance will be $q = \frac{Q}{\frac{\pi}{2} a^2} = \frac{2 Q}{\pi a^2} = \frac{2 V}{\pi a^2 u} R$. To this add the friction F , and the entire

pressure per square inch on the pistons is hence,

$$P = \frac{2 V}{\pi a^2 u} R + F \dots (A).$$

But since V passes through πD , a circumference of the wheel, and u passes through $2 l$, twice the length of the stroke, in each revolution, $\frac{V}{u} = \frac{\pi D}{2 l}$; and this being substituted in (A) we get,

$$P = \frac{D}{a^2 l} R + F \dots (B);$$

and hence,

$$F = P - \frac{D}{a^2 l} R \dots (C),$$

$$R = \frac{a^2 l}{D} (P - F) \dots (D);$$

which express the relations amongst the mean forces or pressures P , F , R .

The velocities of the parts of the engine depend on the number of strokes, that of the piston being,

$$u = 2 n l \dots (E).$$

Also the number of horses' power on two cylinders, according to Tredgold's general rule, page 197, is found to be,

$$H = \frac{\frac{\pi}{2} a^2 P \times 2 n l}{33000},$$

$$\text{or } H = \frac{\pi n a^2 l P}{33000} \dots\dots (F).$$

The numerator of this expression represents the quantity of steam ($\pi n a^2 l$) consumed per minute multiplied into the pressure (P) at which it is supplied to the cylinder: and, the temperature τ being supposed to be preserved, this product, in fact, expresses the evaporating power of the boiler, including, of course, the necessary reductions for the unavoidable losses by the passage of the steam through the steam pipe, the clearance of the cylinder, &c.; and it hence also appears that the effective evaporating power of an engine is proportional to the number of horses' power.

The equation (F) gives also,

$$n P = \frac{33000 H}{\pi a^2 l} \dots\dots (G).$$

Thus it appears, that when the engine is working at a given power, the number (n) of strokes per minute will vary inversely as the mean pressure P on the piston, which is a principle particularly applicable to the motion of Locomotive Engines, where the forces P, R, are subject to considerable variations.

The special relations of the motion of locomotive engines have been ably treated by the Chevalier G. De Pambour, in a valuable treatise recently published by Mr. Weale, which contains much valuable practical information on the subject. From numerous experiments with different engines on the Liverpool and Manchester Railway, made under the author's inspection, with the view of ascertaining the amount of friction, he has arrived at the following useful conclusions, respecting the resistance to traction, which may be regarded as approximate estimations for locomotive engines as at present constructed, viz.

1. That the average tractive friction of the carriages, without the engine and tender, may be reckoned at 8 lbs. per ton of the entire weight of the carriages and load. (Page 116).
2. That the average friction or resistance to traction of well-constructed locomotive engines, in good order, is about 15 lbs. per ton of their weight. (Page 136).
3. That the tractive friction of the engine is increased by the load at an average of about 1 lb. per ton. (Page 157).

We may hence add,

4. That the friction of the wheels alone of an engine, by the first estimation, being 8 lbs. per ton of its own weight, the friction due to its own weight as a load being 1 lb. per ton, and the whole resistance being 15 lbs. per ton, it follows, that the friction of the engine gear alone, independently of any connexion with the rails, is, on the average, about 6 lbs. per ton of the weight of the engine applied at the circumference of the wheel.

5. That the entire resistance to an engine and train may be estimated at 9 lbs. per ton on the gross weight of the engine, tender, carriages, and load, increased by 6 lbs. per ton on the weight of the engine alone.

IV. TRANSMISSION FROM THE BOILER TO THE CYLINDER.

M. Pambour professes to determine the velocities on considerations of a novel nature, which may be briefly explained, thus: If the evaporating power of the boiler be capable of supplying a greater quantity of steam, at the required pressure, than is consumed at the successive strokes of the piston, it is evident that the pressure of the steam in the boiler will gradually increase, provided no portion is supposed to escape through the safety valve or otherwise. This increasing pressure will gradually accelerate the velocity; and finally, when the engine attains her permanent speed, the quantity of steam consumed in the cylinder and supplied through the steam pipe, must evidently correspond with the quantity evaporated by the boiler. Thus he pretends to introduce a new element into the calculation, viz., the evaporating power of the boiler, which again is to be estimated by the quantity of fire surface; and, the density of steam at a given temperature being, according to the law of Boyle and Mariotte, proportional to the pressure and inversely as the volume, as in the case of gases, the evaporating power is measured by the volume of steam, generated in a given time, multiplied into its pressure. We submit, however, that M. Pambour is mistaken if he supposes such a mode of proceeding to involve any new doctrine, or any principle that had not already been laid down by Mr. Tredgold in the first edition of this work. In support of this statement we need only refer to the equations (F), (G), which are founded on Tredgold's well-known rule for calculating the power of an engine, and from which it will appear that he measures the power by the quantity of steam effectively consumed in the cylinder per minute, multiplied into its pressure. Indeed, the preceding equations (A), (B), (C), (D), (E), (F), (G), which are strictly in accordance with the principles laid down by Tredgold, constitute the whole of our scientific information on the power of the steam engine that has hitherto been established on theoretical principles. No scientific theorist or experimentalist has yet satisfactorily ascertained the laws which regulate the transmission of the steam from the boiler to the cylinder,¹ and we cannot, therefore, be surprised that Tredgold has treated this part of the subject in a very slight and imperfect manner. We here allude to Art. 396, which has especially been objected to by the Chev. de Pambour, in a Memoir on the Steam Engine, just published in the form of a pamphlet by Mr. Weale. With this we may include Articles 402, 408, 416, and 426; and we

¹ It is impossible that this difficulty can ever be properly surmounted until we first determine either the specific heat of steam, or the whole quantity of heat contained in a given volume of steam at a given temperature and pressure. A decisive step towards the solution of this most important problem has been effected by E. Clapeyron, in a Memoir inserted in the 'Journal de l'Ecole Royale Polytechnique,' vol. xiv. page 153. The investigation is conducted on a principle which to all appearance is deserving of credit, viz., that no power can possibly be created or generated without the transmission of a portion of heat, and that the amount of power must be wholly independent of the nature of the medium of transmission. The latter condition depends on the former; for if the power developed varied with the nature of the medium, a quantity of heat being transmitted by one medium and returned by another, a portion of power might be so gained or lost without any resulting or effective transmission. In this principle it is of course assumed that no loss of power or *vis viva* is occasioned by contact of bodies of different temperatures. The application of it is very ingenious, and leads to the following expression for the whole quantity (Q) of heat contained in a volume (v) of steam at the pressure (p), viz.,

$$Q = f(p \cdot v) - F(p \cdot v) \text{ hyp. log. } p,$$

in which $f(p \cdot v)$, $F(p \cdot v)$ denote functions of the product ($p \cdot v$) of the pressure and volume, the nature of which functions still remain to be determined before the solution can be considered to be complete. It is found by experiments, that the latter function increases gradually with the temperature.

have every reason to suppose that they were all of them approximate estimations for the work of such engines as Mr. Tredgold had access to for his experience, which, in reference to engines now constructed, were no doubt of very limited dimensions and power, and of comparatively inferior workmanship. There can be no doubt that estimations of this kind, where a fixed proportion of the whole power is taken, are not to be depended upon. It cannot, however, be overlooked that M. Pambour, in throwing discredit on what he terms the ordinary theory, has unfairly applied the principle of constant coefficients in such a way as had never been contemplated by Tredgold or any one else; besides, it should be observed, that M. Pambour has only evaded the difficulty in another way: he has estimated the friction and losses in a manner more in accordance with the nature of the steam engine, but, nevertheless, equally as empirical as that of Tredgold; and the state of the problem remains nearly the same as it did before. For instance, in his *Treatise on Locomotive Engines*, page 184, he takes the effective evaporation through the cylinders at three-fourths of the total evaporation in the boiler, viz., the effective evaporating power 0.3 cubic foot, and the total evaporating power 0.4 cubic foot of water, for each square foot of surface exposed to the fire. On the whole, we are compelled to conclude that such estimations are not to be relied upon as general rules; that where accuracy is really wanted, the actual amount of loss, &c., is only to be estimated by having recourse to the experience of each individual description of engine under given circumstances; and that the correct value of the effective power of an engine is only to be found in the mean pressure on the piston, and the velocity with which it moves, according to the old rule.

There is one more point in M. Pambour's strictures on Tredgold's principles which it may be necessary to notice, being one on which he has, by some sort of inattention, allowed himself to be grossly deceived. The point in question, which, on being misrepresented, might possibly mislead others, is involved in the following extract from page 9 of his *Memoir on the Steam Engine*:

“Tredgold, in his *Treatise on Steam Engines* (Art. 127 and following), undertakes to calculate the velocity of the piston from considerations deduced from the velocity of the flowing of a gas, supposed under a pressure equal to that of the boiler, into a gas supposed at the pressure of the resistance. He concludes from thence, that the velocity of the piston would be expressed by this formula,

$$V = 6.5 \sqrt{h},$$

“in which V is the velocity in feet per second, and *h* stands for the difference between the heights of two homogeneous columns of vapour, one representing the pressure in the boiler, the other that of the resistance. But it is easily seen, that this calculation supposes the boiler filled with an inexhaustible quantity of vapour, since the effluent gas is supposed to rush into the other with all the velocity it is susceptible of acquiring, in consequence of the difference of pressure. Now such an effect cannot be produced, unless the boiler be capable of supplying the expenditure, however enormous it might be. This amounts consequently to supposing that the production of steam in the boiler is unlimited. But, in reality, this is far from being the case. It is evident that the velocity of the piston will soon be limited by the quantity of steam producible by the boiler in a minute. If that production suffice to fill the cylinder 200 times in a minute, there will be 200 strokes of the piston per minute; if it suffice to fill it 300 times, there will be 300 strokes. It is then the vaporization of the boiler which must

“regulate the velocity, and no calculation which shall exclude that element can possibly lead to the true result; consequently the preceding formula cannot be exact.

“This is why, in applying this formula to the case of an ordinary locomotive engine of the Liverpool Railway with a train of 100 tons, the velocity the engine ought to assume is found to be 734 feet per second, instead of twenty miles an hour, or 30 feet per second, which is its real velocity.”

On reference to the article alluded to, it will at once be perceived that these remarks are based entirely on M. Pambour's own misconception of what Tredgold has really given. The formula in question has no reference whatever to the velocity of the piston. It will be observed, that instead of the velocity of the piston, it is distinctly given as the velocity of the steam through the steam pipe, and that the sole object of Tredgold's inquiry is no velocity at all, but merely the determination of the requisite aperture of the steam pipe! This sufficiently accounts for M. Pambour having puzzled himself with the case of the Liverpool Railway locomotive engine, and leaves us with the full assurance that Tredgold was too well acquainted with the nature of his subject to allow himself to wander so immeasurably from the truth as M. Pambour had supposed.

We have not made the preceding remarks with any view to the disparagement of what the Chev. de Pambour has done towards our knowledge of the steam engine, which we by no means hold to be unimportant: he is evidently well versed in the practical nature of its action; he has, doubtless, furnished the best set of experiments on locomotive engines, and his general remarks embody much sound and valuable information on that subject. We cannot, however, admit that he has made any important advance in the mathematical theory of the steam engine, much less that he has brought it to absolute perfection; and so long as the theory remains incomplete, we must continue to make certain estimations by assumed and approximate rules. It is fortunate, however, that the theory of transmission from the boiler to the cylinder¹ and other points, which Tredgold left untouched, and which are still open for future investigation, are matters that may be practically dispensed with.

V. PADDLE WHEELS.

It was originally our intention to have entered rather fully into the theory of the action of paddle wheels; but this has been rendered almost wholly unnecessary by the valuable contributions of Mr. Barlow and Mr. Mornay, who have each discussed the subject with great ability and at considerable length. Mr. Barlow's paper is interspersed with numerous experimental results arranged in the convenient form of tables, and he has successfully applied these results to the solution of various practical questions of great importance. Mr. Mornay has classified the various kinds of wheel, and treated the subject of their capabilities and relative merits with an attention to mathematical precision much to be desired, but which we think, in some cases, unfortunately, to be beyond the practical nature of the inquiry, since the action of the floats must always be affected, in some degree, by the disturbance of the fluid through which they have to pass, more particularly when the velocity of the vessel is

¹ It would be highly desirable to have a series of well-conducted experiments on this point.

slow. This disturbance has already been partially alluded to in the foot-note at page 311 of this work, and it will no doubt, to a certain extent, vitiate any calculation of the power of an engine which does not include its influence, however exact it may be in other respects. Besides, independently of this disturbance, the assumed law that the resistance varies as the square of the velocity, cannot be regarded as satisfactorily established, since another agent, of considerable influence, is to be found in the waves produced by the action of the vessel on the fluid. For these reasons we are inclined to doubt whether, to practical men in particular, the general accuracy of the calculations can reach that degree of minuteness which will compensate the labour incurred by the complexity of Mr. Mornay's analytical expressions. His investigations cannot fail, however, to be highly esteemed by such of our scientific readers as may be desirous of thoroughly examining the theory of this interesting and important subject.

We here propose, in the first place, to explain precisely how the power of the engine is distributed in the general production of effect; then to show how the determination of the power of a wheel, by means of the centre of pressure, may be materially simplified for practical calculation; after which we shall add a few remarks on the resistance of fluids.

Suppose a force Q to intervene between any two objects A, B , tending to their separation, and to act simultaneously upon both of them in the opposite directions, according to the property of action and reaction. Then, if da, db , denote the indefinitely small distances described in an element of time, and c the mutual distance of A and B , by the principle of living forces the quantity of power expended on A will be $Q da$, that expended on B will be $Q db$, and the entire expenditure of power will be $Q da + Q db = Q dc$. In this manner we shall find no difficulty in resolving the action of a paddle wheel into its distinct effects on the vessel and the fluid.

In the annexed diagram let C be the centre of the wheel; $A D B$ the arc which passes through the centres of pressure of the paddles, and $m n$ any position of one of them when immersed in the fluid.

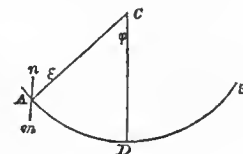

Let V denote the circumferential velocity of the point A round the centre C , in feet per second.

- v ,, the velocity of the vessel in feet per second.
- k ,, CA , the radius of the wheel to the centre of pressure, and estimated in feet.
- a ,, the height of C above the surface of the fluid, and estimated in feet.
- ϕ ,, the angle ACD of the radius, with the vertical.
- α ,, the value of ϕ when the point A enters or quits the fluid.
- ϵ ,, the angle nAC of the paddle with the radius.
- m ,, the number of paddles on each wheel.
- s ,, the surface of each paddle, in square feet.
- S ,, the surface of the m paddles on each wheel, $= m s$.
- p ,, the pressure on the paddle, in lbs., supposed to be concentrated at A .

Then, the angle of the float with the vertical $= \phi - \epsilon$; the velocity V resolved in the direction perpendicular to the surface of the paddle $= V \cos. \epsilon$; that of $v = v \cos. (\phi - \epsilon)$ in the opposite direction; and therefore the effective velocity of the paddle through the water per-

pendicularly to its plane is $V \cos. \epsilon - v \cos. (\phi - \epsilon)$. Consequently, adopting the same law of resistance as that followed by Mr. Mornay, we have,

$$p = \frac{ws}{2g} \left\{ V \cos. \epsilon - v \cos. (\phi - \epsilon) \right\}^2 \dots (a).$$

By putting the effective velocity of the paddle equal to zero, we have $V \cos. \epsilon - v \cos. (\phi - \epsilon) = 0$, which gives,

$$\tan. \epsilon = \frac{V - v \cos. \phi}{v \sin. \phi} \dots (b);$$

and this determines the position in which the paddle would pass through the water edgewise, without producing any effect.

The pressure p being resolved tangentially, horizontally, and vertically, gives,

$$\begin{aligned} \text{Tangential pressure} &= p \cos. \epsilon, \\ \text{Horizontal pressure} &= p \cos. (\phi - \epsilon), \\ \text{Vertical pressure} &= p \sin. (\phi - \epsilon). \end{aligned}$$

In an elementary instant dt of time, the distances traversed by the point A are,

$$\left. \begin{aligned} \text{Tangential distance} &= V \cdot dt \\ \text{Horizontal distance} &= V \cos. \phi \cdot dt \end{aligned} \right\} \text{relatively to the Engine};$$

also,

$$\left. \begin{aligned} \text{Horizontal distance} &= (V \cos. \phi - v) \cdot dt \\ \text{Vertical distance} &= V \sin. \phi \cdot dt \end{aligned} \right\} \text{relatively to the Fluid};$$

and the horizontal distance traversed by the vessel $= v \cdot dt$.

By multiplying the tangential pressure into the tangential distance relatively to the engine, we have,

$$\text{Power developed by the engine} = p V \cos. \epsilon \cdot dt.$$

By multiplying the horizontal pressure into the horizontal distance traversed relatively to the engine, we have,

$$\text{Power developed horizontally} = p V \cos. \phi \cos. (\phi - \epsilon) \cdot dt.$$

By multiplying the vertical pressure into the distance traversed vertically, we have,

$$\text{Power developed vertically} = p V \sin. \phi \sin. (\phi - \epsilon) \cdot dt.$$

By multiplying the horizontal pressure by the horizontal distance traversed with respect to the fluid, we have,

$$\text{Power expended horizontally on the water} = p (V \cos. \phi - v) \cos. (\phi - \epsilon) \cdot dt.$$

Lastly, by multiplying the horizontal pressure by the horizontal distance traversed by the vessel, we have,

$$\text{Power expended horizontally on the vessel} = p v \cos. (\phi - \epsilon) \cdot dt.$$

These results may be conveniently classified thus :

$$\text{I. Entire power expended} \left\{ \begin{array}{l} \text{by the Engine} = p V \cos. \epsilon \cdot dt \\ \text{on the Fluid} = p \{ V \cos. \epsilon - v \cos. (\phi - \epsilon) \} \cdot dt \\ \text{on the Vessel} = p v \cos. (\phi - \epsilon) \cdot dt \end{array} \right\} \dots (c).$$

$$\begin{array}{l}
 \text{II. Power expended horizontally} \\
 \left\{ \begin{array}{l} \text{by the Engine} = p V \cos. \phi \cos. (\phi - \epsilon) . dt \\ \text{on the Fluid} = p (V \cos. \phi - v) \cos. (\phi - \epsilon) . dt \\ \text{on the Vessel} = p v \cos. (\phi - \epsilon) . dt \end{array} \right\} \dots (d).
 \end{array}$$

$$\begin{array}{l}
 \text{III. Power expended vertically} \\
 \left\{ \begin{array}{l} \text{by the Engine} \\ \text{on the Fluid} \end{array} \right\} = p V \sin. \phi \sin. (\phi - \epsilon) . dt \\
 \left. \begin{array}{l} \\ \text{on the Vessel} = o \end{array} \right\} \dots (e).
 \end{array}$$

In each case it will be observed that the power expended by the engine is made up of the powers expended on the fluid and on the vessel; it will also be observed that the entire expenditure is made up of the horizontal and vertical expenditures.

The whole power expended by the engine being $p V \cos. \epsilon . dt$, and the useful power, or that expended horizontally on the vessel, being $p v \cos. (\phi - \epsilon) . dt$, the proportion of the power that is effective is $\frac{v \cos. (\phi - \epsilon)}{V \cos. \epsilon}$, which evidently increases with the angle ϵ . It attains the value of *unity* when ϵ attains the value according to the equation (b), or when the paddle moves through the water edgewise, and produces no effect. If ϵ be taken greater than the value so determined, the effective velocity will become negative, and the paddle will act in the contrary direction and retard the vessel. It is wrong, however, to suppose, as is sometimes done, that the misdirected action of the vertical paddle in such a case constitutes a dead loss of power, since it is plain that when the paddle ceases to propel the vessel, it will at the same instant cease to put the engine to any expense of power; and when it impedes the vessel, it will, at the same time, assist the efforts of the engine, and thereby increase the action of the other paddles.

By integrating the preceding expressions (c) (d) (e), we shall obtain the respective amounts of power developed by one paddle during any finite time, or throughout any proposed finite distance. For conciseness let $N dt$ denote any one of them. Then $\int_0^\alpha N dt$ will give the power expended during each half revolution of the wheel, supposing the motion of the paddle to begin or end at the lowest point D; or since $dt = \frac{k d\phi}{V}$,

$$\left. \begin{array}{l} \text{Power expended by one paddle in each} \\ \text{half revolution} \end{array} \right\} = \frac{k}{V} \int_0^\alpha N d\phi,$$

$$\left. \begin{array}{l} \text{Power expended by all the paddles in} \\ \text{each half revolution} \end{array} \right\} = \frac{2 m k}{V} \int_0^\alpha N d\phi.$$

Now, the circumferential distance traversed by the centre of pressure, in half a revolution, being πk , and the velocity per minute being $60 V$, the number of minutes elapsed will be $\frac{\pi k}{60 V}$. Therefore, dividing the last expression by this number, we have,

$$\left. \begin{array}{l} \text{Power expended per minute by} \\ \text{both wheels} \end{array} \right\} = \frac{120 m}{\pi} \int_0^\alpha N d\phi.$$

Hence, dividing this by the amount expended per minute by one horse's power = 33000 \times 1 = 33000, we get,

$$\left. \begin{array}{l} \text{Horse power expended by both} \\ \text{wheels} \end{array} \right\} = \frac{m}{275 \pi} \int_0^{\alpha} N d\phi \dots (f).$$

In the values of N given in equations (c), (d), (e), restore the value of p by equation (a); assume

$$c = \frac{1000}{275 \pi} \cdot \frac{v}{2g} = 1.15291 \dots (g),$$

and we deduce the following general formulæ :

I. HORSES' POWER expended ENTIRE,

$$\left. \begin{array}{l} \text{by the Engine} \\ \text{on the Fluid} \\ \text{on the Vessel} \end{array} \right\} = \frac{c S}{1000} \times \left\{ \begin{array}{l} V \int_0^{\alpha} \cos. \epsilon \left\{ V \cos. \epsilon - v \cos. (\phi - \epsilon) \right\}^2 d\phi \\ \int_0^{\alpha} \left\{ V \cos. \epsilon - v \cos. (\phi - \epsilon) \right\}^3 d\phi \\ v \int_0^{\alpha} \cos. (\phi - \epsilon) \left\{ V \cos. \epsilon - v \cos. (\phi - \epsilon) \right\}^2 d\phi \end{array} \right\} \dots (h)$$

II. HORSES' POWER expended HORIZONTALLY,

$$\left. \begin{array}{l} \text{by the Engine} \\ \text{on the Fluid} \\ \text{on the Vessel} \end{array} \right\} = \frac{c S}{1000} \times \left\{ \begin{array}{l} V \int_0^{\alpha} \cos. \phi \cos. (\phi - \epsilon) \left\{ V \cos. \epsilon - v \cos. (\phi - \epsilon) \right\}^2 d\phi \\ \int_0^{\alpha} (V \cos. \phi - v) \cos. (\phi - \epsilon) \left\{ V \cos. \epsilon - v \cos. (\phi - \epsilon) \right\}^2 d\phi \\ v \int_0^{\alpha} \cos. (\phi - \epsilon) \left\{ V \cos. \epsilon - v \cos. (\phi - \epsilon) \right\}^2 d\phi \end{array} \right\} \dots (i)$$

III. HORSES' POWER expended VERTICALLY,

$$\left. \begin{array}{l} \text{by the Engine} \\ \text{on the Fluid} \\ \text{on the Vessel} \end{array} \right\} = \frac{c S}{1000} \times V \int_0^{\alpha} \sin. \phi \sin. (\phi - \epsilon) \left\{ V \cos. \epsilon - v \cos. (\phi - \epsilon) \right\}^2 d\phi \dots (k)$$

= 0

To effect the integration of these expressions, the mechanical properties of the wheel will give ϵ a function of ϕ ; and in this way they will evidently apply to every possible description of wheel.

By way of examples we shall apply the formulæ (h) to Oldham's wheel, the common wheel, and the vertically acting wheel.

1. **OLDHAM'S WHEEL.** Here $\epsilon = \frac{\phi}{2}$, and hence, the number of horses' power expended,

$$\left. \begin{array}{l} \text{by the Engine} \\ \text{on the Fluid} \\ \text{on the Vessel} \end{array} \right\} = \frac{c S}{1000} \times \left\{ \begin{array}{l} V (V - v)^2 \int_0^\alpha d\phi \cos.^3 \frac{\phi}{2}. \\ (V - v)^3 \int_0^\alpha d\phi \cos.^3 \frac{\phi}{2}. \\ v (V - v)^2 \int_0^\alpha d\phi \cos.^3 \frac{\phi}{2}. \end{array} \right.$$

In which

$$\int_0^\alpha d\phi \cos.^3 \frac{\phi}{2} = 2 \left(\frac{1}{3} \cos.^2 \frac{\alpha}{2} + \frac{2}{3} \right) \sin. \frac{\alpha}{2} = \frac{5 + \cos. \alpha}{3} \cdot \sin. \frac{\alpha}{2} = \frac{5 + \cos. \alpha}{3} \sqrt{\frac{1 - \cos. \alpha}{2}}$$

$$= \frac{5 + \frac{a}{k}}{3} \sqrt{\frac{1 - \frac{a}{k}}{2}} \text{ may be very readily calculated.}$$

The respective proportions of the whole power expended on the Fluid and Vessel are therefore $\frac{V - v}{V}$ and $\frac{v}{V}$.

2. **THE COMMON WHEEL.** Here $\epsilon = 0$, and the number of horses' power expended,

$$\left. \begin{array}{l} \text{by the Engine} \\ \text{on the Fluid} \\ \text{on the Vessel} \end{array} \right\} = \frac{c S}{1000} \times \left\{ \begin{array}{l} V \int_0^\alpha (V - v \cos. \phi)^2 d\phi. \\ \int_0^\alpha (V - v \cos. \phi)^3 d\phi. \\ v \int_0^\alpha \cos. \phi (V - v \cos. \phi)^2 d\phi. \end{array} \right.$$

3. **THE VERTICALLY ACTING WHEEL.** Here $\epsilon = \phi$, and the number of horses' power expended,

$$\left. \begin{array}{l} \text{by the Engine} \\ \text{on the Fluid} \\ \text{on the Vessel} \end{array} \right\} = \frac{c S}{1000} \times \left\{ \begin{array}{l} V \int_0^\alpha \cos. \phi (V \cos. \phi - v)^2 d\phi. \\ \int_0^\alpha (V \cos. \phi - v)^3 d\phi. \\ v \int_0^\alpha (V \cos. \phi - v)^2 d\phi. \end{array} \right.$$

Assume now,

$$\left. \begin{aligned} A &= c \int_0^{\alpha} d\phi &&= 1.15921 (\alpha) \\ B &= c \int_0^{\alpha} d\phi (\cos. \phi) &&= 1.15921 (\sin. \alpha) \\ A' &= c \int_0^{\alpha} d\phi (\cos.^3 \phi) &&= 1.15921 \left(\frac{3 \sin. \alpha}{4} + \frac{\sin. 3 \alpha}{12} \right) \\ B' &= c \int_0^{\alpha} d\phi (\cos.^2 \phi) &&= 1.15921 \left(\frac{\alpha}{2} + \frac{\sin. 2 \alpha}{4} \right) \end{aligned} \right\} \dots (l);$$

and we shall have,

With the COMMON WHEEL,

$$\text{Horses' Power} \left\{ \begin{array}{l} \text{expended by the Engine} \\ \text{effective on the Vessel} \end{array} \right\} = \frac{S}{1000} \times \left\{ \begin{array}{l} V (A V^2 - 2 B V v + B' v^2) \\ v (A' v^2 - 2 B' V v + B V^2) \end{array} \right\} \dots (m);$$

With the VERTICALLY ACTING WHEEL,

$$\text{Horses' Power} \left\{ \begin{array}{l} \text{expended by the Engine} \\ \text{effective on the Vessel} \end{array} \right\} = \frac{S}{1000} \times \left\{ \begin{array}{l} V (A' V^2 - 2 B' V v + B v^2) \\ v (A v^2 - 2 B V v + B' V^2) \end{array} \right\} \dots (n).$$

These last expressions afford great facility in the solution of any questions concerning the working of paddle wheels, as they give the most simple relations amongst the four leading quantities, viz., the proportionate immersion, the power, and the two velocities, and enable us to determine any one of these when the other three are known.

For convenience of calculation the values of the coefficients A, B, A', B', which depend on the immersion of the centre of pressure, are exhibited in the following table. They are given for every hundredth of immersion as far as eight-tenths of the radius of the wheel, which will take in every possible case in practice; and the smaller figures inserted at the right hand of each column are the respective differences of the two values between which they stand, and serve to expedite the interpolation of any intermediate value falling between those in the table, for which simple proportion will be quite sufficient.

CO-EFFICIENTS FOR CALCULATING THE ACTION OF PADDLE WHEELS.

[The first column contains the greatest immersion of the centre of pressure in parts of the radius drawn to that centre.]

Dip of centre of pressure.	A	B	A'	B'
0·00	0·0000 1632	0·0000 1626	0·0000 1616	0·0000 1621
0·01	0·1632 678	0·1626 668	0·1616 648	0·1621 658
0·02	0·2310 521	0·2294 509	0·2264 484	0·2279 496
0·03	0·2831 441	0·2803 425	0·2748 396	0·2775 410
0·04	0·3272 389	0·3228 372	0·3144 339	0·3185 355
0·05	0·3661 353	0·3600 333	0·3483 298	0·3540 316
0·06	0·4014 325	0·3933 305	0·3781 266	0·3856 284
0·07	0·4339 304	0·4238 280	0·4047 240	0·4140 260
0·08	0·4643 286	0·4518 262	0·4287 219	0·4400 239
0·09	0·4929 271	0·4780 246	0·4506 201	0·4639 222
0·10	0·5200 258	0·5026 231	0·4707 185	0·4861 208
0·11	0·5458 248	0·5257 219	0·4892 172	0·5069 194
0·12	0·5706 238	0·5476 208	0·5064 160	0·5263 182
0·13	0·5944 230	0·5684 199	0·5224 149	0·5445 172
0·14	0·6174 222	0·5883 191	0·5373 139	0·5617 162
0·15	0·6396 216	0·6074 182	0·5512 130	0·5779 154
0·16	0·6612 210	0·6256 175	0·5642 122	0·5933 146
0·17	0·6822 204	0·6431 168	0·5764 114	0·6079 139
0·18	0·7026 199	0·6599 162	0·5878 108	0·6218 132
0·19	0·7225 194	0·6761 156	0·5986 101	0·6350 126
0·20	0·7419 190	0·6917 151	0·6087 96	0·6476 120
0·21	0·7609 186	0·7068 147	0·6183 90	0·6596 115
0·22	0·7795 183	0·7215 141	0·6273 85	0·6711 110
0·23	0·7978 179	0·7356 137	0·6358 80	0·6821 105
0·24	0·8157 176	0·7493 133	0·6438 76	0·6926 100
0·25	0·8333 172	0·7626 129	0·6514 71	0·7026 96
0·26	0·8505 170	0·7755 125	0·6585 68	0·7122 92
0·27	0·8675 168	0·7880 121	0·6653 64	0·7214 88
0·28	0·8843 165	0·8001 118	0·6717 60	0·7302 84
0·29	0·9008 162	0·8119 114	0·6777 57	0·7386 81
0·30	0·9170 161	0·8233 111	0·6834 53	0·7467 78
0·31	0·9331 158	0·8344 109	0·6887 51	0·7545 74
0·32	0·9489 156	0·8453 106	0·6938 48	0·7619 71
0·33	0·9645 155	0·8559 102	0·6986 46	0·7690 68
0·34	0·9800 152	0·8661 100	0·7032 43	0·7758 65
0·35	0·9952 151	0·8761 98	0·7075 40	0·7823 63
0·36	1·0103 149	0·8859 94	0·7115 39	0·7886 60
0·37	1·0252 148	0·8953 93	0·7154 36	0·7946 58
0·38	1·0400 146	0·9046 90	0·7190 34	0·8004 55
0·39	1·0546 145	0·9136 87	0·7224 32	0·8059 53
0·40	1·0691 145	0·9223 87	0·7256 32	0·8112 53

Dip of centre of pressure.	A	B	A'	B'
0.40	1.0691	0.9223	0.7256	0.8112
0.41	1.0835 144	0.9309 86	0.7286 30	0.8163 51
0.42	1.0977 142	0.9392 83	0.7314 28	0.8212 49
0.43	1.1118 141	0.9473 81	0.7341 27	0.8259 47
0.44	1.1257 139	0.9552 79	0.7366 25	0.8303 44
0.45	1.1396 139	0.9629 77	0.7390 24	0.8346 43
	137	75	22	41
0.46	1.1533 137	0.9704 73	0.7412 21	0.8387 39
0.47	1.1670 137	0.9777 71	0.7433 20	0.8426 37
0.48	1.1805 135	0.9848 69	0.7453 20	0.8463 37
0.49	1.1939 134	0.9917 69	0.7471 18	0.8499 36
0.50	1.2073 134	0.9985 68	0.7488 17	0.8533 34
	133	65	16	32
0.51	1.2206 132	1.0050 64	0.7504 15	0.8565 31
0.52	1.2338 131	1.0114 62	0.7519 15	0.8596 30
0.53	1.2469 130	1.0176 61	0.7534 13	0.8626 28
0.54	1.2599 129	1.0237 59	0.7547 12	0.8654 27
0.55	1.2728 129	1.0296 57	0.7559 11	0.8681 25
	128	56	11	24
0.56	1.2857 128	1.0353 56	0.7570 11	0.8706 24
0.57	1.2985 128	1.0409 54	0.7581 10	0.8730 23
0.58	1.3113 126	1.0463 53	0.7591 9	0.8753 22
0.59	1.3239 126	1.0516 51	0.7600 8	0.8775 21
0.60	1.3365 126	1.0567 49	0.7608 8	0.8796 20
	125	48	7	18
0.61	1.3491 125	1.0616 48	0.7616 7	0.8816 18
0.62	1.3616 124	1.0664 47	0.7623 6	0.8834 18
0.63	1.3740 124	1.0711 45	0.7629 6	0.8852 16
0.64	1.3864 123	1.0756 44	0.7635 6	0.8868 15
0.65	1.3987 123	1.0800 42	0.7641 5	0.8883 15
	123	41	5	14
0.66	1.4110 123	1.0842 41	0.7646 5	0.8898 14
0.67	1.4233 122	1.0883 40	0.7651 4	0.8912 13
0.68	1.4355 121	1.0923 38	0.7655 4	0.8925 12
0.69	1.4476 121	1.0961 37	0.7659 3	0.8937 11
0.70	1.4597 121	1.0998 36	0.7662 3	0.8948 11
	120	34	3	10
0.71	1.4718 120	1.1034 34	0.7665 3	0.8959 10
0.72	1.4838 120	1.1068 33	0.7668 3	0.8969 9
0.73	1.4958 120	1.1101 32	0.7671 2	0.8978 9
0.74	1.5078 119	1.1133 30	0.7673 2	0.8986 8
0.75	1.5197 119	1.1163 29	0.7675 1	0.8994 8
	119	28	1	7
0.76	1.5316 119	1.1192 28	0.7676 2	0.9001 6
0.77	1.5435 118	1.1220 27	0.7678 1	0.9007 6
0.78	1.5553 118	1.1247 25	0.7679 1	0.9013 6
0.79	1.5671 117	1.1272 24	0.7680 1	0.9019 6
0.80	1.5788 117	1.1296 24	0.7681 1	0.9024 5

We have so far considered V , v , as arbitrary quantities; but it is evident that, with a given vessel, the dimensions and immersion of the wheel and paddles being given, the communication of any proposed velocity to the wheel must determine that of the vessel, and this will evidently depend on the nature and dimensions of the resisting surface she presents to the fluid. The resistance of the vessel may be estimated by that of a plane surface moving through the fluid perpendicularly to itself with the same velocity, and this may appropriately be termed the

effective surface of resistance. Denote this surface by S' , and the force of resistance in lbs. will be $\frac{w}{2g} S' v^2$. Multiply by $60 v$, the speed per minute, divide by 33000, and we obtain the number of horses' power effectively developed on the vessel, $h = \frac{1}{550} \cdot \frac{w}{2g} S' v^3 = \frac{\pi c}{2000} S' v^3$. Hence,

$$S' = \frac{2000}{\pi c} \cdot \frac{h}{v^3} \dots\dots (p).$$

This expression will serve to calculate the surface of resistance in any experiment; and by substituting the preceding value of h for any particular wheel we shall express the necessary relation between the velocities for a given vessel at a given immersion; and this relation will, in fact, express a constant ratio between the velocities. For the common wheel, for instance, this relation is,

$$S' = \frac{2 S}{\pi c} \left(A' - 2 B' \frac{V}{v} + B \frac{V^2}{v^2} \right)$$

and the ratio $\frac{V}{v}$ is determined by the positive root of quadratic equation,

$$A' - 2 B' \frac{V}{v} + B \frac{V^2}{v^2} = \frac{\pi c}{2} \frac{S'}{S}.$$

EXAMPLES.—Take the case of the 'Salamander' calculated by Mr. Mornay, at pages 127 and 135. The radius to the centre of pressure for the whole power is by Mr. Mornay denoted by y , and, in page 135, is 9.3937 feet; and that for the effective power is, page 138, $z = 9.355$ feet; also the paddles are 16 in number, depth 2 feet 6 inches, and breadth 8 feet 9 inches, making a surface of 350 square feet.

1. COMMON WHEEL.

For the calculation of the POWER OF THE ENGINE we have therefore $a = 5$, $k = 9.3937$, speed of the engine $n = 15$ strokes per minute, speed of the vessel 8.15 miles per hour, and the surface of paddle on each wheel $S = 350$ square feet. Hence,

log. a	0.69897	log. n	1.17609	log. 8.15	0.91116	log. S	2.54407
„ k	0.97284	„	0.97284	const. „ $\frac{22}{15}$	0.16633	„ V	1.16896
{	log.	9.72613	const. „ $\frac{\pi}{30}$	9.02003		„ $\frac{SV}{1000}$	0.71303
		0.5323	log. V	1.16896	log. v	1.07749	
	1.0000			„ V	1.16896		
Immersion	0.4677	log. V^2	2.33792	log. Vv	2.24645	log. v^2	2.15498
Hence $A =$	1.1638	„ A	0.06588	„ B	9.98945	„ B'	9.92516
$B =$	0.9760	„ $\frac{SV}{1000}$	0.71303	„	0.71303		0.71303
$B' =$	0.8417	{	3.11683	{	2.94893	{	2.79317
			1308.7		889.06		621.1
							1308.7
							1929.8
							1778.1
							Horse Power 151.7

The result of Mr. Mornay's calculation is 151·69 horse power.

For the calculation of the EFFECTIVE POWER we have $a = 5$, $k = 9·355$, $n = 15$, speed of the vessel = 8·15 miles per hour, and $S = 350$, with which we proceed as follows :

log. a	0·69897	log. n	1·17609	log. 8·15	0·91116	log. S	2·54407		
„ k	0·97104	const. „	0·97104	const. „	0·16633	„ v	1·07749		
	<hr/>		9·02003		<hr/>				
{	log.	9·72793		log. v	1·07749	„ $\frac{Sv}{1000}$	0·62156		
		<hr/>	log. V	1·16716	„ V	<hr/>			
	0·5345								
	<hr/>		log. v^2	2·15498	log. Vv	2·24465	log. V^2	2·33432	
	1·0000		„ A'	9·87064	„ B'	9·92469	„ B	9·98874	
Immersion	0·4655		„ $\frac{Sv}{1000}$	0·62156	„ - - -	0·62156	- - -	0·62156	
Hence $A' =$	0·7424								
$B' =$	0·8408		{	2·64718	{	2·79090	{	2·94462	
$B =$	0·9744			443·79		617·87		880·28	
								443·79	
								<hr/>	
								1324·07	
								1235·74	
								<hr/>	
								Effective horse power	88·33

Mr. Mornay makes it 88·275 horse power.

For the EFFECTIVE SURFACE OF RESISTANCE, we have, according to equation (p),

log. 88·33	1·94611
„ v^3	3·23247
	<hr/>
	8·71364
const. „ $\frac{2000}{\pi c}$	2·74208
	<hr/>
{	log. 1·45572

$S' = 28·56$ square feet of resisting surface, which is about $\frac{8}{1000}$ ths of the immersed sectional area of the vessel.

Mr. Barlow, page 76, estimates the resisting surface at $\frac{1}{17}$ th of the sectional area.

The PROPORTION OF THE POWER THAT IS EFFECTIVE, when the common wheel is employed, is $\frac{v}{V} \cdot \frac{A'v^2 - 2B'Vv + BV^2}{AV^2 - 2BVv + B'v^2}$; or, if x denote $\frac{v}{V}$ the ratio of the velocities, we have,

$$\text{Proportion of power effective} = x \frac{A'x^2 - 2B'x + B}{A - 2Bx + B'x^2} = xz, \text{ where the value of}$$

the factor z may be taken out roughly from the following table :—

The same depth and number of paddles being taken as before, this amount of surface gives a breadth of 10.56 inches. Mr. Mornay calculates it 10.6 inches.

The requisite POWER OF THE ENGINE may now be found as follows :

log. V^2	2.93920	log. Vv	2.54709	log. v^2	2.15498
„ A'	9.86988	„ B'	9.92350	„ B	9.98677
„ $\frac{SV}{1000}$	0.01621		0.01621		0.01621
	2.82529		2.48680		2.15796
	668.79		306.76		143.87
					668.79
					812.66
					613.52
					Horse power 199.14

Mr. Mornay's calculation is 199.31 horse power.

3. OLDHAM'S WHEEL.

Taking the same data as in the first example, let it be required to determine the requisite amount of PADDLE SURFACE (S) on each wheel.

		log. a	0.69897	$V =$	14.530
		„ k	0.96614	$v =$	11.953
			9.73283	$V - v =$	2.577
$\frac{a}{k}$	0.54054	„ $\frac{a}{k}$	9.66225		
$1 - \frac{a}{k}$	0.45946	„	9.83113		
		$\frac{1}{2}$ ditto	9.83113		
$5 + \frac{a}{k}$	5.54054	log.	0.74355	Effective Power } 88.33	log. 1.94611
$\frac{c}{3} \sqrt{\frac{1}{2}}$		„	9.43416		
			0.00884		log. 0.03756
$(V - v)^2$		„	0.82222		S
v		„	1.07749		1000
		log.	1.90855		1.0903
					$\therefore S = 1090.3$ feet.

This wheel, therefore, requires a much larger surface of paddle than the common wheel. Indeed, under any given circumstances, the common wheel may be said to possess the advantages of requiring the least surface of paddle to produce a given effect, and of encumbering the action with the least possible amount of friction and strain on the bearings, which are recommendations of a very strong character.

VI. ON THE ACTUAL RESISTANCE OF BOATS ON CANALS.

The experiments alluded to in the foot-note, page 297, were made by John Macneill, Esq., C.E., &c., in July 1834, on two canals in Scotland, with the boats actually used in the traffic on those canals; and from a scientific gentleman of such universally acknowledged ability and experience, they are deserving of the greatest reliance. The experiments, which

are very numerous and of a varied character, were conducted with great care; and an interesting description of the circumstances under which they were made, and a well-arranged table showing the results observed, are given in detail in vol. i. of the Transactions of the Institution of Civil Engineers, to which we refer such of our readers as may wish for minute information. A few extracts will be sufficient to show that the theory which considered the resistance of a vessel moving on a canal to be as the square of the velocity, can no longer be maintained.

The canals upon which Mr. Macneill made his experiments were of very different sizes. This circumstance alone had the unexpected effect of destroying the universality of the application of the ordinary rule. On neither canal did the resistance vary precisely as the square of the velocity: and it is remarkable that the increase was not the same in the wide and deep canal as it was in the narrow and shallow one. An extensive field of enquiry is thus opened, which will require much time and numerous observers to collect the harvest of interesting and important facts which it contains.

We have thrown our extracts into Tables, for more convenient reference and comparison. Table I. contains the experiments on the larger canal: Table II. those on the smaller; and it will be observed that the resistance on this canal was less at velocities of 9 and 10 miles per hour, than of those of 7 and 8! The velocities marked * were taken as the standards of comparison.

TABLE I.—EXTRACT. EXPERIMENTS MADE UPON THE FORTH AND CLYDE CANAL.

No. of experiment in the series.	Total weight moved.	Velocity in miles per hour.	Resistance in hours avoided.	Power of the velocity according to which the resistance varies.	Name of boat.
56	ton. cwt. qr. lb.	3.4*	51		Rapid.
49	8 3 0 21	9.9	435	2.01	
62		7.62	363	2.43	
59		8.08	395	2.37	
97	3 12 0 6	4.22*	40.5		Zephyr.
95		9.33	225.4	2.16	
94		12.33	362.8	2.04	
101	3 18 0 6	4.12*	42.95		
100		7.34	153.8	2.21	
99		9.28	233.7	2.09	
98		12.08	367.5	2.00	
106	5 11 0 6	4.04*	50.4		
109		8.41	281.45	2.35	
108		11.69	427.5	2.01	
113	6 17 0 6	4.29*	59.97		
112		8.11	331.1	2.68	
111		10.72	422.3	2.13	
116	4 5 0 6	4.73*	59.9		
115		10.00	274.7	2.04	
114		12.18	383.3	1.96	
118		12.17	386.2	1.97	
128	3 12 3 5	4.39*	55.9		Lark.
127		9.28	257.8	2.04	
126		11.38	348.9	1.92	
132	3 17 3 5	4.26*	44.1		
131		9.63	266.8	2.21	
130		11.57	375.0	2.14	

Dimensions of the Section of the Forth and Clyde Canal.



TABLE II.—EXTRACT. EXPERIMENTS MADE UPON THE MONKLAND CANAL.

No. of experiment in the series.	Total weight moved.				Velocity in miles per hour.	Resistance in hours avoided.	Power of the velocity according to which the resistance varies.	Remarks, and Name of boat.
	ton.	cwt.	qr.	lb.				
266	4	18	0	20	3.70*	42		Rapid.
267					6.00	135	2.41	
264					6.17	168	2.71	
263					9.39	358	2.30	
262					10.97	383	2.03	
261					10.98	406	2.08	
260					6.73	323	3.41	
269					8.03	385	2.86	
270					9.00	318	2.27	
270					9.38	359	2.31	
271					7.26	362	3.19	Heavy swell. Light swell. Light swell.
271					7.38	431	3.36	
274					10.71	471	2.27	
275					9.57	271	1.96	

Dimensions of the Section of the Monkland Canal.



From the observations made upon the spot by Mr. Macneill we select the following interesting and important conclusions.

“ That in the wide and deep canal the resistance was observed to increase with the velocity, but not in any uniform ratio.

“ That in the shallow and narrow canal the resistance had a limit at a certain velocity, and under certain circumstances even *decreased with the increase of velocity*.

“ That there existed a relation between the resistance and the inclination of the keel; the resistance diminishing and increasing in some ratio or other, as the angle it made with an horizontal line diminished or increased.

“ That the boat absolutely rises during its motion. This fact was most satisfactorily demonstrated by the apparatus designed for the purpose. In some of the experiments, the mean of the several rises, indicated by the four slips, was about 4 inches, the bow being, in every case, more elevated than the middle and stern.”

The subject of this last observation has excited considerable interest amongst scientific men, but it does not appear to have met with a satisfactory explanation. It has been particularly noticed by Mr. Russell of Edinburgh, the same gentleman we alluded to at page 182, who has, in furtherance of the objects of the British Association for the Advancement of Science, devoted much time and labour to the experimental investigation of the progression and nature of the waves produced on canals and rivers. Mr. Russell's experiments have proved very successful, and in his reports he has developed many valuable and interesting facts relative to the phenomena of waves, which promise to have an important bearing on the prosecution of future hydrodynamical researches; but, in our view, he has, in some instances, jumped rather hastily to his general conclusions, and in his endeavours to investigate, or rather to induce, the laws of dynamical and statical emersions, we conceive he has proceeded on sup-

positions that are not altogether in accordance with universally received principles. For instance, in the first section of his researches, printed in vol. xiv. of the Transactions of the Royal Society of Edinburgh, after having stated that the resistance of a small unit of surface to a fluid, when either the fluid is in motion, or the surface itself is equal to the statical pressure of a column of fluid having for its height the height due by gravity to that velocity, he asserts that "this statical quantity being the measure of the pressure of the fluid upon the anterior surface of the immersed solid, will also be the measure of the *quâquaversus* pressure of the fluid in every direction, and therefore will measure the pressure of the water upon the vessel causing its emersion." This assumed hypothesis is obviously inconsistent with the mode in which the action and reaction takes place between the vessel and the fluid; and its random nature, independently of other misapplications of mathematical principles, to which it is not necessary to advert, is amply sufficient to account for the startling nature of the conclusion to which it leads, viz., that the vessel rises with every increase of velocity, and that "at 43·8 miles an hour, the floating body *emerges wholly from the fluid and skims the surface.*" By what mysterious action of forces the vessel is thus elevated or suspended in the air, is, of course, left for the reader to find out, but we trust it will not long exercise his ingenuity.

The principal feature of Mr. Russell's observations is the propagation of the great solitary wave of displacement, which appears to act an important part in the modification of the resistance to the vessel; and Mr. Russell's beautiful illustrations of its mechanism and properties are very interesting and important. It is remarkable that the velocity of the generating body does not in any way affect the velocity of this wave; a wave, for example, of 8 miles an hour being produced alike from bodies moved at the rate of 2, 5, 6, and 12 miles an hour. The velocity appears to depend chiefly on the depth of the fluid, and Mr. Russell, in his experiments on canals, has found that in each case it does not differ sensibly from that which is acquired by a heavy body in falling freely by gravity through a space equal to the depth of the centre of gravity of a cross section of the fluid, below the surface. It is not difficult to conceive how this wave exercises its influence and the changes that must take place in the resistance, accordingly as the vessel falls behind the wave, mounts upon it, or passes over it.

The only rational explanation of the phenomenon of the vessel rising out of the fluid, appears to depend on the form of its construction. Thus, the action of the fluid, excepting the slight influence of friction, must, at each point, always be directed perpendicularly to the surface of the vessel; and hence, when in motion, the increase of head pressure must tend to elevate the head of the vessel, whilst the loss of stern pressure will cause the stern to lose a portion of its statical support, and so sink deeper into the fluid. And if we simply consider that the elevated position of the keel of the vessel, so acquired, has a direct tendency to increase the elevating action of the fluid at the head of the vessel, and to retrieve the loss of stern support, the partial rising out of the fluid becomes an immediate consequence of the resolved forces; and it is evident that the vessel cannot, under any circumstances, emerge wholly out of the fluid. The truth or error of this explanation might easily be tested by employing a floating body of a rectangular form: if it be correct, the tendency ought to be to bury itself in the fluid instead of rising out of it.

Mr. Mornay (page 123) appears to be of the opinion that in the motion of a body through

a fluid we have no reason to suppose that the head pressure is at all changed. That it is so, is clearly made out by the valuable experiments of the late Colonel Beaufoy, in which bodies of various mathematical forms are employed, and which distinctly point out the separate effects produced by altering the velocity, the figure of the head, and the figure of the stern. A volume of these experiments, elegantly executed, has recently been presented, in the most liberal and handsome manner, to his scientific countrymen, by Henry Beaufoy. At page xxxix of the Introduction, the different forces which act upon a body moving through a fluid are clearly defined as follows: ¹

“ By HEAD PRESSURE, is meant the total pressure which exists against the head end, or foremost part, of a body immersed, either wholly or in part, in any given fluid when such body is at rest.

“ By STERN PRESSURE, is meant the total pressure which exists against the stern end, or hindermost part of a body, immersed, either wholly or in part, in any given fluid when such body is at rest.

“ By PLUS PRESSURE, is meant the additional pressure which is sustained by the head end, or foremost part of a body, moved through a fluid; which additional pressure is over and above what we have termed the Head Pressure, and arises from the fluid being obliged to be displaced in order to permit the moving body to pass through it.

“ By MINUS PRESSURE, is meant a subtraction of pressure from the stern pressure, and which subtraction is occasioned by the fluid not pressing so strongly against the stern end, or hindermost parts of a body, when such body is in motion through the fluid, as when the body is at rest.

“ By FRICTION, (as relating to this subject,) is meant that sort of resistance to a body moved through a fluid, which arises either from the adhesion of the particles of the fluid to the surface of the moving body, or from the roughness of the body; or from both these causes united.

“ By TOTAL RESISTANCE, is meant the sum total of the plus pressure, the minus pressure and friction united.”

To complete the forces which act on the body we should introduce two other classes, viz., those which arise from the destruction of the equilibrium of pressure caused by the displacement and consequent unevenness of the fluid, and those which arise from the inclination of the axis of the moving body: these may probably account for many of the discrepancies observed in the results of the experiments.

Colonel Beaufoy's extensive experiments, taken in connexion with those of Macneill and Russell, supply various important data for the sciences of hydraulics and naval architecture. These subjects have, unfortunately, been but little cultivated by British mathematicians, notwithstanding their peculiar importance to this country; and we regret that time will not allow us to enter here into any discussion of what has already been done. We trust, however, that the theories of waves and naval architecture will shortly be taken up by some enterprising and able analyst, who may allow his attention to be drawn to such pursuits by their vast utility and importance.

¹ These definitions were drawn out by the late Earl Stanhope.

XI.—PRACTICAL RULES FOR CALCULATING THE STEAM ENGINE.

[The number inserted at the end of each rule refers to the page of the book where information respecting it is to be found.]

PROPERTIES OF STEAM.

THE additional heat required for the formation of steam may be estimated at 1000° Fahr., the heat of conversion from liquid to vapour.

1. To find the elastic force of steam when in contact with the liquid from which it is formed, the temperature being given.

Tredgold's Rule.

RULE I.—Add 100 to the temperature, in degrees, and from the logarithm of this sum subtract 2·24797; then multiply by 6, and the product will be the logarithm of the force in inches of mercury. (59.)

Example.—Let the proposed temperature be 250° Fahr.

Temperature	250	
Add	100	
	350	--- log. 2,54407 ¹
Subtract by the Rule		2,24797
		Difference 0,29610
Multiply by		6
		Log. 59·8 1,77660

The required force is therefore 59·8 inches of mercury.

Southern's Rule.

RULE II.—Add 51°·3 to the temperature, and multiply the logarithm of the sum by 5·13; from the product deduct 10·94123 and find the natural number answering to the remainder as a logarithm; this number increased by 0·1 will express the required pressure in inches of mercury. (58.)

¹ When the water is salt, refer to the last column of the table, page 61, for this logarithm.

Example.—Take the same as before.

Temperature	250
Add	51·3
	301·3
301·3 - - - log.	2·47900
Multiply by	5·13
	743700
	247900
	1239500
	12·7172700
	10·94123

Corresponding number 59·7 - - - 1·77604

To be increased by 0·1

Required force 59·8 inches of mercury.

This Rule appears to be preferable for high temperatures.

The force in inches of mercury may be reduced to lbs. on the square inch by dividing successively by 2, 6, and 9, and subtracting the third quotient from the first, thus :

2) 59·8 inches of mercury,

6) 29·9

9) 4·98

0·55

29·35 lbs. per square inch.

2. To find the volume or space the steam of a cubic foot of water occupies, when the steam is of a given elastic force and temperature, and separated from the liquid from which it is generated.

RULE.—To the temperature, in degrees, add 459 and multiply the sum by 76·5 ; divide the product by the force of the steam in inches of mercury, and the result will express the space in cubic feet which the steam of a cubic foot of water will occupy. (84.)

Example.—Let the force be 4 atmospheres, or 120 inches of mercury, and the temperature 295°.

Temperature	295
Add	459
	754
Multiply by	76·5
	3770
	4524
	5278
	57681·0

Force in inches of mercury 120) 57681·0 (481 cubic feet, the volume of the steam
from a cubic foot of water.

$$\begin{array}{r} 480 \\ \hline 968 \\ 960 \\ \hline 81 \end{array}$$

RULE II.—To the temperature, in degrees, add 459, and multiply the sum by 38; divide the product by the pressure in lbs. per square inch. (84).

Same Example.

$$\begin{array}{r} \text{Temperature } 295 \\ \text{Add } 459 \\ \hline 754 \\ \text{Multiply by } 38 \\ \hline \end{array}$$

$$\begin{array}{r} 6032 \\ 2262 \\ \hline \end{array}$$

lbs. per inch 59) 28652 (486 cubic feet.

$$\begin{array}{r} 236 \\ \hline 505 \\ 472 \\ \hline 332 \end{array}$$

BOILERS.

3. To find the dimensions of a boiler for a given power.

I. Rectangular or Watt's Boiler, when it has no internal flues.

RULE.—The bottom surface should be about 5 feet for each horse power. (124). Take the capacity of the boiler for water, and divide it by the quantity of bottom surface, and the quotient will be the depth of water.

Divide twice the capacity for water less the area of the bottom surface by the side surface for fire and flue, and the result will be one of the dimensions of the bottom. Divide the bottom surface by this dimension, and it gives the other. (125.)

Example.—To find the proportions of a boiler for an engine of 12 horse power, the capacity for water being 12·2 cubic feet for each horse power.

Horse power	12	Cubic feet per horse power	12·2
Table, page 124,	5	Horse power	12
Bottom surface	60	Capacity	146·4
Horse power	12	6,0) 14,6·4 capacity	
Table, page 124,	4·9		
Side surface	58·8 or 59.	2·44 depth of water.	

Double the capacity	292·8
Subtract bottom surface	60·0
Divide by side surface 59)	232·8 (4 feet, one of the dimensions
	236 of the bottom.

4) 60 (15 feet, the other dimension.

N.B. It cannot be of much importance that the dimensions should be in the proportion of 4 to 15, so long as the quantity of bottom surface is 60 square feet.

II. Cylindrical Boilers, with the fire applied externally.

RULE.—Let the capacity for water and for steam be added together, and also the quantities of fire surface ; then divide twice the capacity by the quantity of fire surface, and the result will be the diameter. (126.)

Also 1·27 times the capacity divided by the square of the diameter will give the length.

Example.—Required the dimensions of a cylindrical boiler for a 12 horse power, the whole capacity being 293 cubic feet.

Table, page 124, for	{	Bottom surface	5·0
		Side surface	4·9
			9·9
		Horse power	12
		Fire surface	118·8 or 119.
		Capacity	293
			2

Fire surface 119) 586 (5 feet, the diameter.

Capacity	293
	1·27
	2051
	586
	293

Square of diameter = 25) 372·11 (14·9 or 15 feet, the length.

	25
	122
	100
	221
	225

4. To find the requisite thickness for a rectangular or cylindrical boiler.

RULE.—Multiply the load in lbs. per square inch on the safety valve, by the greatest diagonal of the section of the boiler in inches, and divide the product by,

$\frac{150}{90}$ } times the cubic feet of boiler per horse power, for { wrought iron ;
 copper ;

the result will be the thickness of the upper plates in inches.

The bottom plates should be as much thicker as will compensate for wear ; usually twice the thickness of the top ones. (252.)

Example.—In a rectangular boiler, the greatest diagonal being 8 feet 2 inches = 98 inches, the load on the valve 6 lbs. per square inch, and the space for steam for each horse power 18 cubic feet ; required the thickness of the top plates, to be made of wrought iron.

18 cubic feet	98 inches	
150	6 lbs.	
<hr style="width: 50px; margin-left: auto; margin-right: 0;"/>		
900	27 00) 5 88	(0.218 of an inch for the top plates.
18	54	
<hr style="width: 50px; margin-left: auto; margin-right: 0;"/>		
2700	48	
	27	
	<hr style="width: 50px; margin-left: auto; margin-right: 0;"/>	
	210	

The bottom plates should be the double of 0.218 or 0.436 of an inch.

5. To find the requisite thickness of a spherical boiler.

RULE.—Multiply the diameter in inches by the pressure on the valve in lbs. per square inch, and divide by

$\frac{300}{180}$ } times the cubic feet of boiler per horse power, for { wrought iron ;
 copper ;

the result will be the thickness in inches. (252.)

Example.—A spherical wrought iron boiler, 18 feet 8 inches = 224 inches diameter, with 20 cubic feet to each horse power, and the load on the valve being 8 lbs. per square inch ; required its thickness.

20 cubic feet	224 inches
300	8 lbs.
<hr style="width: 50px; margin-left: auto; margin-right: 0;"/>	
6000	6 000) 1 792
	<hr style="width: 50px; margin-left: auto; margin-right: 0;"/>
	0.3 of an inch thickness.

6. To find the height of a column of water to supply a boiler against any proposed pressure of steam.

RULE.—Multiply the pressure in lbs. per square inch by 2.44, and the product will express the required height in feet. (141.)

Example.—Required the length of feed pipe capable of supplying a boiler when the pressure is 5 lbs. per square inch.

2.44
5
<hr style="width: 50px; margin-left: auto; margin-right: 0;"/>
12.20
12.2 or 12 feet 3 inches above the surface of the water in the boiler.

SAFETY VALVE.

7. To find the aperture of a safety valve, suited to any given pressure.

RULE.—Divide the area of the fire surface by the excess of the pressure above the atmosphere, expressed in lbs. per square inch, and the quotient will be the square of the diameter of the narrowest part of the valve in inches. (142.)

Example.—Required the aperture of a safety valve for a boiler with 60 feet of fire surface, the pressure being 5 lbs. per square inch above the pressure of the atmosphere.

The feet of fire surface (60) divided by the lbs. per square inch (5) gives 12 for the square of the diameter. Hence, by finding the square root, the diameter of the narrowest aperture of the valve should be 3.46, or about 3½ inches. The aperture should be made rather in excess than defect.

STEAM PASSAGES.

8. To find the diameter of the steam pipe.

RULE.—Multiply the length of the stroke in feet by the number of strokes per minute, and divide the product by 6; take the square root of the quotient, multiply it by the diameter of the cylinder, and then divide by 20. The result will be the diameter of the pipe in inches. (95.)

Example.—To find the diameter for the steam pipe of an engine, of which the diameter of the cylinder is 2 feet, the length of stroke 2.5 feet, and the number of strokes per minute 38.

Length of stroke	2.5
Number per minute	38
	<hr style="width: 50px; margin-left: auto;"/>
	200
	75
	<hr style="width: 50px; margin-left: auto;"/>
Divide by 6)	95.0
	<hr style="width: 50px; margin-left: auto;"/>
	16, nearly
Square root	4
Diameter cylinder	24 inches
	<hr style="width: 50px; margin-left: auto;"/>
Divide by 20)	96
	<hr style="width: 50px; margin-left: auto;"/>
	4.8 inches.

The diameter of the pipe should therefore be about 5 inches.

The same rule applies to the steam passages, and the passages to the condenser.

FIRE GRATING.

9. To find the area of the grating.

RULE.—Divide twice the square root of the height, in feet, from the bottom of the ash pit to the bottom of the chimney by the said height, and multiply the quotient by the number of horse power. The result will be the area of the grating expressed in square feet. (116.)

Example.—Let the height be 5 feet, and the number of horses' power 96.

Square root of 5 = 2.28

$$\begin{array}{r}
 2 \\
 \hline
 \text{Divide by 5) } 4.56 \\
 \hline
 0.91 \\
 \text{Horse power } 96 \\
 \hline
 546 \\
 819 \\
 \hline
 \end{array}$$

87.36 square feet for the grating.

CHIMNEY.

10. To find the area of a chimney for a steam engine.

RULE.—For engines of 10 horse power and upwards the area of the chimney, in square inches, should be 112 times the horse power divided by the square root of its height. (145.)

Example.—Required the area of a chimney for an engine of 40 horse power, the height being 70 feet.

$$\begin{array}{r}
 \text{Horse power } 40 \\
 112 \\
 \hline
 \text{Square root of 70} = 8.4 \text{) } 4480,0 \text{ (533 inches} \\
 420 \\
 \hline
 280 \\
 252 \\
 \hline
 280 \\
 252 \\
 \hline
 28
 \end{array}$$

The area should therefore be 533 square inches.

CYLINDER.

11. To find the requisite thickness of a working cylinder.

RULE.—To the diameter of the cylinder in inches add 2.5 ; multiply the sum by the total pressure of steam in lbs. per square inch in the boiler, and divide the product by 1900. The result will express the thickness for strength, and half an inch may be added for wear. (247).

Example.—A cast iron cylinder 24 inches diameter is to be made for steam not exceeding 5 lbs. per square inch on the safety valve ; required its thickness.

Diameter	24 inches	Safety valve	5 lbs.
Add	2.5 „	Atmosphere	14.7 „
	26.5	Total pressure	19.7 „
			26.5
			985
			1182
			394
			19 00) 5 22.05 (0.275 inches
			38 0.5 for wear
			142 0.775 inches, the re-
			133 quired thickness.
			90

PISTON ROD, &c.

12. To find the diameter of the piston rod, &c.

RULE.—Multiply the square root of the pressure of the steam per square inch in the boiler by the diameter of the cylinder in inches, and divide the product by

33 for cast iron,
36 „ wrought iron,
57 „ tempered steel;

and the quotient will be the diameter of the rod in inches, for a double-acting engine. For a single-acting engine one-half of the result will be sufficient. (241.)

Example.—The force of the steam being 20 lbs. per square inch, and the diameter of the cylinder 38 inches; required the diameter of the piston rod, the material being wrought iron.

$$\begin{array}{r}
 \text{Square root of } 20 \text{ --- } 4.47 \\
 \phantom{\text{Square root of } 20} \phantom{\text{ --- }} 38 \\
 \hline
 \phantom{\text{Square root of } 20} \phantom{\text{ --- }} 3576 \\
 \phantom{\text{Square root of } 20} \phantom{\text{ --- }} 1341 \\
 \hline
 36)169.86(4.7 \text{ inches diameter.} \\
 144 \\
 \hline
 258 \\
 252 \\
 \hline
 6
 \end{array}$$

Thus, for a double-acting engine the diameter should be about $4\frac{3}{4}$ inches; and for a single-acting engine $2\frac{3}{8}$ inches.

Parallel motion rods should be about half the diameter of the piston rod; and connecting rods should be about seven-tenths of the diameter of the piston rod. (242.)

THE CONICAL PENDULUM OR GOVERNOR.

The vertical distance between the point of suspension and the plane in which the balls revolve is the height of the governor.

13. To find the height for any proposed number of revolutions per minute.

RULE.—Divide the number 375 by twice the number of revolutions per minute, and the square of the quotient will be the required height of the governor in inches. (263.)

Example.—What ought to be the height of the governor so that the number of revolutions may be 42 per minute ?

$$\begin{array}{r}
 42 \\
 2 \\
 \hline
 84) 375 \text{ (4.46} \\
 \quad 336 \\
 \hline
 \quad 390 \\
 \quad 336 \\
 \hline
 \quad 540 \\
 \hline
 \end{array}
 \qquad
 \begin{array}{r}
 4.46 \\
 4.46 \\
 \hline
 2676 \\
 1784 \\
 \hline
 1784 \\
 \hline
 19.8916
 \end{array}$$

Height 19.9 inches.

14. The height being known, it is required to find the number of revolutions per minute.

RULE.—Divide 375 by twice the square root of the height in inches, and the quotient will be the number of revolutions per minute. (263.)

Example.—Take the same example and let the height be 19.9 inches, to find the revolutions per minute.

Square root of 19.90 = 4.46

$$\begin{array}{r}
 2 \\
 \hline
 8.92 \\
 8.92) 375.00 \text{ (42 revolutions per minute.} \\
 \quad 3568 \\
 \hline
 \quad 1820 \\
 \quad 1784 \\
 \hline
 \quad 36
 \end{array}$$

ECCENTRIC.

15. The length of the levers being given, to find the requisite throw of the eccentric.

RULE.—Multiply the length of the stroke of the valve by the length of the lever on the weight shaft for the eccentric rod, and divide the product by the length of the lever which works the valve, and the quotient will be the throw required.

$$2 e$$

Example.—The stroke of the valve is 5 inches, the lever for working it 10 inches, and the lever for the eccentric rod 8 inches; required the throw of the eccentric.

$$\begin{array}{r}
 \text{Stroke} \quad 5 \\
 \quad \quad \quad 8 \\
 \hline
 10) 40 \\
 \hline
 \quad \quad 4 \text{ inches throw.}
 \end{array}$$

The throw of the eccentric is the distance between the circumferences of the eccentric circle and the shaft, or it is the difference of their diameters.

For calculating the proportions in any other way it will only be necessary to make the throw of the eccentric and the eccentric lever, in the same proportion to each other as the stroke of the valve and the valve lever.

PUMPS.

16. To find the number of cubic feet in the volume of a given cylinder.

RULE.—Multiply the square of the diameter in inches by half the length in inches, or 6 times the length in feet; then, cutting off two figures from the right hand, divide the product by 11, and the result will express the required volume in cubic feet.

Example.—What is the volume of a cylinder whose diameter is 36 inches and length 32 inches?

$$\begin{array}{r}
 \text{Diameter} \quad 36 \text{ inches} \\
 \quad \quad \quad 36 \\
 \hline
 \quad \quad \quad 216 \\
 \quad \quad 108 \\
 \hline
 \text{Square of diameter} \quad 1296 \\
 \text{Half length} \quad 16 \text{ inches} \\
 \quad \quad \quad 7776 \\
 \quad \quad \quad 1296 \\
 \hline
 11) 207,36 \\
 \hline
 \text{Volume} \quad 18.85 \text{ cubic feet.}
 \end{array}$$

17. To find the power requisite to raise water to any proposed height.

RULE.—Multiply the square of the diameter of the pump, in inches, by the perpendicular height of the water in feet, and by the velocity also in feet per minute, and, cutting off three figures from the right hand, divide by 96. The result will express the number of horse power necessary to raise the water. (274.)

It is customary to increase the result by a $\frac{1}{3}$ th part, for friction and waste.

Example.—To find the power requisite to raise a column of water 16 inches diameter, 86 feet high, at the velocity of 128 feet per minute.

$$\begin{array}{r}
 \text{Diameter} \quad 16 \text{ inches} \\
 \quad \quad \quad 16 \\
 \quad \quad \quad \hline
 \quad \quad \quad 96 \\
 \quad \quad \quad 16 \\
 \quad \quad \quad \hline
 \quad \quad \quad 256 \\
 \text{Height} \quad 86 \text{ feet} \\
 \quad \quad \quad \hline
 \quad \quad \quad 1536 \\
 \quad \quad \quad 2048 \\
 \quad \quad \quad \hline
 \quad \quad \quad 22016 \\
 \text{Velocity} \quad 128 \text{ feet} \\
 \quad \quad \quad \hline
 \quad \quad \quad 176128 \\
 \quad \quad \quad 44032 \\
 \quad \quad \quad \hline
 \quad \quad \quad 22016 \\
 \quad \quad \quad \hline
 96) 2818|048 \quad (29\cdot35 \\
 \quad \quad \quad 192 \quad \quad 5\cdot87 \text{ one-fifth} \\
 \quad \quad \quad \hline
 \quad \quad \quad 898 \quad \quad 35\cdot2 \text{ horse power.} \\
 \quad \quad \quad 864 \\
 \quad \quad \quad \hline
 \quad \quad \quad 340 \\
 \quad \quad \quad 288 \\
 \quad \quad \quad \hline
 \quad \quad \quad 524
 \end{array}$$

The addition of one-fifth for friction and waste appears to be too much for large engines. We would recommend, as more preferable, to multiply by the velocity increased by 20 feet, and then to make no addition afterwards. The work, in the above example, would stand thus :

$$\begin{array}{r}
 22016 \\
 \quad 148 \\
 \quad \hline
 176128 \\
 88064 \\
 22016 \\
 \hline
 96) 3258|368 \quad (33\cdot94 \text{ or } 34 \text{ horse power.} \\
 \quad \quad 288 \\
 \quad \quad \hline
 \quad \quad 378 \\
 \quad \quad 288 \\
 \quad \quad \hline
 \quad \quad 903 \\
 \quad \quad 864 \\
 \quad \quad \hline
 \quad \quad 396
 \end{array}$$

18. To find the velocity necessary to discharge a given quantity of water.

RULE.—Multiply the number of cubic feet discharged per minute by 1100, and divide the product by 6 times the square of the pump's diameter in inches. The result will express the velocity of the discharge in feet per minute.

Example.—The diameter of the pump being 16 inches, and the discharge 179 cubic feet per minute, required the velocity.

16 inches	179 cubic feet	
16	1100	
—	—	
96	1536) 196900	(128 feet velocity
16	1536	per minute.
—	—	
256	4330	
6	3072	
—	—	
1536	12580	
	12288	
	—	
	292	

19. To find the diameter of the pump necessary to discharge a given quantity of water.

RULE.—Multiply the number of cubic feet to be discharged per minute by 1100, divide the product by 6 times the velocity in feet per minute, and the square root of the quotient will be the diameter of the pump in inches.

Example.—The velocity being 32 strokes per minute, the length of stroke 4 feet, and the discharge 179 cubic feet per minute, required the diameter of the pump.

32	179	
4	1100	
—	—	
128 feet per minute	768) 196900	(256; square root of 256 =
6	1536	16 inches, the re-
—	—	quired diameter.
768	4330	
	3840	
	—	
	4900	

PARALLEL MOTION.

20. The lengths of the beam, radius bar, and link, as in Fig. 4, Plate x. (B) being given, together with the length of the stroke, to find the point E in the link where the piston rod must be attached.

RULE.—Divide the lengths of the beam and radius bar, measured from their centres of motion, by half the length of the stroke. From the square of each of the two quotients subtract *unity*; find the square roots of the remainders, and subtract them respectively from the preceding quotients. The numbers so deduced will express the relative proportion between the segments of the link; and if we multiply each of them by the length of the link

and divide the product by the sum of the two numbers, we shall get the respective distances of the required point from the beam and radius bar. (231.)

Example.—The radius of the beam is 7 feet, the length of the radius bar 4 feet, the link 2 feet, and the length of the stroke 5 feet; required the point of connexion of the piston rod.

Half length of stroke = 2.5 feet.		
2.5) 7.0 (2.8	2.5) 4.0 (1.6	
5.0	25	
<hr style="width: 50px; margin-left: 0;"/>	<hr style="width: 50px; margin-left: 0;"/>	
200	150	
200	150	
<hr style="width: 50px; margin-left: 0;"/>	<hr style="width: 50px; margin-left: 0;"/>	
Quotients 2.8	1.6	
2.8	1.6	
<hr style="width: 50px; margin-left: 0;"/>	<hr style="width: 50px; margin-left: 0;"/>	
224	96	
56	16	
<hr style="width: 50px; margin-left: 0;"/>	<hr style="width: 50px; margin-left: 0;"/>	
Squares 7.84	2.56	
Subtract 1	1	
<hr style="width: 50px; margin-left: 0;"/>	<hr style="width: 50px; margin-left: 0;"/>	
6.84	1.56	
<hr style="width: 50px; margin-left: 0;"/>	<hr style="width: 50px; margin-left: 0;"/>	
Square roots 2.6153	1.2490	Numbers { .1847
<hr style="width: 50px; margin-left: 0;"/>	<hr style="width: 50px; margin-left: 0;"/>	.3510
Subtracted from quotients .1847	.3510	<hr style="width: 50px; margin-left: 0;"/>
		Sum .5357
	.1847	
	Link 2	
	<hr style="width: 50px; margin-left: 0;"/>	
	.5357) .3694,0 (0.69	
	3214 2	
	<hr style="width: 50px; margin-left: 0;"/>	
	47980	
	.3510	
	Link 2	
	<hr style="width: 50px; margin-left: 0;"/>	
	.5357) 7020 (1.31	
	5357	
	<hr style="width: 50px; margin-left: 0;"/>	
	16630	
	16071	
	<hr style="width: 50px; margin-left: 0;"/>	
	5590	

The distance of the required point from the end of the beam is therefore 0.69 feet or 8.28 inches, and the distance from the end of the radius bar is 1.31 feet or 1 foot 3.72 inches.

N.B. As a check against any gross blunder, the distances multiplied by the respective lengths of the beam and radius bar ought to give nearly equal results. In the present case

they give 4·83 and 5·24. For short strokes, however; they ought to come much nearer.

21. To find the length of the radius bar.

I. When the radius bar and piston rod are attached to the links at the same distance from the beam.

RULE.—First, From the radius of the beam, divided by twice the length of the parallel bar, subtract *unity*.

Secondly, Find the square root of the difference between the square of the radius of the beam, and the square of the half length of the stroke, and add this root to the radius of the beam.

Thirdly, Multiply together the numbers so found, and the product added to the length of the parallel bar will give the length of the radius bar. (235.)

Example.—Let the radius of the beam be 11 feet, the length of stroke 5, and the length of the parallel bar 4 feet.

First operation.

Parallel bar	4 feet	8) 11	
	2	—	
	—		1·375
	8	Subtract 1	
		—	
			·375 ¹

Second operation.

Stroke	5 feet	Beam	11 feet	
	—		11	
Half	2·5		—	
	2·5		121	
	—			
	125			
	50			
	—			
	6·25	- - - - -	6·25	
			—	
			114·75	
			—	
		Square root	10·71	
		Beam	11	
			—	
			21·71	

¹ This difference may sometimes be negative; in that case the final product must be subtracted from the length of the parallel bar (see next Example).

Third operation.	21·71
	·375
	<hr style="width: 50px; margin: 0 auto;"/>
	10855
	15197
	6513
	<hr style="width: 50px; margin: 0 auto;"/>
	8·14125

Parallel bar 4

Radius bar 12·14 feet.

II. When the radius bar and piston rod are attached to the links at different distances from the beam.

RULE.—Multiply the radius of the beam by the distance of the radius bar, and divide the product by the distance of the piston rod or cross head, for the prepared length of the beam.

Also, multiply the length of the stroke by the distance of the radius bar, and divide the product by the distance of the piston rod, for the prepared length of stroke.

And to the length of the parallel bar add the prepared length of the beam, and subtract its true length, for the prepared length of the parallel bar.

The values thus deduced will then be the lengths of the beam, stroke, and parallel bar, prepared for the calculation of the length of the radius, according to Rule I. (236.)

Example.—Let the radius of the beam be 64 inches, the parallel bar 50 inches, the stroke 42 inches, the radius bar connected 68 inches from the beam, and the piston rod connected 84 inches from the beam.

Beam 64	Stroke 42
68	68
<hr style="width: 50px; margin: 0 auto;"/>	<hr style="width: 50px; margin: 0 auto;"/>
512	336
384	252
<hr style="width: 50px; margin: 0 auto;"/>	<hr style="width: 50px; margin: 0 auto;"/>
84) 4352 (51·81,	84) 2856 (34, prepared stroke.
420 prepared beam	252
<hr style="width: 50px; margin: 0 auto;"/>	<hr style="width: 50px; margin: 0 auto;"/>
152	336
84	336
<hr style="width: 50px; margin: 0 auto;"/>	<hr style="width: 50px; margin: 0 auto;"/>
680	*
672	
<hr style="width: 50px; margin: 0 auto;"/>	
80	51·81
Parallel bar	50·00
	<hr style="width: 50px; margin: 0 auto;"/>
	101·81
Beam	64·00
	<hr style="width: 50px; margin: 0 auto;"/>
	37·81 prepared parallel bar.
	2
	<hr style="width: 50px; margin: 0 auto;"/>
	75·62

APPENDIX.

	75·62)	51·810	(0·6851	Beam 51·81	Half stroke 17
		<u>45 372</u>	<u>1·0000</u>	<u>51·81</u>	<u>17</u>
		64380	—·3149	5181	119
		<u>60496</u>		<u>41448</u>	<u>17</u>
		38840		5181	
		<u>37810</u>		<u>25905</u>	<u>289</u>
		10300		<u>2684·2761</u>	
				289·	
				<u>2395·2761</u>	(48·94
				16	<u>51·81 beam</u>
				<u>88 795</u>	<u>100·75</u>
				704	
				<u>969 9127</u>	
				8721	
				<u>9784 40661</u>	
				100·75	
				<u>—·31 49</u>	
				90675	
				40300	
				10075	
				<u>30225</u>	
				<u>—31·726175</u>	
				Parallel bar <u>37·81</u>	
				Radius bar 6·08 inches.	

22. To find the lengths of the parallel bar and radius bar, when the latter works from a stated centre, as is generally the case for marine engines.

RULE.—Prepare the lengths of the beam and stroke as directed in the last rule, and then proceed as follows :

From the square of the radius of the beam subtract the square of half the length of stroke, and take the square root of the remainder.

To this square root add the horizontal distance between the centres of the beam and radius bar ; to the same root add the radius of the beam.

Multiply the latter of these into half the radius of the beam, and divide by the former ; then the quotient subtracted from the radius of the beam will give the distance of the connecting bar from the centre of the beam.

By subtracting this distance from the true radius of the beam, we get the length of the

parallel bar; and by subtracting it from the horizontal distance of the centres we get the length of the radius rod. (233.)

Example.—Taking the same case as that of the preceding rule, we shall have the radius of the beam 64 inches, the length of stroke 42 inches, the radius rod connected 68 inches from the beam, the piston rod connected 84 inches from the beam, and the horizontal distance between the centres of the radius bar and beam 20·08 inches, to find the suitable lengths of the parallel bar and radius bar.

Beam 64	Stroke 42
68	68
—	—
512	336
384	252
—	—
84) 4352 (51·81, prepared beam	84) 2856 (34, prepared stroke.
420	252
—	—
152	336
84	336
—	—
680	*
672	
—	
80	
Beam 51·81	Half stroke 17
51·81	17
—	—
51 81	119
4144 8	17
5181	—
25905	289
—	
2684·2761	
289	
—	
2395·2761 (48·94 - - - - 48·94	Beam 51·81
16 Hor. dist. } 20·08	100·75
centres } —	—
88 795	Half beam 25·9
704	69·02
—	—
969 9127	90675
8721	50375
—	—
9784 40661	20150
	—
	2609·425

69.02) 2609.425 (37.81

20706

53882

48314

55685

55216

4690

Beam	51.81
Subtract	37.81

 14.00 connecting bar from centre of beam.

True radius of beam 64 Hor. dist. of centres 20.08

14

14

Parallel bar 50 inches. Radius bar 6.08 inches.

These results exactly correspond with the original data.

Note 1. For marine engines, the distance from the beam at which the radius bar is connected, is the perpendicular height of the centre of the radius bar above the axis of the beam when horizontal; and the distance at which the piston rod is connected is the perpendicular height of the cross head above the axis of the beam at half stroke, and may be found by taking the height of the lowest position of the cross head, and increasing it by half the length of the stroke.

Also, the length of the connecting rod which works the crank is the perpendicular distance between the centre of the shaft and the centre of the beam.

Note 2. Calculations of parallel motions will be rather more accurate if the length of stroke be diminished by its one-sixth part, before it is used; and in fitting them they should be adjusted at one-sixth of the half stroke from each end, instead of the top and bottom of the stroke.

PRESSURE ON THE PISTON.

23. To find the mean pressure of the steam on the piston when it is worked expansively.

RULE.—Divide the length of the stroke by the distance the piston moves before the steam is shut off, and the quotient will express the relative expansion it undergoes. With this number take out the multiplier from the annexed table, and multiply it into the full pressure per square inch of the steam on entering the cylinder. The product will be the mean pressure per inch, or that pressure which, continued uniformly throughout the whole length of the stroke, would produce the same effect. (155.)

MULTIPLIER for MEAN PRESSURE of Steam worked EXPANSIVELY.

Relative Expansion.	Multiplier.	Relative Expansion.	Multiplier.	Relative Expansion.	Multiplier.	Relative Expansion.	Multiplier.
1·000	1·0000 43	2·000	0·8466 171	3·000	0·6995 120	4·000	0·5966 86
1·100	0·9957 104	2·100	·8295 166	3·100	·6875 115	4·100	·5880 82
1·200	·9853 143	2·200	·8129 160	3·200	·6760 112	4·200	·5798 80
1·300	·9710 164	2·300	·7969 155	3·300	·6648 108	4·300	·5718 78
1·400	·9546 176	2·400	·7814 149	3·400	·6540 104	4·400	·5640 76
1·500	·9370 182	2·500	·7665 144	3·500	·6436 100	4·500	·5564 73
1·600	·9188 184	2·600	·7521 139	3·600	·6336 97	4·600	·5491 71
1·700	·9004 183	2·700	·7382 133	3·700	·6239 94	4·700	·5420 69
1·800	·8821 180	2·800	·7249 129	3·800	·6145 91	4·800	·5351 67
1·900	·8641 175	2·900	·7120 125	3·900	·6054 88	4·900	·5284 65
2·000	0·8466 175	3·000	0·6995 125	4·000	0·5966 88	5·000	0·5219 65

Example.—Suppose the steam to enter the cylinders at a pressure of 50 lbs. on the square inch, and to be shut off after the piston has moved 16 inches; and let the length of stroke be 4 feet 6 inches or 54 inches.

16) 54 (3·375, relative expansion.

48
—
60
48
—
120
112
—
80
80

The relative expansion falls between 3·3 and 3·4. Referring to the table, the multiplier for 3·3 is 0·6648; and in passing to 3·4 we see that it decreases by the printed difference 108. Hence, multiplying 108 by ·75 and subtracting the product 81 from 0·6648, the remainder 0·6567 is the multiplier answering to 3·375. Therefore, multiply 0·6567 by 50 lbs. and we have 32·83 lbs. per square inch, the mean pressure required.

In practice a small extra portion of steam will occupy the clearance of the cylinder. The power of this portion is obviously lost at the beginning of the stroke, but when the steam is shut off, it will evidently afford some slight assistance in the expansion, since a greater volume of steam must lose less pressure in expanding through the same distance. The additional aid thus derived is, however, extremely small in respect of the portion of steam expended; and as the quantity of clearance is generally very small (the smaller the better) the effect of it is disregarded in the above rule. It would be of little avail to include the effect of the clearance of the cylinder, when the influence of other causes, such as friction, waste, &c., which vary in different engines, can be but imperfectly estimated. In cases, if there be any, where the accuracy of information on these points is such as to be relied upon, the following rule may be adopted.

RULE.—To the distance moved by the piston before the steam is cut off, and to the actual

length of the stroke of the piston, add the length of the clearance, and call the sums the increased distance and the increased stroke. Divide the increased stroke by the increased distance, and the quotient will express the true relative expansion of the steam. With this number take out the multiplier from the table, and multiply it into the increased stroke; the product will represent the entire effort of the steam. From this subtract the length of clearance, and the remainder will be the actual effort. Lastly, multiply the actual effort by the full pressure per square inch in the cylinder, and divide the product by the actual length of stroke, and the result will be the mean pressure of the steam exercised upon each square inch of the piston.

The latter part of the rule may be more simply performed thus: having taken out the multiplier, subtract it from 1·0000, multiply the remainder by the length of the clearance, and divide the product by the true length of stroke. Subtract the quotient from the multiplier, and the remainder will be the corrected multiplier, to be multiplied into the full pressure to get the mean pressure.

Example.—Take the preceding example, and suppose the clearance of the cylinder to be one inch at each end.

Distance	16 inches	Stroke	54 inches
Clearance	1 „	Clearance	1 „
	17		55

17) 55 (3·235, relative expansion

51
—
40
34
—
60
51
—
90

With 3·235 we find multiplier, from table, 0·6721.

	1·0000		
	0·6721	- - - - -	0·6721
	0·3279		
Clearance	1		
	3279		
Stroke 54)	·3279 (61	- - - Subtract	61
	324		0·6660
	39	Pressure	50 lbs.

Mean pressure 33·300 lbs. per square inch.

The former rule, which supposes no clearance, gave 32·83. It hence appears that the additional $\frac{1}{10}$ th of the quantity of steam used only increases the mean pressure by 0·47, or about $\frac{1}{2}$ lb. on each square inch.

The preceding rules determine the mean pressure, which is equivalent to the entire action of the steam. To get the *mean effective pressure* it must be diminished by an estimated amount of the resistance and friction of the parts of the engine; and for condensing engines an addition of about 13 lbs. per square inch must be added as the pressure acquired by the partial vacuum.

POWER.

24. To find the power of an engine.

RULE.—Multiply double the length of stroke by the number of strokes per minute, and we get the velocity of the piston per minute.

If the engine works expansively, find the mean effective pressure by the foregoing rules.

Multiply the square of the cylinder's diameter in inches by the mean effective pressure on the piston in lbs. per square inch, and by the velocity of the piston; point off three figures and divide the product by 42, and the quotient will express the number of horses' power. (197.)

Example.—Let the diameter of the cylinder be 36 inches, the length of stroke 4 feet, the number of strokes per minute 24, and the mean effective pressure on the piston 4 lbs. per square inch.

$$\begin{array}{r}
 8 \text{ feet} \times 24 = 192 \text{ feet per minute} \\
 \text{Diameter } 36 \text{ inches} \\
 \quad 36 \\
 \quad \text{---} \\
 \quad 216 \\
 \quad 108 \\
 \quad \text{---} \\
 \quad 1296 \\
 \text{Mean pressure } 4 \text{ lbs.} \\
 \quad \text{---} \\
 \quad 5184 \\
 \text{Velocity } 192 \text{ feet} \\
 \quad \text{---} \\
 \quad 10368 \\
 \quad 46656 \\
 \quad 5184 \\
 \quad \text{---} \\
 42) 995328 \text{ (23.7 horse power.)} \\
 \quad 84 \\
 \quad \text{---} \\
 \quad 155 \\
 \quad 126 \\
 \quad \text{---} \\
 \quad 293
 \end{array}$$

25. To find the quantity of water required for steam.

RULE.—Find the volume of steam from a cubic foot of water by rule No. 2.

Multiply the square of the diameter of the cylinder in inches by half the velocity of the piston in inches, or six times the velocity in feet per minute; cut off two figures from the right hand, divide by 11, and the quotient will express the cubic feet of steam effectively

expended per minute. Divide this by the volume from a cubic foot of water, and we get the cubic feet of water required per minute.

Example.—Let the diameter of the cylinder be 30 inches, the velocity of the piston 120 feet per minute, the temperature of the steam 250° , and its elastic force 29 lbs. on the square inch.

$$\begin{array}{r}
 250^{\circ} \\
 \text{Add } 459 \\
 \hline
 709 \\
 \text{Multiply by } 38 \\
 \hline
 5672 \\
 2127 \\
 \hline
 \text{Elastic force } 29) 26942 \text{ (929 cubic feet of steam} \\
 261 \quad \text{from 1 cubic foot of} \\
 \hline
 84 \quad \text{water.} \\
 58 \\
 \hline
 262
 \end{array}$$

$$\begin{array}{r}
 \text{Diameter } 30 \text{ inches} \\
 30 \\
 \hline
 900 \\
 6 \times 120 = 720 \\
 \hline
 \text{Divide by } 11) 6480'00 \\
 589 \text{ cubic feet of steam per minute.} \\
 929) 589'0 \text{ (0.634 cubic foot of water} \\
 5574 \quad \text{required per minute.} \\
 \hline
 3160 \\
 2787 \\
 \hline
 3730
 \end{array}$$

Some addition should be made to the result for clearance of the cylinder, escape through the valves, and waste.

The quantity of water required serves to determine the dimensions of the hot water pump. About 12 times the quantity is necessary for condensation.

LOCOMOTIVE ENGINES.

26. To find the effective force of gravity when an engine and train are running upon an inclined plane.

RULE.—Multiply the gross load in tons by 2240 and divide the product by the length of

the plane corresponding to an ascent or descent of *unity*. The quotient will be the force in lbs. acting down the plane.

Example.—Let the engine be 12 tons, the tender 7 tons, and the carriages and load 105 tons; and suppose the inclination of the railway to be 1 in 128.

Engine	12	tons.	
Tender	7	„	
Train	105	„	
Gross load	124	„	
Multiply by	2240		
			4960
			248
			248
			277760
			(2170 lbs., the force required.
			256
			217
			128
			896
			896
			*

27. To find the tension on the circumference of the driving wheels, or the resistance to traction.

RULE.—Multiply the gross load, expressed in tons, by 8, and the product will be the number of lbs. resistance if the engine and train move horizontally: for *ascending* an inclined plane the effect of gravity, calculated by the last rule, must be *added*; and for *descending* an inclined plane the effect of gravity must be *subtracted*.

Example.—Take the same case as before.

Engine	12	tons.	
Tender	7	„	
Train	105	„	
			124
			8
			992

992 lbs. traction on a horizontal line of railway.

If the engine and train be ascending an incline of 1 in 128, we have by the example of last rule,

Effect of gravity	2170	lbs.	
Add	992	„	
			3162

3162 lbs. traction up the plane.

28. To find the pressure of the steam in the cylinder.

RULE.—Determine the resistance to traction by the last rule; add to it an eighth part for the additional friction it causes on the engine, and 6 lbs. per ton of the weight of the engine for its own separate friction. The sum will express the whole force or resistance to be overcome by the engine. Multiply this resistance at the circumference of the wheel by its diameter in inches, and then divide by the product of the square of the diameter of the cylinder into the length of the stroke. The quotient will express the effective pressure on the piston in lbs. per square inch; and, adding 14·7 lbs. for the pressure of the atmosphere, the result will be the pressure of the steam in lbs. per square inch.

Example 1.—The weight of the engine is 12 tons, the tender 7 tons, the train 50 tons, the diameter of the driving wheels 54 inches, the diameter of the cylinder 12 inches, and the length of the stroke 18 inches. It is required to find the pressure of steam in the cylinder to sustain an uniform velocity up an incline of 1 in 140.

	Engine	12 tons.	Gross load	69	
	Tender	7 „		2240	
	Train	50 „		20160	
	Gross load	69 „		13440	
		8		140	154560 (1104 lbs. effect of gravity.
	Horizontal traction	552 lbs.		145	
				140	
				560	
				560	
				*	
		Gravity	1104 lbs.		
		Horizontal traction	552 „		
		Inclined traction	1656 „	up the plane.	
		Additional friction	207 „	one-eighth.	
		Engine	72		
Diameter } 12		Resistance	1935		
cylinder } 12		Wheel	54		
			7740		
Stroke 18			9675		
			1152	2592) 104490 (40·3 lbs. effective pressure.
			144		14·7 „ atmospheric „
Divisor 2592			8100		55·0 lbs. pressure of steam per square
			7776		inch.
			324		

The consumption of water may hence be calculated by No. 25.

. The two preceding rules are founded on the Chev. de Pambour's estimation of the resistances experienced by locomotive engines, stated at the foot of page 185; which are, doubtless, good approximations to the truth with the usual proportions and velocities of locomotives; but it should be observed, that in the determination of these resistances, the experimental data are all necessarily affected by the resistance of the atmosphere, which varies nearly as the square of the velocity. It is evident that the results must involve an average value of the atmospheric resistance for the experiments adopted, and that no material correction will therefore be required, on account of the atmosphere, with ordinary velocities, though some additional resistance should be added for very high velocities. It may also be a question whether the resistance of the carriages, &c., would at all be affected by altering the diameters of the running wheels.

29. To determine the power of a locomotive engine.

RULE.—Find the effective pressure on the piston by the last rule, and thence the power by the rule of No. 24.

The following method, however, will be found to be more convenient and useful in practice.

Calculate the resistance by the last rule; multiply by 8 times the velocity in miles per hour; point off 3 figures from the right hand, and divide by 3. The result will express the number of horses' power.

Example.—Take the last case, and suppose the velocity to be 12 miles an hour.

The resistance has already been calculated, 1935 lbs.

$$\begin{array}{r}
 \text{Resistance} \quad 1935 \text{ lbs.} \\
 8 \text{ times speed} \quad 96 \text{ miles.} \\
 \hline
 11610 \\
 17415 \\
 \hline
 3) 185760 \\
 \hline
 61.92 \text{ horse power.}
 \end{array}$$

30. The power of a locomotive engine being known, it is required to determine the speed under any given circumstances of load, inclination of railway, &c.

RULE.—Find the whole resistance in lbs. overcome, by the rule of No. 28; multiply the number of horses' power by 375, and the product will be a constant number to be divided by the resistance to obtain the velocity in miles per hour.

Example.—Taking the same case as before, we have,

$$\begin{array}{r}
 \text{Horse power} \quad 61.92 \\
 375 \\
 \hline
 30960 \\
 43344 \\
 18576 \\
 \hline
 \text{Constant number} \quad 23220.00 \\
 2g
 \end{array}$$

APPENDIX.

Resistance 1935) 23220 (12 miles per hour in ascending the plane.
1935

3870

3870

*

For the velocity when the railway is horizontal, we have,

Horizontal traction 552 lbs.

Additional friction 69 „

Engine „ 72 „

Resistance 693) 23220 (33.5 miles per hour.

2079

2430

2079

351

The force arising from gravity being greater than the horizontal traction, in this example, the carriages would of themselves run down the inclined plane with an accelerated velocity; and this would be the case on all inclinations greater than 1 in 280.

Example 2.—To find the greatest uniform velocity of the same engine and train *down* an inclination of 1 in 600.

Engine 12 tons.

Gross load 69

Tender 7 „

2240

Train 50 „

20160

Gross load 69 „

13440

8

6,00) 1545,60

Horizontal traction 552 lbs.

257.6 lbs. effect of gravity.

Horizontal traction 552.0 lbs.

Gravity 257.6 „

Inclined traction 294.4 „ down the plane.

Additional friction 36.8 „ one-eighth.

Engine 72.0 „

Resistance 403.2 „

403.2) 23220.0 (57.6 miles per hour.

20160

30600

28224

2376

The velocity would, therefore, be about $57\frac{1}{2}$ miles per hour; but this is sure to be in excess, since at such high velocities the resistance offered by the atmosphere must be very considerable.

For any particular engine the constant number, which forms the dividend, when once prepared, will be ready for general application.

In the calculation of the average speed, the distances traversed, or the times of transit, due allowances should be made for the intervals spent in the generation of motion. Nearly one-half of the time elapsed, or one-half of the distances passed over, in the gradual production and annihilation of the velocities, may be considered as lost.

FORMULÆ for calculating the effects of the SCREW PROPELLER, when applied to steam vessels.

r = the radius of the screw in feet.

h = the pitch, also in feet.

$$\pi = 3.14159 \quad \log. \pi = 0.49715.$$

$$c = \frac{w}{2g} \cdot \frac{\pi}{550} \quad \log. c = 7.75506.$$

$$k = \frac{h}{2\pi} \quad \log. 2\pi = 0.79818.$$

v = the velocity of the vessel in feet per second, or the velocity in miles per hour multiplied into $\frac{2}{3}$.

u = the velocity of a point in the screw at the distance k from the axis.

S = the effective resisting surface of the vessel.

$$A = k^2 \left\{ \frac{r^2}{k^2} - \text{hyp. log.} \left(1 + \frac{r^2}{k^2} \right) \right\}.$$

$$u = v \left(1 + \sqrt{\frac{S}{\pi A}} \right).$$

$$\text{Number of revolutions per second} = \frac{u}{h}.$$

$$\text{Horse power of engine} = c A (u - v)^2. u$$

$$\text{Horse power effective} = c A (u - v)^2. v$$

In the absence of better information, the value of S may be roughly estimated at about one-fifth or one-sixth of (tonnage) $^{\frac{2}{3}}$, according to the construction of the vessel.

The larger the diameter and the less the pitch of the screw, the greater will be the proportion of effective power on the vessel.

ERRATA, &c.

Page 155 line 3 from bottom, omit = at the end.

„ 158 Tredgold has made use of the moment of the pressure of the steam instead of the actual pressure on the parts.

The force at the distance x from E is $f y d x$, which multiplied into $2 \pi (r + x)$, the space described, gives $2 f \pi y d x (r + x)$; and the integral is $f \pi a y (2 r + a)$, the power expended on each revolution. It is hence plain that no power is lost, the factor $\pi a y (2 r + a)$ being the volume of steam employed at the pressure f .

„ 164 }
„ 166 } Arts. 333, 342, foot-notes and other parts depending on the same, are incorrect in principle.

The greatest effect is generally produced with the least velocity; the effect being the effective force multiplied into the space through which it is exerted.

„ 263 line 11 from bottom, for *second* read *minute*.

„ 393 lines 4 and 5 from bottom, transpose LXII. and LXIII.

APPENDIX.

Page 128 at the bottom on the left, for $r a^3 \sin. \beta$ read $2 r a^3 \sin. \beta$.

Plate x1. The adjustment of the parallel motion is wrong; the same radius bar will not do for both ends of the beam. In the plate, the motions for the cylinders and air pump are correct; but the pump rods on the left cannot move in straight lines with such an arrangement.

We are indebted to Professor Willis, of Cambridge, for a notice of this error.

INDEX.

A.	PAGE	B.	PAGE
'ABORTION of the Young Steam Engineer's Guide'	43	Banks, John	33
Achard	30	Baldock, Lieut., his form of steam journal	<i>App.</i> 31—39
Agricultural purposes, engines for	282	———'s memoir of H. M. steam ship the Medea	<i>App.</i> 80—100
Air	86	Barlow, P., of the Royal Military Academy, his reports of experiments on steam vessels	<i>App.</i> 63, 64
— and steam mixed	84, 86	Barlow, P. W., on steam vessels	<i>App.</i> 40
— engine	8	Barton's piston	219
— motion of	87	——— stuffing boxes	222
— pump	24, 25, 86, 167, 170, 190	Beale, J., his rotary engine (<i>Plates</i> 71, 72)	401
——— proportion of	167—170	Beam, working	10, 20
——— power required to work	170—172	——— angular movement of limited	241
——— rods	242	——— strength of	242
— for fires	119, 120	Beauty essential to perfect engines	202
— flues	134	Beighton, Henry	12
— regulator	138	Belidor, Bernard	15, 210, 211, 215
Alcohol vapour, force of	30, 32, 39, 72	Bell, Henry	44, 45
——— engine	34	—— steam navigation in Britain successfully introduced by	45
——— latent heat of	53, 55	Berenice, Hon. East India Company's vessel (<i>Plates</i> 70 A, 70·B, 95, 96)	400, 471
——— effect as fuel	109	Bettancourt	32, 63, 211
Ammonia	55, 79, 82	Bevan, B., experiment by	294
Amonton's engine	8, 16	Black, Dr. Joseph	21, 49
Apparatus for boilers	135	——'s definition of latent heat	21, 48
Arsberger's, Professor, experiments on high pressure steam	71, 72	——— capacity for heat	21
Ash pit	115	Blake, Francis	18
Atlantic steam navigation	<i>App.</i> 101	Blakey, John	24, 128
——— remarks on	<i>App.</i> 24	Blowing through	199
Atmosphere, pressure of	80, 89	——— machines	281
Atmospheric engine 9, 10, 23, 24, 36, 96, 149, 185	33, 34, 36	Boats, steam	14, 31, 313, 316
——— effect of	33, 34, 36	—— steam engines for	312, 313
——— improved	40, 189	—— canal	294
——— piston	216		
Austen, Capt. Horatio	<i>App.</i> 82		
Ayre's, Richard, contrivance for preventing engines from running off a railway	403		

	PAGE		PAGE
Boiler with internal flue	21, 22	Boilers, marine, water ways of	<i>App.</i> 20
—— tube	25	—— flues of	<i>App.</i> 21
Boilers, cast iron	253	—— detector pipe for	<i>App.</i> 21
—— formed of plates	251, <i>App.</i> 8	—— glass water gauges and cop- per floats for	<i>App.</i> 22
—— copper	<i>App.</i> 4	—— reverse valves for	<i>App.</i> 22
—— construction of copper	<i>App.</i> 10	Boiling point of solutions	60
—— of the African steam vessel of war, description of (<i>Plate</i> 22)	355	Bossut	32, 291
—— of the Medea steam vessel of war, description of (<i>Plate</i> 23)	<i>ibid</i>	Boulton	29
—— surface for fire	116	Boulton and Watt	24, 163, 170, 192, 195, 208, 218
—— space for steam and water in	120, 122	Bramah, Joseph	32, 40, 215, 222
—— power of low pressure	123	Bramah and Dickinson's rotary engine	32
—— number of	124	—— 's slide valve	207
—— form of	<i>ibid</i>	—— 's four-way cock	212
—— Watt's	125	Brindley	21
—— strength of	249, 251, 252	Brunel	81
—— size of	126, 133	Brunton's fire place	134
—— cylindrical	126, 260	Bucket, air pump	205
—— rules for	125, 126	Bury, Edward, of Liverpool (<i>Plates of the Tiger's marine engines</i> 111, and 111 A)	497
—— spherical	253	C.	
—— tubular	254	Cagniard de la Tour, experiments by	71, 73, 75, 78
—— Rumford's	128	Canal, Table I. of experiments made on the Forth and Clyde	<i>App.</i> 201
—— Woolf's	129	—— Table II. Monkland	<i>ibid</i>
—— with internal fires	130	Canal boats	294
—— steam carriage	130, 132	Carbon, effect as fuel	107
—— supply	130, 135, 136, 143	Carbonic acid	80, 81
—— steam boat	131	Carburet of sulphur	77
—— high pressure	136	Carriage, steam (<i>Plate</i> 20)	42, 119, 120, 132, 284, 403, 407
—— portable	132	Cartwright, Dr. Edmund	34, 218, 223
—— apparatus for	135	—— 's engines	35
—— supply of with water	135, 136	—— 's piston	34, 35, 218
—— practical rules for	<i>App.</i> 207	Cataract	23, 265
—— marine	<i>App.</i> 1	Cements	254
—— uses of roman cement for <i>App.</i> 5, 11		—— iron	<i>ibid</i>
—— coating for	<i>App.</i> 16	Centre of pressure of a paddle	<i>App.</i> 44
—— incrustation of not greater in a voyage to the Mediterranean, than on any other voyage of similar duration <i>App.</i> 3		—— investigation	<i>App.</i> 45
—— circulating pipes and dampers for	<i>App.</i> 13	Charcoal, effect of	107
—— brine pump for	<i>App.</i> 2, 3	Chase water engine	23, 188, 216
—— Maudslay and Field's, expe- riments on	<i>App.</i> 2	Chelsea water-works engine (<i>Plates</i> 84, 85, 86, 87, 88)	404
—— blowing-off cocks	<i>App.</i> 6		
—— Kingston's safety valve for <i>App.</i> 7			

	PAGE		PAGE
Chimney, ascent of smoke in	100	Cotton mills	282
——— areas	145	Counter	270
——— tops	146	Counter weight	10, 194, 256, 260
——— practical rule for	<i>App.</i> 211	Crampton, T., his drawings of Hague's slides (<i>Plate 69</i>)	
Christian, experiments by	72	Crank	27, 228
Clack valve	204, 205	—— strength of	243
Clement, M.	71	—— table of the variation of rotary force of	230
Clinkers	133, 134	—— action of	<i>App.</i> 173
Coal, effect of	17, 112, 113	—— expression for effective leverage of	<i>App.</i> 175
—— engines for drawing	279	—— expressions for angular velocity of for one engine	<i>App.</i> 177
Cock, four-way, to cut off steam at any portion of the stroke	13, 40, 211, 212	—— expression for deviation from mean value of angular velocity	<i>ibid</i>
—— double passaged	213	—— expressions for angular velocity of, for a pair of engines	<i>App.</i> 180
Cocks	203, 211	—— expressions for greatest deviation from mean value	<i>ibid</i>
—— construction of	211	—— position of, when velocity is greatest	<i>App.</i> 180
Coke	112, 115	————— is least	<i>ibid</i>
Colchis and Jason, Russian steam ships of war (<i>Plates of engines and vessels 43,</i> <i>44, 45, 46, 108, 109, 110</i>)	369, 492	Crawford, Dr.	21, 107, 108
Combined engines	29, 181, 185, 186, 199	Creighton, W.	51, 56
Combustion and combustibles	105, 114	——— experiments by	69
Combustion, process of	114	Curr, John	36
Comet, first steam boat in Europe (<i>Plate 93</i>)	470	Currents, resistance of	311, 312
Condensation	6, 25, 34, 146	Cylinder, cooling in	95
——— principles of	146, 150	——— ratio between length of stroke and diameter of	161
Condensers	26, 27, 34, 86, 169	——— proportions of	<i>ibid</i>
Condenser gauge	266	Cylinders, double, ratio of	182, 192
Condensing engines, nature of	184	——— practical rules for	<i>App.</i> 211
——— construction of	186	Cycloidal paddle wheel of the Great West- ern steam vessel (<i>Plate 26</i>)	<i>App.</i> 53
——— proportion of parts	187, 190, 192, 195		
——— power of	188, 190, 191, 196, 198, 201	D.	
——— application of	189, 191, 197	Dalton, John	40
Conical valves	205	——— experiments by	
——— pendulum	261, 263	64, 65, 66, 74, 76; 79, 107, 108, 167
——— practical rules for	<i>App.</i> 213	———'s mode of experimenting	65
Connecting rod	229, 230, 242	——— tables of experiments on the force of steam of temperatures from 32 to 212°	66
——— to find the length of	238	Damper, regulated	37, 251
Contractions in pipes, effect of	88	——— self regulating	137
Copper, precipitation of, by iron	<i>App.</i> 5	Davy, Sir H.	80, 114
——— funnels, failure of	<i>App.</i> 12		
——— boilers, advantages of	<i>ibid</i>		
Corn mills	284		
Cornish reports	276, 277, 278		
Cooling, loss of force by	92, 95		

	PAGE		PAGE
Davy, C. (<i>Plates 64, 65, 66, 67 A, 67 B</i>)		Engine, double cylinder expansive	181
Dead plate	132	— expansive	
D slide	195	— 27, 29, 33, 43, 167, 177, 194, 198	
Density of steam	16, 83	— fire	25
Desaguliers, J. T.	14	— Hornblower's	29
Dickinson's and Bramah's engine	32	— Newcomen's	10, 11, 23
Dinnen, J., assistant engineer, Woolwich		— noncondensing	173, 174
Dock-yard, on marine boilers	<i>App.</i> 1	— Papin's	8
Ditchburn, T. J., (<i>Plates of the Red Rover,</i> 30, 31, 32)		— portable	22
Don Juan, engines of, Peninsula Company		— rotary	27, 28, 30, 32, 36, 40
(<i>Plate 41</i>)	368	— Savery's	5, 6, 17, 24, 36, 37
Double acting engine	27, 185, 195	— Stephenson's patent locomotive	407—469
— for mines	276	— water-commanding	2
Drainage of mines	275	— Watt's	25, 26, 27, 28
Dupin, Baron	29	— Woolf's	94, 237
— total extent of steam power		— Worcester's, Marquis of	3
applied in Great Britain estimated by	46	Eolipile	1, 2
		Equalization of the motion of engines	256
E.		— by a fly	<i>ibid</i>
Eccentric motion	225	— by counter weights	260
— practical rule for	<i>App.</i> 213	Equilibrium of heat	47
Edward Anthony, United States' boat en- gine (<i>Plate 115</i>)		Ether, sulphuric	75
Edelcrantz	141, 209	— latent heat of	54, 55
Eduction pipe	11	— elastic force of	75
Effect, useful, how to measure	269	Evans, Oliver	43, 131, 179
Elastic fluids and vapours, motion of	87	Expanding power of steam	152, 226
Elastic force of vapours	56—89	Expansive engine	
— separated from the		27, 29, 33, 43, 167, 177, 194, 198	
liquids from which they were generated	82	— double cylinder	181
— of steam or vapour produced by		Experiments, Arsberger's, on high pressure	
increased temperature does not follow		steam	71
the same law, when it is not in contact		— Cagniard de la Tour's on ether	75
with the fluid from which it is gene- rated, as when in contact	58, 82	— Dalton's on the force of steam	66
— of steam	56, 89	— on ether	76
— rules for	58, 59	— Macneill's on canals	<i>App.</i> 200, 201
Electric fluid	45	— Payne's on steam	16, 17
Emerson, William	20, 226, 284	— Robison's on the force of steam	64
Engine, Amonton's	8, 16	— Roy's on air and steam	86
— atmospheric	9, 10	— Rumford's on steam	52, 53, 54
— improved	40, 189	— Southern's on the force and heat of steam	51, 70
— Cartwright's	35	— Taylor's on steam	70
— condensing	184	— Ure's on vapour of alcohol	74
— Dickinson's	32	— ether	76
		— petroleum	79
		— force of steam	69

	PAGE
Experiments, Watt's on steam from salt water	62
————— from pure water	<i>ibid</i>
————— on paddle wheels	<i>App.</i> 42, 43, 47
————— additional, on paddle wheels	<i>App.</i> 55
————— deductions from	— 56
————— description of, to ascertain the effect of fixing the paddle boards at an angle with the radius of the wheel	— 57
————— to ascertain the ratio of the speed of a steam boat to the pressure	— 62
————— on H. M. ship Lightning	<i>ibid</i>
————— Dee	— 64
————— Phoenix	— 65
Explanation of plates	327
Expressions for the heat of conversion into steam	50
————— finding the volume steam will occupy under any compressive force not exceeding 60 atmospheres	84
————— area of steam passages	90
————— loss of velocity of steam from bends or obstructions in the pipes	91
————— loss of force of steam by cooling in passing through the steam pipe	92
————— loss by cooling cylinder	99
————— area of chimneys	102, 103
————— fire surface	117
————— quantity of water for condensation	147
————— power of the steam of a cubic foot of water	155
————— power of steam of a cubic foot of water when acting expansively	<i>ibid</i>
————— the greatest quantity of mechanical power the steam of a cubic foot of water will give when acting expansively	156
————— proportion of length of cylinder to diameter	162
————— best velocity for the engine to work with	164
————— capacity of air pump	169
————— power required to work air pump	171
————— friction of pistons	221, 222
————— circular force of crank	229

	PAGE
Expressions for stress on the axis or shaft	229
————— length of radius rods for parallel motion	231, 233, 234, 235
————— strength of rods subjected to tensile strain	240
————— piston rods	241
————— cranks	243
————— wheel arms	<i>ibid</i>
————— beams	<i>ibid</i>
————— shafts	245
————— beam gudgeons	<i>ibid</i>
————— pipes and cylinders	247
————— flat plates to bear the pressure of steam	248
————— the greatest stress in lbs. on a circular inch a plate will bear	249
————— strength of boilers formed of plates	251, 252
————— cast iron boilers	253
————— fly wheels	259
————— counter weights	260
————— paddle wheels	303, 304
————— the angle when the effective resistance of the paddle is greatest	<i>App.</i> 49
————— effective leverage of crank	— 175
————— angular velocities of crank for one engine	— 177
————— deviation from mean value of angular velocities	<i>ibid</i>
————— angular velocities of a crank for a pair of engines	— 180
————— the screw propeller applied to steam vessels	— 231

F.

Fairbairn, W., of Manchester	392, 393
Faraday, Michael	56, 60, 80, 81, <i>App.</i> 6
Fced pipe	135
Fenwick, Thomas	40, 260
Field, Joshua	262, 272
————'s valve	262
Fincham, J., master shipwright, Sheerness Dock-yard, (<i>Plates</i> 33, 34, 35, 36, 94, 104, 105, 106, 107)	.
Fire, management of	273

	PAGE		PAGE
Fire grating, supply of air and area of	115	Formula for power required to work air	
—— rule for	<i>App.</i> 210	pump	171
—— engine	25	—— friction of pistons	221, 222
—— places	132	—— circular force of crank	229
—— Watt's	<i>ibid</i>	—— stress on the axis or shaft	<i>ibid</i>
—— Robertson's	133	—— length of radius rods for pa-	
—— Brunton's	134	rallel motion	231, 233, 234, 235
—— regulation of	137	—— strength of rods subjected to	
Fitzgerald, Keane	20	tensile strain	240
Float	135	—— piston rods	241
Flues	251	—— cranks	243
—— internal	125	—— wheel arms	<i>ibid</i>
Fluids	47, 109	—— beams	<i>ibid</i>
—— resistance of	292—308	—— shafts	245
Fly wheel	20, 163, 256	—— beam gudgeons	<i>ibid</i>
—— velocity of	258	—— pipes and cylinders	247
—— danger of	<i>ibid</i>	—— flat plates to bear the	
—— rules for	259	pressure of steam	248
Formula for the heat of conversion into		—— the greatest stress in lbs. on a	
steam	50	circular inch a plate will bear	249
—— finding the volume steam will		—— strength of boilers formed of	
occupy under any compressive force		plates	251, 252
not exceeding 60 atmospheres	84	—— cast iron boilers	253
—— area of steam passages	90	—— fly wheels	259
—— loss of velocity of steam from		—— counter weights	260
bends or obstructions in the pipes	91	—— paddle wheels	303, 304
—— loss of force of steam by cool-		—— the angle when the effective	
ing in passing through the steam pipe	92	resistance of the paddle is greatest <i>App.</i> 49	
—— loss by cooling cylinder	99	—— effective leverage of crank	175
—— area of chimneys	102, 103	—— angular velocities of crank for	
—— fire surface	117	one engine	177
—— quantity of water for conden-		—— deviation from mean value of	
sation	147	angular velocities	<i>ibid</i>
—— power of the steam of a cubic		—— angular velocities of a crank	
foot of water	155	for a pair of engines	180
—— power of steam of a cubic foot		—— the screw propeller applied to	
of water when acting expansively	<i>ibid</i>	steam vessels	231
—— the greatest quantity of me-		Foot valve	205
chanical power the steam of a cubic		Friction of engines	40
foot of water will give when acting		—— of bodies	215
expansively	156	—— of fluids	293, 313
—— proportion of length of cy-		—— of pistons	221, 222
linder to diameter	162	—— of slides	209
—— best velocity for the engine		Fuel, effect of	22, 194, 195, 201
to work with	164	—— nature of	105
—— capacity of air pump	169	—— measure of effect of	107

	PAGE		PAGE
Fuel, table of effect of	109	Hull's method of converting a reciprocating	
Fulton	44	motion into a rotary one	14, 15
Furnace, Robertson's	133	Humphrys, F., Dartford, (<i>Plates</i> 51, 52,	
Fusible plug	142, 143	53, 54, 55 A, 55 B, 56 A, 56 B)	382, 390
		Humphreys, J. B.	<i>App.</i> 166
		Hydrogen, effect of, in fuel	107, 108
G.		I.	
Gases, properties of	47, 82, 83	Inclined planes	279, 285
— as mechanical agents	80, 81, 85	Indicator	28, 267
Gasket	216	— by Joseph Glynn	<i>App.</i> 167
Gauge cocks	7	— diagrams	385, 386
— steam	28, 266	— calculating the power of an engine	
— condenser	28, 34, 266	by the indicator cards	387
Generation of steam	17, 105	Injection	9, 146, 147, 187
— power of steam	151	— regulating by	23, 189
Gensanne	18	— temperature in atmospheric engines	98, 99
Gilbert, Mr.	101, 145	— water, quantity of	146, 147
Glasgow, number of engines in	45	Inspection of engines	276, 277
Glynn, J., on the indicator	<i>App.</i> 167	Irrigation	189, 283
Governor	263, 264	Irvine, Dr.	21
— practical rules for	<i>App.</i> 213	Ivory, James	71, 72
Grate bars, area of 115, 116, 134, 135, —	210		
Grinding corn	284	J.	
		Jacket, steam	93, 95
		— air-tight	96
H.		Jackson, Dr.	257, 258
Hall's piston	334	Jessop's piston	221
Hall, Samuel, his improvements in the steam		Jet for condensing	147
engine	370, 371	Joining pipes	254
Hand gear	224, 226, 227	Jouffroy, Marquis de	31
Hassenfratz	107		
Heat, specific	21, 47, 49	K.	
— latent	21, 48, 49	Kier's engine, effect of	36
— capacity for	21, 48	Kingston's valves	353, 354
— expansion by	<i>ibid</i>		
Hemp, friction of	214	L.	
— packing	216	Lang, Oliver, master shipwright, Woolwich	
Henderson, Capt. Andrew, of Calcutta	473	Dock-yard, (<i>Plates</i> 100, 101, 102, 103,	
High pressure engine	13, 27, 41, 152	112)	477, 499
— construction of	174	Lang, James Henry, Woolwich Dock-yard	<i>ibid</i>
Hopper	133	Lang, Oliver, Jun., Plymouth Dock-yard	
Hornblower, Jonathan 28, 29, 148, 153, 186, 199		(<i>Plate</i> 99)	476
—'s rotary engine	30	Latent heat	21, 48
—'s valve	206		
Horse power	22, 23		
Hot well	11		
Hulls, Jonathan	14		

	PAGE		PAGE
Latent heat, measure of	49	Locomotive engine, splashers	463
Lavoisier	107, 108, 207	— steam chest	427
Leslie, Professor	42, 117, 256	— pipe	423
Leupold	13, 211	— area of	424
Limit of steam power	156	— tank	467
Links	231	— tender	466
Living forces, principle of	<i>App.</i> 183	— wheels for	<i>ibid</i>
Lloyd's piston	334	— tubes	412
Locomotive engine, parts of	407	— wheels, framing, &c.	454
— blast pipe	415	— working of piston and slides	447
— blow off cocks	422	— practical rules for	<i>App.</i> 226
— boiler and manner of ge- nerating steam	409		
— brake	467	M.	
— coke	467	Macneill's experiments on canals	<i>App.</i> 200
— connecting rods	425	Manufacture, engines for	281
— cranked axle	437	— iron	<i>ibid</i>
— cross heads and guides	434	— cotton	282
— cylinders and manner of using steam	423	— paper	<i>ibid</i>
— cylinders and piston	427	Maudslay	32, 163, 212
— damper	417	—'s four-way cock, (<i>Plate 8</i>)	335, 336
— eccentrics	442	— and Field's experiments on marine boilers	<i>App.</i> 2
— action of	443	— and Co.	272, 316
— external fire box	409	Maximum of useful effect	33, 163
— feed pumps	418, 451	— equalized by a fly	163
— fire and heating power	422	Medea, H. M. steam ship, memoir of	<i>App.</i> 80
— gauges	419	— power of engines	— 82
— inside frames	463	— rigging and internal fitting	— 83
— internal fire box	410	— dimensions of	— 84
— lead plug	420	— engines of	— 85
— man hole	421	Mediterranean, daily evaporation of	— 1
— mud holes	<i>ibid</i>	Mercurial gauge	142, 266
— oil cup	449	— safety gauge	142
— outside framing	459	Metallic piston	34, 35, 218
— pet cock	418	Metallic packing for rods	223
— piston	430	Miller, Patrick	31
— regulator	425	Millington, John	119, 120, 208
— reversing gear	444	Mines, engines for	178, 189, 275
— safety valve	420	— depth of	276
— lock-up	421	Morgan, W. <i>App.</i> 41, 42, 43, 48, 52, 53, 55, 56, 61, 71, 83, 87, 88, 118, 156, 157, 158, 159,	160, 162
— slide valves	427	Morland, Sir Samuel	4
— form of	428	—'s table of force of vapour	<i>ibid</i>
— gear of	443	Mornay, A. A., on paddle wheels	<i>App.</i> 117
— smoke box	415		
— doors	418		

	PAGE
Motion of air and vapour	87
——— steam boat engines	308
Moura, De, M.	18
Murdoch, William	38
———'s slide	208
Murray, Matthew	37
———'s slide	207, 208
———'s damper	37
———'s portable engine	38

N.

Nancarrow, John	37
Napier, Robert, Glasgow	471
Navigation, steam 14, 31, 44, 45, 46, 288	
Newcomen, Thomas	9
———'s engine	10, 11, 23
——— water applied to the out- side of the cylinder for condensing the steam of	9
——— injection inside discovered by accident	9
——— apparatus for opening and closing valves invented	11
Nimmo, Alexander	140
Nitric acid	55
Noncondensing engines	173, 174
——— power of 175, 176, 179	
——— fuel and water for 105, 177	
——— expansive	179
——— fuel for expansive 180	
——— best force of steam 182, 183	

O.

Oars	297
Oil	273
Oil gas vapour	80
Oil cup	212
Oliver, Capt.	<i>App.</i> 65, 78
Ores, engines for drawing	279

P.

Packing	216
Paddle wheels	300
——— action of	<i>App.</i> 121

	PAGE
Paddle wheels, motion of	<i>App.</i> 119
——— centre of pressure of	44
——— with fixed floats	124
——— with feathering floats	145
——— floats turning on radial axes <i>ibid</i>	
——— horizontal axes	146
——— oblique floats	143
——— improved mode of connecting Morgan's wheel to engine <i>App.</i> 164, 165	
——— cycloidal, invention of, due to Mr. Field	53, 140
——— description of, as ap- plied to the Great Western <i>App.</i> 53	
——— coefficients for calculating the action of	195
——— horses' power expended on entire	192
——— hori- zontally	<i>ibid</i>
——— on, vertically	192
——— decay of	29
——— varnish for	30
——— by P. W. Barlow	40
——— by A. A. Mornay	117
——— Buchanan's	146
——— Cavé's	161
——— common wheel	<i>App.</i> 124, 193
——— cycloidal	53
——— Field's	140
——— Morgan's	156
——— Oldham's	152, 193
——— Perkins's	144
——— Stevens's	110
——— vertically acting	193
——— table of velocity of centre of effort	38, 39
——— experiments on Admi- ralty steamers	43
——— experiments exhibiting the ratio of the velocity of the wheel and vessel	47
——— comparison of the lost power in the vertical and the common wheel	52

PAGE	PAGE
Paddle wheels, table of experiments on, made at Maudslay and Field's manufactory <i>App.</i> 55	Parallel motion, formula for . . . 233
————— experiments to ascertain the effect of fixing the paddle boards at an angle with the radius of the wheel . . . 58	————— when radius rod works from a stated centre . . . <i>ibid</i>
————— experiments on Her Majesty's ship <i>Lightning</i> , to ascertain the difference of speed due to different amounts of power . . . 62	————— Rule III. . . 234
————— do. <i>Dee</i> . . . 64	————— proportion of links . . . <i>ibid</i>
————— do. <i>Phoenix</i> . . . 65	————— Rule IV. . . 235
————— ratio of speed of a steam boat to the power . . . 67	————— Rule V. . . 236
————— performances of Her Majesty's Post Office steam packets . . . 68	————— for steam boat engines . . . <i>ibid</i>
————— speed and consumption of coals of nine of the most recently constructed of Her Majesty's steam vessels . . . 71	————— point for the air pump rod to be attached . . . 237
————— comparison of the resistance of a steam vessel with that of a plane surface . . . 76	————— to fix the radius bar . . . <i>ibid</i>
Paddles . . . 301, 302, 308, 309, 314, 315	————— form of curve described by the piston rod. . . 238
————— number of . . . 307	————— rules for . . . 232, 234
————— power of . . . 302, 303, 304, 314	————— practical rules for <i>App.</i> 216
————— modification of . . . 308, 309	Passages, steam, area of . . . 94
————— reefing of . . . 61	Payne, John . . . 16
Papin, Dr. . . . 5, 7, 9, 16, 25, 31, 139	—————'s experiment to determine the density of steam . . . 16, 17
—————'s suggestion of employing the expansion and contraction of steam under a piston to form a vacuum . . . 5	—————'s disperser . . . 17
—————'s suggestion of a steam engine being applicable to impel machinery . . . 8	Peacock, G., master of the <i>Medea</i> . . . <i>App.</i> 83, 94, 98
—————'s engine <i>ibid</i>	Pendulum, conical . . . 263
Parabola 226	Perkins, Jacob . . . 214, 221
Parabolic paddles 305	Perronet 31
Parallel motion 28, 33, 35, 230	Petroleum 55, 79
————— Case I. Where two beams are connected by a link, the segments of the link are inversely proportional to the radii of the beams . . . 231	Phosphorus, effect of as fuel . . . 108
————— Rule I. 232	Pipes 254
————— Rule II. <i>ibid</i>	Pistons 10, 213
————— Case II. When a beam is fitted with a full motion . . . <i>ibid</i>	————— Barton's 219
	————— Cartwright's 218
	————— Jessop's 221
	————— Hall's 334
	————— Lloyd's 334
	————— Smeaton's 216
	————— Woolf's 217
	————— metallic 34, 214, 218
	————— principles of action . . . 221
	————— pressure on 23, 36
	————— rules for <i>App.</i> 222
	————— slide 209
	————— construction of 214
	————— arrangement of <i>ibid</i>
	————— thickness of <i>ibid</i>
	————— leather 215
	————— atmospheric engine 216

	PAGE		PAGE
Pistons, hemp packed	216	Plate 18. Isometrical projection of a steam boat engine as first arranged by Boul- ton and Watt	347
——— friction of	221	Plate 19. Steam boat engine	349
Piston rod	214	Plate 20. Side elevation and cross section of a steam carriage	350
——— collars	222	Plate 21. Kingston's valves	353
——— guides	227	——— blow off valves	<i>ibid</i>
——— strength of 241, <i>App.</i>	212	——— hand pump valves	354
——— diameters of, for locomotive en- gines, as used by Messrs. Stephenson and Co.	399	——— injection valves	353
Plates, explanation of	327	——— manner of fixing the valves	354
Plate 1. Isometrical projection of a rectan- gular steam boiler	328	Plate 22. Boiler of H. M. steam vessel African	355
Plate 2. Two sections of a cylindrical steam boiler	329	Plate 23. Boilers of H. M. steam frigate Medea	<i>ibid</i>
Plate 3. Brunton's apparatus for feeding furnaces by machinery	330	Plate 24. Paddle wheels of Morgan and Seaward	357
Plate 4. High pressure engine with four- passaged cock	331	Plate 25. Positions of a float of a radiating wheel, and also of a vertical acting wheel, in a vessel in motion	<i>ibid</i>
Plate 5. Section of a double acting conden- sing engine for working expansively	332	Plate 26. Cycloidal paddle wheel fitted to the Great Western	<i>ibid</i>
Plate 6. Section of an atmospheric engine	333	Plates 27, 28. To illustrate Capt. Oliver's paper	358
Plate 7. Represents the construction of pistons	334	Plate 29. Exhibits the various situations of a trial at sailing of the Medea, with the Caledonia, Vanguard, and Asia	<i>ibid</i>
Plate 8. Fenton and Murray's double engine	335	Plate 30. Side view of the engines of the Red Rover, and City of Canterbury, steam vessels	<i>ibid</i>
Plate 9. Apparatus for opening and closing steam passages	337	Plate 31. Longitudinal section of the Red Rover's engine	359
Plate 10. (A and B) Combinations used to produce rectilinear motion from motion in a circular arc	338	Plate 32. Cross section of engines of the Red Rover	360
Plate 11. Plan and elevation of an atmos- pheric pumping engine for raising water from a mine	339	Plate 33. Side elevation of the engine of the Nile steam ship	361
Plate 12. Boulton and Watt's single acting engine	340	Plate 34. Plan of the engine of the Nile	<i>ibid</i>
Plate 13. Double acting engine for raising water	341	Plate 35, 36. Cross sections of engines of the Nile	362
Plate 14. ————— for impelling machinery	342	Plates 37, 38, 39. Engines of H. M. steam frigate Phoenix	363
Plate 15. Maudslay's portable engine	343	Plate 40. Engines of the Ruby Gravesend packet	364
Plate 16. Indicator for measuring the force of steam in the cylinder	345	——— Dimensions and speed of	367
——— Diagrams to illustrate the com- parative stability of opposite classes of vessels	345	Plate 41. Section of one of the engines of the Don Juan	368

	PAGE		PAGE
Plate 42. Boilers of H. M. ships Hermes, Spitfire, and Firefly	368	Plate 69. Messrs. Hague's double acting cylinder with slides	399
Plates 43, 44, 45, 46. Elevation, plan, and two sections of the engine room of the armed Russian steam ships Jason and Colchis	369	Plates 70 A, 70 B. Sections of the engines of the Berenice steam vessel	400
Plates 47, 48. Hall's improvements on steam engines	370	Plates 71, 72. Beale's patent rotatory engine	401
-----Extracts from his specification	<i>ibid</i>	Plate 73. Mr. Ayre's contrivance for preventing a locomotive engine from running off a railway	403
Plates 49, 50. Engines of H. M. steam ship Megæra	378	Plates 74 to 83. Relate to Mr. Mornay's paper on paddle wheels	<i>App.</i> 117
-----Action of the valves	380	Plates 84 to 88. Sixty-five inch cylinder engine, erected by Messrs. Maudslay, Sons and Field, at Chelsea water-works	404
Plates 51, 52, 53, 54. Engines of the Hull and London steam packet William Wilberforce	382	Plates 89 to 92. Patent locomotive engine, made by Messrs. R. Stephenson and Co. for the London and Birmingham Railway	407
Plate 55 (A). Longitudinal section of Humphrys's patent marine engine	390	Plate 93. Drawings of the Comet, the first steam boat in Europe	470
Plate 55 (B). Longitudinal elevation of Humphrys's engine	391	Plate 94. The Pacha's steam vessel of war, the Nile	471
Plate 56 (A). Midship section of the steam packet Dartford, showing a front elevation of a pair of Humphrys's engines	<i>ibid</i>	Plates 95, 96. The Hon. East India Company's steam vessel Berenice	<i>ibid</i>
Plate 56 (B). Plan of the engines of the Dartford	392	Plate 97. Draught of the Forbes steamer	473
Plates 57, 58, 59. Forty-five-horse power engine, constructed by W. Fairbairn and Co.	<i>ibid</i>	Plate 98. Herne Bay steam packet Red Rover	474
Plates 60, 61, 62, 63. Ten-horse power engine, constructed by W. Fairbairn and Co.	<i>ibid</i>	Plate 99. Diamond Company's steam packet Ruby	475
Plate 64. Elevation of a locomotive engine, Stanhope and Tyne Railway; constructed by Messrs. R. Stephenson and Co., of Newcastle-upon-Tyne	394	Plates 100 to 103. Her Majesty's steam vessel of war Medea	477
Plate 65. Section of ditto	396	Plates 104 to 107. Construction of the Nile steam ship, built for the Pacha of Egypt	483
Plate 66. Safety valves of ditto	<i>ibid</i>	Plates 108, 109, 110. His Imperial Majesty's armed steam vessel Colchis	492
Plate 67 (A). Cylinder cover and connecting rods of ditto	397	Plates 111, 111 (A). Engines of the steam ship Tiger	497
Plates 67 (B). Cylinder and piston at large of ditto	398	Plate 112. The Admiralty yacht Firebrand	498
Plate 68. Plan and section of boiler seating for a twenty-horse engine, at the manufactory of Messrs. Whitworth and Co., Manchester	399	Plate 113. Portrait of the late Mr. Watt	500
		Plate 114. Portrait of the late Mr. Tredgold	<i>ibid</i>
		Plates 115, 117, 118. Illustrate the state of steam navigation in America	<i>ibid</i>
		Plug tree	224
		Poisson	86, 291
		Portable engine	22, 28, 38

	PAGE		PAGE
Potter, Humphrey	11	Resistance of vessels	292, 313
Power of steam	150, 153	Robertson's furnace or fire-place	39, 133
———by condensation	150	Robison, Dr. John	38, 206, 207, 258
———generation	151	———experiment by	63, 64, 74
———expansion	151, 152	Rotary motion, methods of producing	
———practical rule for <i>App.</i>	225	15, 20, 26, 37, 227
———rotary	157	———engines	27, 28, 30, 32, 36, 40
———modes of applying	160	———power of steam	157
———paddles	301, 306, 313, 314	———valves	210
———for vessels	313, 325	Roy, General	85, 86
Prony, R.	33, 120, 230	Ruby, Gravesend packet, engines of	364
Propelling vessels	297	Rule for conversion of heat into steam	50
———screw	<i>App.</i> 231	———for the quantity a gas or vapour ex-	
Pumping expels air from water	168	pands under a constant pressure	82
———water	274	Rules, practical, for BOILERS	<i>App.</i> 207
Pumps, rule for finding the volume of <i>App.</i>	214	———the dimensions of, for	
———finding the power requisite		any given power when rectangular <i>ibid</i>	
to discharge a given quantity of water <i>ibid</i>		———when cylindrical — 208	
———finding the velocity neces-		———the requisite thickness	
sary to discharge a given quantity of		of plates for	<i>App.</i> 208, 209
water	<i>App.</i> 216	———the height of a column	
———finding the diameter of,		of water to supply a boiler against any	
to discharge a given quantity of water		proposed pressure	— 209
.	<i>ibid</i>	———cylinders, requisite	
———brine	<i>App.</i> 2	thickness of	— 211
		———chimney, area of	<i>ibid</i>
		———eccentric	— 213
		———fire grating	— 210
		———governor	<i>ibid</i>
		———PARALLEL MOTION — 216	
		———the point in	
		the link where the piston rod must be	
		attached	<i>ibid</i>
		———the length of	
		the radius bar	— 218
		———the length of	
		radius bar when it and the piston rod	
		are attached to the links at different	
		distances	— 219
		———the lengths of	
		parallel bar and radius bar, when the	
		latter works from a stated centre — 220	
		———piston rod, diameter of — 212	
		———PUMPS—the number of	
		cubic feet in the volume of a cylinder — 214	
		———the power re-	

R.

	PAGE		PAGE
quisite to raise water to any proposed height	App. 214	S.	
Rules, practical, for pumps—the velocity necessary to discharge a given quantity of water	216	Sadler	32
————— the diameter of, necessary to discharge a given quantity of water	<i>ibid</i>	Safety valve	7, 103, 139, 206
————— LOCOMOTIVE ENGINES	226	————— rule for area of	<i>App.</i> 210
————— the power	229	————— escape of steam at	103
————— the effective force of gravity when an engine and train are running upon an inclined plane	226	————— pipes	140, 141, 142
————— the speed under any given circumstances of load, inclination of railway, &c.	229	————— rules for	142
————— the tension on the circumference of the driving wheels, or what is termed the resistance to traction	227	Sailing, trial of between H. M. ships Asia, Caledonia, Medea, and Vanguard <i>App.</i>	100
————— the quantity of water required for steam	225	Sails, power of	310
————— the pressure of steam in the cylinder	228	Savery, Thomas	5, 7, 16
————— properties of steam	205	—————'s Miner's Friend	5
————— steam pipe, diameter of	210	————— engine simplified	7
————— the elastic force of steam when in contact with the liquid from which it is generated	205	————— first effective steam engine by	<i>ibid</i>
————— the mean pressure on the piston, when worked expansively	222	————— engine	5, 6, 17, 24, 36, 37
————— table of multipliers for mean pressure, acting expansively	223	Schmidt's experiments on heat	51, 70
————— the power	225	Screw propeller applied to steam vessels <i>App.</i>	231
————— the aperture of a safety valve for any given pressure	210	Seaward's slides	209
————— the space the steam of a cubic foot of water occupies when of a given elastic force and temperature, and separated from the liquid from which it is generated	206	Sea water, elastic force of steam of	60
Rumble, F. (<i>Plates</i> 84—88)		————— analysis of	61, 271, 272
Rumford's, Count, boilers	42, 106, 107, 128	————— boiling point of	272
————— experiments on latent heat	52	Shafts, strength of	245
		Ships, resistance of	296, 313
		Side rods, strength of	242
		Simpson, J., Chelsea water-works	404, 405
		Single acting engine	191
		————— expansive	194
		Sleck, effect of	36, 113
		Slide	38, 174, 175, 199, 207
		————— construction of	207
		————— improved	208
		————— friction of	209
		————— cylindrical	<i>ibid</i>
		————— modes of opening by	225
		————— Murray's	207
		————— Bramah's	<i>ibid</i>
		————— Murdoch's	208
		————— Seaward's	209
		Smeaton, John 18, 21, 22, 23, 24, 118, 119, 215	215
		—————'s piston	219
		Smoke, ascent of	100, 145
		————— quantity of	115
		Snifting valve	11
		Southern, John	44, 56, 57

PAGE	PAGE
Southern's mode of experimenting on high pressure steam	69
— experiments by	51, 70
— on the force of steam	70
Speed of vessels	311, 313
Spring beams	262
Stability of vessels	289
Stamping engines	279
Steam, density of, directly as the pressure	52
— condensation of	146
— elastic force of	51, 56, 62, 64, 70
— rules for	58, 59, 82, 83
—	<i>App.</i> 205
— volume of	12, 16, 52, 83, 84
— inversely as the pressure	52
— rules for	84, <i>App.</i> 206
— expansion of	83
— temperature	58
— capacity of, for heat greater than that of water	48
— Robison's apparatus for determining the force of	63
— generation and condensation of	105
— heat to produce	49, 51, 52, 55, 56, 113
— power of	150
— to produce rectilinear motion	153
— modes of applying the power of	160
— power, rotary	157
— latent heat of	48, 56, 112
— mixture of air and	84
— motion of, in an engine	88
— effect of	312
— escape of, at valves	103, 143
— quantity of, for engines	176, 180, 181, 187, 190, 192, 196
— force of	32, 41, 56—84
Steam vessels	14, 41, 288
— Red Rover	358, 474
— City of Canterbury	358
— Medea	<i>App.</i> 100
— African	355
— Caledonia	<i>App.</i> 100
— Asia	<i>ibid</i>
— Vanguard	<i>ibid</i>
— Nile	361, 483
— Phoenix	363
Steam vessels, Rhadamanthus, Salamander (<i>Plates</i> 38, 39)	363
— Ruby	364, 475
— Don Juan	368
— Hermes, Spitfire, Firefly	<i>ibid</i>
— Jason and Colchis	369
— enumeration of, fitted with Hall's improvements	376
— Megæra	378
— William Wilberforce	382
— Dartford	391
— Comet	470
— Forbes	473
— Berenice	400, 471
— Colchis	492
— Tiger	497
— Firebrand	498
— Great Western	357
— Car of Neptune (U. S.)	<i>App.</i> 103
— Sun (U. S.)	— 105
— North America (U. S.)	— 106
— President (U. S.)	— 107
— New Philadelphia (U. S.)	— 108
— Fulton (U. S.)	— 110
— North Carolina (U. S.)	<i>ibid</i>
— Cornelius Vanderbitt (U. S.)	<i>ibid</i>
— Highlander (U. S.)	<i>ibid</i>
— Lexington, dimensions (U. S.)	111
— Dewitt Clinton (U. S.)	— 110
— Savannah (U. S.)	— 113
— Cleopatra (U. S.)	— 114
— Massachusetts (U. S.)	<i>ibid</i>
— register tonnage of	320
— navigation of	14, 31, 41, 288, 360
— engines of	314
— pressure engines	25, 175, 191
— case	38, 92, 93, 95
— gauge	266
— cylinder	161
— indicator	267
— engine, invention and improvement of	1—46
— general theory of, by Editor	<i>App.</i> 173
— Dickinson's	32
— Hornblower's	29

	PAGE		PAGE
Steam engine, Newcomen's	10, 11, 23	Steam engine, force of steam for	183, 194, 195
——— Papin's	8	——— loss of steam	183
——— Savery's	5, 6, 17, 24, 36, 37	Steam passages	187
——— Stephenson's patent locomotive	407	——— rules for	94
——— Watt's	25, 26, 27, 28	Steam pipes, cooling in	92
——— Woolf's	94, 237	——— journal, form of	<i>App.</i> 31
——— Worcester's, Marquis of	3	Stephenson's patent locomotive engine	407
——— equalizing the action of	256	Strength, effect of expansion on	247, 253
——— atmospheric	96, 98, 99, 187	Strength of parts of engines	239—255
——— maximum effect of	99, 100	——— rods	240, 241
——— of useful effect in	163	——— beams	243
——— for, when equal-	163	——— cranks	<i>ibid</i>
ized by a fly	163	——— wheel arms	<i>ibid</i>
——— of useful effect for	163	——— teeth of wheels, table of	244
raising water	165	——— shafts	245
——— atmospheric improved	189	——— pipes and cylinders	246
——— single acting	184, 191	——— plates	248
——— double acting	185, 195, 199	——— boilers	249
——— combined cylinder	199	——— vessels	310
——— high pressure	152, 173	Stress on the parts of engines	239
——— noncondensing	173	Stroke, length of	161
——— proportion of parts and	175	——— cut off	178, 179, 194, 198
power of	175	Stuffing boxes	222
——— at full power	176	Sulphuret of carbon, force of	77
——— by expansion	177	Sun and planet wheels	27
——— classification	150, 161	Symington, William	31, 41
——— condensing	184—212		
——— double cylinder expansive	184—212		
——— best force for the steam of	182, 183		
noncondensing	182, 183		
——— regulating the power of	260		
——— methods of ascertaining the	265		
state and effect of	265		
——— measuring the useful effect	269		
of	269		
——— working of	271		
——— motion of steam in	88		
——— loss of force by cooling	92, 95, 97, 99		
——— length of stroke	161		
——— velocity of mean effect	163		
——— for expansion	165		
——— air pumps and condenser	167		
proportions	167		
——— power required for working	170		
air pump	170		

T.

Table of Southern's experiments on the	51
bulk and heat of steam	51
——— Rumford's, on heat of steam	53, 54
——— Ure's, on heat of steam	54, 55
boiling points of solutions	60, 61
expansion of water	58
constant numbers for sea water	61
Watt's experiments on the steam	62
from salt water	62
Watt's experiments on pure water	<i>ibid</i>
Robison's experiments on pure water	64
on the force of steam	<i>ibid</i>
Dalton's experiments on the force	66, 67
of steam	66, 67
Ure's experiments on the force of	69
steam	69

	PAGE		PAGE
Table of Southern's experiments on the force of steam	70	Taylor's, Philip, scale of the force of steam	70, 178
—— Taylor's experiments on pure water	<i>ibid</i>	Taylor and Martineau	178
—— scale of force of steam	<i>ibid</i>	Teeth of wheels	244
—— Arsberger's experiments on high pressure steam	71	Thomson, Dr. T.	110, 114
—— Ivory's calculations	71, 72	Thrashing machines	283
—— force of alcohol vapour	72, 74	Throttle valve	27, 210, 261
—— Cagniard's, de la Tour, experiments on ether	75	Tonnage of a steam vessel	320
—— force of ether vapour	75, 76	Towing boats	41, 315
—— Ure's and Dalton's experiments on ether	76	Towns, supply of water for	280
—— force of vapour from sulphuret of carbon	77	Trevithick and Vivian	41, 141
—— Cagniard's, de la Tour, experiments on	78	Turpentine vapour	55, 79
—— force of petroleum	79		
—— force of turpentine	<i>ibid</i>	U.	
—— mechanical power of gases	82	Ure, Dr.	44
—— various substances where one volume of water is shown to produce more vapour than an equal volume of any other substance in the list	83	——'s mode of experimenting	54, 67
—— Roy's experiments on air and steam	86	—— tables of experiments on the force of steam	69
—— effect of contractions	88	—— experiments by	54, 74, 76, 79, 168
—— the effect of combustibles	109, 110, 111	Useful effect, mode of measuring	269
—— the effect of fuel	112, 113		
—— quantity of smoke from fuel	115	V.	
—— quantity of fire surface for boilers	118	Valves	175, 203
—— experiments on boilers	119, 120	—— safety	139
—— power of boilers	123, 124	—— rule for	<i>App.</i> 210
—— for calculating safety valves	142, 143	—— throttle	261
—— of the power of cranks	228—230	—— Kingston's	353
—— the teeth of wheels	244	—— arrangement of	204
—— the effect of engines	278	—— principles of construction	<i>ibid</i>
—— the supply of towns with water	280	—— boxes	<i>ibid</i>
—— experiments on canal boats	294, 295	—— rising	204
—— for calculating the resistance of vessels	296	—— clack	205
—— of steam vessels	316, 317, 318	—— foot	<i>ibid</i>
—— the properties of steam	322	—— flat	<i>ibid</i>
—— the proportions of single engines	323	—— Bramah's slide	207
—— the proportions of double engines	324, 325	—— conical	205
Tappets	187, 224, 265	—— Field's	262
		—— Hornblower's	206
		—— sliding	207
		—— rotary	210
		—— plate	213
		—— modes of opening	224
		Vapour, force of	56, 57

	PAGE		PAGE
Vapour, elastic force of, separated from the liquids from which it is generated	82	Watt's fire-place	132
—— bulk of	4, 12, 51	—— governor, steam gauge, condenser gauge, and indicator	28
—— nature of	47	—— parallel motion	28, 230
Velocity of elastic fluids	87	—— rotary steam wheel	27
—— engines	163	—— sun and planet wheel	27
—— vessels	311, 313, 317	Wheels	243
—— paddles	301, 302, 313	—— paddle	319
—— spiral propellers	298, <i>App.</i> 231	Wheel tyers for locomotives	398
Vessels, strength of	310	Whim engines	279
—— arranging the proportion of power for	313	Williams, W.	251
Vinegar	55	Wind, force of	310, 319
		Wood, Nicholas	119
		Woolf, Arthur	42, 133, 152, 209, 260
W.		——'s engine	94, 237
Water	271	——'s boilers	129
—— wheel	24, 87	——'s piston	217
—— air in	167	——'s assumed law of expansion of steam shown to be false	43
—— raising	194, 274	Worcester, Marquis of	2
—— screw	298	—— engine	3
—— works	280	Working of engines	271
—— modulus of	57		
—— expansion of	58	Y.	
Watt, Dr. James		Young, Dr.	120
25, 49, 98, 99, 125, 132, 148, 153, 206,			
207, 208, 230, 255, 261, 262		Z.	
—— experiments of	49, 60, 62	Zeigler, J. T.	29
Watt's boilers	125		
—— engine	25, 26, 27, 28		
—— expansive engine	27		

LONDON:

PRINTED BY W. HUGHES, (SUCCESSOR TO MR. VALPY,)

KING'S HEAD COURT, GOUGH SQUARE.







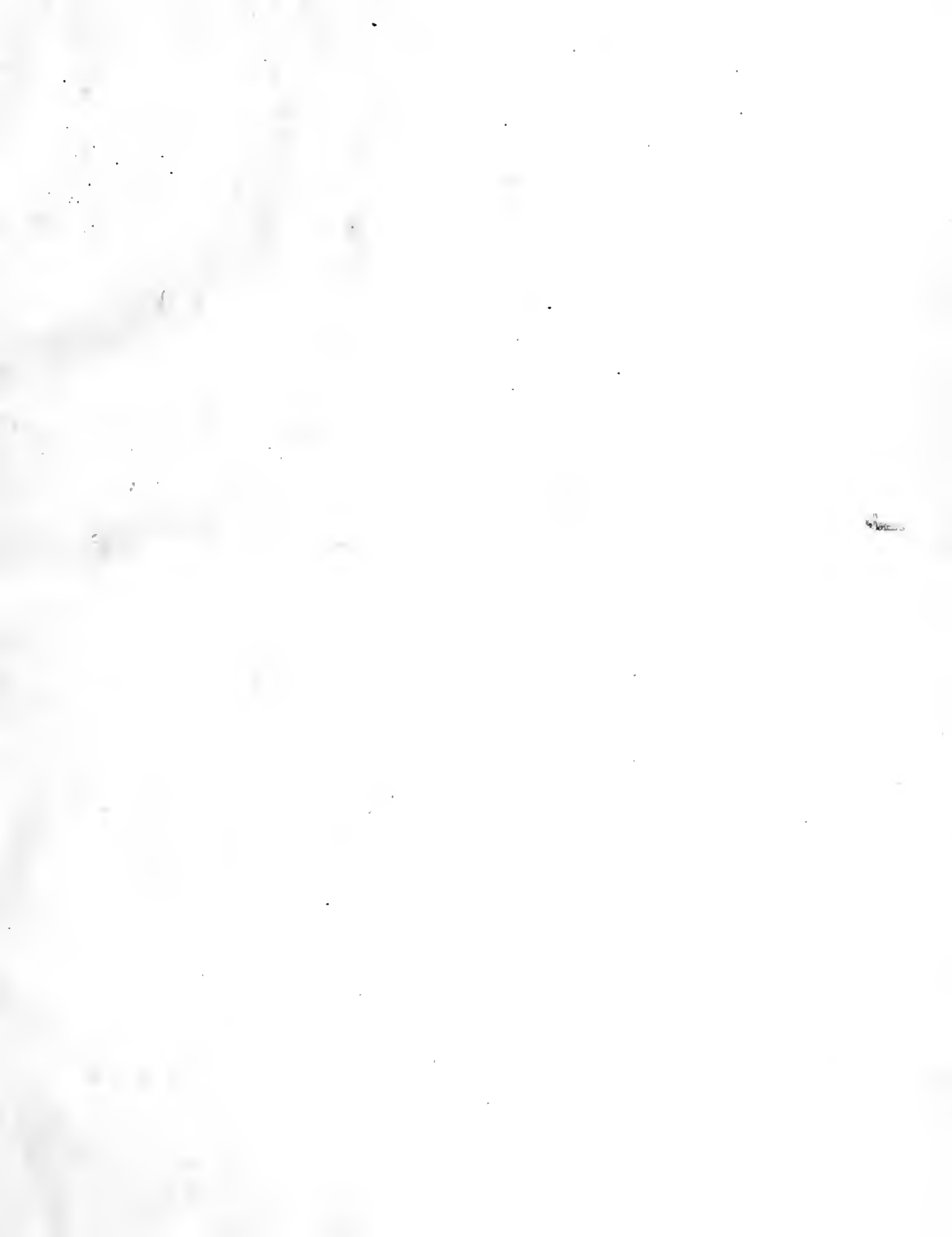

RETURN
TO →

CIRCULATION DEPARTMENT
202 Main Library

LOAN PERIOD 1 HOME USE	2	3
4	5	6

ALL BOOKS MAY BE RECALLED AFTER 7 DAYS
1-month loans may be renewed by calling 642-3405
6-month loans may be recharged by bringing books to Circulation Desk
Renewals and recharges may be made 4 days prior to due date

DUE AS STAMPED BELOW

FEB 19 1978		
OCT 28 1980	15	
DEC 7 1986		
AUTO DISC.		
NOV 18 1986	SEP 1 1986	
JUL 7 1987	NOV 21 1987	

FORM NO. DD 6, 40m 10'77 UNIVERSITY OF CALIFORNIA, BERKELEY
BERKELEY, CA 94720

LD 62A-30m-2'69
(J6584s10)9412A-A-32

General Library
University of California
Berkeley

© 1

GENERAL LIBRARY - U.C. BERKELEY



8000886761

