







**ANTHROPOLOGICAL PAPERS**

OF THE

**American Museum of Natural  
History.**

**Vol. XIV, Part I.**

**THE STEFÁNSSON-ANDERSON ARCTIC EXPEDITION  
OF THE AMERICAN MUSEUM: PRELIMINARY  
ETHNOLOGICAL REPORT.**

BY

**VILHJÁLMUR STEFÁNSSON**

**NEW YORK :**

**Published by Order of the Trustees.**

**1914.**

# American Museum of Natural History.

## PUBLICATIONS IN ANTHROPOLOGY.

In 1906 the present series of Anthropological Papers was authorized by the Trustees of the Museum to record the results of research conducted by the Department of Anthropology. The series comprises octavo volumes of about 350 pages each, issued in parts at irregular intervals. Previous to 1906 articles devoted to anthropological subjects appeared as occasional papers in the Bulletin and also in the Memoir series of the Museum. A complete list of these publications with prices will be furnished when requested. All communications should be addressed to the Librarian of the Museum.

The recent issues are as follows:—

### Volume X.

- I. Chipewyan Texts. By Pliny Earle Goddard. Pp. 1-66. 1912. Price, \$1.00.
- II. Analysis of Cold Lake Dialect, Chipewyan. By Pliny Earle Goddard. Pp. 67-170, and 249 text figures. 1912. Price, \$1.00.
- III. Chipewyan Tales. By Robert H. Lowie. Pp. 171-200. 1912. Price, \$.25.
- IV. (In preparation).

### Volume XI.

- I. Societies and Ceremonial Associations in the Oglala Division of the Teton Dakota. By Clark Wissler. Pp. 1-99, and 7 text figures. 1912. Price, \$.50.
- II. Dance Associations of the Eastern Dakota. By Robert H. Lowie. Pp. 101-142. 1913. Price, \$.25.
- III. Societies of the Crow, Hidatsa and Mandan Indians. By Robert H. Lowie. Pp. 143-358 and 18 text figures. 1913. Price, \$2.00.
- IV. Societies and Dance Associations of the Blackfoot Indians. By Clark Wissler. Pp. 363-460, and 29 text figures. 1913. Price, \$1.00.
- V. Dancing Societies of the Sarsi Indians. By Pliny Earle Goddard. Pp. 461-474. 1914. Price, \$.25.
- VI. Political Organization, Cults, and Ceremonies of the Plains-Ojibway and Plains-Cree Indians. By Alanson Skinner. Pp. 475-542, and 10 text figures. 1914. Price, \$.75.
- VII. (In press.)

(Continued on 3d p. of cover.)



1

ANTHROPOLOGICAL PAPERS

OF THE

87  
11

**American Museum of Natural  
History.**

Vol. XIV, Part I.

THE STEFÁNSSON-ANDERSON ARCTIC EXPEDITION  
OF THE AMERICAN MUSEUM: PRELIMINARY  
ETHNOLOGICAL REPORT.

BY

VILHJÁLMUR STEFÁNSSON.

NEW YORK:

Published by Order of the Trustees.

1914.

copy 2  
monograph

E99  
E9382

This paper is an advance section of a volume to be devoted to the observations of Mr. Vilhjálmur Stefánsson and Dr. Rudolph M. Anderson upon the Eskimo of Coronation Gulf and westward. It is the substance of Mr. Stefánsson's report to Professor Henry Fairfield Osborn, President of the American Museum of Natural History, submitted June, 1913. Upon the completion of this volume, a permanent title page with table of contents and index will be provided.

As Mr. Stefánsson is now on another expedition for the Canadian Government, he was unable to see the manuscript in its final form, or to select the illustrations; therefore for all arrangements and selections the Editor is alone responsible.

The Editor wishes to thank the Macmillan Company for permission to use the maps, illustrations, and other data in Mr. Stefánsson's, "My Life with the Eskimo"; also, for Figs. 66 and 90, from plates in the Museum Journal originally published by permission of the above.

I

PRELIMINARY ETHNOLOGICAL REPORT.

By VILHJÁLMUR STEFÁNSSON.



## CONTENTS.

	PAGE.
INTRODUCTION . . . . .	7
THE CORONATION GULF ESKIMO . . . . .	33
RANGE AND DISTRIBUTION . . . . .	33
CLIMATIC CONDITIONS . . . . .	40
DRIFTWOOD . . . . .	42
TREES AND VEGETATION . . . . .	44
FUEL . . . . .	45
FOOD . . . . .	47
Vegetable Foods . . . . .	47
Animal Foods . . . . .	48
COOKING AND HANDLING FOOD . . . . .	59
DWELLINGS AND FURNITURE . . . . .	61
HOUSEHOLD UTENSILS . . . . .	68
METHODS OF TRAVEL . . . . .	78
HUNTING IMPLEMENTS AND WEAPONS . . . . .	84
IMPLEMENTS AND TOOLS . . . . .	98
CLOTHING . . . . .	114
ORNAMENTS AND CHARMS . . . . .	121
HAIRDRESSING . . . . .	121
RELIGION . . . . .	126
GENERAL CONDITIONS OF LIFE . . . . .	129
THE MACKENZIE ESKIMO . . . . .	133
FOOD . . . . .	133
CLOTHING . . . . .	139
WORK IN SKINS . . . . .	141
MISCELLANEOUS NOTES . . . . .	151
THE MACKENZIE DELTA, 1906-7 . . . . .	151
THE COLVILLE RIVER, 1908-9 . . . . .	196
CAPE PARRY, 1909-10 . . . . .	211
CORONATION GULF AND VICTORIA ISLAND, 1910-11 . . . . .	224
THE HORTON RIVER, 1911-12 . . . . .	305
TO POINT BARROW, 1912 . . . . .	379

## ILLUSTRATIONS.

## TEXT FIGURES.

	PAGE.
1. Probes for Seal Holes, made of Bone, Coronation Gulf . . . . .	49
2. Seal Indicator of Ivory, Prince Albert Sound, Victoria Island . . . . .	49
3. Seal Indicator of Ivory, Coronation Gulf . . . . .	49
4. Copper Probe for Seal Holes, Prince Albert Sound, Victoria Island . . . . .	50
5. Pull for Cord used in Hauling Seals, Prince Albert Sound, Victoria Island.	50
6. Seal Harpoon from Mouth of the Coppermine, Coronation Gulf . . . . .	53
7. Set of Seal Wound Pegs, Coronation Gulf . . . . .	53
8. Stone Lamps . . . . .	69
9. Stone Kettle from about three miles off Parry Peninsula . . . . .	70
10. Large Lamp and a Kettle from Prince Albert Sound, Victoria Island . . . . .	71
11. Models of Vessels, Coronation Gulf . . . . .	72
12. Model of a Horn Spoon, Coronation Gulf . . . . .	72
13. Wooden Pail with Bail of Horn and Copper Rivets, Coronation Gulf . . . . .	72
14. Small Spoon of Musk-ox Horn, Coronation Gulf . . . . .	72
15. Fork made from the Metacarpal Bone of a Musk-ox, Coronation Gulf . . . . .	73
16. Horn Spoon with Bone Handle, Coronation Gulf . . . . .	73
17. Horn Dipper, Coronation Gulf . . . . .	73
18. Models of Buckets, Coronation Gulf . . . . .	74
19. Bag for Fire-making Implements, Coronation Gulf . . . . .	74
20. Bag of Moss for Tinder, Coronation Gulf . . . . .	75
21. Frame for drying Clothes, Coronation Gulf . . . . .	75
22. Blubber Pounder of Musk-ox Horn, Coronation Gulf . . . . .	76
23. Dipper of Musk-ox Horn, Coronation Gulf . . . . .	76
24. Wooden Ware, Coronation Gulf . . . . .	77
25. Wooden Snow Goggles, Coronation Gulf . . . . .	80
26. Copper Fish Hook and Reel, Coronation Gulf . . . . .	82
27. Three-pronged Fish Spear with Copper Prongs, Coronation Gulf . . . . .	83
28. Copper Fish Hook and Line, Coronation Gulf . . . . .	83
29. Copper Pole Hook. From the Pallirmiut, mouth of Rae River, Corona- tion Gulf . . . . .	85
30. Bow, Prince Albert Sound, Victoria Island . . . . .	86
31. Bow Case, Prince Albert Sound, Victoria Island . . . . .	87
32. Types of Copper Arrow-Heads from the same Quiver as Fig. 34, Corona- tion Gulf . . . . .	88
33. Bone and Ivory Arrow-Heads from the same Quiver, Kent Peninsula . . . . .	89
34. Iron and Bone Arrow-Heads from the same Quiver as Fig. 32, Corona- tion Gulf . . . . .	91
35. Copper Arrow-Heads selected from a single Quiver, Prince Albert Sound, Victoria Island . . . . .	91
36. Forms of Metal Arrow Points . . . . .	93
37. Splices for Arrow-Shafts, Prince Albert Sound, Coronation Gulf . . . . .	93
38. Form of Splice used in Spear and Harpoon Shafts, Coronation Gulf . . . . .	93

	PAGE.
39. Contents of the Tool Bag attached to Bow Case, 60-6939, Kent Peninsula . . . . .	94
40. Shaft Straightener, Coronation Gulf . . . . .	95
41. Feathers for Arrows and Bag for the same, Kent Peninsula . . . . .	95
42. Bone Thumb Guards, Kent Peninsula . . . . .	97
43. General Form of the Ulu . . . . .	98
44. Ulus with Iron Blades . . . . .	99
45. General Form of Knife found West of Coronation Gulf . . . . .	100
46. Copper Knife with Caribou Antler Handle, Mouth of Rae River, Coronation Gulf . . . . .	100
47. Steel Knife with a Bone Handle . . . . .	100
48. Copper Knife with Bone Handle, Basil Hall Bay, Coronation Gulf . . . . .	100
49. Steel Knives . . . . .	101
50. Crooked Blade Knives, Coronation Gulf . . . . .	104
51. Crooked Blade Knives of Iron, Coronation Gulf . . . . .	105
52. Tool Bag and Contents, Coronation Gulf . . . . .	106
53. Knife Sharpener, Bone Handle with Steel Insert, Coronation Gulf . . . . .	107
54. Small Knives or Graver's Tools, Coronation Gulf . . . . .	107
55. Saws, Coronation Gulf . . . . .	107
56. Adze Head, Iron Blade, Antler Haft, Pallirmiut . . . . .	108
57. Whetstone from Coronation Gulf . . . . .	108
58. Piece of Worked Copper from Rae River . . . . .	108
59. Wooden Snow Shovel, Edged with Ivory, Coronation Gulf . . . . .	109
60. Bowdrill Set from Coronation Gulf . . . . .	109
61. Snow Knives made of Bone, Coronation Gulf . . . . .	110
62. Bone Pin from Prince Albert Sound, Victoria Island . . . . .	110
63. Bone Pegs from Coronation Gulf . . . . .	110
64. A Sinew Stretcher, Knot Opener, and Awl from Coronation Gulf . . . . .	111
65. Decorated Toggles from Prince Albert Sound, Victoria Island . . . . .	111
66. Prince Albert Sound Man in Winter Costume; (b) Victoria Island Costume . . . . .	114
67. Group of Prince Albert Sound Men . . . . .	115
68. Woman's Boots, Coronation Gulf . . . . .	116
69. Shoe of Sealskin, Coronation Gulf . . . . .	116
70. Pattern for the Hood to a Woman's Coat, Fig. 71 . . . . .	118
71. Patterns for Front and Back of Woman's Coat, Coronation Gulf . . . . .	118
72. Sleeve Pattern, upper and under, for Fig. 71 . . . . .	119
73. Skin Scraper with Copper Blade and Bear Tooth Toggle, Coronation Gulf . . . . .	120
74. Skin Scrapers from Coronation Gulf . . . . .	120
75. Awls of Bone from Coronation Gulf . . . . .	122
76. Steel Knife with Bone Handle, Coronation Gulf . . . . .	122
77. Scissors with Bone Handles and Iron Blades, Coronation Gulf . . . . .	122
78. Needle Case and Attachments, Coronation Gulf . . . . .	123
79. Tool for working Sinew, Coronation Gulf . . . . .	123
80. Guard made of Bone, Coronation Gulf . . . . .	123
81. Copper Needles from Victoria Island . . . . .	123
82. Cup-and-Ball Game, Coronation Gulf . . . . .	124

	PAGE.
83. Needle Cases, Combs, and a Coat Ornament . . . . .	124
84. Cup-and-Ball Game, Coronation Gulf . . . . .	125
85. Drum from Twenty Miles west of Gray's Bay, Coronation Gulf . . . . .	125
86. Steel Knife, Mackenzie River . . . . .	134
87. Plan of a House . . . . .	158
88. Plan of a House at Shingle Point . . . . .	159
89. Ruins at Point Atkinson . . . . .	298
90. Ancient Stone House, Simpson Bay, Victoria Island . . . . .	298
91. Kitchens of Summer Camps, East Edge of Mackenzie Delta . . . . .	299
92. Tent Frame, Langton Bay . . . . .	299
93. Plan of a Caribou Drive, Point Barrow . . . . .	385
94. The Caribou Snare . . . . .	386
95. The Hoop Game, Upper Colville River . . . . .	391

## MAPS.

Map showing the Distribution of the Eskimo between Point Barrow and Cape Bathurst . . . . .	11
Map showing the Distribution of the Coronation Gulf Eskimo . . . . .	32



## INTRODUCTION.

The district traversed by either Dr. Anderson or myself, singly or both of us together, between our reaching the mouth of the Mackenzie River in July, 1908, to our leaving the Arctic in September, 1912, is chiefly a stretch of the north shore of the North American continent, although we penetrated some distance inland on the Colville River in Alaska, in the Endicott Mountains on the Horton River, and on the Coppermine. We also visited Victoria Island and a score or more of the islands of Coronation Gulf; Banks Island we saw only from shipboard. In Alaska the westernmost point visited by sled in winter by members of our expedition was Icy Cape although by water we also visited Cape Lisburne and Point Hope.<sup>1</sup>

The northern portion of Alaska is in general a low alluvial plain, rolling in some places, as level as a Dakota prairie in others, and everywhere covered by grass and moss in summer. There are many rivers, mostly sluggish, and therefore of an apparent size greater than justified by the volume of water they discharge. None of these, with the exception of a portion of the Colville, are represented on published maps with even an approximation of correctness, and some of the largest, such as the one falling into the foot of Smith Bay are unindicated on any chart known to me. The coastal plain is triangular in shape with its apex at Point Barrow and its base formed by a mountain range extending approximately straight from the point where it meets the sea at Cape Lisburne, Alaska, to where it again approaches within twenty miles of the ocean at the international boundary line on meridian 141 west. Just east of the Colville River we hunted nearly to the foothills of this mountain range and judge the distance from it to the sea to be about one hundred miles. At Point Barrow the mountains are probably nearly two hundred miles inland.

In general, all the larger rivers and even some of the smaller ones are well supplied with willow for fuel. On the Ikpikpuk, for instance, and on the Colville, these willows grow to a diameter of three or four inches and to a height of over twenty feet in some cases. Willows of this size, however, are found only at a distance of twenty or more miles from the coast. Apparently the cool winds that blow off the ice-filled ocean in summer tend to

---

<sup>1</sup> A full narrative of our journeys has been published in "My Life with the Eskimo." This report, therefore, gives more particularly the substance of our anthropological observations, but does not duplicate much of the concrete matter in the book, it being taken for granted that the reader is already familiar with the contents of that volume. Most of the important photographs were also reproduced in the book, making them unnecessary in this report.

dwarf tree growth. As most of these rivers are also well stocked with fish and frequented in winter by ptarmigan their shrub-clad valleys were the homes of large bands of Eskimo until the disappearance of the caribou, to which the fish and ptarmigan are only of secondary importance, drove to the coast the small remnant of these people that had not been exterminated by measles and other contagious diseases brought in by white men.

The country itself being a low plain, it follows that the coast line is low, although there are in some places sea cliffs to the height of thirty or forty feet. The villages were strung along this coast and were built in locations determined by the food-gathering habits of the people. Between Point Hope and Point Barrow, the bowhead whale was of paramount importance. A village might therefore be located almost anywhere where the ice conditions in spring allowed the whales to approach within five miles or less from shore in an ordinary year. Next to the whale, the seal was the most important item at Point Barrow and even farther south, although the walrus increased in importance west of Icy Cape.

Everywhere along this coast were strewn huge quantities of driftwood, derived probably in the main from the Yukon River, at least on the coast section west of Point Barrow. East of Point Barrow, I am inclined to think the Mackenzie River is to be credited with the larger amount of driftwood. There is a fairly steady current from the southwest along the coast to Point Barrow and this would bring wood even against the prevailing northeasterly winds, but at Point Barrow this current continues its course off shore and would therefore be ineffective in bringing wood to regions farther east. On the other hand, the prevailing winds between Flaxman Island and Point Barrow are northeasterly and these would bring driftwood as far up as the apex of Alaska.

In former times, villages were not located with any reference to the amount of driftwood, for wood was not used to any extent in winter for fuel, but only seal oil, which furnishes a much more satisfactory method of heating houses of the Eskimo style than any that could have been devised in the days antedating the importation of white men's stoves. When these stoves began to come in, however, and when the Eskimo began to live in flimsy frame houses into which the cold penetrated by induction, driftwood had to be used for fuel and the apparently inexhaustible deposits of driftwood gathered by the winds and tides, for centuries disappeared in a few years. Now the entire coast from Point Hope to Point Barrow may be considered devoid of wood that can be used for fuel, and as the modern houses are unsuited for heating with oil, the people are facing a serious fuel problem of which the local coal mines are the only solution, although an unsatisfactory one, and the supply of coal will therefore in the future have a con-

siderable influence on the locations of the habitations of the people. The two chief coal mines are at Cape Lisburne and Wainwright Inlet, although coal is found in other places.

It appears that east of Point Barrow, on the way to Herschel Island, the food supply has always been more uncertain than it was on the coast west of Point Barrow. We found no indication that there had been large permanent villages anywhere on this stretch, except on the Jones Islands just east of the Colville Delta. One hundred years ago there was, however, no doubt, a fair sprinkling of houses in groups of two or three or half a dozen, probably throughout all these four hundred miles of coast. We know that within the memory of the oldest men now living, it was common that trading parties from either Herschel Island on the east or Point Barrow on the west would be overtaken by winter somewhere between these two locations and would build their houses and stay until spring at any one of a dozen or more places considered suitable for winter.

At Barter Island, about one hundred twenty-five miles east of the Colville, was one of the largest trading rendezvous and the indications are that every now and then some of the traders spent the winter there as well as the summer. Another large trading center was Nirlik, on one of the alluvial islands of the western part of the Colville Delta; but although there were hundreds gathered there in summer, no one seems ever to have wintered in that vicinity; in fact, the region is self-evidently unsuited to a hunting population in winter.

Going upstream, the first recognized wintering place is Itkilikpa, or as the name implies, the mouth of the river Itkilik, which empties from the east into the head of the Colville Delta. This river rises in the mountains to the south and is said to be the only branch of the Colville upon which coniferous trees are found and that only near its head. The mouth of this river was the site of our camp for a portion of the winter 1908-1909. There is excellent fishing in the autumn and several varieties of fish can be caught there in some number all winter. Now that the caribou are no longer numerous in the country, this is about the only place on the Colville which seems to have food supplies enough to make wintering safe.

While the number of recognized wintering places on the Colville and its tributaries is very large, the people of the Colville above the mouth of the Itkilik are by themselves considered to form three groups: the Kagmalirmiut who centered about the Kagmallik branch of the Colville; Killinermiut of the Killirk River; and the Kañianermiut, who, as the name signifies, occupied the headwaters of the Colville. Occasionally also, you hear the name Kupigmiut, the people of the Kupik, which is the name applied to the lower section of the Colville River above the Delta. The reason why this

name has not the same recognized standing as the other three as a designation of a group of people, seems to be that the population of the Kupik section of the river was more transient than that of the other sections and consisted, in fact, of people all of whom would fall under one of the other three designations.

The people of the Upper Colville associated on terms of intimacy with the Noatagmiut of the Upper Noatak and the Napaktogmiut and other groups of the Lower Noatak River as well as the Kuvugmiut of the Upper Kuvuk, and a good many families of the Colville people went annually to the trading rendezvous in Kotzebue Sound where they obtained Asiatic and other wares. North of the Kañianermiut was what seems to have been the largest of all the inland tribes, the Oturkagmiut, who occupied the country between the head of the Colville and the seacoast at Icy Cape and Wainwright Inlet. Some members of this tribe were recognized as land dwellers and are said to have been the only people of Alaska who understood the use of heather for fuel in winter, and were therefore independent alike of the coast where the sea dwellers secured blubber or wood for fuel and of the inland valleys where the land dwellers got the willow they burned in open fireplaces. They obtained their seal oil for food and light as well as other coast products by purchase in exchange for caribou skins and Kotzebue Sound wares chiefly, while others went down to the coast each spring to do their own seal, walrus, and whale hunting. Others still, while recognized as members of the Oturkagmiut tribe, seem to have been fairly constant inhabitants of the coast.

Circled in by these larger tribes, there were near the head of the Colville River, the Nunatagmiut, a small group that seems to be now nearly extinct. For some reason the white men and coastal Eskimo alike, have seized upon the name of this tribe as the name for all the inland dwellers. I have always been curious to find one of them, but have never succeeded in doing so, although I have been told by some old Oturkagmiut men that there are three persons still living to their knowledge who belong to this group.

It seems fairly clear that the name of this smallest of all these inland tribes became recognized on the coast as the name for them all because they were centrally located. From the point of view of the Barrow people, the Nunatagmiut were south of the Oturkagmiut; looked at from Kotzebue Sound, they were north of the Noatagmiut; from the point of view of the traders who met in the Colville Delta, the Nunatagmiut were farther upstream next beyond the Kañianermiut. The people of the north coast knew the name of no tribe farther south than the Nunatagmiut. The people of Kotzebue Sound knew the name of no tribe farther north than the Nunatagmiut. For each of these sections of the country, therefore, Nuna-

TOVI  
DE SITA



W AN.

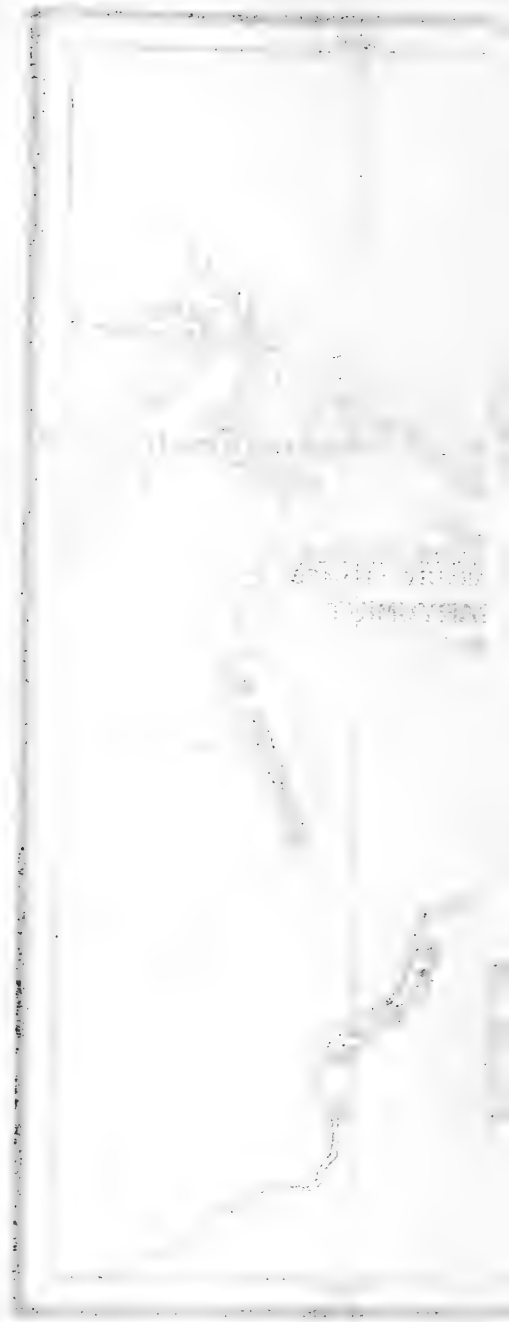



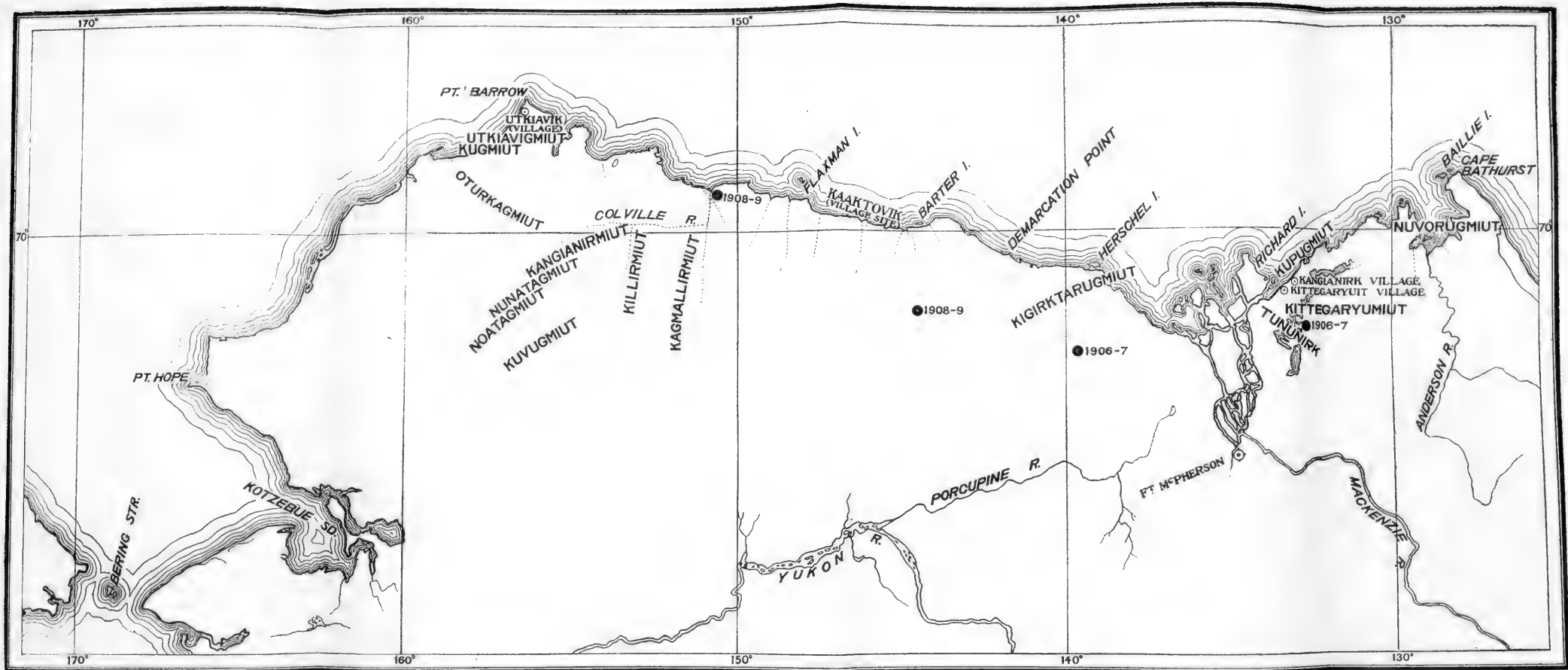

DISTRIBUTION OF THE ESKIMO BETWEEN POINT BARROW AND CAPE BATHURST.

● Winter Camps of the Author.





tagmiut became the indefinite name that covered the people next beyond those who were personally known to the speakers, and thus the word obtained a comprehensiveness of meaning on the seacoast which it never had among the inlanders themselves. Now you find it in census reports and works of ethnology. In the summer of 1912 a group of old men in consultation at Cape Smythe agreed on the following list of peoples who formerly inhabited the coast between Point Barrow and Point Hope. Most of the groups are still represented by some living individuals: —

1. Nuvugmiut (Pt. Barrow).
2. Utkiavigmiut (Cape Smythe).
3. Pinasugrugmiut (Beta Point, Belcher, and Pt. Franklin).
4. Atanirk (Atanirrmuit).
5. Sinarumiut or Uallinergmiut.
6. Nunariagmiut.
7. Kugmiut (Kungmiut) (Wainwright Inlet).
8. Kilavitarvingmiut.
9. Miliktarvik (Ugrug sealing place).
10. Nokolik.
11. Kaiakseravigmiut (Icy Cape, the village used to be on the mainland, now it is on sandspit).
12. Akearonat.
13. Uivarmuiut.
14. Tigiragmiut (Pt. Hope).

East of Point Barrow all the way to Herschel Island, there seem to have been in recent times no groups of people that had their separate names, although of course each would be designated any year by the name of the place where they happened to be encamped. This, however, is different from the names of tribes cited above, for these applied irrespective of where a man might happen to be at any particular time.

Roughly, the limits of the Mackenzie Eskimo are, Herschel Island on the west and Cape Bathurst or the Baillie Islands on the east. There were, however, settlements of these same people as far west as the international boundary line or a little beyond, but although I have known of men who lived in these settlements several years at a time, they do not seem to have had a really permanent character.

East of Cape Bathurst there was also a continuous line of settlements as far as Langton Bay probably up to 1840 and a little after. It is true that from an archaeological point of view, it seems fairly clear that the coast for more than one hundred miles farther east still, was occupied by people of a cultural affinity with the Mackenzie group; but the feeling of the Baillie

Islanders themselves is, that the people farther east than Langton Bay were not of their kind.

At Herschel Island the mountains approach within twenty or so miles of the coast and rolling low foothills come nearly down to the sea. The island itself is of irregular shape; its greatest diameters, if no reference be taken to the sandspits, are about eight by five miles. The island is about five hundred feet above sea level at its highest, is tundra-covered and of a clearly alluvial structure, for huge trees similar to those found as driftwood on the beach today may be seen sticking out of the seaward precipices of the island three hundred feet above tide level. The land at the foot of the bay between Herschel Island and Cape Point is low but there are high bluffs in many places from Cape Point east to Escape Reef, which may be considered the western limit of the Mackenzie Delta proper, although in ordinary conditions of weather the sea water is fresh at King Point, twenty-five miles farther to the west. The delta of the Mackenzie is much like the deltas of the other great rivers of the world. It is over one hundred miles wide, filled with a multitude of low willow-covered and driftwood-strewn islands between which channels of unknown number flow northward into the polar sea. The huge volume of fresh water in the spring (the river usually opens between the fifth and twenty-fifth of May) not only melts away the sea ice, but also by its current drives away any that happens to be floating about, so that none but the strongest ones from seaward can fill the immediate vicinity of the delta with ice. The volume of fresh water is so large, that the whaling ships in passing outside of Mackenzie Bay take water for cooking and drinking purposes that has not a taint of brackishness even where land is not in sight from the masthead.

There are everywhere in the neighborhood of the Mackenzie, windrows of driftwood, thousands of cords to the mile in many places, and the most northerly growing spruce are found near the center of the delta at the limit of tidewater or even north of it. In this connection, it is interesting to point out that the tide proper ranges less than a foot and is scarcely ever noted by the natives, but a strong westerly wind will cause a "storm tide" that rises some six feet above the low level, produced by an easterly gale. At such places as Herschel Island it is often possible to foretell many hours in advance the coming of a west wind by the rise of the sea.

One hundred years ago the territory definitely possessed by the Eskimo, as opposed to the Loucheux Indians, may be considered to have extended to the head of the Mackenzie Delta; in the vicinity of the Eskimo Lakes, it extended somewhat farther south. Had white men not come in just when they did, it seems likely that the Eskimo would have spread farther upstream for their relation to the Indians was an aggressive one. Their own

memory as well as that of the Indians established the fact, which is also confirmed by the records of Franklin's and Richardson's expeditions, that they used to make armed expeditions as far upstream as two hundred miles beyond the head of the delta. These expeditions seem to have been for the purpose of obtaining stone for knives and missile points from the deposits at the foot of the cliffs and the Fort Good Hope ramparts. Even after one hundred years the Good Hope Indians are in such fear of the Eskimo that they do not dare to build fires or to camp openly on the Mackenzie River in the summer time, except immediately around the trading posts, and in the old days they seem to have entirely abandoned the river at the time the Eskimo were expected, not returning to it until the time the Eskimo were known to have returned to the sea.

It seems there were semi-friendly relations occasionally with the Loucheux Indians near the mouth of the Peel River. There are traditions of the employment of a trading method, consisting of suspending in trees or leaving in a pile on the ground, articles for the Indians to take. The Indians were expected to and did in fact, leave other articles in exchange. Parties also came into actual contact occasionally, but only for a few hours at a time, for neither trusted the other and even after the establishment of the Hudson Bay Company at Fort McPherson, there were cases when the suspended hostility of these meetings broke into open feud and killings took place. Between the Loucheux and the Eskimo there is no tradition of anything like formal hostile expeditions of one against the other, but as noted above we have definite accounts of organized expeditions into the country of the Good Hope Indians, not real war expeditions it is true, but still expeditions made in force with a show of arms and with no secrecy. The Indians of Good Hope tell that the Eskimo used to come in singing and shouting boatloads. They do not appear to have made incursions into the forest in search of Indians to kill or to plunder. On the other hand, they were so confident in their numbers and strength that they evidently feared no attack.

East of the Mackenzie River all the way to the Anderson, the country is in general low and flat with few or no exposures of rock *in situ*. In the Anderson, spruce trees come within a few miles of the ocean and on the Eskimo Lakes they extend up to the middle of the three lakes. If a line be drawn from the southern end of the Eskimo Lakes east to the Anderson River about ten miles from the sea, it will approximately mark the northern boundary of the forest north of which there is low and level tundra interspersed with many lakes. All this was in former years excellent caribou country and until the coming of white men, they were killed in large numbers both inland and on the seacoast as well as on Richard Island.

Richard Island on the eastern edge of the Mackenzie Delta is apparently of alluvial formation and is probably of about the same height as Herschel Island although of a much greater area. This is the only island of the delta proper north of the tree line that seems to have been permanently occupied, although parties engaged in egging and fowling frequented the low islands to the west of Richard Island in early and middle summer. The settlements on Richard Island were chiefly on the east coast, facing the mainland and the main occupation as well as that of the mainland people opposite, was the hunting of the beluga, or white whale.

Seals were not hunted to any great extent by any of the people between Escape Reef on the west and Warren Point on the east. The first village of real sealers was that at Point Atkinson, called Nuvorak. A few white whales were occasionally caught in summer and sometimes a single family or two might go west to Kittegaryuit and join in a white whale hunt, although these seem to have been rare occurrences. The Nuvorugmiut hunted caribou towards the foot of Liverpool Bay and also spent part of the autumn there annually in fishing.

Cape Bathurst is a low peninsula nearly cut in two (much more nearly than the charts indicate) by Harrowby Bay. On the eastern or Franklin Bay side, the coast line of the peninsula begins to rise higher after one goes half way to the mouth of Horton River and the sea face rises into steep cliffs that are known as the Smoking Mountains, from the fact that smoke issues from them in various places apparently on account of the existence, deep below the surface, of deposits of coal that have been afire since immemorial times.

Driftwood is very scarce between the tip of Cape Bathurst and Horton River on account of the absence of suitable beaches for it to lodge upon. Horton River has a much smaller delta than would be expected from the size of the river, which we found to be as large as the Coppermine in appearance, although the volume of water it discharges may not be so great. Upon exploration during the winter of 1910-1911, we found this river to come from the southeast. Crossing over from the northeast end of Great Bear Lake from the mouth of Dease River, we took a course northwest true and struck the Horton River some forty miles from the lake. At that point it is already a stream of considerable size coming from the east, and it is likely it may head not far from Dismal Lake and the length of it from its head to the sea is therefore probably over five hundred miles, as measured along the curves of the river. The main branch apparently rises in Barren Ground and flows through a treeless country for one hundred miles or more, but from a point some forty-five miles northwest of the northeast corner of Great Bear Lake, to a point about half way between the mouth of Horton

River and Langton Bay, and about ten miles from the seacoast, there is a continuous fringe of trees which in most places are confined to the valley, although in some parts they spread up over the high land as much as ten miles east of the river. Some thirty miles south of Langton Bay the forest seems to be continuous; west from the Coppermine River to the Anderson, but further south again where the land gets higher, a district of Barren Ground separates these two rivers.

The Indians of Great Bear Lake seem to have regularly hunted north to the headwaters of Horton River, and those of the vicinity of Fort Good Hope hunted on its lower course, and since the days of the Hudson Bay Company, at least, made journeys across the river into the Barren Ground in search of musk-oxen. We have found ancient Indian lodges, the remains of their hunting campfires, within fifteen or twenty miles south of Langton Bay.

In this district the Eskimo occupation seems to have somewhat overlapped that of the Indian, principally in the way in which a similar overlapping takes place in the Coppermine region; for the country that is occupied by the Eskimo in summer during the caribou hunting, will be vacated by them in winter while they are sealing off on the sea ice and this gives the Indians a chance to make a winter hunting ground of the districts occupied by the Eskimo in summer. An old woman, Panigiok, who was born at Langton Bay and is still living at the Bell Island told us that there used to be Eskimo families living on the Barren Ground some fifteen miles southeast of Langton Bay near Horton River who never came to the sea except on short visits and who purchased seal blubber from the coast people, exactly as the inlanders of Alaska did at such places as Point Barrow.

There was semi-friendly contact, apparently with considerable frequency, between the various groups of Eskimo that hunted to the foot of Liverpool Bay and the head of Anderson River, and the Hare or other Indians of Fort Good Hope. Murders seem to have been frequent on both sides and captives were carried off by both, but occasionally marriages were voluntarily arranged, the woman going to the people of her husband. This is said to have taken place with about equal frequency on both sides. At present there is no Indian woman living with the Eskimo, but one Eskimo woman to my knowledge is now with the Indians, having been transferred to them by her foster parents while she was a child.

East of Horton River begin the Melville Mountains which extend thence eastward parallel to the coast until they break up into isolated hills and disappear in the generally high land towards the west side of Coronation Gulf. From Langton Bay west for fifty miles or so, they have the character

of a coast range which bars the way to the ocean against the Horton River which, through this stretch, has to flow about parallel to the coast until an opening to the sea is secured at the west end of the mountains. Two miles or so west of Langton Bay, it is only perhaps a mile and a half from the ocean to the top of the mountains. From here east for some distance they have the character of the seaward face of a plateau; looked at from seaward you have mountains of a height of about 1500 feet, but when you climb to the top of them you find yourself on a plateau that slopes almost imperceptibly southward to the Horton River ten or fifteen miles away.

The Parry Peninsula is high and rocky towards its north end and so cut up by fjords that it comes near being a group of islands instead of a peninsula. There is in fact more than one place where a stone can be thrown from the waters of one fjord to those of the next. The hills which form the north end of the peninsula rise to a height of two or three hundred feet, and from their tops in clear weather one can plainly see Banks Island sixty miles to the north, for the two thousand feet high hills immediately back of Nelson Head are well above the horizon.

The Booth Islands lie six or eight miles off shore west from the tip of Cape Parry and consist of two small islands and some isolated rocks. Both these islands as well as the mainland of Cape Parry were in former times the site of numerous villages of people who no doubt lived chiefly by sealing, but also partly by bowhead whaling. These were too, no doubt, the occupations of the people all around the shore of Franklin Bay as is shown by the fact that bones of whales abound on the beach near the village sites and have been used in the construction of many of the houses.

Near the foot of Cape Parry on the Franklin Bay side are numerous good fishing places, both in the sea and in the lakes that form a chain towards Darnley Bay. Through these lakes runs a river, the mouth of which is back of Point Stevens. In early summer this river with its system of lakes, furnishes a portage route for a boat drawing not more than a foot or eighteen inches of water to within about half a mile of Darnley Bay, while the total distance from Langton Bay to Darnley Bay is about twenty miles. Although the tip of Cape Parry is high and rocky, as before stated, the neck of the peninsula along the foot of the Melville Mountains is in general low and flat, though there are some groups of rolling hills. In one place, surrounded by large areas of level marsh tundra, is a volcano-shaped hill, about one hundred fifty feet high with a small lake in its crater.

The bottom of Darnley Bay has never been mapped. We found two hitherto unnamed rivers of considerable size flowing one into its southeast corner and the other into its east side some ten miles farther north. From the Bay south, it is but a day's journey to trees on a big branch of the Horton

River that heads in some lakes in the vicinity. Cape Lyon is a rocky promontory where the coast turns a sharper angle than I have seen anywhere else. There is a change in direction of the coast line of more than a right angle in the space of half a dozen yards. Here there is the most westerly gull rookery that I have seen, although I suspect there may be some in the rocks found near the coast of Cape Parry, but which I have never had occasion to pass in the summer time. From here on east to Coronation Gulf, as well as in parts of Victoria Island, these rookeries are found at greater or less distances apart wherever there are suitable cliffs. They are not so extensive in any place, however, that they can ever have formed a considerable part of the food supply of the people at the time the coast was inhabited. The species found here is chiefly the glaucous gull.

On our way eastward from Cape Lyon we made a discovery of some possible importance to future navigators: we found an apparently excellent ship harbor in the tip of Point Pierce. Point Pierce is a high promontory, its two hundred foot cliff of stratified limestone being the highest and most picturesque that I have seen on the entire Arctic coast. Just east of this cliff, between it and a sandspit which connects a series of granitic knolls, there is a harbor evidently deep, for there were big cakes of ice inside it, and sheltered from all winds. Continuing east from here, we found but two more ship shelters on the way to Coronation Gulf. The first is at Point Keats which is T-shaped so that a vessel can get shelter on one side or the other from any wind that blows, or so it seems, although this is apparently a fairly dangerous coast and there may be hidden reefs in the neighborhood, for there was no heavy ice near to give us an indication of the depth of water. The other harbor is behind a little island on the mainland shore of Dolphin and Union Straits and is so difficult to find that I doubt that I myself could locate it again, except by the compass bearings. From the west end of the island which shelters the harbor, I found the west end of Sutton Island bears west  $338^{\circ} 30'$  and the east end of Sutton Island  $1^{\circ}$ . This is certainly a good boat harbor and a very good one for ships, if it proves deep enough. In general, the coast line between Cape Lyon and Coronation Gulf is high with cliffs here and there usually of limestone, although there are some sandstone formations.

It was at Cape Lyon that Richardson saw the most easterly house of earth and wood and he therefore concluded that this was the eastern limit of the whale-hunting people who dwelt in permanent villages. This was by no means the most easterly village, however. It was merely Dr. Richardson's method of travel which prevented him from finding similar villages or the ruins of them farther east. He stood along in boats well off shore usually, and had not the same chance of finding what human remains there

are on the beach that we did through our method of sled travel, although of course even to us many things self-evident in summer may have been hidden by snow. We found the ruins of earth and wood villages, however, as far east as the west side of the delta of Crocker River, and in many places along the beach between there and Cape Lyon we found such quantities of the bones of whales that we were convinced whaling must have been one of the industries of this entire district.

Along this coast as far east as Crocker River the Melville Mountains run approximately parallel to the coast, from three to ten miles inland. In some cases the foothills proper come right to the coast, in others there are stretches of comparatively low although rocky and hilly country. Between Crocker River and Inman River the mountains get farther from the coast and apparently lower. Richardson estimates the Melville Mountains in general to be about five hundred feet high, but I found, in the spring of 1911, that standing at sea level at Bell Island near the southwest corner of Victoria Island, I could see the mountains on the mainland up to Point De Witt Clinton, and even there it was apparently rather a fog or clouds that obstructed the view down, after the mountains ran properly below the horizon. This means that the Melville Mountains should be not five hundred feet in height, but anything between fifteen hundred and two thousand feet.

On his first journey along this coast, our only predecessor, Sir John Richardson, saw to seaward near the mouth of Crocker River, what he considered an island lying about twelve miles off shore. He named this Clerk Island. On his second voyage in 1848, apparently Sir John did not see Clerk Island. No one else has traversed the coast, but both Collinson and Amundsen passed at a considerable distance out to sea and neither of them saw the island. In the spring of 1910, we were fortunate in the neighborhood of Crocker River, in having in general clear weather and with my field glasses I used to climb high hills near the coast every few miles and look to seaward hoping to see the island. Had there been an Eskimo village twelve miles to seaward where the island was supposed to lie, I should have been able to see it; but there was no sign of anything but sea ice. In the spring of 1911 we crossed by sled in a direct line from Bell Island for Point Tinney. This should have taken us across the corner of Clerk Island as it is plotted on our charts and again we saw no signs of it. I think it is clear, therefore, that either Clerk Island does not exist or else it is at some place remote from that laid down by Richardson.

Driftwood gets gradually scarcer as one goes east along the coast, although from the point of view of a traveling party that needs wood for fuel there is plenty to Cape Bexley and even beyond. There are few places where you can travel five miles at a stretch without finding a deposit of



driftwood sufficient to supply a camp for a week. The sticks you find, however, get smaller as you proceed east and more waterworn. They are excellent for firewood, however, as they are dry through lying on a rocky beach. Only in the mouths of rivers, such as Inman River, did we have some trouble with wet and rotten wood where it was imbedded in sand or river mud.

Although they have knowledge of the coast farther west, it is not probable that any of the Copper Eskimo go west beyond Crocker River. We saw signs of ancient occupation in the form of broken sleds and split sticks of driftwood all along the coast, but fresh signs (ones not over three or four years old) we did not find until we reached Point Wise.

It may be considered roughly that the territory of the mainland occupied by the Copper Eskimo is bounded on the west by the 118th meridian from the coast to where it intersects Dease River. The line of the extreme boundary will run a little west of south, thence to McTavish Bay of Bear Lake and from the east end of that Bay, straight east to the Coppermine River. It will probably continue about straight east from there until it reaches the longitude of Bathurst Inlet after which it will run southeast to Back River and to the Akilnik.

It is better to leave the eastern limit of these people undefined until our information shall become more complete than it is up to the present, but we can safely discuss their northward range. As stated elsewhere, they occupy regularly only the southeast coast of Banks Island east of Nelson Head. At Nelson Head the land rises rapidly to a height of at least two thousand feet two or three miles back from the beach. The south quarter of Banks Island may be considered high, although the extreme south appears to be the highest, and there is a gradual slope to the north, or at least that is what one gathers from what the Eskimo tell us, supplemented by the accounts of Collinson and M'Clure. Cape Kellett at the southwest corner of Banks Island is a long low sandspit and back of it to the eastward the land appears low. As far north on the west coast of Victoria Island as the Eskimo at present range, which need not be considered to be farther north than the latitude of  $72^{\circ}$ , the coast line is mountainous although the mountains are not very high. From the information of the Prince Albert Sound people this mountainous character is continued well into the country. We crossed the Wollaston Peninsula approximately in longitude  $113^{\circ} 30'$  west, and found it to be mountainous also all the way across. Our route was through a sort of a pass and there seemed to be higher mountains on either end. To the east there was an especially conspicuous range which had never been seen by white men before and as it appeared as a whole to have no native name, we called it the Museum Range to commemorate the connection of the

American Museum of Natural History with the expedition. From Eskimo report we learned, however, that there is a belt of low land stretching across Victoria Island approximately straight east from the foot of Prince Albert Sound to Albert Edward Bay. This strip consists of the valleys of the two rivers that are probably the largest in Victoria Island: the Kagloryuak which heads near the center of the Island and flows west into the foot of Prince Albert Sound and the Ekalluktok which heads in the same vicinity with the Kagloryuak and flows east into Albert Edward Bay. It seems from Eskimo report that the eastern half of Victoria Island is in general low. This is corroborated so far as they go by the observations of Rae, Collinson, and Lieut. Hansen of Amundsen's expedition.

The country between the 118th meridian and Coronation Gulf can scarcely be called mountainous but rather high, hilly, and rocky. There is an abundant vegetation of grasses, mosses, and lichens in the low places, but the high hill tops are in many cases barren on account of their rocky character. There are some rivers of size, but the details of them are unknown to us except that we were told that Rae River heads in an oval-shaped lake, apparently about twenty miles long that lies south of Staypleton Bay which, by the way, is not nearly so deep a bay as the maps indicate. There are commonly the smallest of dwarf willows said to be found anywhere north of the Rae River, and that river itself is not well supplied, but the Richardson River which has its mouth just south of that of the Rae has, we were told, considerable growth of willows in its valley and this we verified through finding heaps of drift willow at its mouth.

The Coppermine, as elsewhere described, is well wooded. It is one of the swiftest large rivers of the world and is therefore never likely to be commercially valuable for anything except water power. It is practically a continuous rapid, but there are no real falls in it, not even the so-called Bloody Fall which is really a shelving cascade or rapid about six hundred yards long. On account of the general rocky character of the country, the valley of the Coppermine is much narrower than would be expected from the volume of water it carries, and the stream itself runs through a confined bed and is seldom over three hundred yards wide and that only in shallow places, while one hundred thirty yards may be considered its average width between Kendall River and the sea while there are many places much narrower than this. Being the swiftest of the great northern rivers, the Coppermine is also peculiar in the roughness of its ice in winter. What apparently happens is that first the river freezes over to a greater or lesser thickness of ice and then the rush of the water causes this original roof of ice to break down and cave into the water. The swift current seizes the blocks of ice and whirls them downstream until something occurs to make a

blockade and there they are heaped together on edge and in every other way while level ice again forms over the open water which has just been swept clear. A few days or weeks later another cave-in may occur where the ice lies smooth and the same process is repeated. But where a jam has once been lodged and cemented together there the ice will remain approximately unchanged all winter. As the season advances the water in the stream bed gets less and less. In many places in the Coppermine there seems to be a sort of winding secondary channel in the bed of the river proper so that towards spring there is really only a little creek running through this curved and ice-roofed water course. Eventually the roof over even this sometimes caves down, but usually only after the ice becomes so thick (say over a foot) that it does not break small and float in cakes as the younger ice did earlier in the year. The current is not so strong late in winter, with the result that this last cave-in produces pits and valleys in the river ice proper. In the centers of some of these the ice is eight or ten feet below the general level of the river in the months of March and April. In the spring when the thaws begin, it is along this channel that the melted snow water first begins to run and we found in the first week of June, 1910, that where the rest of the ice of the river was comparatively solid, this creek had commenced flowing and had eaten through the ice so that although the water had not risen sufficiently to flood the river as a whole, nevertheless a crossing could be made by sled.

The popular summer hunting district which lies between Bear Lake and the Coppermine River north of the parallel of  $66^{\circ}$  is largely Barren Ground on account of its high and rocky character, although trees of good size are found in all the creek beds round about. East of the Coppermine too, so far as we know it, the land is high and rocky and devoid of trees for the same reason.

The south shore of Coronation Gulf averages much higher than the north shore. A striking feature of the topography south of the Gulf is a series of rocky terraces. If one walks southward or southeastward over this country in foggy weather or at night one will often go up so gradual an incline that the country seems level, until suddenly one comes to precipices where it is necessary to scramble down forty to sixty feet of cliff and talus slope. If the walk be continued southward, this experience will be repeated.

Apparently the character of the bottom of Coronation Gulf is similar to the character of the land south of it. There are many times more islands than the chart indicates and these lie in chains extending from the west side of the Gulf eastward or northeastward. Most, if not all of these islands have precipices to the south or southeast and slope down gradually

to the north or northwest. There is deep water close up to their precipitous faces while from their low north ends dangerous reefs extend. There are many boulders of all kinds found on the surface of some of these islands. The islands themselves seem chiefly basaltic and the cliffs are typical columnar basalt. In a few cases we found the basaltic upper portion of the island underlain by stratified limestone.

It is of great significance to the people of this district that native copper is found in many places. I have known of a piece of copper float as large as a house-building brick picked up on the north shore of McTavish Bay, Great Bear Lake, and from here north copper is known to occur either in the form of float along the stream courses or native copper outcrop from the hillside all the way north to at least forty miles north of Prince Albert Sound in Victoria Island a distance of over three hundred miles. The western limit of copper deposits known to us is in the vicinity of Dismal Lake, while to the east it extends at least to the east shore of Bathurst Inlet. It is naturally difficult for the natives to cut the native copper where it occurs in huge masses or as an outcrop and most of the material actually used for knives and other things is picked up in the form of small fragments along the banks of the rivers. Smelting is quite unknown and nothing is ever done with the copper except to pound it with stones and to sharpen the edges of cutting tools by grinding them against rough stones.

As pointed out elsewhere another geological feature of great importance to the people is the occurrence of talc chlorite, of a character suitable for the making of pots and lamps, at the mouth of Tree River and at certain places farther east. Although wood is not used for fuel except to a slight extent in summer, the occurrence of trees on the Coppermine and the head of Dease River, draws people from great distances to these places each summer for they need wood continually for various things, and driftwood of a character suitable for implements and utensils is found only on the coast of the Gulf.

Before quitting this geographical discussion it is worth while to comment especially upon the anomalous economic importance of the Mackenzie River to all the district west of Coronation Gulf and east of Point Barrow. Not only does the huge volume of warm water temper somewhat the climate at the immediate mouth of the river and alter the seasons to a degree, but the river also supplies building material for the construction of houses for more than one thousand miles of coast and material for the construction of the framework of boats and for all the smaller wooden things that the Eskimo need. Most of this wood comes from the Liard branch of the Mackenzie River. Although a great river, the Liard does not bring down as much driftwood as does the Peace or the Slave and it is possible that even

the Athabaska River may carry as much wood as does the Liard: but unfortunately practically all the wood brought by the Athabaska is stranded in Athabaska Lake and all the wood brought by the Peace and Slave is deposited on the shores of Great Slave Lake. On neither of these lakes is the driftwood of any considerable economic importance while on the Arctic coast it would be of incalculable value to the Eskimo, should they survive for any considerable period, or to the white men, should numbers of them ever come to occupy the coast.

In the region of the Mackenzie Delta there were a large number of permanently inhabited village sites. By permanent habitation, however, we mean only that there were houses at these places which were occupied regularly year after year at corresponding seasons for a month or more at a time. The most important of the western settlements was that one of the three on Herschel Island which was called Kigirktoyuk. This name was sometimes even in the old days applied to the island as a whole, and now that the other two village sites on the island have been abandoned, the name for the village has become synonymous for that of the island. Between Herschel Island and the Mackenzie River were several village sites, the most important of which seem to have been Kingak near King Point and Tapkark on the Shingle Point sandspit.

It is true of all Eskimo tribes that they use for distant tribes other names than those which really belong to those tribes. From the point of view of the Kittingaryuit people, for instance, the people west of the Mackenzie River to and a little beyond Herschel Island were known as the Tuyormiut. The people of Point Barrow and Cape Smythe who were called by themselves the Nuvúgmiut and Utkiavigmiut were called by the Kittingaryuit people collectively Apkvarmiut. All other western people were grouped collectively under the term Nunatagmiut.

Two names that may be used anywhere for one's neighbors up or down the coast were therefore naturally in use in the Mackenzie section. These are Uallinergmiut, the people up the coast, and Kagmalit, the people down the coast. It is an interesting fact that whereas in going west along the mainland coast from Baillie Island west the next people may always be called Uallinergmiut while the next people east are Kagmalit, but to this rule there is one striking exception, the people of the Colville River although living south and east of Point Barrow always spoke of the Barrow people as Kagmalit. This is what one would expect had the Colville people first become familiar with the Barrow people at the time when the Colville tribe were living on the seacoast to the west of Cape Smythe. This is what would have happened had Alaska been peopled by a migration from the east along the coast which had followed the shore around until it got to Kotzebue Sound and had then sent a branch up the Noatak and back down the Colville.

From the point of view of the Mackenzie people, the Baillie Islanders and other comparatively near neighbors to the east were known as Kagsmalit but beyond them lived the Nagyuktogmiut. Under this term of Nagyuktogmiut they vaguely grouped all the distant easterners just as they with equal vagueness called the inland Alaskans, Nunatagmiut. Just as we found that the Nunatagmiut were really but one of the many tribes of interior Alaska so we also found later on that Nagyuktogmiut are but one of the many tribes of the Copper Eskimo. Although the name of no other tribe seems to have penetrated as far west as the Mackenzie or if any did penetrate that far they have at least now been forgotten.

As the relation of the Mackenzie Eskimo to the Indians was an especially aggressive one they had pushed their settlements a considerable distance up into the forest country to the head of the delta, but the larger portion of the Mackenzie Eskimo were on the east coast of Richard Island and on the mainland coast opposite and eastward, thence to the Baillie Islands and beyond. Curiously enough, a large number of these people were known to their immediate neighbors by the name of a village which, for a century at least, has been uninhabited. Kupuk was located on the east coast on Richard Island and was a place favorable for the killing of white whales in summer, but the shifting current of the river made the whaling grounds too shallow and the people had to move across to the mainland to the neighborhood of the present large village of Kittegaryuit, which was the largest of all the Eskimo villages of the Mackenzie section and possibly of all Arctic North America until the great measles epidemic of 1900, when the few remnants got the idea that the site was an unlucky one and moved away. Richardson tells us that from this village alone about two hundred kayaks came out and followed his boats as he was passing. We know that during the white whale season kayaks were used only by the able-bodied hunters so this will show that the population of the Kittegaryuit village alone must have been somewhere between eight hundred and one thousand people. It was not true that the other villages on the coast were all depopulated and their people gathered at Kittegaryuit for the white whale hunt. No doubt a few individuals from the nearest village did so, but the people of the Eskimo Lakes inland were at that season hunting caribou and the people of Point Atkinson told me that they never took part in the Kittegaryuit hunt.

There seem to have been many villages of considerable size east of Kittegaryuit, but the biggest of them next to that of the Baillie Islands was Nuvo-rak (Point Atkinson), and eventually it became the only inhabited village between Baillie Island and the Mackenzie Delta proper, and even it is uninhabited since the epidemic of 1900, or was so, until the winter of 1911-1912 when a trading schooner anchored there. The natives as a result

gathered about and in April, 1912, there was a population of perhaps thirty people.

Formerly the people whom we call Baillie Islanders had a permanent village on one of the Baillie Islands which they called Arvak. Since the whaling ships began to come in and winter in this vicinity, the dwelling site was removed to a sandspit on the mainland of Cape Bathurst, called Utkaluk. In the autumn both the people of Cape Bathurst east of Liverpool Bay, Nuvorak, and other places west of it, used to go to the head of the Bay in the fall for the caribou hunt and used to spend the early part of the winter there fishing; but apparently the entire population moved out to one of the promontories for sealing purposes about the middle of winter. East of the Baillie Islands were several villages between that and Langton Bay, which was known as Nuvuayuk from the sandspit on which the village was located, and behind which whaling ships have wintered in recent years.

There is little doubt that there was a continuous chain of habitations prior to say 1830, all the way east along the coast from Langton Bay to Coronation Gulf, and from the character of the archaeological remains, we are inclined to think that these people resembled in culture those of the Baillie Islands more than they did those of Coronation Gulf. However, there seems to have been a feeling at the Baillie Islands that the people east of Langton Bay were not their people, while those of Langton Bay were, and when the changing trade conditions and other reasons broke the continuity of habitation along the coast (about 1840), most of the people of Langton Bay moved west to the Baillie Islands, while some of Langton Bay and apparently all east of them, moved east towards Coronation Gulf if indeed they were not exterminated by some famine consequent upon an untoward season. There were evidently permanent villages as far east, at least, as the mouth of Crocker River, and clearly bowhead whaling was one of the chief occupations. Even beyond Crocker River closer investigation is likely to show the existence of permanent earth and wood dwellings. We did not happen to find any, but we passed this section of the coast in the early spring (May, 1910) when the snow would have covered so as to hide any but the most conspicuous house ruins.

The Copper Eskimo do not seem ever to have had any permanent houses, so far as we could ascertain from spending the summer in the neighborhood of the Coppermine and from making inquiries from the oldest men. In looking for a characteristic by which to differentiate the eastern from the western Eskimo, it may be difficult to find a better one than this, that the westerners built permanent dwellings of earth and wood while the easterners used only skin tents and snowhouses. If it shall be found, as I suspect, that the distribution of the larger western sled will coincide archaeologically

approximately with the area of earth and wood houses, and the long eastern sled with that of the absence of house ruins, these two features will differentiate the two regions with some clearness. So far as we know the big skin boat or umiak was also a characteristic of the western section and absent in the eastern, at least within the last century.

Named from the west and following the mainland coast around without any reference to Victoria Island, we have the groups enumerated below. The population in each case is approximate, but the figures given may be relied upon to vary in most instances not more than ten percent from the actual.

The Akuliakattagmiut are to be found usually in the late autumn and early winter encamped on the shore of Cape Bexley. This is a trading rendezvous where there come to visit them most or all of the Haneragmiut, a considerable number of the Puipirmiut and the Noahonirmiut and a sprinkling from other tribes as far removed as the Ekalluktogmiut of the east coast of Victoria Island. Shortly before or after the winter solstice the Akuliakattagmiut move out on the ice of Dolphin and Union Strait for sealing purposes and about the same time the visitors begin to return, each party to its own tribe. Between the tenth and the last of May they will move ashore near Cape Bexley where they cache their stores or seal blubber as well as their spare clothing and household gear, and move inland two or three days' journey south to Akuliakattak Lake, which is said to be the head of Rae River. This section is less well supplied with caribou than most other districts of the Copper Eskimo; consequently, the people live to some extent on fishing in the lake and are forced to purchase some of the skins they need for clothing from other tribes, chiefly in exchange for articles of wood. On account of this scarcity of caribou the Akuliakattagmiut use more sealskin for garments than do other tribes and are in general less satisfactorily dressed. They are much given to visiting among other tribes, so that while the population is really no doubt sixty or over, we found only thirty-seven at home when we were visiting them in May, 1910.

The Noahonirmiut hunt in winter on the ice of Dolphin and Union Strait in the neighborhood of Liston and Sutton Islands and spend the summer in general on the mainland south of those islands and north of Rae River. This is perhaps the smallest of the recognized subdivisions of the Copper Eskimo on the mainland. Their number is about twenty.

South of the Noahonirmiut in summer are found the Kaniernermiut, so called because they inhabit the headwaters (Kangia) of the Pallirk which is their name for the Rae River. These people are also sometimes called the Uallirgmiut. In winter most of these seem to be out on the ice of Coronation Gulf. This is rather an indefinite subdivision sometimes confused with the Pallirmiut proper. The number may be about thirty.



The Pallirmiut occupy in spring, and sometimes also in summer, the mouth of the Rae River (Pallirk). Some of them, however, annually join the Kogluktogmiut in the summer salmon fishery at Bloody Fall. In winter, they occupy the ice of the west central portion of Coronation Gulf. Their number is about forty.

The Kōgluktogmiut draw their name from Bloody Fall (Kōgluktok — it flows rapidly, or spurts, like a cut artery) which name is also generally applied to the Coppermine River as a whole. They spend their winters on the ice of Coronation Gulf and in summer it is not always that they remain at Bloody Fall during the summer salmon fishery, although the Fall is recognized by the other groups as being their particular hunting ground. Their population is about thirty.

The Kugaryuagmiut hunt in summer in the vicinity of the Kugaryuak River, the mouth of which is about eighteen miles east of that of the Coppermine. In winter they are like the rest on the ice of Coronation Gulf. Their population is about twenty-five.

Pingangnaktok (meaning it blows a land wind) is a place some distance inland west of Tree River and a number of people whom we met considered themselves natives of this district, the Pingangnaktogmiut. Like the rest, they hunt out on the gulf in winter. Their number may be about thirty.

The Kōgluktualugmiut are the people who frequent the neighborhood of Tree River (Kōgluktualuk). They are also called Utkusiksaligmiut, the dwellers of the place where there is pot stone. This is the location of the most westerly pot stone (steatite, or talc chlorite schist) quarries known to the Eskimo on the Arctic shore of the continent of North America. These quarries and others east of them are probably the source of all the so-called soapstone lamps and soapstone cooking pots in the possession of the Eskimo as far west as Bering Straits and even into Siberia, for people still living at Cape Prince of Wales have told me that they got stone lamps from the east and exported them to Siberia, and as you go east from Cape Prince of Wales you find in each village the story that they got their lamps from the next village east of them and so you can follow the trail until it leads to the Utkusiksaligmiut about eighty miles east of the Coppermine River. In April, 1911, we visited a village of these people, located about twenty miles to seaward from the north of Tree River and they had just moved to this campsite from another farther northeast. The population is about forty. This is the most easterly tribe actually visited by us on their own hunting grounds, although we saw and talked with individuals of other tribes as far east as the Kent Peninsula.

Kōgluktuaryumiut are in winter on the ice off Gray Bay. In spring they fish at the mouth of the Kōgluktuaryuk River where Hanbury found some of them in July, 1903. This is the most westerly tribe seen by Hanbury on

his journey with the exception that he saw one family of the Pallirmiut on Dismal Lake. The population is probably about fifty or sixty.

We were informed in a general way that the entire district from Gray Bay to Kent Peninsula was thickly inhabited and this was said to be especially so on Bathurst Inlet and the Kent Peninsula itself. As none of our informants would count above six, it was of course rather difficult to get a definite idea of numbers from them. Members of the tribe of Kanhiryuar-miut informed us that the number of people in Bathurst Inlet was greatly in excess of that of their own tribe and as that tribe numbers about two hundred, I am inclined to assign to the region between Gray Bay and Kent Peninsula a population of four to five hundred. I think that in conversation, I must have heard the names of various tribes of this district, but through some slip I failed to note them down except that of the most talked-of group, the Umingmûktogmiut of the permanent village of Umingmûktok on the west coast of Kent Peninsula. We have never ourselves seen permanent villages or permanent dwellings among the Copper Eskimo, but we were told that Umingmûktok was inhabited the year around. There are no doubt several groups, each with its own name, between the Umingmûktogmiut on Kent Peninsula and Ogden Bay, where live the Ahiagmiut. The ahiak is the Alpine bear berry. We know of this tribe only because they are visited by the Victoria Island Eskimo when they are on their way to the summer trading rendezvous on Hanbury's Akilink River, near the head of Chesterfield Inlet. According to the Victoria Islanders, the Ahiagmiut should number anything between fifty and one hundred persons. South of the Ahiagmiut, the Victoria Islanders fall in with the Haningayogmiut, the people of Back River (Haningayok) who are said to be a small tribe. On this journey they also met sometimes the Kaernermiut, which they say may be only another name for the Haningayogmiut. On the Akilink itself, they met the representatives of a large number of tribes, some of them from the ocean to the east (Hudson Bay?). The people with whom they chiefly trade they speak of, however, as the Pallirmiut. Parties of the Pallirmiut also of recent years make winter trading trips as far north as the Kent Peninsula. It is probable that these trips began with Hanbury's journey, for the Victoria Islanders speak of the first visit of the Pallirmiut to Kent Peninsula as being that of the party of which Hanbury was a member. Whether this was really the first visit or whether it was merely the first one of which the Victoria Islanders happened to hear, is not certain.

We have given roughly the summer location of all the mainland coastal tribes so far as it is known to us, but one district is peculiar in that it is occupied by representatives of a dozen or more tribes. This is the summer hunting district enclosed by a quadrangle formed by the Coppermine River

on the east, Great Bear Lake on the south, Dease River on the west, and Dismal Lake and Kendall River on the north. Among two hundred or so people who visited this district and with whom we hunted the summer of 1910, there were representatives of all the mainland tribes from Cape Bexley to the Kent Peninsula as well as the Puiplirmiut and Nagyuktogmiut of Victoria Island.

In naming the island people we must begin with Banks Island, for it is still inhabited in its southern portion in winter and all of it seems to have been inhabited until comparatively recent years. We were told by the old men of the Kanhiryuarimiut that so far as they knew, all Banks Island was inhabited formerly and the people were very prosperous. They are said to have killed so many musk-oxen and caribou in summer that they usually had plenty of dry meat to take them through the winter. However, famines began to occur now and then, due the Victoria Island people say, to the enmity of a powerful Victoria Island shaman who by his spells caused all the food animals to leave Banks Island and its neighboring waters. Finally, the last of these people are said to have died of hunger at a time when men now apparently less than thirty years of age were small boys. On Victoria Island north of Minto Inlet there was also a numerous population known as the Ugyuligmiut. This is also attested by the English explorers Collinson and M'Clure, whose maps are labeled "numerous Esquimaux parties" in the district north of Minto Inlet. There is a belief among the Victoria Islanders today that these Ugyuligmiut murdered some white men belonging to the exploring ships and that the white men in revenge shot them down, exterminating them to the last man. This is supposed to have happened in the lifetime of the oldest of the Victoria Islanders, a man named Pamiungittok, who at the age of six years visited Collinson's ship in Walker Bay. Pamiungittok said, however, that he had never heard of any eye-witnesses to the shooting of the Ugyuligmiut by the white men and he said it was quite possible that they might really have died from famine and that the story of their being shot might have grown up "as such stories do." However, all the Victoria Islanders agree that at present there are no living representatives of the Ugyuligmiut.

The north coast of Victoria Island east of Collinson Inlet and the east coast north of its middle are supposed to be uninhabited and to have always been so. Collinson Inlet has been visited occasionally by many members of the Kanhiryuarimiut tribe still living, and they have never seen other signs of human habitation than those which they believe to be the traces of the earlier visits of their own people.

Coming to the tribes still in existence, the Kanhiryuarimiut are the most westerly although they draw their name from Prince Albert Sound

(Kanghiryuak). They live in winter, most of them, on the southeast coast of Banks Island between Nelson Head and De Salis Bay, where in contradistinction to most other Eskimo tribes they depend for food chiefly on polar bears. A few, however, spend an occasional winter on the southwest corner of Victoria Island near Cape Baring. Two families did so the winter of 1910-1911.

Late in March or early in April in each year they commence their eastward migrations crossing the straits to Prince Albert Sound and moving east along the middle of the Sound. We found them to be approximately in the geographical center of the Sound on May 13, 1911, and it is probable that their migrations pass this point at the same time each year. In Prince Albert Sound the parties divide. In the summer of 1911, none of them were going south into the Colville Mountains, although certain years a few of them are in the habit of going there to meet the Haneragmiut. Six or seven families were going north into the mountains between Prince Albert Sound and Minto Inlet; a larger party still, were going southeast from the foot of the Sound to meet the Puipirmiut and another good-sized party were going northeast from the foot of the Sound, location about forty miles inland, where native copper is most abundant and can most easily be had for the manufacture of knives, missile points, needles, and other articles. But the largest party of all, were going east up the Kagloryuak River to meet the Ekalluktogmiut near the center of Victoria Island. The population of this group is two hundred or a little over. When they were all together in the spring of 1910 they occupied thirty-three dwellings, as we learned from the examination of one of their deserted villages. When we visited them, six families had already separated themselves from the main body.

North of the Kanghiryuarimiut are the people who bear the name of Minto Inlet, the Kanghiryuatjiagmiut. They are said to have been more numerous formerly, but have suffered somewhat from famines, not so much in actual deaths as in having certain families leave them to join other tribes that had better hunting grounds, for some such as the Kanghiryuarimiut who never had a famine within the memory of anyone living. I failed to make a record of where they spent their winters but have the general impression that they usually, if not always, are with the Kanghiryuarimiut on Banks Island. When we visited the Kanghiryuarimiut the middle of May, 1910, the Kanghiryuatjiagmiut were said to have separated from them on the ice of the straits as they were coming from Banks Island and to have gone around Cape Wollaston into Minto Inlet with the intention of spending the summer in the mountains to the north. Their number is about twenty.

As we have mentioned above, the larger number of the Kanghiryuarimiut

hunt in summer in the middle of Victoria Island, where they meet the Ekalluktogmiut who come up from the east from Albert Edward Bay along the ice of the Ekalluktok River. It is said that the river is so called because of the large number of fish to be caught in it and this is the only tribe of the Copper Eskimo who, according to our information, live largely on fish in winter. It was this tribe with whom Lieut. Hansen of Amundsen's expedition came in contact on the ice east of Victoria Island in the Spring of 1905. The Kanhiryuarimiut say that they and the Ekalluktogmiut are tribes of about the same size, so that we may estimate them at two hundred. Two members of this tribe, both of them men, had married into the Kanhiryuarimiut tribe. We talked with both, and one of them gave us considerable information about the east coast of Victoria Island as well as about his own people and other tribes farther east.

Along the south coast of Victoria Island, the most westerly are the Haneragmiut. A few of them each year hunt on the mainland with the Akuliakattagmiut or farther east, but the larger number go north into the Colville Mountains to a fishing lake called Tahiryuak, where they also get numerous caribou and where, as stated above, they some years meet a few representatives of the Kañianermiut. The population is about forty.

The Puilirmiut are in winter on the ice in the neighborhood of Liston and Sutton Islands and most of them hunt in summer northeast from Simpson Bay into Victoria Island, where they annually meet a party of the Kanhiryuarimiut. A few families usually hunt south of the mainland, some of them as far as Great Bear Lake. This tribe is so given to visiting with other tribes that their number is difficult to estimate, though I suppose it to be not short of sixty.

The Nagyuktogmiut are so called from the little island of Nagyuktok, which may be intended by the charts to be one of the Duke of York Islands, although the maps here as in many other places are so poor that identifications are difficult. This tribe also has the name Killinermiut from the district Killirk on the south coast of Victoria Island east of Lady Franklin Point where many of them hunt in summer. This is nowadays, at any rate, not one of the most important tribes of the Copper Eskimo and still, as mentioned elsewhere, it is the name of this tribe alone of all the tribes of the Copper Eskimo, that is known as far west as the Mackenzie River, as I know from my own observations, and as far east as King William Island as we know from Amundsen's account. This name also impressed itself on Richardson who mentions it in connection with his expedition of 1848. They spend their winters near and north of the middle of the western half of Coronation Gulf and most of them hunt north into Victoria Island in summer, although some hunt to Bear Lake and elsewhere upon the mainland. The population of this group is not over fifty.

The Nagyuktogmiut were the most easterly tribe of Victoria Islanders visited by us. They told us that the next tribe east of them were called the Kilusiktogmiut. I got no special idea of how numerous they are. I happened to see one or two members of the tribe among the Nagyuktogmiut, but in the press of other things I neglected the opportunity of making careful inquiries as to population. They told me, however, that so far as they knew, the entire south coast of Victoria Island was populated all the way around to Albert Edward Bay and in their opinion about as densely as that portion with which we were familiar. If that be so, it should mean from three to four hundred.







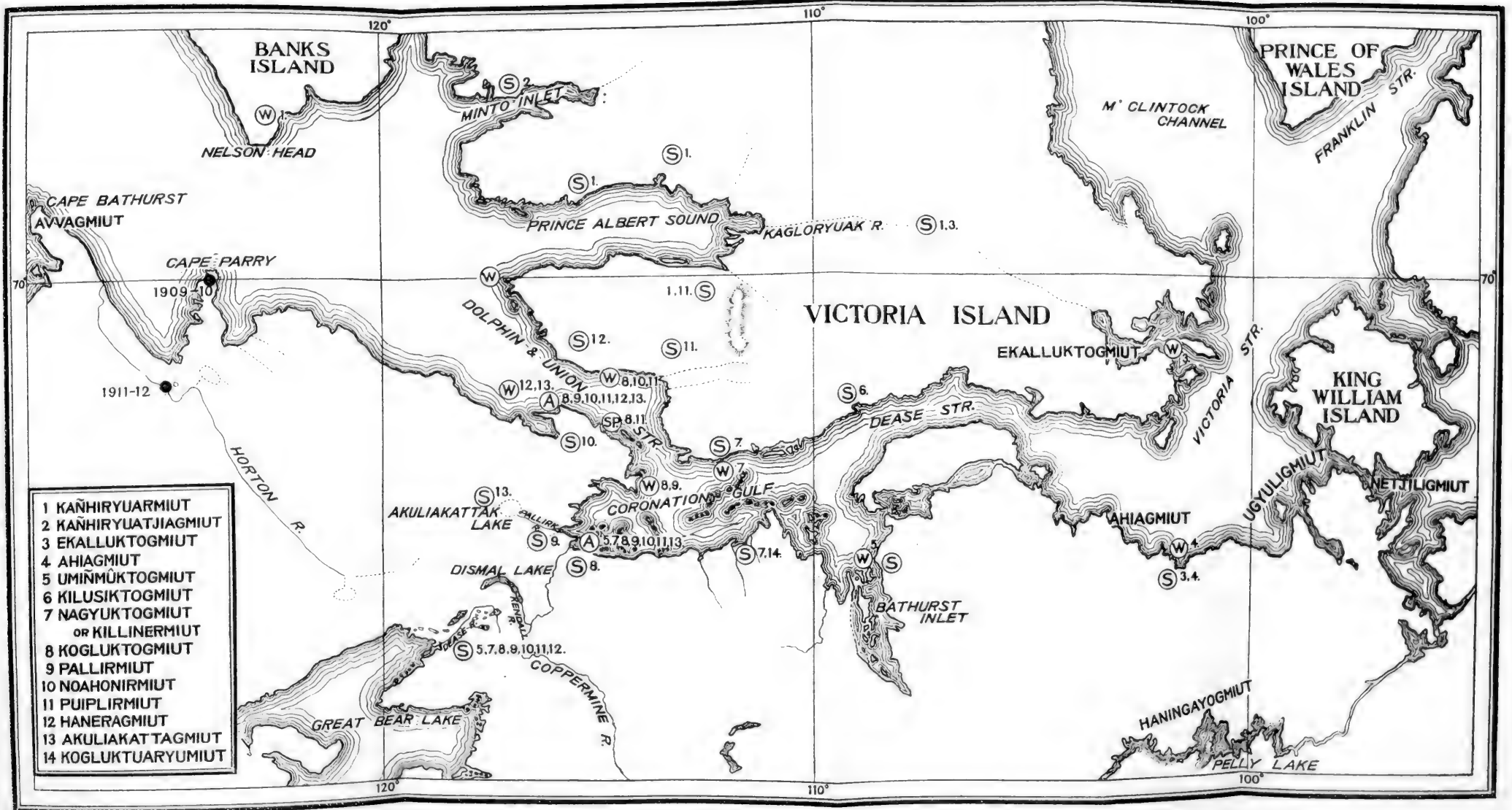

DISTRIBUTION OF THE CORONATION GULF ESKIMO.

The letters locate the campsites for the several seasons of the year; the numerals indicate the tribes occupying each site.



- |    |                 |
|----|-----------------|
| 1  | KANIRYUARNUIT   |
| 2  | KANIRYUARNUIT   |
| 3  | ENALUKTOGMUIT   |
| 4  | AMAGNUT         |
| 5  | UMINUKTOGMUIT   |
| 6  | ALUSIKTOGMUIT   |
| 7  | NAGYUKTOGMUIT   |
| 8  | OR KILLIBERNUIT |
| 9  | KOGLUKTOGMUIT   |
| 10 | PALLIRNUIT      |
| 11 | NOVAKORRNUIT    |
| 12 | PURILIRNUIT     |
| 13 | HANERAGNUT      |
| 14 | AKULALATAGMUIT  |
| 15 | KOGLUTARVUNUIT  |

## THE CORONATION GULF ESKIMO.

For convenience we have chosen to designate all the various Eskimo groups visited by us in the Coronation Gulf District as the Copper Eskimo. In the preceding discussion and again on the ethnographic map we have given the designations employed by the Eskimo themselves and indicated their conceptions of inter-relationship. In general the cultures of these groups seem to be similar and may be conveniently discussed under one head. Since one of the striking traits of this culture is the use of native copper, the term seems to us quite appropriate as the designation of the general culture group.

### RANGE AND DISTRIBUTION.

We found in the spring of 1910 when we first visited the Akuliakattagmiut and Haneragmiut, that they had place names for various points along the coast of the mainland running as far west as Cape Lyon, apparently. Several members of these tribes were pointed out to us as having had parents and ancestors that came from the west or habitually made journeys west. This merely corroborated what we already knew from the Baillie Islands Eskimo that there had been, probably up to about 1840, continuous tribe to tribe trade relations between the west and the Nagyuktogmiut. It was an interesting thing to find that while the westerners knew the easterners by the name of the Nagyuktogmiut tribe, which was but one of many, the easterners correspondingly knew the westerners by the name of Kupûgmiut, which was but one of the western tribes and a distant one at that, although a numerous body and powerful locally. Similarly it is true that the Point Barrow people were familiar with the name of the Kupûgmiut which they used for all the Mackenzie section whenever they did not employ the vague general term Kagmalit.

This knowledge of place names to the west of Cape Bexley indicates that the Cape Bexley people are familiar with a stretch of country about two hundred miles to the west of them. To the south, they as a tribe do not seem to be in the habit of going even as far as Dismal Lake. A few members of the tribe do go to Dismal Lake and beyond, but they apparently always do so by a circuitous route, going east into Coronation Gulf and joining one of the local tribes there such as the Kogluktogmiut and accompanying them to Dismal Lake and Great Bear Lake. We found that one family, at least, of the Akuliakattagmiut had been as far east as Tree River.

We talked with one woman who had been a member of a party that spent the summer there with the Utkusiksaligmiut in the making of pots and lamps; and one of the most popular songs at Cape Bexley was one composed by this woman to commemorate the journey. This song contains several geographic names and so formulates a sort of a record of the event. This woman seems to have been about fifteen or eighteen years of age when she made the journey and she is now about forty. East beyond Tree River the knowledge of the Akuliakattagmiut is exceedingly vague, although they had heard of Umingmuktok (on Kent Peninsula). Like every other tribe, they knew of the Akilunik River. In fact, it seems that the Akilunik River is perhaps the most widely known locality of all places familiar to the Eskimo. In the Mackenzie district there are many tales of the Akilunik and so there are said to be in Greenland. Of course, it is not susceptible of absolute proof that the Akilunik of the stories can be invariably translated to mean the Akilunik River that flows into Chesterfield Inlet, for in the Mackenzie District and probably in Greenland the people have no idea in which direction from them the Akilunik lies, but seeing that the district of the Akilunik draws to it today visitors from a thousand miles west and from great distances in all other directions, it seems that it may always have been as it is now, the greatest gathering center from a geographic point of view of the whole Eskimo race. No doubt the trade meetings in Kotzebue Sound, for instance, were attended by larger crowds, but they did not come from such great distances although some of them came from Siberia and others from the Arctic coast near the Colville or from the comparatively warm region south of the Yukon.

That the travels of the Akuliakattagmiut and Haneragmiut to the east have not been very extensive is shown best by the fact that they had no idea of Victoria Island being an island. We found no one who knew that important fact until April, 1911, when we visited a village occupied chiefly by Nagyuktogmiut and Utkusiksaligmiut off the mouth of Tree River. Several men there knew that Victoria Island had an east coast and they said they had always supposed that it had a north coast also and was an island; in fact, they had heard so from their fathers. These people were familiar with the fact of the loss of Franklin's vessels in the sea between King William Island and Victoria Island. I asked them whether they had ever heard of a ship being wrecked and white men dying on the east coast of Victoria Island. Had they answered either in the affirmative or negative simply, the thing might have meant little, for an Eskimo is likely to answer any leading question without much reference to the facts, merely thinking what answer is likely to please you best. But this man promptly replied that so far as they knew no ship had been wrecked on the east coast, but that about the time when they were born two ships had become fast in the

ice well off shore and that they had been abandoned by their white crews many of whom they knew had starved to death and think that it was likely that all of them had.

It was a curious thing that some months later when in Prince Albert Sound I met two members of the Ekalluktogmiut tribe who live on the east coast of Victoria Island who declared that they had never heard of any ships being lost in their vicinity. These were, however, young men, and young men commonly pay very little attention to the stories told by their elders unless they be stories of a religious or miraculous nature. These men promised me that if they revisited their tribe they would make inquiries from the old men about these ships and would tell me if I were to return. In view of the fact that all but one man among the Rae River Eskimo declared stoutly to me that no white man had ever come to Rae River, shows that no great dependence can be placed on negative testimony. Some of these men who denied knowledge of white visitors on Rae River were the sons of the old man Ekallukpik, who himself as a boy of six or eight had seen Richardson when he was followed across the Rae River by the Eskimo in 1848. When later I asked Ekallukpik's sons how it happened that they were ignorant of such an important event that had happened before the eyes of their father, they replied that they no doubt had heard the story often, but had never paid any attention to it "for," they said, "old men tell so many tales."

We know that the people of the vicinity of the Coppermine often follow it in summer south beyond Kendall River, but then they generally come over to the west into the district between Dismal Lake and Bear Lake. We understood that when the people of Bathurst Inlet come to Great Bear Lake, they go well towards the head of the Inlet and then strike approximately straight west for the east end of Great Bear Lake. One group whom we met the summer of 1910 told us that they had come this route. How far south they sometimes go from the head of Bathurst Inlet we do not know, although the chances are that it will be a considerable distance.<sup>1</sup>

---

<sup>1</sup> None of the Eskimo who habitually hunt to Bear Lake on McTavish Bay know that the Dease River flows into the same lake. In fact, they told us definitely that McTavish Bay was a large lake "like the sea" whose name was Imaryuak; while Dease River, for which they have no name, flowed into a small lake which likewise has no name. As a matter of fact, what they consider two lakes are, of course, but two bays of Bear Lake. They specifically denied knowing of any connection between McTavish Bay and the lake into which the Dease flows, though "there may be a river between" they said. As a matter of fact, Ritch Island so completely shuts off the triangle of water into which the Dease flows, that no one could suspect its connection with a big lake unless he went along either shore past the end of Ritch Island, or got a view of the lake from the high land of the Caribou Point peninsula. It seems evident that in recent times these Eskimo have never penetrated so far, or else the presence of Bear Lake beyond Ritch Island would be known. To discover the identity of McTavish Bay with the water into which the Dease flows they would have to have been to the top of Caribou Point some twenty or thirty miles beyond the farthest reached by them in 1910 while we were with them.

The Kañhiryuarmit have the widest range of seasonal migrations of any of the Copper Eskimo tribes and probably of any Eskimo tribe in the world. In winter most of them are found on south Banks Island just east of Nelson Head. They leave here late in March, cross the straits to Prince Albert Sound, and here the tribe scatters in all directions. Some go thirty or forty miles south; some sixty or seventy miles southeast; some forty or fifty miles northeast; and occasionally all the way across the island to Collinson Inlet, while the larger number go about one hundred miles east up the Kagloryuak to where it heads near the head of the Ekalluktok which flows from the center of Victoria Island east into Albert Edward Bay. At this point four or five families separate themselves from the rest, descend the Ekalluktok and cross the straits to the mainland in the vicinity of Ogden Bay. It seems they reach this point annually the early part of June, for it is here they have to abandon their sleds and proceed south carrying back loads and their dogs also carrying packs, for they are bound overland to the Akiliniik River. Usually, on the way they are joined by a few families of the Ekalluktogmiut in Albert Edward Bay and later by some families of the Ahiagmiut at Ogden Bay. The united parties march overland and some time in July they come to Back River which they call the Haningayok. Their visit is expected by a party of the Haningayogmiut, who are ready for them with kayaks to ferry them over.

The party then proceeds south and it is probably early in August that they reach the trading rendezvous on the timbered section of the Akiliniik River. It was here that Hanbury fell in with a party of them. We met near Tree River in April, 1910, a young woman who with her parents had been on the Akiliniik at a time subsequent to Hanbury's visit and who had heard from the Eskimo there all about Hanbury and his companions, and a month later we met in Prince Albert Sound the man Hitkoak who had been actually present on the Akiliniik when Hanbury visited them. This being the only white man Hitkoak had seen, he was naturally much interested and told me all about Hanbury's equipment down to the smallest detail as well as giving all the names of the Eskimo who accompanied Hanbury. Hanbury's own name and that of his two white companions, Darrell and Ferguson, Hitkoak mispronounced so badly that they were not recognizable, but his personal description of the men was correct as were the names of the Eskimo of Hanbury's party.

These trading parties of the Haneragmiut usually do not get back to join the tribe that year, but return only as far north as the vicinity of the Kent Peninsula. They sometimes proceed some distance west into Bathurst Inlet or even into Coronation Gulf proper, but never continue far enough west to reach the vicinity of the Coppermine and to return home by the

route which we followed on our spring journey in 1911. Instead they always turned back to Albert Edward Bay and ascended the Ekalluktok River by sled in spring to join their countrymen the second summer after their departure on their summer hunt in the middle of Victoria Island.

Meantime another party has gone east towards the Akililik to make in its turn the same round. It seems to be seldom that any individual of the Kañhiryuarmiut will make this trip more than two or three times in a lifetime. On the other hand, there seems to be a good half of the tribe who have made the trip at one time or another. The chief object of the trip in the early days, and it remains so still, is the securing of wood for sleds, implements, and utensils. Probably too, it was only a few years after the first establishment of Hudson's Bay Company's post on Hudson Bay that iron began to percolate into the west by this trade route. Nowadays knives, files, and a few cooking utensils are purchased as well as little odds and ends such as bits of cloth that are kept chiefly as curios. Two steel fox traps had found their way by this route into Coronation Gulf, but we found none among the Prince Albert Sound people.

It is natural that the Haneragmiut, on account of their extensive travels, are better informed of distant places than are any of the other tribes. It is not only that they have seen more places themselves, but by extensive travels and much association with strangers they have acquired a perspective and broadmindedness lacking in other districts. I secured from them accordingly, chiefly from the man Hitkoak mentioned above, a good deal of geographic information about distant places to the east and northeast most of which is more conveniently embodied in a map than in a set discussion.

Hitkoak's information seemed fairly definite and correct as far east as King William Island. He told me that there lived the Netjiligmiut. He had heard that they were just ordinary Eskimo although they had many disagreeable and cruel customs, but next east of them lived other people who differed from ordinary human beings in having no chins; in other words, their necks come straight down from the face to the breast. Beyond these he said lived the Kablunat of whom he had heard many strange stories. These he admitted were not, however, borne out at all by his own experience with Hanbury whom he had found very different from the traditional description of the white men who lived east of King William Island. It was also true he said, that the old men who visited Collinson on his ship had found him and his men to be very similar to Hanbury and not very different from Eskimo in general.

Hitkoak told me further that if you were to come from the mainland to King William Island and keep on in the same direction after you had crossed

the island you would eventually come to another and bigger island inhabited by Eskimo who dressed exclusively in sealskins because they had no caribou. "These people," he said, "are called the Tununirohirmiut because they live on the far side of the land from the point of view of the rest of us." This name corresponds with that given by Professor Boas for a tribe near Admiralty Inlet from information secured on the east coast.<sup>1</sup> Hitkoak's description might fit either North Somerset or Prince of Wales Island. In May, 1911, I learned from the old man, Pamiungittok of the Kanhiryuarmiut, that he is the only man living who saw either Collinson or M'Clure. He was aboard of Collinson's vessel with his father in 1852 in Walker Bay when he was a boy of six or eight. At that time as now, members of the Kanhiryuarmiut tribe but rarely went any distance north of Minto Inlet, although they associated freely with the Uguligmiut (now extinct as elsewhere related) who occupied the narrow part of Prince of Wales Straits on the west end of Victoria Island. A few years after this visit to Collinson some of the Banks Island people (now also extinct, see ante) discovered M'Clure's abandoned ship in the Bay of Mercy on north Banks Island and passed the information on to the Kanhiryuarmiut who made a trip up there immediately for the purpose of securing iron and wood from the ship itself and from the stores which had been carried ashore by M'Clure's men before they abandoned the "Investigator." The iron was of priceless value but there was so much of it that the people could not carry it all away and as they did not have the forethought to suitably protect it from the weather, much of it was destroyed by rust during the next decade or two, although many parties of Eskimo from various directions went up there to help themselves. The wood was of little use because it was mostly hardwood with the working of which the Eskimo are unfamiliar. The only desirable wood they found, Pamiungittok said, was the packing cases around the various kinds of goods. They accordingly broke these cases open, threw the contents away and used the boards for shafts of arrows and things of that kind. The hard wood Pamiungittok pointed out, was almost as hard and difficult to work as caribou antler without being nearly so strong, and consequently they had no use for it. There were many barrels filled with meat which was unfit to eat on account of its saltiness and others filled with strange liquids (among other things probably brandy and rum, large quantities of which were cached on shore by M'Clure), but the hoops of some of these barrels were of excellent iron and were removed by the people while the contents as well as the barrel staves were of no use.

The last visit paid by the Kanhiryuarmiut to the Bay of Mercy was at

---

<sup>1</sup> Boas, *Central Eskimo*, 442.



a time when Pamiungittok's son, Aglervittok, was a boy of about ten years or as Pamiungittok said, when he was big enough to walk all day behind the sled and to shoot ptarmigan; he was not big enough to hunt caribou. Aglervittok appears to be about twenty-five years of age although he may be thirty. It is therefore from fifteen to twenty years since this last visit. At that time there was nothing left of the iron of the "Investigator" except some big pieces that were so unwieldy they could not be handled by the Eskimo. The ship had long ago disappeared. Pamiungittok did not know how the break-up took place or when, but it was not very long after she was first discovered by the Eskimo. Ship's timbers and pieces of wreckage which they recognize as belonging to the "Investigator" have been found in Prince of Wales Strait at various points north of Ramsay Island. This shows not only the fact that the vessel has been broken up, which is not particularly interesting as it could have been surely predicted, but also the more interesting thing that the winds or currents, or both, in this section are such as to bring drift materials down from the north into Prince of Wales Strait. From the scarcity of driftwood on the south coast of Banks Island and Victoria Island and from its abundance in Prince of Wales Strait, as described by both the English navigators, it seems probable that this wood must have passed from the Mackenzie River north along the west coast of Banks Island and east around its north end.

At present no people occupy Banks Island in summer although it is known to be fairly well stocked with both musk-oxen and caribou. The caribou, however, are not in such vast numbers here as in Victoria Island, which is filled by the migrations coming from the mainland in the spring although there are few if any caribou there in winter. Banks Island, however, has caribou the year around, for they do not seem to migrate across Prince of Wales Strait to any extent. It is not very many years, however, since some parties of the Kanhiryuarmit must have spent a part of the summer in Banks Island. We did not learn this from them, however.

The Eskimo, Ilavinirk, who worked for our party was one of four Eskimo who some years ago purchased the schooner "Penelope". They owned her and sailed her for many years and on one of their voyages they anchored off Cape Kellett on the southwest corner of Banks Island and went ashore to hunt. In more than one place on the land they found recent traces of Eskimo occupation, such as bones of animals that had been eaten and the remains of fires where cooking had been done. According to our present knowledge, we infer that these people must have been members of either the Kanhiryuarmit or Kanghiryuatjiagmiut. Because the Kanghiryuatjiagmiut winter with the Kanhiryuarmit annually and families of either tribe may join the other at any time, we can consider that the range of these

two tribes is practically the same, although the more northerly tribe has for its particular hunting ground the country north and east of Minto Inlet.

#### CLIMATIC CONDITIONS.

There are some rather astonishing differences in climate within the comparatively restricted district occupied by the Copper Eskimo. Dr. Anderson found, for instance, in the first week of May, 1911, that the rivers were already opened and mosquitoes on the wing on the southward slope between Dismal Lake and Great Bear Lake. The same year the last days of April and the first days of May we had the first thaws at the mouth of the Kugaryuak, eighteen miles east of the Coppermine. The morning of the second day of May we arrived at the village of the Noahonirmiut near Lambert Island. When we arrived the houses were all of snow, but that was the first warm day and by the middle of the afternoon most of the snow roofs had caved in on account of the heat of the sun and had been replaced by roofs of skin. Going north from Lambert Island we found a week later on Forsyth Bay at the northeast corner of Simpson Bay, houses that were still all of snow. In other words, although we were traveling slowly and halting frequently, we were still moving north at a pace that was leaving the summer farther and farther behind us. We went across the Wollaston Peninsula into Prince Albert Sound and spent more than a week visiting the people there; then we went west along the sound and south to Bell Island near the southwest corner of Victoria Island. The snow on Bell Island showed plainly that there had been no thaw as yet, for even a slight thaw is bound to leave a trace by turning to ice some of the snow on the southward faces of the cliffs. The first thaw came on May twenty-sixth when we had been two days in camp at Bell Island. In the afternoon of that day we started southwest across Dolphin and Union Strait and landed four days later just west of the mouth of Crocker River. When we left Victoria Island the snow had lain soft and white as in midwinter; when we got half way across the straits, puddles of water began to appear here and there on the ice and the last ten or fifteen miles before reaching the mainland the sea ice was honeycombed by the sun and we waded in many places knee deep through puddles on the ice. There were open cracks near shore across which we had to ferry our sled and when we got to the land we found it bare of snow except that a few deep drifts still remained in the shadow of cliffs and cutbanks. In going southwest sixty miles we had found as great a change of weather and ice conditions as could possibly have been brought about on southwest Victoria Island by a month of spring weather. In other words,

there is a difference of a month apparently in the climate of southwest Victoria Island and of that of the mainland sixty miles south.

Richardson remarks that the fall comes a month earlier at the eastern end of Dolphin and Union Strait than it does at the mouth of the Mackenzie River. I consider this an approximate statement of the facts, although of course it would take the maintenance of a meteorological station at these different points for periods of years to form a really safe conclusion.

The fall of 1910, the caribou migration crossing Coronation Gulf from the north began November ninth, which seems to indicate that the ice had not been strong enough to carry the animals until a day or two before this time, for it is the universal Eskimo account that the animals are found on the south coast of the land each fall waiting for the ice to form. One would infer that this is the case and there is no reason to doubt it; besides the statement is corroborated by Collinson's observations at Cambridge Bay on southeast Victoria Island in 1851. On Coronation Gulf it was the second week in October before the rivers could be crossed at any places except those of nearly currentless water. In September, 1910, snow fell more than once to clear away again. There was a medium heavy fall of snow, September nineteenth, however, which remained on the ground for about ten days but had practically disappeared by the end of the month and it was the tenth of October before even the quieter places on the Dease River were frozen, while on November eighth when we set out from the mouth of Dease River for our crossing of the Barren Grounds northwest to Langton Bay, Bear Lake was frozen only around the edges and open water could be seen a few miles out. When we reached the height of land north of Great Bear Lake, however, and commenced the descent of the Arctic slope, it seemed to us again as if we had in the space of two or three days gone a month farther into the winter.

It is difficult without the maintenance of a permanent meteorological station to say definitely about the prevailing winds in summer, but in winter it is an easy matter, for the snowdrifts form a permanent record of the trend of the stronger and more frequent winds. We know, however, that in Coronation Gulf and on Dolphin and Union Strait and in Prince Albert Sound the prevailing winds are from the northwest approximately, while the winds next in frequency and force are approximately from the southeast, or from between southeast and east so that there is an angle of perhaps ten or fifteen degrees between the snowdrifts formed by the opposing winds. One result of the strength and frequency of the northwest winds is that driftwood is driven chiefly upon beaches that face that wind while beaches lying parallel to the wind or in such a way that the wind blows off the land are less well supplied with driftwood, or not at all. Accordingly, we have a

comparative plenty of drift sticks along the mainland shore as far east as Liston Island, while there is little on the opposite shore of Victoria Island. Similarly there is considerable driftwood along the south coast of Prince Albert Sound and very little along the north coast. The record for the whole year is therefore complete for the driftwood deposited in summer tells the same story as the snowdrifts in winter with reference to the prevalence of the northwest wind.

We found the summer of 1910 that inland one hundred miles or so south of Coronation Gulf there is very little rain and the sun shines down from a cloudless sky often for many days and nights in succession. The result is that the temperature rises to a height which one could not suspect could prevail north of the Arctic Circle. We did not have a thermometer with us, but all of us felt that the heat was intense and difficult to bear and I suppose that at times it rose to well over 90° in the sun and probably approached 80° in the shade. In September, however, the climate changed suddenly and both the Eskimo and the Bear Lake Slavey Indians said that this was the ordinary case. Fogs and drizzling rains became prevalent and days of sunshine were comparatively rare.

On the seacoast the presence of floating ice at no great distance from land has a considerable effect on the climate farther west, but in the comparatively narrow and enclosed waters the quantities of ice are not so large and although the seacoast of Coronation Gulf is said by the Eskimo to be more rainy and foggy than the interior, still it is no doubt less foggy and rainy and probably considerably warmer than the coast of the open ocean farther west.

#### DRIFTWOOD.

As pointed out above in the discussion of the prevailing winds, those coasts west of Coronation Gulf which face north are better supplied than the southward facing coasts. Coming east from Cape Lyon we found the driftwood gradually diminishing as we went east, but not nearly so fast as we had expected. Logs of considerable size clearly derived from the Mackenzie River are numerous well beyond Inman River, but when we come as far east as Cape Bexley mostly broken sticks are found and it would be difficult to get together on a small stretch of beach large logs of considerable size such as would be needed, for instance, for the construction of a log house. The beaches, however, are mostly composed of broken rock and for that reason all the wood there is dry and has been preserved from rotting. There is no doubt that if the Eskimo of this country are ever taught the use of sheet iron stoves as the Western Eskimo have been, the supplies of wood

which now are sufficient so that a traveling party can camp almost anywhere and find enough for fuel, will disappear in a few years and it will be found then that the replenishing will be a slow process for the piles of driftwood that make such a brave showing now have clearly been gathered here for centuries.

At one place we found a log that had been chopped with a sharp ax and the ax marks and the chips looked about as weather-worn as they would look in a temperate climate after a year or two of exposure and yet we knew for certain that this log had been chopped by one of Sir John Richardson's parties either in 1826 or else in 1848. This shows how slow the processes of decay are when working upon dry wood in an Arctic climate. Some of the sticks that burned brightly in our camp stove may have been lying there waiting for us some hundred years.

In Coronation Gulf itself there is comparatively little driftwood and most of it derived from the Coppermine River, doubtless. The Coppermine does not bring out much wood commonly, for although it flows through well-forested country, it is a country of solid rock in general, the erosion is slight and it is only in a few places that the river meanders over flat, wooded, bottom lands. It is no doubt on account of the prevailing northwesterly winds that we found much less wood on the west shore of Coronation Gulf than on its south shore, and it seemed to us that there was rather more wood on the island chain that runs east from near the mouth of the Coppermine than on the mainland itself. No doubt a party journeying by boat in summer will find no fuel difficulties, but while the snow was deep in winter we used to keep an eye open all day for any stick we might see and by that means we used to get together enough in a day to furnish fuel for camping at night.

On one of the islands, however, we saw a large log of cottonwood. The chances are that this stick came from the Mackenzie River; surely it could not be of local origin in Coronation Gulf. While it is clear that there is no steady and uninterrupted eastward current sweeping from Beaufort Sea into Coronation Gulf it seems that the prevailing trend of the currents must be more easterly than westerly or else how could this stick get to where we found it. There might well be a current from the west into the Gulf, however, without much driftwood coming in, for the northwesterly wind would naturally drive it ashore in the narrow straits. The course of a drifting stick is evidently a resultant of two forces, the one exerted by the current, the other by the wind.

The Eskimo told us that a few years ago they had found a stranded bowhead whale on one of the islands of Coronation Gulf and in it they had found what must have been a brass whaling iron. This whale must clearly have been shot by the whaling ships in Beaufort Sea and its carcass may have

been transported to Coronation Gulf by the currents and winds. It is, on the other hand, possible that the animal may have been merely wounded and may have made its way into Coronation Gulf before it died.

#### TREES AND VEGETATION.

In many of the river valleys of Alaska and of the neighborhood of the Mackenzie, there is a growth of very heavy willows which serves the natives for fuel. This is not so general in the district of the Copper Eskimo. Small willows are found both on Banks Island and Victoria Island, but there seems to be only one place in Victoria Island where the willows attain a considerable growth. This is the valley of the Kagloryuak River which falls into the east end of Prince Albert Sound. We did not see these willows, but we were told that what there were of them, grew crooked and never stood quite as high as a mast head.

In the valley of the Coppermine the growth of willows is very small north of the tree line, and on Dismal Lake where there are trees both at the east and the west ends of the lake, the middle section of the lake shore is supplied with willows that are only of a size corresponding with the descriptions we have from Victoria Island.

In ascending the Coppermine, the first week of June, 1910, we found a dozen shoots of spruce not more than three or four feet high growing a mile and a half north of Bloody Fall, or not over four miles from the ocean in a direct line. It may be considered, however, that the tree line of the Coppermine is, as measured along the river, nine or ten miles south of Bloody Fall, or in an air line, perhaps fifteen miles from the ocean. Just east of the Coppermine there is, however, a small patch of trees on the head of a little creek. These trees are no more than seven or eight miles from the ocean. As one proceeds up the Coppermine, trees appear in irregular patches not so much in the valley of the river itself as in the valleys of its tributaries. Along the east side of the river we found that north of the mouth of the Kendall, the spruce nowhere extends more than about ten miles up any of these creek beds, and on the west so far as we could judge by looking across from hill tops with our field glasses, the woods are even more closely confined to the river. Just north of the mouth of the Kendall we crossed from the east to the west bank and found that not only is the Kendall Valley itself densely wooded all the way to Dismal Lake, but the higher lands to the north of it are also banked with scattered groves of spruce. Dismal Lake is about thirty-six miles long and is curved as shown on Hanbury's map and not a chain of lakes as described by Dease and Simpson and shown on most of our

maps and charts. There is a considerable growth of spruce around the east end of the lake for the first five or six miles from its outlet, and then for about thirty miles it is flanked on either hand by Barren Ground, but there is a dense grove of trees at a creek mouth at the southwest end of the lake. Crossing here and descending south into the valley of the Dease, it is only a matter of a mile or so from trees on Dismal Lake to the trees of the Dease Valley which run continuously down to the northeast corner of Bear Lake.

South of Dismal Lake there is, however, what amounts to an island of Barren Ground surrounded as it is by the woods of Dismal Lake, Dease River, Great Bear Lake, and the Coppermine. It is on the high hill tops of this rocky section, that the Eskimo chiefly camp in summer.

It is commonly supposed, no doubt from the knowledge of Greenland, that most of the Arctic Islands are covered with an ice cap. This is so far from being true that so far as I know, there is not a vestige of a glacier anywhere either in Victoria or Banks Island and they are everywhere covered with green grass and flowers, except in districts that are too rocky for plant growth.

#### FUEL.

The most important item of fuel among the Copper Eskimo is, of course, the blubber of the seal. Except in special emergencies this is the only article of fuel used in winter in Victoria Island or on the mainland, although the Kanhiryuarmitut on southeast Banks Island use also the fat of the polar bear to some extent. It makes little difference whether driftwood is abundant or scarce in any district, it is never used during the part of the year when people live in snowhouses. It would manifestly be unsuited for the heating of a snowhouse and as a matter of fact, as I know from experience, the seal oil lamp is better suited for the heating of any kind of a substantially built Eskimo house than wood is, even when burned in sheet iron stoves. But in the spring when the snowhouse is discarded for the tent and the people move from the sea ice inland to hunt, the supplies of oil are all left behind at the coast and either wood or heather is used. Among the Noahonirmiut, for instance, we found in the latter part of May, 1910, that families living six or eight miles from the seacoast had taken with them two or three sticks of wood equivalent to as many stout cord wood sticks and these they were eking out for cooking purposes. The man of the family would take an adze and with it make fine chips or shavings which the woman would feed one by one into a tiny flame built under the bottom of the pot. In this way a very small piece of wood could bring a good-sized pot of meat to a

boil. When this was done they intended, they told us, to find heather (*Cassiope tetragona*) underneath the snow and use that for fuel. Later, when the sun had cleared the snow away, it would, of course, be easy to find the heather which is the favorite fuel of the Copper Eskimo.

The Eskimo of my party were all westerners and used to cooking with driftwood or willows. When during the summer of 1910 we traveled around with parties of the Copper Eskimo, my companions insisted that they were not going to cook with "grass." They seemed to look upon the very idea as degrading in some way; and would scout around in search of bushes of willow which they maintained would make a much more satisfactory fire. The result was that our local traveling companions would have their camp pitched and supper cooked before we got our fire lit and proceedings in our camp were usually suspended while we went over and joined them in their supper inviting them later on to come and share ours which was ready an hour or so later. Towards the end of the summer my westerners had finally become convinced that the use of grass was really not necessarily degrading, with the result that we could get our meals as quickly as the natives.

There is a special art about burning heather. You must make a small fire and feed in a handful at a time, keeping the blaze uniform. In most Arctic districts where I have traveled, you cannot walk half a mile without finding a patch of heather big enough to cook several meals by. You build the fire in the proper place and within ten or fifteen feet of it you can gather sufficient fuel for cooking. We found it convenient to carry a small stick of dry wood with which to make shavings to start the fire on damp days, for when it is wet the heather is not easy to light, but with the fire once going there is no more trouble about it.

The Bear Lake Indians are unfamiliar with the use of heather for fuel, which greatly handicaps them on their annual incursions into the Barren Ground in search of musk-oxen. Like my western Eskimo companions they understand the use of willows, but on the Barren Ground, patches of these are few and far between and quickly hidden beyond chance of discovery by the blizzards of early winter. Consequently the Indians on their musk-ox hunts carry sled-loads of wood which burden them and decrease their speed. When the wood has been exhausted the party retreats towards the forests of Bear Lake again. The local Eskimo are under no such handicap. Even in the depths of winter, they could always find heather to burn, as the Back River people do in fact, as we know from hearsay. The Eskimo with whom we personally associated never leave the sea ice in winter and consequently have no occasion for any fuel except oil.



## FOOD.

*Vegetable Foods.* The Eskimo of Alaska from Kotzebue Sound south along the coast depend to some extent on vegetable foods, not only in summer while these are growing and can be gathered for immediate use, but also in winter when the people draw on stores gathered in summer. The Mackenzie district is as well supplied as some Alaskan localities with edible vegetables, but very little attention is paid, or was, until a few years ago when Alaskan immigrants began to teach them the use of berries, leaves, and roots. The summer hunting districts of the Coronation Gulf Eskimo, too, are rich in vegetable foods, but the knowledge of their use is on an even lower level than in the Mackenzie Delta. That proximity to the vegetable-eating Indians of Alaska and not the richness of any given district determines the amount and variety of vegetables used, is one of the many reasons for thinking that the Arctic coast population did not come to their present home down the Mackenzie or from the Yukon. Had they come from a district rich in vegetables to a district rich in the same vegetables they would not have forgotten their use.

Berries known as paunrat are eaten by all the Copper Eskimo, and a few other sorts are occasionally tasted. The most substantial and palatable fruit found on the Arctic coast is the *akpek* (salmon berry). This grows abundantly on the summer hunting grounds of the Coronation Gulf tribes and is sure to be found also on Bathurst Inlet. Its use, however, was never discovered in this locality, though the name seemed to be known. It was the natives of our own party who first induced trial of these berries, and only a few of even those who spent most of the summer of 1910 near us acquired a taste for them. So far as we could learn the *akpek* was under no taboo, it simply had never occurred to anyone that they were food.

The one vegetable of some importance among the Copper Eskimo is the root known to them as *mahu* (Alaskan, *masu*). These can be dug for food at any season, though it is difficult to find them in winter under the snow. In summer they are eaten chiefly in times of scarcity, but occasionally from choice.

The *mahu* (*Polygonum bistortum*) is a parsnip-like root. Large specimens may be half an inch in diameter and ten or more inches long. They sometimes fork into two or more branches. They seem of better flavor and less "woody" if gathered from sandy soil. If boiled and then kept in bags, as is the custom in Alaska, there develops an agreeable mild acid flavor and the roots become excellent eating to the taste of most white men. The Copper Eskimo never keep the roots to sour, but eat them from hand to mouth, either raw or boiled.

Probably because of greater abundance of other foods, these roots are less used in the Mackenzie Delta than even in Victoria Island. They are abundant on the rivers flowing into the foot of Prince Albert Sound, and are said to be fairly common, too, in certain parts of Banks Island.

Reindeer moss is never gathered for food directly from the ground but is a highly relished dish when found in the paunch of a caribou. It is eaten warm with the warmth of the animal, or cold; preferably, however, the paunch is let lie in the sun several days till the contents begin to ferment. West of Cape Parry seal oil is poured over the soured mass, making a kind of salad; the Copper Eskimo, however, never take oil with them inland, and so far as we know do not have the opportunity of eating moss and oil together. No taboo would prevent their doing so, however, as land and sea foods are everywhere freely brought in contact as well as meat, vegetables (*mahu*), and oil.

Besides the undigested moss from the stomach, partly digested food from other portions of the alimentary canal is eaten. Among the Puiplirmiut especially, we saw deer droppings picked up from the snow and eaten directly; here they are also gathered in pails and kept in the house to be eaten as wanted. In Alaska caribou droppings are commonly used to thicken blood soup, or were, until white men's taboos began to restrain the practice. Some quantity of vegetables is also consumed through the eating of the stomachs and intestines of hares, marmots, and ptarmigan.

*Animal Foods.* Most of the Copper Eskimo depend chiefly on seals for food in winter. Fish are said to be caught at all seasons by the Ekalluktogmiut; the Kanhiryuararmiut secure a large number of bears in midwinter in southern Banks Island and all tribes secure stray foxes and wolves now and then. Musk-oxen are never hunted by the Kanhiryuararmiut in winter, but if a band wanders down to the coast between Nelson Head and De Salis Bay the opportunity is taken advantage of. We never heard of caribou being killed in winter either on the mainland or on the islands west of Bathurst Inlet. Among most of the tribes in question no taboo prevents caribou hunting at any season, so far as our questions could bring out; it simply has never been tried. Among half a dozen tribes I have myself been assisted by natives in caribou hunting on the sea ice, and I have seen caribou meat and seal meat eaten at the same meal by members of the following tribes: Nagyuktogmiut, Kogluktogmiut, Pallirmiut, Puiplirmiut, Noahonirmiut, Akuliakattagmiut, and Kanhiryuararmiut. Some families said, however, that caribou and seal meat should not be cooked in the same pot unless the pot were suspended over the lamp by a fresh cord when the caribou meat was to be cooked; but most people paid no attention to even this prohibition.

In bear hunting among the Kañhiryuarmit two or more men usually hunt together. Sleds are not used, as for instance in Smith Sound and among other eastern Eskimo, but dogs loose or in leash accompany the hunter. When a bear is either accidentally met with or is found by the following of a fresh trail, the dogs are turned loose. They overtake the animal and hold it at bay by barking and by nipping its heels when it turns to run. On close approach it is then shot with arrows or speared with lances improvised by lashing the hunting knife (iron or copper) on the end of a

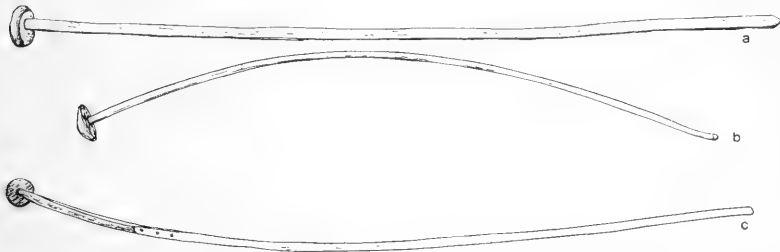

Fig. 1 *a* (60-6941), *b* (60-6931), *c* (60-6930). Probes for Seal Holes, made of Bone, Coronation Gulf. Probe *b* is tipped with musk-ox horn. Length of *a*, 90 cm.



Fig. 2 (60.1-3462). Seal Indicator of Ivory, Prince Albert Sound, Victoria Island. Length of needle, 30 cm.



Fig. 3 (60-6943). Seal Indicator of Ivory, Coronation Gulf. Length of *a*, 34 cm.

long walking staff (*aiaup?ak*) which Eskimo usually carry on their hunts, whether in winter or summer.

The Kañhiryuarmit is the only tribe of Copper Eskimo in whose food supply polar bears play an important part. There are two localities where this hunt is feasible — the southeast coast of Banks Island between Nelson Head and De Salis Bay, and the southwestern point of Victoria Island — Cape Baring. At Cape Baring, however, the “open water” gets farther and farther from shore as winter advances and the people depend more and more on seals as the bears retreat with the retreat of the floe. Near Nelson Head, however, the floe is always near shore, for whenever an easterly wind

blows the ice moves off into the Beaufort Sea. Accordingly this locality is rich in bears, and they form the chief article of food in winter for the larger portion of Kañhiryuarmit. Even for fuel, bear grease here largely replaces seal oil, though occasionally the bear hunters near Nelson Head trade bear meat or fat for seal blubber to their neighbors towards De Salis Bay, for these do not depend exclusively on bears.

There is but one sealing method in winter. All tribes of the Copper Eskimo, except those Kañhiryuarmit who live on bears and those Ekalluktogmiut who live on fish, seek level stretches of ice on which to pitch their camps. So far as we know, the Kañhiryuarmit are the only ones who ever build winter houses on land or even near land, but it is probable that the Ekalluktogmiut do also. These ice encampments are moved from time to time, for the seals within a five-mile radius of any spot are soon exterminated



Fig. 4 (60.1-3462d). Copper Probe for Seal Holes, Prince Albert Sound, Victoria Island. This copper rod is square in cross-section and seems to have been formed by beating together thin sheets of the metal. It is the most remarkable specimen of copper work in the collection. Length, 77 cm.



Fig. 5 (60.1-3468). Pull for Cord used in hauling Seals, Prince Albert Sound, Victoria Island. Length, 11 cm.

by the hunters. Seals in winter are necessarily non-migratory, as each depends for his supply of air to breathe on the hole in the ice which his own teeth have kept open in spite of the frost.

Of a morning the various hunters start out from camp, usually before daylight, in directions radiating from the encampment. Each is followed by his dogs, one or more, but never over three, for a man who is wealthy enough to own three dogs is sure to have a grown son or a dependent who also goes sealing and needs a dog. The main business of the dog is to find a seal hole; secondarily, he is to drag home the seal if the hunt proves successful. The seal's breathing hole at the upper surface of the ice is but an inch or two in diameter; downwards it widens out, and has thus the shape of an inverted funnel. If it is the home of a female seal about to become a mother the mouth of the hole is enlarged sufficiently to allow the animal to crawl on top the ice and make a cave for herself in the hard snowbank above. But be the

seal male or female, be the hole small or large, there is nothing in the appearance of the snow roof above it to indicate its presence to the eye, unless indeed a wandering fox has smelt it out the night before and stopped above it to investigate, leaving its tracks to tell the story. Be a seal hole to windward a dog will smell it at a considerable distance; the finding of it is usually therefore the least of the hunter's troubles. When the general locality is discovered the position of the hole is accurately determined by prodding the snow with the caribou antler probe till its point slips into water instead of meeting the hard ice. If the snow roof is thick it is thinned down considerably by scraping away with the snow knife. When so thin that it is not likely to offer much resistance to a lance-thrust, the "feeler," a slender bone or antler rod, is thrust down through the snow until its lower end is just below the surface of the water. When this is done the hunter cuts himself a block of snow for a seat, spreads a skin rug in front of it to keep his feet from the snow on the ice, and sits down by the hole to wait. The lance lies ready by his side.

The seal must come to the surface frequently to breathe, and the hunter's wait would therefore not prove a long one had the seal but one string to his bow. He has several. In the neighborhood of any seal hole there is a group of several others that have been made by and are used by the same seal. Though the hunter may have done his work so carefully that the seal's suspicions remain unaroused, yet mere chance may prevent for hours and even days his visiting the hole where the captor awaits him. It may happen therefore that the hunter sits from daylight till dark and from daylight till dark again, awaiting the sign of his quarry's approach. If fortune favors, however, the hunter may have his seal in half an hour.

When the seal rises to his hole to breathe his nose pushes upwards the slender "feeler" that has been so arranged that its upward motion is unimpeded. The hunter rises from his seat, which was so near that it is not necessary for him to step forward to be in a position to drive his lance vertically downward into the hole; if he needed to make a step forward the crunching of the snow under his foot would warn the animal of danger. When the indicator rod has been elevated as much as it can be, and just as it begins to fall the lance is driven down alongside it, usually striking the seal in its neck or shoulder. The thrust usually goes home; against a good hunter no more than one fluke in ten chances should be recorded.

When the seal has been speared the hole is enlarged with ice pick or knife sufficiently to allow the animal to be hauled out, this after its strength has been partly exhausted by its struggles. As it is about to be hauled out it is despatched by a stab in the head or, occasionally, by a blow on the head with a club. For killing the seal, among the Kañhiryuarmit at least, a special instrument is used, this is described elsewhere.

If the seal is of the common small kind, the man has little trouble holding him by the stout harpoon line and the hole is soon enlarged with the ice chisel and the animal hauled out on top of the ice. In the case of the gigantic bearded seal, however, the struggle is often severe, the line may break, the harpoon-head pull loose, or the hunter may have to let go. This latter seldom happens, for two reasons: it is considered a great disgrace to let go one's hold, and secondly, the harpoon point, especially if it be of iron, is an article of great value and must not be lost. A single hunter may get, in this manner, three or four seals in a day, or, he may go a week without getting one. But his neighbor's catch is his, no less than his own would be. A man's success is the good fortune of the community as much as his own, he has the work of getting the seal and the praise of a successful man is his; otherwise, the seal belongs to all alike, except for the skin, if that is to be used for clothes rather than eaten. When a seal has been caught, if the village be not far off, the hunter often sends the dog home dragging the seal by the harness which the hunting dog always wears, while he stays in the hope of getting another; if the village be far off (three to five miles) the seal is not taken home till evening. Some hunters, discounting success, will take along two or even three dogs, sending one dog home each time a seal is caught.

It is not common that more than a week's supply of meat accumulates in the village, but the supply of blubber steadily grows beyond what is needed for food and fuel, and often a family has seven to ten sealskins full of oil (fifteen hundred to three thousand pounds) to cache against the need of the next autumn, the period of scarcity.

The method of securing bearded seals is the same essentially as that employed against the common seal, except that two men occasionally join forces, for the animal is huge and powerful and difficult to hold after it is speared. Few bearded seals are secured in winter for they frequent chiefly shore waters, and the seal hunting tribes seldom approach land until towards spring. The stretch of strong current in Dolphin and Union Strait from Lambert Island east to Cape Krusenstern is richer in bearded seals than any other locality accessible to the Copper Eskimo. The ice here is never over two or three inches thick and the seals bask on the ice even in February with the temperature below  $-40^{\circ}$  F. I have here counted over forty bearded seals visible with the naked eye from shore, as many as ten sometimes crawl up through one breathing hole.

Except among the Kañhiryuarmit the winter from October to April is generally a hand to mouth struggle. Starvation may, and does, occur at any time, but generally the sunless days are most feared. There is seldom a winter that among one or another of the Copper tribes dogs do not die of



Fig. 6.

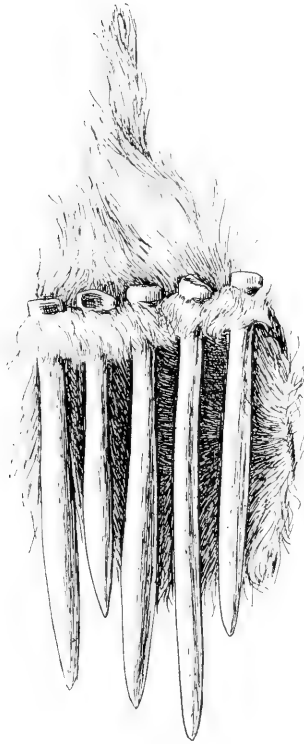

Fig. 7.

Fig. 6 (60-6970). Seal Harpoon, from Mouth of the Coppermine, Coronation Gulf. Length, 1.86 m.

Fig. 7 (60-7032 a-e). Set of Seal Wound Pegs, Coronation Gulf.

hunger; dried sinew and clothing are eaten and the houses are without light or fuel. Specific instances of deaths from hunger are detailed in another place.

In April and early May seals are still the main food of the people and the methods of securing them remain what they were in winter. During this period the Kañihiryarmiut move from Banks Island to Prince Albert Sound, Victoria Island, and the other tribes divide or move in single bodies towards either the mainland or the Victoria Island shore. The Akuliakatagmiut consider the appearance of the first seal on top of the ice in their locality (about May 20th) as a sign it is time to leave the sea for the fishing lakes. No member of this tribe or of the Haneragmiut, we were told ever tries crawling up to a basking seal in the manner familiar from many other Eskimo districts. Among the Puiplirmiut and Noahonirmiut (in portions of whose hunting districts seals bask on the ice even in winter) about one in three of the able hunters knows this method and uses it more or less. In Coronation Gulf again the method is not much used.

All tribes of the Copper Eskimo in April and May have their camps on ice across which the caribou migrate in thousands on their way north. None of these make any use of their opportunities so far as we could learn. Especially the Noahonirmiut near Lambert Island and the Kañihiryarmiut on Prince Albert Sound see endless successions of small bands passing their very doors. As mentioned above, there seems no taboo on caribou killing or caribou meat at this season, but we were merely told "nobody ever hunts caribou on the ice" — they live in abundance of seal meat at this time and blubber gathering is their most important object. It would really be foolish for them to spend their time pursuing the skinny migrating cows, if they did they would have to face the winter without the store of blubber that is their salvation at the time of autumn scarcity.

In April no starvation came to our notice, though we found a Puiplirmiut village on short rations May 6, 1911, in Simpson Bay, Victoria Island. These had plenty of blubber, however. Each family lays by at this season as much blubber as it can. This is cut in small pieces and placed in bags made by skinning a seal through the mouth. Each of these bags when filled with oil will weigh one hundred seventy-five to two hundred fifty pounds and one good hunter will fill two or three such bags during March, April, and May. When it comes time to go inland these are placed *en cache*, preferably on a small island. Be the caches on an island, or not, they are covered with large stones so as to be safe from bears; people, it is said, never steal from such caches. At the same place are also cached usually the winter lamps, the heavier stone pots, the winter clothing and all good clothes, and in fact everything that is not absolutely needed for the summer. On account of taboo restrictions no blubber is taken along inland.



Most people move inland while there is still snow on the ground; a few remain on the coast till the thaws are well under way, and some even stay on or near the coast all summer; notably certain of the Puiplirmiut in Simpson Bay, most of the Pallirmiut at the mouth of Rae River and some of the Kogluktogmiut at Bloody Fall on the Coppermine. Nothing is rigid about these arrangements;—the summer 1910, for instance, Bloody Fall was unoccupied.

On May 7th, 1911, the first three families of the Puiplirmiut moved inland into Victoria Island from Simpson Bay. They expected to camp by some fishing lakes and to live mainly on fish till the ground should be bare of snow some three or four weeks later. They no doubt tried for caribou too; at any rate we found on May 24, 1910, that some Noahirmiut had already begun deer hunting about fifteen miles southwest of Lambert Island. By May twenty-sixth, however, they had not themselves secured any caribou as yet, and had no food when we left them but the carcasses of two bucks that we shot just before leaving their neighborhood. The women of the party fished every day for small lake trout with their copper fish hooks and caught about half enough to feed the party. The Kañhiryuarimiut whom on May 19, 1911, we left still encamped on the ice in the middle of Prince Albert Sound expected to move inland in about two weeks and to live partly on fish when they got inland.

The musk-ox plays no part in spring among any Victoria Island tribes directly known to us, nor among any people on the mainland much west of Gray Bay. About Gray Bay and east of it musk-oxen are more numerous and are said to come down towards the sea in the spring, but to what extent they are killed while the snow is still on the ground we do not know. The pursuit of these animals will assume new phases now that guns are about to be introduced in Coronation Gulf. It is said there are some musk-oxen east and north of Minto Inlet, Victoria Island, so the Kañhiryuatjiairmiut may get a few occasionally.

Hares and ptarmigan are shot with bows and form part of the food supply in spring, summer, and fall.

An important food animal in the mainland districts is the marmot (*Spermophilus parrii*). These awake from their winter hibernation in April and when they first come out of their holes they are rolling in fat and are excellent eating. Many are killed with bows and many are caught at the mouths of their holes with slip nooses of slender braided sinew. It is generally not difficult, except for large parties, to secure enough of these to feed men and dogs. Certain sections, especially rocky barrens, are largely wanting in squirrels, however, while others, such as the flats of Rae River and the lower twenty miles of the Coppermine, are abundantly supplied.

It is only on Banks Island and southwestern Victoria Island that polar

bears are common at any season. A stray bear may find its way into Dolphin and Union Straits and Coronation Gulf, especially in the spring. One at least was killed by the Puipirmiut in 1911. I have however, both among the Akuliakattagmiut and in Coronation Gulf, seen grown men who have never seen a live polar bear. Brown bears (*Ursus arctos Richardsoni*) are quite absent from Victoria Island but most mainland tribes kill one of them now and then, especially the Akuliakattagmiut. If found still in the stupor of hibernation they are easily despatched, but if awake (any time after the middle of April, or even sooner) they are more difficult game than polar bears. One or two good dogs will generally keep a polar bear at bay; it is seldom dogs can hold a barren ground bear. At close quarters, too, they are more dangerous than white bears both to men and dogs, and many a man bears the mark of their claws. They are however attacked single-handed, by hunters armed with only the bow and knife. We were told that the hunter sometimes pays for his venturesomeness with his life; of this, however, we learned no specific instance, though I saw among the Kogluktogmiut a man whose eye had been scratched out and who had been "confined to the house" the larger part of the summer as a result of the mauling he got.

In summer caribou are the chief source of food, although in certain districts fish, birds, and eggs, barren ground bears, and musk-oxen, play a more or less important part. Fishing is of most significance in early spring. When the first seals appear on top of the ice, about May fifteenth to May twentieth at Cape Bexley, the supply of blubber, the winter clothing, oil lamps, etc., are put in safe caches under heavy stones, usually on small islands, and the people move inland by sled, taking along a little seal oil (not nearly enough for all summer) and little other food. Individuals of some groups, such as the Pallirmiut, sometimes go inland only after the snow leaves the land, carrying packs instead of using sleds. A few people stay near the sea all summer, especially at the mouth of the Coppermine. Generally, the objective point with those who move inland early is a fishing lake that is also frequented by caribou and while the men hunt the women fish with hooks. As the hooks are not barbed they are seldom "set." Later, when the water courses become free of ice, fish are often speared at certain well-known spearing places. These spears are of the three-pronged Eskimo type with handles sometimes twenty feet long or longer. The barbs of these are usually of copper, though they may be of iron, bone, or antler. If fish are caught in large numbers they are often dried by being spread out on flat stones, hung up on deer antlers, etc., seldom on wooden racks, even where wood is available. Perhaps the most frequented spearing place is at Bloody Fall on the Coppermine. No fish nets or fish traps are used or known.

For spearing caribou a few members of the Puiplirmiut, Nagyuktogmiut, Pallirmiut, and Kogluktogmiut still use kayaks. Formerly, they say, while caribou were more numerous, kayaks were more numerous and much used. A few even of those who hunt farthest inland carry kayaks by sled or on their backs to astonishing distances from the sea. The summer of 1910 seven or more kayaks were brought to the lake, Imaernirk, in which the middle branch of the Dease River heads. One of these came from the Kent Peninsula and had been packed on the back a hundred miles of that distance by Itigaaittok ("The Footless") whose toes and insteps of both feet froze off a few years ago and who has only the heels of his feet to walk on.

Many spearing places have of late been abandoned. One of the favorite ones up to a few years ago was Dismal Lake, at the Narrows (Cf. Hanbury's Account). This was last occupied by a single family the summer of 1909 but they got no deer and nearly starved. The summer of 1910 half a dozen families spent a part of the summer on Imaernirk Lake but were finally starved out. The Kogluktogmiut, perhaps the best caribou hunters as a group, carried no kayaks inland the summer of 1910, though they use them for crossing the river those summers when they fish at Bloody Fall instead of going to the Bear Lake hunt.

The method of waylaying and spearing caribou is the same as elsewhere described by Eskimo and need not be here described.

All the hunting practically is with the bow and arrow, either by simple stalking, or, by driving bands of deer towards concealed hunters. The first consists merely of approaching the deer to seventy-five yards or less by such methods as the character of the ground and the other special features of each case suggest. Just before sending the arrow, the hunter usually abandons all attempts at concealment and makes a sudden dash towards the caribou, thus usually getting fifteen or twenty yards nearer than was possible by stealth, for sometimes the animals will not at once notice a man running at them though upright at close range and even when they see him their minds seem to work slowly and it takes them a second or two of staring to make up their minds to run, and then they do not always run directly away, but as often as not at about right angles to the approach of the hunter. The first run is often, too, only a dash of a dozen bounds, after which they stop to have another look, and thus give the hunter a chance to speed three or four arrows. At close range an arrow that does not strike a bone will go entirely through the largest bull caribou and often fly a considerable distance on the other side. An animal wounded by an arrow that stays in the wound, and all do, unless they pass clear through, usually lies down to prevent the arrow from working in the wound, and is then easily approached for a second shot. I have known a single hunter to separately approach and kill three isolated caribou in a single day.

Most of the caribou killed, however, are secured by the concerted action of several men, women, and children, even the dogs help. When a band is discovered feeding, a V-shaped "fence" is constructed somewhere beyond their line of vision, generally to leeward. The "fence" consists of straight lines of stones or pieces of sod raised on end and set twenty to forty yards apart. In spring, blocks of snow are used instead. These stones, sods or blocks of snow are often not over eighteen inches high and no particular pains need be taken as to their shape or appearance, though a dab of earth is usually put on a block of snow or light colored stone so as to make sure the animals will see it. Apparently the eyesight of caribou is very poor, as compared with that of man. When this fence is completed, a half dozen men make one a mile long in an hour, the men conceal themselves in the angle of the V, the women and children with the dogs, go to windward of the deer to drive them. Usually the deer do not see the women who go to their windward. A few long-drawn wolf howls will generally set a band of deer in slow motion before the wind, or in the direction they are migrating. If they attempt to pass outside one of the wings of the V, someone is there to turn them, and usually the band moving in single file along one side the V-shaped fence, much like horses along a barbed-wire fence, arrives at a walk or slow trot at the point where the angle of the fence becomes so narrow, about one hundred yards, that they begin to notice the fence on the other side and to see there is no opening. Then they bunch up irresolutely and give the hunters a good opportunity to shoot. Members of our party have seen only as many as eleven caribou killed in this way by four hunters and half-a-dozen women and children. It is uncertain how many they get in lucky hauls, none can tell themselves, for none can count, but they considered eleven a small catch. Perhaps six to eight animals per hunter may be near the ordinary limit, though we have been told that occasionally not a single animal escapes of those that once enter the fence.

When deer have been killed in some number, most of the meat is cut up and half-dried, never fully dried, spread out on stones. The blood is always taken and used for soups, and the moss contents of the stomachs are allowed to ferment a few days in the sun and then eaten. This last dish, fresh or fermented, is about the only article of vegetable diet used by these Eskimo.

Most of those groups who hunt on the mainland kill a barren ground bear (*Ursus richardsoni*) now and then. These animals are not found in Victoria Island. A few musk-oxen are killed by the Kanhiryuarmit only in Banks Island, by the Akuliakattagmiut west and northwest of Dismal Lake, and by the more easterly people in the district towards Kent Peninsula and southward perhaps to the Akiliniik River. Otherwise, musk-oxen are extinct from the mainland and Victoria Island in the districts frequented

by the groups under discussion. Where there are musk-oxen they are naturally an easy prey for the Eskimo, who surround them with their dogs and usually kill every animal of every band found.

A few wolves and foxes are killed every year, with the bow, for there is little trapping, and a good many spermophiles (marmots) are taken. The skins of all of these are valued for clothing, though deerskin is preferred, and the meat of all is eaten, though only the marmots are secured in numbers to make them of significance as sources of food. The Akuliakattagmiut and others kill a few muskrats, but they use neither skins nor meat but only use the tails for charms. This, as well as lack of knowledge of common berries as food, may go to show that the present territory has not long been occupied by these people. Further, had they come to Coronation Gulf either from the south or west they would have brought with them the habit of using these things, and would not have forgotten it while occupying the present territory which, comparatively speaking, abounds in berries and has numbers of muskrats. (As to the muskrats, however, the Bear Lake Slaveys say that they, as well as the beaver and the moose are new arrivals north and east of Great Bear Lake. This may explain the Eskimo ignorance of their use.)

All groups shoot a few ptarmigan with bows; the only ones to whom birds and eggs are of much significance are those who summer in Victoria Island, some of these are said to kill numbers of swans and smaller water birds during the moulting season. The skins of all birds are used for hand wipers after eating greasy food, and the skins of loons are used for slippers between the socks and outer boots in winter. Loon skins are also used during the fly season in summer to beat off mosquitoes.

#### COOKING AND HANDLING FOOD.

Caribou meat is more often eaten raw than cooked, whether fresh or half-dry, thawed, or frozen. Fish are also often eaten raw, whether frozen or not. This eating of raw meat and fish conforms to Eskimo custom farther west, except that the western people show greater preference for the frozen state as opposed to the thawed. A raw dish peculiar to the Straits and Gulf Eskimo (at least, the Eskimo of my party knew nothing of such a practice) is fresh sealskin cut in small pieces with about a quarter inch of blubber left on it. The hair is not removed. I found this agreeable eating on first trial, but our Eskimo would not taste it, they had "never heard of such a thing." All western Eskimo, however, practice eating the skin of the bow-head and white (beluga) whales in a similar manner.

In general, these Eskimo are not so fond of "high" or partly decomposed fish as are those of the Mackenzie River and farther west, who generally prefer rotten to fresh fish for eating raw. Meat is more often eaten "high" here than farther west, but that seems a result of circumstance and is not a matter of preference. Caribou liver is, however, highly esteemed here, as everywhere to the west, after being allowed to ferment for some days under a hot sun inside a moss-filled caribou stomach. Seal oil fermented in an air-tight bag from spring till fall is by all Eskimo, and those whites who have tried it, much preferred to the fresh.

There is really but one method of cooking and that is boiling, though roasting before a fire is known. Fish and caribou are more often eaten raw than cooked, but caribou heads are always boiled and fish heads are boiled when convenient. Seal is seldom eaten raw, and never raw unless frozen, except in emergencies. The cooking is over the seal oil lamp in winter and generally over a fire of heather or small twigs in summer, even when good wood is at hand. The pots (stove) are long, narrow, and shallow, a large pot may be thirty inches long, eight inches wide, six inches deep. The seal meat or deer meat is usually cut in pieces of such a size that half of each piece sticks out of the water. In cooking over the lamp the meat (at least the first potful) is put in the cold water as the pot is hung over the lamp flame, and when the pot boils the lower half of the meat is considered cooked. The pieces are then turned around and now and then after that one is lifted out of the pot and squeezed between thumb and finger to see if it is sufficiently cooked. When one of the larger pieces seems done, the pot is emptied of the meat and some seal or caribou blood is added to make the blood soup which forms the last course of a properly arranged meal.

In a snowhouse, where space is limited, the guests usually eat standing, while the master of the house, his wife, and perhaps an especially honored visitor sit on the edge of the bed. The woman divides the meat into as many (or more) pieces as there are people present, squeezes each tightly between both hands so that no blood or juice shall later drip on the floor while it is being eaten, and hands the best piece to the guest of honor, e. g., a visitor from another village. If there is no especially distinguished guest, the woman hands the best piece to her husband, she will not keep a good piece for herself though she may make up for that by eating a few tidbits between meals. Each person present has a piece handed him in turn, the order being generally one of age, the oldest first. A middle-aged woman will be served ahead of a young man though an old woman or a decrepit man may be ranked lower than a middle-aged one. A few usually get a second helping, though I have never seen enough pieces of meat at a meal to go twice around.

When the meat course is finished the warm blood soup is dipped up with

musk-ox horn dippers and these are passed around in about the same order as the meat was. Several persons often have to use the same dipper in succession; a single house seldom has more than five or six dippers and twelve or fifteen people often eat in a single house. If the pot is not large enough to satisfy all present, then it is filled with meat a second time, or a few of the younger people are given frozen instead of boiled meat. In case of two or three boilings, each potful is eaten while the next is cooking, and the blood soup course follows only the last potful of meat.

The foregoing is based on the practice of the Akuliakattagmiut and Haneragmiut, who were the only ones visited while still living on the ice or by the seashore in May, 1910.

The summer food being caribou and fish mainly, there is less cooking done in summer than in winter, though there is usually one cooked meal per day, the morning meal commonly. The last course here too is generally warm (never hot) blood soup, though I have seen caribou blood drunk un-boiled. Birds and spermophiles are almost always cooked, and as above stated caribou heads always are. Marrow bones are cracked and the marrow eaten raw; caribou back fat is sometimes boiled and the intestinal and kidney fat usually is boiled. Eggs are always boiled if a fire is available.

#### DWELLINGS AND FURNITURE.

The general style of the Copper Eskimo snowhouse is fairly well shown by our photographs.<sup>1</sup> They are built in a manner similar to that employed by the Mackenzie Eskimo. In Alaska the construction of proper snow-houses is an unknown art. A sort of snowhouse is built at Point Barrow, the groundplan is usually rectangular. The blocks are huge and stuck on edge in a slip-shod way and rafters of wood are used to support the roof. The true dome house is first met at the Mackenzie River.

The snow is cut with a snow knife into blocks that have a surface area of something like eighteen by thirty inches and are about four inches deep. Among the Copper Eskimo this method of cutting snow blocks is rarely used and chiefly in the fall while snow is still thin on the ground. In winter when good snowdrifts can be found, the cakes are cut of about the same length as in the Mackenzie district but with a depth of eighteen inches instead of four so that while the finished block is the same size and shape as that used by the Mackenzie people, it is obtained by a different method. In other words, the snow block in the Mackenzie district is, while it is being

---

<sup>1</sup> See "My Life with the Eskimo."

cut, in the position of a domino lying flat on a table, while the block among the Copper Eskimo is cut in a position of a domino standing on edge.

The snow dwelling houses of the Mackenzie Eskimo proper were used only on journeys and under special circumstances. Among the Baillie Islands or most easterly branch of the Mackenzie people, snowhouses were frequently lived in all winter although wood and earth houses were also used. Among the Copper Eskimo no other form than the snowhouse is now in use nor was any other house in use in the past so far as the people themselves know. The Cape Bexley people were familiar with the wood and earth houses used on the section of coast west from them to Cape Lyon, but I infer that this familiarity came through the ruins of the houses only because they made about them some statements which are absurd in the light of our knowledge of the characteristics of the Eskimo house of the western type. They said that the people of this section of the country used to live in snowhouses in winter and in earth and wood houses in summer. The nature of an Eskimo house is that so soon as the sun begins to thaw the snow on its roof in the spring, the house begins to drip and must be vacated. This is true, I know, all the way from Point Hope east to Baillie Island and must be true wherever houses of the type are used. All summer the floor of one of these houses is a puddle of water and it is only next fall after the ground is thoroughly frozen that the dwellings become again habitable. It appears to me therefore an essential absurdity to suppose that the houses of which we saw the ruins west of Crocker River were used as summer dwellings.

The snowhouses of the Mackenzie people seem to have averaged considerably larger than the ones in use by the Copper Eskimo. It was common enough at Baillie Island that it was something like nine or ten feet from the floor to the top of the dome. In the east, however, houses of this size are erected only on special occasions when dances are to be held. One such house was built to celebrate our coming to the Akuliakattagmiut and was about nine feet in height and accommodated forty people standing up, with a circular space of about five feet in diameter left in the center free for the dancers.

The largest dwelling house we ever saw in actual use was among the Kanhiryuarmit, where nine people slept under a single roof. At the time we were there they were using snow walls and a skin roof in that particular house, but we were told that the same family had occupied a snowhouse until a few days before. Five or six may generally be considered a large number for a single snowhouse and if there are only two or three inhabitants, the house is commonly no more than five by seven feet in the dimensions of its floor space and five and a half to six feet high from floor to the center of the dome.



By the eastern method of cutting snow blocks so as to have them standing on edge as they are cut out of the drift it is possible to complete a house entirely from the blocks that are cut out of the floor; in other words, a single man without assistance can easily complete a house and finish it to the last detail of the "key stone." By the western method this is not possible for a second man is required to stand outside, cutting blocks and bringing them to the builder, or else, the man who does the building would have to cut a door in the wall of the house he is making and crawl out through it to fetch blocks with which to continue the work.

The principles of snowhouse construction have been so often discussed that there is not much use for going into them here in detail; besides our photographs are in a measure self-explanatory. It is worth pointing out, however, that while the Eskimo of the Mackenzie River are rather particular in building up the house in a continuous spiral which seems from the accounts of other travelers to be a method also in use in many other districts, the Copper Eskimo take no pains to follow this method. In the building of a large house, for instance, there are sometimes three men working at different parts of the wall and one of them may have his section five feet high while neither of the others has got beyond three feet and there will be high and low places in the wall so that it presents a serrated appearance. All that is necessary in order that the snow blocks do not cave in is that no part of the wall shall be absolutely straight. The curve must be continuous; if then the ends of two blocks are properly trimmed so that they fit together they cannot possibly cave in without breaking. The same principle applies to the finishing steps of a dome roof. The roof may be almost flat but it cannot be quite flat for if it were the blocks would fall in of their own weight. Still, an expert snowhouse builder will make a roof so nearly flat that it is difficult to see it is not perfectly so.

When the key stone has been put in place the next thing is to arrange the interior. It is intended that the bed shall be on a platform anything from eighteen inches to three feet high which occupies about two-thirds of the oval floor space. Commonly the house has been excavated to about a depth equal to the desired height of the platform by the taking out of the floor of the blocks that went to construct the walls and roof. If this has been the case, the builder has been careful to leave a little shelf running all around the wall, but if that has not been convenient he will cut from what remains of the floor a series of blocks and stand them up on edge around the wall, or if there is not material enough inside the house to do this have it brought in. Then the floor blocks are passed in to the house by the builder's wife or someone who remains outside. The longest of these has a length equal to the transverse diameter of the house and by being put crosswise

forms the front edge of the bed platform. The shorter ones are put farther back, the shortest forming the foot of the bed. In other cases, however, there is one piece put crosswise on the side to form the front edge of the bed platform and the others at right angles to it lengthwise of the house. The skins are spread over this platform and household gear is stowed away under it.

If, however, no planks are at hand out of which to make the floor of the bed platform, the entire platform is built up out of snow. The disadvantage of this method is that it takes a little more work and that it gives you no stowage space underneath the bed. After the bed platform has been prepared it is the woman who does the rest of the work. She comes in and spreads the skins over the bed and then she puts up the blubber lamp, either setting it on a block of snow or else by the use of uprights and cross pieces of wood she sets up a table upon which the lamp stands and above which the stone cooking pot is to be swung. When everything is in readiness she takes a little blubber, crushes it with a blubber pounder and about half fills the bowl of the lamp. Then she takes from a bag either a piece of moss or some fuzz of the pussy willow and spreads a layer for a wick along the forward rim of the lamp. She now strikes a light by knocking together two pieces of iron pyrites above a bit of pussy willow fuzz which is used for tinder. When the lamp has been lit it is trimmed so as to burn with the greatest possible heat and then the door of the house is sealed up with a block of snow. In about half an hour the house becomes so warm that the snow of its walls and roof begins to melt. As the melting goes on the water does not drip but is soaked up into the snow blocks blotter fashion until finally they are nearly or quite soaked through. The woman occasionally feels of the walls by pressing her knuckles into them and when they are the requisite degree of dampness she puts out the lamp and opens the door. In a few minutes the intense cold which rushes in from the outside freezes the wet snow blocks and the house is turned from a fragile structure of snow that would crumble if you touch it carelessly to a vaulted dome of ice so strong that a polar bear might crawl over the roof without the danger of breaking it in. This in fact often happens in districts where polar bears are numerous.

The house is now fit for occupancy and will be occupied as long as circumstances require. When the weather is cold out-of-doors, it is possible to keep the snowhouse very comfortably warm for the cold from the outside neutralizes the heat from within and no melting takes place, but if the weather turns warm, melting soon starts. If the house has been perfectly built the dome is of such even curvature that no water drips down, but only trickles down the sides. If there is any unevenness, however, dripping will

commence. This is temporarily dealt with by pressing a block of dry snow against the spot from which the water drips. This block will adhere to the roof without any danger of its dropping until it becomes thoroughly soaked before which it should be removed and be replaced by a dry block. Occasionally, however, one naturally forgets to do this and it is not uncommon to have a block of soaking wet snow drop on the bed upon your head or into any food that you are eating.

Outside the door of the house is an alleyway anywhere from ten to thirty feet long with its floor on a level with the floor of the house. Both the outer door and the alleyway and the door of the house itself remain open day and night and there is commonly also a small ventilating flue in the roof so that the interior is always plentifully supplied with fresh air. This is universally the case except in times of famine when seal oil becomes too precious for food to allow its being used for fuel and then, of course, it will be necessary to decrease in size the ventilating openings to keep up the temperature of the house.

Sometimes two families will occupy the same house in which case the woman of each family has a separate lamp for cooking standing on either side of the door as one enters. More commonly two families, if for any special reason they want to live together, will build a double house. There is a single alleyway at the inner end of which there are two doors leading into the two houses. Again, there may be a three-room house or three snowhouses built adjoining each other and intended for the occupancy of two families. In this case there are generally two alleyways leading into the houses at either side while there is interior communication between the two houses and the central common room furnished by the third house between them. It is also common that a house has an alcove for storage purposes either built on to the house or excavated into the snowbank in which the house stands. This alcove is used chiefly for the storing of meat and blubber although other articles may be kept there as well. Sometimes these storage alcoves are built into the wall of the alleyway just outside of the door of the house in which case they have to be closed with snow blocks for the dogs of the family occupy the alleyway and would help themselves if unrestrained.

When the warm weather of spring comes upon a snowhouse village that is already built, the roofs will cave in while the walls remain intact. A few sticks are then put up for support and skins spread over. Only caribou skins are used, although sealskins, bearskins, and musk-ox skins are used in emergencies. If, however, a village is built during the changing weather of spring, snow walls are put up with the intention of using a tent roof over them in which case they are built rectangularly instead of ovally as they

would be if they were to be roofed over with snow. This is a sort of a transition stage and all the dwellings of this time are makeshift ones so that they may be of any shape. The roofs may be flat, pyramidal, or of the general outline of our A-tents, differing from them, however, usually in that the ridge pole is never as long as the floor of the house and the roof therefore slopes in from all sides instead of from two sides only as in the case of our common tents.

The tents in use in summer from Cape Bexley to the Kent Peninsula as seen near Bear Lake the summer of 1910 may be described as A-tents with bell ends. Commonly the tent of last year is during the winter cut up and used for some purpose, perhaps it has been fed to the dogs, or possibly it has been needed for bedding. The tents of all but the most provident families are therefore very small and unsatisfactory but each time a caribou is killed its skin goes to increase the size of the tent and by the latter part of summer everyone is suitably housed. The skins are always used with the hair side out whether they be sealskins or caribou skins. I have never seen musk-ox or bearskins used in summer. They are useful only in the transition stage while the snow walls are still in use and while the people are still able to haul their belongings in sleds. In the summer, when everything has to be carried on one's back, none but light skins can be conveniently used. The tents range from little bits of three-cornered shelters where skins are spread over the two sides leaving the lee side open, to long affairs with a floor space say six by fourteen feet and a door in one of the long walls. In this sort of a tent two families live, one on each side of the door while the shelter first described merely keeps the rain off the heads and upper parts of the bodies of two or three people who use them. Their feet stick out into the open as they sleep and if it commences to rain, they either get soaked or else the people have to get up and sit huddled inside their shelter.

The triangular shelter, of course, has no ridge pole; its frame is a mere tripod. A good-sized ordinary tent used by a single family will have a ridge pole about five foot long supported on either end of the tent by a tripod of sticks about seven foot long, the third leg of each set being so placed that the floor of the tent will have an extreme length of about nine feet. This frame is by its construction rigid and is completed by leaning up against it at various points any number of sticks that happen to be at hand. The skins that form the tent cover are sewn in one piece and are spread over the tent frame something in the manner employed with Indian tipis. It is not intended, however, that a fire shall be built within the tent except for smudge purposes, to keep out mosquitoes. There is therefore no design to have an opening at the top of the tent. It is, however, a matter of fact that little care is taken in lacing the skins together at the top and a little rain will accord-

ingly come in all along the ridge pole and especially at the two ends where the upper six or eight inches of the poles that form the tripods stick out through the roof of the tent.

An Eskimo family usually needs such a quantity of gear that there is room for but a small part of it inside the house and it is kept outside either on top the roof or on a rack especially constructed for the purpose. Most of this belongs to the woman's department of the family and consists in large part of partly worn-out clothing, tanned and untanned skins intended for garments, bundles of sinew for sewing thread, and things of that sort.

Some of the main items of the furniture of the snowhouse have already been indicated: the planks that form the floor of the bed platform, the stone lamp, and stone pot with which the cooking is done, the wide board that forms a table in front of the lamp, and the round rods that are stuck vertically into the floor and horizontally into the walls of the house form the framework that supports the lamp and the cooking pot and upon which the drying frame rests above the lamp. The drying frame is a hoop commonly oval in shape perhaps two feet by four in size. There may be one or two rods across this hoop to keep it rigid or there may be only thongs stretched at right angles to each other across the hoop so as to form a network upon which mittens and other small articles can be spread without any danger of their falling through into the cooking pot or lamp underneath. On the table in front of the lamp will usually be found some platters made of wood for holding meat and dippers of musk-ox horn from which the blood soup is drunk. There is also a woman's knife, the rod of antler which she uses in place of a fork to turn over the meat when it is boiling and to fish it out of the pot when it is done, the blubber pounder of musk-ox horn to crush the frozen seal blubber before it is put into the lamp, and the short flat-tipped stick that is used for trimming the lamp. There is also kept convenient a little pencil-like stick the end of which is charred and stuck in grease. This can be made at any time to form a torch if anyone wants to look in a dark corner of the house or under the bed or something. By the door is a flat stick like a ruler that is used for beating the snow out of the clothes when anyone comes in from a blizzard. This is usually done out in the alleyway while the snow is still dry and powdery on one's clothes. If you were to come into the warmth of the house the snow among the hair clothing would soon become damp and would stick instead of flying out easily as it does when clothes are beaten while the snow is still dry with cold.

The furniture of the summer camp is even simpler than that of winter. In Coronation Gulf there are certain small islands upon which all sorts of household belongings can be safely left for the summer and everywhere the greater part of the property of a family is left behind in spring, although

the cache may be nothing safer than a heap of stones which a polar bear might easily break into. Polar bears, however, are exceedingly rare, so that the danger is really not very grave. Commonly when they move about, the grown members of the family carry all the household things as well as the small children; the dogs are loaded with nothing but the dry meat and with the tent poles and the handles of fishing spears which they drag along somewhat as did the dogs of the more southerly Indians.

For some reason, apparently not a taboo, no seal oil is carried inland and consequently the seal oil lamps are all left behind. Only the smallest stone pots are taken not only because they are heavy, but also because the large ones are so fragile that they would never get through a summer's hunt unbroken. Even a pot no larger than twelve inches long by seven wide and six deep is so breakable that no one but the housewife is entrusted with the carrying of it and she wraps it carefully in a bundle of bed skins and carries it on her back. Two or three musk-ox horn dippers will also be carried for use in drinking the blood soup but the wooden food platters are all left behind, for stones or grass can always be found upon which the boiled meat can be spread for the meal. Unless the woman's sewing kit be considered an article of furniture, we have hereby exhausted the list of the furnishings of the typical camp.

#### HOUSEHOLD UTENSILS.

Most lamps and cooking pots are made of stone secured on a small mainland river that flows into Coronation Gulf "a short distance" east of the Coppermine. This river is called Kugaryuak but is often referred to as Utkusiksalik (the place where there is material for pots).

The lamps are of the type already familiar from Point Barrow.<sup>1</sup> This is to be expected if, as the Mackenzie people say, the Point Barrow people used to buy lamps at Barter Island from the Mackenzie Eskimo who got them from the Baillie Islanders, who in turn got them from farther east. Lamps and pots were formerly costly in the west as compared with other artifacts, but are now cheap on Coronation Gulf, another thing that points to the Gulf as the source of pots, etc., used farther west.

We have seen lamps in use ranging in length from six to forty-three inches. If the lamp is too short for the entire length of the pot or pots swung above it, a second or third is used, so as to give a flame equal to the total length of the bottoms of the pots. For wicks, moss is sometimes used

<sup>1</sup> Cf. Murdoch, John. *Ethnological Results of the Point Barrow Expedition.* (Ninth Report of the Bureau of American Ethnology, Washington, 1892.)

as at the Mackenzie River, but more often the cotton-like fuzz of a plant found in marshy places. This seems to make a wick superior to the moss used in the west, for at the Baillie Islands, etc., the snowhouses are usually discolored inside by lampsmoke, but old winter houses at Cape Bexley to our surprise showed no lamp black on the walls.

Pots seldom vary much in depth or width (about eight inches wide, and six inches deep) but may be anything from ten to forty-five or more inches in length. These pots, especially the larger, are very fragile and are a constant care to the women. The larger ones are never carried inland to the hunting and fishing grounds in summer; the ones that are taken along are carried by the women wrapped inside a big bundle of skins. In winter each housewife keeps two pots at least in continual use, one for cooking, the other for melting drinking water. The pots are so swung on rods that they can be shifted over the lamp flame or beyond its influence. The length of the lamp flame is constantly varied according to the warmth of the house or the urgency of bringing a pot to the boiling point.

The blood soup that forms the last course of every cooked meal is drunk from dippers of musk-ox horn. These differ strikingly from the sheep horn dippers in use west of the Mackenzie, through being so shaped that they will stand on any flat surface without danger of upsetting, and in having a handle less than two inches long against handles of eight to twelve inches to the west. Some housekeepers have as many as five or six of these dippers, though two or three is more common. At a meal the head of the house or an important visitor gets the first dipperful but never gets a second helping until all present have had their turn. The woman who serves, drinks last, but grown women present are preferred to boys. Rank at meals is by age irrespective of sex; decrepit persons rank below those of middle age.

Shallow wooden dishes are used as platters for meat, cooked or raw;

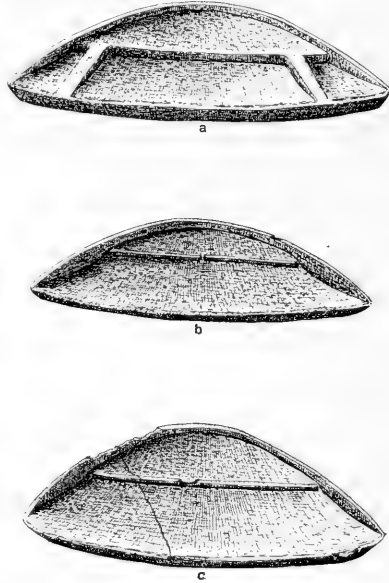

Fig. 8 *a* (60.1-2862), *b* (60.1-3458), *c* (60.1-2871). Stone Lamps: *a*, Point Barrow; *b*, Coronation Gulf; *c*, Mackenzie River type. Length of *b*, 60 cm.

pails of sealskin are used for carrying and keeping water; bags of sealskin are used for oil and blood; and bags of one sort of skin or another are employed by the men to keep safe small tools, fragments of metal, etc., and by the women for scraps of skin, needle cases, knives, etc. In eating, both sexes prefer to use ulus (women's knives), a copper ulu is preferred to a man's iron knife. The women's needle cases are of the lowest long bone of the foreleg of the caribou. Clubs or mallets of musk-ox horn are used for pounding blubber before it is put in the lamp so the oil may run out more freely.



Fig. 9 (60.1-3211). Stone Kettle, found on an Island in west Darnley Bay about three Miles off Parry Peninsula. Length of fragment, 47 cm.

Campsites are chosen with more care in summer than in winter. In the fall the Kogluktoarmiut, they told us, are kept from moving out on the ice to the best sealing grounds by the lack of suitable snow for house-building everywhere except near shore. Why the Akuliakattagmiut remain near shore at Cape Bexley through the fall, till about the disappearing of the sun, we did not learn, but the reason is most likely the same. After midwinter, however, a village can be built wherever the ice is a little rough and has gathered snowdrifts of sufficient depths for house blocks and that is in several places every square mile of even the levellest ice the Straits can show. Of course, villages are seldom found in winter except in good sealing localities. What is a good site for a sealing village one year may not, however, be equally good the next for the seals, though more dependable than caribou, frequent certain localities more one year than another, the fluctuation depending probably largely on the season at which the ice forms in the fall and on the conditions of calm or storm under which it forms and its consequent roughness.

The summer of 1910 we saw several hundred sites of summer camps, two dozen or so of which were occupied when we saw them. The location is always marked by the stone tent rings (the stones that have been used to hold down the tent flaps) and usually by numerous other works of man, shavings of wood, bones and horns of animals, flat stones raised on edge for fireplaces, drying frames for meat, or for windbreaks, etc. Over ninety percent of these are situated on hill tops that give a commanding view of the surrounding country. The reasons for choosing such hill tops were given as follows: (1) Fear of Indian attack; (2) Desire of a good view of the caribou feeding grounds; (3) The advantage of a wind-swept hill in mitigating the plague of mosquitoes and sandflies. Those that hunt toward Bear Lake told us the nearer they camped to the lake the more carefully they chose their campsites for "you never know when or from where the Indians may come."



Another consideration in choosing a campsite is that there shall be enough stones for camp purposes, to fasten down the tents, to form windbreaks, fireplaces, etc., to furnish suitable slabs and boulders on which to spread meat to dry, and perhaps most important of all, to give a background with which the color of the tents so harmonizes as to make them difficult to perceive from a distance. The tents generally have a mottled appearance due to the use of whole caribou skins, the animals are much darker on some parts of the body than on others. This harmonizes well with the huge moss-grown boulders and stone slabs that cumber the hill tops about the sources of the Dease and along the Coppermine to McTavish Bay of Bear Lake. A dozen tents are often so artfully pitched that the men and dogs moving about them can be seen at a greater distance than the tents, while an Indian

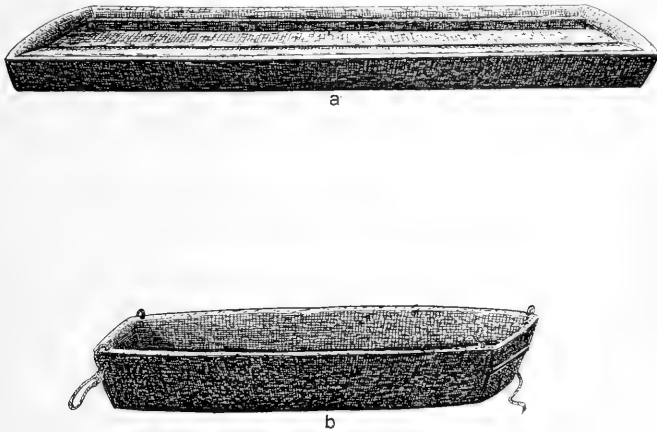

Fig. 10 *a* (60.1-3457), *b* (60.1-3455). Large Lamp, and a Kettle from Prince Albert Sound, Victoria Island. Length of *a* 1.8 m.

lodge or a white man's tent can usually be seen four times as far as could men standing around them. In August, 1910, our camp was for a few days located a quarter mile across a small lake from an Eskimo camp of some seven tents. Though this camp was on the skyline as seen from ours, we had the greatest difficulty in making it out without the use of glasses, so little did a tent on the skyline differ in shape and color from a boulder on the skyline. Looking from their camp to ours the small details of arrangement could easily be made out.

A third desideratum is the presence near by of a considerable supply of heather for fuel. There seems to be a prejudice against camping near wood, or even using it for fuel. If wood is used at all in cooking, a small dry stick is brought to camp and chopped into shavings with an adze. The chief



a

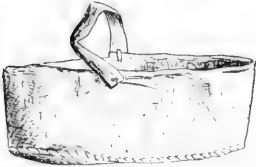

b

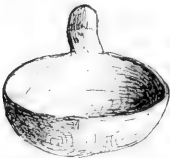

c

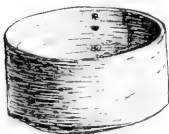

d

Fig. 11.



Fig. 12.

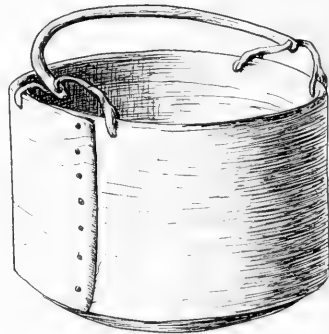

Fig. 13.

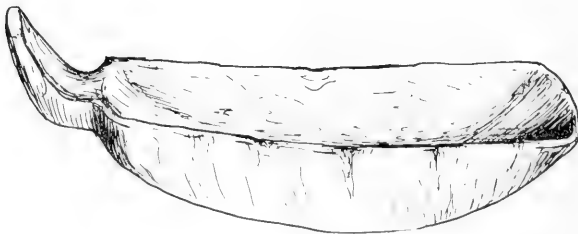

Fig. 14.

Fig. 11 *a* (60-7066), *b* (60-7065), *c* (60-7067), *d* (60-7071). Models of Vessels, Coronation Gulf: *a*, food dish, made of a knot from a tree, diameter, 9 cm.; *b*, pail made of skin; *c*, dipper made of wood; *d*, food dish made of wood. Length of *a*, 9 cm.

Fig. 12 (60-7073). Model of a Horn Spoon, Coronation Gulf. Length, 8.5 cm.

Fig. 13 (60-6963). Wooden Pail with Bail of Horn and Copper Rivets, Coronation Gulf. Height, 12 cm.

Fig. 14 (60-7027). Small Spoon of Musk-ox Horn, Coronation Gulf. Length, 14 cm.



Fig. 15 (60-7006). Fork made from the Metacarpal Bone of a Musk-ox, Coronation Gulf. Length, 29.5 cm.

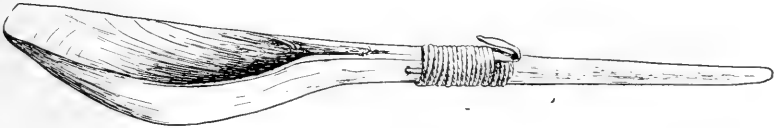

Fig. 16 (60-7028). Horn Spoon with Bone Handle, Coronation Gulf. Length, 40 cm.

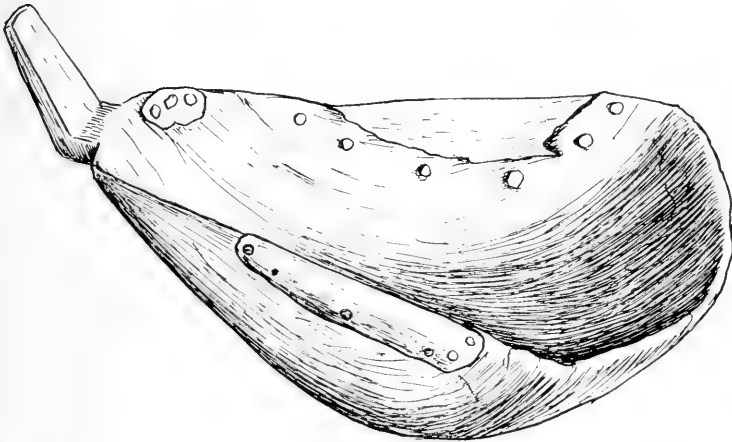

Fig. 17 (60-7024). Horn Dipper, Coronation Gulf. The repairing is with iron and horn plates; copper rivets. Length, 23 cm.

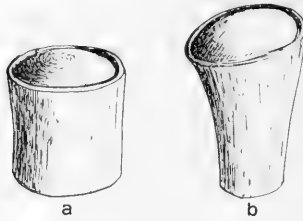

Fig. 18 *a* (60-7070), <sup>7</sup>*b* (60-7072a). Models of Buckets, Coronation Gulf: *a*, bone, *b*, horn. Height of *a*, 3 cm.

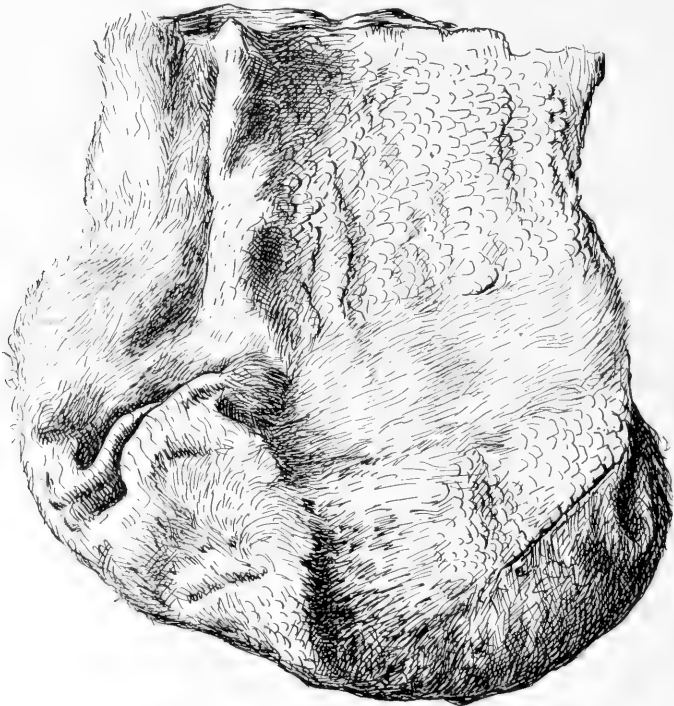

Fig. 19 (60-7053). Bag for Fire-making Implements, Coronation Gulf. It contains two pieces of pyrites each having wrapped grips. Length, 19 cm.

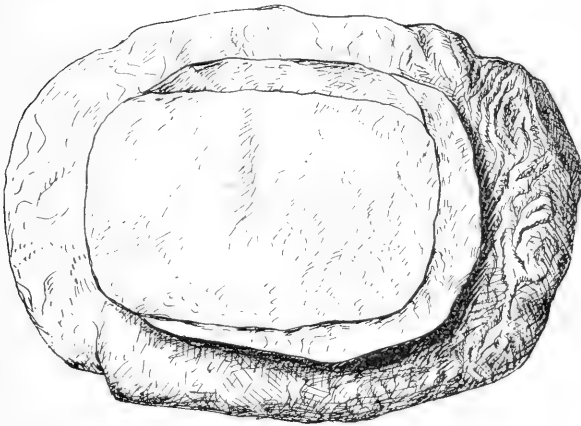

Fig. 20 (60-7062). Bag of Moss for Tinder, Coronation Gulf. Length, 12 cm.

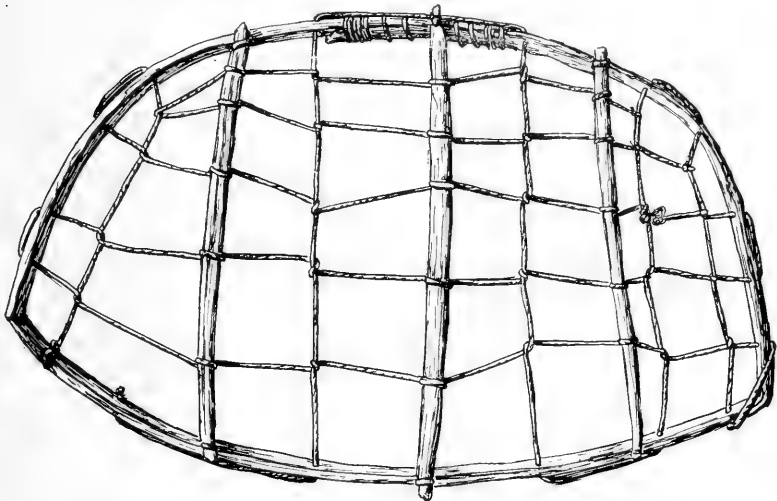

Fig. 21 (60-6967). Frame for drying Clothes, Coronation Gulf. The cord is of braided sinew, the frame of wood. Length, 55 cm.



Fig. 22 (60-6925). Blubber Pounder of Musk-ox Horn, Coronation Gulf. Length, 35 cm.

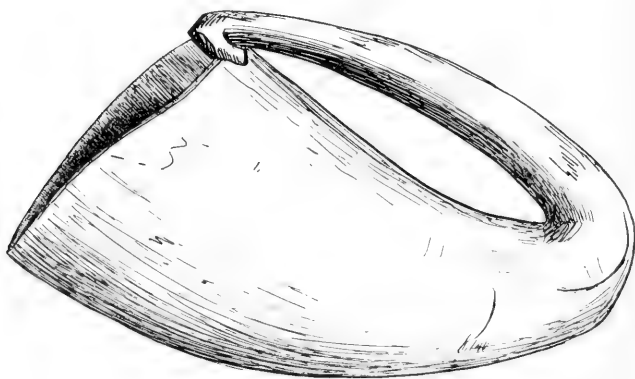
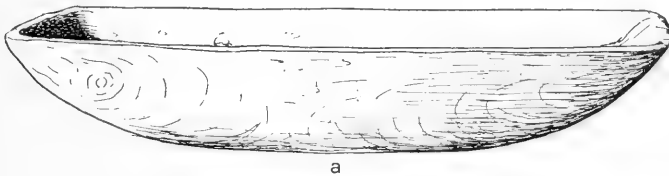

Fig. 23 (60-7031). Dipper of Musk-ox Horn, Coronation Gulf. Length, 18 cm.

reason for doing this I take to be the, to a white man, incomprehensible conservatism of the race, though the shape of their cooking pots furnishes some reason. Fear of enemies cannot be the reason, for a heather fire makes more smoke by a great deal than would an adequate blaze of dry sticks.

In cooking with heather, the oblong stone pots are set up on small blocks of stone about the height of a common house-building brick laid edge-



a

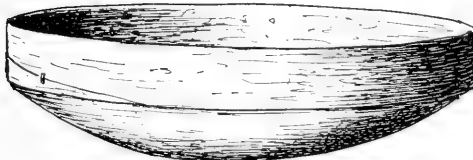

b

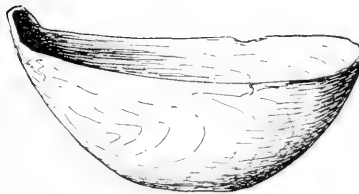

c

Fig. 24 *a* (60-6926), *b* (60-6964), *c* (60-7026). Wooden Ware, Coronation Gulf: *a*, food dish, 69 cm. long, carved from a single piece; *b*, food dish made of two pieces, bottom carved out, sides bent; *c*, food bowl, carved out.

wise, or perhaps an inch higher. A long slab of stone is then taken and set on edge at the back of the pot and two smaller ones at either end of it, so as to form three sides of a rectangular box for the pot. Fire is then built and small handfuls of heather or a shaving at a time of wood are pushed under the pot to keep a low blaze constantly going.

Our own Eskimo refused for a long time to cook with heather when we were traveling with a party of Coronation Gulf Eskimo, saying their people

(Port Clarence, Alaska, and Mackenzie River) never cooked that way. They would therefore hunt far and wide for green dwarf willows, but by the time there were willows enough gathered by our party, further operations would be stopped by hospitable shouts from the other tents to come over and have supper. They had boiled two successive potfuls of meat and sometimes three, while we were getting ready to build a fire. This was too much for the conservatism even of Eskimo and towards the end of the summer our Eskimo could cook a potful of meat as quickly as anybody, though there seemed always an undercurrent of feeling that they were doing something unworthy, and there was much rejoicing in our camp over finding a patch of large willows to camp by, though I cannot see that it helped us to get supper any quicker.

But as our Eskimo prefer wood, for fuel, so the Coronation Gulf people prefer heather. When heather is scarce and far from camp and wood near and easy to get, they often waste much time gathering and carrying heather, but so often do white men traveling with Eskimo waste time and energy doing in their own way what could be quickly and better done in the way of their companions. It is a common human trait, though the Eskimo has it developed more strongly than most other people, more strongly than the most "old-fashioned" European.

Nearness of water is not of much concern in choosing a summer campsite, for good water is found almost anywhere during the Arctic summer, even on top the salt sea ice. Of self-evident importance to the Eskimo (and therefore not needing much consideration) is locating their camps overlooking deer passes, good feeding grounds, places where caribou swim lakes or rivers, etc. The steady decrease in the number of migrating caribou has of late years led to the abandonment of many formerly frequented campsites at swimming places.

#### METHODS OF TRAVEL.

In winter there is little long distance travel by large parties, the individuals and groups of two or three families often make long journeys for trading purposes, to pay visits, or to return to their own people after summer wanderings to distant hunting grounds. Such travel as there is, is by sled exclusively.

The sleds used in Dolphin and Union Strait are longer on the average than any familiar to me among Eskimo farther west, the natives of the Kuwuk and Noatak Rivers have long ones also, while perhaps the shortest sleds used by any Eskimo are those of the Mackenzie Delta and Baillie Islands, three and a half to four feet long. The sled fragments found on



old graves at Cape Parry, Cape Lyon, and east along the coast to the limit of the present range of the Straits people (say Inman River) are all of the short type and correspond in detail to those still in use by some of the Baillie Islanders, the same width of "guage," shape of runners, number of cross bars and manner of inserting the ends of the crossbars into the runners. There are always three crossbars, and the fourth perforation in the runner, that for the hauling lines, is always triangular. The sleds in use in the Straits vary from twelve to twenty feet in length and those of Coronation Gulf average longer. The number of crossbars varies not only with the length of the sled but also according to the fancy of the maker, though there usually are from five to nine. A few sleds in the Straits and as far east as Rae River are shod with whalebone in the usual Eskimo way, strips of bone cut lengthwise from the bone of the lower jaw (inferior maxillary bone) of a bowhead whale. Generally, however, the shoeing of a sled is as follows:—

The runner to begin with, is a spruce wood plank about one and a half inches thick and twelve or fourteen inches high. To the bottom of this is pegged with round wooden pegs a thin strip of wood, the width of the runner. This strip is of as decayed and "fuzzy" a kind as is obtainable, a piece of half decayed driftwood is preferred. In the fall, when the sled is to be used sod is cut in strips as long as convenient and about three inches thick and four inches wide. Lengthwise, along the flat side of these is cut a groove the width of the sled runner and the sod is put under the runners as shoeing. With a little water these are securely frozen to the bottom of the runners, the fuzz of the half-decayed wood holding them securely. The bottom of the runners is then rounded off with an adze or knife so the sod takes the form of a longitudinally bisected cylinder. The last touch is given by turning the sled upside down and washing over the sod runners with a little water to give them a one-tenth inch coating of ice. This ice coat is inspected every day of travel and repaired when necessary; the sod shoeing usually lasts a whole winter without special attention being paid to it. In spring when the sun shines warm a skin is hung loosely over the sunward side of the sled to shield the runners when traveling from the direct rays of the sun, and at camp time, the sleds are buried in snow to keep the sod shoeing from dropping off and the ice coat on its bottom from melting. In various places I have seen different ways of applying ice to the shoeing of sleds but none seems so satisfactory as this, at least, none are so well adapted to use on rough ice or stony ground. Ice is no doubt the best form of shoeing ever devised for sledging at low temperatures. We have seen sleds thus shod carrying a thousand pounds and more of load, traveling at the rate of two miles an hour hauled by one man, one woman, and two dogs.

Traveling in the same company we had some difficulty keeping up with the party with six good dogs and two men hauling six hundred pounds on a steel shod sled such as is now used by all Eskimo west of Baillie Islands. Steel has many advantages and is the best all-round shoeing in spring and fall, but it grates on the snow as on sand when used at temperatures prevalent in the Arctic from December to April. Ice is the best possible shoeing for low temperatures, it most nearly eliminates friction.

Except when carrying blubber and other things to islands, promontories, and other places where they are to be cached, the Straits and Gulf Eskimo usually travel light, but we have never accompanied them on such journeys. Generally, they do not carry even one day's provisions of meat, expecting to catch seal wherever they camp, and thus be saved the trouble of hauling, always irksome to them as few have over two dogs, none, so far as we know, over three, and many only one. We have however, followed the trail of a

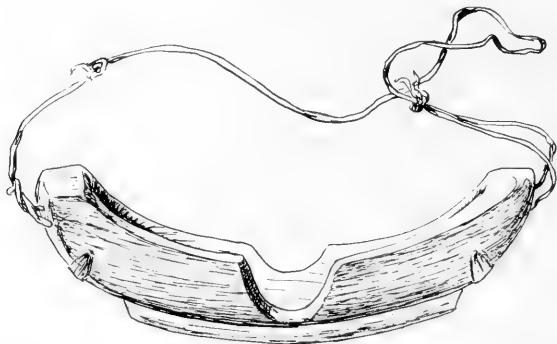

Fig. 25 (60-7054). Wooden Snow Goggles, Coronation Gulf. Length, 14 cm.

party bound for the caribou hunting grounds who kept the coast several days before striking inland. These traveled on an average of about six miles per day. Their chief baggage in winter is the lamps, cooking pots, wooden supports for the lamps, and the pots and woman's table that stands before the lamp, and the boards that form the bed platform of the snow-houses. More than most Eskimo these groups practice keeping a large part of their belongings in caches here and there. This is pretty safe as a polar bear is seen once in many years only (we have spoken with middle-aged men who never saw a bear) and wolverines are absent from a large part of their territory. There are no powerful animals to break caches, therefore, neither wolves nor foxes will break a stone cache.

When bound for the caribou hunting grounds and fisheries in the spring most families start inland by sled, though some are delayed on the coast by

this or that circumstance till the thaws have made sledding impossible. Those usually spend the summer not far inland, though we have seen within ten miles of Bear Lake men who had packed their camps on their backs from the mouth of Rae River on Coronation Gulf. A large kill of caribou near the coast may delay any party till the thaw overtakes them, but commonly they penetrate seventy-five or one hundred miles inland before the disappearance of snow (about the first week in June for the Coppermine district) compels the abandoning of sleds.

When moving camp in summer the woman carries the stone cooking pot wrapped in bed skins, for the pot is very fragile. She also carries, if there be any, pups that are too small to walk and usually she carries the tent besides. If he has a kayak, the man carries this, his bow, arrows, all his tools, fragments of copper for making arrow-heads to replace those lost, and some other odds and ends. The one or two dogs carry backloads of meat and drag the sticks that go to make the tent frames. Thus loaded, the party travels at the rate of about two miles per hour but seldom moves over eight miles per day. The loads carried by the men and women are about of the same weight, and seldom exceed eighty pounds, for if there is more meat on hand than the dogs can carry they either delay till the surplus is eaten or dried down to suitable weight, or else a stone cache is made for the meats to serve as a relay on the return journey to the coast. Generally, therefore, a family returns to the coast by the way it came south in the spring, or else someone else takes up the caches if some special reason sends the owner by another route. Things *en cache* seem to belong strictly to the maker of a cache, though all eat equally of the meat when the cache is once broken. Very seldom does anyone, however, help himself from another man's meat pile, his wife is expected to serve out the food to all who want it.

On a windy day the long kayaks though they weigh not over forty pounds are very awkward to carry, and camp-moving is often delayed by a gale. When traveling a man will usually not take the trouble to launch his kayak on a lake less than two or three miles long. When a sufficiently long lake is found the kayak is put in the water, the rest of the man's backload is stuffed into the after end of it, and the man paddles quickly across. But the speed and ease are not all pure gain, for the wetting has increased the carrying weight of the boat and it has taken time to unpack and repack the load. When there are two kayaks they are lashed together side by side with cross sticks to form a sort of raft capable of carrying a heavy load. In that case the women, who have to walk around the lake, are relieved of a part of their load. This makes travel easier and pleasanter for all, and routes abounding in lakes are therefore chosen when possible. Those lakes will later on too, furnish good sled routes when the party returns to the coast in the fall along its line of caches.

During the summer the people who hunt south of the Dease, chop out with their adzes planks of green spruce and set them up to dry. At the freeze-up the camps concentrate around these places, and sleds are made for the return journey to the coast. Some sleds are well made, if the maker intends it for permanent use or to trade off to the Victoria Islanders; some

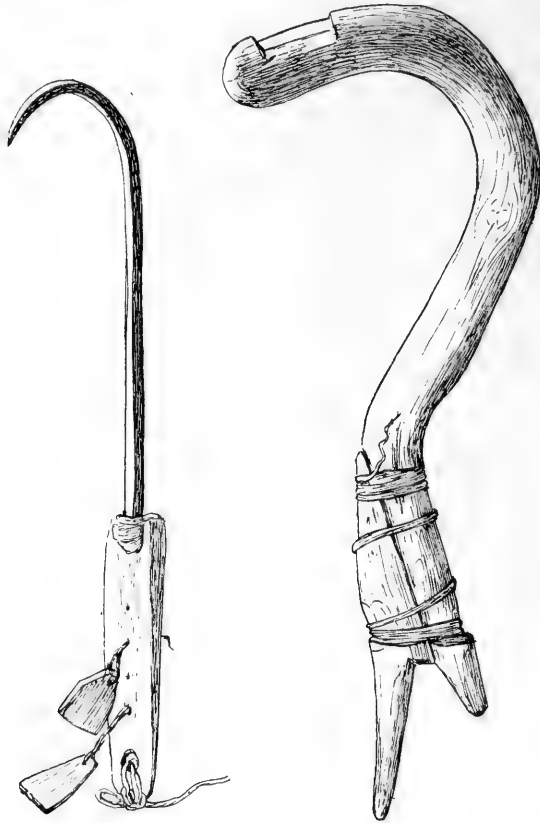

Fig. 26 (60-7085). Copper Fish Hook and Reel, Coronation Gulf. Length of hook, 24 cm.

are poorly made and intended to serve only for a few days or weeks till the cache is reached where they left their good sled in the spring. At these sledmaking places are made also, both for use and to trade, quantities of wooden furniture and utensils, dishes, pails, tables, lamp supports, bows, etc. The favorite sled-making place south of Coronation Gulf is on a branch of the Dease (not indicated on the ordinary maps) that heads near the northeast

corner of McTavish Bay, flows north, west, and then southwest into the Dease, joining that river about fifteen or eighteen miles above its mouth. The immediate locality is a clump of trees only a few acres in extent, located about fifteen miles up stream from the confluence with the Dease. This place is well-known to the Bear Lake Slaveys and is called by them "Big Stick Island." In the fall of 1910 the manufacture of wooden articles here

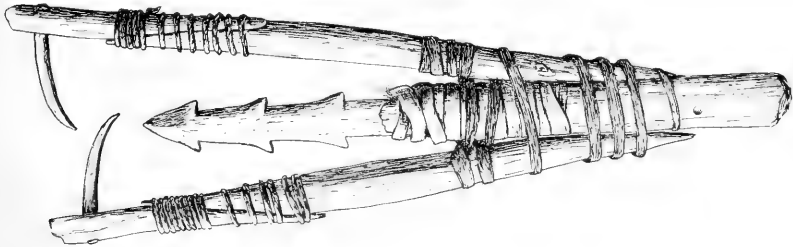

Fig. 27 (60-7086). Three-pronged Fish Spear with Copper Prongs, Coronation Gulf. Length, 39 cms.

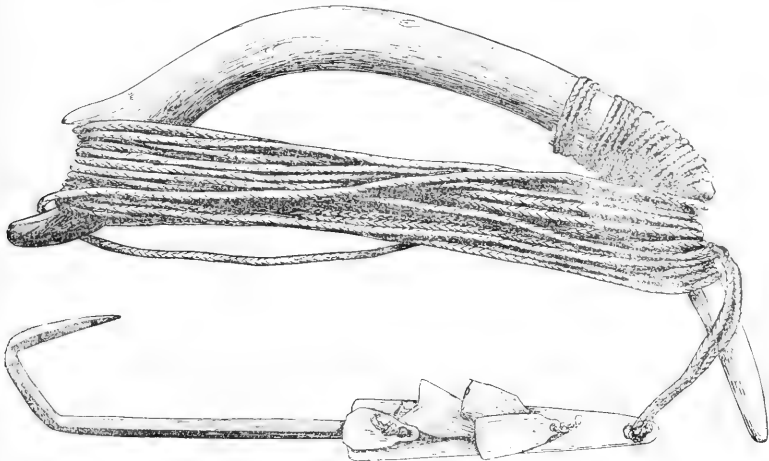

Fig. 28 (60-7084). Copper Fish Hook and Line, Coronation Gulf. Length of Hook, 28 cms.

was interfered with by the scarcity of caribou for food, and many left before sufficient snow came, carrying their sleds on their backs towards Dismal Lake.

The Coronation Gulf and Straits Eskimo use a head strap in carrying heavy loads. Head straps are also in use among the Unalit, Kaviragmiut (inland from Port Clarence), Killirmiut (upper Colville) and generally

among those Alaskans who hunt towards the Yukon and come in frequent contact with the Indians to the south, while we have not seen it in use among the people of the north coast of Alaska, in the Mackenzie Delta, or at Cape Bathurst (the Baillie Islands).

A sidelight is thrown upon the habit of extensive summer movements among these people by some questions we asked a family from the Kent Peninsula whom we saw near Bear Lake. They had been at Bear Lake before, but not habitually, they said. We asked them why they came so far. "But this is not far; we often go farther in the spring to where there are trees." The route by which they came to Bear Lake may have been anything between three hundred and five hundred miles. That they consider this "not far" is significant. Just where they "sometimes go" we could not make sure, probably to Hanbury's Akilinik River.

#### HUNTING IMPLEMENTS AND WEAPONS.

The seal spear or harpoon does not differ in principle from those in use by Eskimo elsewhere. The lance head is sometimes of copper, more often of iron. We have been told that stone heads are still occasionally used, but have seen none, though we have seen stone-headed arrows. The lance warp attached to the detachable head is of bearded seal thong among the Akulikattagmiut but generally of braided deer sinew in Victoria Island. The Kogluktogmiut have both types. That caribou are more plentiful in Victoria Island may be the reason for the prevalent use of deer sinew there.

There are two methods of catching fish, by hook and by spear. The hooks are generally of copper, unbarbed. The spear is of the ordinary Eskimo three-pronged type, the barbs of the two side prongs being of copper, typically, and the prongs themselves of musk-ox horn or caribou antler. These spears are often mounted on handles over twenty feet long. A combination of the hook and spear is found in hooks mounted on spear handles. The difference in use between these and spears is merely that in spearing the fish is transfixes by a thrust, in hooking it is transfixes by a jerk towards the fisherman. The simple hooks are generally used without bait. In using the spear or polo-hook the fisherman holds the shaft in one hand, while with the other he dangles in the water near the spear or hook, a bait attached to a long string. This bait is usually the canine tooth of a wolf or bear.

The caribou spear is used only in connection with the kayak for killing deer as they swim lakes or rivers. There are typically two spears to a set. When the kayaks at the spearing places are made ready to be launched two spears are attached to the deck of the craft, forward of the manhole; in

traveling the spears are usually packed inside the kayak. The head is not barbed nor detachable, as the weapon is intended for repeated successive rapid stabs at the same animal or different animals. The heads of spears seen by us (not over twenty all together) were in about equal number of copper and iron.

The bow is the most important of all the hunting implements. By it is secured in summer all the food of the two hundred or so people who in 1910 hunted south of the Dease River, or at least over 90% of it. I have never seen a fish hook in use here, but have known of one or two fish being clubbed with a stick and of a few ptarmigan being killed with stones. There are no spermophile to be snared in this district.

All bows intended for serious use are of the three-piece or "Tartar" type. Very small boys (under six years) sometimes have toy bows of the

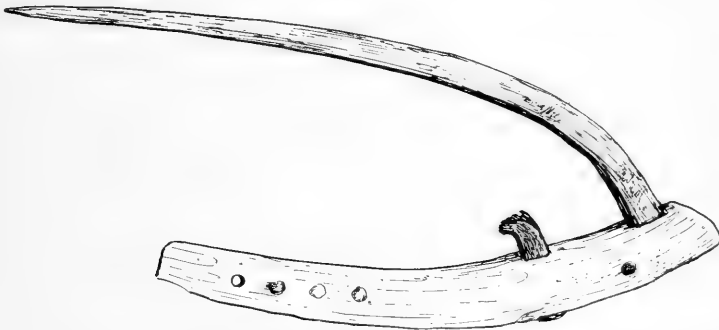

Fig. 29 (60-6972). Copper Pole Hook: In use it is fastened to a long pole. Originally, there were two prongs of copper as indicated in the drawing, the one remaining is 26 cm. long. The shaft is of bone. From the Pallirmiut, mouth of Rae River, Coronation Gulf.

rib of a caribou or musk-ox, or of an unshaped willow twig. Boys of eight years and over, women, and able-bodied hunters alike have three-piece bows, the difference as to the age and sex of the owner being expressed solely through the weight and stiffness of the bow and the length and character of the head of the arrows.

The bows of the Akuliakattagmiut are generally made of driftwood, as well as those of the Haneragmiut and the Victoria Islanders north and west of them. All these get the materials from the mainland shore near Cape Bexley, except the Kanhiryarmiut who secure driftwood to some extent on their own coast, but chiefly on the west coast of Banks Island. All these buy many bows, ready made, however, more especially the Victoria Islanders. In trade among themselves an ordinary seven-inch butcher knife (generally from Hudson Bay) is equal in value to a good bow with

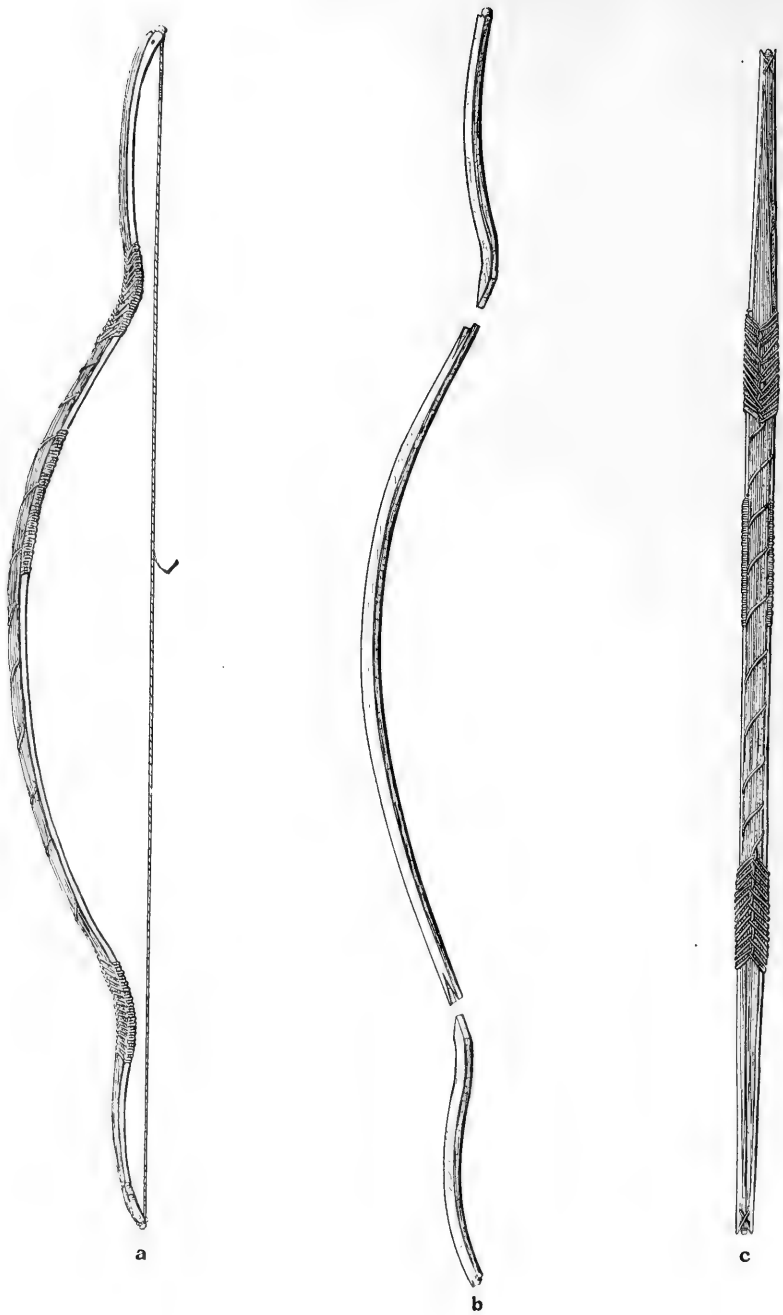

Fig. 30 (60.1-3462b). Bow, Prince Albert Sound, Victoria Island: *a*, side view; *c*, back view; *b*, detail of wooden parts. Length of *a*, 124 cm.



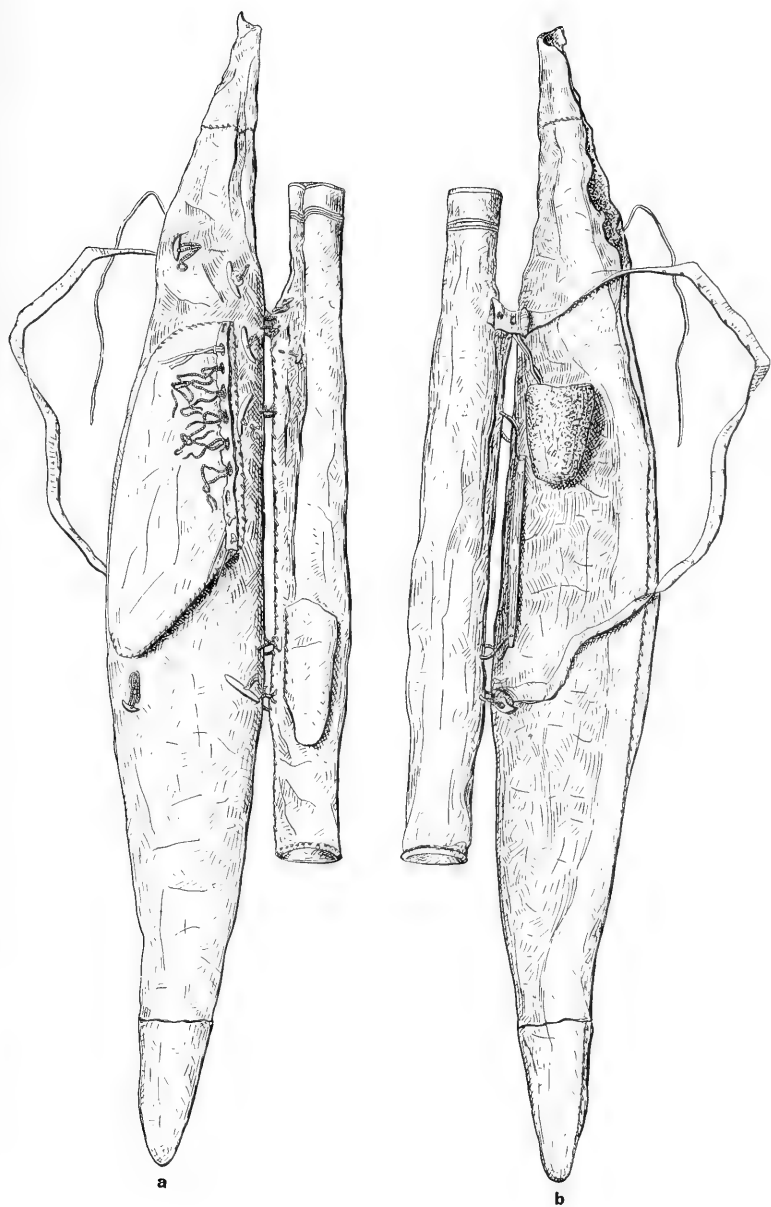

Fig. 31 *ab* (60-6938a). Bow Case, Prince Albert Sound, Victoria Island: detail of both sides and attachments. Length, 137 cm.

bow case, quiver, and full complement of arrows, fifteen to twenty. A "number one" steel sewing needle was worth about the same in 1910.

The Victoria Islanders east of the Haneragmiut, a few families of them each year, practise hunting in summer to the Coppermine and Bear Lake for the purpose of securing wood for bows for themselves and for trade, as

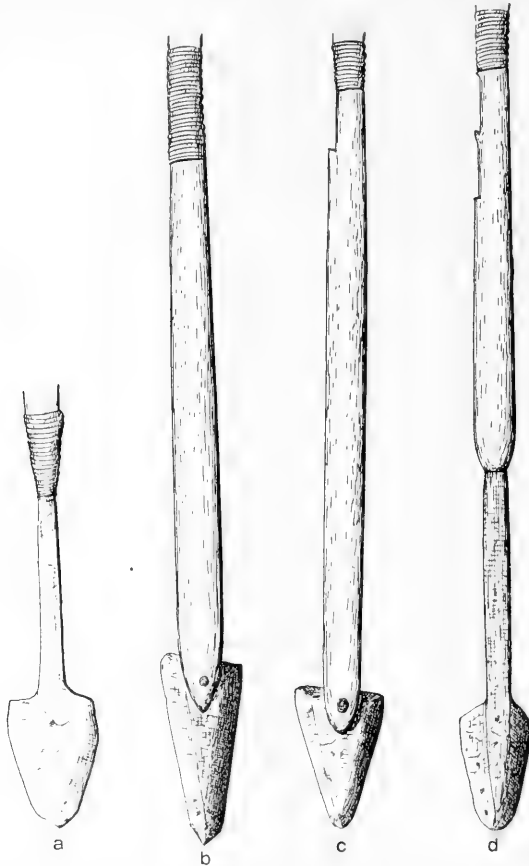

Fig. 32 (60-6975d). Types of Copper Arrow-Heads from the same Quiver as Fig. 34, Coronation Gulf. Length of *a*, 10 cm.

well as wood for other articles. Besides this, they buy many bows, chiefly, perhaps, from the Kogluktogmiut.

The Kogluktogmiut and others who hunt towards Bear Lake make their bows exclusively of green spruce trees. These are chopped down with adzes and roughed-out in midsummer. After drying a month or so the bow materials are further shaped with the crooked knife and perhaps made into bows on the spot, perhaps carried unfinished to the coast in the fall.

The backing of the bows is preferably of the leg sinew of old bull caribou; the leg sinew of smaller animals is also used, and even back sinew. There are three or more different ways of preparing this backing and applying it to the bow. The bowstring is of sinew braided three-ply into a long slender line. This line is then taken four, five, or six-fold and twisted into a round cord from one-eighth to one-sixteenth of an inch in diameter. When the bow is strung the bowstring usually touches the frame of the bow on the two

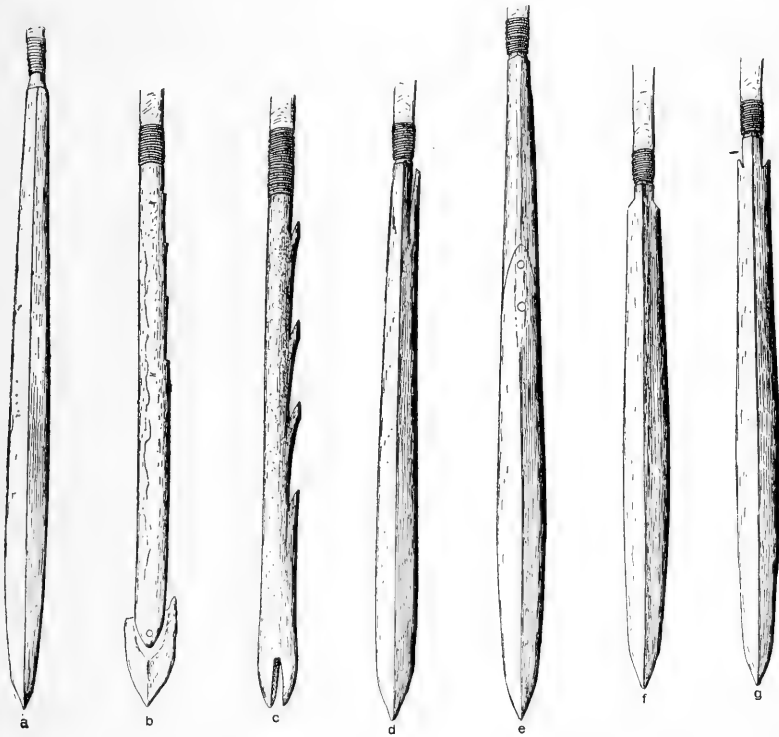

Fig. 33 (60-6939, e, d, k, c, h, f, g). Bone and Ivory Arrow-Heads from the same Quiver, Kent Peninsula. Length of *a*, 23 cm.

convex curves. The length between tips of the strung bow is from four and a half to five and a half feet in those used by men; those for women and boys are smaller in all dimensions with less sinew backing and more slender bowstrings.

The arrows are much longer, by six to ten inches, than those used by the Mackenzie Eskimo or the Bear Lake Slavey Indians. At Kittgaryuit, eastern Mackenzie Delta, I have been told that the standard length of arrows was equal to that from the left shoulder joint to tip of middle finger of

the owner's left hand; there seems to be more variation in the Straits and Gulf according to the strength of the individual and the span and stiffness of the bow, but in general a short arrow is measured between the chin and middle finger tip of the maker, and a long one from the right shoulder joint to the tip of the middle finger of the left hand.

The ordinary arrow (all except the blunt bird arrows used by women and boys, and the "killing arrow") may consist of from three to five pieces when new; a mended arrow may have more parts separately joined together. In other words, the wooden shaft of the arrow may be of one, two, or three pieces, in addition to which there always is a caribou antler head piece pointed with a cutting blade of stone, iron, or copper. Of several hundred arrows seen, over ninety percent were copper-headed and perhaps one percent had stone heads, the rest, tin, iron, or steel. Most of the arrows of the Akulikattagmiut seen in May (we saw only two or three quivers out of over twenty) had a three-piece shaft, but at that time our command of the local dialect was so poor that I could not make sure if the owners had made or bought these arrows; the arrows later seen from Uminmuktok generally had a one-piece shaft, but there was such confusion on account of frequent barter: a man often had in the evening a quite different set of arrows from what he had in the morning, if there were many men around and the day was one of idleness. Another element of confusion is the frequent marrying of men into distant groups, where a son may continue his father's methods in spite of the different practice of those around him. Direct inquiry often failed to show a man's foreign parentage; some did not seem to know or have any interest in their parents' ancestry, and an accidental remark of some old man or woman would bring it out afterwards. For these and similar reasons I am still in doubt where to localize the three-piece arrow-shafts, though they seem to be more frequent in Victoria Island than on the mainland and more frequent in the west than in the east. It might be thought that the quality of wood used for the shaft had something to do directly with the number of pieces spliced together to make it, but this seems not to be the case. One man will take pains to straighten a crooked stick over a fire to make a one-piece shaft, another will take a stick as straight as a tight string, cut it in three pieces and splice these together laboriously by means of sinew and seal blood glue. There are four or five variants on the method of splicing as to whether sinew alone, blood alone, or sinew and blood together are used to join the pieces. When blood is used the joint is carefully dried over a charcoal fire, the sticks being held in place meantime with temporary lashings. There are two forms of the joint. Fig. 37-38. When blood alone is employed, the second type of joint is invariably used.

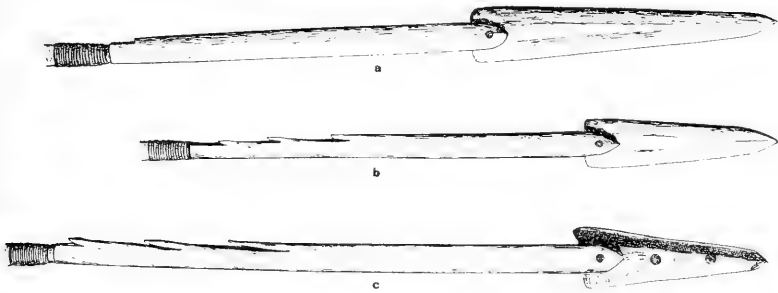

Fig. 34 (60-6975e, f, f). Iron and Bone Arrow-Heads from the same Quiver as Fig. 32, Coronation Gulf. c. Rivets of copper. Length of a, 29 cm.

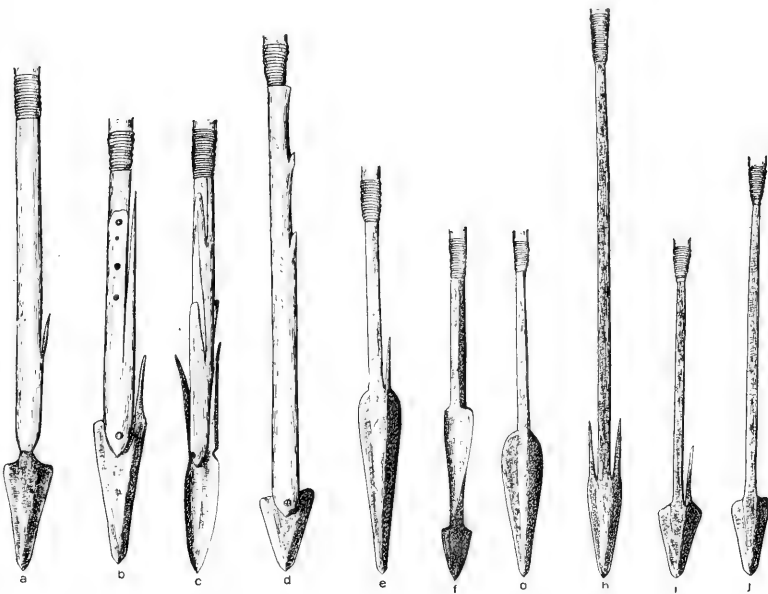

Fig. 35 (60-6938p, e, g, i, h, o, s, f, q, n). Copper Arrow-Heads selected from a single Quiver, Prince Albert Sound, Victoria Island. Length of a, 20 cm.

The section of the shaft nearest the head is invariably of caribou antler. This is from five to eight inches in length, slightly flattened or round and fits by a round spike-like point and shoulder into a socket in the front end of the wooden shaft, while a slit in the front end of the antler piece holds the metal or stone cutting blade of the arrow-head. There is generally some device for holding this part of the arrow in the flesh of a wounded animal: it may be one or more small notches on one or both sides of the arrow, or it may be one or more long flange barbs. One specimen seen had four barbs each over an inch long forming a complete circle around the shaft just back of the metal head, another had six one-inch barbs set in two rows on opposite sides. These barbs are rarely of inserted metal but of one piece with the antler forward end of the shaft.

The metal head varies in shape and size almost indefinitely, as well as in the number and character of barbs, or in their absence. The one fairly constant character is the shape of the point, which is the same as that of both copper and iron knives of their own fashioning. Fig. 36 shows some of the types seen.

They make no attempt at geometric regularity in the outline shape of arrow-heads except in the point, where the two cutting sides are the equal sides of an obtuse isosceles triangle. Occasional heads are of very irregular shape; these are generally iron heads, the shape no doubt due to that of the original piece of iron.

The copper arrow-heads are roughly hammered out with stones picked up at the place the arrow-heads happen to be made. We have never seen any sort of a hammer as part of the tool-kit carried by anybody. The finishing touches are given by grinding the arrow-head held in the hand against any rough stone that happens to be convenient, generally a large stone lying on the ground, not a small one used as we use whetstones. A few men have files, mostly from Hudson Bay, but these are usually saved for iron tools.

The head is glued into the antler forepiece of the shaft with seal blood, usually, though it is sometimes fastened with copper rivets. The shank of the antler piece fits tightly into, but is not glued into, its socket in the wooden shaft. It does not seem to be deliberately intended that the head or antler piece shall be detachable, but as a matter of fact, in about two cases out of three, the wooden shaft does become detached and is usually lost if the wounded animal carries the arrow far, while an arrow-head is seldom lost that strikes an animal, unless the animal escapes.

The arrows here are feathered in a careless, perfunctory way, as opposed to the practice among the Bear Lake Slavey or the Mackenzie Eskimo, in both of which places bows are still occasionally made. The feathers most commonly used are those of the snowy owl and various hawks, eagles, and

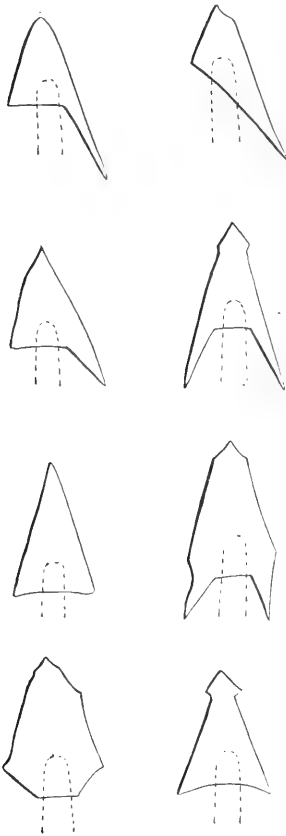

Fig. 36.

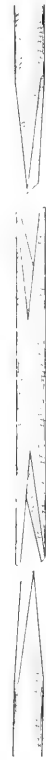

Fig. 37.



Fig. 38.

Fig. 36. Forms of Metal Arrow Points.

Fig. 37 (60.1-3462d). Splices for Arrow-Shafts, Prince Albert Sound, Coronation Gulf.

Fig. 38 (60-6970). Form of Splice used in Spear and Harpoon Shafts, Coronation Gulf. Interlocking grooves prevent slipping under the strain of a thrust.

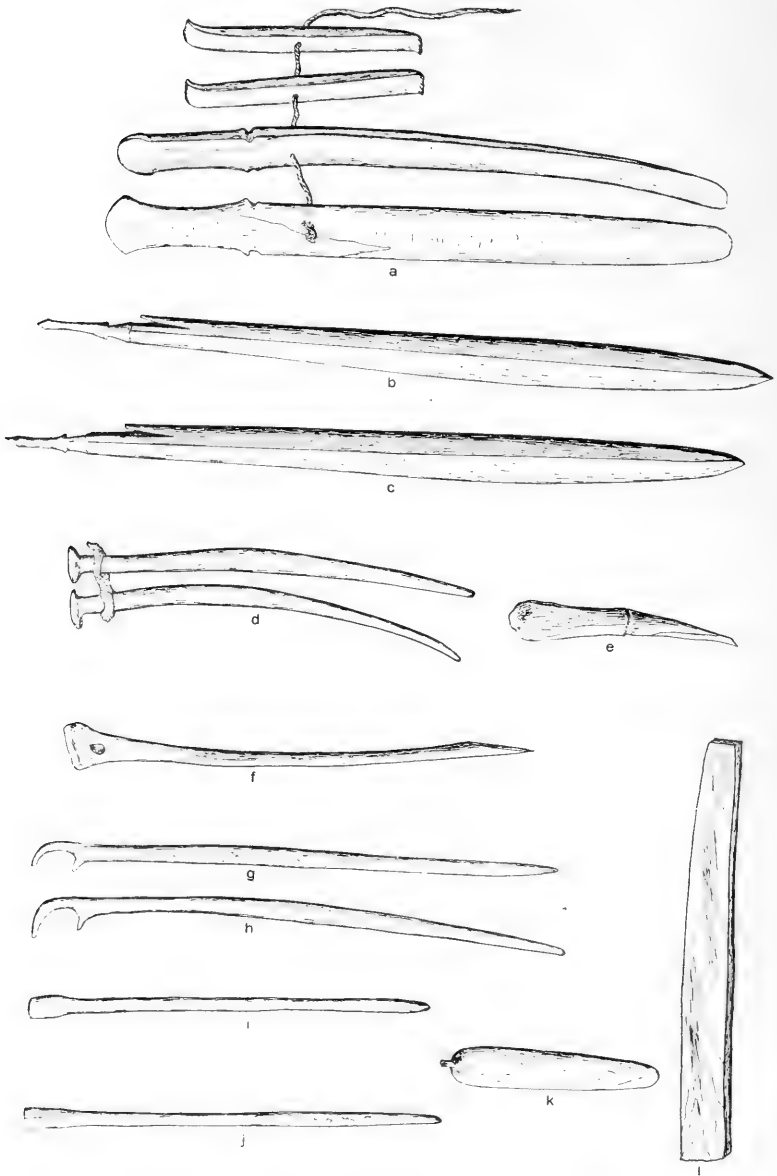

Fig. 39 (60-6939 g, p, r, s). Contents (including Figs. 41-42) of the Tool Bag attached to Bow Case, 60-6939, Kent Peninsula. Length of *a*, 21 cm.



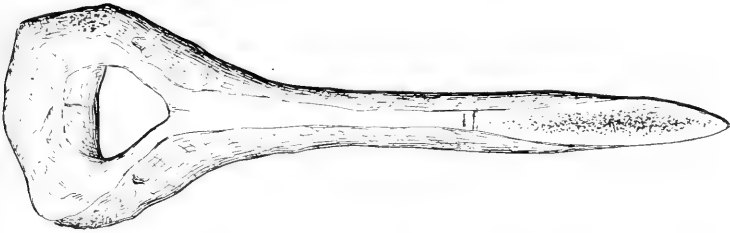

Fig. 40 (60-6975h). Shaft Straightener, Coronation Gulf. Length, 19 cm.

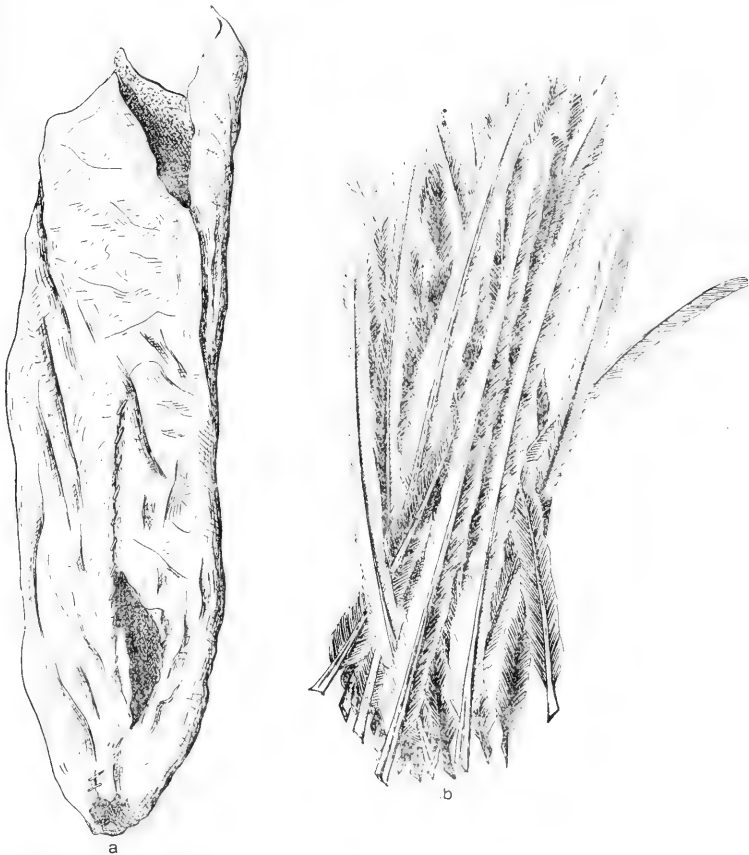

Fig. 41 *a, b* (60-6939n). Feathers for Arrows and Bag for the same, Kent Peninsula. Length of *a*, 23 cm.

loons. Ptarmigan feathers are not used, if others are available. The midrib of the feather is split and the two halves (the pieces about four inches long) are tied with sinew on opposite sides of the shaft in the usual way. But the feathers are often twisted, are badly worn away on old arrows, and are sometimes one or both partly or even wholly missing.

The "killing arrow" differs from the others in having no metal head. On the front of the shaft of wood is set a long double-edged dagger blade of caribou antler from eight to twelve inches long. This arrow is used to despatch wounded animals and is discharged at close range behind the shoulder of the caribou into the heart. It is also used by the men to shoot birds, as men seldom carry blunt arrows. This arrow is never barbed.

The blunt bird arrows are carried only by women and boys and are used chiefly against ptarmigan. The shaft is of the ordinary character, except a little shorter than is usual. The head is of antler (or of wood, in the case of very small boys) and has a flat front end or one slightly rounded, to give a stunning blow.

As to the efficiency of the bow: Tolerable accuracy, such as is needed in shooting birds, is not secured beyond a range of twenty-five or thirty yards. Against caribou the effective range varies with different archers generally between seventy-five and ninety yards, and is probably not over one hundred. At thirty or fifty yards members of our party have repeatedly seen an arrow pass through the thorax or abdomen of an adult caribou and fly several yards beyond. An arrow seldom breaks a caribou bone, except a rib; never, it is said, does it break a leg, though the point may penetrate a long bone slightly and even stick fast in it. When an arrow lodges in an animal, every movement of the body causes pain and tends to increase bleeding. For this reason an animal that would keep moving with a similarly located bullet wound will lie down if it carries an arrow, and will thus give a chance for a second shot. Much fewer wounded animals escape from the bow hunters than do from the rifle-using Eskimo of Alaska. Barren ground bears and musk-oxen are also killed with bows and arrows, but none of our party have been present at any such hunt.

A defect of the "Tartar" bow is that as its shooting power depends entirely, or almost so, on the sinew backing, the weapon becomes weak or useless if the sinew gets damp. Eskimo therefore protect their bows carefully in bags of waterproof sealskin, and are reluctant to use them in a rain or even a heavy fog. For this reason, also, the bows must be daily tested to see if the backing or the bowstring has become too tense or too lax from dryness or damp. There is seldom a day, even when the bow is not used, that it is not partly taken to pieces for one reason or another, generally to give an extra twist to the backing or to relax it by taking a turn out of it.

Deadfall traps are known, but we have seen none in use. One man of the Kogluktogmiut had two common steel traps from Hudson Bay through Uminmuktok; he had never set them for wolves or foxes but used them for trapping birds at their nests, and for spermophiles. This man had a wolf-skin coat of two wolves he had shot with his bow. Ordinary snares seem unknown; either for use against animals or birds, but boys catch spermophiles (marmots) with a string snare set in the mouth of the hole, when the animal emerges from the hole the string is jerked after the manner of farm boys catching gophers.

The kayak might be described as a hunting implement for it is only incidentally used for other purposes than spearing caribou. It is never used, we were told, for sealing. A sufficient explanation for which is that the people are never on the sea and seldom near it during the period of open

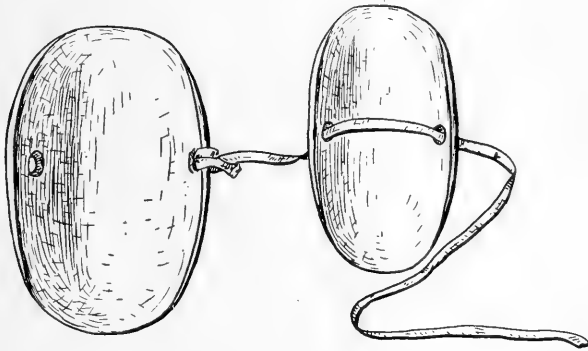

Fig. 42 (60-6939,o). Bone Thumb Guards, Kent Peninsula. Length, 5 cm.

water. The kayak has, so far as we know, disappeared during the present generation from among Kanhiryuarmit, the Nuwukpagmiut, Haneragmiut, and Akuliakattagmiut and is owned by less than one hunter of five among all the other groups familiar to us. It seems in danger of becoming obsolete.

The Coronation Gulf kayaks seen are up to sixteen feet in length and barely wide enough at the widest to accommodate the maker, sitting in the ordinary kayaker fashion. The width varies therefore somewhat according to the stoutness of the man who makes it. A man always makes a kayak or almost anything else for himself, though he may later sell it. We have known of no kayak made by another man than the one who used it. These kayaks are therefore longer and narrower than those of the Baillie Islands or the Mackenzie. The frame is of dry spruce, generally driftwood, and is much clumsier and heavier than any we have seen in the west. The lashings are thongs of the common seal and the skin that covers the frame is of the

same animal. Several Alaskan groups make kayaks of caribou skin which makes a lighter boat, but less durable. The skin cover is removed each fall and generally is used for one purpose or another, while the old frame is covered with new skins next spring, if the kayak is to be used that summer. As a man may, and usually does, hunt in different places different years, he may have use for a kayak one year and no use for it the next.

#### IMPLEMENTS AND TOOLS.

The most important items under this head are the woman's ulu, the man's snow knife and crooked knife. Both the ulu and snow knife are frequently of copper, otherwise of iron. We have seen several ulus made of heavy sheet tin which must have come from the refuse piles of some of the English ships of the Franklin Search Expedition, probably from those of Collinson's "Enterprise" at Cambridge Bay or Minto Inlet, Victoria Island, or from McClure's "Investigator" at the Bay of Mercy, Banks Island. Whatever the material of which the blade of the ulu consists, the general shape is such as would be secured by mounting a section of the blade of a cheese knife or buck-saw, T fashion, in a handle. (Fig. 43.) The broad part of the antler handle that runs up on the blade, is so thin that it does

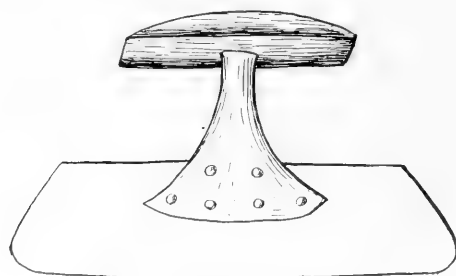

Fig. 43. General Form of the Ulu.

not interfere with the depth of the cut made by the ulu into such soft materials as cooked or uncooked flesh.

When the ulu is of copper, it may be all of one piece up to the musk-ox horn hand grip, the riveted middle piece of antler being replaced by an extension of the copper blade. The same general shape obtains, however. We have also

secured specimens of ulus in which a riveted middle piece of metal replaces the antler.

The striking thing about these ulus to one who comes from among the Western Eskimo, is that the cutting edge is straight except near either end of the blade. The western type of ulu in present use from the Baillie Islands at least to Icy Cape has a curved cutting edge similar to that of knives used by harness-makers.

The copper snow knives, and the iron ones, if the material allows it, have

a broad, double-edged spear blade six to twelve inches long, mounted on a handle of caribou long enough to easily accommodate the two mittened hands of the man who uses it, or a handle from seven to ten inches long. The handle is wound with split roots of the small arctic willow. It flares at the end into a thin, kidney-shaped widening. One side of this kidney-shaped spade is perforated and a string attached for tying the knife fast to the bow case in summer, when it is used as a hunting and skinning knife. The sheath for the knife is separately tied to the bow case, so that the knife lies horizontally when the bow and quiver are slung across the hunter's back.

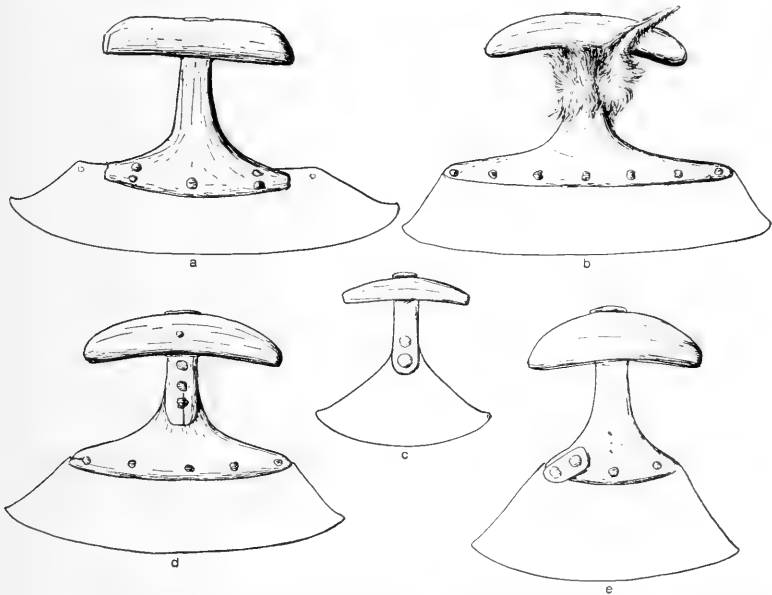

Fig. 44 *a* (60-6992), *b* (60-6991), *c* (60-6997), *d* (60-6993), *e* (60-6994). Ulus with Iron Blades: *a*, *b* and *c*, Coronation Gulf; *d*, Puipuirmint; and *e*, Nagyuktogmint. Length of *a*, blade, 19 cm.

In winter the knife is carried in the sled, or held in the hand. (Cf. Richardson's account of the way in which knives were formerly carried in the Mackenzie Delta, Arctic Search Expedition.) The two things of perhaps the greatest interest about the knives are: (a) that the knives are always sharpened not only on both sides the blade, but each edge is sharpened from both sides, as white men sharpen a knife, while from the Baillie Islands west to the Yukon mouth, both on the coast and inland, Eskimo sharpen knives of all sizes on one side the edge only, or in the manner in which we sharpen scissors. Coronation Gulf and Victoria Island people sharpen only the



Fig. 45. General Form of Knife found West of Coronation Gulf.



Fig. 46 (60-6984). Copper Knife with Caribou Antler Handle, Mouth of Rae River, Coronation Gulf. Length, 39 cm.

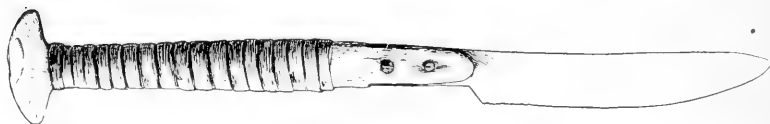

Fig. 47 (60-6980). Steel Knife with a Bone Handle. The blade is stamped "Fox." Collected at Coronation Gulf. Length, 43 cm.



Fig. 48 (60-6983). Copper Knife with Bone Handle. This specimen was purchased of Taptuna, living cast of the Akuliaktagmiut but met with at the foot of Basil Hall Bay, Coronation Gulf. Length, 44 cm.

crooked knife, scissor fashion. (b) The fidelity with which the shape of the copper knives is copied in the iron knives whenever the character of the material allows fidelity. If the blade as a whole cannot be coerced into shape, the peculiar local type of point will at least be given it; the same point as is found on all their arrows, spears, and lances. This type of point is not

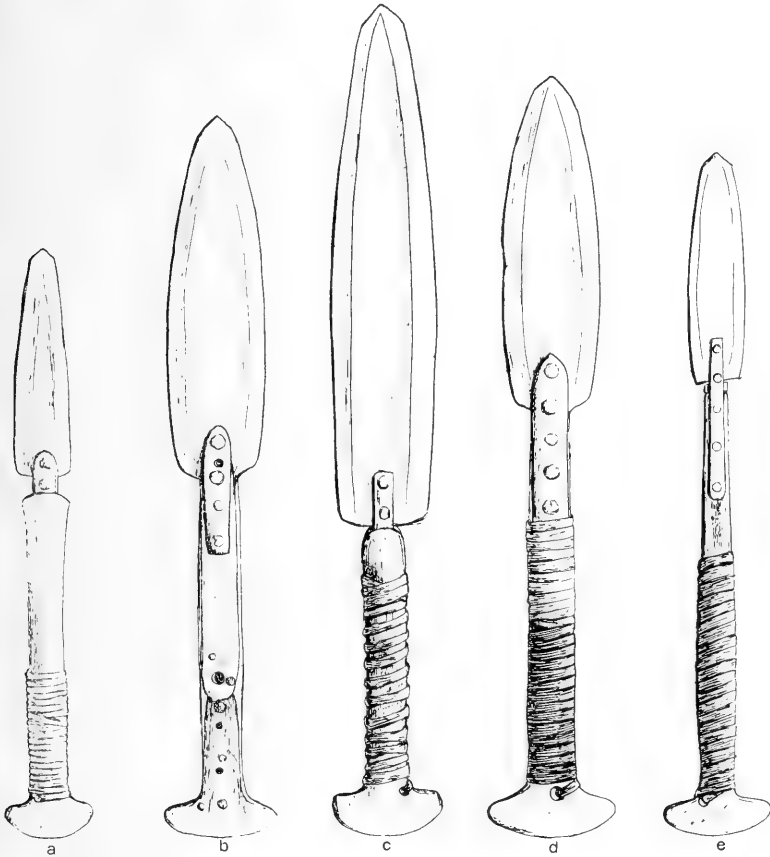

Fig. 49 *a* (60-6982), *b* (60-6978), *c* (60.1-3463), *d* (60-6979), *e* (60-6981). Steel Knives. *a*, Pallirmiut; *c*, Prince Albert Sound, Victoria Island; *b*, *d*, *e*, Coronation Gulf; the rivets are of copper. Length of *a*, 33 cm.

familiar to me from farther west, where the blade of any butcher knife is soon filed into the type shown in Fig. 45. It is to be expected that in knives as well as other things closer affinities will be found to the east than to the west, for our discussion goes to show that not only in the recent past, but also in the more distant past, relations with the east have been more continuous and probably more friendly.

The crooked knife here is the same as farther west except for one rather interesting thing; the handle of a Straits or Gulf crooked knife is just what the handle of a western knife would be if about six or eight inches were cut off its tip. In other words, each knife gives the impression of having been made with a handle capable of reaching, and resting on, the user's elbow, and then of having had a piece sawed off so that now the handle can reach only about two-thirds of the distance from the wrist to the elbow when held in the usual western fashion. Both my Eskimo and I took the first dozen or so crooked knives we saw to be broken, but the uniform length of the handles and their uniformly "sawed-off" appearance led me to ask directly, and I learned they were "always made so". The knife here, too, is held in the manner in which the Slavey Indians hold their crooked knives (about as we might a hunting knife in making shavings to kindle a fire), and not in the peculiar manner of the Western Eskimo. In working a large stick the end of the handle is often stuck in the ground or held with the foot or knee, a position I have never seen farther west. The handle is always of caribou antler.

The three-piece drill, bowdrill, or firedrill is here what it is elsewhere, practically. The bow is usually one of the long ribs of a musk-ox, the mouthpiece often the bone from the hock-joint of a caribou, and the stem of the drill of antler, musk-oxen, or bear bone, the point most often of iron but occasionally of copper. For drilling the eyes of needles, the drill point is usually a fragment of a broken needle. Various less familiar minor tools and implements are difficult to describe without illustrations: wound pins, not like the familiar wound pegs for seal, for pinning up gashes in skin, rents in a caribou stomach that is to be used as a bag for blood, etc., handgrips for carrying blood-filled caribou stomachs, sinew stretchers for bows, bone thimbles, and thimble holders, marrow extractors, for the long bones of deer, copper chisels for perforating sled planks, etc. For the forms of such specimens as we were able to bring home, the reader is referred to the drawings.

There is a general rough division of labor between the sexes although under certain circumstances a man may do any kind of woman's work and a woman any kind of man's work. There is no taboo restriction in this matter apparently. At any rate it seems to me that men among the Copper Eskimo and in fact all Eskimo whom I know, are less likely to mind doing such work as mending clothes, cooking, or looking after children than white men would be under similar circumstances. But besides this sexual division of labor there is a rudimentary one of another sort. Lame men or others for some reason not well able to hunt are likely to be occupied in the making and mending of implements and utensils and in some cases a man's skill at bow-making or pot-making is well known to be superior to the average and he therefore makes bows and pots for his neighbors occasionally merely as a favor, but



sometimes also for pay. Commonly a man who makes pots, for instance, is thereby handicapped in hunting and is consequently paid in caribou skins which he needs to clothe himself and his family.

There is also a specialization of industries by tribes according to the natural resources of the country. The Kogluktogmiut and others who hunt south to the woods of Great Bear Lake during the summer, make from spruce saplings large numbers of the type of tent poles necessary for the A-shaped skin tents that are in common use. They also make complete bows of wood, sinew, and antler all of which are more abundant among them than among most other of the mainland tribes. They also rough out the wooden materials for bows intended for sale to men who themselves are sufficiently supplied with sinew to be able to finish the work.

Commonly, those who hunt to Bear Lake abandon their sleds in the spring in the neighborhood of the seacoast and make new ones in the Bear Lake woods upon which to haul to the coast their household gear and the wooden wares they have made in summer. When they get to the coast with these new sleds they find there waiting for them the old sled of the year before and as no man has more than three dogs nor use for more than one sled, there is always one sled for sale.

Besides the articles already mentioned, the Bear Lake hunters during the summer make large numbers of snow shovels, wooden platters, planks intended for the floors of snowhouses, tables, and sideboards to be used in connection with the cooking over the seal oil lamp and the uprights and cross pieces needed for supporting the lamp on the table and for swinging the stone pots as well as supporting the drying frame upon which the damp clothing is dried over the flame of the lamp, harpoon shafts, and spear shafts both for the caribou lance and the fishing spear as well as for the long gaffs that are chiefly used by the fishermen at Bloody Fall. All these are made in greater quantities than are needed by the makers and the Bear Lake hunters may therefore be considered merchants in wooden ware.

While the Bear Lake people make their implements and utensils out of green standing trees which they chop down at great labor with adzes, the Akuliakattagmiut also make various wooden articles for sale out of the driftwood which is more abundant on their beach than upon the shores of the rest of the Copper Eskimo district. While the Bear Lake men have to rough out each piece from the green wood and leave it for months to dry before the wood is seasoned enough for finishing, the Akuliakattagmiut find the wood already seasoned to their hand. Neither do they have to carry the made articles long distances to the seacoast as do the Bear Lake traders. As a consequence, the Akuliakattagmiut are also great makers of sleds and bows and other wooden things with which they supply a consider-

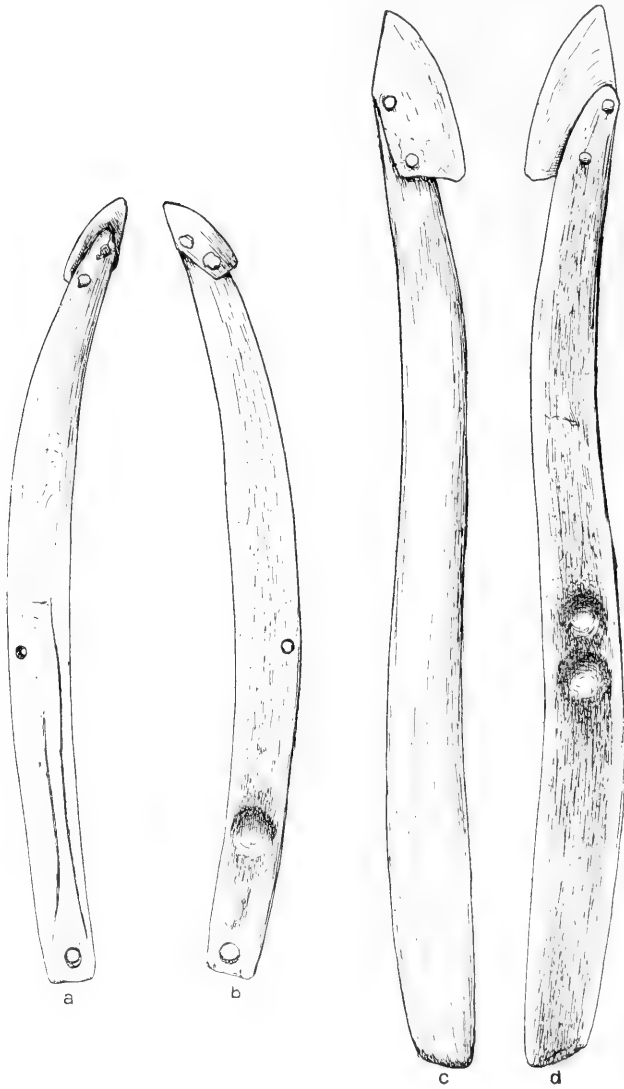

Fig. 50 *ab* (60-6990), *cd* (60-6985). Crooked Blade Knives, Coronation Gulf. The first has an iron blade, the second copper; the rivets are of copper. Length of *a*, 26 cm.

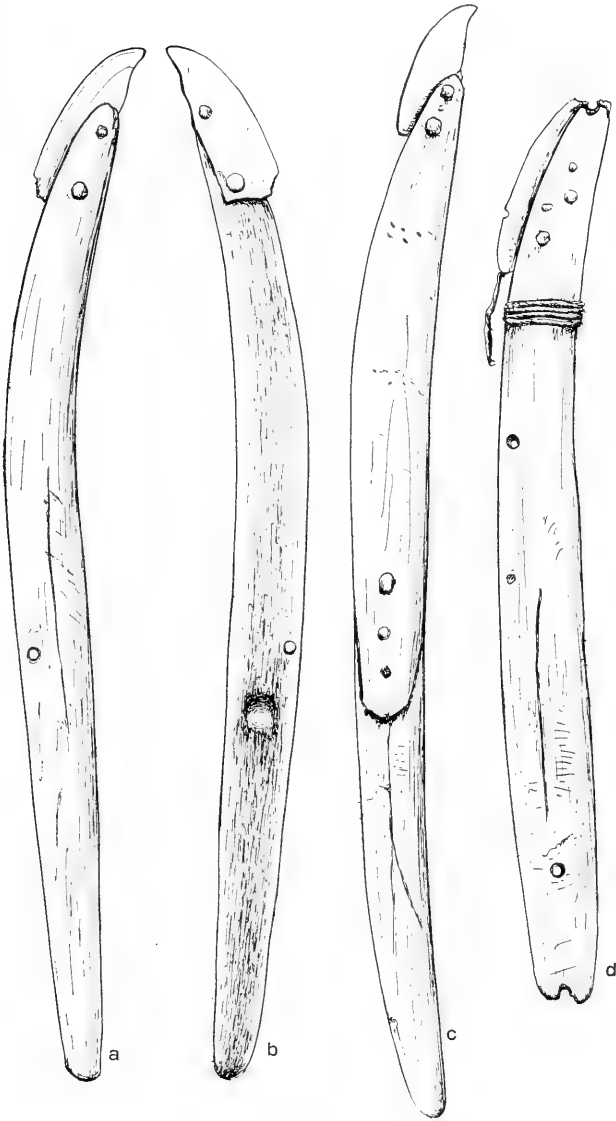

Fig. 51 *ab* (69-6988), *c* (60-6989), *d* (60-7004). Crooked Blade Knives of Iron, Coronation Gulf. Length of *a*, 13 cm.

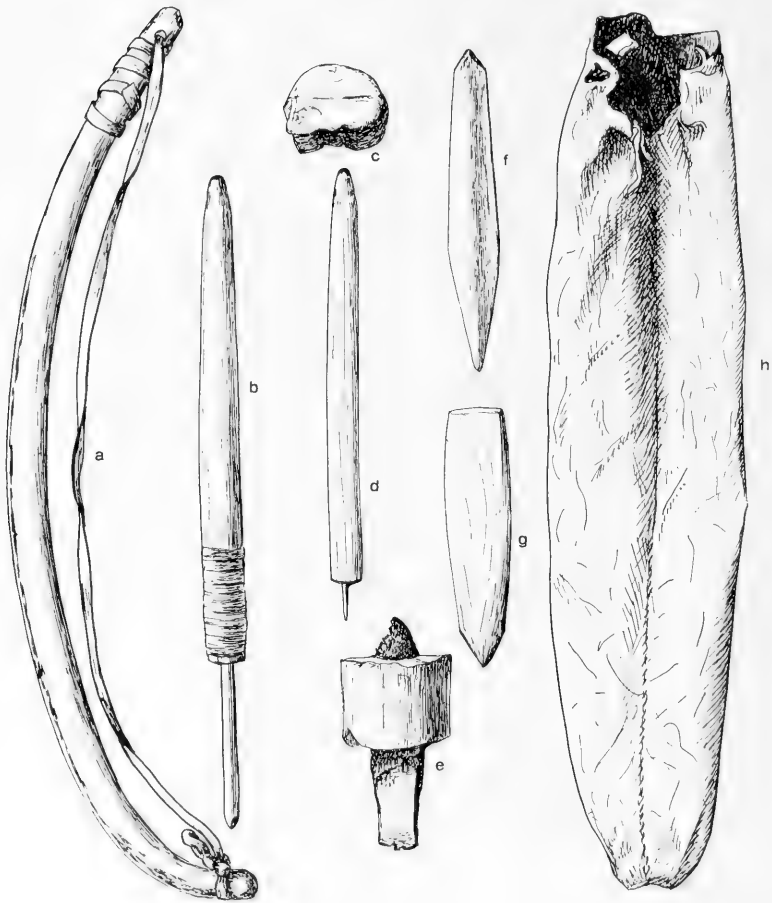

Fig. 52 (60-7048 a-d, g, i, j). Tool Bag and Contents, Coronation Gulf. Length of *a*, 51 cm. *c*, has a copper blade.



Fig. 53.

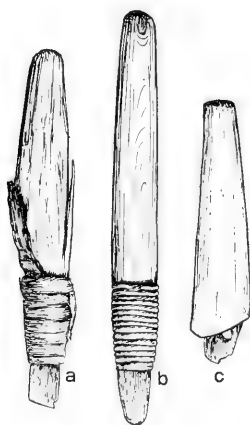

Fig. 54.

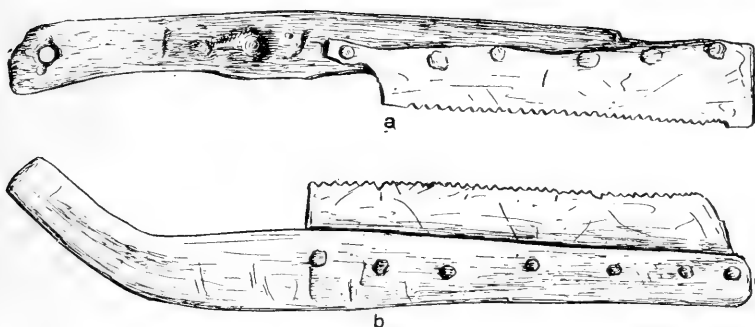

Fig. 55.

Fig. 53 (60-7011). Knife Sharpener, Bone Handle with Steel Insert, Coronation Gulf. Length, 9 cm.

Fig. 54 *a* (60-7013), *b* (60-6986, copper blade), *c* (60-7012). Small Knives or Graver's Tools, Coronation Gulf. Length of *a*, 9 cm.

Fig. 55 *a* (60-7001), *b* (60-7000). Saws, Coronation Gulf. Length of *a*, 25 cm.

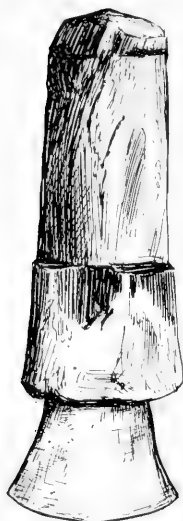

Fig. 56.



Fig. 57.



Fig. 58.

Fig. 56 (60-6999). Adze Head, Iron Blade, Antler Haft, Pallirmiut. Length, 17 cm.

Fig. 57 (60-7076). Whetstone from Coronation Gulf. The surface bears traces of copper from use upon copper tools. Length, 9.5 cm.

Fig. 58 (60-6987). Piece of Worked Copper from Rae River. Length, 12 cm.

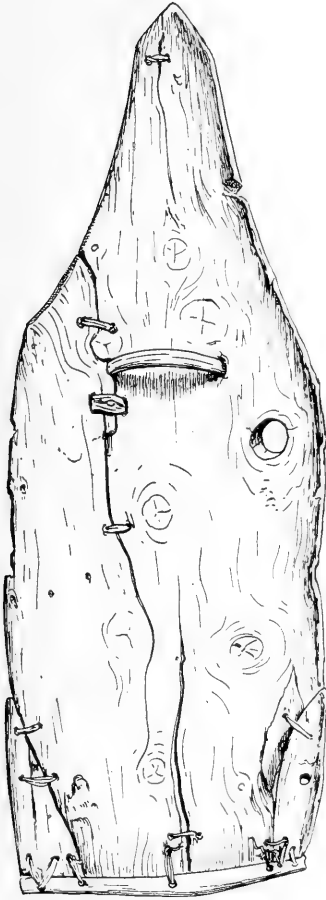

Fig. 59.

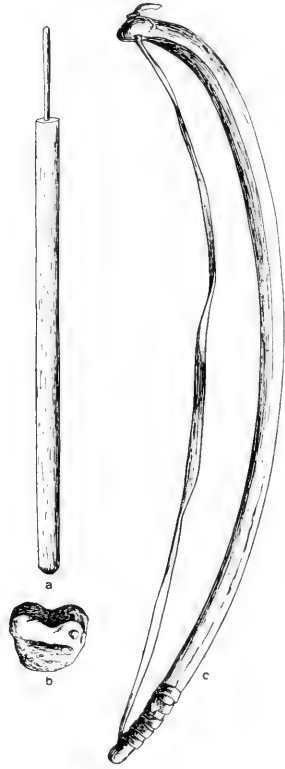

Fig. 60.

Fig. 59 (60-6962). Wooden Snow Shovel, edged with Ivory, Coronation Gulf. Length, 98 cm.

Fig. 60 *a* (60-7007), *b* (60-7050), *c* (60-7049). Bowdrill Set from Coronation Gulf. Length of *c*, 48 cm.



Fig. 61 *a* (60-6976), *b* (60-6977). Snow Knives made of Bone, Coronation Gulf. Length of *a*, 42 cm.



Fig. 62 (60.1-3467). Bone Pin from Prince Albert Sound, Victoria Island. Length, 14 cm.

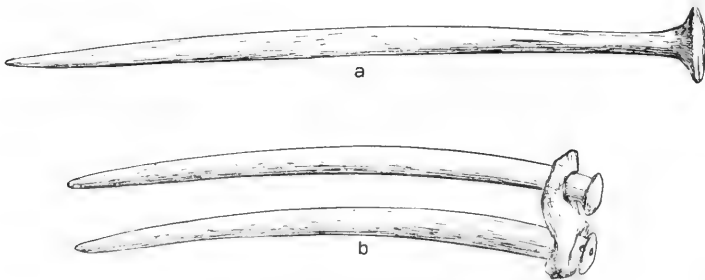

Fig. 63 *a* (60-7033b), *b* (60-7033a). Bone Pegs from Coronation Gulf. Length, 18 cm.



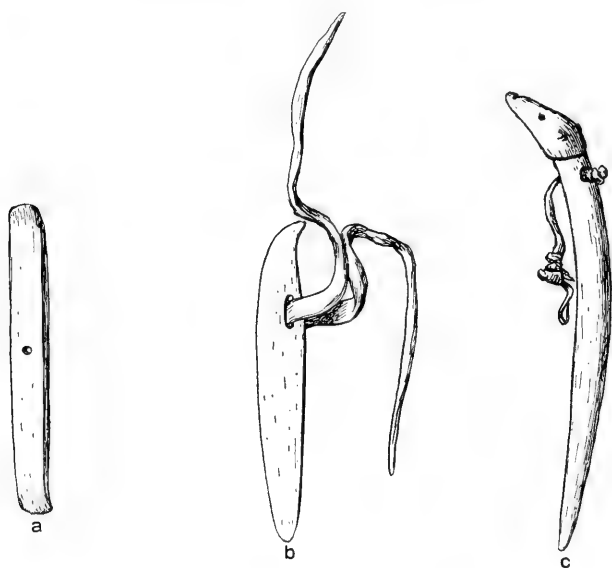

Fig. 64 *a* (60-7017c), *b* ((60-7045), *c* (60-7034). A Sinew Stretcher (*a*), Knot Opener (*b*), and Awl (*c*) from Coronation Gulf. Length of *a*, 8 cm.

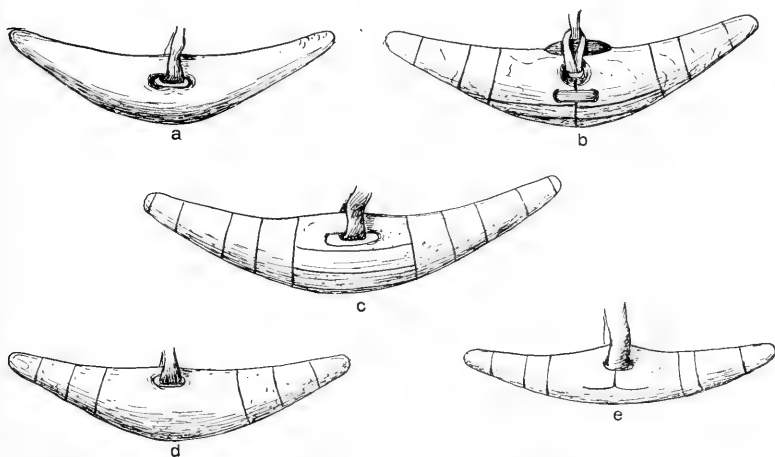

Fig. 65 *a* (60.1-3474), *b* (60.1-3469), *c* (60.1-3470), *d* (60.1-3473), *e* (60.1-3471). Decorated Toggles from Prince Albert Sound, Victoria Island. Length of *a*, 9 cm.

able portion of Victoria Island. Their sleds and their bows are considered to be about as good as those from Bear Lake although the bows intended for sale are seldom if ever completely finished for caribou sinew is scarce with the Akuliakattagmiut. In one thing only do the Bear Lake products excel according to popular estimation and that is that their tent poles being made of the slim saplings that grow in the thick woods are better than ones made on the sea shore by the splitting of large logs and adzing them down.

About the most difficult article to make is a snow shovel. The biggest of them are as much as twenty inches wide. It is therefore in the first place difficult to find either in the Bear Lake woods or on the sea beach of the Akuliakattagmiut a log so big that a shovel of this size can be adzed out of it, and then the labor is self-evidently considerable especially in view of the care for size and sharpness of the tools with which the work has to be done. We found, accordingly, in Coronation Gulf that a good snow shovel made of one piece of wood was worth as much as a dog or as any but the very best sleds.

The Utkusiksaligmiut from the nature of their country are dealers in stone lamps and stone pots. Sometimes a family from as far away as Cape Bexley will make a journey to Tree River in order to find material for pots and lamps for their own use and for sale to their countrymen upon their return which is sometimes at the end of a year, sometimes in two or more years. More commonly, however, the distant tribes buy lamps and pots.

It takes a good deal both of labor and patience to make a large stone pot. The largest specimen which we actually secured and brought home is twenty-five inches long, but we saw another pot which was not for sale that was nearly forty inches long. The maker of this pot, one Ivarluk, told us that he had spent an entire summer in its construction and had for that reason been unable to hunt caribou so that he had been forced to purchase skins for clothing for his whole family that fall. While doing the work he had camped beside the best fishing place he knew of and stayed right there until the pot was finished.

The making of a stone lamp is evidently not so difficult a task. The chief tool used nowadays is an iron adze, the iron being procured chiefly by tribe to tribe trade from Hudson Bay, although some of it is said to date back to the finding and plundering of M'Clure's ship on the north coast of Banks Island, which must have been somewhere in the '50's of the last century. When iron is not at hand it is said that tools of stone take its place. As all soapstone products are fragile and especially so the cooking pots because they are made thin, there arises continually the necessity of supplying new pots and lamps. In earlier times before the coming of the Hudson Bay trading post at Fort McPherson on the lower Mackenzie broke up the chain of continuity of the coastal trade between Coronation Gulf and Bering

Strait, it is probable that the making of stone lamps and pots was an industry of far greater proportions than it is today. For, as elsewhere pointed out, it seems clear that this community and ones east of it supplied all the steatite cooking gear used to the west as far as Siberia.

Of the tribes whom we visited, the Kanhiryuarmit are paramountly the makers of weapons and implements of copper. From the deposits northeast of Prince Albert Sound and from pieces of float which they pick up here and there they make long-bladed hunting knives, the ordinary half-moon shaped woman's knives, crooked knives for whittling purposes, copper rods for the foreshafts of seal harpoons, points for ice chisels, blades for caribou spears, seal harpoons and arrows, prongs for fish hooks, needles for sewing, and nails and spikes used in the making or mending of articles of wood, horn, or bone. Naturally, they have more practice than members of other tribes in the making of these copper articles and they are the wares for which they purchase sleds and other wooden articles, which if they are from the Cape Bexley region come to them through the intermediary of the Haneragmiut while if they are from Bear Lake they come through the territory of the Puiplirmiut. Some of these copper articles also they take with them on their long trade excursions to the head of Chesterfield Inlet where they exchange them for articles of wood and even for certain white men's wares for although they do not meet white men on the Akilnik, they meet there Eskimo who deal with the white men of Hudson Bay.

Besides the sale of made articles of copper, there is also a considerable trade in raw materials. The chief of these are pieces of unshaped copper and the skins of summer-killed caribou. The caribou skins seem to go chiefly to the Akuliakattagmiut through the hands of the Haneragmiut in exchange for articles of wood.

A good many tribes do not have any special advantage of territory that tends to develop industries along special lines but in general these occupy the position of middlemen between other tribes. As has been pointed out above, the Haneragmiut receive copper and caribou skins from the north and articles of wood from the south and these act as go-betweens for the Haneragmiut and Akuliakattagmiut. Their only peculiar local resource is that there are some deposits of iron pyrites, a substance that is universally used by the Copper Eskimo in kindling fire, and this they sell to many of the surrounding tribes. The Puiplirmiut also act as middlemen between Prince Albert Sound and the Coppermine River passing articles of wood on northward as well as cooking utensils of stone and receiving in exchange copper and caribou skins. The wooden articles, however, are only in part those received from the Coppermine people proper, for a few of the Puiplirmiut each year go to Great Bear Lake to secure wood for their own use and for trade.

## CLOTHING.

All coats for summer or winter wear are preferably of caribou skin, except the raincoats which are of the skin of the common seal. The cut of the coat is much in the form of our formal evening dress, except that they are whole in front on the breast and are therefore put on after the manner of



Fig. 66. (a) Prince Albert Sound Man in Winter Costume; (b) Victoria Island Costume.

our sweaters. In front the coat (both sexes practically alike) comes down only to about the tip of the sternum, the long tail may reach barely to the knee or quite to the ankle, according to the fancy of the wearer, apparently. The coats are not trimmed with wolverine as in Alaska or any skin other than

caribou, but have a narrow tape of caribou skin sewed along all borders to keep the edges from rolling up. Some coats are ornamented, strips of white deerskin sewed into the coat in various places, especially on the breast or along the borders of the coat tail. There may also be strings sewed on for ornament; and there may be bone buttons, shells, weasel-tails, etc., worn for ornament or as charms. There are two coats worn in winter, the inner with the hair turned in, the outer with the hair turned out. The sleeves are



Fig. 67. Group of Prince Albert Sound Men.

short, seldom come quite down to the wrist joint. The hood does not come well forward on top the head as it does in the coats of most other Eskimo, but leaves almost the entire top of the head exposed, the edge of the hood slanting forward and down so as to barely cover the ears.

This form of coat is evidently not adapted to winter storms, and most persons therefore have a storm coat in readiness to put on over one or both the others if the wind blows, or if a snowhouse is to be built. This coat is as

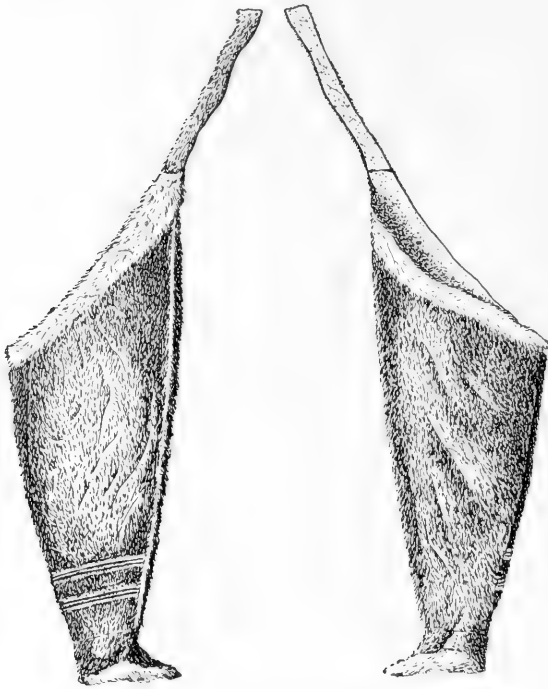

Fig. 68 (60-6882a). Woman's Boots, Coronation Gulf. Length, 1 m.

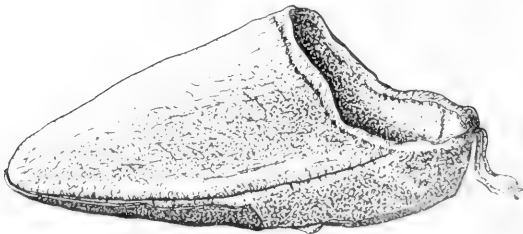

Fig. 69 (60.1-3601). Shoe of Sealskin, Coronation Gulf. Length, 24 cm.

often of seal as of deer; it has the same hood and same short sleeves that the others have, but it comes down to the knees both before and behind and thus is a more satisfactory garment in a blizzard. The bottom edge of this coat is never trimmed evenly, it has all the flaps and unevenness of the original deerskin or sealskin. If it be of sealskin, the margin has in it the holes by which the green hide was pegged out to dry. This garment never has ornamentation of any kind. The sealskin storm coats are identical with the raincoats used in summer, the hair worn out, both winter and summer.

The breeches worn by the men are of caribou skin preferably, or of marmot skins. They come well up to the tip of the sternum instead of barely above the hips, as in Alaska, and reach down to the middle of the calf of the leg. They do not have a pucker-string at the knee as among the western Eskimo. Two pairs are worn, the inner hair in, the outer hair out. In summer when but a single garment is worn, both coat and breeches are usually worn hair out.

There are two types of mittens. Although the coat sleeves are short, the mittens commonly worn are without gauntlets leaving usually a bare strip an inch or more wide at the wrist. These mittens are of thin summer fawnskin or legskin of young caribou yearlings. The second type of mitten is of caribou skin or sealskin, has a gauntlet that comes almost up to the elbow, and pucker-string by which it is tightened around the forearm so that no snow can enter. This mitten is used in snowhouse building and in blizzards. It is seldom put on without assistance, a second person's help is required to tighten the pucker-string of the gauntlet.

The footgear worn differs strikingly from that in use at the Baillie Islands or west. In the west there are many variants, but in general at the Baillie Islands and the Mackenzie both boots and socks come either just up to or just above the knee and are held in place by a pucker-string of the breeches, which comes outside the boots at the top. Generally, in Alaska the boots have a pucker-string at the top whether they be ankle or knee boots. Everywhere in the west the women's nether garments are in one piece from the waist down (in the manner of fishermen's wading pants), and short (ankle) boots are worn over these. In some cases a slipper, usually of sealskin, is worn between the socks and boots.

East of Cape Bexley and in Victoria Island, two pairs of socks are worn, both reaching up to the knee. These are not worked soft, as in the west, but the skins are intentionally left stiff so that the leg may hold its shape. The leg is widest at the top and comes just up to the knee, with no pucker-string to hold it up. A slipper is worn between the two pairs of socks. The breeches overlap the socks at the top by about three inches, and are

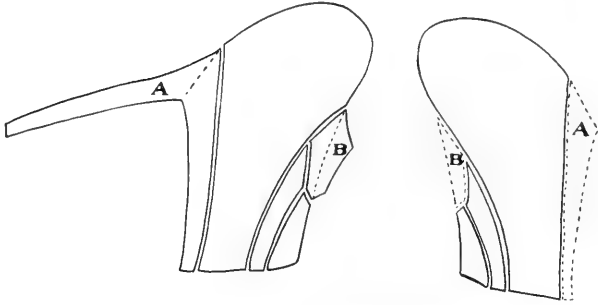

Fig. 70 (60-6947). Pattern for the Hood to a Woman's Coat, Fig. 71.

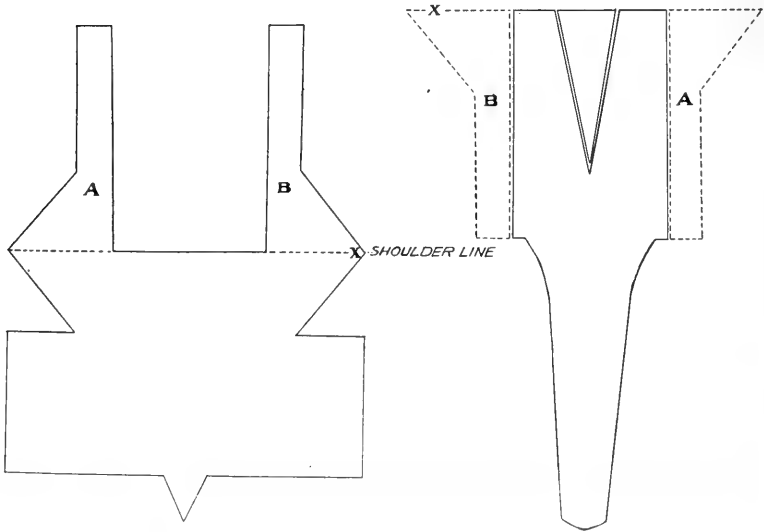

Fig. 71 (60-6947). Patterns for Front and Back of Woman's Coat, Coronation Gulf



not tied with a pucker-string. The knee joint is thus left far more free in walking than is the case among western Eskimo.

Outside the socks is used a shoe of sealskin. This is of a peculiar shape, differing radically in cut from a western Eskimo boot. It resembles, in fact, rather closely the sheepskin shoe worn in Iceland, more closely at least, than it does the western boot. An essential of the boot in the west is that it has a sole of another material (or at least of another piece) from the upper; in the east the shoe is of one piece, with small patches sewed under the heel and the ball of the foot to strengthen it. In the west boot soles in summer are of bearded seal when possible (white whale, beluga, in the Mackenzie), in winter they are of deerskin. Neither material is ever used in the east, only the skin of the common small seal, though they have the other materials in abundance.

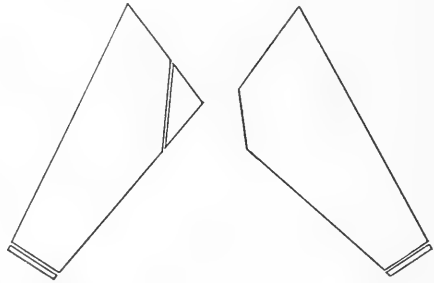

Fig. 72 (60-6947). Sleeve Pattern, upper and under, for Fig. 71.

The boot worn by the eastern women is an extraordinary garment. It fits the foot only below the ankle, above which it is funnel-shaped, reaching at the woman's hips the width of a flour sack. They are supported from the waist by strings that go over the belt. Their shape, looseness, and weight make them a considerable impediment in walking. The breeches worn reach only half way down to the knee; consequently the loose bootleg fills with mosquitoes and sandflies in summer and with driving snow in the winter storms. It is as irrational a garment as any worn in civilized countries.

The "evening-dress" coats and short mittens of both sexes and the boots of the women make the every-day clothing of these people ill-suited for the climate in which they live. True, they have good coats and mittens against storms, but these are seldom put on until pressingly needed, and naturally therefore a person is often caught ill-prepared for bad weather. This is probably one reason why they so often freeze to death in blizzards of which we heard many stories. We have seen a woman both of whose breasts froze off the winter of 1909-1910 because she was caught in a blizzard while wearing the ordinary "evening-dress" coat. A man who accompanied us from the village of the Akuliakattagmiut to that of the Haneragmiut suffered considerably from a slight wind which blew up, though I and my western Eskimo companion were not at all inconvenienced. These clothes also allow mosquitoes and sandflies access to all parts of the body in summer.

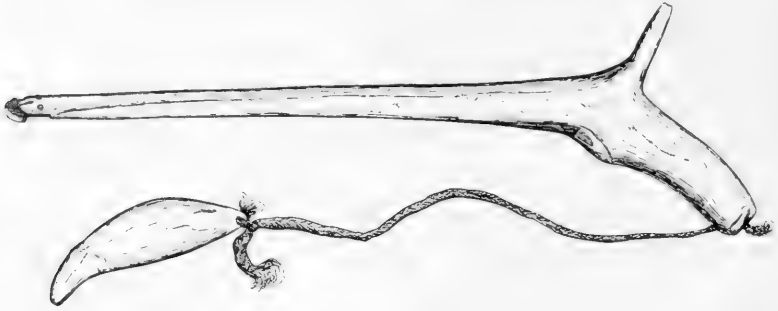

Fig. 73 (60-7005). Skin Scraper with Copper Blade and Bear Tooth Toggle, Coronation Gulf. Length, 27 cm.

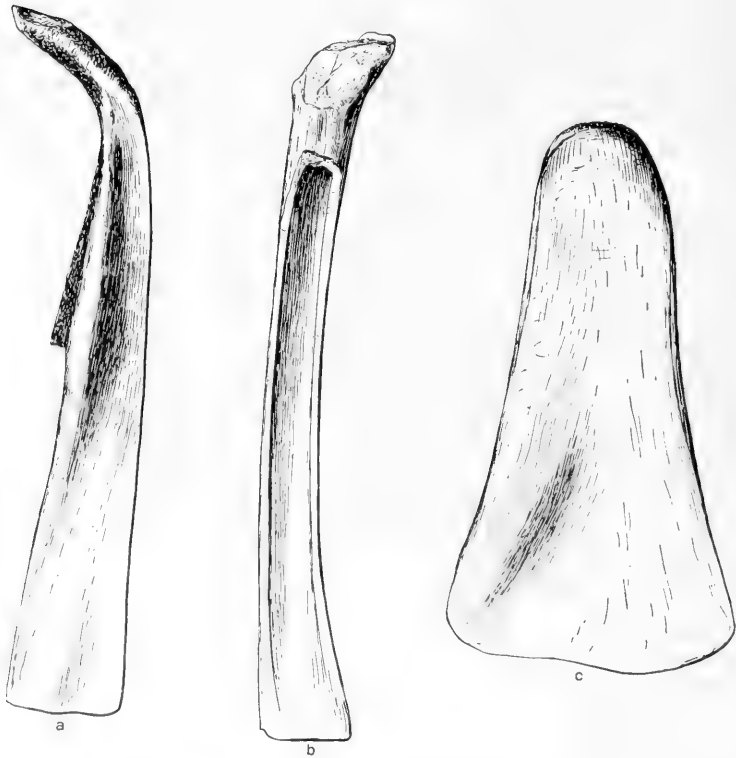

Fig. 74 a (60-7059), b (60-7060), c (60-7058). Skin Scrapers from Coronation Gulf. Length of a, 26 cm.

Caps are in use in summer only, and then are not worn for warmth, but as a protection against mosquitoes. It is a simple skull cap with ear flaps to which strings are attached that tie under the throat. The material preferred is the headskin of a fawn, but it may be marmot skin or any other light soft material.

Loon skins and duck skins are used for slippers inside boots in very cold weather; those skins are also carried in summer to beat off mosquitoes from one's face and neck.

#### ORNAMENTS AND CHARMS.

The outer "evening-dress" coats of men often have a single bone button sewn at the small of the back, placed about where the back buttons are on white men's dress coats. Muskrat tails, weasel-tails, etc., are worn as pendants on the coat, usually on the broad of the back. The coats are cut so as to give somewhat the effect of an epauletted uniform coat. Strips of caribou skin are worn on the coats by both sexes and on the breeches by men, somewhat in the manner of the buckskin lacing of frontiersmen pictured in story books. Bone buttons, round or rectangular in outline, are worn by children bound on the forehead above and between the eyes, these are purely charms, we were told. Each child wears only one button. Almost any conceivable thing may be carried, usually in a bag, as a general charm by either men or women, usually, though, it is some rare thing, as something they have found in a deserted Indian camp, a part of some rare bird or animal, etc.

#### HAIRDRESSING.

The men do not have the hair cut in the proper tonsure fashion that maintains from the Baillie Islands west to Indian Point, Siberia, and beyond. East of Cape Bexley not only the crown is cropped short, but also the forehead, in fact, the entire head except a fringe from one to two inches wide extending in a horseshoe from just in front of and above one ear, back in a curve to the back of the neck, and up and forward to just in front of the other ear. Such hair as is allowed to grow is apparently never trimmed and comes well down on the back in many cases. It is not braided. The hair cutting is with a sharp knife and a small piece of flat stick, and is closer than it is possible to cut with barber's clippers. I have never seen hair over half an inch long on the trimmed part of a man's head. Boys of two years and over have their hair cut like the men's.

The women usually braid in two small braids that portion of the hair

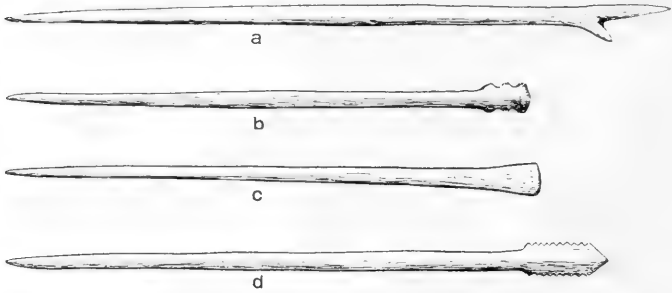

Fig. 75 a (60-7036), b (60-7038), c (60-7037), d (60-7041). Awls of Bone from Coronation Gulf. Length, 17 cm.



Fig. 76 (60-7002). Steel Knife with Bone Handle, Coronation Gulf. Used for cutting skins when sewing. Length, 14 cm.

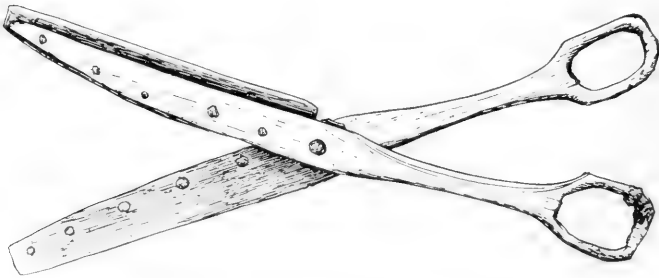

Fig. 77 (60-7003). Scissors with Bone Handles and Iron Blades, Coronation Gulf. Length, 17 cm.

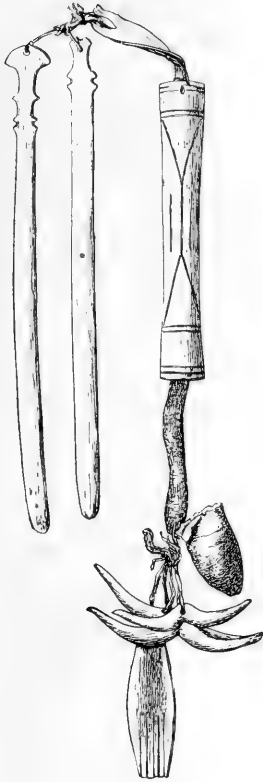

Fig. 78.

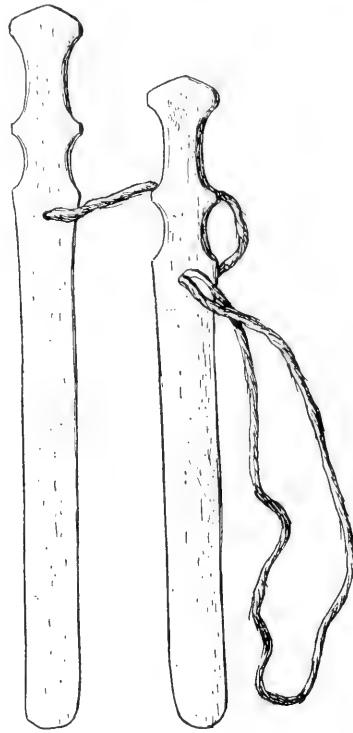

Fig. 79.

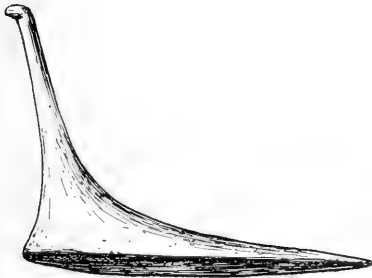

Fig. 80.



Fig. 81.

Fig. 78 (60-7018). Needle Case and Attachments, Coronation Gulf. Length, 70 cm.  
 Fig. 79 (60-7015ab). Tool for working Sinew, Coronation Gulf. Length, 19 cm.  
 Fig. 80 (60-7051). Guard made of Bone, Coronation Gulf. Length, 7 cm.  
 Fig. 81 (60.1-3438). Copper Needles from Victoria Island. Length of *a*, 5 cm.

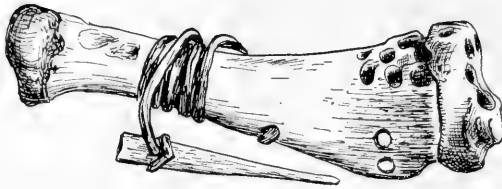

Fig. 82 (60-7057). Cup-and-Ball Game, Coronation Gulf. Length, 12 cm.

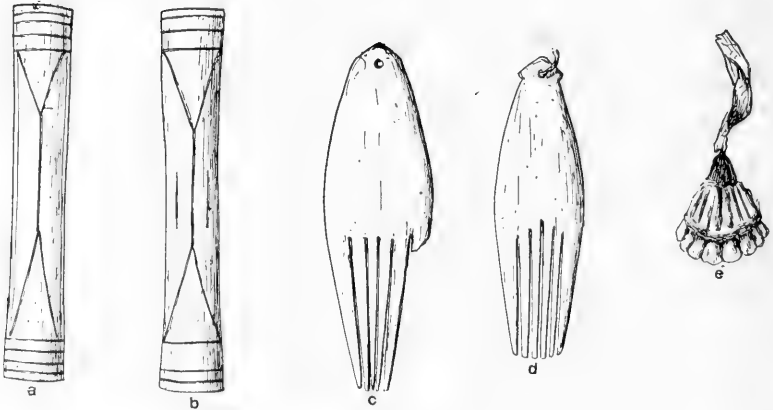

Fig. 83 *a* (60.1-3510), *b* (60-7020), *c* (60-7042), *d* (60-7043), *e* (60-7064). Needle Cases (*a* and *b*) from Prince Albert Sound and Coronation Gulf; Combs (*c* and *d*), and a Coat Ornament (*e*), Coronation Gulf. Length of *a*, 12 cm.

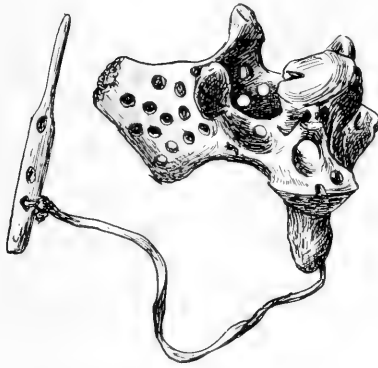

Fig. 84 (60-7056). Cup-and-Ball Game, Coronation Gulf. Length of bone, 7 cm.

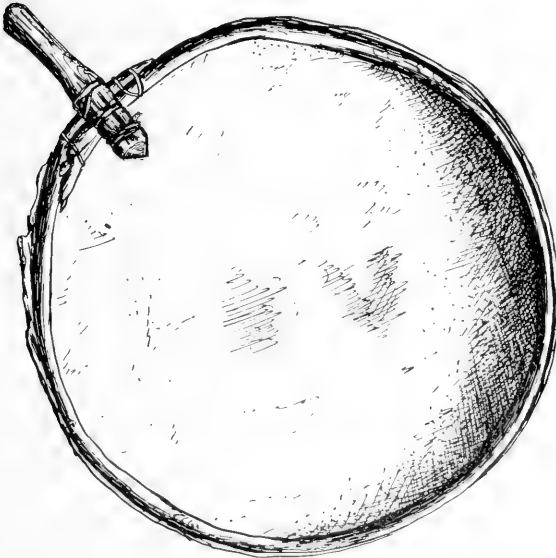

Fig. 85 (60-6974). Drum from Twenty Miles west of Gray's Bay, Coronation Gulf. Diameter, 38 cm.

that is liable to get into the eyes. Except for this, the hair is in most cases not done up at all. Some women however, divide the back hair of the head in two, and wind each half into a queue by twisting around each bundle a long strip of thin, short-haired deerskin.

The hair is probably never washed. The women occasionally wash their faces by spitting into the palm of the hand and then rubbing the face. As they have no mirrors they sometimes forget to clean one part or another of their faces, which gives them a rather unusual appearance. This washing is most likely to take place on the arrival of visitors from a distance, and usually is performed in their presence.

#### RELIGION.

It is doubtless impossible to sum up the religion of any people in a sentence. We can make an attempt to do so for the Eskimo by saying that to their notion all things and processes are controlled by spirits which in turn can be, and as a matter of fact, are controlled by formulae that are either known to man or susceptible of becoming known. The most obvious shortcoming of this statement is that there seems to be a fundamental idea in the Eskimo mind that certain things are punishable in an automatic way or of their own very nature without the intervention of any effective agent. In this connection we must emphasize the word "seems" for like all other men the Eskimo are very unclear in their religious thinking and it is possible that what one thinks of as happening in an automatic sort of a way another may consider as being brought about by an agent. It is also possible that a man who has been in the habit of thinking of a thing as happening of its own account may when pressed for an explanation say that he never thought of doing so before, but doubtless there is some spirit back of it all.

We shall first discuss some of the phases of the subject of taboo.

On the basis of any dialect from Cape Prince of Wales east to Coronation Gulf two words must be thoroughly understood before one can discuss intelligently with an Eskimo the subject of taboo.

Aglirktok, this word applies exclusively to a person or to some animal or thing considered as personified. Our nearest approach to a translation of it would be: he is under a taboo. In certain things a man may be aglirktok at birth and will have to remain so forever by reason of the tribe to which he belongs. In the case of the Kittetaryuit people, for instance, every grown woman and child is aglirktok with reference to the eating of a marmot and in Coronation Gulf with reference to the eating of a muskrat. In other cases a man may become aglirktok automatically, as it were, by



attaining a certain age or by having certain things that are in the nature of natural development happen to either himself or some relative or intimate associate. All these cases are fairly definite and are easily known and kept in mind with the result that offenses against the *aglirktok* condition are rare and the consequent misfortunes and punishments assigned to a breach of conduct are not likely to occur.

Under certain conditions, however, a man may become *aglirktok* without knowing it. If, for instance, he lives in another community from that occupied by his relatives and were one of those relatives to die, certain articles of food and dress and certain lines of conduct would become prohibited and the violation of this prohibition would similarly become punishable but the man under the taboo would know nothing of it by reason of not knowing that his relative is dead. He would then be likely or almost certain to break the taboo with attendant evil consequence to himself, his friends, and family and to the community at large. It is in connection with a misfortune that comes without assignable cause that the shamans go into seance and inquire who it is that is *aglirktok* and why. When they find out and tell the right man that he is *aglirktok* the misfortunes are likely to cease if the man acknowledges his fault and commences to observe the taboo.

*Aglernaktok* is generally applied to things, conditions, and actions but may also apply to persons. In the case of the *Kittegaryuit* people every individual, as above pointed out, is *aglirktok* with reference to eating the flesh of the marmot and the flesh of the marmot is by a reciprocal relation *aglernaktok* from the point of view of every native *Kittegaryuit*.

An action may be *aglernaktok*, such as the walking in the same trail with a woman who has recently borne a child. There are probably no things, actions, or relations that are thinkable to the Eskimo mind that are not subject to becoming *aglernaktok*. It was formerly unthinkable to them that one day should be different from another, but since they learned from the white men that the days have names and are different one from the other the civilized Eskimo have universally acquired the idea that Sunday is *aglernaktok* and some of those who have associated much with white sailors have discovered that Friday is *aglernaktok* with reference to the sailing of ships from port. In the old days with the Alaskan Eskimo a man was considered wise in proportion to the number of charms he had for the accomplishment of what he wanted and the number of prohibitions he knew the observance of which would prevent the happening of things he did not want and now many Eskimo consider it a proof of the superiority of the white men over the Eskimo that while no Eskimo had discovered that a day could be taboo, the white man had found out that important fact and had acted on it with the result that they have become a mighty and a prosperous people.

It is common that if a man is sick or has poor success in hunting or if there is any other fact or condition that he wants to change he applies to a shaman to find out what he shall do to attain his ends. The shaman will usually after the performance of suitable ceremonial rites of the summoning of his familiar spirit find out that some hitherto unsuspected thing is really aglernaktok to the man in question and he announces this fact. It may be that the man has been fond of eating the fat at the back of the eye of a caribou and he is told that this is aglernaktok to him and will remain so until he is full grown, until he is married, until his son kills his first caribou, or up to the consummation of any similar thing. In a few cases it is discovered that a man is aglirktok for life with reference to one or more things. It is a general rule that more prohibitions fall upon the young than upon the old and upon women than upon men. A child will outgrow certain prohibitions by the mere passing of years and the attainment of stature. Others he leaves behind him through the accomplishment of something such as the winning of a race, the killing of a bear, or the attainment of perfection in the art of snowhouse building or kayak paddling. Other prohibitions are left behind when the persons in question become the parents of children. This is more especially true of women. There are other prohibitions, however, that fall upon the parent at the birth of a child so that the total number of prohibitions may remain unaltered or may even be increased.

One of the most fundamental of the religious ideas of the Eskimo is this, that supernatural punishments come not so much on account of evil things being done as on account of their remaining unconfessed. If a famine occurs, for instance, a shaman will magically inquire from his familiar spirit why the food has become scarce and the answer is likely to be that some member of the tribe has done such and such a thing in secret. A woman may perhaps have eaten the meat from the wrong rib of a mountain sheep. When the spirit informs the medicineman that the woman has done this, he calls upon her to confess that she has done it. If she confesses the famine will end and all will be well, but if she brazenly asserts that she has done no such things as charged with, then the most serious misfortunes will continue to fall upon the people. A person who stubbornly refuses to confess is therefore a public enemy and will be treated accordingly. In extreme cases it may become necessary to kill a person who is incorrigible. This is rare, however, seeing that no punishment will fall upon one who has broken a taboo provided he confesses, it is obviously simpler and better to confess to a thing one has not done than to be punished for not confessing.

## GENERAL CONDITIONS OF LIFE.

Our discussion comes here to the less tangible things of which archaeological and ethnological collections can give but indirect evidence at best. A thing of fundamental importance in determining the social condition of a people is the degree of comfort in which they live and the presence or absence of the continual anxiety as to what they shall eat tomorrow. Not only "humanity" but many other things are "functions of the food supply" and of the comfort of houses and clothes. The question of the comfort and security of the lives of these people will therefore be taken up before a discussion of their social status is attempted.

Most travelers (e. g., the English explorers from Parry to M'Clintock) are a unit in characterizing the Eskimo's conditions of life as "wretched." What most of these writers say is that the Eskimo are wretched; what they really mean is that they suppose an Englishman would be wretched if he had to live as the Eskimo live. In this latter they may be right, though my own experience goes against it no less than that of the well-known English travelers David T. Hanbury and Alfred H. Harrison, men who really have lived as Eskimo which Parry and the other ships' commanders, of course, never did.

But whether or not an Englishman could live comfortably in a snowhouse on seal meat is beside the question. That their houses and clothes are comfortable in winter is sufficiently shown by the experience of such men as Peary, who have given them a severer test than the Eskimo themselves are called upon to do under ordinary conditions of life. That their native foods meet all their wants and wishes, if only they have plenty of them, is best shown by the pronounced distaste they invariably have at first for any of our foods when invited to try them. After half a century of abundance on white men's goods at Point Barrow, Alaska, caribou meat, seal meat, and whale "blackskin" are still considered the three things without which no one can be reasonably expected to do, even for a week, though tea, sugar, flour, and ship's biscuits have secured a place on their bill of fare.

In the district to which the personal knowledge of the writer extends (from Wainwright Inlet, Alaska, to the east end of Coronation Gulf) the Eskimo are in general satisfied with their conditions of life, the least so in the extreme west where the obtrusive pity and insistent commiseration of certain white men has taught them to pretend a discontent which they do not really feel, or at least do not feel in the way in which they have been taught to express it.

But although no group of the Eskimo known to me are dissatisfied with

their lot, at least in the sense in which almost or quite every class and condition of men are dissatisfied among us, and although they all live in as high a degree of average comfort as we do, there is in certain districts an uncertainty of the future that profoundly affects ethics and ideals. Among the Nogatagmiut, Napaktogmiut, Nunatagmiut, Oturkagmiut, Kaniangermiut, Killirmiut, Kagmalirmiut, and others, in fact all the inland people of Alaska who depended mainly on caribou for food, the fear of starvation was ever present, even in the periods of greatest abundance. From this resulted among these groups an inhumane treatment of the sick and the aged that, judged by our standards, amounts to the most horrifying brutality. Today when these groups have "become Christian" he is considered a much more reprehensible person who neglects to say grace before meals than he who has shut his father out of a warm house to die by freezing, or she who has exposed her child on a snowbank. Several such cases have been recorded by me that have happened within fifteen years.

Starvation is most frequent on the Colville River. It is accordingly chiefly thence that the most abhorrent things are told. One of these stories I have heard several times. The point of view of the narrators has always been the same and is of sociological interest. The man in question, one Turnnrak, a Killirmiut (upper Colville) now living in the Mackenzie Delta, shut his father out to freeze to death in a time of comparative plenty. He did it just then because his brother, who did not want their father to be put out of the way so soon, happened to be away and could not protect his father. There were a dozen other tents, all fairly stocked with food, within hearing of the old man's cries as he was freezing to death. I have never heard this murder criticised on the ground that it is wrong for a son to kill his father, or even that it is wrong to do so in time of plenty, nor have I ever heard it suggested that someone of the other houses should have taken the old man in and sheltered him till his other son came home. What all say is: "It was too soon to shut him out to freeze. He was not decrepit or sick. If he had been sick it would have been well enough." One thing no narrator omits from this story is that the old man kept crying out: "It is only a few days since my son ate five ptarmigan I snared." He was still self-supporting, that is the heart of their criticism. This incident happened a thousand miles from the locality at present under discussion. It is set down here to counterbalance, in a way, some of the laudatory things we have to say about the people east of Cape Bexley. We have learned no similar story from among them as yet, but we have learned that they undergo frequent periods of scarcity and not a few actual famines. We expect therefore to learn similar things of them in time, for hunger everywhere has a brutalizing effect on the individual and famines compel a disregard

for the weak. No one who refused to abandon a decrepit parent at such a time could himself long survive, nor would his children be likely to survive to the age of self-support. Among such a people will inevitably develop a brutal code of ethics, brutal at least when judged by the standards of the well-fed.

The stories of the abandonment of the decrepit that have come to us east of Cape Bexley, have a stereotyped self-justifying form: the party was traveling, this old man dropped behind because the sleds went faster than he could walk; a blizzard came up and he must have lost the sled trail on account of the storm, for he never came to camp. How easily this might happen without any brutality being intended, we ourselves know by the close calls that members of our own party have had more than once. If there be nothing worse hidden behind these stereotyped accounts, one finds little to condemn.

Of the exposing of babies we have learned nothing direct. Among the Akuliakattagmiut the proportion of the sexes leads one to suppose that the exposing of female children is practised. We found here ten women of marriageable age as against nineteen men. In all other groups the men are more numerous than the women, the difference is nowhere else so great as at Cape Bexley.

To whatever extent the abandonment of the aged and the exposing of children does exist, it may be considered a direct result of the scarcity of food, for it is found rarely or not at all in such prosperous, well-fed communities as those of Cape Smythe (Point Barrow) and the Mackenzie Delta, while among all inlanders it is so common as to scarcely induce comment.

We were told by the Akuliakattagmiut and Haneragmiut that the people north of them along the west coast of Victoria Island were better supplied than they with caribou in summer and seal in winter, that they never want for food. At Cape Bexley and to the east there is apparently hardly a winter when the people do not have to subsist for considerable periods on seal oil alone. The oil that takes them past these scarcity periods is invariably oil saved the previous spring and cached during the summer on some small island or other secure spot. But sometimes these "secure spots" prove insecure, a rare bear finds one of them and destroys the entire hoard, and sometimes the winter period of scarcity is so long that even though the summer caches be safe they do not suffice and starvation ensues. About fifteen years ago on a small island about three miles off shore from Cape Kendall, Coronation Gulf, about forty (?) people died in one winter of hunger.

Of crimes committed we know as yet only of murder. There may be thefts, but we never heard of one. In fact neither myself nor my Eskimo found among them a word for stealing such as is found everywhere in the

west and in many more easterly Eskimo districts (some form of tigliktuak). This word they had never heard, nor did they understand it when they heard it. Specifically, we know of but one murder, a group of people whom we found in Basil Hall Bay (three men) had killed with their caribou lances one of the Akuliakattagmiut. We were unable to learn a reason for this killing beyond that the slayers "felt angry" at him. The wife of one of the men concerned told us of it in a matter-of-fact way in the presence of the wife of another one of them.

Among the Akuliakattagmiut one family had their house two hundred or so yards from the rest. The man always kept his bow and arrows ready by his bed. We have since learned of several relatives of his living among other groups, and have heard of one man that he was afraid to return home. Everyone professes ignorance of why he was afraid and though he spent the summer largely at our camp we failed to learn anything from him. However we suppose a murder or blood feud to be at the bottom of the matter.

## THE MACKENZIE ESKIMO.

## FOOD.

In winter there were months at a time when no cooked meat was eaten by anyone except those to whom uncooked food was for one reason or another taboo. There was plenty driftwood within a few rods of any Kittingaryuit house and there was a fireplace in the alleyway of every house; blubber was abundant and several lamps continually burned within doors, yet during the dark days especially, and so long as the store of half-rotted summer killed meat and fish lasted, there was no use made of lamps or kitchen except to melt water for drinking purposes. Usually this was done over the lamps. Those who lived on lakes or rivers sometimes cut holes in the ice for water with the ice pick. Women at times of childbirth drank only snow water, and other regular and special taboos required the drinking of water from a certain source or melted in a certain way.

Although they ate in the aggregate large quantities of uncooked food, the range of foods that were considered suitable for being so eaten was not nearly so wide among the Kittingaryuit as among most Alaskan tribes. They ate freely from white whale meat (Kuak, or, Kuarasuk), frozen summer caught fish (tipa-ktok), half-thawed summer caught fish (augnerluktok) and frozen fish roe, frozen fresh "connie" (*Stenodus mackenzii*) fish (si-pl-si-t) and frozen "high" caribou meat they used only in emergencies. When they first began to be familiar with the Alaskans in the early nineties they used to say of them: "One would think they were dogs to see the way they devour raw things." The Alaskans consider the cooking of caribou brains, liver, or kidneys as spoiling good food; the Mackenzie people would eat none of these warm from the animal as the westerners prefer to eat them, nor yet frozen. Fresh caribou meat they never ate raw, either frozen or unfrozen, except in emergencies, they ate no fresh frozen fish except connies, and so the list could be extended indefinitely among the things which Alaskans like to eat raw.

Shortly after the sun comes back each winter the Kittingaryuit people move inland to the Eskimo Lakes or to other fishing localities. As long as they remain at the fishing they make their snowhouses only on the ice, generally near shore, however. The food is now fresh fish and almost every meal is cooked. Over the lamp there is but one method of cooking — boiling; at wood fires meat and fish are often roasted; frying was an unknown method of cooking till the whites came and even now few can make a full

meal of fried meat though they could and do eat a hundred successive full meals of boiled meat alone without beginning to suspect the diet monotonous.

In winter the first meal of the day was generally eaten in bed by the men, but all women not sick were expected to get up before eating. Certain taboos operated to get children dressed early in the morning; in many cases a child however after being driven out-of-doors to satisfy the taboo was allowed to creep back into bed again and to eat breakfast in bed. If frozen white whale was to be eaten it was brought indoors and allowed to thaw to a point where it could not splinter on being adzed or was soft enough to allow cutting with the knife. It was then divided into pieces, put on large wooden trays and either passed around, or else so many trays were employed that at least one of them was near anyone still in bed. The women would gather around a single tray, or else each take a piece with her to eat in her place on the edge of the sleeping platform (iglik). If fish were to form the breakfast they were brought in and allowed to thaw so much at least that the skin could be stripped off. If the fish are large (over two or three pounds) they

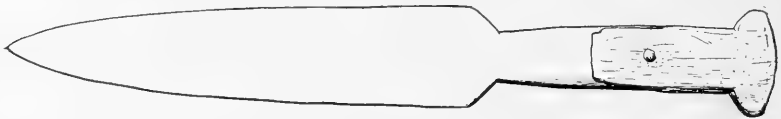

Fig. 86 (60.1-1684). Steel Knife, Mackenzie River. Length, 39 cm.

are cut in pieces; if small they are served whole. The women slit the skin along the belly, take its edge in their teeth and strip it somewhat as one might peel a banana. The procedure is then the same as for frozen meat. This method of serving raw fish differs from the Alaskan in that among the westerners each man has to cut up and skin the fish he eats.

Besides the frozen fish there are three important adjuncts to the breakfast: a pot of oil, a pail of ice water and some sort of a hand wiper and face wiper to get the oil, blood, and other ingredients of the meal off one. The oil at Kittegaryuit was generally that of the white whale; along the ocean shore proper it was more likely to be oil of seals or bowhead whales; inland it might be any of these, purchased where most convenient. Preferably the oil was "soured" by having been kept in air-tight bags through the warm summer; this fermented oil is much more agreeable to the taste and is apparently more digestible than the fresh, which is used only under necessity. Pieces of the frozen meat are dipped in the oil before being put in the mouth; or else the first and second fingers are dipped in up to the proximal joint and the oil sucked off them. The water pail passes around



frequently, for a meat diet requires much drinking. The hand-wipers generally consist of wads of freshly made fine wood shavings (excelsior); more rarely the skins of birds are used, especially of loons, and of recent years sometimes cloth.

The other meals do not differ from the breakfast essentially except that a single food tray usually suffices for the men of a house. There are nowadays at least seldom over fifteen. The tray is then usually set near the center of the sleeping platform, and alongside it the pot of oil. All gather about in a circle; if some cannot reach the tray, pieces are handed them over the shoulders of the others, or they may join the women and children who usually gather about a separate tray. Though there is no disgrace involved in eating with women, as a matter of fact, it is the younger or less influential who are crowded out of the men's circle. If the household is small, men and women eat from one tray.

The foregoing discussion of "table etiquette" applies to households consisting of one leading man and a number of dependents, married or single. In perhaps a greater number of cases housemates consisted of two or more families each independent of the other. Outdoors they had their separate food stages, at the summer hunting stations they had their separate meat caches. In such a case each woman brought in food for her own family only and ate with her husband and children. If, however, one family is having a meal of fish while another is eating meat, the woman of the first family will make a gift of fish to the woman of the second, and *vice versa*. In making these gifts it is etiquette for each woman to ignore the other's husband and family; she must address the woman only and must use the singular, never the dual or plural, the idea being that the other woman individually and not her family collectively receives the present. The gift received is, however, always shared with the husband. Gifts of food are also handed out to her housemates by a woman whose family takes a meal at a time different from the mealtime of the others, e. g. on the home-coming of her husband from hunting. If one family is short of food or out of food while another has plenty, those who are short receive lump presents which they divide among themselves and eat in their own eating places. If a traveler arrives, he is usually more intimately connected with one family in the house than another and he is therefore looked upon as their guest. The other families in the house will, however, contribute to his meals each of what it has; they will eat at the same time as the visitor does, as a sign of respect for him, or to show they are glad he came; each family, however, in its own place as usual. If the visitor is an absolute stranger, he will be entertained by the most prominent family of the house. Stinginess occurs among the Mackenzie people, but is rare, for "thrift" is not an admired quality; such families will

shirk the entertainment of strangers and even refrain from eating at different times from the other families so as to avoid the practically obligatory giving away of food on such occasions.

Meals were seldom taken in the club house by the men in winter; the club was in use only in the fall while sleds, etc. were being made. It had (at Kitegaryuit, and in most other places probably) an open fireplace in the center and a large smoke hole above it. This arrangement could not keep the house comfortable after real winter weather had set in, and it fell into disuse. Summer meals in the club house will be described later; their character was the same in autumn, though the club was then less frequented and many men took their meals at home.

Towards spring, fish was not always the only article of food; there were caribou, ptarmigan, rabbits, and moose in different inland districts and seals were killed in spring in some numbers at Cape Bathurst and elsewhere. These were always boiled or roasted, never eaten raw or frozen.

In spring came into effect a remarkable food taboo — remarkable because of its general application. Most of the Mackenzie people of all ages and both sexes were forbidden to eat eggs of any sort, a prohibition that would mean little to the Coppermine Delta, for example, but which in the Mackenzie Delta means that a body of people who might otherwise have been drawn out to the low mud islands to reap the easy harvest of thousands of goose, duck, and other eggs were by it kept to the mainland fisheries and hunting grounds. Many taboos are arbitrarily imposed on individuals by the shamans, many others apply to all persons without exception, e. g., that against eating brown bear liver; but the egg taboo was prescribed upon them by the children's parents and it held through life. Other taboos similarly imposed generally held only till puberty, till marriage, till the birth of progeny, etc. There was a general doctrine to the effect that the eating of eggs caused illness, but that a few individuals were immune. Some parents would therefore experiment with their children; would feed them an egg or part of one and watch for results. Sometimes illness did not come quickly, and in occasional cases the parents were already rejoicing that their child was immune and might eat this delectable food freely, when illness of some sort came. This might be severe or mild, but it was at once seen that the eating of the egg had caused it, and eggs were therefore taboo ever after. Other parents were so careful with their children's health that they never even ventured to find out, but forbade them eggs from the start. A few of these later in life, knowing their immunity had never been tested, would try the matter out for themselves, with varying results. From the ranks of these were recruited some of the few egg-eaters there were; the larger part, however, seems to have consisted of persons who while children, before they

learned to recognize the danger of violating a taboo, surreptitiously indulged in egg-eating. When at last these learned to fear taboos in general, they had been eating eggs so long that the conclusion they must be immune was unavoidable.

Those who ate eggs boiled them. They were eaten at all stages of incubation. A female bird with embryonic eggs was not taboo to anyone by virtue of the egg taboo, but all vestiges of eggs must be carefully cleaned out of them before cooking.

No part of any bird was ever eaten uncooked unless it were dried. Dry meat was made of the breasts of any birds that were caught in numbers but especially of geese, brant, and swan. The rest of the body was eaten fresh or somewhat high, according to circumstances. Fresh birds were often roasted, when high they were generally boiled.

The important part of the summer at Kittegaryuit is the white whale season which begins about the tenth or fifteenth of July and ends some time in September. The earlier part of the season, however, used to be taken advantage of, for the pursuit of the caribou needed for clothing began so soon as their skins were in condition, or between the beginning and the middle of August. Of the first few whales killed the skin was removed, as elsewhere described. After everyone had sufficient materials for leather, the blubber (from  $2\frac{1}{4}$  to 4 inches thick) was allowed to go with the skin and the whale (sirkuvyak) was cached to rot in shallow pits covered with earth. The flippers as they are, as well as the head and the rear third of the body (itiryukak), also go to these pits (kiñnirk, kiñnerit). The meat of the forward two-thirds was sliced thin and hung up to dry (mipku), some of it in smoke houses, some to be wind-dried. In the case of animals whose skins were preserved, the "false skin" (ganirk), sliced off the outside of the hide, was cut into small pieces, boiled, and preserved in oil in air-tight bags, or it was hung up to dry; in either form it was considered a great delicacy. It was preferred half dry, to thoroughly dry, for in the latter case it was hard to chew.

Some of the whale blubber while fresh was cut into pieces and put into skin bags to ferment. Most of this was plain blubber, but occasionally some was cut so that each piece carried with it a portion of skin. This was the múkta<sup>r</sup>k, corresponding to the múktak of the bowhead-hunting communities.

When well dried some of the white whale meat was cut in domino-sized pieces and put into bags containing a little oil. This was the gilittat, the most prized food known to the Mackenzie people; the ullia'kat, or, ullia'kkat (uliaga<sup>r</sup>k) differed from the preceding only in that the pieces were some three or four inches square in area. The gilittat were made of white whale meat

only, while the name ullikkat might apply to any sort of dried meat kept in oil. It seems, however, that dry meat of caribou or birds was never put into oil bags, at Kittegaryuit only white whale and at other places white whale, and seal (common and bearded).

Fresh mükta<sup>r</sup>k raw, though considered a delicacy by most Eskimo was hardly eaten at all by the Kittegaryumiut; boiled it was eaten more freely, but never many meals in succession; it was not considered good eating until it had become high through storage in the meat pits, when it was relished either thawed or frozen raw.

Netting for fish was done before the coming of the white whales and even during the whaling season women often set nets. Some of the catch was placed in pits covered with logs and usually straw to keep out sun; some were cut up and smoke dried or wind dried. Between cutting up whales and cutting up fish, the women's palms were often worn to the flesh by the ulu handles. Even if the fish were not dried there was much work for the women in cleaning (gutting) them before they went into the pits.

Though the Kittegaryuit were not given to eating any other unfrozen things raw, they were fond of raw fish that had been allowed to lie a month or so in the warm, log-covered pits. This fish, mentioned above under its winter name of tipaktok was eaten in summer under the name of erkalug-yuak.

The heart and kidneys of white whales were among the first things to be eaten. They were roasted on vertical spits beside the fire. The stomach and gullet were taken for use as oil bags, etc., the lungs, liver, and intestines were thrown away. A week or two later, however, if some one found a well-rotted pair of lungs not yet devoured by the dogs, the bronchial tubes were separated from the body of the lungs and boiled. This was a much-esteemed dish.

As stated elsewhere, each tent during the whaling season had its kitchen, or else it had one in common with one or more other tents. The cooking was done here by an open fire. Each woman ate her meals at home with her children. At this season no man able to walk about took his meals anywhere else than in the club house. When a hunter returned from his kayak rowing, he walked directly to the club; it was the woman's business to watch for his coming and to bring him food to the club so soon as it could be got ready — really she was expected to possess a sort of prescience and to have the food boiled but yet still hot at the time of her husband's arrival. If a hungry man had to wait long for his food, or found it underdone, overdone, or cold when it was brought, there was likely to be trouble in the family. As most Eskimo like to have the boiled meat just a trifle underdone, the woman's task was somewhat difficult.

Boys did not generally begin to eat in the club house until they were grown and had become hunters. Children of either sex would wander in, however, and were often given hand-outs by their fathers. This was not frowned on but a set meal was allowed only grown men. Cripples unable to walk ate by themselves at home, however, and so did the blind. Men too blind to hunt but who could yet go about, would eat at the club; convalescents would go there as soon as they could be about.

The caribou hunt was carried on in a desultory way all summer, but it was the first part of August to October only, that much energy was put into the matter. When women were along they cut up meat and spread it to dry, and occasionally the men prepared dry meat (*mipku*, or, *gu*) if no women were with the hunting party. Much of the caribou meat, however, was merely buried so as to be comparatively safe from animals. After the freeze-up the venison was often dropped into shallow lakes through holes in the ice. The high flavor developed in these ground caches or in the meat dropped into lakes, made them comparatively palatable to the local taste. This article of food is mentioned in the winter menu under the name of *kuak*.

#### CLOTHING.

In most of the garments made at present the local Mackenzie fashion has given way to those recently introduced from Alaska, and it is only by careful questioning of the older people one can learn what the local style really was.

The preparation of skin for the various articles of clothing is discussed elsewhere.

Summer boots (waterproof) had their uppers made preferably of autumn-killed seals. A medium seal made a pair of boots. The tops came to just below the knee, were drawn tight with a drawstring (*uñeron*) and were not trimmed with *nalluak* which is now the fashion. The soles were of white whale, crimped with the teeth at heel and toe. The crimped part was sewed to the upper with a welted seam, the rest of the sole with "plain sewing." The toe was shaped as the foot and the boots could not be shifted from one foot to the other; today the western rounded toe is in use and it is considered advisable to shift the boots from one foot to the other every day. No ankle lashings were used with any Mackenzie boots.

The socks used at all seasons were the same, though partly worn out ones passed muster in summer when they would have been unsuited to winter use. Their tops came up even with the boots and had a drawstring as the boots did; they were made entirely of the body skin of short-haired deer,

or of long-haired skins that had been clipped. Between the socks and boots was worn a slipper of caribou legskin.

When about the house in summer the men wore "fancy" boots of two general types, both knee boots with drawstrings and white whale soles. One sort (atirkak) had the uppers made of caribou legs with black and white ornamental stripes of short-haired skin running down the sides of the leg a little forward of the middle of each side.

Another sort of boot (atirkak tiv-yalu-k), the "holiday" boot proper, had the uppers made of dark short-haired summer caribou skin. Animals used for such boots had to be killed in July before the old hair was all shed, the last remnants being plucked off with the fingers before the animal was skinned. The ornamentation of the boot consisted of a stripe running down the full length of the front, an inch wide at the top but narrower down. There was also a diagonal ornamentation on the outside of each boot leg. This consisted of two outside strips of white caribou belly skin about half an inch wide, a middle white stripe about  $\frac{1}{2}$  inch wide, and two  $\frac{1}{8}$  or  $\frac{1}{10}$  inch wide strips of black caribou skin separating the three white stripes. Along the upper edge of the lowest white stripe was a row of red dots made of the red skin found above the eyes of the willow ptarmigan (*Lagopus lagopus*).

On both sorts of ornamented boots there is above the white skin sole an inch wide strip of black sealskin (water boot material) and above that a half inch wide band of white sealskin (ka<sup>r</sup>k soktak).

In general, the coats and trousers worn in summer were merely the half worn-out underwear of the preceding winter. Good caribou skin clothes could not be safely worn in summer except about the house, for the first rainy day would have spoiled them. At Kittingaryuit, it seems, sealskin rain garments were never used except the kayak coat; towards Baillie Island sealskin coats were used occasionally, but it is difficult to say if they were made as raincoats proper, or if they were mere makeshifts due to a scarcity of caribou. About camp thin and loose ornamented outer garments were slipped on occasionally by most men for dancing purposes, etc. and by "dressy" persons they were used about camp whenever the weather was fine. There were no caps or hoods corresponding to the hoods worn for protection from mosquitoes by the mainland tribes of the Copper Eskimo.

In winter legskin "fancy" boots were much worn — with them, as with us, holiday clothes become everyday clothes so soon as they show wear. Those whose families had industrious seamstresses seldom wore unornamented boots. That these "fancy" boots were really everyday boots is shown by the fact that they have no special name, they are merely atirkak or boots. The skin of all the four legs of a single caribou went to each boot; the skin of one hind leg made the front of the boot leg, another hind leg

made its back, the two front legs made its sides. Along the outside of each boot leg through its whole length ran a band of black and white stripes; two outer white stripes each about half an inch wide, a central white stripe about  $\frac{1}{3}$  inch wide, and two black stripes each about  $\frac{1}{10}$  inch wide, separating the three white ones. Along the front edge of the rear broad white stripes ran a line of red dots, made of ptarmigan head skins.

There are three sorts of plain knee boots in common use. One is the ornamented legskin boot with the ornamental stripes and dots left out; like the ornamented boot this has the name of artirkak only. A second plain boot, which also lacks a special name, differs from the preceding in that its instep is formed of the hock skin of the caribou instead of the hock coming half way up the calf of the boot. This is the easiest of all boots to make (it is the inexperienced seamstresses' refuge) for the natural shape of the hock skin just fits the human instep, so there is no complicated cutting and splicing to be done. But if the hock skin is brought down to the ankle, some five to eight inches of the legskin will stick out beyond the toes. This is cut off and goes to form the uppers of the women's short boots.

The third of the plain boot styles is the tunñayuk. It differs from the first of the plain styles described, only in the omission of the bands of seal-skin; the caribou legs come right down to the white whale sole, hence their name, i. e., the upper touches the sole (tunñayok — it touches).

The kaera'y-u-k is a sort of makeshift boot worn at any season by all ages and both sexes, but especially by children in spring and summer. It has a sole of white whale, above that is a band of thinner white whale skin two to three inches wide. This forms a sort of slipper which is worn about the house as it is; or an upper may be sewed on it, in that case usually the leg cut off a worn-out water boot. The name is said to refer to the fact that the whitefish upper of the slipper has only one seam (at the heel, or up one side), and is therefore smooth on the toe (ka-erktok — it is smooth).

#### WORK IN SKINS.

Up to the coming of the first whaling ships in 1889 the only freight-carrying boats of the Mackenzie Delta were the (typical Eskimo) umiaks. As walrus are absent from Mackenzie waters and bearded seals are rare, the skin covering for these boats was sewn from the hides of kilalukkat (sing. — kilalugark), known popularly to us as whitefish or white whales (*Delphinus leucas*). This large mammal supplied the Kittegaryumiut not only with boat covers, but also with bootsole material (or spring and summer waterproof boots as well as for boots used in winter on the always damp sea

ice), and material for lines. When so worn out or rotten as to be unsafe as boat covers, they found their final use as covers for summer shelters, kitchens, and smoke houses.

Whether the skin was to be used for boat material or for boot soles, it was removed from the freshly killed animal as follows: circular incisions were made around the neck of the animal and around its body well towards the flukes; the skins of the head always and of the tail usually went for food, becoming the *maktak* described under the section of foods. These two incisions were then connected by a third along the ventral median line and the skin stripped off with the *ulu*. While as yet fresh, all blubber still adhering to the skin was scraped off with the *ulu*. From the outside of the skin was pared off the false skin which seems to correspond to the hair of ordinary mammals. This was done by hanging the skin over a smooth log of driftwood. The woman then took the *ulu* in both hands and, using it somewhat as one might a plane, pared off the false skin. The "technical" term for this paring process is *kilioktok* (*gilioktok*).

The meat of the animal was sometimes cut up for drying before attention was turned to removing the false skin. It is said, however, that a few hours toughen the *maktak* and make it hard to remove with a knife.

When cleaned as thoroughly as possible, the skin was pegged out on the ground to dry. It must be pegged with the flesh side (blubber side) down to insure its drying properly; it must be pegged with its headward end "faced" inland, its tailward end pointing to seaward to assure the coming of more white whales next year, for if the skins of the dead white whales had their tails turned inland the live whales would also turn tail and none would ever come to that part of the coast again. As the heads of the drying skins face this year, so will the heads of the migratory animals be pointed next year.

If the skin is to be used for a boat no further treatment is needed; next spring when the boat covers are to be sewed it needs merely to be soaked in water for a day or so to soften it to the needle and to make it stretch well over the *umiak* frame. If the skin is to be for bootsoles or for thongs it is, so soon as thoroughly dried, taken to form part of the roof of an open-fire kitchen or a smoke house. The blubber side is the one smoked; the purpose is said to be to prevent the little blubber which still adheres to the skin from getting a rancid taste unpleasant to the women who must eventually "chew" the skins. When the skin is considered sufficiently smoked, perhaps in two weeks, it is removed and replaced by another new skin to be smoked or by an old and worthless one. Boot sole materials may then be cut from the skin as needed, or the whole of it may be cut up into suitably large pieces at once. Each boot sole is then chewed to get the last remnants of the



blubber off and to soften the skin; only the blubber side is chewed. The chewing done, the sole material is then sponged with water to soften it and the blubber side is scraped a bit with a stone or iron scraper. When this is done it is either dried for future use or immediately sewn to a boot. If thongs are needed the skin is cut into strips whose length is the full length of the hide. These are then chewed to get the blubber out and further softened by being pulled dry back and forth through a loop of thong.

If the tailward part of the white whale skin is used for anything but food, it is to make a bag for oil. If this is the intention, the median incision of the rest of the body is carried down to the flukes, the skin is removed, and in every way treated as is the case with the body portion, except that the smoking is sometimes and the chewing is always omitted. When a bag is to be made, the skin is merely soaked in water till thoroughly soft, and then sewed up, the mouth of the bag being at the tip of the tail. These bags are at once filled with oil before they have time to dry.

Seals, for whatever purpose the hide is intended, are skinned so that the lighter colored thinner belly portion all the way from neck to tail is in a separate piece from the rest of the hide. This thin skin (the ummaksak) eventually is to be used for the uppers of the ankle boots (gaugak-gak-gat) worn about the house by most women and children and by some of the men. The two incisions for removing the belly skin are made in such a way that the main body of the skin shall have its long edges approximately straight and parallel; that this should be so is especially desirable if it is intended for a kayak cover.

If the skin be intended for the uppers of water boots, the hair is shaved off with a sharp ulu while the skin is fresh. It is then dried by being pegged on the ground, unless immediate need for boots demands quick drying in the warmth of the house. Those skins are considered to be inferior that are house dried. The material for boots is chosen with care. The freshly killed seal is examined by the women. It is said that irrespective of age or sex the skin is darker on some than others. The darker it is the better boots it will make; the whiter ones are less valued. The "better" in this case seems to refer largely to looks, and anyway hardly any two Eskimo tribes agree as to what sort of skin will make the best boots. Kotzebue Sound people, for instance, say that the lighter skins are better, and that the more nearly transparent a skin is when held up to the light the better will it keep out water. Most tribes agree, however, that autumn-killed skins are the best; the chafes and scratches found on the skins of seals that bask on the ice in spring make them ill-suited to most uses. The skin is thinned by one dry scraping of the flesh side.

If the need is for boot soles a thick skin is chosen, generally that of an

old male seal. Its hair is removed by scalding; the fresh skin is dipped repeatedly into hot water and the hair scraped off. It is then dried either in the house or out-of-doors.

Skins intended for kayak covers were placed in a bag while fresh. They were then kept in the house if it was winter, or outdoors in the sun if it was warm enough, and the hair was allowed to rot off slowly. The kayak cover was usually sewn while the skins were still wet and their first drying was on the frame of the finished kayak. A kayak cover seldom wore out in one year, and it seldom lasted four years. With both umiaks and kayaks, the life of the skin depends on how frequently and thoroughly the boats are dried much more than on the number of days they are actually in the water. Three weeks or a month of warm rainy weather will ruin any skin boat, if both sides of the skin are allowed to get wet; a skin canoe lying bottom-up on shore would not be much damaged by a month of rain.

Old kayak covers were used to spread on the floors of snowhouses (traveling camps) underneath the bedding; in summer they had similar uses in tents or were used to roof summer kitchens, smoke houses, etc. or to spread on the ground in the open outdoor work places of the men.

A specially prepared white sealskin (nalluak) was used chiefly for the trimmings of women's and children's 'fancy' boots (gaugak). A medium or thin skin was chosen; while fresh it was rolled in a bundle, hair side out, and put in the warmest place in the house; usually over a lamp, or near the peak of the roof in a wooden house. When sufficiently rotted the hair was plucked off with the fingers. The skin was then staked out in a shaded place outdoors. This should be done so early in winter that it might be thoroughly dry before the spring thaws. The treatment produces a leather, white with a slight yellowish tinge; the flesh side is somewhat darker.

If a bag for oil is to be made of a sealskin, the animal is skinned through an opening made by a circular incision around the head at the eyes; the skin is "cased" as a furrier would say. A careless person or one in a hurry, may make the incision around the head at its largest diameter, somewhat back of the eyes. The claws of the flippers are left in the skin, usually, so that the incision at the eyes is the only one made. The bag is turned hair side in and inflated, for if not air tight, it would probably not prove oil tight. These bags, besides being used to hold oil, are in whaling communities used for floats attached by a line to the detachable head of the whaling harpoon. In the white whale hunt smaller floats are used; generally inflated white whale stomachs.

Bearded seals are rare in Mackenzie waters and their skins do not seem to have had any specific use. Following fashions recently introduced from Alaska, some Mackenzie women use them at present for bootsoles, especially if beluga skins are scarce. In imitation of Alaskans, too, the ulu is

largely discarded as a tool for removing the hair from common and bearded sealskins that are intended for waterboots and bootsoles. The skin is dried hard and kept unwrinkled by being tightly stretched while drying. Dry wood ashes are then spread over the skin and the hair removed by scraping with a dull stone scraper.

The use of bowhead whale skin for bootsoles has been tried of recent years occasionally. The idea is pretty surely of Alaskan introduction since 1889. The treatment is about the same as for white whale skin. It is said, bowhead skin makes better bootsoles than white whale, which in turn is preferred to bearded seal.

Fish skins were less used in the Mackenzie district than in many sections of Alaska. Of the whole skins of the kaluakpúk, were made bags of all sizes and for various uses; they were rainproof and well suited for storing spare clothing, dry sinew, dried fish or other things that must not get damp. Of the whole skins of titalirk were made bags and of their belly skins, windows. Of kaluakpúk skins windows were sometimes made, but these were considered inferior to most of the other common window materials. Kaluakpúk skins were used for kayak covers by the Inuktuyu-t of the Eskimo Lakes in the memory of men still living.

Different parts of the alimentary tracts of various sea animals had their uses apart from the role they played as food. As mentioned above, white whale stomachs were used for harpoon floats and for oil bags: their gullets too were employed as bags for oil, and when this had increased their transparency, they were often sewed into windows; fresh gullets were occasionally taken for windows too. The common Alaska use of intestines of various animals for windows was not in vogue near the Mackenzie.

Bird skins were not used for clothes at all in the Mackenzie District. Bags for holding the lines used in white whale hunting were made from skins of loon and swans. Tobacco bags were also made of the same skins, and women's work bags were sewn of the foot skins of swans, the claws being left on. Windows were frequently made of the gullets of glaucous (and perhaps other) gulls and more rarely of those of loons. Skins of all sorts of birds, but especially of loons were used for handwipers.

The bills of loons and portions of other birds were often used as talismans.

Polar bears were seldom killed in numbers in the delta region proper or even at Herschel Island, but from Toker Point to Cape Parry they are more frequently met with. As several persons usually took part in the pursuit of a single bear, the skins were usually cut up into portions so small as to be unsuited for anything but mittens, and this accordingly was about their only use. The pieces were dried either indoors or out and then softened by scraping with the ordinary metal or stone skin scrapers.

Brown bears (*Ursus richardsoni*) were not often secured. It can scarcely

be said that their skins played a rôle as clothing. The headskin and the skins of the forepaws were worn as cap and mittens in the midwinter bear ceremony; the working of these parts of the skin consisted essentially in drying and then softening with the scraper. The remainder of the skin was merely dried, and then used for bedding. The possession of a brown bearskin is much desired by those who have growing boys, as children sleeping on such a skin will become quick to anger and of an unforgiving disposition. Growing girls should never be allowed to sleep on one of these skins, for women should be of a mild and forgiving temper.

Wolfskins, and the skin of all the large land quadrupeds, were removed from the body much after the manner described for caribou. The claws of all animals except wolverine were let remain with the carcass. Wolfskins were usually dried indoors but sometimes they were pegged out on the ground or snow. All fat was removed at the time of skinning the animal, and the dried skin was softened by scraping. No coloring was applied to the skin side, though that was done with wolverine. The headskin was used for ceremonial caps, the body skin for the trimming of coats, the legskins for boot legs and the tails for the belts worn by men and boys.

Wolverine skins were treated exactly as wolf skins except that the claws were let remain on the skin and that the flesh side of the skins was colored red either with ashes or pulverized rock (ocher). The head, body skin, and tail were used as the corresponding parts of wolf skins were used; the feet were cut off so as to leave three or four inches of skin with the claws. These were then slit so as to leave each separate claw at the end of a ribbon of skin; the strips were then sewed on to men's belts so that they formed pendants about four or five inches apart.

It is not unlikely that muskrats are comparative newcomers in the Mackenzie delta; however that may be, their arrival antedates the knowledge of people now living and their skins are said to have been "always" of importance among the sources of the clothing supply. They were "cased" in the manner we employ with small fur animals; the claws remained with the carcass and so did the tail, the latter because of its importance as food and source of sinew for sewing. The skins were dried by being hung up without stuffing or stretching in any way. When thoroughly dried, the skins are rubbed between the hands till fairly soft; next they are dipped in hot water in which meat has been boiled, or better still fish (no stress is laid on there being fat in the water or not) and pulled and stretched when thoroughly soft. A second drying follows, and lastly the skins are powdered with a chalk-like decomposed rock and then a coarse soft sandstone. The skins are then slit along the ventral median line. They were never separated into back portion and belly portion until that method was recently

brought in from Alaska. By men, muskrat skins were used for inner coats, inner pants, inside mittens and (rarely) socks, by women for inside mittens and inner coats.

Though much used both in Alaska and by the Copper Eskimo, the skins of marmot (*Spermophilus Parvi*) were never preserved, in fact the whole animal was thrown away, not even were dogs fed on them. It is said nowadays that this is because they burrow in and under the graves of the dead; this may be the real reason for the taboo, for there is fear of anything that comes in contact with a corpse. The taboo seems local between Cape Parry and Demarcation Point, the international boundary.

Until some six or seven years ago when their numbers suddenly decreased greatly, caribou were more important than all other animals together as sources of the clothing supply.

To remove the skin an incision is made around the muzzle about half an inch back from the corners of the mouth; from this cut another incision is run along the ventral median line back to the roots of the tail; an incision from back of each nostril runs up to each corresponding eye and horn. From the hoof of each hind foot an incision passes up the back of the leg to about four inches above the hock when it curves to the inside of the ham and thus till it intersects the median cut. A similar slit is made up the front of each front foot to about four inches above the knee and then curves to the inside of the leg and intersects the median cut on the breast. As appears in the discussion of boot-making, it is important that the legskin be removed quite down to the hoofs and that the incisions along the legs shall not curve till well above the hock.

After the necessary preliminary cuts have been made a knife is not much used in the skinning, except about the eyes and horns. Old bulls are an exception to this statement, however; especially when poor their skin requires the knife. Otherwise the hide is removed by grasping a flap of skin by one hand and pushing the fist of the other hand between the skin and flesh; on portions of the sides and back the skin is so loose that after the legs, head, and neck have been skinned one can strip the rest off by taking hold of the headward end and pulling back towards the tail.

The moment the skin is off it is spread out on the ground: if in summer, to begin drying; if in winter, to freeze without wrinkles. After being taken to the summer camp the skin is again spread out on the ground, if that be safe from the dogs, or else hung up across a pole. Not unless dried indoors, is the skin pegged out or stretched on a drying frame, except those intended for tents or for bedding. If it be winter, the skin is either house-dried (which is considered injurious) or wind-dried by being hung up outdoors, hair side only exposed to the wind and sun.

Of recent years Alaskan methods of working caribou skins have been adopted by some Mackenzie women, apparently not because they think them better but rather to be in the fashion, for in many things the westerners are now "leader of fashion," partly no doubt because of partiality to them shown by the white whalers. Those who still keep to local methods begin by softening the edges of the skin and especially the headskin by removing most of the hardened fascia attached. The skin is then warmed (*sirlaksiga*, literally, makes it crack) by being hung up near a fire or by being used as a blanket over night, the flesh side of the skin next the naked body of the sleepers. This warming process is supposed to make the dried fascia brittle and easy to remove. The warm skin is now sponged with water which is usually approximately of blood temperature. Immediately after the sponging the skin receives its second scraping which does not yet remove much of the fascia. The skin is now rolled up, flesh side in, and let remain a few hours, usually over night. The last scraping removes all adhering fascia, dries the skin and leaves the flesh side soft and white.

The Alaskan methods now adopted by some differ from the local in the following respects: the first scraping involves the whole skin, instead of the edges and headskin; the wetting of the skin is with a mixture of caribou brains and water or of caribou liver and water, instead of water alone. The brain or liver may be fresh or rotten among the Alaskan Eskimo (*Nogatagmiut*, etc.); thoroughly rotted brains are used by the Bear Lake Slavey Indians. Just before the last scraping the western method requires the sprinkling or rubbing over the skin of a powdered whitestone. The Kittgaryuit women say the skins treated the Alaskan way are no better and no worse than those prepared in the old way; there may be a vague taboo idea behind the adoption of the new method, besides its fashionableness; at any rate we can testify that the western method has no marked advantages over the eastern. For four years we have had in our employ women who dress skin in the manner of the Killirmiut and *Nogatagmiut*, as well as a woman from Kittgaryuit who adheres to the old method. The last named has made better clothes for us than the other, rather however because of better workmanship than superior methods. The different skin dressing processes seem to give identical results. We have also purchased and used garments, blankets, robes and unsewn skins dressed by the Loucheux of Fort McPherson as well as by Slavey and Dog Rib of Bear and Slave Lakes and various points on the Mackenzie. These Indians apply to the skins between scrapings various dressing preparations, notably rotted caribou brains. The finished work does not show that these preparations have any effect whatever on the skin beyond those produced by lukewarm water.

For reasons put forth elsewhere it seems likely that muskrats have not been in the Mackenzie Delta over a hundred years or so; we know that for

the greater part of this time there was at least occasional semifriendly contact with the Loucheux. It is interesting to note in this connection that Indian ways of "tanning," though never used with any skins with which the Eskimo are certain to have been long familiar, are used with muskrats. The knowledge of the animal itself is likely to have been first obtained from the Loucheux, and along with that knowledge seems to have been borrowed, in part at least, the Loucheux method of working its skin.

An example of division of labor between the sexes is found in that the fourth scraping of caribou skins is often done by the men. They however usually avoid the working position used by the women and do the work standing, generally out-of-doors. The skin is hung by its headward end from some elevated support and the scraping is done by holding the implement (the same as used by the women) so that its blade takes somewhat the position of an adze blade; the skin is then struck with a free hand movement much as one might adze a log. The method is not adapted to thin or fragile skins.

In agreement with the Alaskans, but contrary to the practice of the Copper Eskimo, the Mackenzie people used short-haired skins for under garments and longer haired ones for the outer coats and pants; as everywhere among Eskimo the inner garments had the hair side turned in, the outer ones the hair turned out. One adult caribou sufficed for the inner or outer coat of any but the largest men; two were required for a woman's coat, largely because of the big hoods. The main part of the hood was made of the headskin of the caribou that formed the back of the coat; leg-skin was used for the boot legs for both sexes and for large gauntlet mittens; body skin was used for socks and legskin for slippers worn between the socks and boots. If a short-haired (August killed) caribou had an especially white belly skin, this was taken off in a separate piece somewhat in the manner described for skinning seals; these were used for the decorative piece work of the outer garments of both sexes, but especially for the women's coats.

Caribou killed between the first week of August and the middle of September furnished the bulk of skins used for clothing; fawns were considered good for a month after that. If it was necessary to use for garments skins the hair of which was considered too long, the hair was thinned and shortened by currying or shortened by clipping. The soles of winter boots are nowadays made of the October killed skins of old bulls; until the coming of the Alaskans (1889 and after) caribou skins were considered unfit for bootsoles, white fish soles were used. Caribou used for boot soles is scraped twice with one wetting between, allowed to stay wet for a day or longer.

It is probable that when the first moose came to the Mackenzie Delta he found the Eskimo already in possession. The people, however, do not

seem to preserve any memory of his coming, but the fact that mooseskins are little valued or used is itself a proof that this valuable animal is a new-comer. The conservatism of the Eskimo prevents them from readily devising uses for new things, and the Indian method of preparing mooseskins could have little attraction for them for, as the writer can testify from experience, the products of their tanning offer less protection from a cold wind than does good woolen cloth. While well-suited to timbered regions, a moose coat is unfit for the blizzard-swept barrens; in fact, you can blow out a candle through the skin of a bull moose.

The preparation of mooseskins consisted generally merely of simple drying. They were then used as bedding, as parts of the walls of smoke houses, etc. If white whale skin for boot soles gave out, soles were occasionally made of mooseskin by clipping the hair short and scraping and chewing the flesh side. As the white whale skin was used so long as it lasted, the shortness in boot soles did not generally occur except in summer, and it was for water boots therefore that the moose was chiefly used.

In the Mackenzie Delta proper and inland on the Eskimo Lakes sealskins for kayaks could be had only through hunting expeditions far from home, or by purchase from the country east of Toker Point or west of Escape Reef. Caribou were therefore often used for kayak covers: for this purpose were chosen the comparatively light skins of females, killed in August or early September, skins that were not made unfit by the holes made and kept open by the larvae of the bot-fly. These kayaks were said to be heavier and to rot and wear out more quickly than those of seal. Natives of the upper Colville River, however, say that caribou skin kayaks are lighter than seal-skin ones; which side has the truth of the matter is doubtful.

Skins not well suited for clothing and not needed for kayaks were used for bedding, for blankets (sleeping bags do not seem to have been used and there was no need for them in the warm earth or snowhouses), for hold-all bags (short haired spring skins), and for tents. Sealskins were seldom or never used for tents in the delta, but were occasionally used elsewhere, especially at Cape Bathurst. Caribou skin tents usually had the hair side out, but sometimes the flesh side faced out. For tents skins were not scraped, but were dried pegged out to prevent their shrinking; if in winter, they were merely spread out to their full size on the snow to freeze. A skin thus frozen does not shrink in drying, provided the drying is completed before it can thaw. Skins intended for bedding were treated in the same way.

Sinew furnished the only sewing thread of the Mackenzie people as well as of all other Eskimo; of the various sources of sinew the caribou, until recently, was the most important.



## MISCELLANEOUS NOTES.

As an introduction to this section the Editor wishes to state that at Mr. Stefánsson's suggestion he selected from the journals of the expeditions such passages as in his judgment contained useful anthropological data not fully presented in the author's book, "My Life with the Eskimo." The author's absence on another expedition made it impractical to submit the selections for his approval, so that he is neither responsible for the choice of data nor the arrangement. To the Editor it seemed best to present the various extracts in chronological order under their respective dates of entry to facilitate their use in connection with the author's previous work.

## THE MACKENZIE DELTA, 1906-7.

*August 11, 1906.* Herschel Island. The schooner "Olga," Capt. Klinkenberg (Jorgensen) arrived yesterday morning from a winter at Minto Inlet. They report plenty of natives, "the cleanest they ever saw" at Minto Inlet. They used copper knives, plenty of copper, deer, bear, fox, etc. Prince Albert Land natives had no seal or fish nets. Were shown how to make and use them by Capt Klinkenberg. Had slit wood goggles. Two tribes of natives Minto Inlet: Could speak with Kogmollik from Baillie whom "Olga" took down. A few words different. Coat cut swallowtail; down to end of sternum in front only. Inside pants to reach up and under coat, and fancy leggings over. Did not see any water boots. Part hair in middle; braid it in two braids and hang over shoulder in front; carry babies in large hood. Most of snow knives, etc., of copper. Copper ice picks.

Saw about two hundred and fifty natives, all told, on Prince Albert. These said there were more. Game is inland in winter. Think Banks Island better for game than Prince Albert. Went along shore in fall and picked up wood; in winter about six miles from ship. Natives burn oil exclusively. Found winter about as cold as at Herschel. Got free from ice about fourth to sixth of July. Blizzards not so sudden as at Herschel. Were northeast and southwest, the southwest blizzards were worst. Bows of wood and sinew.

Natives they dealt with most, call themselves Kogmollik; another taller, darker tribe called Nunkatiks. Neither tribe smoked nor chewed. Tea and hard bread they spit out: did not like molasses. Natives very

clean; never saw them look for lice, do not believe they had any. Put their bed clothes on a line to freeze every day.

*August 20.* The o'ola-ho'ola, which the natives hold every night, seems purely for amusement. There are usually from two to three drums and all the crowd sings, the dancers excepted. They do have them for seal killing, curing diseases of any kind, or for any good thing; also for evil.

When the oola-hoola is for a purpose, it is usual that no one speaks except when the performers stop, and then it is a cheer of thanks to the performers. The dances I have seen are something like a cake walk, they move in unison, each doing the same thing as the others. Some know the dance well enough never to watch the others, and some have to keep their eyes on some good performer to get their cue.

*September 1.* Shingle Point. I notice the Nunatama we had with us have all given up polling their hair, though the custom, they say, was no less universal among them than the Kogmollik. The Nunatama seem to have been entirely an inland people and they furnish one of the interesting problems of the region.

Labrets. All the older men have labret holes, and most of them wear at least one. Those who wear two seem seldom, if ever, to wear a pair even when they own pairs, but wear one labret of one kind, another of another. Most of them are of various stones, from gray to green which they say they find in the mountains themselves. Many wear labrets used by their grandfathers, so it seems that a man's labrets (or at least all of them) are not buried with him. I asked Kakatu about this, but could not make him understand fully, though he told me both they were buried and not buried; probably means that either the customs vary, or else they bury some of a man's labrets, and keep others.

Roxy tells me among the Kogmollik sometimes you bury labrets, sometimes son keeps them. When his own father died he had six labrets (three pairs). Roxy put one pair in the grave alongside of the body, and kept two pairs for himself. They have no scruples against selling these heirlooms, though they put a high price on them. Roxy says that so far as he knows these customs are the same for the Nunatama. The labrets are always taken out of the lips before burial, whether they are to be buried or not.

Burial Customs. Roxy says that nowadays if a man has two rifles, one good, one poor, they put the poor rifle in the grave and keep the good rifle. He thinks perhaps this was different a long time ago; then they put both rifles on the grave.

Huskies. Harrison's Huskies seem to be very kind and thoughtful in every way. When we left the tent, they would tie the door if we forgot to; they put special wrappings around my trunk because they saw papers in it.

When flour or tea is scarce, they will go without and give it to you. If they see you chopping wood they come and offer to do it. They are very cleanly. Many of the women are good-looking. Many of the men are about six feet tall; all are strong and active. They are crack shots, at least Iaki and Kokatu are, as I saw last night in target shooting with my rifle. They can make almost anything; last Saturday they made a centerboard for our boat out of poor boards, and did it beautifully. Most of them have a brace and set of bits. Some of their tastes are not cleanly to a white man's notion, though most of them have their parallels in civilization. They roast their fish, stuck vertically near the fire on sticks run through their mouths, without removing the insides, which you merely leave in the dish when eating. They allow dogs to lick the plates after meals and dip their fingers deep into the seal oil and suck them off with a smack. None of them seem lazy, though there is doubtless a difference, especially in some working faster than others, for all of them are always working, one may say. Even at this time of year, when their kerosene lanterns are lit at nine P. M. they work by lamplight, especially the women. Day times, if the weather is not bad, the men are out-doors all the time, and the women much of it. They spread blankets, skins, etc., to sit on and build a windbreak, lighting a fire if wood is plentiful, as it usually is on this coast. Even when the cooking is not done at this fire, but on a sheet iron or kerosene stove in some tent, the food is brought out to eat.

Fishing. In fishing they usually push out their nets with their fifty to seventy foot poles, though they occasionally tend nets in kayaks and small umiaks. The nets here were set indifferently outside and inside the sandspit, and with similar luck. The fish caught were a small whitefish mostly, with pickerel "bull heads," and two or three large cod-like fish (?).

Clothing. The Nunatama sleep naked. They are fond of blankets, especially four point blankets, though they use fur also. Over their artegis of skin they usually wear a cloth one to keep the hair from wearing off fast. The artegis should be made of summer deer, and the favorite trimming is wolverine, for which they pay as much as \$30.00 a skin at McPherson. A man who buys one cuts it into strips, uses all he needs, and sells or trades the rest, often getting a fair profit. Some whites say they consider wolverine their "medicine," but Roxy says they use it because they think it looks good. Wolf or dog is used for trimmings if wolverine cannot be gotten. Sometimes the artegi is worn fur in, and for such occasions it often has a few small strips of wolverine in a bunch between the shoulder blades, perhaps three or four strips half by three quarters inch, and perhaps on the shoulders or sleeves. Sometimes, perhaps under white influence, they make patch-

work garments of seal and deer trimmed with wolverine. They are made for whites usually and usually are buttoned, while theirs are not.

**Boots.** The summer waterproof boot is of seal, with a "shoepac" sole; the winter boot is of deer, the sole of the brow, the leg of the deer's legs. The hair of the sole is always in, the leg may be either way. A sack of thinner skin is worn inside of this, or perhaps occasionally duffle.

**Cooking.** The Itkillik seldom use baking powder in cooking, and do not know how to use it right when they do have it. The Husky is skillful with it. The bread is either dry-baked, baked with a little fat in one-eighth inch of batter covering the bottom of a frying pan, or boiled doughnut fashion. Fresh seal oil leaves no taste perceptible to me, and they take pains not to use rancid oil. Roxy says "big seal" is "all the same" to eat as small seal; the skin is a little thicker and is used for boot soles, while the other goes for uppers.

**Tattooing.** The tattooing of the Nunatama and Kogmollik differs little so far as I can see, both depend on taste of individual, within certain limits. It is done by drawing a thread under the skin, charcoal, or occasionally stove coal smoke or lampblack.

**Care of Children and the Aged.** I have never seen a child struck or punished by Huskies, and a dog seldom. Both are well behaved, especially the children who always jump to do what they are told. It is said old people are occasionally left behind to die on journeys, usually at their own request, but I have seen nothing like this. Iaki's old parents are with him. His mother is especially decrepit, and whines with a bad head continually, but he humors her in every way. If he sees her trying to do anything that is difficult for her, as getting out of the boat, he runs to her; he lifts her very tenderly ashore where everyone else jumps. Among Indians she might be helped by some other woman possibly, but not probably by her own son or any other man. The old people (we had two such couples) eat with their children, but have their own tupek, a very small one, to sleep in. How it will be in the winter I do not know.

Much of the men's time is taken in making and mending nets. At this the women help if they have no clothes, etc., to make. Children even close upon a year old, are much of the time carried about on their mother's back when at work.

Both with the Nunatama and with Roxy the men eat separately. Roxy's boy (about fourteen years old) eats with him and so does another boy about same age from Herschel Island whom Roxy brought down last time. The Nunatama children all ate with the women.

Our camp here consists of two tents set with doors opposite. In one is Roxy, his wife, Mamaline (Neviluk) fourteen years old, a woman Roxy

brought from Herschel and her (?) boy of fourteen and Roxy's boy. The other is Whiskers, his wife, and daughter of fifteen. She smokes, Neviluk does not — probably sign of being past puberty, so Walker says.

Roxy born at Kopuk, other side of Pullen Island some fifty-five miles. Alualuk, and another Husky, live there now. Speak a little English. They had implements of copper from Coppermine. Kopuk people once lived at Richard Island, then moved on account of bad weather to Kopuk. Thinks Kogmollik used to be as far as Icy (?) River, sixty miles west of Herschel Island. Nunatama came before whalers to Herschel, when Roxy was a small boy. (Nuna — land: taima — stop, stay).

Kogmollik used to fight Point Barrow people, but never with Nunatama, who came only eighteen years ago. Kogmollik got their name from Point Barrow people. First time Kogmollik and Nunatama met they could not talk, "all the same, Itkillik." Very soon "savey little, though." When Nunatama came, they killed animals with "mucky powder." They do it still occasionally, though Roxy has threatened to call the police. Nunatama could not speak with Itkillik. They had both umiaks and kayaks on inland rivers. Before they came to coast used to trade with Kogmollik and Point Barrow, especially the latter, for whale and seal oil for which he paid in skins, wolverine, etc. Roxy says he is so used to Nunatama language now he hardly knows what words are Nunatama, has to stop to think.

*September 4.* At 8:00 A. M. Whiskers awoke our tent by telling Roxy there were five boats passing, coming down from Herschel. At first we thought they would pass by, but they rounded the point and came in; five Nunatama boats, had left Herschel three days ago.

Tattooing. These five women, have one strip of tattoo half an inch wide on chin, some a little narrower. One is split slightly at the top, as if by a failure of having the tattoo lines of the band quite touch.

All the men are about thirty years old. Have labret holes, but do not wear them; one younger (twenty-five?) has them, one almost thirty has none. One of the men has his feet gone up to the knee. Is cheerful and active. Does all his own work, apparently. There are sixteen in the party, none old, for even the gray-haired woman seems not old.

Food. I suppose their meal with Roxy and his partner is typical of such welcomes to travelers. The men went into the partners' tent, the women and children into Roxy's. They then had some raw fish. They prefer it a little "high," Roxy says, so they had it out of the cache. Each man takes a fish, cuts off his fins, about two inches of the tail in front of the tail fin, and then eats with his knife, the fish having the consistency of a fresh one two-thirds cooked. A dish of seal blubber was also on; of this each man takes a piece, cutting off it a small piece for each mouthful of fish.

He puts the blubber in his mouth immediately after the fish and chews them together. In eating, when they come to the guts they are picked out and put back in the fish trough. Some, after chewing off the spine to which the ribs are attached, chew this up, spitting out the ribs, but apparently swallowing the masticated vertebrae. Dried fish was also eaten; after this came tea and doughnuts. Each cup is handed the guest in its own napkin. When through drinking he folds it after wiping the cup and saucer "clean" with it. They usually drink from the saucer to cool the tea. In folding, the saucer is placed on the center of the napkin, and the corners bent in so they just touch in the middle of the saucer bottom. The cup is placed right side up upon the corners of the napkin, and the sides of the napkin bent up and stuffed into the cup. The napkin which is big, and usually of some white stuff fills the cup and makes the whole a ball which may be rolled about without coming apart. This is a convenient thing in moving camps, or even in the crowded houses.

**Physical Characteristics.** The eyes of all these people are a dark brown. A few of them have a slight tendency to widening of the nostrils (Negro or Mongol fashion), but most of them not. The teeth seem good, though some, especially the women's, look yellow and are worn down in front by use. None of them have their heads polled.

**Kogmollik.** Roxy tells me the name Kogmollik was given them by the Point Barrow and Nunatama people. They always referred to themselves if not as "innuit," as "the people of Kopuk," or the people of "Kittegarue" (I did not get his pronunciation of this word clearly, but it is doubtless the one of Murdoch, p. 48). This village was east of Kopuk, but how far I do not know. Its people were "all the same as those of Kopuk." Down there they still use stone lamps, Roxy says.

**Tobacco and White Man's Food.** It was in his father's time, but before his own, that Kopuk people first saw tea, sugar and flour, though they had pipes and leaf tobacco, that it was leaf tobacco I infer for their mistaking tea leaves thrown away after meals at the fort for tobacco. Roxy says that when he was about twelve years old he and Oaiuk ("chief") who was a year older, stole some tea from William Smith (Indian) at McPherson, thinking it was smoking tobacco. They threw it away when they found it was not. This shows it was not very highly prized even then by the Kopukmiut. When his people first got them they did not like any white foods he knows of, not even sugar or molasses. The bacon was "all same seal," and did not tempt them for they had plenty of seal. Now they are very fond of sugar and tea, and like to have flour, coffee, molasses, etc. Tea is most highly valued by the Kogmollik, though the Nunatama seem to like coffee as well. They are all still indifferent to bacon when they have seal; the Indians are very fond of it.

**Houses.** There are said to be a great many houses on the Herschel Island sandspit, and they are scattered in three or four places between here and there. One house (apparently of Kogmollik type) was shown me as Nunatama. This morning I took a walk to the east end of the sandspit to see what evidences of permanent occupation I could find. I found only one house ruin, and that is about two hundred yards east from our camp, which is within five hundred yards of the west end of the spit.

**Graves.** I found three graves. In two I could see the skull; the third was well filled with gravel. I found perhaps a dozen fish caches, but these are often the remains of temporary camps. The graves are made as the caches are, and may differ only in the presence of bones and absence of fish scales, but there usually is more or less gravel in the graves. Some of the caches are more carefully made; I have not seen logs split to form sides of graves. The caches are often square, but the graves are oblong.

**Houses.** To the west of our camp there are evidences of at least ten houses. One of these is still "fit to live in," and one seems to have been abandoned in the course of construction. The one still standing was rebuilt by Roxy six years ago. He lived in it three winters, and for the last three it has been empty.

**Hair Dress and Physical Appearance.** Roxy's brother wears two tutaks half inch in diameter. He is older than Roxy, hair streaked with grey. On the crown it is a two months' growth; in front and to the ears it is trimmed on a level with the eyebrows, but hangs in long locks behind, to the level of the head while Roxy's is trimmed even (see p. 141, Murdoch.) all around. His name is Pokerk. Iguam., his son, has the hair trimmed exactly as his father. He has labret holes, but no labrets, is perhaps twenty years old and the handsomest Husky I have seen, a distinguished, slightly aquiline oval face, light Italian complexion (light olive), a rather slim, erect figure five feet eight inches and a soldier-like gait. His mother has a series of narrow tattoo marks, which amount to and may be intended for a solid band three-quarters of an inch wide. She wears no earrings, but has the holes.

**Rings.** These people have many silver rings on their hands — gilt ones I have never seen worn, though I have seen several stone rings, on woman's pipes. The ring is worn, if one only, on the third finger of the left hand. A woman in Anderson's boat has five rings all broad silver. Mrs. Whiskers has same tattoo as Mrs. Pokerk, except the lines composing it don't merge so evenly.

**Tea Drinking.** Roxy tells me he likes to drink six cups of tea "every time," and that means about five times a day. I have seen him drink six several times. The others seem to drink as much. A good deal of water is drunk, too.

Bows. Roxy says he never knew Kogmollik to have three-piece bows.

*September 8.* Names. Roxy says his foster daughter is named Nevilluk because "my mother die, this one come up." He says names of the dead are seldom given to a child born the next week, but usually one, two, or three

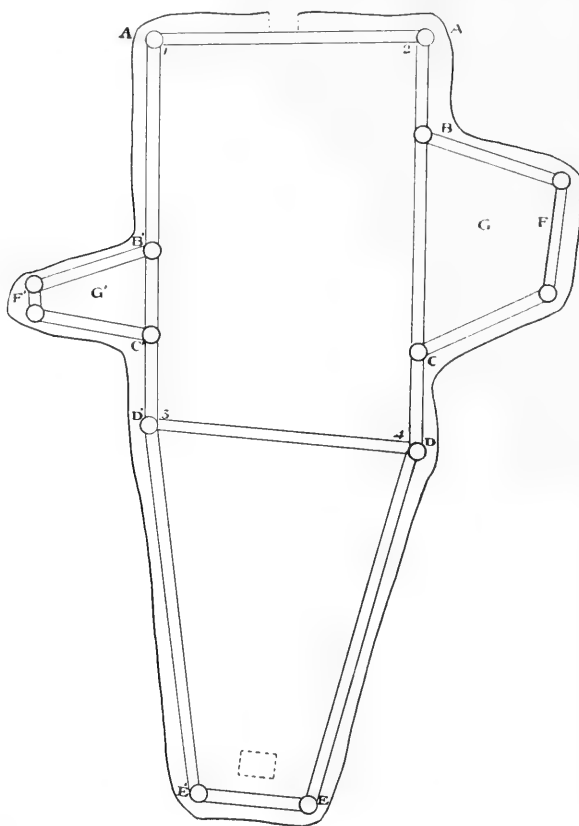

Fig. 87. Plan of a House. Measurements: A to B, 3'2"; A' to B', 6'10"; B to C, 7'; B' to C', 2'; C to D, 2'9"; C' to D', 3'; A' to A, 9'; D' to D, 8'10"; F to AD, 41" F' to A' D', 4'; posts 1, 2, to roof, 5'3"; posts 3, 4, 3'4" (roof one length, sloping logs); D E, to D' E', 10'; E to E', 3'5". The outside of the house is banked with earth. G' is a small storage alcove usually for housing a bitch with pups; it has a flat roof about 2 feet from the floor. G has a roof of the same level as the rest of the passage and sloping towards E. The door is toward the west.

years after death. When I asked him why he sometimes calls her "mamma" he said: "She got name all same my mamma (mother)."

*September 9.* Clothing. Stein says the H. look upon wolverine trimmings merely as we do sable, etc., but thinks the strips attached to the small of the back of the coat, etc., are "medicine."



Roxy and Anderson say these things "long time ago" were so you could tell when you saw a man far off, or saw his back, who he was. One would wear a loon feather between the shoulders always, another one would wear it on the left shoulder, another on the right shoulder, and then you could always tell his name. And suppose some stranger came and told you he saw a man five miles away who had a feather on his left shoulder, then everybody would know he had seen X—over there. Anderson says the son used to wear the same mark as his father.

**Length and Care of the Hair.** The women's hair seems to average shorter than with whites. Roxy and Anderson say that both Nunatama and

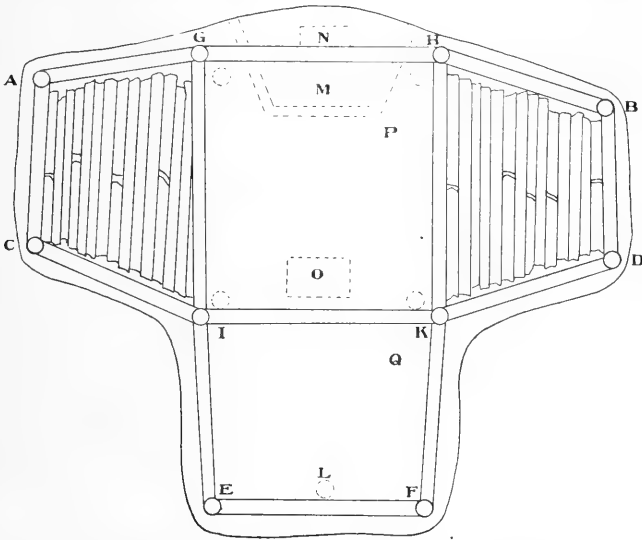

Fig. 88. Plan of a House at Shingle Point. Measurements: A to B, 23'6"; C to D, 24'; G to E, 18'10"; I to E, 8' (H to K and H to F about the same); G to H and I to K, 10'; A to C, 7"; B to D, 6'2"; E to F, 8'10" equals height of G and H, 4'; I and K, 5'10", E, 3'; F, 2'4". (A to F measurement from floor of respective platforms, others from main floor.)

Kotzebue used to pull out the beard when it came, but Kogmollik never did this. From people I have seen I am inclined to think the upper lip often escaped this process. I have heard of heavily bearded Nunatama, though this may be an effect of white contact. Oblutok, Roxy's partner, has a beard three inches long on the chin, and evenly distributed in the manner usual among whites.

Fig. 88 shows a groundplan of Roxy's house at Shingle Point. To the north there is no alcove, but a slight curve in the wall behind the door. The door is oval, made of two (not three, as shown) plank slabs two inches thick, hewn out of driftwood logs. It is one foot seven inches by one foot ten inches

in size and the slant of the planks makes one foot eleven inches to the floor of the passage below from the edge towards the center of the house and two feet six inches from the edge towards the wall, both measurements from the under edge of the two-inch planking.

Alcoves A-C and B-D are floored with split logs of irregular length, lacking from six inches to one foot on each side from reaching the walls. These are the sleeping places. The main door and south alcove are floored with logs split into boards. The south alcove floor is six inches lower than the others, and the main floor six inches lower still. The window, rectangular, one foot three inches by one foot eight inches, is above the dotted rectangle marked on the floor and is thus on the north slope of the roof which is of split boards, sod, and gravel. It has been covered with a plain sack tacked across.

The walls all lean in so that though they are a few inches from the posts at the base they come to them at the top, except at the posts (I and K). From K, the wall is two feet at bottom, one foot at top; from I it is fifteen inches at the bottom, eight inches at the top. The walls and roofs are of split logs with the flat side in. The posts have roots for a crotch in every case. The walls are built partly of sod, though mostly of loose earth. At various points at the base of the wall, posts are driven in and horizontal timbers placed inside these to support the walls. There are also all sorts of odds and ends of timber laid up against the wall vertically, so that the house, at a distance, looks like a pile of wood. The floor of the house seems to be about at ground level. The cache near by, south of house, is six by six feet high, built with root crotches, as all this type are.

In old times Roxy says they used to have five lamps in the house, four near posts G, H, I, K and one small at L (S.) between E and F. He says in this house people slept at both A-C and B-D ends and he himself slept at Q. In old times the favorite material for windows was the membrane from gulls' necks. The ventilating hole is above P, and is about three inches in diameter. The stove pipe, for this is a modern house, is near it. Roxy says houses are always faced toward the water, if water is near. If no water is near, the door always faces east he says.

*September 10.* Food. In eating raw fish today, only slightly high, I could barely smell it in the tent, Anderson (Kotzebue) had to go out and throw up what he had eaten, at which the other five (some Kogmollik, some Nunatama) who were eating in our tent laughed very much. When he came back he told me that his people never eat raw fish unless it is well rotted. The Kogmollik and Nunatama prefer it a little rotten, but are fond of it in all stages from fresh from the net to a cheesy consistency. His people bury fish in the ground to rot it. Here that would not do, it would freeze. He

says that although he has tried repeatedly these several years he has been in the country to eat raw fish with the Kogmollik and Nunatama, he always has to vomit what he had eaten. If he eats more after vomiting he has to vomit that also.

*September 11.* As to the statement by Murdoch that unmarried people sleep with their heads the opposite way from the others in the common bed; I believe that is only so that more can be accommodated in the small space allotted for sleeping. At any rate Roxy's boy slept with his head the other way until now that there are two less in the bed, when he sleeps as the rest. The girl used to sleep head towards the door with the rest all the time, and the other boy lodged at Oblutok's.

*Childbirth.* Yesterday a child was born in a Nunatama tent. Roxy tells me that women sometimes die at childbirth; that doctors are (among Kogmollik) often secured to be with the woman, sometimes they hold her head, sometimes her hand. The child, he says, is never touched until completely delivered. The Nunatama used to have the custom of confining the woman to her tent for a certain period after births; he says his people never did this, that she goes out as soon as she feels able. The Nunatama have discontinued this custom, he says.

*Houses.* He tells me the Nunatama build snowhouses outside their tents in winter. His people always have wood in their permanent houses.

*Houses on Banks Island.* Stein says that both N. and S. of Kellett, Banks Island, he saw traces of recent houses that must have been lived in at least one winter. The wood stakes had been pulled out indicating the scarcity of timber, and only the sod was left. This was in 1901. He saw three on the shore where they landed some miles S. of Kellett and two at a landing N. of Kellett. The ones S. seemed not over two years old, the ones N. a little older. They had been built circular at the bottom. Though they had caved in he thought they had been cones like an Indian wigwam. The wall had been of rather well cut sod. He saw more game there than he has seen anywhere; deer, bears, foxes, hares, and musk-oxen. This Anderson corroborates, for he has landed from the "Penelope." I have not had a chance to ask him about house ruins yet, but finding them tallies with Klinkenberg's story that the people of Prince Albert Land go to Banks Island occasionally.

*Names.* Anderson tells me that the Nunatama and Kogmollik give their children the names of people who have recently died, irrespective of sex. Supposing he died, and a girl was born soon after, she would be called "Anderson." If two or three people die she will get their names. He never heard of more than three, and does not know how many a person might have, supposing many people die.

Childbirth. He says "long time ago" Nunatama women used to go outside tent, perhaps make small tent, when childbirth approached. Now they do not, and as far as he knows his people never did.

Burial. When a man dies among his people or Nunatama, some people do not dare to stay in the tent with the dead man; some do, and these fix him for burial. They wrap him in skins or cloth or put him in a box, and then place on elevated platform. He says he helped put up the Nunatama platform-grave I saw on the sandspit in August that contained the body of a woman who died one hundred miles up the delta and whom A. brought down in his whaleboat. He says "some people are afraid" to use clothes, etc., that belong to the deceased, but he has worn such clothes, and many now do the same.

*September 17.* Village Sites. On the way, just east of Sabine Point, Roxy pointed out the village site where he lived some years ago as a boy. At this place he said there were twelve whaling boats always ready to put out, and he remembers the whale-killing. His father at one time was the first to spear one. Just beyond King Point was a village that supported six whaling canoes; beyond, at Stokes Point, was another, the size of which he did not know. Then came the one on the Herschel Island sandspit, and one at the harbor. It seems to have been the fashion to indicate the size of a village by telling how many whaling boats they had.

Breaking Bones. In breaking bones for marrow, i. e., the long bones, I have seen the Huskies always break them somewhat as we might break the shell of a hard-boiled egg with a knife. They generally use the back of the blade of their hunting knives (butcher knives), twirling the bone and tapping it on all sides from one point to the other until the bone is all cracked into small pieces, which, however, remain in place held, I suppose, by membranes. The bone is always, so far as I know, broken for the marrow without roasting, though I have seen shoulder blades roasted after most of the meat was cut off.

Fish. Various men whom I have asked tell me they prefer boiled fish to rotten raw fish. It seems chiefly a matter of convenience to eat it raw, though it may be that the preference for boiled is a taste acquired since the whites came.

*September 18.* Sickness. Last week arrivals from Herschel reported that most of the Huskies there suffered from coughs and colds. Yesterday Anderson suffered from toothache. I am told there was toothache before the whites came just as now.

Two of the young Kogmollik with the present party are without the polled haircut, one close cropped and the other cut on a level with his ear lobes. Oyanginna, who looks fifty has gray hairs and tends to baldness in

front. Roxy tells me that a good many Huskies "no savey" sing or dance, he is one of them and never does either.

He says colds and other sickness were less common before white men came. He attributes this to tea, flour, etc. Before they drank only water or "soup" of deer meat, seal, and occasionally fish.

*September 19.* I asked Roxy this morning concerning certain scars on his breast. He said they had been made when he was sick inside under the spot where the scars are. He said this was not done by a doctor, but by anybody. "I just said: 'Here, you come out this place' and somebody come out." His wife and others whom I have seen have similar scars. He is just now thinking of having his head cut to relieve a headache that goes with the cold he has had some time. He says "By and by blood come, headache all right."

*Physical Characteristics.* On seeing more of the Kogmollik I found that tall men are much rarer among them than the Nunatama, while their women are all rather small. Many of those who are here now, seem to have weak eyes, and one woman is blind in one eye. All the young men have labret holes, and only two are without the polled hair cut. One woman has a chin tattoo of three bands one third of an inch wide each, separated by two spaces one-eighth of an inch wide. The bands are a trifle wider on the chin than at the lip. The woman's dress shows conspicuously the V cut both before and behind.

*Clothing.* Roxy says formerly Kogmollik sometimes made men's pants as women's are still made, in one piece with the boots.

*Intermarriage.* Happy Jack, who is a Point Barrow man, is married to a Kogmollik woman, the one noted above as being blind in one eye.

*September 20.* *Skins used for Clothing.* Roxy says that before Fort McPherson was established musk-ox skins were always thrown away and foxskins only occasionally used then for clothes for children under ten years of age. The musk-ox robes were too heavy to carry. When he first remembers his people gave as many as forty foxskins for a small knife. Their tents were then usually made of mooseskins, although that animal is almost never killed now by people living at Kopuk.

*Deer Hunting.* When he was a small boy deer were usually killed in the following way: They were found in a position where they could be cornered against a lake or river, the men went out and cautiously made a semicircle about them. If there were too few men to completely invest the deer, scarecrows were employed alternately with the men. When all was ready the men began to howl like wolves. Sometimes the deer dashed into the water at once. Sometimes they ran toward the men, but were turned back by them and the scarecrows and finally took to the water. Then they were

dispatched by spearmen in kayaks. He remembers as many as two hundred deer killed in one day. Sometimes the people considered enough had been killed and let the rest escape.

Umialik. Roxy explains "Umialik" as man who has an umiak, and says that at Kopuk, and among Kogmollik generally a man who owns a umiak is so called. Iliuluk is a name applied to a man who has neither umiak nor kayak, and who has no parents, even if he has children living.

Earrings. Roxy says earrings, such as his wife wears now, long pendants of dentalia about one and a half inches long (two lengths, plus beads), were always made by his people, and who found dentalia on Husky Lake, also occasionally bought them from Nunatama.

Clothing. Roxy says that he long ago gave up the use of skin underwear, prefers woolen or cotton.

*September 22.* Herschel Island. Walker tells me that when a whitefish was killed here this fall pieces of the skin were given to "everybody," i. e., to each native or family on the beach. The same is true when an ugrug is killed, but not of a small seal. For water bootsoles whitefish skin is best, and ugrug comes next.

Exchange of Wives. After dinner I secured measurements 21-22 and 23. Kabheahek ("22") is Roxy's half brother by an exchange of wives, Roxy's father and another man's wife. This is seldom more than one night at a time, and seldom except upon the two families meeting after a protracted separation. After another separation this may be repeated. This practice seems to be seldom indulged in except by close friends, partners, sort of blood brothers. Roxy says the Nunatama custom is the same. He says that even when a man has two wives (this applies to Kogmollik, he does not seem to know Nunatama custom), and a traveling friend who has none arrives, they never lend him one of the wives.

I think that most of the natives (excluding kept women, and also those on the Narwhal, of whom I know nothing) who are now staying at Herschel Island (perhaps fifteen grown men all told) are Kogmollik. There is no one whom I know to be anything else than Kogmollik. They seem to be depending largely on the seals they catch in nets.

*September 25.* Ula-hula. Sunday night I saw an ula-hula in one of the Mesinka houses. Several dancers followed one another. There was scant room for three (one woman and two men) to dance, and that was the largest number. Much of the time there was no one, while two danced only occasionally, one man being the rule. There seemed to be two or three slightly different ways to beat the drums, but different dances were also danced to the same tune. Each dance was only from two to four minutes long; but when a dancer once was up, he usually danced from one-fourth to one-half

hour. One old man, a doctor (Kogmollik — in fact I heard the affair called a “Kogmollik ula-hula” and all those dancers whom I knew were Kogmollik, though several whom I knew as Numatama looked on) danced until he was so exhausted that his motions, which had been exceedingly lively, became those of a man half dead. The other dancers moved their heads, bodies and arms in a manner to make one who did not see their feet think they were jiggling. Usually, however, the motion was at the knees, and one or both feet were kept nearly still. Sometimes the dancer faces gradually around in a crescent, using one foot as a pivot.

The old man rushed about, shook all parts of his body apparently to the dislocation point, and roared and shouted hoarsely. Occasionally, he dashed into the crowd and seized a certain young man by the head, shaking him. The spectators laughed and the young man took it coolly. I was told afterwards that the old man was making the young one a doctor, for fun. This meant, so far as I could understand, that the present generation was having performed for its amusement a ceremony that had been serious formerly. No one appeared to be very serious.

Two young men who took care of Roxy's tent during his stay at the dance, passed the time by singing Church of England hymns. One of these was Eskimo, composed by the missionaries I was told.

Ball Game. A game of hand ball Sunday afternoon was played as follows: The crowd was divided into two parties, usually this is the men vs. the women, but this crowd was promiscuous, a few men helping the women's side. The ball is thrown to any member of one's own side and by him to anyone he chooses. The game is to intercept the ball and to get it into play on one's own side. I was told there were no prohibitions, you could even take the ball out of an opponent's hand by force. This I never saw done, but pushing, etc., was frequent. This game, I was told by Roxy, was played at Kopuk before whites came.

Juggling. Many seem expert jugglers, especially the women. They will keep three stones in the air with one hand, or keep one ball in the air a long time with the toe of one foot, kicking it several times in the air.

Blanket-tossing a woman, and jumping spring board are favorite amusements. The blanket-tossing I have not seen; formerly a big seal hide with handles was used. The woman tossed kept on her feet if she could, and was thrown twelve to fifteen feet in the air, it is said. Broken bones and dislocated joints were often the result. I have seen women who have been pointed out as having broken arms, clavicles, etc.

Chiefs. Capt. Leavitt assures me that Oaiuk's father was as real a chief at Kopuk as there ever was at Point Hope or Port Clarence. He himself has paid this chief toll and could not get deer hunters except through him. If

personally offended, he would compel all the Kogmollik of his village to boycott certain ships and sell meat to certain others, even when the boycotted ships offered a higher price. Displeasing other natives had no such consequences.

*September 27.* Shingle Point. Villages. Half way from Herschel Island to Stokes Point there is one Kogmollik family wintering and one at Stokes Point. Thence to King there is no one. Formerly, Roxy says, there used to be a number of villages, one at the Harbor, Herschel Island, one at the southwest sandspit (the one at the Harbor depending on seals), one village near Stokes Point and Herschel, one on Roy Point, one between Roy and King, one just west of Sabine and one at Shingle Point, as now, then one two or three miles farther east.

Roxy says six years ago fifteen Kogmollik died at Herschel Island of pneumonia, and in one week seventeen at Kopuk. Ever since he remembers Kogmollik have been dying fast.

*September 28.* Last night Obluktok, and some of the rest of our folks, had an ula-hula in the next tent until after 12:00 at night.

Roxy tells me that when he was a boy they had various jumping tricks, one to kick a stick over their head with both feet, landing on them again, another was to tie a thong around the neck and just above the knee of one foot and drawing the knee close to the chin and kicking with the free foot.

He showed me tonight various scars on his legs where he had been cut when swollen there, and water came out. He says if the cuts had not been made the swelling would have turned "all the same bone," as they did in the case of a man he cited.

Roxy says at Kopuk they had a special whale house. This house was used for no other purpose.

*October 2.* Roxy tells me that when he was a boy about twelve years of age fights with weapons were frequent between Kitigaru and Kopuk, Kitigaru being only about six miles east from Kopuk. He says that men of one village often picked up things which men of another claimed belonged to them, and fights resulted. In these spears, clubs, snow knives, or anything else, were used and men were often killed. But about the time Roxy was eighteen or twenty years old, these inter-village fights came to an end, apparently simply because people began to see they were silly.

Houses. When he was a boy he says there were seven houses in Kitigaru of the type of his own house at Shingle Point only they were larger, most of them. These housed, on an average, six families, he says. There were also small huts of skins on a frame like a smoke house, "perhaps two, perhaps four," in which certain unattached persons lived (orphans, though mostly old people). He does not remember how many houses there were at



Kopuk at the time, though there were more houses there than at Kitigaru. Kopuk, besides, was a trading center for the people to the east as far as Liverpool Bay, and beyond and to the west as far as Herschel. The fights do not seem to have prevented this intercourse. They were more in the nature of quarrels or brawls, and seem to have occurred especially at the meetings.

*Skin Dressing.* In scraping skins the women use both iron and stone scrapers, the stone scrapers seem to be preferred with rough skins at the first scraping, or rather, in beginning the scraping. On small skins, as muskrat, I have seen only iron ones used. Mrs. Roxy uses water in which fish have been boiled to wash the skin side of deerskin after scraping; she rubs it on with a swab of deerskin with long hair on it. Tuluga's wife rubs the inside of rat skins with a paste of flour and water; Stein says that at Point Hope they take a little white, chalk-like stone, burn, and powder it, using it to rub on skins. Though she is a Kogmollik she may have learned this from her husband's people, who are Nunatama.

*Houses.* Roxy says that he built his house five years ago, on the site of another house, which in turn he thinks was on the site of an older one. The passageway of the new house is five feet high where lowest; this gets lower year by year, and finally it is necessary to rebuild. At that time all the old timbers are thrown away and new ones substituted. The hole and passageway are deepened and then the house built as before. This makes the number of house ruins in a place a better index than otherwise of its former population.

*Lamps.* The lampwick used by Oblutok is composed of moss. By the side of the lamp is always lying a little round stick which is left in the oil and lighted whenever they need to look into dark corners. This torch is also used for lighting pipes, etc.

*October 4.* *Lamps.* Roxy has told me two things of considerable interest — First, that "170" years ago, when his father's father was a small boy he could barely remember seeing the last of a woman's labret which had been in fashion before that time. These were single labrets, of stone usually he thinks, worn in a hole in the middle of the lower lip. They made the lip stick out "like a shelf," as he indicated with his hand.

The second was, that a greyish stone was "all the same gold" among his people formerly. This was soft and stood fire perfectly, and was used for labrets, lamps, etc. It came from Prince Albert Land. He showed me a pair of labrets of the material, and it seems to me the same as Klinkenberg's lamps.

*Pottery.* Of pottery Roxy never saw any, but his wife had seen some fragments brought from the west, and he had been told by western natives of its manufacture and use.

*October 5.* Whaling Customs. Roxy tells that when a man of his village killed a whale (as boat-steerer) he wore a crowskin with beaks and claws across his back for some time after. It was also usual to tattoo him with two lines running from the corners of the mouth to the angle of the lower jaw below and in front of the ears. His father killed a whale about in October and wore a crowskin until about April. When the houses had all been fixed and all preparations made for winter, he sent word out that there would be eating and ula-hula at his house for he intended tattooing because of the whale he had killed. The house was filled with guests, and during the celebration the two lines were tattooed.

Tattooing. Formerly the women and men of Kopuk used to tattoo a line diagonally down from the nose. He remembers seeing one old man and two old women, all very old, who had this tattoo. Roxy says tattoo line from nose never curved as shown by Boas, but always down towards angles of jaw.

In an umiak the man who steers the boat is "umialik" while the boat-steerer is "niuyákti." The crew range from three to six besides this, and often consisted in part of women.

Feathers as Means of Identification. Roxy had previously explained that the wearing of feathers, etc., was for purposes of identification. He says that the same sort of feather, or other insignia, was also tied to snow knives, or any other article of value that was likely to be left lying around — to show at a glance whose it was.

Chiefs. Roxy corroborates, in a measure, Capt. Leavitt's statements as to chiefs at Kopuk. He says his own father (Itaar'ktjiak) and grandfather were chiefs there. When his father died, Oaiuk's uncle, Kax'alik, became chief and remained so until six years (?) ago, when he and seven other members of his household of eleven died of the black measles, among others his two wives and his eldest son. A young son lived who was too young to be made chief; besides, he did not want the post. Three years ago "Mr. Frith made Oaiak chief," apparently by giving him tea, etc. Some time later a trader at Red River made another Kopuk chief in a similar manner, by making him his trading representative, or Katatjě.

"Long ago" the chief had much power. No one could sell deer meat without the chief's permission. This agrees perfectly with Leavitt, and Roxy explicitly says that Kaxalik had this power, though the chief has no such power now.

Drums. In Kogmollik dancing, the Mūmīrktuak, a stick six inches long, called 'Kat' tuk, is used to beat the drum, which is half rotated with a tambourine motion and a blow is struck on each edge alternately. In stretching the drum, it is "tuned" by tapping with the finger tips around

the edges. If the sound at any place does not satisfy, the skin is readjusted at that point. The material is usually deerskin.

**Balls.** The balls used in play by Kogmollik were kicked with the foot and were some three to five inches in diameter. The outside was often of white fish skin and the stuffing was fine wood shavings or whalebone.

**Fire Bags.** The real fire bag of the Eskimo, containing now matches and a pocket knife, etc., besides tobacco, but formerly the flint, steel, and tinder, is called *ignên*. The Nunatama call it *igaktaun*. *Telemayun* or *tlamayun*, is a bag for tobacco only.

**Dancing.** If I understand Roxy right, dancing was sometimes in the nature of contests between villages. Persons danced as representatives of certain villages, and sometimes men not belonging to a certain village might be chosen to dance for it; say, if all the crowd were Kopuk, certain men might be told "you be Kittegarmiut." Whether these were contests of strength, endurance, or what, I do not know.

*October 8.* Roxy says that so far as he knows, nose rubbing was never a general form of salutation, but was indulged in practically solely by old people who saw their children after a long separation — perhaps after believing them dead.

"Medicines." I described to Roxy Hanbury's louse remedy for sore eyes, as he saw it. Roxy says that he has been told that the Nunatama run a hair across the eye in some cases, and also that they sometimes make a hair fast to a louse to "make him scratch" the eye. His people, he says, use a sharp, bent nail and make a little wound inside the eyelid with it. When the eye clouds, I understood him to say, they occasionally scratched the eyeball.

For snow blindness the Nunatama, he says, cut the tip of the nose, and prod sticks up their nostrils; the Xogm. cut on a level with the eye and an inch or inch and a half back of the outer corner of the eye, and also on the top of the head above each eye just in front of the tonsure or even across the front border of the tonsure. Cutting, Roxy says, is their only "medicine," and is not done by the doctor, but by anyone at all, often by the patient himself. They cut for everything. I believe I have already noted that Timmïuni, whose eyes are now well, was cured by cuts on the top of his head, and that Tsïtsak was cured of earache by a vertical cut an inch and a half long and about an eighth inch deep, an inch in front of the ear, the middle of the cut being on a level with the opening of the ear. The small of Roxy's back is practically covered with scars, and he has them all over, even on his fingers. They emphasize that it is not so much blood, as water, that comes out, and this water must be gotten rid of in some way.

Sometimes the doctor is called. He works in the patient's house, and

his treatment consists in songs and dances. While he is at work no one must leave the house, though the doctor himself often goes out, goes around the house, and comes in again. The dance ordinarily lasts from about 7:00 P. M. to 1:00 A. M. Occasionally it may be longer. Sometimes, too, there are recesses of a few minutes, when people may leave the room. The fee is proportioned according to the severity of the disease, and ranges from three to five foxskins, to a finished umiak made for the doctor of from five to seven whitefish skins. If a man is poor, people join in and give the doctor anything they feel like, one a knife, another a foxskin, etc., regarding these contributions as much as a matter of course, as giving a destitute man food. If the doctor makes a cure, or if he fails to cure but the patient lives, he keeps his fee; but if the patient dies soon after treatment, the doctor comes back with whatever he has received and refunds it. Among the Nunatama, Roxy says, the doctor got no pay until the benefits from his treatment were evident.

Kadjigi. In the time of Roxy's great-grandfather (paternal) his people lived in two villages about one mile apart, Kopuk and Kingnirit; but the filling in by the sea of the places where they used to kill whitefish induced them to move some six or seven miles, where they founded Kittegarau and Tsannirak; these last places being about one mile apart. In Tsannirak there were two kadjigis and in Kittegarau three. But these have all fallen in ruins and been burnt, and there are now no kadjigis on the coast. These buildings, Roxy says, were so high in the center that a tall man could just reach the roof with a four foot stick, while around the sides an ordinary man would just touch the sides with his head when standing on the bench seat which ran all around the house. These houses were about fifty or sixty feet long, and as wide. When dancing was on they sometimes danced a whole day without eating; when they ate they had to go to their own houses for the food. In the spring the kadjigi was used as a workshop for repairing umiaks, etc. The kadjigi had the same sort of an entrance as an iglu, was lighted and heated comfortably with lamps and had windows of whitefish skin.

Reckoning of Time. The three or four weeks ending about New Year were almost continual dancing, Roxy says. The month was called the "dancing time." There appear to have been eleven months in the year, counted from each new moon. Probably there were ten "moons" and the moonless summertime taken as the remaining one. Roxy puts it that they "left August out."

October 9. Kittegaruyuit and Tsannirak. Roxy drew for me a map indicating the position of the old towns Kopuk and Kingnirit and the newer ones, Kittegaruyuit and Tsannirak. The people at Kingnirit moved to

Kittegaryuit and those of the Kópuk to Tsannirak. This was in Roxy's great-grandfather's time. The Kópuk men, both while at Kópuk and later at Tsannirak, hunted up the Anderson River, while the Kittegaru people hunted towards Richard Island. The result of hunting up the Anderson was frequent fights between the Kópuk men and Itkillik, who were thus traditional foes.

The last "fight" with Itkillik came when Roxy was a small boy. He does not remember it. His mother and her brother and cousin were in an Itkillik house of which they had taken uninvited possession. The Itkillik, who were eight in number, tried to drive them out and a fight ensued. Roxy's mother killed two with a knife; four others were killed, and two escaped,— a boy of twelve and an old man. The fight occurred on the Peel. The Itkillik used to come down as far as Tunurak.

I noticed today that young Roxy wears a young hawk's wing feather suspended by the "near" end by a string around his neck inside his shirt. I asked him "why" and he said he did not know, someone gave it to him long ago and he always wore it. Roxy explained to me that this was a remnant of the "marks" he had explained to me before. Young Roxy produced two white weasel skins fastened together at both ends. These were to be worn as a wreath, only more on the back of the head than the classic. There was a string to tie these under the throat. Young Roxy said he would not sell them for any money. Roxy said he had a wolverine head skin split so as to fit as a fillet on his head, but that he disposed of it many years ago, for he got to see they were no use. Whatever may have been the understood meaning of these things once, young Roxy seems to prize his as a gift.

*October 10.* Songs. Roxy tells that the "Kogmollik singing," a more continuous and softer song, accompanied evenly on the drum, which is half rotated in the hand and struck on alternate edges, came from the east lately, reaching Kittegaru only some ten years ago, and Shingle Point later.

Dancing. In the "Kogmollik dance" which is, now at all events, not always to the Kogmollik song, only one man and one woman take part at one time, being followed by another pair when they are tired; in the Tuyor-miut form, the most common at Herschel, any number of either sex take part. In the Kittegaru *kadjigi* there was usually one big drum (say, three to four feet across) and this sufficed, but the Tuyor-miut often had as many as nine drums. When a visitor came from another district it was usual to dance as long as he pleased before eating. Roxy has heard that "long ago" there were fighting games, but his information on the point has been vague.

At Herschel if a sled came from the east it was always said: "Kogallit are coming!"

Fishing. At Kittegaryu they did not use nets for whitefish but speared

them from kayaks. Roxy thinks there were as many as one hundred kayaks. A good hunter, if he was lucky, sometimes speared ten in a day.

*October 11.* Roxy's wife saves the feathers of the birds eaten, and uses them as swabs whenever it is thought necessary to wipe a pot, or some mess off the floor. Feathers are occasionally used to wipe the hands after meals.

*Succession of Chiefs.* Roxy says when a chief died his eldest son became chief; if he had no son, his brother became chief; if no brother, some relative in whom the people had confidence. If the son was mentally or otherwise unfit, the people would decide that fact and then the succession took effect. If there was no brother, popular opinion decides which of the relatives should become chief.

*Building Umiaks.* Umiaks were usually built in the summer out-of-doors. But if one had to be built say in April, a special snowhouse was put up to shelter the builder.

*Kadjigis.* As before stated Tsannirak had two kadjigis and Kittingaryuit three. The doors were not like those of iglus, as previously stated, but were something after the white man's style. There was a whitefish skin employed to close the door when necessary. When a dance was to be held, no fire was lighted that day, and the house cleaned just before the dance, usually this began between 4:00 and 7:00 P. M.

*October 12.* Kogmollik on Coast. This year there are three Kogmollik families between Shingle Point and Herschel Island: one Kay Point Bay, and at Stokes Point, one half way thence to Herschel Island.

*Commerce at Kittingaryu.* For copper, lamp stone, tutak stone, etc., the Kogmollik paid in skins and blubber, paying as much as five whitefish skins for a copper skin scraper. The place seems to have been a trading center, as was Kupuk.

*October 13.* Waterproofs. They had a waterproof garment made after the manner of a union suit, with hood and boots attached. It had a slit of a few inches down from the neck in front for putting on, and was made large, to go over artegi, water boots, and everything. The garment is called *annō'tjik*.

*Dressing Skins.* In scraping garments or finishing skins they rub with lumps of chalk. Formerly, they used a stone called *maxatlik* found at a place called *Kitikkat*, not far from Kupuk.

*Trade with Point Barrow.* The first man of whom Roxy knows that came from Point Barrow was one who arrived in a umiak at Herschel a few years before Roxy was born. He stayed there until after the freeze-up, when some Shingle Point people took him home with them. Later he was taken to Kupuk by a resident of that place, and finally he got as far as Baillie Island, where he married and turned back with his wife, who was a

cousin of Kunalik's grandmother. After this Point Barrow people frequently came as far as Baillie, bringing tobacco and labrets which they exchanged for copper and stone for *kōdliks*.

*October 14.* Tents. The tents of the Kogmollik were made conical on a frame of ten or more sticks tied together at the top in the manner of the cooking tripod. They were preferably of moose, though seal and deer were also used. It was the Nunatama who introduced the dome-shaped tents.

Kogmollik-Nunatama Disagreement. Four (?) years ago the Kogmollik delivered the Nunatama a sort of ultimatum to the effect that if they did not stop using poison for animals they would have to leave the country. This, the Nunatama seem to have taken to heart.

*October 25.* Camp. Yesterday we picked up another deer, leaving, however, some of the meat for me to take going back. At 6:00 P. M. we arrived at the camp. It consists of two oval brush and moss houses, the larger about twelve by twenty-five feet and eight feet at the top of the vaulted roof. There are three women and four children in the camp. The men left in charge had killed 11 deer while our companions were absent.

Shedding Teeth. A little girl who had just pulled out one of her milk teeth, wrapped it in a piece of meat and gave it to a dog. This, I was told, the Nunatama always do.

Candles. The Nunatama have always used candles, one I saw being about two inches in diameter.

Traps. Yesterday, we stopped to make a wolverine trap. The beast has to reach in through a door for the greased end of a long stick, on the outer end of which a short stick is pivoted to support the roof.

*October 26.* At supper tonight we had a mess made by stirring together a quart each of melted deer and finely minced meat. This we stirred with the hand in a ten quart pail, and in half an hour the pail was full of a puffy creamy stuff. It tasted fairly good, but is too rich for a white man's taste. The stuff is called "akūttok" by the Nunatama.

*November 1.* Home Life, Kogmollik. Tonight Roxy's wife was unusually sick, head, back, etc. The manner in which he sat by her, held her hand and forehead and rubbed her back, was exactly in the manner to be expected of a "civilized" man who had great affection for his invalid wife.

*November 2.* Infanticide. Stein tells me of two cases of infanticide last winter, a Point Barrow man and Nunatama wife; one Kogmollik woman who left her white husband. He has known of many other cases, usually girl babies.

*November 8.* Boots. The Nunatama wear their winter boots on alternate days on a different foot. The Kogmollik wear same boot on same foot all the time, as we do.

Dancing. Among the Kogmollik when any dance is through, the dancer may touch anyone present, man or woman, whose time it then becomes to dance at least one dance, a sort of "tag".

Shortening Hair on Deerskins. When for any purpose the hair on the deerskins is too long, it is cut off, not with scissors, though every family has a pair, but with the ulu. There seems nothing the ulu cannot be used for, ripping seams, cutting skins, and sometimes cloth in shape for garments, cutting bread, slicing meat to be fried, etc.

*December 9.* Kang'anic. Made fair progress Wednesday. Camped at 1:30 on the big river "that comes straight down from Red River". Thursday night we camped at Tunurnak, the first Kogmollik site on the way east. Had hoped to find people here. Friday noon we got to Simigúak where Roxy expected to find Oaiok, but found no one. The dogs were played out and the fish all gone, so we cached everything but our bedding, tent, stove and twenty pounds of flour, all the food we had. T. and I pulled the sled along fairly fast now, and we got to Iglöryuit at 3:00. This was also deserted, though at both these places people had lived last year. Saturday 1:30 we got opposite Kittegaryuit, but passed two miles off shore. Roxy said no one had lived there for eighteen years and there would be none. Soon we came upon sled tracks going from Kittegaryuit to the east. These, Roxy said, were white freighters from Kittegaryuit, for there often is a summer camp at Kittegaryuit to catch white whales. We soon came to two cached whale boats, one of them Jimmy's, and at 2:00 got to Kang'anic, where we found a house with twelve people and all kinds of food, so much they will have to throw half of it away next summer: fresh fish hooked, dry fish, white whale meat, and plenty of oil for four kodliks. This is the first real Kogmollik family life I have seen. Were told here there is one family at Kittegaryuit.

Boy's First Game. T. showed me a place near Kittegaryuit where he shot his first duck. His parents invited all the neighbors for a feast with plenty of tea in honor of the event.

Snowshoes. Typical Kogmollik snowshoes are of two pieces of driftwood sewed together with thong or whalebone at heel and toe; toe sharp and turned up. Numatama are of two okpeks, spliced at the toe, rounded toes and turned up rather less than R. Have seen them made of one okpek around the toe.

House at Kangianik. Similar to Roxy's at Shingle Point. Four kodliks, one at each main post, kept burning all night, supplied with oil from a bunch of blubber suspended by a stick above and behind the flame. Wick is a pile of wood scrapings like sawdust. Kodliks are all of iron. House heated by stove also. Window of a white whale stomach. Ventilator always open. Rather warm inside, but no bad smell. Diet: fish and tea.



**Feuds.** An old man here, whose father killed three men and wounded three more in one night with a knife. A man near here somewhere who killed two men with a rifle two or three years ago, one of these Roxy's cousin. Police have not been told.

**Hand Wipers.** Both sexes employ considerable time in making shavings like fine excelsior with fistfuls of which one wipes his hands and mouth after eating.

**Rate of Growth.** Tjitjak is said to be seventeen years old and to be full-grown. Roxy says boys are full grown at sixteen and seventeen.

*December 10.* **Surgery.** Saw an incipient boil on a girl's back slit with knife today. A bunch of excelsior was put on as an absorbent.

**Water Holes.** The one here has a windbreak of snow about three feet thick. There is an ice pick with a point of iron and a sort of spoon of wood with a blade about four by six inches, handle about seven feet. The water here has a faint trace of salt, but will be fresh later. Is fresh all summer.

**Sleds.** The ones here are stronger and wider than at Herschel, approach the old Kogmollik type, and are about three feet wide and four to six feet long. These were shod formerly (as now) with whalebone, deer horn, etc. Ice was put on; moss chopped fine and mixed with new snow, then some water added and the mush put on with the gloved hand. Ice spots were avoided. The ice on runners was smoothed by pounding with a piece of wood.

**Cook House.** An alcove in left side of passage as you enter, chimney of snow blocks, roof about five feet high and chimney two feet more. Brands scattered when the pot is taken down.

**Old Age.** The oldest man here, Taiakpanna, is said by Roxy to have been as old as Roxy is now when Roxy was a small boy, about thirty years ago. He does not look a bit decrepit. He has a beard.

**Cleanliness.** Today they scrubbed the floor carefully with warm water and rags. Floor is partly of hewn, partly of round logs or poles. The little girl washes to excess, and most, if not all, wash their faces in the morning. The women comb their hair daily. There is no bad smell in the house. Have seen no signs of lice.

**Nursing Children.** The three-year old girl here today is not weaned yet.

*December 12.* **Snares.** Isib'yuok, a strip of whalebone fifteen inches long, half an inch wide, and one tenth of an inch thick is folded back on itself in about two inch lengths, tied with a thong and covered with ice and oil. This the wolf or other animal swallows.

*December 15.* **Tattooing.** Anarakljiak has a single horizontal tattoo line on each arm, about over the upper neck of the humerus.

**Wolf Tail Belts.** Oyanguim and one of the boys wear belts of wolfskin

fastened in front and having a wolf tail fastened at the middle of the belt and thus hanging down to back.

**Stone Lamps.** Oaiak has one stone lamp which he says is "akkia auganimi" with front edge slightly curved about two feet long. Bridge has three openings, one at each end and one midway.

**Kadjigi.** Oyangina says the Kogmollik the other side of Baillie make a snow kadjigi every winter.

**Xagmallit.** The people here make it plain they do not consider themselves Xagmallit. Those are the people to the east.

**Fishing.** Formerly, no one of Kopukmiut hooked fish while sun was down. As it is, only Oaiak is doing it.

*December 16.* Kangianik. Left Tuktuyoktok for Kangianik with a company of Huskies to meet there Oaioka's boy from Singyok.

*December 17.* Care of Children. Notice here, as with the Nunatama in Stein's house, that tukurak (raven) is used to scare children when naughty.

**Childbirth.** Notice no peculiar practice in regard to the newborn boy. Mother in some pain yesterday, everybody grieves over the child, as among kablunas. Mother eats only boiled fish as, I believe, the sick do usually.

*December 19.* Tuktuyoktok. Dance. Last night saw the best dance yet. Agnalluak, who has incipient consumption, danced first a long time with her back most of the time to the audience, and with no violent movements. She occasionally said something, i. e., how her cough started, (audience, "too bad"!), that she hoped it would stop soon ("amen"), etc. Then Oaiyuak began dancing alone sometimes playing one of the drums, sometimes merely with his gloves in his hands, or nothing. He was stripped to the waist. His movements gradually became very violent and then he called for his weasel laurel, which he alternately wore on his head or held in his hand, shaking it. Then he threw it away and called for a wolf belt, which he threw on the floor and then danced around it. He now began making excited and earnest statements (or questions) to which the audience replied. Occasionally, he jumped down into the doorway, dancing there sometimes with his back to the audience, sometimes his breast, continually exclaiming and asking questions. Both here and on the floor, he made complicated passes with both hands. He seemed near dropping from exhaustion at one time. At this point he went out of sight into the passage. I did not see just the movement when he popped up into the doorway again, but believe he came into it backwards. At least someone held up a drum in front of my face at the moment; when I saw him he was dancing there again with his back to us. When he turned, there was blood running out of his mouth at the labret holes. This trickled to his breast, but soon stopped flowing. After this he mostly walked (sort of cake-walk, stooped forward)

in a circle, beating one of the drums. At the shouting points of the dance, the drums beat violently and most of the people sang the accompaniment. At the speaking parts there was silence, except for the responses. These remarks came in bunches, between which (perhaps about a minute) the drums beat softly, stopping just before O. began to speak again. Near the end of the dance he ceremonially drank a cup of water, holding it high with his right hand, and striking a dramatic upward and forward attitude, while with his left hand he held the hand of a decrepit old woman (Ekoptěrea). During the performance everyone was very serious. O.'s part of the dance lasted about forty-five minutes. Dancers seem to want to have something in their hands — usually gloves, either grasped or put half-way on.

Games. Last night we played with match-like sticks about four inches long. We had nine, but lost one later, which seemed to make no difference. The bunch is held on the flat palm, tossed up and caught on the flat back hand, then tossed again and caught in the fist, the trick being to catch one stick or any odd number. The odd stick is kept; the throws are invariably alternate between the players. The one who has the most sticks when all are gone, wins.

Tricks. One boy showed me twenty-two tricks with a string, called tuktu, kimmek, amaox, etc. He said there were others. The H. say these are "all the same as writing."

Lamps. After burning a long time, several days, a good deal of residue matter from the oil forms on the bottom of the lamp, and is removed when the lamp is almost full of it.

Polygamy. O.'s two wives seem to get along well. The older is evidently boss, though she seldom uses her authority. Certain things, as piptje and tea she has in her charge and deals out to the other one. She seems as fond of the children as the mother is.

Physical Characters. The men have nipples better developed than I remember seeing them on whites. There is uniformly a spot of about one inch diameter, slightly conical, of a dark brown color, and looks about as the palm of one's hand does under a low magnifier. The nipple itself is about one sixth of an inch in diameter, cylindrical, and about one fifth of an inch high, about like an empty 22 cal. "BB." cartridge inverted. The accumulation of flesh, too, beneath the skin simulates a woman's breast to a considerable degree.

Songs. O. continually sings about various exploits, his and others', at which everybody laughs.

*December 21.* Tonight a Kotzebue Sound, Kalē'lik, who lives some fifteen miles inland, came walking in in pursuit of one of his dogs which arrived this morning.

**Pulling Teeth.** Pulling milk teeth is practised. This evening a girl had one pulled that had become loose. A loop of sinew was used.

*December 23.* **Childbirth, Nunatama.** The mother immediately after birth presses the baby's head firmly before and behind with her hands, but once only. Anderson says he believes the Kogmollik do not do this, while his people, Kotzebue, do as the Nunatama do.

*December 25.* **Windows.** Two ice windows facing S. and about fourteen by fourteen inches each admit light enough, so lamps were dispensed with at 10:30 A. M. The ice is about four inches thick. It tends to frost on the inside in the manner of glass. There is a skin window in the roof, but this gives less light.

**Houses.** This house is of the moss turf like the Nunatama house, but has a framework of spruce logs instead of okpak, two uprights, a ridge pole between and four long logs, two running from each end of the ridge pole in opposite ways and the ground eighteen feet on one side, twenty on the other, where these are about three feet from the ground, the ridge pole is seven feet, they have cross logs between which the ridge is laid. On the longer side there is a cross log three feet from the ridge, making a rectangle in the roof three by ten feet. In the center of this is the window of skin. The walls all slope in and are of upright spruce sticks. The ends of the lean-to logs stick out about five feet through the corners of the house till they reach the ground. The floor is of brush, the beds not elevated as in Kogmollik house but similarly placed.

**Whitefish Catching, Nunatama.** A. says the Nunatama used to come down to the sea at Kotzebue and elsewhere, and catch white whales, seal, etc. They were always fond of Oktjuk and bought some from A.'s people frequently.

**Blood Mixture.** The habit of the Nunatama of coming to the sea every year at various places for trade or fishing made intermarriages with various coast people frequent, so much that careful inquiry almost always shows impurity of blood; Kuwax and Katotox, for instance, had a Kotzebue father.

**Fireplace.** A square of logs three by three feet in the center of the house and filled with earth, forms a fireplace used when fish is cooked in a huge pot of eight gallons. The skin window then serves as a smoke-hole.

**Ice Sieve.** For completely clearing a net hole of ice before pulling out net, a spade four inches wide shaped like a tennis bat, is used here.

**Coronation Gulf, Cape Parry People.** About four sleeps east from Parry, A. saw ruins and one old Kogmollik house some years ago. No other signs of people.

*December 28.* **Nunatama.** This country has no trees (merely okpek), no rabbits, few fish in summer and none in winter, but plenty deer, formerly. Now there are no deer.

Rabbitskin Blankets. K.'s wife has made two for the children to sleep with; woven "all the same net," K. says. She learned how since coming here, though the Kogmollik do not practise this. I can't find out from where she learned. The skin is slit in quarter inch strips, twisted so as to bring the hair out, and then looped; for which a wooden needle (4 in.) is used.

*January 1, 1907.* Kangillirk. Fishing. Nets set under the ice here are first placed by cutting a series of holes eight inches in diameter about six feet apart, and two holes two feet in diameter at the net ends. The net line is passed from hole to hole under the ice by means of a bent stick, a tupek willow.

Temperature. Mr. H.'s observations give the following results for three months past. Those before Nov. 16 were taken at Long Lake, the rest here:

	<i>Max.</i>	<i>Min.</i>	<i>Mean.</i>
October:	33°	1°	24.076°
November:	15°	-41°	-7.464°
December:	12°	-51°	-18.860°

The thermometer is said to be accurate above 0°, but gives too low readings if colder (i. e. -42° probably -40° on a standard thermometer). Yesterday afternoon we had -5° and at 7 P. M. today -46°. It does not feel cold at all today, one would guess it ca -10°.

*January 28.* Burial Customs. A. says he has laid out several dead persons in the sweater he still wears while most people throw away the clothes they have worn on such occasions. He also told me that when a man lives alone in a house and dies, he is usually left there. Somewhere near Tuktuyoktok O. has told him, there is a house with two bodies.

Sickness. O.'s baby, the one adopted of Tirtkirk, has been sick for some time. One evening he "spoke," to cure the child, a series of exclamations, declarations, and questions responded to by the company every now and then. There was neither dance nor song. The day before yesterday he built a snowhouse; I was told so that the baby's rest would not be disturbed by the noises of O.'s house.

*February 1.* Incantations. O. indulged in a long one after bedtime last night, sitting at the head of his bed. He demands good winds and little, small cold, good going, plenty of various goods at Herschel and cheap, the generosity of his son-in-law, Sander's mate of the Narwhal, and good health and good luck for us all four and the dogs.

Shifting Population. Avantok and family, who were at Kittegaryuit, lived a while at Kang. and are now at Imnaluk. Alualuk's wife is his sister and Navalluk's at Shingle Point. One of the younger couples counted here before now is at Imnaluk. Jimmy's mother who was here (Kangianik)

in December, left with Anderson for Kiglavait this morning. A. himself was the first part of the year in a house he built near Kunnox's (near Husky Lake). There are many people on the coast now starved out of Kuraluk. Mongilaluk the half-breed son of Oblutok's wife, his wife another half-blood, neither speaks English, is at Imnaluk and Jimmy has gone to Richard Island hoping for both fish and deer. Okilliak moved from his and Kunnox's house to Anoktok's some distant S. E. Then he and Anderson's brother Oyuliak to Kaxotok's, thence Okilliak back to his house and Oyuliak to Tuktuyoktok, intending to go later to Imnalak, and so the story might be long continued. This shows the uselessness of trying to get the census by localities or houses.

*February 2.* Kangianik. Edge of Tools. All knives and tools, except axes, have edges, scissor fashion.

*February 3.* Tonsure. Kaxilik, three and a half years old, O.'s son, has just had his first tonsure and the full adult haircut.

Cleanliness. Today, as also this morning, we left Tuktuyoktok. O.'s younger wife washed her face in fresh urine.

Language. Mangilanna spoke with Capt. Amundsen's (King William Sound?) "Kogmollik" last winter and thought some words strange in form, but had no difficulty in conversing with him.

*February 4.* O. gives me the following places inhabited when he was a boy, most had two or three wood houses, and some snowhouses: Tsaunrak 3, Kittegaryuit 8, Kang., Naparotalik, Niakoatjak, Imnalugyuak, Kenerktjak, Tuktuyoktok, Tapkark, Mangomiĭk, Anagniarne, Nunasuame, Tapakalugyuame, Sjëöakane, Imnalungme, Kangirgme, Itibyaak, Itibyaak Tsaniane, Itibyaak Tsaniane (two of same name), Mumîrkpavik, Tjigilialuk, Nuwurak, (as big as Kittegaryuit formerly) (O.'s wife from there), Ublat-saun, Niungatjak, Kiglavait, Kigirkatme, Nuwuk, Tjaiuaryune, Okivig, (very many houses), Kopukine (many houses), Igloryuit, Sinigyhak. In the interior (Husky Lakes district) Kuraluk, etc., very many. All these places were inhabited every winter.

*February 5.* O. says that he, Jimmy, Anderson, Avanlik, Ivitkwa, think of going beyond Parry for hunt and trade next summer. May want passage on ship.

Washing. O. used today a method I have seen among Russian immigrants, sipping and spitting into his hands.

*February 7.* Tunuruak. Deer. We saw two sets of deer tracks old, of several, and this morning's of three deer, going to Richard Island. O. says there will be a few deer after a month, besides those that are here now. Formerly deer were so plenty that, in his own house, fish were little eaten, but the last three years comparatively no deer and they have lived on fish.

Last year he came E. from Shingle Point about March 1 and got ten deer the rest of the spring besides fish and small game.

Waterfowl are innumerable here in the spring and on some of the islands to the S. and N. they nest in thousands. White whales and fish abound in summer.

*February 11.* Near Shingle Point. Tents. O. contradicts R.'s statement that Kittingaryuit tents were formerly of moose. Said it was used merely on the floor next to the snow.

*February 13.* W. wind and trace of snow. Therm. at  $-46^{\circ}$ , wind 2, much better day than yesterday.

Our trip, as a whole, was very cold, though the wind was never very high. Our camps were comfortable. Our snowhouses were large, about eight by ten feet oval and six feet at vault, and consequently froze a little, just enough to make the frozen fish right for eating. Most days we cooked fish for our meal, eating raw fish for the first course even there. This usually mornings.

The effects of cold on our dogs were quite as pronounced as upon ourselves which the H. understand. O. said yesterday they were tired more from cold than hard work. The sled was lighter, of course, yesterday than ever before, and the wind blew the rime away so it should have dragged easier than on past calmer days which were fully as cold, but the wind seemed to chill the strength out of them so they could not be urged beyond a very slow pace. On other days the mere approach to a place that looked like a campsite made them strain and tug, but yesterday the sight of houses, men, dogs, which usually makes them rush ahead wildly, had but slight effect, and they had to be whipped for the first time to keep them from stopping, quite, even on a level, when a blast of wind came.

*February 15.* King Point. Beliefs. Kataksinok, Stein's wife, was greatly disturbed by my handing Annie, her two year old child, K.'s cup to drink from. Stein says she does not mind who drinks from her cup, except now, while she is pregnant, the child is due soon. O.'s wife shows the same prejudice, but whether she is pregnant I do not know. Her last child was born at McPherson about July 20.

*February 18.* Herschel Island. Childbirth. Childbirth seems frequently to come as a surprise to natives. Oaiyuak's daughter had child today, was planning to go E. with father next Thursday, but will now stay until April. Sgt. F. says that unless a birth is expected in a few hours the woman's abdomen is continuously kneaded by other women. As today labor is seldom severe, the doctor said last spring half-whites were often born with difficulty.

*February 20.* Childbirths are said by Capt. L. to frequently cause

rupture among Husky women. This often due to the kneading of the abdomen.

"Modesty" in the exposure of the sex organs is said by Capt. L. to be far greater among the men than the women. In examining them for rupture, for instance, the women make no attempt to cover the sexual organs, but the men almost always do.

Childbirth. Child delivery is said by Capt. L. to be more difficult with half-whites.

*February 23.* Stokes Point. Consumption was the cause of death of a middle-aged woman who died in this house this winter.

*February 24.* Vessels of wood (cf. Koogniks) have the groove for the bottom formed by pressure with the round point of an ivory, horn, or bone instrument, usually the end of the handle of a crooked knife. The edge of the bottom to be inserted is beveled with the side of the knife handle. The sewing of the side of the vessel is from below upwards along both seams. The bottom, when pressed in, is large enough to make a convex form.

*February 28.* Shingle Point. Dog Feed. Whale meat from an eight to ten year old whale on the N.W. shore of Herschel Island was our dog feed on the trip. The meat was moss-grown and looked a good deal like hard hay, but seemed to do well for the dogs.

Pregnancy Customs. Mr. Stein gives the following with reference to his wife, who is expected to have a child in a few days. She is a Nunatama. A pregnant woman should not use the "chamber" in the house, though his wife occasionally does. She has not done any sewing for the last few days, and won't until the child is born. At Point Hope he says, pregnant women could not work at whaling, because they must not urinate on the ice, and the whaling is done some miles from shore.

Menstruation Customs. S. says at Point Hope menstruating women were under the same restriction in regard to ice-work as pregnant women.

Whale Hunt Prohibitions and Customs. At Point Hope lead could not be safely cast into bullets within the "village limits" while the whale season was on. Skins must not be worked in the house of the husbands of the women working them if they are engaged in whaling, probably this restriction applies rather to the houses of the whalers than to their wives. Skins are worked in the house of some one not an active whaler, or else in a tent, etc., or in a white man's house. The owner of the house seems the one likely to suffer injury.

In launching a canoe for the first time each season there is some slight ceremony of which I could get no clear account from S. It seems to consist of passes and incantations by the men as they sit in the newly launched craft.



After a death in his family, a canoe belonging to its head, or, probably, to any member, must not be launched for whaling till the first whale has been caught by a member of the village. The same prohibition probably applies to engaging in whaling by men not owners of canoes.

At the Point Hope village the spirits of the graveyard were fenced off from the whaling grounds by a fence of stones, or pebbles, set on edge, ceremonially by old women "doctors." The fence was not a complete enclosure of the graveyard, but merely one side, a curve or bow-shaped fence.

Childbirth. Stein's wife (Kataksi'nax) had her child at 9:15 P. M. tonight. We had the first intimations of its coming at about 8. At 8:30 she asked that I leave the house till the birth was over, and that Roxy's wife come. About 9, Roxy's wife came home with the report that the child would not come before morning, so I went home and was in the house when the child suddenly came. She did everything for herself and the child, but came near fainting about half an hour after the birth. By 11:00 she was sitting up and chatting and laughing as if not indisposed. Apparently there was no superstition behind her request that I stay away — merely a reluctance to have a comparative stranger present.

*March 2.* Childbirth Customs. Kataksinax says she must not eat frozen fish now. How many days that will last I don't know. She must not eat fish heads, a great delicacy. Her cup must not be washed. She wipes it with a cloth and wraps it up Eskimo fashion. She treats her other eating appliances similarly, except the plate on which food is brought her, equivalent to the old "iliniak." The child's first excrement must be burned or else the child will suffer from a hardening of the rectum. The burning was neglected with her first child, Annie, now twenty-two months old, and she has suffered; so the present youngster must be protected, and S. had to burn it today, made a fire in the woodshed. Could not burn it yesterday, so it was kept carefully wrapped in paper till today.

Inconnus, Mr. Stein says, are caught on Kotzebue Sound — Selanik, etc., and are larger than here, some say seventy-five pounds.

Winter Habitat. When ships are at Herschel Island many of the Kogmollik now beyond Kittgaryuit are usually at the Island, living largely on their women.

*March 4.* Migrations. Stein tells the following: Nyūvikannak, the father of Tūlūgak's wife, was born of a tribe who lived on Langley Bay. When twelve to fourteen years old he came to Kittgaryuit. When a grown man he married and went to Langley Bay again and found no one. Beyond Cape Parry he later found a stone lamp belonging to his father and farther east campsites and remains which indicated to him that the whole tribe had

moved east. Nothing has been heard of them since and I suppose they went either to the Coppermine or Prince Albert Land. He was therefore, the only survivor of the tribe. He died at Cape Parry about 1903-4 and seemed to be about forty then.

Houses in Langley Bay. There are ruins of two villages close together in Langley Bay, two close together, five and seven houses — frames of whale-bone, did not see any wood in the house-frames, house not much smaller than any ordinary Kogmollik. Pretty well caved in, all of them.

*March 6.* Childbirth: Kataksinax, whose boy was born the evening of Feb. 28 was up yesterday, she seemed to be worried by staying in bed so long, but was ordered to by Stein. She never seemed sick, but for the semi-faint a half hour after the birth, from loss of blood and exertion in washing the child.

Marriage Relations. It seems to be customary that the man who marries the youngest or only daughter, must attach himself to the parent's family. If he is later unwilling to go where they go, the girl nevertheless goes with her parents (cf. case of Titjak and Pannigok, she is to go with parents to Kittgaryuit and he does not want to go, so has already gone up river to Pokerk's).

*March 7.* Starvation. Ovayuak brings the report that a Nunatama arrived from the mountains a few days ago with tales of hunger. Omigluk has plenty deer on the Herschel Island River and the next camp E. from him has gotten fifteen deer since New Year. But farther E. there were no deer and most of the dogs are dead and the people are said to be en route for Herschel so enfeebled that it is feared some will not get there. Kurugak, Ningaktjirk, Apökerk and Tulugak, with their crowd, are said to be about the hungriest. They were farther E., had proceeded some dist. S. W. from where we visited them last fall, and then had to fall back.

*March 9.* Migrations. With O. this morning Oblutok, wife and daughter with a sled and Naipaktunak and wife with toboggan started for the Kittgaryuit country, while Roxy's family and Kunalik and Kimmiwa (two sleds) went to the river twelve miles E. where Kannirk and wife are "grousing."

*March 22.* Starving Natives. It seems Ovayuak's account of the starving Nunatama was grossly overdrawn, at least; the sum known here is that they had enough for themselves, but scant dog feed at the end of the dark days. Papërök, who brought the story, is the only one who has come in, and him we met going out after deer at Stokes Point.

Religion. Capt. Leavitt, who has seen many natives approach death fully realizing it, says he has seen no one afraid so far. They take it better than whites, on the average.

*March 28.* Wolverine Beliefs. Stein says Nunatama who has trapped or otherwise killed a wolverine is not allowed to eat any cooked or warm food for a certain number of days after. He found this out on inviting a number to Christmas dinner and Niyak sent word he could not come and eat for that reason. The skull of a wolverine must not be disposed of (sold, etc.). The head is buried. Kunnax, etc., still hold to this.

*April 17.* Flaxman Island. Arrived at 4:30 P. M. Monday after traveling steadily from 9 A. M. after leaving the native Uikshak, wife Tullik, adopted baby and Nagorak one year old — parents of baby as well as adopted parents, from near Cape Prince of Wales. This native, together with another family, are "permanent" inhabitants of Flaxman Island who have moved out for deer hunting. As yet he had killed only three deer. In the winter they lived chiefly on seal, of which they have abundance, the other family even having an ice house. These two families have been supplied with provisions by the ship to hunt deer for it. Uikshak has already brought his three saddles to the ship. He made me a present of a seal which I picked up at his house on the east end of the Island on my way to the ship.

The trip from Herschel Island had to it little of special interest. Between the sea and the lagoons the sand divide is strewn continuously with wood, so there are few half-mile stretches on which one does not find good firewood. Here and there are remains of villages which York calls Kogmollik, both permanent houses and summer camps. They lived, he said, chiefly on seal, but also on deer and fish. I had no time to investigate them, leaving that for the return journey.

*April 18.* Native Census. Dr. Howe knows of the following natives.

1. Uikshak and Tullik, adopted baby Nagorak, 1 year, from near Cape Prince of Wales, permanent house on Flaxman.

2. Sagauichak (Jaruis) (Taklemanak), Kayotak (boy ca. 10-12), Shumigan, boy ca. 7. (Father, Pt. Barrow, Mother; Point Hope, children their own. Permanent house Flaxman).

3. Karnaurak (Iakok—2 names), Kapkannak, their children: Okelli-sök, boy 15-16; Capok, ca. 10. Iglanisok, ca. 4 (said by his father to be crazy — Dr. is uncertain.) Temp. house last winter at Flaxman.

4. U'shuruk, Shukranna (or Sirkinnirk) (husb. Nuna.; wife, Pt. Barrow). Nanigra, ca. 12-23, their daughter. Temp. house Flaxman, last winter.

5. Ned Arey, Ikaya, Cape Smith (?), Gallagher — Ned's son by former Cape Smith (?) wife, ca. 16. Yakak, ca. 16, son of Ikaya by former native husband. House at mouth of Okpelia river. Children of Ned and wife: May ca. 6, Joe ca. 3-4.

Also 4-5 families up the Kugaruk at a waterfall where fish is caught in open water all year.

Cancer is said not to be found among the Eskimo.

*April 20.* Syphilis. Dr. Howe says he has seen no trace of the disease.

*April 21.* The coast population from Herschel Island to Camden Bay, some five years ago (Mr. Arey says) consisted chiefly of Nunatama and probably none were Kogmollik. But going east last summer on his boat he examined some houses and thinks that towards the eastern end of the sandspit some of the older houses are Kogmollik.

An ice house is used by one of the natives on Flaxman Island, "Sagavichak", for storing seal. They are partly excavated (some two feet) and a vault roof built over the hole. Near the center of the roof is a trapdoor and part of the contents can be fished out by a man sticking his head and shoulders through the hole, while things near the wall can be reached only by going into the house. This native has two ice houses and some seven to ten seals at present. Last fall he is said to have had as many as two hundred at one time.

Sealing, is done chiefly at two seasons — spring and fall. The spring season is probably equally as productive as the fall season, but is more or less interfered with by the weather; sometimes spring sealing is completely neglected. In the last, prevalent N. E. winds are said to have "closed up everything so tight" that seal have not been caught for long periods and the natives have been "hungry". In ordinary years seal are caught more or less all winter.

Diseases. Dr. Howe has seen no case of gonorrhoea or syphilis. About twelve sick people examined. Boils observed, but no more frequently than, say, in Boston. Four cases of osteomyelitis, chronic; one in humerus, two in tibia. One case of tuberculosis of spine. One case has touch of pulmonary tuberculosis (woman "Toolik"). Chronic cough prevalent; much of it is not of a tubercular nature. At St. Lawrence Island many complained of impaired sight, but there were no means of testing eyes. Complaint of being sick, when really not sick, about as often as whites. Seem to flinch from pain as much as whites of a corresponding class. Most of those who complain of being sick are women, one man only, a particularly lazy and worthless chap.

*April 23.* Aboriginal Trading. The summer 1901 was the last time (Mr. Arey says) the Itkillik (from near Rampart House, probably) came to Collinson Point to trade. That year they found only one family, a Nunatama.

It seems that about, or over, twenty-five years ago the old trading residence of Barter Island was given up and Collinson Point took its place. Cape Smythe natives met there both Itkillik and Kogmollik, though it seems

probable that the waning interest of the Kogmollik in this trading center due to Hudson Bay Co.'s influence, may have been one cause of its moving farther west. Gradually, the Nunatama became a factor in the Collinson Point trade. What brought the westerners so far east was probably the wolverine skins of the Itkillik, for the deerskins they could get farther west. Cape Smythe natives now come as far as Flaxman Island only rarely; what they now get is chiefly old skins, in exchange for ammunition, etc.

*June 10.* Point Barrow Eskimo. Saxawanna has heard that long ago there were many people living on Flaxman Island who spoke not as Kogmollik but as the Point Barrow people. This was long before his day.

Archaeological Remains — Flaxman Island. There are no clear evidences of the old houses above suggested, on the island, but several places where decaying wood in high places may show on excavation that they mark house locations.

Burial Customs. Point Barrow People. Saxawanna says the head of the body in the grave is always to the eastward among his people, and probably therefore similarly placed in the graves along this part of the coast.

Burial Customs. Nunatama. S. says the Nunatama are so afraid of the dead that they ordinarily make no grave, nor any arrangement of the body after death.

*June 14.* Dances. The evening of the 12th, the Captain, Dr. Max Thuesen, and I attended a dance at the village in a tent made by stretching a sail forward as an awning from a tilted umiak. There were three drums and four dancers at the most. As the crowd was a miscellaneous one there were many dances in which one or two only could appear, as the others did not know them. The music varies occasionally, no one ever seemed unable to play the proper accompaniments, the drum passing from hand to hand as the men took turns dancing.

Disease. A young man was sick at the village the night before the 13th and word was sent he was dying. Dr. found him suffering from wind colic and promptly cured him. He was told he had been shivering violently. Dr. has seen several cases of these "shivers" and believes them affectation.

*June 16.* Weapons, Pt. Barrow. S. told me today that the favorite knife for fighting with formerly, was one made from the humerus of a polar bear.

*June 23.* Summer Migrations. All the natives but Kanaurak's family are on the mainland after game and eggs. Must have gone some distance westward.

*July 4.* Physical Characters. Dr. Howe has noted on patients he has examined that there is some hair, though far less than in whites, under the arm-pits of both men and women. It is currently stated by whalers that

both male and female genitals are devoid of hair. It is more likely that the hair growth is slight and inconspicuous, rather than absent.

*July 9.* Archaeology. Today I took a walk around the west end of the Island to see if any remains were revealed by the caving in of the bank. I saw none. At the old (ten year old) houses on the bank I found two wooden lamps, a small tub, a fragment of a larger one, a bone implement (club?), and a broken wooden ladle.

*July 11.* Disease. Kanaurak has been complaining for a week or more of various pains, head, back, etc. Today we were down at the village and learned he was going to die. In the afternoon the Dr. and I went down to interview him.

Yesterday the devil (a turnnrak) had appeared inside of him and told him he would die. He therefore broke his drum and tore his dancing cap, for he would need them no more. The dogs had eaten the drum skin and part of the cap. I was able to recover only a few fragments of the cap (the bird beak) and a few splinters from the drum, including a three-inch piece of the kattuk. We found the man sleeping outside and that he did not look at all sick. He was cheerful, but apparently perfectly convinced he would die, as was his wife and all the rest of the village. The fellow's character (with us) is shady, but breaking up these two articles for which we would have paid him in grub (and he is "hungry" now) is an indication that while the disease is hysterical it is not wholly shammed.

Apparently the devil in him was the Christian devil, for there was a book there illustrating both the temptation on the mountain and the devil-swine episode. Iakak told me it was the same devil.

*July 15.* Physical Appearance. Putulirayuk's most noticeable peculiarity was curly hair. This, he said, was rare in his country. Saxawanna says it is also rare at Point Barrow. The nose was also of peculiar type. The Dr. says Uikhrak's hair also curls when it gets long. P. was the only one in camp who had labret holes, and these looked as if stones had not been worn for years.

*July 20.* Jones Island. Native graves are not remarkably frequent, so far as we have seen the coast. A quarter mile E. from this point are three graves, two coffins, calico covered, standing side-by-side, and a log grave just west of them. Some old calico clothes were scattered around, but we saw no other articles. Another coffin, not calico covered, is about half a mile W. from the point.

Native camps, recent, are frequent along the coast. We have picked up a number of articles, mostly wooden, at these.

A women's camp is said by Saxawanna to have been here — Beechey Pt. in the early days of trade with the Kogmollik at Barter Island and

neighborhood. The fishing, he says, is good here, and the Point Barrow people seldom dared take their women and children farther.

*July 21.* Pt. Barrow Dance House. This tent was built, so near as I can find out, a year or two after Jarvi's coming to Pt. Barrow, say, 1899 or 1900. It was built by Nunatama, and Pt. Barrow natives were invited to dance. Saxawanna was present. Some trading was done at the same time, this was main object of Nunatama. The roof-supporting posts were about seven or eight feet high. The tent was partly of skins, partly of calico. All along the wall was a close palisade of uprights, slender or split, about five feet high. The stumps of many of these still remain,— the wood has since been chopped for camp-fires. The floor was covered with umiak skins for the dancers, while deerskin was scattered over the rest of the floor, and some of the people sat down. The drummers sat in a single row the row not reaching quite to the sides of the house. Everyone sang. The dance continued two days, and few, if any slept. Plenty eating. Nunatama and Point Barrow danced alternately. The following winter many of the Nunatama who took part in the dance died of hunger inland. No hunger then at Point Barrow.

Bird Iron. Formerly, before they knew of guns, the Point Barrow people used to kill ducks, etc., with shot in their breasts. These they called "bird iron" and used as "medicine" against pains in the chest, just how they used them I cannot quite understand, did not take them internally.

*July 22.* Traveling Camps. On different days, either tracking, or walking the shore while boats sailed, I have seen recent camps in great number. Often averaging more than one to the mile for long stretches. Picked up paddles, net floats, etc.

Jones Islands. Archaeology. In a walk E. along the entire N. side of the island and W. to its middle on the S. side I discovered two village sites and some other house ruins along the N. side, and two graves on the E. side of the more eastern narrows. One village is located at the western narrows and the other some distance west of the E. narrows. There are probably thirteen house ruins in the W. village; the E. one, which seems older, I have not counted up carefully, and probably shall not be able to estimate how many houses there were, as so many of the heaps are of doubtful character. It seems likely the sea has eaten away some of the houses, and some are now at the edge of the bank. Near one house was a dilapidated human skull, completely on the surface.

Pingok History. Saxawanna has heard there was a considerable number of people living here. They were not Nunatama nor Kogmollik, but nearly related to the people of Point Barrow and known as the same people as those along the shore towards Flaxman. They were whalers, killing also

bears, seals, and deer. I found a skeleton of a deer, almost whole and mostly in position, indicating that the deer had died here and only a few of its bones disturbed — dogs, wolves, or people. How long ago these people lived here, he does not know, but when he went E. along the coast as a boy, they were long ago gone. He thinks they were gone in his father's time, and is sure his father never saw them.

Medicine. S. says that the Point Barrow people were very much afraid of little black stones, about the size of a bean. These, if one lay with head on gravel, would get into the ear and eat their way into the head, devouring the contents of the skull. When the top of the skull was eaten empty to the level of the ears, or sometimes sooner, the man died. S. once had a stone in his ear. Oil (seal or whale, he has forgotten which) was poured into the ear and the stone finally came out.

Certain little black sticks, or worms that looked like sticks, I can't find out which, were also greatly feared. He showed me a stick much like the dangerous ones. This was a piece of a twig, a trifle more slender than a slate pencil, and an inch and a quarter long. He says that if these get into the stomach of a man or deer they work their way out, making a whole through the stomach, muscle, skin, and all.

*July 24.* Beliefs. When S. and I came up to Pu.'s camp a separate fire was made away from the others, some three or four yards and we were asked to sit in the smoke of it, which we did. This was because Pu.'s older wife gets sick if anyone who has been handling dead persons stays around her without being purified. S. says that formerly at Point Barrow also those who had been handling dead used to sit for a few moments afterwards in the smoke of a small fire made for the purpose. The fire above was really no fire, but a few brands picked from the main fire, and merely smoking, not burning.

Mortuary Customs. S. says that at Point Barrow no great fear was ever caused by the dead. People would eat afterwards the food part of which had been consumed by the dying just before his death, they would wear his good clothes and throw away his bad ones. The sled on which the body went to burial was, however, formerly broken at the grave. Some other things were also buried, but not of great value, such as labrets, iron articles, etc.

*July 25.* Some Nunatama up the Colville, or at least of the crowd that went there to trade are said to have starved to death this winter and others to have been close to it.

Medicine. One of the Point Barrow has a sore eye and the other rubbed together a flint-like stone and one of a whetstone texture with some water and rubbed the resulting salve on the sore eyelid.



*July 30.* Herschel Island. Archaeology. I spent the day prospecting the S. E. coast of the island, saw several graves. In one found broken Kogmollik sled, broken stone lamp, iron pipe bowl and a bone object — perhaps part of an eyeshade. Also picked up skull near tent on surface.

*July 31.* Archaeology. Today made a map of the point, showing approximate distribution of houses and location of some graves. The graves do not seem old, and have been considerably disturbed, by dogs and whites, probably. On top of hill are some graves considerably older. Fish caches, or seal caches are scattered all over the point.

Present Distribution of the Loucheux. At present many individuals born on the Peel River are found living in the Yukon Basin, along the Bell and Porcupine Rivers. The reason for this migration seems to be chiefly that food animals, such as moose and caribou are more abundant on the Yukon side of the divide, although the valuable fur animals seem more numerous on the Mackenzie side. A partial reason may be that some of the Indians were employed in the Yukon gold rush to help miners cross the mountains over the La Pierre House portage. Their association with these white men, and the opening up of the markets and trading posts in the Yukon Basin have been contributory reasons for leaving their former home.

These people had been brought up to trade at Fort McPherson with the Hudson Bay Company, and some of them make long trips yearly to Fort McPherson, partly to see their friends and relatives, and partly to buy such things as copper kettles and fur-bound blankets, of which the Company carries a stock which the Indians believe superior to the corresponding articles bought from the American traders of the Alaska side.

Eskimo Boats. The hunting boat of the Eskimo men was, and is, the sealskin kayak; for moving their family and transporting freight they formerly used large open boats, also of sealskin, known as umiaks. Sometimes, and preferably, these were made of the skin of the big grown seal, or of the white seal (beluga). These skins are capable of carrying from five to seven tons of freight, and are reasonably seaworthy, as well as light and convenient to take ashore on the harborless coast when necessary. The great disadvantage with them is, that it is unsafe to keep them wet more than three or four days at a time, and frequent halts have to be made to take them ashore and dry them thoroughly to prevent the skin from rotting. In the rainy season when a boat cannot be dried it will rot and become unseaworthy in the course of two or three weeks, while otherwise a boat may last two seasons. In winter the skins are taken off the umiaks, rolled up in a bundle, and stored on the fish platforms beyond the reach of dogs or wolves. As a matter of fact few of these boats are now in use in the neighborhood of Herschel Island. The American Whaling Fleet from San Fran-

cisco has been in these waters now since 1889. Many a whaling captain in exchange for labor, fresh venison or furs, has found it convenient to trade off his spare whale boats. At present, therefore, many families own these boats, but those who have none frequently move about as passengers on board the boats of others. The Eskimo are becoming expert and daring sailors, managing their boats competently in weather which would look doubtful to many a whaleman.

**Eskimo Villages.** Eskimo houses were at various times in the past built at practically every point of the coast between Herschel Island and the Mackenzie River, but the first place west of the Mackenzie River recognized as a regular village site is Escape Reef, some fifteen miles west of the most westerly mouth of the Mackenzie. From this place, going eastward, one has to cross the entire delta to the south point of Richard Island before coming to the next recognized site of habitation.

At Escape Reef there are the ruins of some eight or ten houses clearly visible, and the huge quantities of driftwood may easily cover from sight any number of old ruins.

There are also several graves. Some of them of the old log-covered type, and others, more recent, of wooden boxes set on high hills. One grave differed from all the rest in being a platform burial of what might be called the Indian type. This contained, as I learned during the winter, the body of a Nunatama girl of fourteen, but the grave had been constructed by an Eskimo known to the whites as Anderson, who was an immigrant from Kotzebue from the west coast of Alaska.

(/ Honesty of the Eskimo. Nothing can make more clear the general honesty of the people than the fact that people leave their household goods on platforms, or even on the ground, at any point where it is convenient to leave them. Although these articles are often of considerable importance and easily carried off they are very seldom disturbed. Of course, where food is left, it is an unwritten law that anyone who is hungry may help himself. But, having done this is always freely acknowledged. In the old days apparently no restitution was made, but in more recent times, since the Eskimo began to acquire ideas of private ownership from the whites, the custom is gradually growing up of making payment for food as it is taken from abandoned stores.

There are, however, thieves among the Eskimo. Of those native to the Mackenzie Delta two men are publicly recognized as thieves, and it seems to me probable that these two are really the only ones at all given to stealing, for such matters become quickly known among the Eskimo. / One of these men is also the only murderer now living in the community, or at least the only one whose crime is at all recent.

**Burial Customs.** The Mackenzie River Eskimo put the body of the dead person on the ground, sometimes on hills, but more frequently on sandspits where driftwood is abundant. The body is then covered with logs, the sled on which it was hauled to the burial place is broken up by the side of the grave, and a number of articles, such as the dead man had used, or owned, are left beside him. A few articles of great value, such as labrets of rare stone, ordinarily go as inheritance to the descendants of the dead man. If, however, the man owns several pair, one or more may be buried with the dead. A woman's most valuable possession, her false hair, was, however, usually buried with its owner. This accounts, among other things, for the fabulously high price at which false hair was held, for the value of a good set was computed at from one to two white whale skin umiaks.

White men assert that very often an old and inferior gun is substituted for burial purposes for the better weapon owned by the dead man. This, the Eskimo deny, however, and I am uncertain where the truth lies. They admit that the custom is growing into disuse. Certain recent burials have no property at all left beside the grave, and it seems not improbable that the white men's story of the substitution of inferior articles may be true. In general, the Eskimo seem to have the idea that the articles left with the body are useful to the dead. Sometimes these take a curious form, however. One man told me, for instance, that as he could not bury both a blanket and a rifle with the deceased relative he buried two blankets and no rifle. He said that the dead man could use the blanket as a rifle in the future life. As I met this Eskimo at the time when my command of the language was as yet rather poor, I could not make out clearly whether he expected his relative to trade off one of the blankets in the future life for a rifle, or whether he thought of the blanket merely as an indefinite equivalent for the gun.

// Food is often placed in the grave with the dead, and it was formerly a custom to replenish this store occasionally for two or three years after the individual's death. Only small quantities were put on the grave, however, a year's supply of food for the dead man rarely being equal to a square meal for the living. Sometimes articles placed on the grave were deliberately broken and the food was occasionally burned, or otherwise handled, so as to be unfit for the use of the living. From my investigation of the older graves I conclude that such articles as kayaks and sleds were almost invariably broken, while smaller things were buried in good condition. The labrets, all the Eskimo agree, were not left in the man's lips, but were placed at the side of his head in the grave, some said invariably at the right side of the head. [ ]

The Eskimo from Point Barrow, and along the north coast of Alaska, told me that the only proper way to bury a man was with his head to the

east, but the excavation of graves showed no such uniformity as a matter of fact. It was difficult, however, in some cases, to determine the original position of the body, because the graves had been disturbed by dogs, wolves, or polar bears. In fact, the body ordinarily is devoured within a day or week of its interment. It was said that if the dead was recognized by the community as a man of importance more pains were taken to preserve his body, and the Eskimo frequently remark, on seeing a carefully covered grave, "that a good man must be buried there."

**Firearms Among the Eskimo.** In guns, as in everything else, the Eskimo are particular to get the best. In the early days they had no firearms at all until long after the Indians south of them were supplied with muzzle loaders by the Hudson's Bay Company. But when whalers began to winter at Herschel Island the Eskimo soon secured modern American rifles, and are now so particular about their quality that 44 calibre guns, and others of low power, are practically without value among them. Some own Krag-Jorgensen, Lee-Enfield, and other similar high-power rifles. If it were not for the expensiveness of the ammunition these guns would doubtless entirely replace the American-made rifles, for the Eskimo values even more keenly than most white hunters, lightness of ammunition and the high power of the rifle.

**Fear of Being Photographed.** Some of the Eskimo east of the Mackenzie River have not the least idea of what is happening when their picture is being taken, and so they do not mind it. But west of the river some seem to enjoy being photographed, those were the more sophisticated ones who had gotten over their early views on the subject. But others of those who understood, in a way, what a photograph was, were exceedingly afraid of having their picture taken. It seems probable that this is from the underlying idea found among so many primitive peoples, that one who possesses the likeness of a man thereby secures magic power over him, and can, by injuring the picture correspondingly injure the individual. Some of these men were willing to have their photographs taken when they were feeling well, but if they had a cold, or other form of sickness, they would excuse themselves saying that they would come and be photographed as soon as they were well. Some really did this, but some of them used the excuse to escape entirely.

**The Eskimo of Herschel Island.** Previous to the first coming of the whalers in 1889, there were probably few Eskimo immigrants into the Mackenzie River country. There are traditions of occasional visits, perhaps one only, from Point Barrow. Roxy told me that when he was young a umiak arrived at the Island just about freeze-up time one fall. These were Point Barrow people who were on what might be called a voyage of explora-

tion. True, the Mackenzie River and the Point Barrow men met yearly for trading purposes at Barter Island, Collinson Point, or some neighboring place, and were, therefore, more or less familiar with each other. As I learned later, the Herschel Islanders had a very bad reputation for dishonesty and even treachery among the traders from Point Barrow. These, therefore, left their wives, children, and property behind in the neighborhood of the Colville Delta. It seems there really was a difference in the two people, because the Point Barrow men never had a correspondingly bad reputation with the Herschel Islanders. It may be considered, therefore, a rather venturesome journey upon which this Eskimo boat found itself.

The visitors were well received, however, at the Island, entertained for a while, and then began a sort of triumphal march to the eastward, going from village to village with a large company of followers, and finally going as far east as Baillie Island. Here the leading man of the Point Barrow party married a "Kogmollik" woman who became his second wife. In the latter part of the winter the party returned to Herschel Island; and when navigation opened they proceeded to Point Barrow. It is, therefore, clear that there was some intercourse, and intermarrying, between the Mackenzie River Eskimo and others.

Shortly before 1889 the first Nunatama, or inland Eskimo, arrived at Herschel Island. The people who were used to dwelling with Point Barrow Eskimo, and who found no trouble in understanding their language, understood at first scarcely a word of the dialect spoken by the inlanders. After being together for a week or so, however, they found little difficulty in conversing, but it seems that the Nunatama dialect differs more from that of the Herschel Islanders than from that of the Kotzebue Sound, or so, at least, the Mackenzie people say.

With the first whalers, and practically every year since, there have been Eskimo immigrants from the Islands in Bering Sea, and from various points between the mouth of the Yukon or Point Barrow. Sometimes these have stayed one and a half years, sometimes indeed they have hardly come ashore from the whaling ships, but not infrequently both men and women have taken up permanent residence at Herschel Island, or farther east. A large number of the Nunatama have come either overland by themselves, or eastward from Point Barrow or Kotzebue Sound as passengers on whaling ships, while those from Bering Straits have ordinarily come as whalers or servants on board. The net result is, that the Mackenzie population is becoming mixed in blood, is already deeply influenced in its culture, and has taken up many strange words into the spoken language. A few of these borrowed words are English, an occasional one is Indian, but most of them are forms of Eskimo words which were previously not in current use at the mouth of the Mackenzie.

## THE COLVILLE RIVER, 1908-9.

*July 4, 1908.* On way to Red River. Hunting has been poor at Good Hope. The Indians ordinarily live largely on rabbits. But this and last year no rabbits, so they could not stay near the Fort for marten (even if these had been plenty) but had to go to the deer country around the head of the Anderson and north of Fort Confidence. Many dogs starved and they are now high in price. Indians had been living mainly on rabbits for "last ten years," Mr. Gaudett said, but these last two there were none.

*July 23.* Deaths. Kunnullak and wife and young girl (about 12-14) of another family died Tuesday of this week at Niakōnak, apparently of kilalua poisoning; had eaten of kilalua day before they became sick. The common belief seems to be they died because they worked at skins, (deer, seal) just after a kilalua was killed.

*September 14.* Smith Bay. Child Teeth. Noashak had two pulled with a string today and they were thrown away. Mamayauk reminds me that Kogmollit feed teeth enclosed in meat to a dog, but Ilav. says his people throw them away.<sup>1</sup>

Beliefs. When he was young some women of his people scraped deer-skins the same day an ugrug had been killed and eaten. Later that same summer, some weeks later, an epidemic ("dry throat," he calls it) came, killed many people, among them some, but not all, of the women who had been concerned in scraping skins. This epidemic came because of the skin scraping; Ilav. still believes this (Kotzebue Sound). Has known many similar cases, among them the deaths at Niakōnak this summer.

Why dead seals, etc., must have fresh water. In the boyhood of Ilavnirk's grandfather there were at one time many hunters (as usual) at the kilaluak station of Sishulik. One of them, Kaiaaitjuk, was one day capsized in his kayak, but was not drowned for two kilaluak placed themselves one under each arm and he swam off with them and lived with them some time. By and by, he became a little homesick and they took him back to Sishulik. When they came to the surface where he had been capsized, he saw all the tents were gone, all the people had left for their homes. K. began crying (weeping) but the kilaluak said, "Never you mind; come stay with us all winter and we will bring you here next summer when your friends are here." K. accordingly stayed all winter and at the proper season was taken to Sishulik by the kilaluak. When the hunters saw them they came in innumerable kayaks (there were both Nunatama and coast people)

<sup>1</sup> See Stefánsson, "My Life with the Eskimo," p. 56.

to the hunt. The kilaluak told K. to keep between two of them and not to go near any kayak for fear of being harpooned. The kilaluak soon found themselves in shoal water and many of them were harpooned. Finally Kaiaaitjuk saw his chance and came out of the water. When he appeared people at once said "There is Kaiaaitjuk," for they recognized him though his outfit was somewhat changed. Over the deerskin coat he wore when he went away, he now had a waterproof coat of intestines (ugrug?) and his kayak was now pure white, like the skin of a kilaluak. But what people wondered at most, was that while Kaiaaitjuk held his paddle level and dipped neither blade in the water, still his kayak flew ahead faster than anyone could paddle. When people saw this they feared he would go away again, and all gave chase to try catch him. One of them was so placed he could head off the fleet white kayak, and got his hand on it as it went past him. At his touch, the kayak became an ordinary one and thereafter moved only to the paddle, as other kayaks. Kaiaaitjuk now went ashore with his friends, but was scarce able to go into a house or stand near anyone, or he said they smelled so bad. They brought him food such as he had been very fond of before, but he declared it stunk, and he could eat only a trifle at first. Finally he got used to everything, however, and was thereafter as other men. After his return K. told that the kilaluak and other animals that live in salt water, are really tarnigut (sing. "tarnik") and that whenever a seal, ugrug, walrus, kilaluak or bowhead was killed he should be given fresh water on coming to shore. (This water is brought from some house, not any particular one, and maybe river, pond, snow, or sea ice water, providing it is not salt.) Ilav. says maybe the people lied who told this, but his own grandfather saw Kaiaaitjuk. Anyway, Ilav. always gives seals, etc., water.

*September 18.* Guests arrived yesterday in the shape of three sleds, two with umiaks (bound for Point Barrow), and some sixteen people. Measured all men and women — rest of women and children unwilling. These were some of the people we met Wednesday. One of them was the man whom the ice party two years ago encountered on their return, on an island just west of Pingak, he says. He gave me map with location of some families in the Colville this winter.

*September 20.* Near Flaxman Island. Old Houses. The two houses where we camped last night were recent. Some four to five miles E. is older house, but also recent, half to one mile E. of that again is a really old house ruin on sand bar at N. W. corner of a large, roundish lagoon near some large pressure heaps of sand.

A grave near this old house has this board: "† C. L. Gray died Oct. 5, 1897, aged 36 years." A half mile farther west are two native graves with crosses.

Landmarks. About half mile E. of our camp of last night is a pole about twenty feet high supported by a large number of props. Two very conspicuous pressure heaps of earth near the above grave.

*September 25.* Aboard the "Olga." Capt. Mogg gives information as to Prince Albert Land. Wood very scarce, though in summer often sufficient for camp fires traveling along the coast. A little more wood on Banks Island east of Nelson Head. Blubber for fuel, however, easily attainable.

The people of Prince Albert Land, Capt. Mogg estimates at 800, 250 of whom they saw. They are in the estimation of himself (and crew, including natives) a very superior class of people in honesty, resourcefulness and intelligence. Extremely hospitable. In winter they live on the ice. Seal are so abundant that at most abandoned winter camps one finds "tons" of blubber either cached or left lying around. They have no fish nets, kill bears with spears, every man and dog turns out, and deer with bow and arrow (tartar bow). Spears and arrows copper and bone tipped. Only Banks Island people heard of are towards Mercy Bay, called "bad" by Prince Albert people.

*October 21.* Flaxman Island. A daughter was born the night between Saturday and Sunday (17th and 18th) to Akpek and Shungauranik. Shungauranik danced furiously in our house at a general "ulahula" the evening before, and has been able to walk behind the sled with the child on her back since we started. The child is apparently in the best of health, has black hair half an inch long, and thick — "a full head of hair."

*October 26.* Island in Sharavanktok Delta. Care of Infants. Sh. handles hers entirely inside her clothes. The child is dressed, however, coat and boots, coat fur, boots blanket. Sh. was able to walk all day, though she is not feeling well, distance about ten miles, Ojarayak's camp about four miles S.E. of Putulray cache, the one we knew of old. Saw another of his caches on E. branch of river about two miles inland.

*October 28.* Sharavanktok Delta. Dog harness were made by the Nirlirmiut of deer legs "because they had no seal" (A. says). They were like the harness now made, sometimes one broad band, sometimes two narrow, along back.

*October 30.* Barrel Point. Deer driving was much employed by the Colville people, especially up near the mountains, Akpek says. He remembers one only, however, when he was about eight yrs. old (say twenty years ago). At that time about fifty were killed, and it was a small drive. Kayaks were used, and okpek stakes in convergent lines to represent men. The driving was towards small lakes and seldom towards a river, if at all. The bucks often fought with their front feet against the kayaks. Deer were killed by his father, Billy says, about two days' travel from Cape Prince of



Wales. Billy never saw any there. A whale skeleton Akpek knows about and has seen on the bank of the Colville about two days' journey from Oliktok. Some has by now caved into the river. People say that formerly there was sea extending to this place and a whaling village located here.

*November 8.* Itkillik River. Started 8:45; camped 3:00; near Itkillikpa, saw tracks of sleds gathering willow. Place we stopped called Tuluraluk, on right bank. After starting yesterday, we followed left bank except not going into some small streams, until we came to a point about twelve feet high. After that we kept "main road" pretty well. Saw a grave about six miles from our camp. Opposite (west of it or N. W.) is a point of an island (its south end) high and with small pingoks. This is Pëshiksharvik, a place so called from frequent fights and many being killed there. E. or S. E. of this on mainland, high pingok.

*November 9.* The people we have seen so far are disappointingly sophisticated, though they do not seem to have much use for "civilized" food. Akpek's whole family seems to be around here — brothers, sisters, mother. One of his brothers (Aya'unirk) came to visit him last night and Akpek goes to see him tomorrow, lives some few miles south. Panū'lak is the name of our neighbor here.

*November 14.* Akkoblak's boy has delayed us about one hour today with nose bleeding. He had another attack just after we got into our tent for the evening.

*November 15.* Nirlik. Akoblak says there are trees on the Itkillik, but not on the Kupik branch of the Colville. He lived among the trees one winter of the five he has spent on Colville (comes from country behind Kotzebue, wife of Colville parentage and birth); at that time (four years ago) some deer (formerly plenty) and moose, fish, rabbits, and ptarmigan; in mountains, sheep and some places bear. Now no deer but still some moose in tree country. Some miners occasionally and one expected next year, has horses, and has been on Itkillik before. Have been miners also on upper Kupik. When "Charlie" (the one who lived in "Miner's House" with "Minnie" the Jap.) left, he went up Itkillik in spring by sled. Of the five he knows of that starved to death last winter some (two?) were on the Itkillik and three on a branch of the Kupik called Ningolik. This branch is on the Kupik's east side. Farther east still (or north) is another branch, the Anaktok.

*November 16.* Indian Song. Noticed what might be called an Indian refrain in Mrs. Akoblak's singing. She said it was a Nirrik song. The refrain: Ai hēā hē occasionally brought in.

*November 20.* Cape Halkett Island. Preparing Deer Legs. Akkoblak's wife is doing a pair as follows: After cutting them off the hide she

dried them and then rubbed them soft with a brick-like (pumice?) stone found on the Kupik near Atoakotak's house. She then plastered the skin side with a mush made of boiled deer liver and whale oil. When thoroughly plastered with this each leg is folded like the closing of a book (lengthwise).

The above holds, except in this respect, that the rubbing with stone was down to the knee of the deer leg only; below that the leg was slightly scraped with the ikuun. The liver is applied only to the part scraped, and not to that rubbed with stone. After the leg is folded book-wise as above, it is doubled on itself so that the "livered" part is four-fold and the rest merely double. The legs are then piled one above the other in a pile and sat on a little while and then put aside. Perhaps tomorrow, perhaps later, she says she will scrape the livered part soft and the leg will then be ready for boots.

*November 23.* Started 7:30, camped 2:30, housing with Kunagrak where we made our first camp going east. Akoblak's family slept in the other house. Both houses have considerable fish (the kind caught at Shingle Point) and are catching them now. They also have a smaller fish, looks like Norwegian herring. They expect the fishing to stop about the time the sun comes back.

*November 29.* Started 9 A. M. Camped 2:30 P. M. in a house built this winter by some Barrow people who have left it temporarily. Found stove, lamp, etc. in position and blubber on the rack — took some for our dogs.

*November 30.* Iglorak.<sup>1</sup> Houses. We found two caches on a sandspit east of Iglorak and one (of snow) on another, a snowhouse at latter place but tent sites only at former. On Iglorak were two houses. The people had all left these, only a few days ago,— probably went to Cape Smythe for Thanksgiving. From Iglorak broad sled trails northward showed they have been sealing from there.

*December 5.* Cape Smythe. The blue stone (sapphire?) beads were accounted for in this way: Long long ago, there was a man in Kotzebue Sound who treated his wife very badly. Finally she could not endure his abuse longer and ran away, going across country northwards. When she reached the ocean she still kept the same course (it was winter) until she came to an uninhabited island. Here she found a beach covered with pebbles, and all of them were green (or blue) stone. She filled a mitten with these and turned back. When she got to her people again her husband had married another woman, and they already had a family, but because the stones represented great wealth he took back his former wife and ousted

<sup>1</sup> Probably Cooper's Island. See Stefánsson, "My Life with the Eskimo," p. 51.

from the house his second wife and her children. This story was told to Mr. Brower some years ago by a native from Kotzebue Sound who was at Cape Smythe. The value of these beads was fabulous. Some years ago when furs, bone, etc., were already at a high price, one of these was sold at Cape Smythe for two silver foxes, (twenty) slabs of bone, a sled and team of five dogs and five cross foxes. Labrets were made out of these beads if they happened to break accidentally. One side was ground to a flat surface and stuck on to a circular disk of white stone. The adhesive material was "gütjuk," or seal oil boiled till thick and sticky, the same material as they used for chewing gum and for pitching canoe seams, when they pitched them at all. Occasionally, however, they used the pitch from the lake behind Simpson. After the ships came, imitations of almost no selling value were made by using split blue marbles. An unbroken bead was much more valuable than a pair of the best labrets made from the same sort of bead, so beads were never broken to make labrets. The red stone (ochre?) used for coloring skins and woodwork comes to Barrow from a branch of the Sharavanaktok River. Mr. Brower himself still uses it in preference to paint for his skin boat frames, etc. In putting it on, sometimes the powder is dampened with water before rubbing on the wood, sometimes the wood is dampened and the powder rubbed on dry. Occasionally, seal oil is used in place of water; this makes a darker shade, but the object remains sticky.

*December 8.* Cape Smythe. Practice of Abortion. No disgrace, so far as Mr. Brower knows, ever attached to either voluntary or involuntary abortion and the former was practised until a few years ago, especially by young girls who considered it too early to assume family cares. Treatment was by kneading the abdomen and was done by doctors or by old women. Two or more doctors often worked together in other cases and Mr. Brower believes, but does not know, that both doctors and old women worked together on abortion. No secret was made, he thinks, of the time and place of treatment although he never heard of it till afterwards, except in the case of a young girl who told him she was going to have it done pretty soon, and later told him that now it was done. He never knew death or any serious illness to follow voluntary abortion, though he has known of serious illness after a miscarriage. Treatment was occasionally by hitting the stomach smart blows with a flat stick, though kneading was the usual way. There was no question of "confessing abortion" for it was made no more secret than childbirth. Twins were not desired, but were no great misfortune or disgrace to the women who had them. Two could not be cared for, however, and one was exposed, usually not always, the girl, if the children were one of each sex. No secret was made of either the birth or the killing. The sex of a child is usually correctly foretold by the mother after five or six months

of pregnancy. Mr. Brower knows of but few mistakes, and in his own wife's case there have been none, two girls and four boys now living and two girls and one boy dead. He thinks they tell partly by the amount of movement of the foetus, boys move more. Preference for boys is the rule, but in many cases girls are desired. Mr. Brower can give no rule as to under what circumstances girls are wanted, but thinks that in most cases parents prefer to have the first child a boy (cf. Mackenzie River). He has never heard of any magical or other treatment to control the sex of the expected child. Pigmentation among Eskimo varies from that of whites in this general way that the parts lighter than the rest of the body among whites are darker than the rest among Eskimo — cf. *linia labæ*. The genitals, nipples, and abdominal line are usually, if not always markedly dark (Dr. Marsh).

*January 1, 1909.* Names. A small boy (about four) in this house was born a short time before his uncle died. After the uncle's death the baby became very restless and became quiet only after he got the uncle's name. This was given him as a second name and he at once became quiet. He had been crying for the name. Formerly, when a child was very restless and cried, a medicineman was called in to determine whose name he was crying for, when the right name was found the crying stopped. On being questioned, all the people of the house (three) agreed that not only did the child want the name, but "in all probability" the name was equally anxious to get into the child, i. e., they seem to think of the name as an entity.

Ten-Footed Bear. Tarak told us Wednesday evening that the ten-footed bear lives mostly in the water like a seal. Looks like a polar bear all but the ten legs. When he walks on ice the five feet of each side track after each other so the bear makes a double track like a sled. Walking the bear often gets his legs tangled up; there are so many, he can't manage them all. Once a man was followed by a ten-footed bear. The man walked between two cakes of ice and the bear was caught in the crevice between them. If his feet had not become entangled he might have gotten off. As it was, the man speared him. When dying, the bear fell on his back, all his feet pawing the air. This is an old men's story. Tarak never saw such a bear or tracks.

*January 2.* Point Franklin. Started 10 A. M. Arrived at house of Akebiana (Point Franklin) 4:45. There are six houses here, but only two have people just now, the other four families are at Icy Cape for the dance.

Tattooing. A woman from Noatak (Napaktok) says girls of her time (she looks forty) were told if they did not tattoo the chin, the chin would grow long to disfigurement.

A "Kogmallik" woman is Akebiana's wife and she is Roxy's and Ova-yuak's cousin. She has been around Barrow about twelve years and has forgotten most Mackenzie words that differ from Barrow.

Humor. Two jokes "sprung" last evening may be called typical Eskimo jokes. The loose root of a badly pulled (broken) tooth, came out. Some one said I had twisted it out in trying to pronounce Eskimo words. George said when he was small he cried for another name. His wife said she guessed it probably was worms.

*January 3.* Point Belcher. Started 10:10 A. M., stopped 1:30 P. M. in vacant house (stove, etc.) at Sisdraruit (Point Belcher). Two inhabitable houses here. About half mile north is house of Portugee Jerome Lope who three years ago last fall went into prison at McNeill's Island, Washington, for "Statutory Rape," living with woman under sixteen.

*January 7.* Wainwright Inlet. Perpetual Frost. At various times in the past I have found in speaking with Eskimo that they consider solid frost as the natural condition of the earth to an unknown depth, the layer thawed in summer is the only part not frozen at that time. They have asked me how far one would have to dig in my country and in the negro's country to get down to frost, after it was explained that in Africa it does not freeze in winter or summer.

*January 11.* Wainwright Inlet. Sharpening Tools. Dr. Marsh says women never sharpen stone ulus or ikuuns, the flaking done by men.

Takpuk is said to be going insane. He is so restless that he has to be traveling or moving all the time. Got tired of waiting for crowd of dancers (who hang around Wainwright four days) and came back to his deer herd. Behaving as he does would not be remarked among the whites, but is considered abnormal here.

*February 19.* Wainwright Inlet. A native trader arrived last evening from Kotzebue Sound. He is said to have \$500 in money and some "civilized" shoes, sweaters, socks, underwear. He pays \$3.00 in money for white fox; other prices in proportion.

*February 21.* Whalebone was made into a sort of toboggan. The small ends of the bone turned forward so the sled was narrow in front, raft fashion. The forward end bent back as in toboggan. All hair trimmed off the bone. Back end bones cut straight across side pieces and at end of bone turned up on edge or at an angle. Some sleds strengthened with wood, Mr. Brower thinks, but is not sure.

Bone was also used in making snares for big birds, geese, etc., and occasionally for ptarmigan. Hair off the bone used to snare smaller birds. Ptarmigan snares and small bird snares generally caught bird about neck; geese caught by leg in snares along beach. These snares usually set in strings with one or two dead geese for decoys. Bone also used for wolf killing, was not folded (as at Mackenzie River) but coiled, was frozen in deer meat and deer fat and string removed so mere thawing would release spring.

*February 25.* Victoria Island People. "Fearless" (Ilavinirk's "brother") who was with Mogg last winter gave me some items concerning the people today. Fearless says people had a distinctly lighter complexion than any Eskimo he ever saw. Saw some whose skin (face) was as light as mine, several with hair ranging from mine to Mr. Hadley's (which is dark, but not black). Hair was, too, not so stiff as ordinary Eskimo and children's hair averaged lighter than grown people's, a thing true of whites, though I have seen no variation from the ordinary black among Eskimos except in newborn children.

It seems entirely out of the way to suppose that these facts can be explained by white blood mixture from Collinson's and McClure's vessels, in view of the fact that no such changes have been wrought at Pt. Barrow in over half a century of definite contact. Fearless says the complexion differences are carried out in the eyes, for he says the white of the eye was like white men's and not like Eskimo's or Indian's. Some of the people had eyes as light as mine, Fearless says (though McIntyre says he saw only one as light and Baker [engineer] says he saw two.) Fearless agrees with white men in saying average stature of the people up to that of Nunatamas.

Mr. Brower knew of one woman a daughter of an officer of McGuire's ship. No trace of white blood is apparent in her full grown son who now lives at Point Barrow, woman long dead. It may be said, therefore, that all trace of McGuire's wintering has disappeared. Mr. Brower has seen only one case of light eyes in half-whites here, and knows one case of light hair. All half-caste children I have seen anywhere (Eskimo) have had black hair, have seen thirty or thirty-five. F. says beards no more marked than among other Eskimo. This is negative but he also says beards were as light or lighter in shade than hair.

*February 25.* Victoria Island People. Scarcity of women is marked. There were no single women but several single men; no men had two wives but several women had two husbands. Exchanging wives is practised and little or no sexual jealousy. Large proportion of children (contrary to Klinkenberg's story).

Movements of People. People hunt in Banks Island sometimes. Whenever they cross sea it is by sleds, for they have no umiaks and but four kayaks among people whom Fearless saw (Capt. Mogg says about 150 visited ship and F. saw an encampment of twelve houses besides those 150). They sometimes hunt where there are trees (not willows) and have their bows, etc., made of these and not of driftwood. They know of people (Eskimo presumably) who have white men's wares, but these are hostile. Know of Indians also.

Copper not much in evidence among people Fearless saw, most had

knives from Klinkenberg's ship of former years. Some women had ulus of thick tin probably from Collinson's ship.

*March 5.* Wainwright Inlet. Ugrug boot soles when cut from canoe skins, should be cut with their long axis perpendicular to the rail (or keel) of the boat, on account of mis-stretching of the hides in lip parts of the boat. Only boat skins make first class soles. The prow and stern skins of an umiak, however, are stretched fore and aft and from these the soles cut should have long axis parallel to rail.

*March 5.* Sled rafts à la Peary were always used by the Point Barrow Eskimo—usually one poke forward between the runners and two behind lashed outside the runners.

*March 8.* Aboard the "Challenge." The hair cutting of the Siberians aboard (from near Indian Point) is the same practically, as that of the Eskimo, except, possibly, the tonsure is a bit larger and the hair shorter below, i. e., the uncut hair just after a hair cut, gives the impression of a ridge or band around the head. You notice on them the hair they have left, on the Eskimo the hair cut away. They say that everywhere along their coast the same style prevails. Some abandon it while on shipboard but always cut hair just before getting home. The same style does not now (if ever) prevail on Big Diomedé.

*March 8.* Barrow Houses. Mr. McIntyre says that he was at Point Barrow in 1880, and saw and entered a house there that had a door in the side covered with skin. There were two doors each covered with bearskin, i. e., one in alley.

*March 10.* West of Iglorak. Started 8:45 A. M., camped 6 P. M. in one of three snowhouses (deserted) on next sandspit west of Iglorak. Biggest (the center one) house had evidently been lined with canvas for permanent habitation, but canvas recently removed and big holes left open in roof of house, about three feet square. The (west) one we slept in was a temporary camp but door and stove pipe hole closed and all in good shape. Did not look into easternmost house.

*March 10.* West of Iglorak. Snowhouse building seems a lost art. It is said the people formerly made the dome houses, but nowadays they use a handsaw, cut the snow into huge blocks (say eighteen inches by forty), build the house in a rectangle with the walls perpendicular and the gables highest in the center, log cabin shape. A ridge pole of wood is then laid and block laid resting one end on wall and other on ridge pole. If no wood is available the blocks are said to be leaned together at the top. This sort of roof will evidently sag in mild weather. It is said some half dozen men at Cape Smythe and Point Barrow know how to build dome houses.

Inlander combination houses and tents are thus made: The ordinary

dome tent is put up. On top this snow is shoveled. It must be soft; if there are chunks they are pulverized or thrown out. When the tent is covered about six to eight inches (patted down with flat of shovel), a fierce fire is built inside. This forms ice in the snow outside and unites the tent, of course. In course of use the tent dries. A space is left between the tent and snow (now part ice), by the first thawing. This acts as insulating space all winter. We thus have practically a lined snowhouse. If the tent be removed the snowhouse remains, unless broken.

*March 12.* East of Point Barrow. Victoria Island people hitch their dogs fan fashion to sled, Uyuliak says. Team usually four or five dogs. Sled, short, such as used formerly at Mackenzie River. Runners of wood, shod only with ice. No knowledge of nets nor of snowshoes.

*March 15.* Fine whetstones were, and are, brought from Ulahula River to Barrow, etc., for trade. Look almost or quite suitable for razors.

*March 16.* Imarruak Ingenuity. Someone in the house has made today a kerosene lamp with a two inch wick (wide) out of one of my two-pound roast-mutton tins. The wick is of manifold cloth. The wick is raised by a pin thrust in alternately through two slits in the side of the burner.

*March 17.* Imarruak. Combination pants (like wading pants) such as women usually wear, are worn by Pilyalla (the starved man) and by the boy Cekeara who is with us. The man's outer and only pants are with hair in. The boy wears inner pants hair in, a sealskin slipper on feet over these; then outer, hair out. The legs of the outer pants are of deer legs such as usually used for boots. Boy is twelve or thirteen years old.

*March 17.* Polyandry. A Point Hope woman, Aksxratkok, had two husbands, the earlier, Nayukuk; the one added later, Ukulli'na (a Kuwormiut) N. is from Point Hope, and later lived at Point Barrow. Ukulli'na has now been divorced. All are still living, woman and husband at Point Hope. (Told by Uyuliak and Billy in concert.)

*March 18.* Near Cape Halkett. Tents of walrus or ugrug gut were, Billy says, sometimes made for summer use at Port Clarence.

*April 14.* Flaxman Island. Thefts are numerous this year. We have lost from the cache here 1 spy glass, 1 pair deerskin boots, 1 skein red yarn, about 10 lbs. tobacco, half a tin matches, etc. Others have lost similarly. Whole community very religious. Thefts formerly rare.

*April 20.* Near mouth of Kuparuk River. A cache at our camp about two miles west of the Old Barrel. Table gear, ulu, wolverine claws, etc., indicates to us starving people, but it may be stuff left by people going inland to hunt.

*April 29.* Near Point Barrow. Started 10:45 A. M., camped about



9 P. M. in Arnvirak's house, the house he was living in when we slept in his other vacant house March 11th. All houses now deserted, everybody whaling at Barrow.

*May 23.* West of Simpson Cutbank. Bringing up Children. Talked with Ilavínirk tonight about the fact that Noashak is a pretty bad little girl. When we travel she is always on the sled, when we stop she is over all creation tumbling and capering. He said if she were a boy, he would make her walk. Told of the harmful results of speaking harshly to children. Said when he himself was small his father spoke harshly to him occasionally and he feels the evil effects still. Is not as bright as boys always spoken to kindly; if spoken to harshly or suddenly now his "heart jumps." Besides, he wants her to have as easy time as white children. Travelled once with Mr. and Mrs. Lapp and children to Point Hope; neither Mrs. Lapp nor children walked a step.

*May 26.* Length of Stories. Ilav. says his father knew one very good story. It was so long it took about a month to tell it all. Of course, he says they did not sit at it continuously. His father might go looking at traps one day and hunting another, but always when he came home and had eaten he took a seat in middle of karrigi floor and started where he left off.

*May 27.* Imarruak, (Smith Bay). Hunting Methods. Pannigabluk found some small dead bed-willows at Imarruak, stuck them in the snow, and snared ptarmigan among them.

Religion. Ilav. the other day repeated his assertion that before missionaries came Eskimo were bad. Now they are good. The first time the story was that they lied, stole, and worked on Sundays; now they lie and steal but don't work Sundays. To this he now adds that formerly "doctors" used to kill men by magic, but now there is none of this, thanks to fear of Hell.

*May 28.* Near Imarruak. Conservatism. A. says that last winter when they had no deerskin for bootsoles his people would not try moose-skin. Said they never heard of anyone trying it. Refused to use for bootlegs those of deer skinned by A. because he ripped the skin up the back of the leg up to the hock, whereas they rip it up the front of leg to hock then go inside leg.

*May 29.* Near Cape Halkett. Dimensions for our Umiak. Length  $33\frac{1}{2}$  feet, width 6 feet at top, 33 inches at bottom, depth 26 inches.

*June 3.* Cape Halkett Island. Found on top pressure ridge by last camp a piece of an Itkillik bark canoe laced with a root.

*June 9.* Island southeast of Point Comfort (?). Women's tapsís at Port Clarence and neighborhood were decorated with deer teeth. Pannigabluk says she has not seen this at Barrow or among any of the eastern peoples.

*June 19.* Beliefs. Pannigabluk tells that two years ago her brother Alĕkak wanted to stay at Rampart House as Kururak did, but could not because their mother (hers and Alĕkak's) "did not want to die among trees." Why did she not want to die among trees? "That was her idea not mine. I don't know what she thought."

*June 24.* Eskimo Medicine. Have seen this winter several cases of violent squeezing of the chest to relieve pains there. The patient holds up his arms above his head while the strongest man available stands behind him, puts his arms around his chest and grasps one wrist by the other hand and squeezes about or below the nipples. Apparently he squeezes as hard as he can, while the patient does not seem to swell the chest to resist. Usually the patient lifts his feet off the ground and is thus held up for perhaps thirty seconds, when the pressure is relaxed.

*June 24.* Childbirth. The old women tell the young girls to be sure to get their first child early, as otherwise childbearing will be difficult. Shortly before the time of delivery pregnant women are advised to court violent exercise as "it will loosen the child and make it come easy." This advise Mr. B—blames for the death (about Apr. 30) of his nurse girl, Flora—miscarriage. She brought a sled out to the floe over rough ice and worked hard on it, against B.'s directions, because old women had told her to.

*June 25.* Nirrlík. The person seen was a Colville woman, Kĕruk, a widow since last winter. B. had come to a river and attracted her attention by shooting, so she came to the opposite bank. She told B. that if we ascended river we were planning to ascend we should hit Colville "far" above Itkillikpa; besides the river was cracked—very. Said almost all Colville people had starved this winter, though none to death; that about all of them had come in boats yesterday to Nirrlík to fish and they had proceeded to where they are now camped on a river, having its mouth in sight of Nirrlík and coming to within half mile of the river we were near.

*June 25.* Nirrlík. The people we found yesterday were the following (according to Pannigabluk): Kĕruk, a widow of Í'tjĕrrak (K's father Nunatama; mother Kuwuk) (Í's Nunatama?); Kálĕgarrk (Killermiut) (the Killer is a branch of the Kañianik in the mountains, the Kaña branch of Kupik); Duk'kayak (mother, Nuna; father, Killer); Innuahlúrak, husband of D., (Killermiut); I'yaak (daughter of Kan'aurak's brother. K. is one who had a devil) (Kagmallirmiut—in mountains); Ítáhluk (Kagmallirmiut); Kaxxorak (Daughter of Kĕruk—about five years old), Arrígaaitjuak (Akpek's sister, about fifteen years).

*June 28.* The people camped about one mile S. W. of us are Turnña and Kiktoriaak and their two children, boy ten, girl three. T. is Kuwuk, K., Point Hope.

*July 2.* Nirrlík. Measured heads today with Anderson's help, twenty-eight in all. Measured all but two grown people (Attoakotak who is sick and his wife) and eight children, mostly small, though some six or seven years. Panniulak gives the number and distribution of the other people, who frequent Nirrlík to trade as follows (excluding seven measured June 27th and Keruk's little girl (who would not be measured). Up the river S. W. of here four, near Oliktok seventeen, Kuparuk five, total sixty-four. This is not counting, of course, Pillyalla, Kunagrak, and others who are at Point Barrow now and may not come back. One old man, Ikakshak, has parts of his skin turned about "white men's" color — not tallowy albino.

*July 3.* In Camp at Nirrlík. Some of the people were across the mountains, so far they saw no mountains where they were; supposed they were near the Kunkpúk (Yukon). Saw no Indians, but saw two miners who told that the country was now full of prospectors up to the divide, that Carter had "struck it rich" and also the Jap "Cookie." The Eskimo (five tents) killed seven moose and about twenty sheep to the tent, and some deer, but starved in spring.

*July 3.* Nirrlík. Panniulak tells that formerly when a man killed a wolf he ate no warm food for four days, if it was a male wolf and five, if it was a female. When he got into the house after killing the wolf, he would take a stone hammer (an old one preferably or necessarily) and shout four times in the fireplace or near it, "O-ho!" Four times, if wolf a male; strike five times and shout five times if a female.

*July 4.* At Nirrlík were eight umiaks:— Attoktuak, Neakoyuk, Alak, Panniulak, Kēruk, Kattēruak, Kaiyau, Aksiaktok, Aiakkērak, Alahuáluk (arrived as we left). Turnñak had his boat up on the Ekallirpik; Puya and Kirinirk have each an umiak and are on their way now with them from Oliktok by the river. Nutarksiruak and wife and two children are in the mountains, not coming to sea this year. Had umiak when he went up, but may be dismantled now. There are not known to be any others on the Kupik or its branches, have deserted either to Barrow or Kotzebue. No one this summer on Itkillik. People at Nirrlík do not seem to hunt at all this time of year birds, eggs, or deer, but fish exclusively. This is the easiest, as mosquitoes don't bother so much. Mosquitoes do not seem so bad anyway at Nirrlík as elsewhere inland, probably because situated on a high cutbank not far from the sea, and because several tents divide attentions between. Panniulak and family are going to Barrow by the first fair wind. P. says Colville is too uncertain a country for food. Though he did not starve last winter, he came near it, after giving food to those who were starving.

Seal Hunters. Eighteen of the Colville people went by earliest water to

Oliktok (sledged to islands outside?) for seal. One of the three boats (Alahualik's) with nine people and five and a half poks seal oil arrived as we left Nirrluk. They had gone outside the delta. The other two umiaks are on their way with seven poks oil. People killed only one caribou near Oliktok, but think there are plenty now on account of the mosquitoes.

Indian Feuds. In general the relations with the Indian in the tree country seem semi-friendly. I was told, however, that the father of the girl Dukkayak (Innuahlurak's, Panniulak's son's, wife) was shot by an Indian while he was hunting deer five winters ago. Seems to have been and to be regarded, rather as a murder than a warlike act, though quarrels are always admittedly likely to occur. It is said that a few years ago when Omigluk (now of Herschel) crossed the mountains on the Ulahula, he "nearly had a fight" with some Indians he met.

The Nirrluk people seem to be pretty stingy. P. was told that Neokoyuk and Alak had flour and Panniulak a little. Panniulak used his for his children only, but the others are said to have cooked for themselves. Neokoyuk also had coffee and shared with no one. After Panniulak got the sack of flour I owed him and the five pounds tea for the copper kettle he did not spread himself much. In fact, the only public tea drinking was at our house. Several women, however, brought us cooked or uncooked fish at different times, and one brought us two good meals of mashuk roots, locally called Mahū'. These were sacked inland up the Itkillik north of the mountains. They were very pleasantly sour, had been merely boiled and sacked without further preparation.

*July 29.* Diseases. Woman today complained of her heart being so bad it hurt her ribs, and said she got that way after most meals, first her heart would get bad, then her liver, and both "wanted to come up in her throat." In connection with this I asked Pannigabluk about Kēruk on the Ekallirkpik River who complained to us her coughing had broken a rib that morning. P. denied the incident, and so did Billy, for they must have heard us amused over the matter. Later today P. told a woman how Kēruk had broken her rib one day she was with us.

*August 11.* Barter Island. Saw among nine house ruins at W. end of Barter Island at least three that seemed of Mackenzie type — one, a typical Mackenzie River house. Ruins not very old, perhaps older than, e. g. Flanders Point; a larger number of houses at E. end of Barter. Asked Niñ. who used to live there? Said all sorts of people in summer, but in winter few or none but Mackenzie River people. Some winters he thought, no one; sometimes a good many Kogmallit (Mackenzie River).

## CAPE PARRY, 1909-10.

*August 30.* Cape Parry Peninsula. Archaeology. Many of hills, perhaps every fifth has stones set one on top the other by man. Found yesterday one old meat cache of rock, empty. One tent site (circle of stones) with broken deer, seal, and fox bones, as well as charred sticks. Judging from known age of Flanders Point remains, these should be a hundred years old at least. Traces of people most numerous on hills near west side of peninsula. Yesterday found grave on hill just S. of our tent. Some fragments of bones as if body eaten by wolf or bear. Stones at head and foot of grave. Grave wood-covered. On hill yesterday found a half circle wall ten or twelve feet in diameter and about two feet high, averaging two layers of small boulders. Suppose it made by boys playing, some boulders must weigh three to four hundred pounds.

*September 2.* Cape Parry. Archaeology. Yesterday found on a little island what neither Billy nor I knew if to class as a grave or a deer meat cache, a box about two by two feet with sides of stone slabs (one piece to the side) and a cover of two slabs. One slab was partly shoved from its place, leaving a triangular-shaped opening about twenty-four by eighteen inches. Other slab not only in place, but had boulders on two of its corners, apparently to prevent slab being raised. Although hill was nothing but cracked rock everywhere else, inside of box (its bottom) was sod with only an odd pebble. Dug into soil about six inches and found no stone bottom, though we were an inch or two below level of surrounding ground. No bone or other trace of anything, but soil with stray fragments of stone. Sides of box stood about ten inches above ground from outside, but inside of box filled to about six inches from top. Did not dig (could not) below level of sides inside box; would have dug outside box but increasing surf made it necessary to launch our boat. We had gone ashore on the island to spy a harbor across the fjord. It is remarkable in how many places we find a considerable sprinkling of small driftwood sticks on top hills, mostly within quarter mile of some arm of the sea, though in one case half a mile at least. In one instance found slender sticks laid as usual in tents and camp-fire sites during mosquito season. This is Billy's guess as well as mine. Billy says box above referred to may possibly have been a trap for wolf, wolverine, or fox.

Pannigabluk plucks out, whenever they appear, any hairs from her armpits. Looks as if there would be quite a growth there if not plucked. Have heard many whites say Eskimo have no hair there but this is evidently wrong, though the hair may not be so abundant as with whites.

*September 3.* Cape Parry Peninsula. Archaeology. Remains of an old meat cache made with stones and whalebone on island; and another of stones (or a grave?) near our camp tonight. No remains in either. Fragments of an old short sled, the wood parts, also found on island.

*September 4.* Archaeology. About four miles south of camp along beach saw pile of logs apparently gotten together to build a house. All now rotten, though perhaps not over thirty or forty years old. Some chopping done with poor ax, though more likely small iron hatchet than stone ax. Numerous stones everywhere put up (as landmarks?) on top hills or on hill slopes.

*September 5.* Cape Parry. It is so wintry today that I started off about 12 M. to see from hills N. of here if ice is not in, these westerly winds, if extensive, should bring it. Just after starting, however, it got so thick with snow that I was about to turn home a mile from camp when I saw under the shelter of a rock what I took for a rabbit. The one we saw last week was white. I approached to about fifty yards and fired — no move; fired again, same result — concluded I was shooting too high and aimed lower. The thing jumped up and rolled over. On near approach found a very old human skull with two neat holes in the center of the top of the head and a third through the temporal bone. The grave from which this skull came was about twenty yards away. It is built up of flattish stones, none more than twenty inches in diameter or one hundred pounds in weight. The form is oval, its inside dimensions about forty by seventy-five inches. The walls are about eighteen inches high. If there ever was a roof, it probably was of wood or skins, probably largely the latter. Fragments apparently of a short sled, very rotten. Only one piece of any size, with four perforations probably for thong or whalebone lacing. I suppose this piece to be from a sled runner. The piece is about three feet long, the perforations about  $\frac{1}{2}$  by  $\frac{1}{8}$  inch. The skull is very fragile, especially after the shooting. There are only five teeth left, one an incipient wisdom tooth. From general appearance of teeth and especially wisdom tooth, conclude subject not an old person. No other bones or other remains found. Dimensions of skull, length, 167, width, 127. Skull too broken for other dimensions.

Pan. tells me Mary Thrasher is now a "bad woman." "In what way?" "She scolds all the time. Most women who live with white men get into the habit of scolding, contradicting and quarrelling." Pan.'s opinion of the Indians, whom her parents used to meet often each year, is that they are "nagomiut," excellent people.

The above description of the grave is from superficial examination at the time of the shooting. Later B. and I went there with spade. The general shape is as given above, so far as the grave is the work of man, but excava-

tion of its bottom shows that a crevice was chosen to build the grave upon, so that the body lay in an irregular shaped space considerably smaller than the box. The main axis of the grave is N. and S. (compass), the sharp point being slightly up hill and away from the sea. From shape of grave, conclude head of body must have been S., towards a narrow fjord about two hundred yards away. The bones give no evidence of position of body. Found lower jaw and part of femur together near S. end but found loose teeth all over bottom of grave as well as fragments of several ribs and two pieces of vertebrae, no whale bone found. Fragments of round bones found indicate breaking under teeth of some animal. Excavation showed plainly the grave had had a roof. At the N. end of the grave was a largish slab jutting out somewhat, the only part of the roof still in position. For the rest the roof was of thin (about one and a half inches thick) sticks, some split and others adzed into shape evidently by a small and very blunt adze, probably stone. On top of these had been small, thin pieces of brownish stone (the largest not over one inch thick or ten inches square) and sod cut with some sharp instrument. One that still retained its shape perfectly had one straight cut side and the other sides a gradual curve, as if sod had been cut at the side of a rock. The curved part came to a "knife edge" all around, the maximum thickness of the straight side about two inches. The brown stone slabs seem to have been under the sod, the rafters were lengthwise of the grave. The depth of the crack in which the grave was about twelve inches; so total depth eighteen plus twelve to thirty inches. On rolling them away, conclude that heaviest stones in grave weighed about one hundred fifty pounds a piece. Found about fifteen fragments of ribs (none more than half a rib, some splinters an inch by an eighth of an inch only) two fragments of vertebrae, the upper two thirds of a femur, with its head gone and one piece apparently from the pelvis, and eight teeth. No traces of hair or of rotten skins in which the body may have been wrapped; while enough sod and wood found to account completely for roofing of grave. A piece of antler (?) dimensions 19 by 7 by 6 by 5 measurements of smooth sides and sharp edges (corners); at one end looks as if broken off from a longer piece: Part of needle case (?) or end of belt (tapsi)? Walrus ivory. One side is somewhat damaged by decay. The figures, though they have elongated heads, suggest otherwise an Eskimo woman with a fairly large baby on her back.

*October 4.* Whaler's Harbor. Immaculate Conceptions. Pan. says Eskimo women frequently have children that have no father. Sometimes they die at or before birth, sometimes they live. When they live they do not differ noticeably from people that have fathers. Some women are afraid of these fatherless children and kill them at birth. One instance

of this is the woman Aklaátjiak who lives in one of Brower's "iglupauraks." A few years ago she had a fatherless female child. She buried it at once. Another Cape Smythe woman, Īnāvīna (she is bald-headed though not old) had a fatherless child. It died when one or two years old, of sickness. A Kuwök man who is now wealthy and a trader is fatherless. His name is Kǎx'ri. She knows of two Unalit women who had fatherless children. One had a boy and a girl (not twins), and the other a girl. Kǎx'ri's mother's name was Imō'sirk. She was a widow when he was born; she had had a girl before, whose father was her husband. Some women who have fatherless children are virgins at the time, some have had a child before, some are widows. Pan. herself has had a fatherless birth, an abortion at Olíktök last spring when she was on her way west with Billy and Anderson. The foetus was about three inches long. She never had connection with a man since the death of her first (only) husband,— a full year previous to the abortion. People do not suspect of lying, she says, women who say they have fatherless children, for they know that it often happens. Sometimes, perhaps always though people don't know it, some "doctor" is magically responsible for the child. This was known to be the case with Īmō'sirk, Kaxri's mother, and she foretold the birth of a son to herself at an "ulahula" long before Kaxri was born. It is not only in recent times, Pan. says, but it has been "always" this way, that women had fatherless children.

**Abortions.** At the abortion above referred to Pan. says she had no great pains but lost much blood. She seems to feel no reluctance in telling of the matter.

**Dreams.** Pan. says when she dreams a river with a swift current, a strong west wind follows; if she dreams the ocean rough with waves, there will be a strong nigirk (easterly wind). If she dreams of making "slap jacks" (but not other kinds of bread), the next day some traveler will come; if she dreams of eating deer-ribs boiled, deer will soon be killed. "Sometimes I dream well (true) and sometimes badly (untrue)," she says. She has heard of people who always dream true. Dreaming a swift river means east wind only to a few people, it means this or that to others. And so with other dream signs.

**Boots.** Pan. made herself the first boots I have seen made from the body skin of the deer. She says some people want only boots from deerlegs, others like boots from the body skin anywhere. Of course, the latter kind are always worn hair in. She says her husband Alashūk never would have socks made of anything but the upper half of the legskin of a caribou fawn, reindeer would not do. Upper half, skin from knee or hock upwards to where the hair gets long. A. would, however, wear any kind of boots.



*October 5.* Snowshoe lacing is said by Billy to be best if of seal; I have heard others say deer is better. The skin is cut in lacing about one tenth of an inch wide and is cut from the center of the piece. Then at one end of this cut, the cutting of the lace is begun, leaving finally an irregular fringe of skin. When skin is plenty, the cutting ceases when the continuity of the lace is first broken. Today we are making lace from the back of Billy's old coat and are cutting up all corners so some of our pieces of lace are not a foot long. A skin intended for lacing is put in water immediately after the deer is killed. In summer four or five hours suffice to loosen the hair so it can be rubbed off; in winter I suppose it takes a bit longer. When skin has once been dried this method does not work well. The skin is then usually plucked, fowl fashion, and then soaked to make it soft. The Eskimo do not seem to have the idea of shaving a skin with a sharp knife as Icelanders do, for instance, for shoes.

*Kágmalit.* Billy says that among his people, at least, and in most places probably, "Kágmane" is a less frequently used alternative form of "ka-va-ne" (in the east; down the coast). The people living to the east (along the coast only?) are called "Kágmalit," and (less frequently) "Kagmalirrimūt"; corresponding to "Kagmane" there is the term "shag-mane" (in the west). His people therefore, call the people of Cape Nome, etc., "Shagmanerimūt"; has heard Nunatamas call people of Tapkark, Kotzebue Sound, "Shagmailrimūt." His people never refer to people living eastward inland as "Kagmalit" or "Kagmalirrimut." Pan. says Nunatamas call Cape Smythe people "Kagmalit" and Mackenzie River people "Kagmalixihlaurat." The people of the Diomedes are called at Port Clarence "Immarxlit" while people living "west of the Diomedes, rather far off, on another island are called "Ökiövormūt." The "Okiovarmiut" Island can be seen from Port Clarence sandspit, but Diomedes can be seen only from Cape Prince of Wales."

*Bering Ice.* B. says though ice is continually moving people cross with light sleds and small or no loads between Diomedes and Cape Prince of Wales while Okiovarmiut can come to mainland only by umiak in summer.

Snowshoe lacing is usually dried on a double-cross frame. The frame is ordinarily five foot long between the cross pieces.

Skins for clothing are rated about as follows: sheep retain their hair best of all, but the skin itself is weakest of all; tame reindeer keep the hair better than caribou and are about equally strong, but somewhat smaller for animals of the same age. Squirrel is preferred to muskrat, because stronger. Swan plucked of all but finest down makes good clothes for children and loon unplucked breasts make a good coat.—Pan.

*Scraping Skins.* The "innermost thin skin" should be scraped off

with a sharp scraper; if the deerskin is then too thick for the purpose intended, "the next skin" should be rubbed off with a rough stone. Pan. uses for this purpose piece of slag (so light it floats in water) that we found on the Cape Parry Peninsula. Often, when skins are plenty, the neck is not used in garments wanted thin. If skins are not plenty, the whole skin may be given one scraping, and the neck rubbed with a rough stone to a thickness uniform with the rest.

Names. The name "Kōñ'nīrk," now applied to tame reindeer, is the one anciently applied to them when they were known only by the skins that found their way over from Asia. Kō'hliit or Kōñihlāxat," are the two names Pan. knows for the people across Bering Strait. The latter, she says, she supposes comes from their having reindeer (Kōñ'nriit). The wolf has these two names: A'marōk, Kī'rlūnīrk among all Eskimo, so far as Pan. knows.

Coats. A coat should have in its making one deerskin with the head complete. This skin is used for the back of the coat. The natural shape of the skin as it is on the living deer will then give the proper form to the hood, small patches being put in for the eyes, horns, etc., and perhaps a strip along the middle of the top of the hood, as well as along the cheeks, etc., to form the complete hood. If the head is on the other skin it is cut off and used for the patches where needed. In cutting a coat or other garment a good deal of material seems to be wasted, each piece (i. e., a sleeve) is cut larger than needed and not of quite the desired shape at first and then trimmed down. At first, fairly large pieces may be cut off, but towards the final stages the parings are almost infinitesimal. Some of the larger pieces will later be used to fill in here or there. Most women have a large bag full of these remnants and can from it match almost any kind of skin in mending or altering a garment. The final waste of material is therefore not great.

Boot Soles. Even when skins are scarce, the neck of the skin intended for a coat, if considered too thick after the first scraping, is not rubbed down with a stone (cf. above description of scraping skins) but cut off and used for boot soles, for one must ordinarily have boot soles as well as coats. The thickest and strongest deer boot soles are from the neck of a buck killed October to December.

*October 10.* Snowshoes. In piercing holes for the thongs of the foot-part of the snowshoe, Billy measures from front to back as follows:

- (1) Cross bar to first string, width of first finger at first knuckle.
- (2) 1st string to 2nd string, width of first finger at first knuckle.
- (3) 2nd " " 3rd " " " " and middle fingers at 1st knuckle.
- (4) 3rd " " 4th " " " " and 3rd fingers at 1st knuckle.

- (5) 4th string to 5th string, width of first and middle and 3rd fingers at 1st knuckle.
- (6) 5th string to 6th string, width of first and middle and third fingers at 1st knuckle.
- (7) 6th string to rear cross bar, rest of distance. Ugrug line is preferred for this part of snowshoe. The first and second strings are brought together in arranging the fore and aft thongs.

Aklak skins, Pan. says, are used by Unalit and others for umiaks and make a good substitute, though whether better or not, she does not know. On the Colville all umiaks are ugrug or walrus, even on the Kangianik (upper Colville) where some skins come from Noatak, some from Kuwök and some from Cape Smythe.

*October 13.* Wolverines. Pan. says if wolverine knows of meat buried under frozen ground, it will lie down on top the earth covering, thaw it a little, dig away the thawed part and lie down in the hole, thus finally thawing its way to the meat. As for stone covering, they will lift straight upward, if necessary, stones to uncover meat.

Aklak (bear) meat and fat, I find has to me a peculiarly disagreeable taste and smell when even slightly tainted. The meat of the big bear had begun to smell when we buried it, the fat layer, apparently, had protected body from getting cold, though skin and internals removed. When we cut it up and buried it in the rock (covering with stones only) it seems still to have kept warm so much so that middle pieces of pile were still little frozen when Billy opened the cache to take out meat Oct. 9th. Aklak meat, untainted, I like well, and the fresh fat, boiled, has a very agreeable taste. As fat, it is to my idea better than deer fat because it is nearly as agreeable and "goes" twice as far.

Aklak feet are like human feet because aklaks are descended from a woman who, with her two children, a boy and girl ran away from people and turned into bears (aklak). Pan. has also heard some story of polar bears.

Ptarmigan feathers are here a household necessity. One needs at least a bird a day for wiping greasy hands after eating, bloody hands after preparing fish or meat for cooking, or wet hands from any cause.

*October 17.* Horton River. B. was in completely treeless country, but west of the river almost every one of the innumerable lakes has small trees along its N. bank. B. found considerable flat land. I none. He found one "Large" lake on the barren with a creek to the river and Indian tent frames on the shore (hauled by sled probably).

*October 18.* I started 7:30 A. M. up river looking for ptarmigan. Billy made log deadfall at our camp and came along with load behind at

about 8:30. Found another Indian tipi frame about half mile up stream from our camp, perhaps three years old. B. found old deadfall trap about five miles farther up stream on W. bank and fixed it up. Logs cut with saw by Baillie Islanders, he thinks.

*October 20.* An Indian tipi frame seen about two miles N. E. of our deer meat, on edge of tree area. May be summer camp for deer hunt, though more likely winter camp for musk-ox and deer.

*Animal Lore.* B. asked me what sort of mouse it was I shot at the other day, dark or white. I said it was dark, which he said must then have been *aviña(k)pī'ak*. There is a white sort of mouse *kilañmiu'tak*. These have feet (hoofs) like a caribou and fall from the sky when it is snowing. He has not seen them in the country but has seen their tracks. Many other people have seen them, however. These mice cannot travel straight ahead, when they fall from the sky they run in circles and always run crooked. The *Kilañmi'útak* are a little larger than the dark mice and are usually fat.

*November 1.* Fish. Great excitement tonight over Pan.'s seeing two fish known as *títálrk* through hole she made to get water. She and Billy have been fishing for them most of time since but have had no luck.

*November 16.* Trade Across Bering Strait. Billy says his father made a number of trips in umiak to the *Xōd'lit* to get reindeer skins. Perhaps more frequently, however, the *Xōd'lit* brought their wares over. B. says in his neighborhood there are many ruins of houses built on top of cliffs for fear of *Xōd'lit* attack. This was very long ago; in more recent times visits of *Xōd'lit* were entirely friendly. Caribou have for a long time been absent from the rivers inland from Port Clarence, though Billy has seen numerous bones. His father told him he made one killing of twelve deer. This was when B. was a baby; now about 25.

*Ideas Foreign to Eskimo.* The value of time idea found currently among "civilized" people seems entirely incomprehensible to the Eskimo. If they can get a sack of flour for two foxskins from a trader two hundred miles away, then if that trader were to haul the flour to their village they would equally expect a sack for two skins. So I found the people of the Kittgaryuit neighborhood would expect the same price for each fish sold at home as they could get hauling to Herschel where they seldom arrive with over a dozen fish (say fifty pounds) and often with none. So in trading if they know a trader buys a rifle for ten dollars they consider it worth only ten after he has carried it two thousand miles, spent a year in doing so, and hired many men for the work. They will, however, of course, pay any price for a gun they need, but their thinking is this: "You have the upper hand; you are 'doing' me out the difference between ten dollars and what I pay you, but I must have the gun." One of the results of this view of trade

is that the advantage is all with the resident as against the itinerant trader. Those who make long voyages, e. g., for deerskins, lose from hunting the time they travel and usually have to pay what the skins are worth in their home neighborhood. When a man is known to get more for an article than he pays for it, the profit is looked upon after the manner of winnings in gambling, somewhat as we look upon stock exchange transactions. There is, in other words, no such idea as our "legitimate profit."

The wages idea such as they have is quite different from ours. Indeed, this might be considered as our idea misunderstood. If I hire a man for a stated sum or quantity of goods to work for me a year, if the day after I hire him he falls sick and is sick all the year and I keep him, clothe him and his family and care for them all as if they were my own people, all this is not considered in any way to affect my obligation to hand him at the end of the year the amount he would have received had he worked hard and efficiently for me every day of the year. A concrete instance I know of illustrates a variant of this idea. The man Kunnaluk was hired on these terms: he was furnished fifteen (or twenty) sacks flour, besides rice, beans, tea, coal oil, etc., a new rifle, and a thousand cartridges, tent material, etc., and promised certain things at the end of the year, if he should do as follows: trap energetically with (fifteen) traps furnished for the purpose, and deliver all foxskins, half his deerskins and sheepskins, and the saddles of all deer and sheep killed, to his employer. Kunnaluk trapped six foxes and sold the skins, ate the saddles of all deer killed, and used all deer and sheepskins, in fact, willfully and openly broke every item of his agreement. Now he expects to receive, and his neighbors expect he will receive, the things promised him at the end of the year. These views of wages and bargains have been fostered, perhaps engendered by whalers with other white men who have been so dependent on the service of Eskimo that they have put up with anything. A man who tried to do differently would become known as a "bad man" and the object of an informal boycott. Necessarily this paragraph applies only to Eskimo who have had considerable dealing with whites.

The rigidity of the triangle idea is, so far as I know, unknown to Eskimo mechanics. In lashing a quadrangular frame (as the rear end of a sled) to make it rigid, they will wind innumerable turns about the angles but never use a rope or string as a diagonal. That they never use a stick as a diagonal, I am not sure, though I have seen no case of it. It might be noted here that the Eskimo are the only Americans, north or south, who have ever employed the dome principle of architecture.

The cardinal points idea seems to be absent. There are words currently translated as "north, east wind," etc., but I fail to see they have any,

but a local relation to our ideas that correspond to these words. Their real meaning is "landward" "seaward," "up the coast," "down the coast," etc. Thus the word "nīgirk" means southeast wind at Point Tangent twenty miles east of Point Barrow, northeast wind at Cape Smythe or Wainwright, south wind in Greenland (West Coast — Kleinschmidt) and north wind (sailors have told me) at various points on Bering Strait. This fall nī-girk with us on the Cape Parry peninsula was a northerly wind. I have found no name for the North Star (though the Dipper is named) and no evidence that Eskimo have noted its peculiarity of no apparent motion. Traveling at night they often shape their course by a conspicuous star, but always make allowance for its motion, as they would for sun or moon.

*November 24.* Customs. Ilav. says the first time he killed a wolf was when wintering at Horton River (six or seven years ago) with Kaxotox and Kunnak. When he came in the evening Kaxotox's father said he must not eat cooked food or drink tea for five days. When he was going to drink water they told him not to until they made him a cup. K. made him a cup of sealskin from which he had to drink. All this, Ilav. says, was new to him. The old man said if he broke the rules he would, if he did not die, become very sick or suffer great misfortune the next year. Ilav. says he broke the tea prohibition before the five days were over, but did not notice being particularly sick or unfortunate that year. The old man, however, was much worried about him. (The old man was a Nu'natarmiut). That same winter when Ilav. came home one day reporting the killing of a polar bear, the old man said he must not work (chop wood etc.) the next day. He was also going to hang up to the roof of the house a crooked knife, but Ilav. would not let him. Said that he submitted in the wolf case because there he was ignorant, but that he had killed many bears without more ceremony than a grouse and had suffered no harm and he wasn't going to begin ceremonies now.

Game at mouth of Horton. When he wintered here six years ago, Ilav. says that they killed seals in considerable number up towards the dark days (as long as had open water) and bears now and then (five or six during winter. In both fall and spring got a few deer near the coast, perhaps twenty in all. Grouse fairly numerous in first willows up river, some straggling, waist-high willows three or four miles upstream from where B. and I crossed over it Nov. 17th. This man lived well all winter on ptarmigan only, shot and snared, never went up to rabbit country and got no fish so far as Ilav. knows. Ilav. went up near his house in February and got a heavy sled-load in two days' shooting.

Aklak Doors. Ilav. says only people who use them much and value

them highly are the inlanders (probably coincident with the users of willow and moss dome houses) and they use them primarily as house doors but also for tents.

Doors. Ilav. says when first he remembers his father's house had a trap door in the floor, but while he was yet a small boy Ilav.'s brother induced his father to put in a door of the style he had seen on a trip, a white man's door.

Food. Ilav. says he knows his people ate all the fur animals now trapped except wolves, but then he says wolves were very rare anyway and that it is possible they really had no objection to eating wolf, but none was killed when he was around and so he never saw one eaten. He himself, however, never thought of eating first wolves he killed, did not take carcasses home. Note: He did not kill a wolf till he had been aboard ships many years and had opportunity to absorb white man's prejudices. Many Eskimo are now ashamed of eating wolf, fox, etc., and lyingly deny that they or their people ever did, admitting always, however, that neighboring tribes did. In recent years Ilav. has eaten many wolves and likes the meat. Mamayauk has eaten all fur animals and objects to none.

*December 1.* Started 9 A. M., camped 1 P. M. on account of supposing we had arrived at small river from south, recommended to Ilav. at Baillie as a good rabbit place. Found no tracks, however. Near mouth (S. side of small river) were some house ruins perhaps ten years old.

*January 8, 1910.* Horton River. Women breaking bones today and we use some of tallow for lamp.

*January 28.* Langton Bay. Turnrak Beliefs. Tannaumirk tells: He has only once seen a turnrak. A year or two after he began to hunt with a rifle, it happened one full-moon evening that he and another boy went out of the house together. This was at Tuktuyoktok. The club house (kadjigi) was still in fair repair but not much used. When they came out of the alleyway door they saw a man standing near the kadjigi and took him for one of the neighbors. They did not speak to him as they expected him to come nearer, for theirs was the only inhabited house and they thought the man had come to visit them. But instead of approaching, he turned and entered the dance house. The boys expected he would soon come out and waited, and the man did come out in a few moments, but stopped outside the door and soon went into the club house again. The boys now became curious about what he was up to and who he was, and went to the door and called to him. No answer. They then went in, struck a match, and looked in every corner but saw nobody. They then went to the house and told what they had seen. No one but they had left the house and the people said it must have been a turnrak. Then for the first time the boys

became frightened. Up till then they thought of nothing but that it must be a neighbor. There were no tracks the next morning except their own at the *kadjigi* door.

*January 30.* People. *Pik.* has heard that formerly *Ikpikpok* was uninhabited, later inhabited, and says it is now again uninhabited.

*February 5.* Kayaks. *Kutokak* promises to make a kayak to sell us as soon as they get two more seals; it takes three fresh skins to make kayak.

*February 22.* Cape Parry. Use of Copper at *Baillie*. Copper was always rare for implement use at *Baillie*, *Kutakat* says.

*February 24.* Fishing Methods. In reading *Steensby's* "Eskimo kultur, etc." yesterday, I found the description for East Greenland of sealing through two holes in ice by two men, one watching, the other holding a long spear. Someone last winter (I think it was *Kadriviak*) described the same method for fall fishing. *Pikkalu* lived on the headwaters of *Kuwök* once, but never saw or heard tell of this method.

Inhabitants of Parry. *Kutokak* and others aboard the "*Rosie H*" told me the other day that the former inhabitants of Parry were one people with the *Baillie* Islanders and that one summer they all died of disease, except one who thereafter lived at *Baillie* Island. *Capt. Wolki*, however, says this is a new story. Both in former years and last summer he frequently asked *Baillie* Islanders who were the former inhabitants of Parry and always got the answer, "*A'-tju*," until after they got in winter quarters this winter, when he began to hear it from all sides.

Bows. Ships people gave me a bow picked up on one of the *Booth* Islands. A piece is broken off one end. It seems to have been about three feet long. It has evidently been a one-piece bow, but if reinforced, or how, one can't tell.

*February 27.* Travel. *Kutokak* says that formerly at *Baillie* an "*ümialik*" traveled with a string of five short sleds hitched one behind the other, and two dogs to drag the five sleds, separate traces. Plain men had one dog, usually.

Shamanism. *T.* says a few years ago *Taiakpauna* died and had been dead all day (about twelve hours) when *Alualik* undertook to resurrect him with witchcraft, and succeeded. Both are still living, *Taiakpauna*, a very old man, and "many people" saw *T.* die and knew that he was dead all day, and saw *A.* revive him. *Tannaumirk* asked me if *Jesus* was the only white man that knew how to wake up the dead. He said many Eskimo used to know how and to do it frequently. Many still know how, but dare not practise, by and by nobody will know because none dare to learn now for fear of not going to heaven after death. When I told him that I doubted if *Jesus* really did raise people from dead, *T.* said it was reasonable white men



should doubt it if they had no one who could do it, but the Eskimo understood how it was done by others and therefore believed Jesus could do it also.

*March 16.* O-kat. Eskimo Ways of Thinking. Ilavinirk told me three or four days ago that he himself is naturally of a skeptical turn of mind. He continually prides himself herein, without good reason. He is really the most gullible Eskimo I know. He had some private doubts of certain anatkut performances. He had made a ring of wood about the size of a napkin ring and had it inside his clothes. No one in the kadjigi knew he had it. He made an excuse for going out and dropped the ring in the dark hallway carelessly on the floor. When the performance was to begin, he asked to be one of those who held the rope. A long single thong of ugrug was brought, the añatkok tied feet together, hands behind back, a turn over neck and under knees, bringing his chin between his knees. Then Ilavinirk and another man took hold of the rope and braced themselves. Somebody lifted the doctor up and tossed him carelessly down the trap door in such a way as to have hurt any other man, but the añatkok never struck bottom. The line played out with terrific rapidity, so that it took the skin out of the hand of Ilavinirk who was going to try to hold the doctor. When the line was about all payed out, the strain ceased, and they hauled it in hand over hand till they brought the añatkok, bound as before, up through the opening, and behold, Ilavinirk's wooden ring was on the rope, just behind the shaman's back. He had made himself so small he had gone right through the ring and thus threaded it on the rope. He had turned natural size before they pulled him up through the scuttle. Ilavinirk concludes that though certain doctors may be frauds, this one certainly was not, and most doctors are not. In fact, no genuine doctors are frauds, but some unprincipled men pretend to be shamans when they are not. One such is Pannigabluk, as witness: When hungry at the river and impatient for me to come back, Pan. said she used to have seances for Alashuk's deer hunting, and it never failed to bring him deer. Ilavinirk says he knows "doctor business" is wicked, but they were in such straits that no means were to be neglected. He told P. therefore to go ahead. He and Mamayaux took part in good faith (i. e., did not work against P. by doubting her) and she announced at the end that her spirits (Alashuk and a white man) had talked of eating deer tongues tomorrow evening and had said Dr. A. and I would come with our whole party in two days. Ilavinirk was therefore to kill deer next day. No one arrived for a week. "We know now what sort of a woman Pan. is, and we'll not believe her in anything she says. If she had spirits she would have told the truth, for spirits know everything and never lie." Ilav. explained further he thought it was too bad spirit driving conflicted with religion but as it is, everyone must quit them for everybody wanted to go to heaven.

*March 18.* Women's Tutaks. Both Mamayaux and Tannaumirk remember seeing tutaks that were said to have been women's center labrets and that have been sold to the steamer people at McPherson. They know the common report that women wore them once. They are said to have always been inserted from the inside. The largest he has seen, Tan. indicates to have been about three-quarters of an inch in horizontal diameter as worn in the lip, one-fifth or one-sixth of an inch in vertical diameter and with an axis of about half an inch. Those he has seen have all been of white stone. Neither of them has heard any reason assigned for these tutaks going out of fashion.

*March 20.* Prejudice against Working on Sundays. Mamayauk is afraid to go today (to Langton Bay) as it is Sunday. Sunday is as taboo to useful work as work on deerskins is taboo the day after a white fish kill.

#### CORONATION GULF AND VICTORIA ISLAND, 1910-11.

*April 22.* En Route towards Coronation Gulf. We took spyglass survey first thing in morning. Saw pair of erect sticks to southeast and to make sure they weren't signals from our party (Billy, Pan. and Tan.) I walked southeast about four miles to them while Ilav. started north along coast with sled. Found remains of rack approximately five to ten years old, and frame of native umiak, carelessly made, small, and nailed with iron nails, evidently ships' natives. Ilav. went about eight miles north and camped.

*April 26.* Cape Lyon. Food Tastes. Tannaumirk eats only ugrug (bearded seal) when both it and bear (barren ground) are cooked. He says it does not taste so very bad, but he can't stand the smell. Old John, a German sailor with most of such men's food prejudices, says it is the "best meat in the Arctic" for it "tastes and looks just like pork." He does not like caribou, saying it is "watery" and prefers salt beef every day to deer meat even once a week for a change. All of us here prefer bear to ugrug except Tan. This is the first barren ground bear he has eaten, except some tainted and moldy bear meat he ate and liked at Langton Bay in January. He has eaten many polar bears and is fond of their meat. All the rest of us prefer barren ground bear.

*April 29.* Near Point Pearce. House Ruins. Besides the up-ended stones referred to above we found just west of our camp (one hundred yards) a wood pile, probably a grave which seems more recent than the houses on Parry or Langton Bay. Wood scarce just at our camp, so used earth. Billy saw three house ruins at the next point east. I shall look at these tomorrow.

*April 30.* On examining ruins found by Billy yesterday I found six house sites where he had found three, it was blizzarding then. The houses were apparently about rectangular, though the caving-in has given them a doughnut appearance. Interior dimensions of largest about eight by fifteen feet. There were found only three stubs of sticks sticking up that had apparently been parts of the walls. None stood over a foot above ground. Though none were over four inches in diameter, none were decayed enough to break with a sharp blow with the foot. Six or seven pieces of wood lying aimlessly about, none decayed badly, though lying on sod or moss. All good firewood. These may be more recent, of course, than the houses, the leavings of a summer camp, though no one would probably camp here after the ice goes off, as the boat landing seems bad and there is no wood for fuel, while plenty on the other side of the hill some two hundred yards away. Carrying wood there (plenty on the other side of the hill) would be difficult as it would be over a hill about one hundred fifty feet high; there is no beach around. No rafters seen in the ruins, or other sticks than those standing up as erect stumps, but these would be under the earth of the roof naturally enough. Fragments of vertebrae of small whale (bowhead or "inyutok") in walls of one house. Small rocks half the size of a man's head mixed with the earth of what had been walls. Highest portions of "doughnut rings" left by caving walls and not over eighteen inches, average a foot.

Houses seem somewhat older than the most recent at Flanders Point, Herschel Island, that are known to date back to 1890 only. These here, however, are probably much older. They are on a terrace about thirty feet above sea level and have black rock for a background. They may have been standing though not seen when Richardson passed. He says: "to the eastward of Cape Parry . . . we met with no villages, though solitary winter-houses occur here and there on the coast." (Searching Exp., Vol. 2, p. 348.) Doors of houses faced the east apparently and some at least had passageways six feet long. Mackenzie River houses are often a good twenty feet. Many things may have escaped me on account of snow covering them.

*May 1.* En Route to Coronation Gulf. Traces of People. At camp place found some cross-pieces for a sled that had never been used. They are of exactly the type found at Parry and Tan. says, are just like those formerly used at Kittegaryuit.

Beliefs concerning Caribou. Tannaumirk relates: In former times bull caribou when fighting would often get their horns interlocked and die thus or be killed. This interlocking may sometimes have happened naturally, but he knows that it was often caused by some chance watcher giving a

twist to his hood; i. e., throwing the hood back from the head and giving it a complete turn with the hand, as one would twist a wet cloth in wringing it. Pannigabluk adds that her mother once saw bucks fighting. She twisted her hood and they promptly became interlocked, but the prongs of the horns were not strong enough and after a struggle the ones that held got broken off and the bucks went free. Billy has heard of bucks being thus caught, but has never seen it tried.

*May 2.* Near Roscoe River. Village Ruin. Pannigabluk, in making a short cut where the sled went farther off shore, came upon a ruined village on a sandspit. She did not count the houses but thinks they were over twenty. There were numerous sticks upright, some the remains of racks. She says the village looked older than that at Flanders Point on Herschel Island. If our camp was yesterday at Roscoe River, then these houses would be about five to eight miles east of it by her account. Driftwood in large quantities at this village site, she says. Saw two or three "up-ended" stones inland.

*May 2.* En Route to Coronation Gulf. Sleds. On seeing accidentally the picture of a "kutchin" sled in the frontispiece of Richardson's "Second Journey" Pan. and Billy both said it was like a Kuwûrmiut sled, P. said "just like"; Billy said he had seen most of them with the rear end a little lower in the runner bend than the front end. He has owned one sled bought in the Kuwûk "for a rifle, when rifles were yet valuable." It was longer than any sled he has seen at Herschel, though some of them must be sixteen or eighteen feet long. Kuwûk sleds never had shod runners, neither did they, he says, ever shoe them with ice or ice them even slightly. The runners were of ūrūrri'lik, or canoe birch. It was the best sled he ever used for snow, but very poor crossing ice.

*May 3.* Eskimo Cleanliness. Certain remarks and deeds of Pannigabluk's today prompt me to enter certain things about Eskimo cleanliness, etc. Pan. will clean dog excrement off a sole of a pair of boots with her ulu, wipe it casually with a rag that may have had as bad uses a dozen times before, and then proceed to eat with the ulu or cut up with it food for cooking. She will not use the same spoon twice in a half hour to stir her own tea without wiping it between times with the same rag, if it so falls, with which she has just wiped the ulu. Most of the Eskimo I know will pick up and eat without concern a piece of blubber, cooked meat, raw meat, fish etc., that falls on the floor, no matter in what state the floor is, but most of them would throw away a piece of bread that dropped in the same way. I noticed this especially in Roxy's house. He has been with the police a great deal, and seen them throw away such pieces; naturally, they less often would drop meat, etc., than bread, besides meats are native foods and the

customs with regard to them are of long standing. In times of scarcity they will eat their own foods to the last scrap and take pride always in a clean picked bone, but I never saw a bacon rind eaten, nor even shaved close in time of necessity. E. g., I gave bacon to Kunaluk's starving family last spring, he threw away nearly a fourth of the bacon with the rind.

Most Eskimo wash religiously every morning. Usually, they soap profusely and leave it unrinsed on the face. Few of them seem to care if the water is dirty. In Ovayuak's house up to twenty would wash from the same water or until the dish was empty. Then the towel passes around, the same for months, and occasionally a nose blown into it incidentally.

On my telling Pan. one day that certain water was dirty she said that was no matter, she was just going to wash the teapot inside with it. I am considered a sort of renegade because I insist on the teapots and my own cup remaining unwashed. I have often heard my natives tell strangers that with many good qualities I have the failing, differing thus from most white men, of caring little for cleanliness in my food utensils. That I prefer manifestly dirty dishes to apparently clean ones in an Eskimo house, is considered a curious eccentricity; some seem to think it is "put on."

Pan. will sometimes wash a pot thoroughly with an ancient dish rag and then use the water to make soup. She will hook with the dirtiest finger to the bottom of a cup of tea or water to get a deer hair, of which she conceived me, in common with "all" white men to be in horror, in spite of my protests that I rather am fond of hair in my food. I have known no Eskimo to contract the white man's horror of hairs in food. As with us, white cloth garments must be washed, a dark one may be as dirty as it will.

Songs. Eskimo songs seem to need explaining. Tan. knows a great many, most of them composed by Ovoyuak or others he knows. When he sings them he always explains after the song what it means — "what it says" (i. e., *gōx*). Then he sings it over again after telling "what it says."

*May 4.* West of Point De Witt Clinton. Sled. Billy improvised out of the bearskin a sled of a type new to me, except from hearsay. He merely laced it into a bag and attached the bag by the head-skin to the rear end of our sled. On level snow its two hundred pound weight can be pulled by a small dog; on glare ice it is a bit sticky; in rough going its weight comes in play, of course. To have this behind the sled rather than on it may or may not increase the average hauling weight, but it is a convenient way, and I am afraid of two hundred pounds more on the sled, a breakdown would be serious.

*May 8.* Near Crocker River. Songs. Pannigabluk sang today a song consisting chiefly of a repetition of *atōyōa kēnōyōa* which she says she learned when young among the Unalit. This song has an irresistible

tendency to suggest the music of "The Darling of the Gods" which I suppose to have been based on Japanese melodies. I have noticed before that she sings songs much resembling the one Indian tune heard all along the Mackenzie. This, too, she says, is Unalit.

*May 9.* Point Wise. Traces of People. At almost every place where we have camped or cooked we have found sticks, split pieces of sleds, etc., but all uniformly very old, any or all might have been half a century or more. Have found two bed planks from a snowhouse and about the last of April or first of May, a single stone tent ring. Tent might have been round or square, and about eight feet in diameter. On thinking about it, a log evidently chopped by white men seems rather mysterious. We found it May 7th. The lower and upper end were chopped with a sharp ax. The log was about fifty feet long, four inches in diameter at upper end, ten inches in diameter at lower end. An eighteen inch section (stove length) of the lower end was almost chopped off in a manner rare even with Mackenzie Eskimo. The cuts might have been eight or ten years old, but the strange thing was that the marks seemed not to be at all much water-worn. The snow was deep around the log, but I much regret now we did not make a search for chips, as the log seems to have been chopped *in situ*. It can hardly date back to Dr. Richardson's time.

Today, at camp time, we came upon the first fresh signs of people, numerous choppings with a dull adze into pieces of wood, logs, etc., apparently to test their quality, as if searching for sled or bow material. Consequently everybody excited and in good spirits. Marks seem to be of last summer. One would suspect they were made by Victoria Island rather than Coppermine people, for they were evidently in search of material for artifacts.

*May 10.* Point Young. Stone Graves. Numerous adze choppings, some last summer or last fall, for a mile after leaving camp. No good timbers and few adze marks Pt. Young (?). Drumstick and other artifacts at Pt. Young, most recent, at least five years. Seven or eight stone graves seen on ridge by our camp here, ridge of broken rocks about twenty feet above sea and two hundred yards or more from it, parallel to beach. Old rock caches in numbers near beach, but no house signs.

*May 10.* Point Wise. Traces of People. Adze choppings at camp here so new they can hardly be distinguished from our own choppings into the same stick. An old broken stone kettle found near camp on Point Wise.

*May 12.* Point Hope. A Deserted Snowhouse Village. Saw tracks of two men with a sled getting wood from Point Hope. Camped tonight at a deserted snowhouse village. There are over forty houses, how many more I do not know; part of the village is completely snowed over under the cut-bank. All seem to have had skin or gut windows, the window directly

above the door, and the door usually facing south, though in some cases north. Every window about twenty by twenty inches. Were in one house, about seven and a half feet high inside, ten feet in diameter, and with a U-shaped bend along walls, facing door about fifteen inches high. This, Tan. says was the support for the bed boards laid across the house. Seal and ptarmigan leavings; food plenty, as sealskins lying around, dogs would eat them if hungry. People evidently came for wood, from Victoria Island. Houses about two months old, or less. One sled trail fresh, not over two weeks. It comes from the east and follows main trail north towards Victoria Island.

*May 13.* Following Trail of People toward Victoria Island. Started 2:30 P. M. on trail of people leading towards Victoria Island after moving Pannigabluk who did not want to go and then camped east about half mile to some wood. Main trail perhaps two months old and hard to follow, but one new sled track, about two weeks. At about 4:30, some eight miles from our camp came upon a village of houses, which showed by fish spears, etc., that people intended returning. From roof of one house saw with glasses three men, some three miles northwest, sealing evidently. Headed for nearest. Before getting to them, saw a deserted village about in our former course, 320° by compass, some five miles from one first seen. Getting near first man B. and I halted team while T. went ahead to try not to frighten him by all approaching. The man sat on his snow seat bent forward as if watching for seal, occasionally raising his eyes only not his head to T. When T. got within some paces man suddenly stood up, seized an iron snowknife that lay on the snow beside him, and poised himself as to receive an attack or to be ready to spring forward. This scared T. and he went no nearer, but started to talk. The other never smiled or paid attention for some time repeating monotonously (about twenty times a minute, as often as one breathes) ha-ha-ha-ha, etc. Evidently he at first understood nothing of what T. said, but he soon began to. Then he began talking and T. did not understand. T., however, knew from Kalakutak (who was both with Mogg and Klinkenberg) a Victoria Island phrase; a-li-a-nait-tū-aral'-u-īt (they are good) which he then used, and showed by lifting his coat he had no knife. After about five minutes of parley Igxslirkī laid down the knife and soon after began an examination of T.'s clothing, which seemed to satisfy him we were harmless he had probably heard of "calico" from Victoria Island people. He then told T. to tell B. and me to follow a little way behind while he went along a line of sealers to tell that we were alianaituaraluit. We came near forgetting to remove our goggles. If we had, I don't think our first meeting with these people would have gone well. The village proved to be southwest about three miles, we had gone past it.

When we arrived within a hundred yards of the houses, they asked if we would camp near them, or a little way off on account of the dogs. We preferred to be a little way off and as many as could get at it turned-to to make us a snowhouse.

Victoria Island. Snowhouses. Snowhouse building differs here somewhat from the Kittegaryuit who build in a regular spiral from the ground up and cut the snow usually outside the house. Here the snow is probed with a probe about four feet long to see if it is good quality down to the ice and the ice level. Blocks are then cut from the floor of the house first, and so as to have their transverse diameter vertical. The Kittegaryuit are particular about the size of the blocks having them about uniform. These cut blocks any shape and size, some like a "four square" timber and anything from a foot to four feet long, some squares, some triangles, etc. The wall is not started in a spiral, our north wall was well up when someone else started the south wall equally irregularly. When the roof part is in construction the blocks are more regular in shape and of more uniform quality. There was not enough snow in the floor for much more than half the house, a few blocks were spoiled for the snow was not good. The house was about circular and about eight feet to the dome, diameter about ten feet. Outside to a height of about three feet, a second wall is built outside the first, about eighteen inches from it, and soft snow thrown in between. An oval shaped hallway about four feet high was built southwest and just east of it a rectangular shaped door cut about three feet high and two feet wide, through which snow blocks were passed in. When house was finished this was walled up and a new door arch-shaped about two and a half feet high, cut in from entry. The sleeping platform is built of the pieces that break and of new blocks passed in to front it, with loose snow shoveled over. In our case the platform is about eighteen inches, but I have seen it two and a half feet, in which case it consists of a horseshoe-shaped bench left or built around the wall and boards laid across.

All the people seem to carry with them dwarf willow for bedding and their skins are polar bear, seal, and deer. The lamp is on a platform usually of two parallel bars two feet above the floor and resting one on a piece of snow on edge, the other on a bar at right angles also stuck through the wall. This is about eighteen inches above the lamp stand and from it is swung the pot, while above is a long narrow frame for drying socks, etc. In front of the lamp is a sideboard from twelve to twenty-four inches wide on which rest the ulu, dipper, pieces of meat to be cooked or that are cooling, parings of blubber trimmed off too fat meat, etc. When this gets pretty well littered it is scraped clean, the litter being pushed over the back edge of it and falling in a pile about under the lamp. This is periodically gathered up for dog feed.



When our house was built and the bedding in place, some half dozen men had sent to their various houses for contributions of cooked, or if there were none, uncooked food.

*May 14.* General Characteristics of the People. The people, as Mogg's and Klinkenberg's people report from Victoria Island, are apparently of superior type. They look clean as compared with Baillie, for instance, and are models of good behavior. In fact, have manners towards strangers such as I do not suppose any white men have ever honored themselves by showing to any branch of the Eskimo race. There is interest, but no forward curiosity shown with regard to all the strange things we have and do; no laughter at a dialect which must seem funny to them; the greatest courtesy in everything,—the best seal for the visitor; the first choice of food; continual expressions of friendship; no questions as to why we came. No spitting out and calling "bad" food we give them to taste, though all say "We are not used to it and do not like the taste." The same with smoking. "We do not expect people from far away to have no manners different from us, so go ahead and smoke," but several have had to leave the house when T. and B. smoked together. Continual invitations to come and eat though they are short of food, got three seals yesterday for thirty-eight people, an average catch, and continued bringing presents of blubber for our lamp and meat to cook, small pieces, for there is little to give. The snow today keeps melting in holes from sun, and each house is carefully patched as it appears, our clothes are carefully brushed of the least particle of snow in entering a house. One could particularize endlessly, but the sum is courtesy and good breeding with generous kindness.

*May 14.* People at Cape Bexley. At Cape Bexley last winter there were three groups of people joined these, who hunt in summer invariably south from Point Hope "toward a lake that is like the sea for size," a Victoria Island group bound up the west coast this spring (they are supposed close now), and a Victoria Island group (now "far away") who belong off the mouth of the Napaktulik (Coppermine River). No one here has seen the Nagyuktogmiut, but they say they are excellent people, which encourages our party. There must have been over two hundred people at Bexley, to judge by the snowhouses.

*May 14.* Use of Copper. There is probably not a single copper implement here, though some ulus etc., are nailed with copper rivets.

Iron Implements. Their iron comes from the "Uallirmiut," whose location is not yet clear to me. They have iron pots, frying pans, snow knives, etc. The knives are all made by themselves, apparently.

The language resembles Kittgaryuit more than any other dialect I know, yet some things remind more of westerners, as "hamma" in both for

"tjamma" in Kittingaryuit. I have this advantage, too, that when B. or T. identifies a word, he at once changes its pronunciation into the form of his own dialect, while I try for the local. That I speak something like T. is shown by the fact that they were unanimously agreed T. was my younger brother, and that he was not full grown "because he is so much smaller than you, and brothers are often similar in size."

**Method of Wearing the Hair.** The women do not braid or apparently tend the hair much, but I have seen only one woman (no man) who apparently is lousy. The men cut the entire top of the head close in a horizontal line a half inch above the ears, and wear the back hair loose.

Both sexes use the hair frequently for toothpicks, in manner of "tooth-silk." This I have never seen before.

**Tattooing.** The women, most or all, tattooed. The lines down the forehead are (the two) everywhere equidistant (about  $\frac{1}{4}$  in.) from each other, go half way down the nose, and are, the inner, one inch, the outer  $1\frac{1}{2}$  inch, apart where they end at the roots of the hair. The only old woman here has her forehead bald an inch or two back, and the lines end where her hair formerly ended. The eye design varied. The cheek lines I have seen did not vary. They extend from nostrils slanting up to ear, meet at nose and are about quarter of an inch apart at ear. The chin lines I have seen varied from five to seven and equidistant in pairs.

**Clothing.** The clothes are of the general style of those I got from Mogg (Victoria Island — Prince Albert Sound) but vary greatly, no two being quite alike. The swallowtail is usually to knee and never below calf of leg, and from six inches to fifteen inches wide. Some coats are cut about as our "frock" coats. One has almost a horizontal lower line and reaches almost to knees. The sleeves are generally short and the mittens not quite to wrist, leaving the wrist bare, all but snowhouse-building gauntlets. The pants and coat barely meet in front, typically, and when one reaches arms above head the abdomen and chest are bare from an inch or so below the navels to above the nipples, for the coats are very badly cut at the shoulders, — for a man about a foot broader than the wearer. On some women's coats the shoulders are nearer the elbow than the shoulder. Outside their pants, the women wear two huge pairs of leggings fitting loose around the thigh suspended from a belt. They must fill with snow in a blizzard. Both sexes wear slippers over leggings. Two men froze to death last winter, old men following the trail behind a party. It is a wonder half of them don't freeze to death.

**Tattooing.** The most common number of chin lines is five. The lines are in general quarter of an inch apart at top and half an inch at bottom, being all curved but the middle one. They begin about one-half inch below

edge of lip mucous and end where they would disappear from the view of a person whose eyes were on a level with those of the wearer. The hand designs seem to be unlimited in number and form. A rather common one is an M-shaped figure across the back of the hand. The back of the hand is pretty well covered. The arrow-heads at the eye angles decrease in size backward from the eyes generally. The point of the arrows is somewhere between the line of the angle of the eye and that of the upper brim of the lower eyelid when the eye is open. The cheek lines are parallel till about two inches from the nose, when they converge. In one case they do not meet. The nearest arrow point is about in the wrinkle, usually, of the angle when the eye is closed tight. The inner of the forehead lines meet and end abruptly at the line of the inner ends of the eyebrows; the outer meet just below angle of eyes at top of nose and are prolonged down, Y-fashion to the middle of the nose. Have seen no tattoo on men.

Complexion. The complexion is a good deal darker than our two men, who have been much outdoors, though the ice may sunburn more than the shore. Some are as dark as half-blood negroes.

Hands. The hands are typically Eskimo in general, but one woman (twenty-five or thirty years, approximately) has the long fingers that I have seen only in half-bloods. She has no other marked non-Eskimo characters.

Term used for "white man." "Kablunak" is used here for "white man." This is the first locality I have been where it has an apparently respectable standing. The western people know it only as slang, on a par with taksipûk. Tan., who has never worked on a ship, did not understand it when used to him last night, and only when I explained it today when he did not yet get its meaning from their talk.

Blubber Eating. The people here pare off the blubber from fresh seal meat too closely to suit me, or any of us. When I asked for parings (pared off after boiling) they were surprised. I have not seen them eat any blubber or oil, but they evidently expected me to prefer the raw. I have seen no "sour" oil. All Eskimo I know (till these) set forward an oil pot, fresh, if there is no "sour" at every meal.

Needles. The needles I have seen are all made by Eskimo. They are of the "glover's" type and vary in size from darning needles to "glovers No. 3." Some have a smaller eye than "glovers No. 3."

Lamps. The largest lamp I have seen must be forty inches long and weigh fifty pounds. The largest pot is about thirty inches by eight and eight inches deep, flat bottom.

Windows. Windows are not in use now, though all the abandoned houses we saw had them, both on shore and the two sea villages. Evidently they are to catch the faint light. Either ice was never used or else sledged away to new houses.

“Modesty.” Have seen no signs of the sexual hospitality which MacKenzie Eskimo have told me was part of ordinary courtesy to a guest.

Skin Diseases. Several persons have sores now, mostly on the hands, though some on eyebrows, forehead, and one in the scalp. He has hand sores too. Where this man's hand sores have healed there are little elevations, almost like warts and lighter color than rest of back of hand, about color of palm. The one now open is circular, like a conical pit, about one cm. wide and half a cm. deep. It is red, perhaps from plucking off scab, which seems a habit. It is not apparently a “running” sore, nor yet is it dry, about as moist as our lips.

Names. Names are given here with a freedom not found to the present to the westward, even among people who have worked on ships. Among Kittegaryuit people, the name is never given you by the man himself when you ask him, but always by a bystander, here each as he first sees you says: “I am So-and-so; what is your name?” When we arrived here, Tan. had to repeat his name to every man as they went along the line of sealers, each sealer giving his own name in return. After we got to the village, those who had not seen us before always gave their own names before asking ours.

Manner of Speaking. The voice is kept much lower and the manner in telling stories, conversing, etc., is quieter than that of any group I know and contrasts especially with the Kittegaryuit.

Opinions of other Groups. Contrary to all groups seen before, they speak favorably of all those people of whom they have any knowledge. They seem to have no knowledge of Avoak or Kittegaryuit. Of the Itkilliks they know, but they say “We do not know what sort of people they are, for we have never seen them.”

May 15. Dancing. Dance house built today in our honor. The dance house has its floor on ice level, is about fifteen feet in diameter and eight feet high. It is full six feet in height a foot from the wall, i. e., the roof very flat. In building it, two temporary doors were used on opposite sides. As with all houses, the door faces south. The hallway is about half the usual length, about five feet. The door is a trifle higher than ordinary. There are no seats or benches along walls. People stand in complete circle, some boys in the front row, “so they can see.” All the men and about half the women present. No special place for the women. A circle about five feet in diameter left for the dancer in center. There was no drum, but their bewailing its absence showed they ordinarily use it. They said: “We almost never dance. We have no drums *any more*.” This would imply the dancing on decline. The dance now was entirely perhaps at Billy's instance.

Most of the dancers assumed being very tired or overcome with languor from heat, they cast their eyes down and the hand dangled lifeless at the

wrist. They sang in general with the chorus, there were words to three-fourths of the song and in some cases the dancer used words while others accompanied him without words; in other cases he añaya'd while others used words; in still others he danced silently while others sang. In a half dozen cases the singer made a mistake, used words when he should not have joined the words of the chorus, etc. In each case he was "jogged" by one or another, and one who failed to hear first correction was tapped on the shoulder to draw his attention. This was all done in a jocular way, each mistake causing laughter, corrections given and received about with same spirit as in a "set" at a country dance.

One dancer Iglíxírk, danced about in Kittegaryuit "doctor" style. His movements quick and often violent, his facial expressions at times diabolical, his shouts earsplitting and evidently intended to frighten. At intervals he would suddenly face some one and ask: "Who am I?" This always of one of us visitors. "Am I a good man?" etc. (il-yër-a-nait-tok). Occasionally, however, he dropped the dance manner and smiled as pleasantly as his Mephistophelian face allowed. At a set point in his song, everyone joined him in a half dozen movements bending at hips and knees. Both my own knowledge and Tan's verdict show this performance to be one not essentially different from the Mackenzie River type.

Trip to Victoria Island. After the dance we had supper of seal meat and blood soup and then started in search of the Victoria Island party that was supposed to be near. One man, I can never remember his name, one of the prominent men, came along, saying, "When you come near, I will run ahead as a herald (kivrarniaktuña) and tell them you are good (harmless, friendly il-yëranaktüsi)." Leaving at 9 P. M. "We always travel at night in the spring," our companion said. He did not want to start earlier than we did. We first struck east about six miles when we found a deserted camp. The trail from here led north about five miles to another abandoned camp about a week old. Here the trail was a trifle north of west about five miles to the present camp (four houses, three with sealskin roofs, one all snow) which lies about two miles east of Tulugak some ten yards from shore on a low bit of coast. We had therefore traveled in a U curve.

When a half mile off we stopped the sled and our friend ran to the houses. He darted into one after the other, and in about two or three minutes the men began to come out. After a few words, all started looking to the dogs, securing those not already tied. Then a shout was raised for us to come, and our friend came running to meet us. When about two hundred yards off the village, men and boys, all in line (not in file) started slowly forward to meet us, holding their hands above their heads and calling out at intervals, "il-yër-a-nait-tu-ru" "nam-nak-tu-rut," a word not heard among the

Staypleton Bay people "We are made glad by your coming," etc. When near, we each were asked to pass along the line from our right to left. As we came opposite each in turn he gave his name and we then repeated ours. This was done even with boys not over eight years, though the boys were fallen out of line before the introductions and being introduced to them seemed more or less optional. A snowhouse was then built in the Staypleton manner with the door south and we cooked some milk. They had all been asleep and the seal meat frozen, so they said they would not be quite ready yet. We were then taken each to a separate house, where we introduced ourselves to the women, they giving name first. The meat was cooked, we had a sort of midnight supper. Had arrived 3 A. M. It was now 6 A. M. and then all went to sleep again.

**Relations with Other People.** There is living here a man belonging to the Nagyuktogmiut. Several of them have brothers and sisters living now with the Staypleton group. They have, at present at least, less to do with people along the west coast, the first of whom are now supposed to be, as they habitually are, on the ice of Prince Albert Land. These will hunt the summer to the north of the Sound. With the group that have gone east this spring and belong off the Coppermine, they have frequent relations.

**Knowledge of Land, Victoria Island People.** This group has names for all points and rivers on the mainland to Cape Lyon, but not beyond. They also name several points on Banks Island (including Nelson Head?). Banks Island, they say, is uninhabited, though the Prince Albert Sound people occasionally spend the summer there, crossing by sled in spring and fall.

**Cooking.** There seems to be very little uncooked meat eaten. I have seen two cases among Staypleton people of a single man at end of a meal asking for a piece of frozen meat because he had not had enough cooked meat. Tan. has seen one meal where frozen meat formed "a course." Today our dogs were fed cooked meat, "For," they said, "meat frozen hard is not good for a dog."

*May 17.* **Food.** Had my first meal of frozen meat today, an emergency one when our guide came into a house. There must be a meal whenever one of us visitors goes into a house. Two men present refused to join, a thing I never saw with boiled seal. I liked it better than frozen deer. When a trifle high I prefer it raw to cooked.

**Clothing.** Clothing here same as at Staypleton. Mittens have hair in on palm and thumb. Long blouses of seal or deer slipped on when wind blows or build a snowhouse. Tails vary in length from middle thigh to middle calf, and in width from six to fourteen inches. Some meet body (waist) of coat at right angles, are of equal width all the way; some curved as much as to middle of each side of coat. Deer's ears form ventilating

holes to hood. There is a slit about half inch into tip of each ear, possibly ceremonial, on killing deer.

**Kayaks and Umiaks.** Kayaks and umiaks are not made now by either Haneragmiut or Akuliakattagmiut, though some have had kayaks in recent years who now have none.

**Use of Bows and Arrows.** They do not spear deer but shoot them with bows. Billy was mistaken yesterday about Koñõittok's aktlak. He told me today he killed him, with arrows only. This aktlak he told me today was a very light color, yellow, quite different from any I have seen killed, though similar to one we use for tent door and I got from Capt. Pedersen at Barrow, from Icy Cape, if I remember right.

*May 18.* **Counting.** I have heard of Eskimo being unable to count beyond six, but this is my first meeting with that fact. There are seventeen people here and after careful conference they showed me on the fingers of three hands, do not use feet as Mackenzie do, there were fourteen. They had no name for this number and on being pressed, none could count beyond six. A-tau-hĩrk, ma'l-lrök, pĩñ-a-hsut, hĩ-ta-mat, ta(d)l-lĩ-mat, arr-vĩn-ñran. A half hour of trying by Billy and me could not induce them to count at all, unless objects were in question, as our dogs, or theirs, the size of their families, etc. They would not count their fingers, deeming it useless, I suppose, their number is well known.

Entering a house, everyone except members of the family utters a series of sharp exclamations from the time he stoops to enter the alleyway till his head is inside the door proper. The first to come to our house each morning always comes singing loudly; also, when no visitors known to be with us, while yet at a distance.

**Hanirkarmiut Houses.** Skin roofs and snow walls are used in the spring by the Haneragmiut. Have been in use since they came ashore here some eight or ten days ago. There is a ridge pole some three feet shorter than the long diameter of a slightly oval house, supported on X sticks and lashed to them. These sticks incline a little, in pairs, toward the center of the house. The rest of the rafters, of which the ice pick is always one, are either from the wall to the ridge pole, or from wall to the X sticks, whose end sometimes, and sometimes not, sticks out of a hole in the roof. There are generally three rafters from wall to X sticks, the middle being to the crotch. The tents are preferably of deerskin but only one here is wholly of deer. One has a gable of aklak and another is mostly of sealskins, dried, laid shingle fashion. The hair is turned in. In summer they use tents similar to the house roofs now in use. One man here has not enough skins yet, and still uses a snow roof, which is poor now, as the weather is no longer cold.

Use of Iron Implements. Iron implements are universal here as with the Akūliakattagmiut. These they say come from the Uallīrmiut, or Uallinergmiut, who wintered to the north, beyond the Kañhīryuarmiut in a huge two-masted umiak. They do not seem to identify these with kabluñā'k who are probably known only by hearsay from the east, unless the middle-century explorers are remembered as such, but of memory of them I find no trace. I cannot make sure whether most come from Klinkenberg or Mogg, though I recognize, I believe, some of Mogg's canned beef tins. None of the Hanéragsmiut saw either ship, and I am not clear if they realize there was a ship more than one winter.

Misinformation concerning Knowledge of Ships. Billy misunderstood the other day that a woman who was telling about the two-masted umiak had been to one of the ships. On close inquiry we find neither she nor any other of them was, but they have all their information from the Kañhīryuarmiut, some of whom were at the ship. It seems the Kañhīryuarmiut seldom come down here, they probably made a trade expedition after meeting the ships, who, as is whaler habit, immediately glutted the natural market, expecting later, I suppose, to create an artificial one for tobacco, matches, firearms, flour, and perhaps whiskey.

Outside Influence on Eskimo. Outside influences seem to be as slight and indirect here, therefore, as one can find among the Eskimo or perhaps anywhere in the world. This would be a good place to stop therefore, and we might do so.

People to the East. The Pūñlīrmiut are said to be on the south shore of Victoria Island this side the Nagyuktogmiut, and both are said to be numerous. Then there are (account of Hanbury) the group from Bloody Fall to Krusenstern, the people (Hanbury) of Gray's Bay, and the ones seen by Lieut. Hansen at the southeast corner of Victoria Island, and probably Victoria Island people west of these on south coast and possibly some in the islands of Coronation Gulf besides those of whom we have heard. All of these are about equally untouched, and the Akūliakattagmiut are on our home road to be easily seen again.

*May 19.* Dogs. Dogs are not numerous. Most people have two dogs and the largest number I know of is four. They are on an average about fifty pounds if in flesh but are rather thin now, though not skinny. They seem to get nothing but bones and blubber and not much of the latter, judging by how greedily they eat when fed, a dog soon is satiated with blubber. At Haneragsmiut there were fourteen dogs to five families. Here I have not been able to count them. The color is generally black with light spots over eyes, a stripe on breast and belly and often white hairs in under side of tail, with white tips. But there are many other colors from roanish gray to black; would pass for mongrel farm dogs, any of them.



Western People. One woman says her mother was from far west along the coast of the mainland, this side Lyon somewhere, I suppose.

Starvation. Pan. has heard of two people who starved to death "ai-pani" "when there were no seals in the winter." Two old men froze to death this winter, possibly we suspect, partly from hunger.

An Accident. A man here, Kūdlark, when shooting at deer last summer, shot past accidentally and killed his younger brother, an adopted son of Aialuk (the Aialuk living with Akuliak).

Haneragmiut. B. also misunderstood that one of Haneragmiut was originally from the Nagyuktogmiut. He had not even been to their country.

Akuliakattagmiut at Cape Bexley. Left Akuliakattagmiut camp at 4:45 P. M. and got to our camp about 6 P. M. Their camp is about eight miles from the northwest corner of the Cape Bexley peninsula (the land one reaches first from Point Hope) and bears about 300° magnetic. Since leaving shore, some time after the sun came back, they have had three camps, the first about five miles east of the present, and the other some four miles farther north and half way between first and present camps, apex of isosecles triangle.

Cephalic Measurements. Cephalic measurements taken of all women when they came for present of needles and most of the grown men. No boys came at my call for all the village, and I did not want to press it. They all seemed restless after novelty of first few measurements wore off, so I did not venture to try their patience on stature, etc. Photos of group worried them too, so took no individuals.

May 20. Houses. At Hanërak, four to five families and seventeen people; among Ak. thirteen families and 38 (?) people. Three with skin roof at H. No skin roofs used yet by Ak. Perhaps difference due to fact H. have moved ashore.

Contact with Explorers. What I know and what they know leads me to think as they think, that neither they nor their ancestors (Akuliakattagmiut or Haneragmiut) have come in contact with any of the middle-century explorers. I think it worth while therefore to give more space than already given to a description of their manners, etc.

When I presented some needles to the women they all wanted to pay. This I declined on the ground our sled was too heavily loaded already (as it is); I told them that when we go home I should be glad of anything they give me. Pan. and Tan. had, however, received while B. and I were in Victoria Island several presents of sealskin, bootsoles, slippers, etc. Their interest in us continued to our leaving, though only the men (all I think) came to see us off, helped load the sled, etc. B. and T. had explained when people parted as good friends they always shook hands, so of course it was up to

me to shake hands too. I regret having been forced to plant here the seed of this to them thoroughly foreign custom.

Difficulty in obtaining Information. We had great trouble in getting any information out of them. They are far from garrulous. Our many inquiries as to where the Nagyuktogmiut are and how to be found, brought an invariable "We do not know, we never were there." It was an accident we found out that three of them did know the way by winter, straight down the middle of the strait. Either these had not been present when we inquired, or they had been silent when those who did not know spoke up, I think the latter is the fact. The others must have known too, by hearsay, but in every case, we got, "We do not know" as an answer when they had not themselves actually seen the thing, except information as to their ancestors. This character I have often noted in Eskimo to the west, but never so marked as here. They will also agree with you in anything. After telling us in a body of three islands known as "the hares" (*ōkallīit*) they at once agreed with Pan, who said they were only two in number as a woman had told her who had been there. This is a place where people habitually cross the strait, and no doubt many knew positively how many there are, but they immediately agreed with Pan, that there were only two. My chart shows three islands (Liston and Sutton) and I have no doubt there are three. Similarly, after telling B. that the Nagyuktogmiut consider the Ikillik bad people, they at once agreed with him when he said they were very good people. They had previously said to me "We do not know what sort of people they are, for we do not know them."

General Characteristics. While they probably once had an organic connection with the people towards Cape Lyon (and one indeed has a mother from "far west") their present movements seem to be restricted to less than fifty miles of coast and to the strait ice just north of them. Some spend an occasional summer in Victoria Island with the Haneragmiut or the Puiplirmiut farther east. This is a very confined sphere. Perhaps this has had a strong influence. At any rate, after allowing for their not well understanding our speech, I am inclined to consider them somewhat less intelligent in general than any I have before seen. Eskimo everywhere are little interested in the outside world; these show practically none. But as their intelligence is less, so their general kindness and good breeding is far beyond anything I have before seen. Of course, I have seen only "civilized" and mostly christianized people heretofore.

Their generosity was always prominent, and the expression of it was monotonous. Perhaps because of difficulty of conversing and a distaste for remaining silent, considering it impolite they kept constantly repeating "We hope you are having enough to eat." "We want you to be content

(not lonesome) while with us. We are therefore trying to feed you well, for a man with a full stomach is seldom discontented. He is well off who is well fed," etc. These were endlessly repeated. I believe some of their phrases have a status similar to our proverbs, for their phraseology was almost never, if ever varied. Whenever one of these sentences was uttered, most or all present acclaimed with "i-yarr-li," which we do not understand exactly, but which clearly is akin to our "amen," "so it is," "so be it." When we left we took with us a number of small pieces of meat, presents, and their last words were inquiries if it was enough and urging us to speak up if we wanted more. It has been noted that they have little themselves, especially since they have neglected sealing largely since we first came. When we were not five miles off they were spread all over the ice, hunting in earnest for the first time since we came.

Modesty is not among their conspicuous virtues, however, for as often as they expressed friendliness (which was about every five minutes) they would say "ilyiranaitturut" "köyanaktürut," "nagöyürut tamapta" and when they spoke of other groups, "They are excellent people, just as good people as we are." They are as monotonous in this self-praise as in their good wishes to us, etc. It is to be noted, however, that the connotation of these phrases is not so much that they are an excellent, superior people, as that they are harmless, friendly, not to be distrusted. A phrase much used by the Hanerágmíut and occasionally by the Akuliakattagmíut is "naunait-türut" which literally, nellünait turut, we are easily seen, easily discerned from afar, but which I suppose denotes "easy to see through," "not given to underhand and secret practices," "not treacherous," "really as we appear."

Treatment of Dogs. Their kindness to their dogs, a uniform trait I believe of all un-influenced Eskimo, is even greater than I have ever seen before. One of the dogs will every few minutes come and stand with his head in the doorway. He invariably gets a bone or piece of blubber. They can spare no meat now, but they do not clean-pick bones as western Eskimo do, and if someone tries to drive him off, another member of the family will protest "You cannot expect a hungry dog not to beg for food," "Drive him away with a bone and not a stick," etc. The dogs wear their harness all the time, and when they fight they are not beaten apart, as is the custom farther west, but pulled apart by the harness, which seems to be left on for this purpose. I saw one dog struck with a small stick, but he was an inveterate trouble breeder.

Habits of Cleanliness. Measuring their heads, I saw neither lice nor nit, though this gave me a good chance to see any there were. I do not think them quite free, however, as I saw one or two women feeling for some such thing inside their coats. They were never successful in their search,

which bad luck seldom attends a similar quest in the Mackenzie. They probably never wash but I know from experience one gets no dirtier after the first few days.

Attitude toward being Measured and Photographed. They showed no fear of head measurements and of being photographed, at first. But B. officiously explained the photo process which seemed to make them uneasy and I dared not go beyond two group pictures, for we expect to have considerable to do with these people later. They made no inquiry as to the nature of my operations in photographing them, possibly not to show ignorance, or perhaps for some other reason. B.'s explanation was gratuitous.

Use of Bows. Wanting to see them shoot with bows, I thought it a happy introduction to the subject to show them how to shoot. I therefore set up a small stick at one hundred yards and fired at it. Two of the apparently prominent men went with me at my call for volunteers to see the effect of the shot. Unfortunately, I had missed and wanted to shoot again, but this they earnestly begged I should not do, saying they were unused to such things. I regretted my foolishness in starting this, but seeing it was started I thought it better to show we occasionally did hit, and B. and I each fired once, both hitting. The repetition seemed to rather reassure them. Two bows were then brought out at our request. The range seems to be about one hundred yards and at twenty-five yards they hit within a foot of the target "bulls eye" about four out of five times. Doubtless these two were the best bow men. Evidently the bow is a more satisfactory weapon for deer than I had supposed, yet it surprised me that they should have given up the method of spearing, which has everywhere, so far as I know, been the mainstay of deer hunting.

Clothing. Only a few of them have really good deerskin clothes and some help themselves out with seal and squirrel, seal long blouses and squirrel pants.

Condition of the Houses. Their houses have no bad smell noticeable to me. They doubtless smell somewhat of seal oil, but so do our houses smell of the things we eat and use, and we don't consider them therefore vile. They are very careful that their lamps are trimmed and I have not yet seen a snow roof with traces of lampblack evident, and it would soon show on snow, ours was fairly black in a week, but then we don't understand lamps, except Tannaumirk.

Use of Stone Lamps and Pots. The lamp and stone pot are a pretty satisfactory cooking apparatus. A lamp takes perhaps double the time of a "primus" to boil water, but it can be left for hours unattended, and if one wished (but this they probably never do) one could leave a pot on going to sleep and find boiling water in the morning. It seemed to me those who

used stone pots took less time in cooking than those who had iron or tin ones (over half of them), but this is perhaps because the stone ones are long to fit the lamp flame, the iron ones are round and therefore with less heating surface.

Cooking. I have heard of Eskimo merely warming meat to eat it. These always comment unfavorably on a piece that is a trifle rare and I have not seen one eaten that would not be considered "medium" or "well done" if a beefsteak in a grillroom. In fact I have never seen Eskimo eat partly cooked meat, they usually cook well. Besides, I have tried boiling seal more than the Eskimo do and found it toughened the meat, unless you boil it an hour or so, when it softens again but has lost its best flavor. I prefer meat put unfrozen in cold water and taken out about five minutes after the water boils. At this season of the year I much prefer seal to deer meat, if fresh.

At meals the couple of the house and anyone else who cares to, usually an old or middle-aged man, sit on the edge of the bed platform with their feet hanging over; younger visitors stand, as do the children who typically come in from play to eat and dart out again when done. When the meat is considered cooked, the woman takes it out of the pot, using a handle-less musk-ox horn dipper in her right hand and the fingers of the left hand. The pieces are put on the sideboard in front of the lamp and left to cool. They are occasionally felt of, and when comfortably cool to the hand, the woman takes a piece, squeezes it between her two hands to squeeze out any water that might drop on the floor or one's clothes, rubs off the blood (seal blood coagulates in the water in grains and thickly covers each piece of meat as it is taken out). Then the woman hands out the pieces. In our case, who were guests of especial honor, the husband took the piece intended for us, usually felt of it and the other pieces to see if it was really the best, squeezed it again and rubbed it to make it drier, and then handed it to us, saying their meat was not much good, but this was about the best piece. In all cases blubber was carefully trimmed off, until they found that I liked to have some left on mine.

Most of the people hold the meat in both hands and do not use a knife; some use an ulu, eating in the ordinary Eskimo fashion, biting into the meat and then cutting just in front of the teeth. After eating the hands are wiped on a birdskin. I have seen ptarmigan, gull, and swan used. Then any fragments that have dropped on the floor are scraped under the table with an ulu.

Ceremonials or Charms. Of ceremonials I saw no trace, nor of charms, though they probably have both. Tan. took a leather thong worn over shoulder and under arm across the breast and back, to be a charm, but I think it was to carry the knife. It is worn between the two coats.

Stories and Cat's Cradles. They told Tan. they told stories and did cat's cradles only during the dark days. This T. says is as formerly it was at Kittegaryuit.

Skin Dressing. Sealskin is dressed in the ordinary Eskimo style: black for water boots and white (nelluak) for soles and ornamental work. The skins are dried on snow walls, perpendicular and facing south, being pegged on with small pegs. At Haneragmiut I saw skins being dried on the north side of these walls, not for want of room on the south side, for the wall that had skins on its north side had none on its south side. What the difference of result is I do not know. Their ugrug lines were cut about one-third of an inch wide which is the ordinary Eskimo width. All of us see them here for the first time white. They have been sun-dried and then most of the hair scraped off with a knife. The style west is to rot off the hair making the skin yellow.

*May 21.* Iron and Copper Implements. The Akuliakattagmiut and Haneragmiut all have iron snow knives, though one Akuliakattagmiut has a copper one too. All the women have iron ulus, only one has a copper one, but she has also five iron ones. They have whittling knives, crooked knives, and needles, all of steel. Their tools are all sharp.

Clothing. Pan. says their sewing of water boots is to her mind better than Kittegaryuit or Avoak (Baillie). They have seal coats against rain, they say, but these I did not see.

Stone Pots and Lamps. Their stone pots, they say, are not very costly, did not find out about lamps, though they are probably more valued.

Snow Knives and Ice Picks. One man had bought a good snow knife for a bow. Must have good ice picks, one Akuliakattagmiut has a copper one.

Fishing. They use ice picks for fishing when first they move inland. The fishing is chiefly by spear, a polar bear tooth is "jigged" on a string and the fish speared when they approach.

Bows. One bow measured was four feet one inch from tip to tip, straight. They are not unstrung in winter. They are of three pieces, of drift spruce, backed with deer leg sinew. Bow about two inches wide and one-half to three-quarters of an inch thick. String of leg sinew, is one-eighth inch in diameter.

Seal Spears. One seal spear is four feet eleven inches over all, the loose piece fifteen inches. Spear had iron point, called (with bone it is set in) *naúlak*; the bone into which loose piece fits (on handle), *katka*, *kěyukta*; the wooden feeler put in seal hole to show seal's approach, *kaup'kōta*; bone cross piece at end of string attached, *īlark*. The whole seal spear, *natjírksūn*, the ordinary name for seal is *ōxōvīk*. *Túraxiok* is the ugrug line attached to the spear to hold seal.

Sleds. The sleds are not of the short Mackenzie and Baillie type though Prince Albert sleds said by Mogg to be short as early Mackenzie. All the old sled pieces we found on Parry and one or two found east of Lyon were the short type. One measured, an average one, was ten feet one inch long, nineteen inches wide, inside measure, about ten inches high, with eight cross-pieces lashed on. They are rudely made of driftwood, and as many were new, I conclude they are frequently discarded and new ones made. Shoeing of moss and ice. I did not want to ask to see it, as all sleds carefully buried to within about two inches of top, to protect ice runners from chance thaw. Their trails leading on rough and glare ice often show the shoeing substantial, no pains taken to avoid glare spots, apparently.

Food. Seal heads are cooked and the meat eaten, but the bones only slightly broken to take out brain. Heads protected from dogs. At a deserted village I found a pile of some thirty heads that showed no dog gnawing though some meat on all, not clean picked, as bones seldom are here.

Houses. The lamp platform in most houses is a piece of wood split from the root of a large drift log. This splitting is done with numerous small wooden wedges. The platform resting on a cake of snow, as described some days ago, is after all, on visiting more houses, found to be very rare.

The houses are all high enough to stand upright in. The door faces the south. The woman sits on the edge of bed at side board, over edge of which is the lamp. To her right is the man's seat and to her right the guest or older visitors. Younger visitors stand. In one case two houses had a third, without door to the outside, between them. I was never invited into one of these houses, and none of us ever entered houses uninvited.

Clothing. A cap of fawnskin with ear flaps and band under chin is used in summer against mosquitoes. The coat is typically swallow-tail, length varying from middle thigh to middle calf, and width from six to fifteen inches. All borders, seams, edges, are reinforced with a strip one-eighth to one-quarter inch of hairless skin inside and about one-quarter inch in from edge. Some coats are one color, some have much fancy work in black and white (all deerskin), mostly lines and rectangles. No fancy work on inner coats. Some outer coats have thongs hanging here and there usually in pairs. Most have a bone button (from twenty-five to fifty cent piece size) on small of back of coat. Some buttons oval or lozenge-shaped. Some coats not swallow-tailed; some of deer, but most of seal (no swallow-tails of seal) and come to about the knee. They are put on for snowhouse-making and in blizzard. The lower edge suggests that the skin was not trimmed at all below, the coat being as long as the skin allowed, and showing all the flaps and irregularities. The shoulders of these coats about fit the man, but the

swallow-tails, especially the outer, have exaggerated military shoulders, some being fully six inches too wide at shoulders, shoulders of coat sticking three or four inches beyond shoulders of wearer, and often therefore sagging down. The exaggerated shoulders and the swallow-tail give the men a triangular back figure.

Ears seem never cut off skins. I have seen them on women's boots, men's pants in front about each side the navel, and on the shoulders of a man's inner coat, the ear sticking inwards. Each ear forms a hole in the garment, at least in the hoods. The ears of the hood sticking out give at a distance an appearance not unlike the mortar boards of academic institutions.

Inner coat has hair in; outer, hair out. Outer coat usually, but not always, thicker than inner. Tails of both outer and inner coat seldom of quite the same cut. Women's coats in general similar to men's, except that ears are not prominent on hood, but hood large and pear-shaped, hanging back on shoulder. Children are not carried in hood, but inside coats on back, as Mackenzie River. Trousers are plain or ornamented with white skin and pendant strings. They come well above navel, much higher than farther west, and reach three inches below knee. They are loose at knee, not tied. The women's trousers are ornamented from the middle of side to middle of back of each thigh with vertical strips of dark and white deerskin. Each strip is wide at top and tapers down, or widest, perhaps about ten inches from top.

Boots. I had no chance to examine complete footgear. They wear two or more pairs of socks coming to knee inside pants, and over these a slipper of nelluak (white) sealskin drawn tight just below the ankle. Women's slippers similar, but leggings come to hips, about as our own water boots do, and fit very loosely. They are suspended from a belt.

Sleeping Bags. Saw no sleeping bags nor sewn-up deerskin blankets, but they may have either or both.

Clothing. Haneragmiut have about same clothes as Akuliakattagmiut, but deerskins seem rather more abundant. The shoulders of their coats also somewhat less exaggerated.

Cat's Cradles. I had Tan. make all the cat's cradles he knew, three, to see if they knew their names. They recognized them as (1) Tërrërántak, (2) axrar'ruk, (3) marhïktō'ryuk, which T. says was as they are named at Kittingaryuit. The Akuliakattagmiut then made for us these same three, and also (4) imirtaktar'ryuk, (5) tūktō'ryūk (Kittingaryuit, tūk-tū), (6) pihyūgyuk (Kittingaryuit, pitjūgátjīak), (7) kannahēryuk (not recognized by Tan. till named and then as kānmayōk), (8) ūk'pīk (not recognized till named, then as ūkpīk), (9) ūlūurūlik (Kittingaryuit, aiḡarak). All agreed



this was all any of them knew. Many did not know how to make all, but all apparently knew some. The string passed from a young to an older man and then to a middle-aged man before list was complete. T. said he did not recognize some because he does not happen to know how to make them, but insists all are "just the same" as at Kittegaryuit.

*May 22.* Point Cockburn. Introductions. Each man of Akuliakattagmiut or Haneragmiut usually explained the meaning of his name or made some pun on it at time of introduction. This I took to be to help us remember the name. Each seemed to have a stock phrase, for some must have had a dozen occasions to repeat their names and always used some set accompaniment. Some made no comments on their names after first introduction, and a few not even then, simply repeating the name two or three times.

*May 23.* Coronation Gulf. Deserted Village. Started 10:45. Had seen from camp before others woke up what appeared to me a snowhouse window just south of the two little islands (north end of northern one  $46^{\circ}$  from camp, south end of southern one,  $50^{\circ}$ ). Had previously determined to cross to Victoria Island south of Liston and Sutton Islands to look for the trail of the people who wintered with the Akuliakattagmiut as Pan. claims a woman told her that they always travel along the Victoria Island coast after passing these islands. Either Pan. misunderstood or else the woman did not know, as this snowhouse soon proved to be one of seven and the trail lead about  $80^{\circ}$  or  $85^{\circ}$  towards mainland, and this must be the party in question. Followed trail till 10 P. M. and passed three camps after the first one, four in all. Trail about two weeks old. They used snowhouses at first camp and tents at others. Stopped to rest every two or three miles and always adzed or whittled wood at each resting place.

"Windows" in Deserted Snowhouses. The "windows" I have spoken of in previous entries are, not windows, but holes cut in the snow wall to pass out bedding, etc., at time of breaking camp, to save carrying through alleyway. The hole is naturally over or near the door, as the woman could most easily stand there passing things out. It is never to the left of the door, but rather often to the right of it, because, no doubt, lamp occupies left of door.

*May 24.* The Akuliakattagmiut. Started 11 A. M. and at 1:15 P. M. after several stops came to place where trail led inland. This is not at a river mouth proper, but at a tiny inlet at the bottom of a V-shaped small bay. There are gravel bars just outside this inlet, a few yards off. Its bearing is  $312^{\circ}$  from the east (or north) end of the farthest east (or north) of the Liston-Sutton group and  $0^{\circ}$  from the west end of Lambert Island. The trail led about  $140^{\circ}$  over several small ridges about three miles to where

we found two tents and seven people. The other sleds had moved farther on. There were two men, three women, and two boys. They had fish only for food and say that have never had quite enough to eat since they came. They, however, at once presented us with about ten pounds of boiled salmon trout. They consider themselves Akuliakattagmiut though they often hunt here, Nūahō'nīrk.

A young woman whose child died soon after birth a few days ago has a tiny tent to herself.

Names. A boy is named "Nyčr" which is said to be the name of a kablunak who lives far away by the sea; can't find out just where. We met the same name in a woman of the Akuliakattagmiut, but it was not explained to us.

Songs. They have songs which they sang for us which they say their ancestors got from the Uallirnergmiut very long ago. They were surprised to find neither T. or B. knew them.

Dress. The dress in general is the same as Akuliakattagmiut but two of the three women have a twelve inch long, one and a half inch wide tail in front also. An old woman wears a man's sealskin coat. They wear more seal than others seen and two women have squirrel skin pants.

Though only women at home they seemed far less timid than others seen. A woman who had been fishing stopped on her way home to wait for us a half mile from their camp. Nevertheless, we halted and sent Pan. ahead to confer. We then pitched camp about a hundred yards west of them on the ice.

Method of wearing the Hair. Brown hairs in eyebrows and moustache (no beard) of both men. Hair cut of men Akuliakattagmiut. Two men and one boy have front hair braided, two small braids, apparently to keep it out of eyes. One woman and ten year old boy have back hair wound in two bundles with hairless thong.

House furnishings much as Akuliakattagmiut. They have sledded some wood, for fuel, which they burn with blubber, of which they say they have plenty. They gave us both for cooking.

General Characteristics. This group appears to better advantage than others seen, seem more intelligent, answer questions readily, seem far better informed about their neighbors.

May 25. Skin scrapers. They say they never had skin scrapers of copper or iron, but only horn and white and brown bear bones. We saw metal scrapers among the Akuliakattagmiut, but they may have learned the making of them indirectly from the Klinkenberg or Mogg ships' natives.

Clothing. Muskrats are killed inland here, but flesh never eaten and skins never used for clothes, "for we never learned to use them." The tails are sometimes worn as pendants on clothes, as ornaments or charms.

The Puiplirmiut. The Puiplirmiut are said to be inland in Victoria Island from the Liston-Sutton group of islands. Have just moved in they think. They are called more numerous than the Akuliakattagmiut by a good deal.

They call the Indians, *ırksınaktūt*, bad, or rather, to be feared.

Skin Diseases. Amĩrailak has some sores on one leg (did not see them) and he showed me scars of sores from sole to knee open last winter. Size ten cents to dollar and leg as a whole swollen, slightly swollen now. Sores chiefly or only on feet. He is the father of the baby died at birth a few days ago.

The first case of anyone asking for anything was that of a woman today who asked for a spoon for her boy who asked her for it. We refused as we have only one each. They seem well acquainted with the Nagyuktogmiut Iglĩsĩrk and say he has told much of kablunak. One of Hanbury's natives (a talkative one, according to Amundsen's account, Amundsen's "Atangala") was left with Iglĩsĩrk while sick and probably told of the whaler "Lords Bountiful" in Hudson Bay, so this may account for the begging as well as for greater inquisitiveness than before. They are evidently not nearly so untouched by outside influences as the Akuliakattagmiut, though they call themselves the same people. Perhaps they are a division of the Akuliakattagmiut who have long acted as intermediaries between them and those farther east.

*May 26.* The Kabluna. The kabluna Njěr, Něr, or, Něrķ, as variously pronounced remains a mystery. Arr. told me he was an excellent man, "just like us." I could get no idea of where he lived "by the sea," but not by the Haneragmiut, Kanhirmiut, or any group whose name I knew. He was "lost" (a word used here of people who freeze or starve to death on trail or out hunting) "and when he was lost we gave his name to children."

Arr. also has a dog named Něr, after the kablunak. I gather he must have been lost over twenty years ago, because the Nyěr of the Akuliakattagmiut can certainly not be under twenty, and the Nyěr here, though only about eight was named after Mũkharak's son (?) who was her child and Arrnatak's.

"Nũkka" — Arr. is probably thirty-five years, at least, but of course his "nukka" may have been considerably younger. I could not make sure if this "nukka" was named "Nyěr" directly from the kabluna, though I think so. He may have been named after some other Eskimo who had been named after the kabluna. Arr. told me (the only fact I could worm out about the kabluna) that he never could eat seal blubber. Arr. thinks "perhaps he would not have been lost if he had been willing to eat blubber" from which I infer hunger played some part in his ending, probably never

came to camp some night, as so often seems to happen here when the "tribe" is moving.

The Haneragmiut. The Haneragmiut are more numerous than those we saw. Arr. asked if we had seen "Taktuk" when at Hanerak. We had not and after I had given him a list of those we did see, I got from him these names: Taktūkkut (i. e., Taktuk's family), Erianatkut, Kalatkut, Ūñallar, Avranna. I could not gather if the last two are members of one of the three preceding families. Apparently we saw only half the Haneragmiut who may therefore be estimated as thirty-five to forty. Where they were I have no idea. That no one at Akuliakattagmiut or Hanerak said a word about them is an interesting fact.

*May 27.* Coronation Gulf. Eskimo Cache. Started 2:30 P. M. and came in sight of Coronation Gulf at 5 P. M. on a low ridge having an Eskimo cache, a pile on ground covered with stones, fish spears, clothing, etc., showing owner's intended return before fishing season. 6:45 P. M. came to two caches, a rack and a pile on the ground. The rack was about four feet high, two boards on two columns of small flat stones. At just 7 P. M. we got to the salt ice and the trip we have hitherto called "towards Coronation Gulf" has become "to" it.

I had hoped for and looked forward to for some years, the pleasure of rounding Cape Krusenstern into the Gulf, but that has been denied by the pleasant happening of finding this portage route. Shortly after striking the ice we saw numerous fishing holes and some fresh footprints. A little later saw a woman fishing, and then three tents. Billy went ahead to confer, and at about 8 P. M. we pitched camp about two hundred yards to east of this camp, which is on the north shore of a narrow inlet running into a valley. Only tomcod for food and people hungry. Had seen band of deer in forenoon and while others camped I went about eight miles southwest but saw nothing. Home at 2:15 A. M. Gave people saddle of meat, all we had left. They gave us a dozen tomcod.

People at Coronation Gulf. People seem more sophisticated than others, are evidently getting more so continually as we go east. They seem to take our coming about as we would a visit from next door, not to be considered anything out of the ordinary. Their clothes, speech, etc., same as last camp. Two deerskin tents, one house of snow with skin roof.

People at Bloody Falls. Say no people yet at Bloody Fall, only after river breaks up.

*May 28.* Names. Nėrk also found here, a small boy, about one and a half years old, and another about fifteen or eighteen years. "Named after Kabluna."

Kayaks. One of the four men here has a kayak. Say people farther south have "many kayaks."

People of Dismal Lake. Started away 2:30 P. M. and camped 6 P. M. at Eskimo camp, three people. Distance about five miles. Had much trouble following trail till came in sight of house, to which trail led. Apatok, an old man, is the hind member of a party who have moved ahead to an island and are waiting for him there. They are going to Tahirpik (or Tahierpik) lake, Dismal Lake.

Use of Copper. Copper is said to abound near Dismal Lake. I bought a copper snow knife this morning and saw a piece of copper, both said to have been brought from there, the piece by Iglix<sup>s</sup>irk, whom Hanbury saw. The copper piece was rudely triangular about five by seven by nine inches and about half an inch thick. It had been partly melted either to break it from its native bed or to break it from a larger piece.

General Characteristics of People. The people we left this A. M. are said "aipani" to have killed with a spear (or spears) the husband of the Haiyuxuk whom we saw with the Akuliakattagmiut, now wife of Itáyuk. They sometimes speak of the Akuliakattagmiut as Akuliakattagmiut sometimes as Noakattivut, so they seem to be only half and half real Akuliakattagmiut, perhaps the man killing causes them to live apart from the group. As noted above, they are the most sophisticated, forward, and inquisitive people we have met. They also declared themselves well informed of the ways of white men through Iglix<sup>s</sup>irk, who must have his knowledge from Hanbury's Uttungerkuk who spent some weeks with Iglix<sup>s</sup>irk. They offered no pay for needles I gave them, the first not to offer pay. As Hanbury was not in the habit of giving gratuitously, they probably have from Hudson Bay the idea that white men do not take pay for such trifles.

Food. People here asked to taste the salt we put in soup, and after that firmly refused to taste any of our food, at previous places all have tasted the different sorts we have, pemmican, milk, and triscuit. Brought us seal meat after seeing us eat, evidently thinking we must be hard-pressed for food to eat such stuff. Say no deer around here usually. Have seal for food and fish from a lake inland.

Knives and Copper Implements. The "ten" this morning denied that their knives were from the Uallinergmiut, but said they were from the Akuliakattagmiut. The people this evening say they have nothing of copper except fish hooks. A knife I saw has the stamp "fox" under a picture of that animal. This is the first knife I have seen that is stamped.

Knowledge of Ships. They seemed to know nothing of the ships (Mogg and Klinkenberg) in Victoria Island nor of Richardson, but spoke of Iglix<sup>s</sup>irk "not many years ago" having seen them (kablunat) at Dismal Lake. Did not seem to know of the episode of the camp desertion at Bloody Fall, though they profess to know well all those who summer there.

*May 31.* Island Northeast of Point Mackenzie. Crossed Back Inlet to island northeast of Point Mackenzie and camped 4 A. M. Cape Kendall from here bears  $307\frac{1}{2}^{\circ}$  distance about ten miles. Found here two weeks (?) old trail of three sleds which I take to be those we should follow. It leads to Point Mackenzie.

Contact with other People. People here not properly Akuliakattagmiut, though they speak of them occasionally as Noakattivit. Brown hairs in beard, eyebrows, etc., least numerous of any people seen, more like Eskimo proper though all look more or less so except some Haneragmiut. They were last winter at Cape Bexley to trade. Kĩrkpũk says he trades mostly with two men of the Ekalluktogmiut whose geographical location he does not know but whom he evidently meets at Bexley. A "folding" frying pan such as one presented me by Capt. Mogg is used here for a dipper. This they say, they got last winter and came originally from Kanhirmiut, so Mogg's men have gone at least this far in two years (since early spring, 1908).

Food. Always brought contributions of meat at each meal though we had plenty seal, ate with us, and we occasionally with them. People east here much smaller eaters than Mackenzie and west, perhaps because they often starve.

Similarities to Akuliakattagmiut. Speech here differs somewhat from Akuliakattagmiut but clothes, tattooing, hair cut, etc., are the same.

Sleds. Apattok's sled the other day had runners varying about  $15^{\circ}$  from vertical, like "cutters" of "civilized." Curtains of skin hang on sides when traveling to keep sun off runners. Vertical section of runners: wood about 2 by 12 inches, sod about inch thick, shell of ice  $\frac{1}{4}$  inch thick. Dogs hitched eastern style with middle trace of three dogs two feet longer and others even, traces ten or twelve feet. Woman pulled ahead of team and men on both sides. Careful to keep sled in tracks of former sled, which Eskimo west never do. All sleds even gauge, as I have seen over ten sleds make tracks like a single sled. Haul big loads six to eight hundred pounds.

Ceremonies of Meeting. Noted, but did not understand that Iglĩx<sup>s</sup>ĩrk, the man we first met stroked Tan.'s clothes over with downward motion. Hala did the same the other night and we now understand this is connected with turnrak belief, to remove evil influences. Apattok fed us each with a piece of raw blubber which he would not let us touch but himself placed in our mouths. Possibly simply hospitality, more likely to ward off evil influences, or to see if we were human and not spirits. (Some of my folklore tales from the west imply blubber fatal to spirits, kills them.) Fear of our guns not shown since by Akuliakattagmiut, probably through Hanbury's Iglĩki telling of them.

*June 1.* People. An old man here Ekallukpik, says he was a child when

white men were here. They were ferried in kayaks across this river at camp about half mile nearer sea than present camp. They have heard that formerly they used to meet the Uallinergmiut for trade, before white men ascended river. Uallinergmiut said to be excellent people, possibly Baillie Islanders, or only Cape Lyon people. They never meet the Akuliakattagmiut now.

*June 2.* Point Mackenzie. Camped 6 A. M. at Point Mackenzie to wait a day for promised coming of Kirkpûk and family who are going towards (but not to) Dismal Lake. It seems no one going this year to the lake. If they do not come today, we shall strike for woods up the Coppermine and return to Bloody Fall "when the mosquitoes come" which is when people are said usually to go there.

Names. One man Atigiliōx "named from a kabluna."

*June 5.* People East of the Coppermine. Next group of people east of the Coppermine habitually go to Napaktulik (tree-grown part of Coppermine) in summer. Richardson River "is said to have had" food on it and to have been peopled, "but it ceased to have food before my time" said Ekallukpik.

Rae River. The Pallirk (Rae River) has since very long ago (iñ-il-lě-ran) been the home of the people in summer. Ekallukpik apparently the most intelligent and best informed man seen down here. Apattok had never heard of Kōxlükтарыuk (Hanbury's map) but E. could tell much of it though he had never seen it.

Fear of Guns. No one since Akuliakattagmiut has shown fear of our guns, but have on the contrary all urged us to use them on game.

*June 12.* Coppermine River. Rae River people were first we have seen, who were not at Cape Bexley last winter.

Found today two sod tent rings and spruce bough bedding of two Eskimo shaped tents of last summer on high hill by river. Put there either for deer lookout, or else on account of mosquitoes. Tan. says Kittingaryuit use "amisūt" only of caribou, and only when very many. If only fairly many, then "amīlraktut. If many birds, "ōyamūyat" (ū as in mute). Billy says deer "innūiaktut," birds amīlraktut, if many. "Innuiaktut" is used by both B. and T. for people, though usual colloquialism at Kittingaryuit is "innūk!" "Amisut" used by Akuliakattagmiut etc., for all things over five, though when pressed they know "avīnñran" (Kittingaryuit, arrvanīlirīt).

*June 13.* Ekallukpik the other day took triscuit for whale meat on seeing them first. He took my light hair as a sign that I was a very old man, saying, "You and I have lived a long time, our white heads show it."

His sled shod with whalebone. Pallirk (Rae River) sleds in general longest we have seen.

Campsites. Found numerous old campsites on hill alongside lake just north of us, probably a fishing lake. Deer and musk-ox bones.

*June 17.* All people we have seen speak familiarly of tuktuwik and aivik, but none have seen them. None seem to have any notion of such an animal as ĩnnak, though they use ĩnnak for a cliff or precipice. The Akuliakattagmiut who do not eat meat or use skins of muskrat, have the name Kĭvraluk. Tan. describes bears to them in terms of Kĭvraluk but no sign they ever heard of such an animal. Neither did Akuliakattagmiut seem to have heard of a smaller ōkallĭrk than the hare.

*June 19.* Belief. Pan. says Kuwĭk people hang afterbirth in a high tree. Among her own people a woman with a child on her back (i. e. less than about five years) must not eat kaksrauk (black-throated and red-throated loon); if she does her child will be unable to walk or be at least a poor walker.

*June 19.* Campsites. Found yesterday some eight or ten different places formerly campsites of Eskimo, mostly along small lakes lying about half a mile from river about six miles south, but one each on our river and the next one south, the one on our river at foot of rapid, all probably fishing places. Next river south has branch, comes from a lake lying parallel to mountains about two by a half miles. Found yesterday small river (ten yards wide, eighteen inches deep, five or six mile current) coming out of a chain of small, very deep lakes. Along two of these very large spruce a foot in diameter six feet up and over thirty feet high. Indians axings (sharp ax, winter cut) on trees here. This river lies parallel to main river for about two miles behind a range of peaked gravel hills, a few hundred yards further up stream on opposite side of main stream is a rather large river.

*June 22.* Tan. got back 12:30 P. M. so did not sleep, but kept on up small river. 1 P. M. came to river widening into a lake with one island, a hill, and three smaller ones low roundish lake, half by a quarter of a mile in transverse diameter. On shore, found tipi frame and inner cover of lard pail with Cree characters and the four names "Melvill, Hornby, McKinlay, McCallum." Large number of trees cut shows they were here for some time, and in chilly weather, as large logs used, twelve inches in diameter cut in eighteen inch lengths and not split. In a way disappointed at finding this, had hoped Melvill and Hornby were coming this summer and that we might meet somewhere.

*June 23.* Started 8:30 A. M. and turned towards home about noon as our time is up and no fresh signs of people. Old signs are plenty, a tent ring and firewood leavings on top almost every one of the big hills along river. Hill tops average over a mile apart. Most tent sites seen on very pinnacle of hills. There may be as many in lowland though we did not find them.



Campsites. Tan. yesterday found "over ten" meat caches of about three by five and four feet deep, made of rocks, and "plenty" house sites, but wood, bone arrow-head, etc. indicate twenty-five or more years. One case of stones set up at an angle to indicate direction campers moved up stream.

*June 27.* Tan. knows names for about one third of flowers and now a purple-red flower is called itkilō'yak and it was former practice at Kittergaryuit for small boys to chase around all day with bow shouting "itkillirk ūvva!" when one was found, and competing to see who could shoot it down first with arrow, encouraged in this by elders as "long ago we used to fight the Itkilliks."

*June 29.* Started 5 P. M. moving camp S. Looked at chopped trees seen by B. and T. yesterday and think them all Eskimo work. Some cut up by roots for lamp rests and sled runners (?). On bank found pair of sled runners made last summer and left to dry.

*July 8.* Eskimo Habits of Mind. When we first saw robin redbreasts the other day all three agreed they were kiyirk (the name for blue-jay) and fond of meat. When T. and I found first nest he said he now saw they were not kiyirk, as the eggs were different, but he is now evidently back to his former view, for he agrees that he and B. yesterday had found a kiyirk nest with three eggs. On reasoning the matter over P. concluded they might be kayōtak, e. g. they were not kiyirk. From this B. violently dissented, saying kayōtak is not found here. The mental trait illustrated is the same with both, however. Each identifies the bird positively with a bird they knew before, though (I do not know kayōtak) the difference between robins and jays is great. This trait was noted in reference to snow geese, sulupaurak (arctic trout?) and aklaks (land bears). One must bear this trait in mind in reasoning about Eskimo prehistoric migrations on the basis of animal names, a source from which I now expect less light than I did before I understood their laxness in differentiations. (Cf. also the Noatak-Killirk, et. al, belief, that doe never fawn two years in succession). Last winter we repeatedly killed a solitary doe and fawn, when the doe carried an embryo, also often a fawn broke from a band and returned to look for its dead mother who had embryo. This last fact Kunaluk admitted was very strange in view of the known fact that if a doe had embryo that proved she had not fawned the past year, therefore fawn's return probably accidental. When single doe and fawn together, he called that accident, too, as any two deer might be found together, that the doe had milk in her udder did not seem strange to him, perhaps because Eskimo women give milk five to seven years after bearing a child. Typically an Eskimo is very different in advancing an opinion based on his own observation, but rock-firm in adherence

to views he gets from others "for people would not keep saying it if it were not so." The fact that many Eskimo here have names of white men (Nĕrk, several), etc., B. and T. refuse to regard as strange, as "The people here, as we used to, no doubt have white men for turnnrat (familiar spirits) and name their children from them, as we used to." When I pointed out that the name "Nĕrk" is characteristically non-Eskimo, they said that was natural, as turnnrat who were white men naturally spoke like white men and had white men's names. I pointed out that Arnatok had told us the Kāblunak "Nĕrk" had been averse to eating seal-oil; that too B. and T. said was natural, as many turnnrat have strong food-prejudices and B. personally knew of several turnnrat that would not eat seal oil; T. contributed that Alualuk's turnnrat would not eat seal-oil. B. added that being a white turnnrat, it would be especially natural he would not eat oil. The only thing that seems to them strange is the fact that "Nĕrk" is said to have died. They do not know of turnnrat dying, but say that, come to think of it, it would be but natural they should die, though people naturally are not likely to become aware of this circumstance.

Both B. and T. are Christian, though B. admits he is not well posted on Christianity, T., however, is a sort of deacon, and missionary last year to Baillie Islanders.

B. the other day after singing what he 'mis-knows' of the hymn "Rest beyond the River" explained that if one was Christian, when one died he would have to cross a river and could not rest at all after death till he got across, by which time he was in many cases very tired. This explained I suppose to be a misunderstanding (with additions) of his Sunday school teacher's (Port Clarence) explanations of the symbolism of the hymn.

Akuliakattagmiut and East do not wear belt to support pants at hips as Eskimo west and Indians commonly do, but at waist, about as whites do. This probably a corollary of coats which are short in front.

*July 24.* Near Dismal Lake. Lice. Pan. says "annirut" come out, as child at birth, from a man's body in at least three places she knows of, at the nipple, under the arm, and near the upper inner part of the shoulder blade.

*July 27.* People found and our hopes therefore realized. Our old acquaintance Apatok with wife, two sons, daughter-in-law and her baby girl. They are the people we left at the island off Cape Kendall. The other three, Kīrkpūk, wife, and child are said to have attempted to follow our trail (we had talked of summering together) and their whereabouts are now not known. They may (I think, but Apatok thinks not, account of fear of Indians) have gone to the S.W. and Tahierpik, where I had said I hoped to spend the fall. They say a large party, the Kogluktogmiut, have just

gone south up the small river we were on yesterday (Richardson's "Wooded Valley" river, also his "river had thrown a sandbar across lower end of the lake.") They are said to be now, as habitually on Imaernirk lake, a common name among Eskimo for lakes notably larger in spring than fall. This is said to be "near," from here but no one can tell just what that means. Shall try to keep in touch with people hereafter, though we cannot stay long here as only two deer have been seen since they came here "a few days ago" (ikpûksak). These both they killed with bows, though they have kayaks; otherwise they live on squirrels and ptarmigan which they mostly shoot with bows; we cannot afford this, as our ammunition would soon run out and must therefore find deer. The camp is, I believe (though they do not know) situated about where Hanbury found "Igliki's" camp. Extensive innuk-cûit (deer stockades) both on lake shore and on land.

*July 28.* Packing all wear head straps. One man carries kayak scuttle up, other scuttle to his back. Scuttle-up is on top a pack, other man carries no pack but the bow and quiver, which in both cases are on top the kayak. The dogs have pack of a single seal pōk split down one entire side and laced, apparently to suit contents, the lacing being tightened if load grows smaller.

On camping they had pot boiled by time our fire fairly started, our woman had to have green willows even from considerable distance, while they cooked with heather which when dry makes apparently a very quick fire. The long, shallow stone pot is well suited to this sort of fuel. Packing kayakers walk far from others for safety of kayak, especially in turning around. The people and dogs straggle in any order, and one man now leads, now another, often many abreast.

*July 29.* Found on reaching lake people gone. Have gone "south into the woods and are lost till they make sleds and come out again." Ap. says it is hopeless to try to find them but I shall have a look around tomorrow and the following day.

*July 30.* The "lost" people of yesterday prove to be visible with our glasses from our tent about four miles off on east side the southern part of the lake. Shall move there this afternoon. The two women are very helpful to us, cutting out sinews, helping cook, sewing, etc. without our suggesting it. They use all three principal tendons of hind leg for sinew, ours only two. They and Kittegaryuit people skin deer head by splitting from nostrils to eyes and horns, westerners cut up middle face and make Y cut from between eyes to horns. In boiling heads, westerners cut off nose, split rest of head, and boil brain loose (if not eaten raw). Kittegaryuit people cut off nose just below eyes instead of above nostrils, split skull but allow it to hang together so that it retains the brain in boiling; on eating it is opened oyster fashion and brain eaten as oyster from shell. I have not

yet seen a head eaten here, but the bones show the split whole head, nose to foramen, without removing nose. They crack marrow bones with stone on stone without scraping off membranes; ours scrape off membrane with knife and crack with back of knife.

Moved about five miles and camped on account of numerous deer seen. Got to them just in time to conflict by our scent, with deer-driving plans of resident people so neither got any. B. approached the only person we saw near, expecting to apologize, but she took fright when she saw B.'s strange clothes, and ran for home, abandoning deer-driving operations and scaring off a small band that were in fair way to approach the bowmen, as we later saw. B. was only about one hundred fifty yards off and she must have heard plainly his protestations of friendliness and pleadings for her to stop. Later B. got five small deer, three females, two young bucks, and I two, a female and a large buck. After shooting latter I was approached by a stump-legged man (feet, frozen off) wife and small girl, who said this was their buck, had wounded him this morning. I gave him the doe besides. Ap.'s people had by this time arrived at village and news of our harmlessness were carried to hunters.

Caps for mosquitoes are worn by most, though Alyirk had an addition to his head that extends it well forward. Caps are usually squirrel and are tied, bonnet fashion under the chin.

*July 31.* Moved and camped a few hundred yards from people on account of our thievish dogs. Brought home some of yesterday's meat.

*August 1.* A band of deer came to W. side of lake and would have crossed, people think, but for smelling our tent which (and not the Eskimo camp) was to windward. On smelling us they turned west and disappeared.

Later: Moved nearer to village to prevent recurrence of this morning's deer episode. Shot young buck and gave to people who have little meat.

*August 2.* Learn that Kirkpuk who followed our trail last spring and was lost to his family (Apatok's) is camped some four or five miles S. of here, having come around by way W. end Tahierpik, where he went looking for us.

In the afternoon a crowd of eleven (three women) including Kirkpuk came to visit us, the Kogluktogmiut. At their suggestion moved to their camp in the evening, they carrying most of our stuff.

Apatok's people at least will not eat akpek. "Never heard of such a thing," though they do eat blueberries and occasionally macut roots.

*August 3.* People have plenty of meat and do not seem to care to hunt, expecting wonders from our rifles and modestly refraining, or else shifting the burden on us. They dry meat on rails supported by stones three feet above ground. When outside is dry, it is then taken down and piled under

sealskin rain shield. Very generous to us, give us more dry meat than we could eat if we ate alone and then insist on our eating with them about five times a day. Boiled meat and blood soup in morning only. Have no kayaks, left them near mouth of Coppermine.

One man at Imaernirk, the footless Aiaki, belongs to Umīnmōktok, (Arctic Sound — according to Hanbury) and one here belongs to Akuliakatagmiut, whom he left this spring (will return next fall).

Saucers, cups, etc. here from Mogg or Klinkenberg. Some are said to be from Kanhirmiut, others from Puiplirmiut. Aiaki says some of his people have rifles; one man here (Hūprōk) has a new house trap which, he says, came from the kablunat to the east, Hudson's bay: People more like western Eskimo in appearance and manners than any seen yet, striking difference from Victoria Island. Our people (P. and B.) say their speech is more easy to understand than any other and Aiaki and his wife's best of all. Thus affiliations are evidently closer in some direction other than Victoria Island.

*August 4.* Suddenly without any foreknowledge of any of us, the camp broke up about noon to move south (compass) eventually to woods which I suppose six or eight miles off in that direction. This is evidently the reason why they have not hunted recently, as they are heavy with meat for moving. One family — Natjinna, wife, boy of eight, girl of two, decided to come with us S.W. (compass) where we hope to cache meat for winter. Very glad of their company as one family is about as good for my purposes as many, for the present.

*August 5.* Moved to woods beside small lake. Musk-oxen are said to frequent the district to N. and W. of us along Dease River which has no Eskimo name, other than Imaernirk River. The first musk-ox signs of recent years we saw along E. side of Imaernirk, last winter's dung abundant.

*August 7.* B. hunted west with no success. Apatok, son, and son-in-law and the three families moved to us today. Say Huprok killed two large bucks in one day recently, several other deer killed.

*August 8.* Natjinna's and Uluxrak (Akuliakattagmiut) family moved on farther S. today and we have only Apatok's family. Imaernirk is abandoned, all people now S. E. and S. of us. Said to be people scattered here and there all the way to the coast, as well as E. of the Coppermine.

*August 9.* People here evidently don't know much about Indians as they call the tipi frames occasionally found, kablunak tent frames. Natjinna and others evidently fell in with Melvill-Hornby party (about four miles S. of our present camp) for they tell of meeting six (some say eight) white men there two years ago, and Nat. has a shawl, ax, file and other things

from them. All refuse to believe that any of this party were Indians, though there can hardly have been more than four white men, and the woman must certainly have been an Indian.

Have been trying to teach people to eat akpek. Most or all the men and children have tried and some like them. Most of the women refuse to taste them even, and those who taste do not like them. About the only berry they seem to eat is a small black one growing on a low shrub that resembles an evergreen, these berries none of us like, though I eat them when brought me as presents by the children. The name "akpek" seems known to all and some, but not all know an "akpek" by sight. The Akuliakattagmiut couple say they never saw an akpek before, but I think that is merely because they do not pay attention as the Akuliakattagmiut hunt close up to Tahierpik and the woods occasionally.

*August 10.* Hunted S. saw over twenty deer, three bucks of which shot two, half inch back fat both. B. returned, had been loafing with Kogluktok people. Natjinna and Uluxrak's families returned. N.'s baby sick, swollen feet, and other parts of body, ears, etc.

Billy killed five deer while with Huprok's people eight or ten miles S. E. of here. From there he saw Imarryuak (which is Bear Lake, I suppose) from a hilltop. Huprok told him that once when he was a boy (now thirty-five) his people hunted for some time along the shore, but fled on hearing shooting, which they attributed to Indians. There are only four men (three women) in Huprok's party now, all scattered in groups of one and two families, some gone back, some forward or E. Apatok's family moved back to Imaernirk.

*August 13.* The Uminmuktok woman (wife of footless Aiaki) told Pan. wonderful stories the other day of the Pallirmiut, from whom they get guns and other white men's wares. These Pallirmiut come overland from a country near which white men have big houses. They kill so many deer en route north that they bring sealskin bags full of deer marrow. Their women use a whole deerskin for their hoods, which hang down to the ankles. Only a few of the Umin. have guns as yet, but they have from the Pallirmiut cooking pots in which they cook a whole deer at once.

*August 19.* Conservatism. Most Eskimo I have seen habitually (if they want meat to boil quickly) turn pieces over even when water covers every piece in the pot. This practice no doubt dates from time of shallow stone pots when every piece had its upper side out of water. B. never probably saw meat cooked in a stone pot till here.

*August 22.* Great Bear Lake. After traveling about two miles saw Indians at a distance, three families, one of them man who was with Melville-Hornby on Melville River two years ago. Speaks a little English, says

Hornby has house N. E. corner of Bear Lake close to our route yesterday. Hornby is coming back soon, he says, with boatload trade and had sent this man to try find Huskies and establish relations.

I am sorry to see trade begin but it can evidently not be long staved off and I am glad to see it fall to Hornby of all those who seek it, I am therefore at Hornby's urgent request (through the Indian) undertaking to bring them together and took the three men this evening to the next Husky camp about five miles N. and eight from Bear Lake. These are the following: Niraktallik, Avalluk (Rae River), Añivvra'nna, Oturriak (younger brother of N. both of Uminmoktok).

Pizyūak (z French) of Pupilrk, Nalvalhlrök or Nabanna (son of above, about six); Ullröyak or Dtōxanna of Puipilrk, Kallōn of Rae River, Igūak son about five, and Avaliit'tok about three, Kūmak about twenty-five Rae River, Kōpan'na, Rae River, inland; Kūdláluk of Akuliakattak, Atūgyūk (same as husband), Kōmiarryūk, eight, adopted daughter of Kōrluktak, Aviūranna of Akuliakattak, two years, Nablūaluk of Akuliakattak.

*August 23.* As mutual amities Eskimo and Indians danced; very like in song, loose, stooping attitude, gestures, step, almost as like or quite like Eskimo of Mackenzie River and Coppermine.

Six Eskimo to visit Indian camp on condition I go too as interpreter and guarantor. Indians last night and Eskimo today by my request in first case and Indian request in later, left guns and bows respectively at a distance. Indians last night refused to sleep till we lay down on each side the three as sort of guard. Very amicable towards last today. Indian insists on making many presents contrary to my advice. Bought three Indian dogs from Eskimo for two knives and an old coat. Ulus (iron) for plates and jack knives, snow knife for poor butcher knife.

Indians Catholic and swear in French. Brought pictures of Virgin, etc. for presents to be worn over right breast and message from Bishop that he would build mission at Bear Lake if Eskimo were good. Indians say in the winter time they use drum in dance, and from gesture today, it appears that the dancer carries and beats it Eskimo style.

Indian tents thirty-six caribou skins, hairless, white as cloth and fold as small as No. 10 drilling, or smaller (small pack for one dog). Roomy, comfortable, big fire in center does not smoke, room for meat drying in blanket pieces, about Coppermine size, on crossbeams seven feet over floor. Indians (Jim, Jim Hislop and Snowman) think large body Bear Lake Indians will come here, in about nine sleeps. Say plenty are going (or gone) up Dease River. Hodgson coming up Dease, they say for Company. Plenty deer, moose and fish winter N. E. corner Bear lake, plenty deer and moose and marten lower Dease. About three weeks caribou will go south to tip (N. E.) of lake.

In tent women keep shifting meat with reference to fire as it dries. Head and legs of deer not skinned. Intestines with fat dried à la Eskimo and back fat cut off similarly. Favorite food, pounded meat with garnish of dry back fat.

Dogs poor and much beaten, but not as at Peel River. Caribou skins dried by fire in tent (far off) which Eskimo say spoils skin. Dried skin out, Eskimo hair out if plenty time on hand. Deerskins after hair off in water, dried over fire about ten feet up while wet, later to side of fire far off. Large fire flames often four feet up.

Dry meat toasted slightly just before pounding (ax on stone). Some meat not dry, though no blood. Tent skins sewn head up, head and legs cut off. Some of Indians including this man (Jim) will go to Fort Norman Christmas. The lake is crossed end to end, usually in six days or seven.

No rabbits on Dease River but some E. side of Bear Lake.

"Arrah" exclamation of Indian identical with Eskimo west of Barrow. Indians break marrow bones like Eskimo on the Coppermine on stone with ax instead of stone on stone.

*August 25.* Indians moved to habitual camping place of Jim; two miles west. Says in woods has safe meat cache, wolverine do not climb if legs are of stout timbers, this cache a short day from here — three miles? On invitation took some meat to Indians to be dried in tipi.

Jim's father killed by bull moose, hooked under shoulder blade. Was on trip to mountain Indians to trade tobacco, etc. for the company. Caribou heads never boiled, roasted by fire with tongue in, kept rotating till all baked but nose, then placed on plate with nose to fire a few minutes, then jaws opened and if underdone, placed gaping toward fire. Bear Lake people, he says, do not eat boiled meat if least bit rare, but eat slightly rare roasts, i. e. tongue of roast head. Half-dry and dry tongues boiled, dry meat usually pounded before eating.

Lines of braided deerskin, flat, half inch wide.

In winter travel always use tent at night and do not sleep by fires, as the Cree. Use old tent frames which are numerous on all usual routes of travel and on favorite hunting grounds.

*August 26.* Two men Hanbury saw on Dease River were Good Hope men. Good Hope men are not far from lake everywhere along N. shore. Thinks their houses frequent along treeline northwestward toward sea. Bear Lake people first seen by Hanbury on Bear Lake. Bear Lake people never have tents larger than thirty-six skins nor smaller than twenty-five. If poor skins, tent lasts three years; if good five years.

*August 27.* Fort Rae ("Jim Hislop place") is called seven sleeps from S. side Bear Lake and some Bear Lake people occasionally go there Christmas.



Fishers (no deer) called "sometimes hungry" at head of Bear River, but "people never hungry" east of Dease or along E. shore Bear Lake. In winter Jim says much gambling song, drum, sticks in closed hands, à la Cree. Use head straps in packing.

In cooking, head cut as at Kittegaryuit, and hind leg dismembered similarly. Udder and kidneys usually roasted, liver "not liked," perhaps as Loucheux, think it poisonous, or have it taboo. Thin, cut meat dries in a day, then placed in pile under pillows because of fear of dogs. When "plenty" will be cached on a rack. If legs of rack of stout logs wolverines will not climb, they say.

*August 28.* Brought to Indian camp most of our meat from creek bottom N. a mile. Wolverine had stolen from our rack one backfat and some meat. Indians Catholic service; say do not hunt Sundays, but went for meat, though Jim Hislop saw two moose, one large, in comparatively woodless country. Camp here said to be about half way between mouth of Dease River and N. E. corner of Bear Lake; nearer Dease perhaps, on straight line between these.

*August 29.* Dease River. Built rack for our meat near Indian camp and started homeward along treeline (towards Dease) making this long curve to look for Hornby or some one who has seen him. Camped where valley curves eastward, beginning of our branch of the Dease.

*August 30.* Home before sundown. Met party of about twenty Eskimo going west to camp near our sleeping place of last night. No deer east, they said; a few families gone seaward to fish along Coppermine. Natjinna and Uluxsrak's families gone, took without asking three quarters of our meat, about eight caribou, and cached it by their future sled-making place. Took, too, about twenty deer sinews and two deerskins of ours without permission. An old woman Aialik, left by the food caches. Many have cached meat at sled-making place. This old woman had one breast frozen off last winter and it is tied with a string Pan. says.

The Indians learned to hum B.'s most complicated song (Pí-hjū-ū-lirk-tūñ-a (or puna?), after hearing it two or three times. B. and T. learned this at Akuliakattak and it took them longer it seems to me. Evidently songs of Eskimo not essentially different from Indians. I don't think a white man could learn it in hearing it twenty times.

Indians say they never heard of caribou horns growing smaller in old age. They say the older the caribou, the bigger the horns.

Pan. says Kagmallit habitually use water pails and cooking pots as receptacles for urine.

*September 1.* Moved to woods near where cooking lunch Aug. 21st. Camping in old tipi after dark, made no tent.

*September 3.* Kogluktok people say they have had visitors before who were "nagga" from east no doubt.

*September 9.* Expected to meet my crowd coming west, but B. not home yet. About 10 A. M. Pan. heard eight or ten shots fired in quick succession a quarter mile or less S. W. of us. Did not look as she thought it was I coming home, though I am not in the habit of firing such volleys. Had difficulty restraining dogs from following the shots. Went to old Indian camp in evening, hoping to find traces of people, but found none. Would give a good deal to know who fired shots and where they went. Have only about two pounds meat in camp but shall nevertheless spend day hunting around for traces of people.

Made fifteen mile circuit to S. and S. W. but saw no people or deer. Coming home saw a mile E. of our camp in our river a tent frame I have seen before. The people who fired the shots must have slept there, and passed west quarter of a mile S. of us.

*September 6.* Taboos. Pan. says Noatak, Killirk and Kuwok people, and perhaps others cooked mountain sheep and caribou in different pots on different fireplaces when cooked at same time. If cooked at successive times, the pot, if they had only one, was carefully washed with water between times. Some people never ate caribou and sheep the same meal, others ate both together. Women did not eat sheep off any of the four legs or front of the rear line of the shoulder blades. If they did, their husbands would become sick "inside" (i. e. lungs, liver, stomach, etc.). Prohibition did not apply to women past childbearing. Of the shoulder vertebrae, the women might eat the meat above the line of the ribs, but not the fat and meat facing into the thorac cavity below the rib line. People that ate sheep and caribou same meal, washed hands with water between the two courses.

Old men, and they only, often wore pants same style as women, socks and pants one piece. This "because they had ceased to make long journeys."

*September 17.* Hornby and I to his camp-cache at last rapid, Dease River. Hodgson and family there, building log house. Lives in combination tipi and wall tent. Hodgson says at Peel River Eskimo always carried knives in hand all day, in store trading, etc., as late as 1896. In 1885 Indians between Porcupine and Yukon River usually hunted moose with bows though they had guns and a few still wore the old type clothes (pants and socks in one piece like Eskimo women) though they had cloth. Loucheux more afraid of Eskimo than vice-versa, as it is here at Bear Lake now.

Very marked break in language between Loucheux and Good Hope but nowhere else till one comes to Cree to south. No great difference from Loucheux down Yukon so far as Hodgson knows.

*September 20.* Melvill and Hornby agree that Slavey, no more than Eskimo, can understand that time and labor (even hired labor) spent in carrying goods adds to their cost or value. They also have many stories of their business stupidity. One man they deputed to buy meat for them. He paid for the meat with a shirt worth six skins. He brought the meat to Melvill and Hornby and wanted six skins for it because he was bringing them six skins worth of meat, and another six skins because he had given away on their behalf a six skin shirt. They were finally forced to pay both bills; as otherwise they would have acquired among the Slavey a reputation for dishonesty.

*September 21.* B. tells when Eskimo saw Melvill and Hornby's smoke (the same day B. and T. got to them), he and T. had difficulty restraining them from moving camp at once. They said they were "not afraid of the Indians, but it was their immemorial custom to move away if they saw smoke." It was only on saying the camp was as likely as not a white man's camp, that they stayed. As it was, it was several days till T. could induce any of them to visit the strange camp with him.

Melvill and Hornby's "Tom" has hunted N. W. to salt water and points out on the chart the bay west of Cape Bathurst as the place big ships used to winter. He is wrong in this. It was Langton Bay the Indians used to visit. He says that to go straight from here one would have to cross large stretches of barrens on the way to where the big ships used to go. This he believes a gameless country and says that the Good Hope people do not hunt there any longer as they always starve (in recent years) when they go there, as they sometimes do in hope of getting musk-oxen, which Tom says are all, such as there are, well to the right of a line drawn from here to Langton Bay.

*September 25.* At Hodgson's. At Trout Lake, eight days west from Providence, are twenty-five or less hunters who trade alternately at Providence, Vermillion, or Liard. They are pagans. They come, some of them, every year about Christmas to Providence. They are called more enterprising than any others who trade at Providence. They speak a dialect of Slavey. They live in a good game country. They do not visit other Indians, nor do families of Christian Indians hunt among them for a year's visit, as other groups do with each other. Women never come to the trading posts. Occasionally a few come in canoes down Beaver River twenty-five or thirty miles S. of Providence and go home up Yellow Knife, about eighty miles, north of Providence. This is outlet of Beaver Lake.

*Wolves and Deer.* One year in the '70's there were extensive bush fires between Bear Lake and the Mackenzie. Before that, caribou used to pass in great numbers between the lake and the river, but were apparently

turned back by the burning of the moss which to this day has not grown up in the burnt stretch and have never since passed south or north, west of the lake, but only east of it. That winter wolves numerous west of the lake, but starving and frequently attacked Indians, in one case a single wolf entered a lodge and attacked a woman alone at home. Husband fortunately returned from hunt as woman was fighting with wolf and shot wolf inside the lodge.

An interpreter of Hodgson's, said he once shot a large caribou, breaking one hind leg. He pursued deer, which disappeared over a ridge quarter of a mile ahead. Snow was deep. When man got near top of ridge he saw wolf had cut into trail and was following caribou from the tracks. Soon both came in sight quarter of a mile ahead. Wolf was close on heels of caribou, still running, and now and then made a jump, landing on animal's rump and tearing out a mouthful. Soon deer fell and wolf pounced upon it, tearing away at rump. Indian fired at long range, missed wolf but scared him off. Deer got up and tried to run but was weak and Indian killed it next shot. It was a fat deer, and wolf had devoured almost all backfat but had not otherwise bitten deer.

Hodgson's interpreter saw two deer, yearlings, feeding at a distance and a moment later three wolves came in sight of deer. Two stopped and lay down to leeward of deer and third wolf circled till deer got his wind. At same time as they got wind he gave long howl and started for deer. Deer ran straight before wind towards the concealed wolves. As they got near wolves made a dash, one for each deer, and before Indian could get to them both deer were dead and partly eaten.

Nine years ago, the year before Hanbury, Hodgson was on Dease River. Fort Confidence was then standing, piles of firewood, several cords, were as dry and fit as if chopped year before. Sleds, several, in good condition for use. Houses and everything since burned by Indians. This year near Dease's mouth Hornby found sled, evidently built for hauling a boat with a keel. Sled badly decayed. Seems probable it was brought by water from farther up river, as it is in a pile of driftwood.

*September 27.* Dease River. Pan. has been told that the people who hunt here to the woods every year make various articles of wood, beyond what they need, for trade to the Puiplirmiut.

*September 28.* Pan. relates that Noatak, Kuwûk, Kanianik, Kagmallik and affiliated people used to use in summer when traveling by umiak or camped on streams, a tent resembling an Indian tipi. It was a rectangular pyramid with only the four corner sticks meeting at the apex. A foot or two below apex was a hoop much like the frame of an Eskimo drum. To this there were fastened willows (large number) running to the ground. Some

four feet above the floor four crossbars made a rectangle strengthening the corners posts and willows. The largest tents were about the size of Bear Lake tipis (36 caribou skins). There seldom was cooking done inside and the vent in the top was for smoke used in smudging mosquitoes. Meat, clothes wet from rain, etc. were sometimes dried in tents, a fire being then used.

**Dog Language.** Dogs are never addressed imperatively in first person, always in third. Lie down, *akūvillī* (let him lie down), not *akūvittīn* (you lie down). A dog is forbidden to do a thing by words which, if literally translated, or if applied to a man tell him to do it. *ūyōriūñ*, don't fight with him (literally "fight him"); *něrkiksran parkittūtīn* — you have found something you must not eat (lit. "you have found something meant for you to eat"). *Kī, kī, kīlamīk* (literally, come, hurry up!) is often used by my Eskimo to dogs who will not stand still when their pack is being fixed. It really equals our "be quiet."

*September 29.* P. relates: The *Ir'riḡak* is a *turnrak* that lives in the woods. They are very numerous in some localities. She has never had a front view of one, but has seen one walking away from her. It looked much like a man and was about as tall. It had a coat on, probably of squirrel skin, and it was so torn there were only shreds left, and P. could see the bare back and ribs (*kattīgak*). It had no hair, but so far as she could see skin like a man. It is a very troublesome *turnrak* in that it steals squirrels and *ptarmigan* from peoples' snares and traps. She has had it steal squirrels from her snares. The squirrel was always replaced by a little earth, moss, or grass; that's how she knew the *irrigak* had been there and that it was not merely a case of the squirrel having escaped. B. contributes that once he was out snaring *ptarmigan* with an old man. They got very few. The old man said that was no wonder as they were in a locality infested by *irrigak*. B. pointed out he had seen no strange tracks in the fresh snow. Naturally not, the old man said, for it is one of the characters of an *irrigak* that it walks without touching the ground. When seen they seem to be walking on ground, but as a matter of fact their feet never come nearer than about six inches from the surface of the ground or snow. B. has never seen one.

B. says his people when on the seacoast sometimes used to live in *tipi*-shaped houses made entirely of driftwood. If big, the sticks were split, but most of the sticks were round. They were fitted closely together. At *Kittegaryuit* T. says rough houses were used such as I have seen with big spaces between logs and used to smoke-dry fish. People often sat in these by the fire, but had a regular tent besides.

The Copper Eskimo have repeatedly told me the cheap butcher knives I brought for trade are fine knives because they bend easily. My own knife

none of them care for because it will not bend. Hodgson says the Porcupine and Yukon Indians had exactly the same test for the goodness of a knife. At Barrow and Mackenzie, now at least, they will not have a knife if it bends. They don't like anything lighter than a Wilson nine-inch blade (at Barrow at least), which they cut down with a file to seven inch to give a point.

"Jimmy" says arrows of Bear Lake people were much shorter than those of Copper Eskimo. T. says the same thing for Kittegaryuit as compared with Coppermine. Both Barrow (?) and Kittegaryuit feathered arrows with much longer and better feathers than do Copper. B. people still use bows a good deal.

T. says that while camped on the hill on the river bank above (91 mile S.) our present camp the Eskimo sometimes killed as many as four deer in one day per man, i. e., two or three men out of eight or nine hunters frequently reported three or four deer killed that day when they came home at night. Some days no one hunted.

*September 30.* Bear Lake Indians know nothing of the danger of dogs eating a deer's windpipe that has not been split down the middle, so Jimmy says, and I saw him feed several windpipes to dogs without bad results. B. and P. believe dog liable to die if windpipe not split. T. never heard of this, but says windpipe never fed to dogs at Kittegaryuit because people liked eating it too well.

Jimmy also said his people believed that the older a bull caribou the larger the horns; while B. and P. say a very old bull has small (slender) horns. I believe Indians are right in first case and Eskimo in second.

T. relates some years ago he saw Alūálūk (native of Cape Smythe or Point Barrow, but has been so long near Kittegaryuit that he speaks almost like them) strip to the waist, seat himself on the bare floor in the center of the house, and have two walrus tusks almost as long as his arm (but slender — about size of man's thumb in diameter) grow gradually out of his mouth. The tusks had been inside his chest reaching down to the stomach and he groaned with pain as he forced them up through his neck, and out of his mouth. Soon after they had attained full length, they disappeared back into his mouth, gradually but after several people had felt of them. They were hard and smooth like ivory. This performance was in the evening but the house was well lighted. T. firmly believes this was genuine; i. e., no sleight of hand or make-believe. B. contributes he has known of one "doctor" who spent four days under water and came out unharmed when everyone thought him long dead. Another "doctor" (A'pōkērk, whom I know) B. himself tied as thoroughly as he could, all the house then turned their backs. They heard a loon's cry and the noise of wings. When they

looked again A'pökërk was gone, had flown through the window. This B. thinks may have been trickery, he may have untied himself and run out through the door. The story of the four days under water he firmly believes, however, apparently because he did not see it and has it on honest men's hearsay from other honest men.

Yesterday to the sled-making place, expecting to find Hūprök, but found instead Nirak Talik's crowd, five families in three tents. Hūprök, they said had started north two sleeps before we came, carrying their sleds on their backs.

At lunar eclipse, Melvill tells, circle around houses and toss pieces of meat, fish, etc., in through door of each house. This brings plenty game and fish in future. They keep up continual shouts. Do not use drum except in dance.

*October 8.* Athapascan Beliefs. Mr. Hodgson has a quilt made entirely of the legskins of lynx. He says that all over the northern Mackenzie Valley a man who kills a lynx always cuts off all its feet and brings them home separately. He has asked the reason and been told that once long ago a man killed a lynx and put him into his game bag. The lynx came to life on the man's back and scratched him badly. Since then the precaution is always taken to cut off its paws. Jimmy Soldat says he has given up this practice now.

When a hunter brings home rabbits he always throws his day's catch into the tipi on coming home, and the woman sings the nose of each rabbit separately at the fire. Mr. Hodgson has been told this is to prevent them from eating the snares. The custom is universal where Mr. Hodgson has been. Jimmy S. says he and all Bear Lake people practise this, but he says he does not know why.

Mr. Hodgson says Providence Indians are the most "superstitious" in the north. Few if any of them dare to hunt alone daytimes, to say nothing of sleeping out alone nights. They practise numerous ceremonies and charms not seen elsewhere, nowadays at least. They are all catholic, and have been for over fifty years. Are considered by both traders and priests the worst Indians north of Slave Lake.

Beliefs. Pan. told some time ago that "Kádzōm nū'nanī in'opta," (the winter I was at Kittegarynit, when several families in the mountains south of Shingle Point had to retreat on Rampart House where Mr. Kadzow outfitted them, the same families whom I visited in October, 1906), they at one time had nothing to eat but a little caribou fat. They used to make tea, of which they had plenty, and then boil over the steeped tea leaves in a little water and add the grease (much as we did with seal oil in December, 1909). Kūnas'luk and his son Pik'kalō alone would not eat this mess for

the missionary had told them not to eat tea leaves. When taxed with having eaten tea leaves before, they said that was before they were told by the missionaries not to. I asked Pan. why the rest of them ate tea leaves when they knew this from Kūnas'luk. She seemed to think the question silly and replied shortly that it was all right for them to eat the tea because none of them had ever been forbidden to do so, i. e., K. and P. took the missionary's simple statement that the tea liquor only was meant for consumption, to be a personal taboo inflicted on them individually by the missionary and having no force for anyone else. In Dec. 1909, when we were hungry, Kūnasluk was the only one of our party who did not eat tea leaves soaked in oil, but took the oil "straight," I did not attach significance to this then, but understand it now.

Pan. also tells that it is dangerous to leave a sleeping child alone in a house, even for a moment. She has known one case. One spring two large parties had met to dance and trade, the one Kurrermint, the other Indians. An Indian mother, who probably did not know of this danger, was dancing when she heard her baby begin to cry. She went to it, fed it, and it soon fell asleep. A little while later she went out to get some meat from a stage at the tent door. She was only gone a few moments, but when she came back the child was missing. The people stopped dancing and searched all day but found no signs of the child. It was not old enough to walk, besides no one had entered or left the tent by the door, as the mother had her eye on the door all the time, as Indians usually do fearing dogs. The people all agreed the child had gone up to the sky to Jesus because of being left alone. Both Indians and Eskimo were christians.

Pan. has told further that formerly añ'atkūt used to bring back from the sky, sun, moon etc., where they went on spirit flights, songs taught them by the spirits they had been visiting. Now all the añ'atkūt are christians and some have ceased to fly as formerly, but the spirits come to them in dreams instead. Other añ'atkūt still practise spirit flights, but now they go to heaven where God and Jesus are, instead of going to the sun and moon as formerly. As formerly, both in dreams and in flights to heaven, they learn new songs, which they sing on their return to prove the truth of their story of the dream or flight. Sometimes the song is taught them by God, sometimes by Jesus, sometimes by an angel. One case is that of the Otürkagmiut (mother, Oturkagmiut; father, Napaktogmiut) Pápěřök. This man's name was formerly Pátík. "When he was being converted he dreamed that a man came to him from the sky and said: "You are called Pátík, that is a bad name, for it is the name of a turñrak, hereafter you shall be known as Papěřök." This, Pan. explains, she thinks was the name of the man who descended from the sky, who gave his name to Pátík. The man



then taught him a song: *í'l a aira ūhūlahū''la pag-ma ū-pīñ-a-a cū'-pī-ra-ō-hū-la-hū''la*. This is all Pan. knows of the song, which is long and consists partly of words which no one understands except she supposes Papēřok himself. She knows the whole of the song to hum it. The tune reminds me of several common hymns and the *ū-hū-la-hū-la* part sounds like ragtime. She annotates as follows; *i-la(ñ)* (nom. case, subj. of *ai-ra*) [B. however, thinks *i-la(ñ)* nom. sing. = *ō-ma* (he, that one)] one of them, literally, part of it; *ai-ra*, he brings it home (a dead man to heaven, P. says); *pag-ma* = up there; *ū-pīñ-a* = *ū-pīrk-tok*, he speaks truly (?) or he has a well founded faith in (?), (cf. missionary's use of *ū-pīk-tok*, for he is a christian); P. thinks *cū-pī-ra* may be intended for *cū-pī-va-ūñ*, what is he doing? or she says, it may be some secret word; *ū-hū-la-hū''la*, she does not understand; (may be from hymn "Holy, holy, holy, Lord God Almighty" or from *ū-la-hū''la*, the Kanaka? jargon word for "dance"). Paperok has never been called Patik since he had this dream; he has had many dreams since, at each of which he was taught a song.

*October 14.* Pan. says of mother who lost child, noted above, that it happened before she was born, but she knew personally several people who had been present at the dance. Her own mother was one of these. People did not know until this occurrence that it was dangerous to leave a sleeping child alone, but since then they have known it.

Tan. says Kittetaryumiut had no horn dippers, either musk-ox or sheep, except spoons for scooping ice out of holes in setting nets, etc. These were usually musk-ox, sometimes deer horn or even wood. Never used "snow-shoe-like" type I have seen among Kuwūk, Noatak, etc.

Mrs. Hodgson tells that when she was a little girl at Fort Norman her father used to spend all summer with the Company's scows and she lived with her uncle (mother's brother). Each group then kept very strictly to their own hunting grounds and only in extreme need followed game into a neighbor's territory. Once her uncle, she does not know why, decided to hunt farther west than usual. Though they were near the western boundary of their proper district they went three short days' marches farther west. On the third day they found a stage with dry meat and fish and plenty of baskets and stones from which they inferred the owners had no kettles and boiled their meat in baskets with hot stones. They saw no iron at all, although there was plenty of household gear. They were all thoroughly frightened, and immediately turned back, but by a different way from the one they had come. On the march children were usually allowed to play in the rear of the party and to straggle along as they pleased. In this case they were not allowed to play at all and were cautioned to silence; on the retreat they walked ahead, instead of behind, the stoutest bringing up the

rear. They traveled far into the night, and finally camped without a fire and without chopping or making any noise. The dogs were all tied and each fed more than usual so they would not howl. Long before sunrise they again broke camp and marched till dark, when they first made fire on reaching their own ground. The Loucheux, she says, seemed to be a bit freer than the rest in their wandering about. In recent years none seem to fear visiting their neighbors or wandering about freely except to the northeast of Bear Lake where there is danger of falling in with Eskimo.

Moose. Mrs. Hodgson tells that when she was a child (perhaps forty years ago) there were no moose or deer west of Norman east of the Rockies, and the mountain Indians depended entirely on goats instead. Now no one hunts goats, as it is hard work and moose are plenty and easy to kill.

(P.) mam'-mīrk, inner part of any skin (deer, seal, etc.) that is or may be scraped off to make skin suitable for clothes. Seal skins have this usually removed among Western Eskimo, but not in Coronation Gulf. Western Eskimo leave it on seal boots that have the hair in (for spring) and on deerleg waterproof spring boots.

(P.) ma-mīñ-ērċ-shak, skin that has had "mamirk" removed.

pū'yūviak (P.) is the name used by the Killirmiut for snowshoes with a sharp toe (Bear Lake style). It is seldom referred to as tagluk which is the name of the round-toed type. Both types of toe are in use by both sexes indiscriminately — though more "tagluk" than "puyuviaks" (P.) i-gan (g, Icelandic saga) is used by the Kaviragmūit for kettle or pot, (ū't'kūsik, which is not used).

*October 21.* Animal Heads. Hodgson tells of all Indians of lower Mackenzie: Do not like to allow animal heads to be taken out of country. They fear scarcity of animals.

*October 22.* Taboos. Melvill tells that until Maccallum started a crusade against it, Bear Lake women had separate (usually brush) huts at time of monthly periods. No woman may step over a fish net or go over one in a canoe. It brings bad luck to the owner of the net. A man who carried a deerhead on his back must not walk along the trail but must walk on the side of the trail. If a bearskin is carried across Bear Lake it spoils the fishing in the lake. This applies to sleds; M. does not know if it applies to a canoe. Woman during menses must not walk in the trail. When a boat passes a spot where an Indian has been drowned, they toss a little tea and tobacco into the water. A priest at Fort Good Hope once caught and kept a live caribou, since then there are no caribou at Good Hope. People do not like to kill mink or otter even now. A wolfskin must not be kept in the house as women will have no more children. A man last winter would not sleep in McKinlay's house because some otterskins were under the bed but took them outside.

*October 23.* When wind on the lake is too strong for fishing or for hauling, a woman who has a child at breast goes out-doors and squeezes her breast so as to send a squirt of milk up into the air. This stops the wind, though not always promptly nor on the first attempt.

*October 31.* Windows. T. tells Kittingaryuit never used ugrug or beluga intestines for windows, used by preference the gullets of gulls. P. says she has seen at Baillie Island gullets of the various loons in use, but if these were not handy, they used fish skins of anoxlirk, ekaluakpûk, and others.

Snares and hooks both used at Kittingaryuit to catch gulls. Snares for feet set in a roofless house that had meat bait in middle of floor. Hooks always set in water.

*November 1.* Clothes. T. tells that the Kittingaryuit people never used a separate string around waist to support pants, but string was threaded through pants as it is through boots with short loose ends behind where they were tightened and tied. Leg of pants always reached some three inches below knee, somewhat down on calf. The short pants I have seen there, tied above the knee are an innovation. The Cape Smythe man, Alualuk, was first one T. ever saw with that sort of pants. Pan. says they belong to Kagmallirk and Killirk primarily, though they have lately been taken up by Cape Smythe and others.

Spirits. While alone the other day P. hear pounding in the woods north of camp. She took this for Indians camped near and chopping wood. Later, she heard the noise from all sides as if a man had walked slowly in a circle a hundred yards outside our camp, pounding the trees with a rod as he went. There were no tracks so Pan. knows they were tûrûrat.

*November 10.* En route to Langton Bay. Beliefs. Eskimo from Point Barrow to Baillie at least, believe that in winter smokeless powder is "not strong" and will use only black powder guns if they can, 38-55 and 40-82 preferred. Bear Lake Indians uniformly believe that a black powder bullet "gets cold" in winter soon after leaving the barrel, that great speed is therefore necessary so bullet may reach its mark before it "loses speed through getting cold." 38-55 are said to be the worst and it is claimed that in very cold weather the bullet barely penetrates the skin of a caribou at fifty yards. 45-90 guns are said to be the best of the black-powder kind. This caliber can hardly be given away now to Eskimo.

Western Eskimo (Pan. Billy) believe eating a caribou windpipe, whose rings have not been split, will kill a dog. I have seen B. slit windpipes of small animals before feeding to dogs. Bear Lake people say there is no danger in windpipes but ribs are deadly and must not be fed to dogs. In every camp ones sees long bundles of ribs hung up out of reach of dogs. This belief unknown to Eskimo, and windpipe belief unknown to Tannau-nirk.

*November 16.* A Big Cave. A Fort Liard Indian who is now dead was out hunting one clear March day. He came to a porcupine track and followed it. The trail led into the mouth of a cave, the entrance the size of a blanket. The cave was dark. The porcupine was not far in front and the man heard it walking over pebbles. He left his rifle at the mouth of the cave, took a club and followed the porcupine, one hand feeling one wall of the cave, the other tapping in front and to the side with the club to guard against crevices or a precipice. Now and then the man stopped, threw a pebble as far as he could to the left, but never heard it strike the opposite wall — it always splashed into water. After a while the man turned back, having his club now in the other hand and feeling the wall with his free hand. After a long walk he came out, took his gun and went home. When he came home he said: "I did not hunt far, I followed a porcupine track into a cave, from the time the sun was there and came out when the sun was there," (pointing to indicate about three hours of the afternoon). "But when did you sleep?" people asked. "I have not slept: I have been gone only a part of the day." "Oh no," they said, "you have been gone one night, you started from here yesterday." He had been a little over a day in the cave following the porcupine. That's why people think there is somewhere in the mountains near Liard a large underground lake with a pebble beach.

The Underground River. There are two fishing lakes near Fort Liard, one a day from the fort and the other, half a day from the fort. The two are on opposite sides of the river and in opposite directions from the fort. A man fishing in the lake a day from the fort used a birchbark dish as a buoy for a hook, the line being sewn to the middle of the bottom. He thought, "No fish is strong enough to swamp this dish, it will be an excellent float." But the next day the dish was gone, a fish had taken the hook and swamped the dish, pulling it down with him. The man looked long in vain for the dish.

A man of another group of Indians was fishing on the other lake, a half-day from the fort. He saw something floating and moving. He paddled to it and picked up a birchbark dish with a jackfish fastened to it by hook and line. He thought some "mad men" might have been fishing in the lake and this was their dish. He did not, therefore, try to find the owner.

When next fur trading time came, all people from all sides gathered at Fort Liard. The man who had lost the birchbark dish happened to see it in the tent of the finder, he knew it by the arrangement of some porcupine quills on it. He asked, "Where did you find that dish?" the other replied, "It was a float on a jackfish, I picked up on our fishing lake." That is why people think there is an underground channel between these lakes; the

channel must lie under the Liard. The lake where the dish was lost has never been successfully sounded. Once a man cut a big bull caribou into babiche and sounded with a big stone. He found no bottom. He then took the babiche of half a second hide, but this was not enough, so he gave up, and no one else has succeeded. The men concerned in the losing and finding of the dish are both dead, but they died not so very long ago.

*November 26.* Horton River. Johnnie tells that "long ago" Bear Lake people had runner sleds for use on lake. They made the runners of "red sticks." When they stayed long in one place fishing, they made a lodge-shaped house of sticks, placed close against each other, covered with a thatch of spruce-bows, and this again with snow. B. has told me his people used tipi-shaped houses occasionally in summer, the sticks being usually split, and fitting close against each other. Cf. smoke shelters of Kittegaryuit in which people often sit daytimes though they seldom or never sleep in them.

*November 29.* B. tells: Coppermine Eskimo told him that the lake into which the Dease flows is small and that seen from Huprok's this summer (the east end of Bear Lake) is large. There is no connection between the two. The large one is called Imarryuak, the small one has no name. Dease River, so far as B. ever heard, has no name except Imaernirm kūāñu. People told B. that when near the woods of the Dease they are especially careful to place their camp in a commanding position for fear of the Indians cf. Billy's own country where ancient stone and wood roofed houses are on highest hill tops. Said to be from fear of East Cape (?) people, who made terrible summer forays.

*November 30.* Bear Lake people, same as Eskimo, practise leaving a caribou unskinned over night "to improve the meat." Caribou tracks seldom found on the north shore of Bear Lake farther west than the middle of the lake, in summer at least. Most winters snow so deep on Caribou Point, Bear Lake, that deer travel in set trails only. Beaver spreading into many localities where it was not a few years ago. Notably to E. of Bear Lake. Moose are also spreading. Last winter (1909-10) was the first when starvation was general among Good Hope Indians on account of failure of caribou (i. e. in the district mapped as the basins of River Macfarlane and River la Roncière) (Johnnie).

The year Hanbury passed, Johnnie shot on Caribou Point, when at their fattest, eighty-three large bull caribou in two weeks; number killed limited by number he could take fat and ribs of. Another man of the same party killed one hundred sixty bulls in three weeks. A party of eleven men loaded a York boat in three weeks with fat and ribs only, and crossed back to mouth of Bear River, whence they all came for the hunt. The caribou are always to be found at Caribou Hill.

When Johnnie some fifteen years ago crossed the mountains west from Simpson toward Telegraph Creek (just after Christmas) there was plenty game, chiefly moose, except for three days crossing the crest of the mountains, where there are no sticks. Game chiefly moose.

Bear Lake people, for crossing the lake in winter, wear caribou skin pants with hair in à la western Eskimo. Bull caribou skin in the fall is stronger than moose skin for shoes (J.).

Billy's grandmother remembered the last fight between the Kaviarmīūt and the Khōdlit of East Cape. She was so old when B. was a boy that "her skin was not like human skin, but hard and black," and "she had almost come to nothing" (our "shriveled up" nūñūpīūrāktok). B. found some arrows of the battlefields. The East Cape arrows were of iron and had a very slender shank just below the head, but shafts otherwise about size of Eskimo arrows.

*December 14.* Langton Bay to Dease River. Johnnie is quite unreliable in what he tells about "long ago." He asserted tonight that the Bear Lake Indian always had stone chimney places of the type we saw together in the ruins of Fort Confidence; also, they always had candles. The latter may conceivably be true, the former surely is not.

*December 30.* Dogrib Feast. Johnny says that "when Dogrib Rae Indian make a big feast for plenty people to eat," they take a small piece of meat, fat pemmican, bread, and any other food they are about to eat, then a cup is taken and a little grease and bouillon is skimmed off the top of the pot in which the meat was boiled. This cupful is spilled into the fire and then are thrown in the pieces of meat, pemmican, etc. This must be done before anyone starts to eat. "This is Dogrib fashion; Bear Lake people don't do like that."

*January 24, 1911.* Dease River. Race Blending. Arrv̄yū'nna was the "Eskimo George" of whom Hodgson tells, who was the company's interpreter at Peel River. He is long dead. His wife was an Indian and his three children are living among Indians. One of these three was born with one arm wanting.

Niūttjiak is now living among the Peel River Indians and has an Indian wife. Both these men belonged to the Kittegaryumiut. Irūan'na Kittegaryumiok (?) had an Indian husband for some time and lived at McPherson. Memoranna may have had an Indian father. Tan. knows one Peel River Indian who lived at Kittegaryuit; he was a grown man when T. first remembers, and T. used to call him "Añayūra (my older brother) for no reason known to T., except people told him to do so. This man died while T. was yet small. All, or most of the fingers of one of his hands were wanting from birth. This man was unmarried.

Loucheux-Eskimo trade. Mr. Hodgson, when at La Pierre's house, knew an old Indian who bore the nickname "Husky" because he used to cross the mountains every year to trade with the Eskimo on the coast. This was one of the men told about before by Mr. Hodgson who used to make trips south of Rampart House and buy for the same price he got from the Huskies, wolverine skins for trade to the Eskimo.

Use of Bows by Loucheux. As late as twenty-five or thirty years ago (if not more recently Mr. Hodgson says) the Loucheux of Rampart House frequently came to the post with only bows and arrows, though they owned guns. They explained this was "because they were hunting moose," as they preferred the bow for this use. Bows are still in use in almost all parts of the Mackenzie, though in some districts use is confined to women or to shooting birds and rabbits.

Shape of Snowshoes. The round Yukon toe is now, at least in use on Bear Lake for women. Harry Hodgson says, a shoe may be the proper woman's shoe, however, so long as the toe overlaps and is lashed. The men's shoes have this toe, a slight knob and lashing confined to one groove around the toe, as far south as Providence. Loucheux only, use round toe for both sexes. Kitegaryuit Eskimo had the same toe as Bear Lake, but perforated and laced instead of lashed and no knob. Tan. does not think women's shoes differed from men's. At his place B. says (inland from Port Clarence) the men had the sharp toe as at Kitegaryuit and women slightly rounded. Pan. says the people of the Colville had the round toe (Yukon) for both sexes, but the part of the shoe in front of the foot was generally narrower on women's shoes.

Conservatism. Our house, though in a clump of spruce woods, is floored with large, crooked willows. "There are few good willows," they say in explanation, but they won't put spruce boughs for "they are not as good flooring as willows." Anderson tells that on the Chandelar River in 1908-9 they often went far and spent a long time in getting willows for the floor of a one-night camp when spruce were at hand and could be secured in a quarter of the time. On the Chandelar, too, they used to camp on bare sand-bars in the middle of the river and carry firewood a quarter of a mile when they might just as easily have pulled their toboggan in among the trees to a good campsite.

These toboggans by the way, were made the same width as the big runner sleds, so that the man walking ahead could not break a trail through soft snow more than half the width of the sled. Neither do they really try to break trail, they merely walk ahead of the sled, and that generally on big snowshoes that go on top while the dogs behind flounder to the belly. And all this in spite of the fact that most of those Eskimo who go to the woods at

all are familiar with Indian methods and have themselves been among woods in winter since children, and so their fathers before them, e. g. Kuwurmiut, Napatogmiut, the people south of them and the Colville people who hunt south of the mountains, chiefly over the Itkillik River pass.

Eskimo Pemmican. (Pan. says) Eskimo make pemmican occasionally, but only as a food for children. She has seen it made only of dry pounded back-meat and bone grease of caribou; more often a similar food for children is made of bone grease and boiled back or leg meat minced fine with a knife. Tan. knows of no such food, nor of pounded meat except for making akutok, and not even that is often made there, though a favorite dish. The Coppermine people make akutok occasionally, but only with seal oil as well as deerfat and "could not" therefore make any here last summer. Around the Yukon akutok is made of fish more often than meat, and often without deer fat. In the latter case snow is stirred in to make the grease thick.

Comparison of Eskimo and Indian Customs, Character, etc. It may be that I am scarcely fitted by experience for a just comparison of the two people, but then a comparison may never have been attempted by anyone better fit. Anyway, the following is set down, with some diffidence far as Indian character goes; as to hunting methods, camps, etc., here there is little chance of my going far wrong, as I have discussed what I have seen with the Hodgson's, Melvill, Hornby, and the Indians themselves. Johnny Sanderson, while quarter or half white is an Indian in bringing up and in his ideas.

The Two Peoples as Travelers. The Indians carry less impedimenta in winter and in that matter have the advantage. The Coppermine Eskimo, who carry less than any other Eskimo I know, always carry the table and other wooden furniture that goes with the lamp, besides the lamp itself and the cooking pot. They carry no tent in winter, but the Indians frequently also travel without the lodge, making "open camps" in the wood. When tents are carried, the advantage in weight is with the Indians, for the lodge weighs no more than the modern tents of the Western Eskimo and the Eskimo carry the willow framework in addition, bulky and a little heavy. Pitching camp seems to take about the same time with the lodge and the beehive tent. But when the tent is once pitched there is no comparison in comfort. In fact, the word "comfort" is out of place in describing a lodge camp, at least in cold weather. But thrust a foot clad in a woolen stocking (skin would burn) as near the fire as you can bear it, and hoar frost will form on the back of your toes. It is almost impossible to dry anything, as steam rises in clouds from the snow-covered ground from the cooking and from anything in fact that gets warm. Frequently, I was unable to see Anderson's face, though he was my next neighbor, for the steam from the



ground. This steam condenses on the away-from-the-fire-side of any garment hung up, and alternately condenses and melts on the fire-ward side, as the fire varies in heat. If one attempts to bank the tent, it smokes, and if one camps in a low place (valley) it usually smokes anyway. This is hard on the eyes besides the moment's discomfort. Anderson was nearly blind some days and suffered considerable pain.

A lodge cannot be tolerably pitched unless at least a half-dozen poles be found of a length three or four feet greater than the height of the lodge or poles thirteen or fourteen feet long, and to be well pitched the smallest lodge should have twelve poles, while I have seen eighteen used, and seen old lodge frames of over twenty. Then from a quarter to a third of a cord of good dry wood is needed for the night (say three hours) and for breakfast (say two hours) and if one remains in camp all day a cord will be used up in cold weather. A beehive Eskimo tent can be pitched anywhere on ice or land, it furnishes some comfort though no wood be found, and a stove and two or three armfuls of wood, such as a farm boy carries to the kitchen stove, will cook two meals and dry one's clothes, keeping the tent so comfortable that one can sit in shirtsleeves or stripped, Eskimo fashion.

Two points of advantage the lodge has over a tent. It dries deer meat or fish faster than any other ordinary way, and keeps off bluebottles and gives an agreeable smoke flavor. Back meat or sinew meat cut thin is thoroughly dry in two days. This sort of meat has the place most nearly over the fire; it is intended for making "pounded meat" and pemmican. The boneless ribs are half-dry in the same time, though hung farther from the fire. Ribs the Indians never thoroughly dry, as they are intended for boiling.

In the matter of which are better long distance runners I have no opinion of one's superiority over the other. There are many white men who state positively the Indians are much better, but these are, so far as I know, men who know only the Indians. It is true that the Indians travel faster and stop more seldom in traveling short distances; but the apparent reason, nowadays at least, is that they are so poorly dressed they have to keep moving to keep warm, while an Eskimo is usually, if not always, comfortably warm on the body and can therefore take his ease anywhere by turning his face away from the wind.

As hunters of caribou it seems to me clear the Eskimo are better men. The Indians have about the same methods of driving deer as the Eskimo and if they differed materially I would not be competent to contrast them as to efficiency. They snare more deer than the Eskimo trap or snare but that is through the advantage of better local conditions. But in "straight hunting" the Indian has but one way if trees are absent for cover. He walks

or runs straight at the caribou, shoots poorly at long range, and depends on the caribou's curiosity and frequent stops to get in range at all. This method is equally used by the western Eskimo (the Coppermine people do not seem to use it), but only in one of two cases; when the weather is calm and the snow crusty, too stealthy approach is impossible through the deer's acute hearing; or when the deer have accidentally seen or heard the hunter and further concealment is to no purpose. Otherwise, the Eskimo have the habit of careful approach, and can often get within one hundred yards of a band of deer on even level ground, while if there are several Eskimo their approach to deer is often worthy of the term Hanbury applies when he calls it "a carefully planned campaign." From some point of vantage the ground is studied out (nowadays usually with the use of glasses) with reference to the wind, the direction the deer are moving, etc. It often takes an Eskimo all day to approach a band that an Indian would be shooting at fifteen minutes after he saw them; but then an Eskimo is about five times as likely to get his deer, and does not scare the animals off the hunting ground to such an extent as the Indians do. The method used by the Bear Lake Indians is well enough where caribou, when they come, come in thousands and can be butchered off hand; but in a country such as Horton River, where one needs to kill a large portion of the deer seen in order to live, they would starve, as indeed the Good Hope Indians have been completely starved out of Horton River, their ancestral hunting grounds. On Horton River we can live well by attending to the hunt at proper seasons.

As companions when traveling my experience confirms that of Hanbury (who could contrast Eskimo and Indians from personal knowledge), Pike, Russell, etc. They are always whining when something goes wrong, are always ready to break a bargain, always haggling for more pay, always homesick and worrying about not being able to see their little grandnephews, or other distant relatives. They are afraid to go out of the territory of their own tribe, except along the Mackenzie highways of travel. None of these faults the Eskimo have in general, or at least none of them are so universally evident. Our man Ilavinirk is always worrying about starvation in a strange country, but he has some cause. He has starved, and his health is poor, he has frequently in the past been unable to hunt or travel for weeks at a time. B. and P. have none of the above faults, and T. only some of them slightly developed — is homesick, a little lazy, a good deal thoughtless and very lacking in initiative. The Indians are very much on their dignity, I have never seen an Eskimo who was. Johnnie, for instance, felt very grieved at having to do women's work, cut up meat to dry, find spruce boughs for flooring the lodge, etc. There are lazy Eskimo, but I have never known one of them to refuse doing a thing be it sewing, tending the baby,

cutting up meat, or what not on the ground that he was too important a person to do these things. Few Eskimo will stand being harshly spoken to. They will leave an individual employer or a ship at no matter what loss of pay, etc., promptly if harshly spoken to by the man in highest authority be the reproof deserved or not. Indians, it seems from Johnnie's case and what I have heard will not only stand sharp words, but will be more attentive and better servants if occasionally dressed down a bit.

Honesty, at least "business honesty," is on a higher level among the Eskimo. The Akuliakattagmiut would not accept the smallest thing without paying for it; the Western Eskimo through long training, have become beggars to a degree, but not as the Indians. But if the Western Eskimo promise pay they will deprive themselves of "necessities" and luxuries to meet their bills. An example were the people to whom Cadzow gave credit at Rampart House the winter of 1906-7. He gave them no more than he was accustomed to give Indians as gratuities, but some of them made a three hundred mile trip from the coast (Alēkak, Tūllūrak) to pay bills of three or five fox skins, and carried fox skins for the settlements of debts of others. They were so far from Cadzow that they needed have no fear of his attempting collecting or even seeing him. It might be that Alekak and Tullurak paid their debts to get more credit; this can't be thought of those who sent their furs with these two to pay debts. Most of these, or all, were without a remote notion of ever again seeing Cadzow. As a contrast, an Indian at Norman will run up as big a bill as he can with one trader, and then, before that trader's face, take his furs to a rival trader to avoid paying his debts, and then change his trading post for another when he can get no more credit at Norman. Even now Eskimo take no "debt" from the traders at Peel River, though some are often urged to do so, for the traders know that if they can sell to a man more than he can pay for, that man will bring the furs next year to them, whereas they might otherwise go to a whaler. And having brought furs to pay his bill, he will probably bring also the rest, for he won't have the time to go back to the "Fort" and Herschel Island (to the ships) without forfeiting his chances of the summer white whale hunt and the fishing.

I have, however, known cases of misrepresentation, cheating and real "confidence games" among the Mackenzie Eskimo. There are also thieves, but they are few, everybody knows them for thieves, and they are looked down on, a few years ago they would have been killed.

Comparisons of Ethnological Interest. Tonsure hair-cutting was and is even now by old men, Johnnie says, practised on Bear Lake. It was Mackenzie River Eskimo style, and not like that of Coppermine.

Bear Lake Indians and (all?) Eskimo put bait on hooks alike, lash it

to the stem of the hook, instead of putting it on the point of the hook, as we do.

Bear Lake people had one-piece bows. Kittegaryuit both, though three-piece were the rule and one-piece were toys, children's bows, and women's etc. The Coppermine people have only three piece bows, except very small boys who use a caribou rib or unshaped stick.

Bear Lake people use caribou skin pants for cold weather, especially for crossing Bear Lake. These are (nowadays at least) made in the ordinary Noatak style. Mr. Hodgson says pants and socks were always in one piece on Porcupine, à la women and old men of Western Eskimo. Nowadays, Indians generally consider garments of fur more or less "infra dig," though both sexes wear caribou coats in traveling, the women's coats longer than the men's.

*January 30.* Indian Beliefs. Johnnie and Anderson saw two ravens fly over them the second day out from Langton Bay. One of these kept turning half-somersaults in the air and croaking as he did so, as ravens often do. Johnnie tells that "Indians believe" this is a sign that the men who see the raven do this will soon kill caribou. The raven ducks thus to imitate a man shouldering a heavy load of meat.

*February 19.* Theories of Disease. Tan. says either men or dogs may lose their gall. In that case they become ill and usually die; the symptoms are such as Dekoraluk (a dog) has now, inability to close the mouth, unwillingness to eat, staggering gait and later inability to stand up, etc.

*February 20.* Beliefs. Pan. when small was forbidden to eat at the same meal, berries and seal meat, especially if fresh. They habitually ate berries with old seal oil, but must not use fresh. Grown people feared this prohibition less than children. Tan. says he was forbidden to eat bowhead whale, meat, skin, or oil, while his labret holes were healing.

*February 27.* Beliefs. Pan. says the Noatagmiut, Killirmiut, etc., believe that if a child "before he gets understanding," before seven or eight years, is continually forbidden to do things it wants to do, continually "don't do that," "stop your noise," etc., their ears become like dogs' ears and they are stupid throughout life. If a man has big ears, or is stupid, people know he has been forbidden to do what he wanted to do when a child. Tan. confirms this for Kittegaryuit, but is not sure of the dog's ears, knows that stupid people are so in the degrees in which they have been forbidden to do things. Pan. says it is better to run the danger of a child pricking his eye out with a sharp knife than to forbid him the knife if he wants it and thus have the certainty of making him stupid.

*March 2.* Beliefs. One of the lobes of a caribou liver is called "the thumb," (kūblūa). Mothers that are bringing up young sons should eat

this. (Killirmiut, Noatagmiut, etc., Pan. says). When the boy grows up to be a man and hunts deer, the bands will circle about him in a curve shaped like the outside (margin) of this lobe. This will give him a chance to kill many at once, while if his mother had not taken the precaution to eat this lobe, the deer might have run straight away from him. There is a story ("Unipkak") that tells of this, and a song in it about making the caribou circle as if running around the lobe of a huge caribou liver, but Pan. knows neither.

*March 4.* Pan. tells, a few years ago she and a large party of people were traveling in winter. They had gone up the Killirk branch of the Colville and had reached the head of the Kivirk, which flows into the Yukon. There were a few trees where they camped the night in question. Among the party was the elderly man Kēnōranna, his wife Okī'laērk, their son Tūrnrak or Tu'-yak (a grown man). These pitched camp a little (a hundred yards perhaps) away from the rest of the party. When all camps were made, the rest of the party noticed that Turnrak's party had a fire outdoors and that the old man Kenoranna sat by it, but his wife and their son were inside the tent. Later they heard Kenoranna crying "Let me in, why don't you let me into the warm tent?" Later he began upbraiding his son: "It is only a few days since you ate in one day five ptarmigan I killed. I am not decrepit. I am feeling a little sick tonight but it is nothing serious. I shall not die if you let me in." Later as the strong wind increased (nīgirk) the cries became inarticulate, but were still loud and plainly heard in the camps of the rest of the party, for the wind blew that way. Towards morning the cries died away. Everybody knew that Kenoranna was not seriously sick, and people thought it mean of his son not to let his father in, seeing he was not very sick. Kenoranna had another son, Pūktau, who was away hunting deer. When he returned he was angry at his brother for having let their father freeze to death when he was not seriously ill. Kenoranna's wife cried the next day for her husband. Puktaun and Okilaerk are since dead; Turnrak still lives, usually stays with Aiaki (Kanirkpuk) and is probably in the Mackenzie delta.

P. tells on the Ikpikpuk in summer a boat party was traveling. One boat contained a middle-aged woman and her son, who was sick. He was uncomfortable in the boat and urged his mother that they remain and wait for the next boat party which was coming behind, allowing their present companions to go ahead. So they stayed in their tent and their companions proceeded. But when it got nearly dark the mother was afraid to stay alone over night with a sick man so she started off for the camp (about eight miles away) of the party for whom they were waiting. When she got there she told: "He called after me; 'Mother, don't leave me when I am sick

and our friends are sure to be coming along soon in their boats.' But I dared not stay in the night with a sick man." The next morning they all went to the sick man's tent and found he had shot himself in the night. The dead man's name was Irkaark, his mother's, Akergavik; they were Killirmiut. Akergavik is now dead too. She was the younger sister of the Okilaerk of the preceding story. This happened about ten years ago. Note: This was in the time of epidemic and five members of the party were already dead.

*March 9.* Beliefs. Pan. says Nogatak and Killirk women might not eat the inside membrane of the ribs, i. e., the membrane covering the side of the rib that is towards the intestines or lungs, of mountain sheep or brown bears. They might eat the meat of no part of a sheep that was front of the eighth rib, counted from behind, except as follows: the leg back of a plane bisecting each from leg from the middle of the shoulder blade to the middle of the hoof, and the meat above a horizontal plane bisecting the neck vertebrae from the head to the trunk, i. e. they must not eat the head, ventral halves of the front legs, ventral portion of neck, or any part of the back vertebrae behind the neck and front of the eighth rib counted from behind. They were forbidden also the heart, that part of the intestinal fat that is near the pelvis, and any part of the pelvis itself. They were, however, allowed the kidneys and kidney fat. When eating lungs they must be careful not to eat any of the bronchial tubes. They were not allowed to eat any sheep marrow. A man might eat any part of a sheep. Children of both sexes ate all parts; the first menses put a girl in a class with the women. Women were allowed to eat any part of a caribou, except during menses, when they must not eat caribou heads.

Tan. tells, when he was small he did not believe in ghosts (turnrat), in angels (which he called nelluarimiut kēyūkkat), or in God and was never afraid to be alone day or night. Now he knows of the existence of all these and is afraid to be alone not only at night but also sometimes in the daytime. He thinks a man who does not believe in turnrat or in God deserves no particular credit for not being afraid at night.

Pan. says the beliefs of different families varied among Killirmiut. Her husband believed it was safe for her to eat of only five ribs of a sheep of each side. He told her not to eat of any of the first four or the last three ribs, the ones between she might eat.

*March 12.* Names of Dogs. T. and P. agree that dogs usually have names of dogs now dead which usually belonged to people now dead, most often to the parents of the man whose dog now bears the name. Pan. once owned a team (five or six) all but one of whom had names from folklore stories (unipkat). Of the three we have had, Kañivagok and Ukuñerk had folklore names.

Richardson. Pan. told me that she learned at Rae River last spring that Natjinna who was with us all summer, one of the sons of Ekallukpik, had been named after the white man who came to Rae River when Ekallukpik was a boy. This information Natjinna himself repeated last summer so both Pan. and Tan. heard, though now is the first I knew of it. "Natjinna" from "Richardson" is certainly as close as Velvinna from Melvill and Caunapina from Hornby. For a test, I spoke Richardson's name as we would in ordinary unemphatic conversational speech. Both Pan. and Tan. heard it and repeated it to me as Nätjīsīn.

*March 13.* Iglu. Pan. says the people between the Yukon and the Kuwūk, most of them had never heard the word "iglu" and would not have understood it, had they heard it. At that time there came to them (near St. Michaels) a man who was gathering folklore, ethnological specimens, etc. This man told them that the "Kagmalit" spoke of a house as an "iglu." This they would not have believed, seeing it was only a white man who told it, had not her mother spoken up and confirmed it by saying it might well be so for she had heard the name when she was among the imarxhlit and the Okīōvūgmīūt. Pan. is not sure it was known by the Nogatagmiut, she thinks it was known but seldom or never used. All the Colville people knew it twenty years ago, she says, "for they traded every summer with the Cape Smythe people." South of the Kuwūk the word for a house was "Tūpērgrūk" or some dialectic variant. Itjalīgan'rak was the word for a tent (or Kallrōvik). Tuperk, covered both houses and tents, a common, non-discriminating name. Napaktak, a tent similar to an Indian tipi, though hole in top smaller, and covered when it rained, no fire in summer unless to dry meat or fish. Panapak, was a white man's style wall tent. Nanmaunak was a tent that had a ridge pole and rafters running at right angles to it, usually giving wall tent shape.

Itjak was the name for the ordinary tent cover. It consisted almost invariably of six caribou skins, all legs and heads being left on the skins. Ilavinirk has advanced to me the theory that it was called itjāk because there were six skins (six, itjaksrat) but it is much more probable that six gets its name from the fact that six skins were itjaksrat (i. e., materials for a tent. ĩ-tjak, tent; srak = material for).

*March 14.* Swimming was known by two (Roxy) men only in the Mackenzie district when Memoranna was a boy. Pan. says several Cape Smythe men knew it, but she thinks they learned on their trading expeditions to Nirlik. Both near the Yukon and on the Killirk everybody could swim. Young men and young women often went swimming either in separate parties or together. They used to make a fire to dry themselves before dressing. The maturer girls used to wear breeches, the younger girls and the boys none.

This summer Pan. was told by Natjinna's wife that a few years ago, when they crossed the Dease River, the string broke by which they were ferrying their goods across on a raft. There was no man on the raft. Hūprōk, she said, then took off his clothes and swam (pūbraktuak; to wade in deep water is turñmaktuak) to the raft and tied a line to it so the others could pull it ashore.

When looking for musk-oxen, Natjinna's wife said, they used to cross the Dease (about eight miles above its mouth) and hunted northwest to the edge of the barrens. They habitually use a small raft, one or two men cross first trip, and after that the raft is hauled back and forth with a line.

Beliefs. Pan. tells her husband spent a year at Cape Smythe before Brower came there. He told among other things the following. In the spring when they were about to go out to the edge of the floe to begin looking for whales, each umialik (master of a whaleboat) would take a dish in which his wife had placed four small pieces of mūktūk ("black skin," true skin, and say quarter of an inch of blubber) and whale meat. Going to the trapdoor (houses at Cape Smythe had only trapdoors then) he would stand astride the trapdoor with his back towards the door of the alleyway, face towards the bed-platform end of the house, and throw the pieces one by one between his legs through the trapdoor towards the door of the alleyway. As he did this he said (in part):

Piñōärrūmiūt ōxsrōktōriärittjī (name of a second group of people forgotten by the narrator) ōxsrōktoriaritjī ōxsrōksrāksī mārā. Ōxsrōksrāp-siñnik aiyōgnāaitjūämik aixlirñiäktūgūt.

This paraphrase is not likely to be accurate even for the part of the speech which it pretends to cover, but probably gives a correct idea of the trend of the speech.

Names. At Cape Smythe at one time there were four men who bore the name Appaiyauk. One of these was called Appaiyauagnak, that may have been his name from the first, or it may have been given him later in life to distinguish him from the others. The most prominent of the four was always called Appaiyauk. The remaining two Appaiyauks were given the distinguishing suffixes, -hlux, and -tjiak. Appaiyaxhluk is now dead but Appaiyauxtjiak is the one still living and at present one of most important men at Cape Smythe. When the prominent Appaiyauk died (but Appaiyaxhluk, brother of Tagluksrak's wife still lived) the -tjiak was removed from the present umialik's name. He has since been plain Appaiyauk.

At Herschel Island, etc. and at Cape Bexley and east I have heard of no such distinguishing suffixes being applied to men of the same name.

March 14. Names. A child is named Kēyūk from one of several Kēyūks. The one from whom the child is named is "ōmā ātk'a" (that



one's name), the others are not the child's "name," though they bear the same name.

**Boots.** Boots for long journeys were sometimes carried in large number. Pan. has known of a man who started in midwinter and did not expect to return till spring carrying ten pairs along.

*April 6.* Coppermine River. Started 11:30, camped 6:45. Distance fifteen or eighteen miles. Followed seaward side of island chain extending with few short breaks about parallel to shore. Found autumn snow village of twelve houses on the Limestone Island, seaward side. Saw later autumn track of one sled and found just before camp one footprint by a piece of wood that had been chopped this fall with an adze.

*April 7.* Old choppings (last fall) at camp place, no other signs of people. Found wood enough for one night's fuel on a small point on about one hundred yards of beach — all small broken pieces. In June no doubt plenty wood for sledding camps everywhere.

*April 10.* The Future. For over a century since Hearne first saw an encampment of them at Bloody Fall the Coronation Gulf Eskimo have made little "progress towards civilization." It was probably after Hearne's time that they first saw an article of European manufacture; later they got a few scraps of iron, etc., by plundering the abandoned boats and gear of the Franklin expedition; Richardson traded the Rae River group a few knives, files, and needles, and so did Rae a little later; Collinson's ships traded with widely separated parties at Cambridge Bay and on Prince of Wales Strait and threw heaps of empty tin cans and other waste gear ashore; M'Clure's abandoned ship on the north coast of Banks Island may have become Eskimo spoil, though he never saw Eskimo on Banks Island, as well as some wreckage from Franklin's ill-fated ships on the east coast of Victoria Island. Of recent years articles of iron have begun to come in more freely by overland native trade from Hudson Bay. Firearms and the fur trade are known by hearsay, though they have not as yet penetrated into Coronation Gulf proper.

From the present year, however, change will be rapid. Our unwilling ministrations this summer broke down the walls of fear and hatred that ignorance of each other has till now maintained and that has since effectively kept apart the Coppermine Eskimo and the Bear Lake Slavey. The fur-trading post on Bear Lake River (Fort Norman) is the natural market for Coronation Gulf. The white men there are eager for the Eskimo's furs; the missionaries there are no less eager to extend their activities. Both will go to the sea if necessary to attain their ends. The Eskimo, after familiarity with our outfit for a summer, are set on getting guns, fish nets and tools, now that they know the Indians are really a harmless lot and

friendly. In a year or two the Eskimo would go to the traders if the traders did not come to the Eskimo. And if neither Eskimo nor trader had the enterprise to seek the other, the Indians are eager to act as middlemen between. Commerce in goods may, therefore, be said to have begun; commerce of ideas cannot help following close behind. From the point of view of the ethnologist and sociologist the result of these new forces is clear, the rapid change of ideas, institutions and material surroundings.

Up to the present, three-quarters of the food of the people has been the seal and three-quarters of the year have been spent in its pursuit. The sea has therefore, been their home, the snow hut their dwelling. But the coming of the trader and the acquisition of guns will give the land a lure it formerly did not have and increasingly the people will become land-dwellers seeking furs with which to buy articles to supply their newly discovered wants. At first making a living on land will be easy, for caribou are still numerous. The result will be that the people will live on caribou meat for twelve months a year (some of them, at least) instead of three or four; where they had one dog to hunt seal-holes for them in winter they will now have teams of four or six with which to make long winter journeys (or so it has been in the west of the Baillie Islands) and these dogs also will feed on caribou meat. At present the caribou has in winter a wide zone of safety between the Indians who dare not face the barren ground and the Eskimo who prefer the sea coast. But the Eskimo fear the woodless barrens about as much as a fish fears water, and when the fur trade draws them inland the doom of the last musk-ox will be not a decade away nor that of the last caribou many decades. This will have its effect on those northern tribes of Indians who are still to an extent caribou-eaters, while the disappearance of the caribou will drive the Eskimo back again to the sea coast. They will then have to get all their living from the water instead of three-fourths of it as at present and will have to dress in sealskins where they now use caribou. By then they will have learned tea drinking, tobacco using, etc., and will have lost their economic independence as completely as have all Eskimo west of the Baillie Islands. They will then be less well fed than at present, less well clothed, richer only in ideas without which they now live content and in wants which their poverty will never completely satisfy. The Coronation Gulf people look to the immediate future with eager anticipation; so do also the fur-traders at Fort Norman. As a spectator with no material interests at stake the writer feels that the trader is to be congratulated, but not the Eskimo. In closing a chapter on the Eskimo of King William Land Captain Amundsen says: "My best wish for my friends of the Netchillik Eskimos is that civilization may never reach them." It had reached them even when that line was written, or its wants and its vices had, and that is

all of civilization that is readily absorbable. It is now about to obliterate the last oasis of economic independence on our continent, the populous district surrounding Victoria Island. I would wish these people the same wish that Amundsen did their neighbors to the east, but I should have to put it in a past tense and should have to add a regret that I had a part in bringing the change about.

*April 10.* Range of Ideas. The people east and north of Cape Bexley were probably even in the earliest days among the most isolated groups of Eskimo anywhere. A comparison of them a hundred years ago with the then equally uncivilized Mackenzie Eskimo would probably have, even then, shown in intellectual things a heavy balance in favor of the westerners. However that may have been, the difference in range of ideas today is marked. Unfortunately, the sixteen years of Herschel Island whaling that preceded the writer's first visit to the Mackenzie Delta had made it difficult to determine for that locality what ideas were local there or of ancient introduction, what ones were borrowed recently from the Alaskan Eskimo, whom the whalers brought with them, and what had been absorbed from the white men directly. Nevertheless a comparison will be attempted on the basis of what seems to be local and primitive in the Mackenzie district.

Inability to count in the Coronation Gulf district has a wide direct influence; it is besides an index to their general mental status. At the Baillie Islands and west any grown person can count up to four hundred (twenty twenties); at Cape Bexley, in Victoria Island, and east at least as far as the Kent Peninsula no one can count above five. Even this seems to be a numerical vocabulary beyond their wants. In summer nothing is of so much interest or importance to them as the caribou, yet of all the people we have lived with and hunted with, no one (unless cross-questioned by us) ever used a numeral larger than "two" to designate the number of caribou seen or killed. If there were more than two but less than six they knew how many they were but never told. The expression for more than two was invariably "many" (*ămihūār'yūit*). When we pressed them for more exact details they could tell us "three, four, or five," but with impatience as if ours was unreasonable or childish curiosity. If there were over five the answer would be; "I don't know how many, very many." Of certain things, such as the population of a small village, they have approximately correct ideas of number to and even above fifteen and will indicate this by holding up their ten fingers and getting some bystander to hold up as many more as are needed to complete the total, prompting him by "one more finger" till he holds up the required number. Of such a performance the main performer seems very proud and the assembled crowd finds it highly amusing. It is probable that it is seldom except when we ask questions

that anyone finds occasion to express a number above five. We never heard a man not of our party ask any question in regard to exact number after he had been told "many."

In the Mackenzie district a band of caribou seen is usually reported by exact number if there are less than ten; over that number careful estimates are let suffice, e. g. "over twenty," "less than forty," etc. It is in fact, usually, exceedingly difficult to count caribou correctly if the band is over ten animals.

*April 10.* Started today at 11:45 A. M. and followed sled trail 20° Mag. about fifteen miles to people. Enthusiastic welcome, one or two old acquaintances from our summer on the Dease, the Footless (Itigoaittok) family. Say we have narrowly missed numerous parties of people to the west. Report the "Teddy Bear" wintering just east of Coppermine. Camped in excellent vacant snowhouse, fitted up for us and furnished with lamp and drying rack.

*April 12.* The Pallirmiut who come to Umñmúktok to trade come from a wooded (spruce) river in the south called Pallirk (a branch of the Akilnik?).

The Kaernermiut. The Eskimo who were with Hanbury are called Kaernermiut usually, but are sometimes called Pallirmiut.

The girl *Thyūmätök* is named so after "the white man who came to Iglihsirk on Dismal Lake."

Day occupied in taking cephalic measurements of all but one boy (four years) of the fifteen people here, and in buying ethnological specimens. Prices very different from last spring on account of ship's buying. Most who sold garments cut off piece to throw away, some did not.

Iron Work. There are here some large three-cornered ulus from the Pallirmiut (made by them), many spear-shaped knives said to be made by the Pallirmiut by sawing gun barrels lengthwise and beating them out cold so as not to lose the temper. Knives of files are made here by heating files to softness, working down with a stone and retempering. Blubber pails are like water pails except shallower and wider.

Cooking. Seal blood is kept in large pails of "Nelluak," one seen was about 2½ ft. long, 1½ ft. wide and 1½ ft. deep. The blood is kept frozen in these. For cooking, the blood is broken off in chunks by pounding with the muskox-horn blubber pounder. Raw blubber is chewed by the women and spat into the pots in which cooking is going on, the fat is too closely trimmed off the meat being cooked to give enough fat to the soup.

Food. There is not the slightest prejudice against eating caribou meat on the ice. We had a hundred or so pounds fresh meat and some dry meat when we came. We hid part of the dry meat, but the fresh and the rest

of the dry meat were quickly eaten up. They ate fresh blubber with it (there is no old blubber to be had) and ate meals of boiled fresh seal meat within an hour or two before and after eating deer meat. Saw children eat deer meat and seal meat at the same meal.

Fish Spears. Not possible to get three-pronged fish spears on the handle, as handles are always thrown away when they move camp far. Handles are always rude therefore, being only temporary affairs, so I had one set of prongs mounted on a stub handle to show size and position of prongs. Handles are any length needed in the particular locality, some over twenty feet long.

*April 13.* B. with two women, Arnauyak and Anaktak, to fetch people of next village. They went east about five or six miles, found deserted village and trail southwest. Found people by going southwest seven or eight miles and came home from a little west of south at dark. Two sleds came with them and one had come ahead, two boys to pay this village a visit. They had started for here before B. got to their camp. "Igliki" whom Hanbury saw is coming tomorrow. He treated B. especially well and fed our dogs half a seal, the first square feed since they came here.

*April 14.* A dance house was then built by clearing away the Footless family's alleyway, cutting a six feet high arch in their wall where the door used to be, and building a ten by twelve snowhouse so that those that were crowded out of the new house could stand in the Footless house and watch the dancing through the arch. Dancing about two hours when it broke up on account of the visitors being anxious to get back home for a square meal. We had stayed so long keeping people from sealing that the village was out of meat. They told me they did not want to go sealing for fear of our getting lonesome.

Went with visitors six miles south to their camp, which is apparently some ten or twelve miles from the mainland, a trifle west of north true, from the mouth of the Kogluktualuk, which is the place whence comes the material for most of the stone pots and lamps in this locality.

Mammoth bones have been found "to the west," I can't learn how far west, perhaps it is only a story from the times when there were trade relations with the Mackenzie. They keep asking us if we hunt mammoth, or see them alive. They say their neighbors to the west near Rae River, they heard, a few years ago found mammoth bones on sea ice near shore. They don't know if any bones were saved. We never heard of this at Rae River.

Contact with White Men. Igl<sup>s</sup>hirk and Ulipsinna told me separately that their grandfather had seen white men near the Coppermine but their father never had, nor they themselves except when Igl<sup>s</sup>hirk saw Hanbury. An old woman was about six years old when her father saw white men on

Rae River, she herself did not see them. I asked Igl<sup>s</sup>hirk if he had heard of ships being broken and white men dying on the east coast of Victoria Island. He is the first man I have seen who knows Victoria Island has an east coast. He said no; but he had heard of two ships being broken in the ice off shore east of Victoria Island and all the men eventually dying. Had any of the white men lived a while among the Eskimo? Not that he had heard.

Anarak says he really belongs west of Cape Bexley; has often camped with the Haneragmiut but always hunted summers on the mainland with the Akuliakattagmiut or near them, a little west of them sometimes. Igl<sup>s</sup>hirk says just the same of himself. Anarak's wife also used to be with the Akuliakattagmiut. This perhaps accounts for her having more "fancy work" on her clothes and her husband's, the only man's garments here I have seen with red stripes.

Natjinn is the young woman whose parents used to spend summer now and then on the Akililik River.

One of the sleds here (Kaiariak's) has runners of folded musk-ox skin stiffened with willows and interstices full of ice. The cross-pieces and runners as well as the shape of the sled are the usual ones.

Snowhouses. This village when we came consisted of one single snow-house, one double one, and two tents with snow walls. One family from other village came with us (Kaiariak, son of Igl<sup>s</sup>hirk) and built a house, the rest of the village will follow today.

Deerskin Leggings. Could not buy today woman's large legging (ordinary cut) made of deerskin tanned white like "nelluak" with narrow red and white and black stripes in broad bands running up the front of the leg from ankle to hip and a crosswise band between ankle and knee. The narrow black and red stripes were deerskin, the white ones "nelluak" seal-skin, sewn by Niakoptak, wife of Anarak, who has lived at Bexley. Was told no other woman makes such clothes here. Stripe work in general same as on man's leggings I bought.

Mittens. Told also that they do not make the black and white tiger stripe mittens here ordinarily, only now and then "to have mittens like some of rest of our neighbors" i. e., Cape Bexley, et al.

*April 22.* At the Schooner "Teddy Bear." Place Names. Napaktöktök, first river east of Coppermine. Kūgaryuak, eighteen miles east of Coppermine (second river east of Coppermine?) where "Teddy Bear" is wintering. Kōglūktūāluk, Tree River. Kōglūktūaryük, river flowing into Gray's Bay. West part Lambert Island, Kauvoktok. East part of Lambert Island, Igoktorlirk. Near here Dolphin and Union Strait never freeze, "Cagavok."

Eskimo at Mouth of Rae River. Capt. Bernard first found Eskimo, as

he cruised south from Cape Krusenstern, at the mouth of Rae River (Ekalukpik, et al) August 20th, 1910. They had plenty of meat most of which they had no doubt speared, though they shot some with bows while "Teddy Bear" was there.

Eskimo at West Mouth of Coppermine. At west mouth of Coppermine on a triangular island they found (Oct. 26) twenty-seven houses of people who were spearing fish between this triangular island and the bluff that marks the west bank of the Coppermine mouth. Some of these people also hooked for fish, though spearing was in three feet of water by an open hole at the river's mouth, the hooking was from three to five miles up stream. Capt. Bernard finally got as far up as Sledmaking River, and turned back.

Cache on Read Island. On Read Island saw with glasses from ship a platform cache on wooden (?) posts with kayak (?) on it.

Stone House. Saw dome-shaped stone house, old, no rafters used building it, on neck of Cape Krusenstern.

*April 25.* Puipirmiut. Five Puipirmiut came over today from not far northwest of here.

Clothing. Several coats seen here and there east of Cape Bexley have on hood the horns of the caribou, the velvet, no branches, as well as the caribou ears.

*April 29.* En Route to Banks Island. A Deserted Camp. Started towards Banks Island April 29th, 3:15 P. M. At 5:45 came to temporarily deserted camp of people not at ship, kayak and other things, including blubber, en cache. At 6:15 crossed our east going track of about middle of our second day going east along islands, between first and second islands. At 8:30 reached second deserted camp, permanently deserted. Camped in one of snowhouses.

Most of houses here double. Have been told that usually, but not always, double houses are built by those who are in the habit of exchanging wives.

Sorcery. B. heard it told April 28th that Kōllrōnna is a great añatkok. Last winter he dropped his knife into a seal hole. He took an ordinary argegi, put it over the hole so that the hem completely circled the hole, and then reached with his arm through the neck of the coat down to the bottom of the sea. The sea had become so shallow it was up to his biceps only. B. saw the knife so recovered. B. believes the story.

*April 30.* Started 10:45 A. M. following old trail. In about eight miles found camp not over two weeks abandoned, but could not trace trail by which they arrived there. One faint trail (a single sled) leading northwest, evidently had come overland from Lambert Island way. Did not follow this as hoped to find people off Krusenstern. At the first cape south of

Krusenstern found last fall's village, unknown number of houses as snowed over among the big ice cakes. Northeast of this cape, about one and a half miles found village of eight houses deserted three or four months.

*April 30.* Near Cape Krusenstern. In all villages seen on ice far from land, doors faced south; in villages at point of Cape, doors in most or all directions.

*May 1.* Puiplirmiut Village east of Lambert Island. Saw from camp an Eskimo village a mile or so east of Lambert Island. Started at 8 P. M., got there at 10:30, slow going account dogs sweating, heavy load (took part of two deer killed) and soft snow, softened by thaw today. Camp consists of twelve snowhouses. People mostly Puiplirmiut, though many others here too. Kamññok and his wife Miyuk who are really Akuliakattagmiut are here now and were with Haneragmiut when we were there last May. Uluxarak (Akuliakattagmiut) is here too. Huprök and his brother Kōnirk (Kogluktogmiut) also here, and their parents. Others not seen before. None of these hungry last winter. Are killing ugrug now, got two today. Are not killing any caribou "because we have no guns." All, or most, are going to the ship and to Bear Lake. None here have seen white men except those who have seen us. (Huprok's and Uluxrak's families now here were at the ship last fall, however.) A good deal more prying and unpleasant forwardness than among the same people last spring.

*May 2.* Near Lambert Island. Food. Deer and seal meat eaten at same meal and cooked in same pots, did not see both cooked together though. I asked them if they all did this, they said they knew it wasn't really right to cook both in same pot, but they always did it, never, however, without changing the strings by which the cooking pot is hung over the lamp. Deer and seal fat and meat raw and cooked eaten in almost or quite all the possible mathematical combinations.

Snowhouses. Village near Lambert Island was all snowhouses (eight) when we arrived last night, by three P. M. today five of eight houses had skin roofs. It was a very warm day. This is almost three weeks earlier than at Cape Bexley last year and about ten days or two weeks later than at mouth of Kugaryuak.

Summer Hunting Grounds. Say Puiplirmiut and Kanhiryuarmiut usually meet every summer where they hunt, probably north of Read Island. Say they go in three days from sea to sea (from near Read Island to Prince Albert Island) when they go to trade with Kanhiryuarmiut in winter. Say Kanhiryuarmiut are very timid, afraid of strangers.

Drying Frame. Uluxrak had drying frame over lamp with hoop of whalebone. Did not seem to know where bone was picked up, had bought frame from another man.



Copper Knives. Copper knife bought of Huprok (only one in camp) has history of at least four previous owners, all of them Puipliirmiut now dead.

*May 3.* Deserted Village. Started 1:35 P. M. and at 2:30 arrived at deserted village on the trail of ten houses, i. e. Huprok's party now in nine houses were then in ten, or else someone has since left the party. People had evidently been here several days. Trail fresh to here, but beyond this hard to follow; only one sled track discernible most of time, though it occasionally coincided with an older trail of many sleds, that could now and then be faintly made out. At 5 P. M. arrived at old deserted village and simultaneously saw quarter mile south of it a small village of tents. Found here Apatok's family (10 persons), four other houses.

*May 3.* Feathered Arrows. Saw wing of a black eagle found frozen on ice last fall, feathers intended for arrows.

*May 4.* The teeth of an old woman here, Havīuyak, are worn even with the gums in both jaws and as far back as the eye teeth, molars slightly less worn. Not a single tooth seems to have fallen out. Many younger Eskimo, however, have lost several teeth.

The black eagle of which we were shown a wing, is known here as *Kōpa-nakpūk*.

*May 5.* B. and all the men but Takuerkinna hunted seals due south from camp. The hunting ground was perhaps three or four miles west of the end of Lambert Island and a little south of it. There were "many ugrug but more seals" B. says. He had two ugrug of which one slid into the water and sank, though dead. One of the natives crawled up on a seal and stabbed at him, but got blood only (*Küllärk*). The ice was so thin it could be felt heaving under one's weight "and in some places there was no ice probably" they say. Even when crawling flat-bellied towards seals the hunters keep stabbing their knives through the ice to test it. On the sealing ground the ice is in few places over two inches thick and mostly not over an inch. B.'s blunt "skinning knife" went through at every stab. Accidents are said never to happen to men or sleds "for we know where it is safe to go."

B. said also he never saw so many ugrug in one locality as here last summer. It would evidently be a great hunting place with boats in fall and nets in all seasons. The ice was everywhere smooth where the seals were. The seal holes were mostly "as big as tents and some oblong and much bigger than any tent." The current could be heard in most places under the ice and in the holes it could be seen running rapidly west. So far as we can learn it always runs west, though people seem to have paid no particular attention to it, and are therefore not to be relied on.

**Ceremonial Gift of Caribou Meat to Dogs.** A ceremonial gift of caribou meat to their dogs was made by Apatok's family the evening we came here. We had given each family about five pounds of meat and this was at once set to cook. I was eating with Apatok. When we were half through he asked his wife, "Have the dogs had any caribou meat yet?" "No. What can I be thinking about," said his wife, cut off a piece for each dog about the size of a pea and gave it to them. I take it that this was a ceremony, the dogs look well fed. They have plenty of seal meat on hand, and the pieces of caribou were so small anyway that they were a bare taste.

Some dogs here are tied, some have one leg tied up to the neck, but most are loose.

**Food.** Deer meat was here cooked in the seal pots without even changing the strings they are hung up by, as do the Kogluktogmiut (at least Huprok's family), nor was any ceremony applied so far as I know, not even washing the pots between.

**Boots.** Water boots, summer style, are worn by some, ordinary winter boots by others, and by a few sealskin leggings, hair out, with slipper made in the manner of the soles of water boots.

*May 6.* Near Victoria Island. People by Shore of Victoria Island. Started 1:35 P. M. and took course generally true north. At 5 P. M. spied people by shore of Victoria Island ahead of us and got to camp of three houses at 5:35 P. M. Distance fifteen miles. People hunting seals only though camp by shore, now three days old. They have had hard luck and have only a day's supply of meat ahead. They are nevertheless very generous with the little they have, more modest and pleasant people than we have before seen. None of them have been to the ship, which explains much. They are in conduct very like the Akuliakattagmiut last year. Camp is at mouth of Kogluktok River which "used to be a good fishing place but has ceased to have many fish. There are ugrug in its mouth though."

**Kogluktok River. Knowledge of Ships and White People.** Some of people spend all summer in sight of the sea, none however saw "Teddy Bear" nor have they seen any other ship either winter or summer, or any white men at any time, nor have their ancestors.

**Food.** Customs in general do not seem to differ from other people seen before. For first time saw deer droppings eaten. They had them in a bucket frozen and ate them as we do berries. Similarly when deer were killed at Kirkpuk's camp two days ago grubs were gathered in a small pail and passed around as a sort of dessert after the meal as we might nuts or fruit.

**Care of Infirm.** One man of about forty-five, Avranna, is totally blind

and has been "for a long time." He seems tenderly cared for and goes walking about outside with his cane, guided by the shouts of grown people or children warning him of obstacles and telling him where to go.

*May 7. Houses.* Houses here have the land east of them but all have doors facing north, in that direction land is about two miles away. At last village (Kirkpûk's) three houses faced south, one east, and one north. The one facing east was north of a house facing south but there was no house immediately east of it and none farther north or west.

*Hunting Seals.* Seals on top the ice are occasionally hunted here, both sorts. This method is called "auktök" (he hunts seals by crawling up to them on his stomach). The same word is used for this method at Mackenzie River and Port Clarence. Kirkpûk told me, "I have often seen people crawl upon seals (auxhigu) but I have never tried it myself." It seemed only the older men ever did it, of those in that village, and not even all of them, for Apatok said he never tried it. Roughly speaking, the Noahonirmiut (mainland) had never done it and the Puiplirmiut (Simpson Bay, Victoria Island) had.

*Stone Houses.* In nearly the bottom of the small bay just west of the mouth of the Kogluktok set a hundred yards back from the present waterline, we found what we were told was "tûrnñrat iglukapcaluk." This was so covered with snow which must also have filled the inside that I did not attempt to uncover it. It would have taken a day's hard work. It seemed to be about eight feet high and about eight feet in diameter, about the shape of a truncated cone, the truncated section not over three feet across. It is said to have a door on ground level about the size of the door of an Eskimo (local) snowhouse, and children often use it for a play house in summer. "It was built by the turnrat long before the time of our forebears" (sivûlîvût). There is one other somewhat like it to the south at Tuktûktok. I could not make out positively if this is the neck of Cape Krusenstern where Capt. Bernard found a similar house, though they said Tuktûktok was of a piece with the same land as Puiblirk. The house is built of flat limestone slabs, some of which must weigh over one hundred pounds even those near the top. There is no evidence of sod or moss between stones. The house is not at a conspicuous point on the coast that would attract attention of passing boats.

*People.* People are said to be here and there (got no idea of how many) from here to Haneragmiut. The nearest village is Puiplirmiut, about six miles west, just west of an island which may be the most easterly one marked on the chart in Simpson Bay, just west of Clouston Bay (Mouth of Kogluktok is probably in Clouston Bay). This village consists of four houses, probably about twelve people. I should have found out their names only I



Fig. 89. Ruins at Point Atkinson.

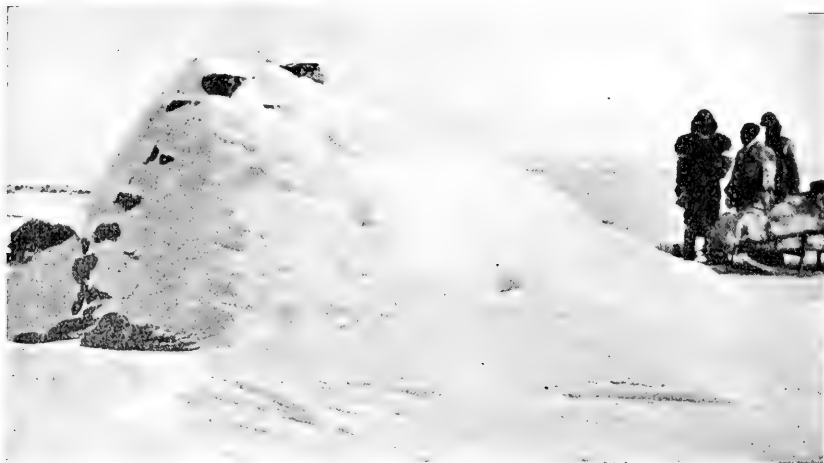

Fig. 90. Ancient Stone House, Simpson Bay, Victoria Island.



Fig. 91. Kitchens of Summer Camps, East Edge of Mackenzie Delta.



Fig. 92. Tent Frame, Langton Bay.

intended going there but changed the plan on having to go about three miles inland for first deer killed by B. There were three of last village along who were to convey us to next village, but they turned home packing deer we gave them (Kalaark, Aialik, and Hinaxiak). Have been unable to form a definite idea of the total number of Puipirmiut. Suppose I have seen aggregate of less than half. Near Nagyoktok we are said to have missed one party of them, and there are others west of ones whose village we intended visiting today.

Musk-oxen never killed by Puipirmiut when hunting at home. "Plenty" on other side Prince Albert Sound.

*May 9.* Forsythe Bay. Eskimo Village at mouth of Kĩmĩryũak. Visitors arrived about 1 A. M. this morning. Neglected to note yesterday we saw a native village with the glasses a mile or two southwest of the most easterly island off the mouth of the Kĩmĩryũak (Forsythe Bay, if Forsythe Bay is the narrow estuary or fjord-like bay and not the wider one west of it.) Two of the four families of this village had started inland in the afternoon, following the river. When they came to our trail the rest camped and two men followed us up. They must have known we were not of their people for B. used snowshoes. Probably guessed who we were, though they did not let on that they had. When they heard our names, however, they knew we were the party that had passed east last spring and asked where the rest were. They have been catching plenty seals and ugrug lately, the latter in the river mouth. They are going up the river to fish in some small lakes in which the river heads "not far inland." They will follow the river ice all the way so the stream cannot be crooked. Must come from the east or north-east, the latter more probable. The lakes in which the river heads are called small. The fish are sea fish (salmon?) and are caught with hooks. The rest of their party will follow them inland. "It is time, for ugrug are on top the ice by the shore." The ugrug caught lately were speared through the holes, winter fashion.

The Uallinermiut. Older of two men asked B. if he were a Uallinermiut. On B's replying "Yes," he told us his wife's father was a Uallinermiut too.

*May 12.* Near Prince Albert Sound. Food Taboos. Hunting with Huggok last summer was a young man (B. tells), Kamoariok (Kogłuktok) who forbade anybody to break for marrow bones of caribou he had killed. Both ends must be sawed off to get the marrow. This was because "caribou might all leave the country, if the bones of any he had killed were broken for marrow." This man would break in the ordinary way bones of caribou killed by anyone else. He was the only one last summer who, so far as any of us learned, put restrictions on manner of eating marrow. B. says in his place he heard of people who had similar restrictions as to breaking marrow

bones. When B. was young he had pain in his index finger. The doctor then told him that until he was a grown man he must not eat fish roe or he would quickly die. B. kept restriction some years but broke it before grown up. None of his people would eat ptarmigan heads with seal oil for fear of going blind.

*May 13.* An Eskimo Village. Saw from our island village on ice bearing 270° from hill on south middle of island. Started for this at 3 P. M. after shooting and skinning one more caribou. Got to people sealing three miles southeast of village at 6 P. M. and to village at 7 P. M. Distance from island about ten miles. Evidently much nearer south than north shore of bay.

Our reception seems worth describing. The three first approached showed some timidity which quickly wore off and invited us to village. When within half mile they signalled meaning "The Tōgmūt are coming" by one man running off to the left from us at right angles to our course about ten yards and back to us again, this repeated twice. A crowd of men and boys then started to meet us, a crowd of women following a few yards behind, because of timidity or because slower runners. When they reached us we were surrounded by a howling friendly mob who jumped around us, pulled at our clothes to attract attention and all talked at once so no one could be heard. They were eager to help put up a tent, but of course were more hindrance than help. When the tent was up seventeen persons besides ourselves crowded into the tent (seven by seven feet square). When first approaching us all ran with upstretched hands, palms forward, saying: "Īlyëranaittugut, imainnarittugut," the latter words accompanied by an opening and closing of the palm to show there was no weapon held in the hand.

Note: From this date to the entries of May 22 the author's diary is given in full as Chapter XVIII of *My Life with the Eskimo*.

*May 22.* Cape Baring. Traces of People. Saw one snowhouse about a mile east of the pitch of Cape Baring yesterday (Alunak's, no doubt) about three hundred yards off shore, door facing southwest. Nearest way to land was south. Several "up-ended" stones seen near beach today and one grave (?).

*May 23.* Traces of People. After leaving Clouston Bay and before reaching mountains proper, we saw six stone graves. All were conspicuously placed on top hills, but not on top the very highest, and were merely irregular low heaps of stones as they are at Parry. Saw no bones or artifacts. In one case two graves on same hilltop, about five yards apart, other graves isolated. Numerous "up-ended" stones and some stones placed on top of others, but none in regular lines as if deer drives. One tent ring seen of usual oval type.

Tent rings less conspicuous than graves and therefore more readily overlooked. "Up-ended" stones in mountains and one tent ring about twenty miles before reaching the Sound. One empty meat or blubber cache seen on Ualliraluk Island.

Ugrug. According to Hitkoak there are plenty ugrug near Ūñahiktak Island off the bay of the Ekalluktogmiut.

Names of People and Places. According to Hitkoak the Ahiagmiut are south of the Ekalluktogmiut on the mainland. Aulätivīgyuak and Pitökīrk (Peelokek of Hanbury) are in their country. Hitkoak has been at the Akilīnik only above the lakes; he has heard there are lakes in it down stream from where he was; he has forgotten the names of them. He has been at Uminmuktok. In front of it is the island Ekalluligaluk (Barry Island?). Kilaktōrvīk is a small river near Uminmuktok. Kū'nayuk is a river just west of Aulätivīgyuak (White Bear Point). Aulätivīgyuak is so called because it is a great place to hook for fish. Kūlgāyuk another river just west of the Kūnayuk. The people that frequent the Akilīnik are the Ahiagmiut and the Kaernermiut.

The Kaernermiut. The Kaernermiut (according to Hitkoak) never kill seals, but live on caribou and musk-oxen. Their land is east and south of the Ahiagmiut. They never come to the sea except as single families visiting other tribes.

The Nētjilīgmīut. Hitkoak has heard of the Nētjilīgmīut but never seen them. East of the Nētjilīgmīut again he has heard there are people without chins whose necks come out flat with their mouths and breasts.

The Natjīrtogmiut. On the south coast of Victoria Island, east of the Nagyuktogmiut, Hitkoak has heard there are the Natjīrtogmiut. He has never visited the Nagyuktogmiut or Natjīrtogmiut nor have any Sound people.

Place Names. Prince Albert Sound, Kañhīrgyuak; Minto Inlet, Kañhīryuatjīak; Walker Bay, Kañērkhīnērak; De Salis Bay (?), Kañēr-xualuk; Cape Wollaston (?), Kītikat (the place they leave Victoria Island to cross to Īgā'hūk.) They sleep three times, three camps, on ice between these capes; Cape Cardwell or Cape Collinson, Īgā'hūk (this also serves as name for Banks Island); Cape Baring, Ikpīgyuak; Point south of Baring, Nauyat; River south of Baring, Kūgaryuak; Back River, Hannīñayōk; Arkilīnik River (Hanbury), Akkilīnik; Albert Edward Bay, Ekalluktok (same name given large river that flows into Albert Edward Bay); Admiralty Island (?), Uñahiktak; Taylor Island, Ōmannak.

May 30. Near Crocker River. Commerce between Groups. B. tells when he was young the Uallinermiut used to come to Port Clarence, with umiaks loaded with nothing but pōgōtat (wooden platters, pails, etc.) He



thinks these Uallinermiut were mostly or all Unalit. These were bought by the Port Clarence people and carried by umiak the following summer to the Khodhlit who bought them for reindeer hides chiefly, but also for tobacco. The Port Clarence people paid for the pōgōtat entirely in goods received from the Khodhlit, reindeer hides, sinews, and tobacco.

**Bows.** The Kanhiryuarumiut make few of their bows, but get most of them from the Haneragmiut in exchange for iron goods (plunder from Bay of Mercy and goods bought of Ekalluktogmiut who get them on the Akilini), and made and unmade copper.

**Tent Sticks.** Their tent sticks are partly of local driftwood, partly from the Haneragmiut (Cape Bexley driftwood), but chiefly from the Puiplirmiut who get them from those who hunt on the Dease.

**Sleds.** Their sleds are chiefly or entirely from two sources, the Haneragmiut who either get the wood or the made sleds from the lands or the hands of the Akuliakattagmiut, or from the Puiplirmiut who get them as they do the tent sticks. Of course, a Puiplirmiut sled may get to the Kanhiryuarumiut by way of the Haneragmiut or a Haneragmiut or Akuliakattagmiut sled by way of the Puiplirmiut for these meet every winter to trade.

**Trade between Groups.** The Akuliakattagmiut get Bay of Mercy iron from the Kanhiryuarumiut and Hudson Bay iron from both Kanhiryuarumiut and Puiplirmiut, the Kanhiryuarumiut getting it from the Ekalluktogmiut who either got it themselves on the Akilini or got it from the Ahiagmiut; the P. getting it from the Kogluktogmiut or the Nag. who get it from the Uminmuktok who got it directly from the Akk. (by going for it or from the Pallirmiut traders who come to Uminmuktok from the Akilini) or through the intermediation of the Ahiagmiut.

*May 3.* **Traces of People.** Traces of people, such as there are, would be very easy to find now if we only had a third man to leave me free to follow the beach while they proceeded off shore. The snow that must have covered many things the first week of May and the last week of April last year is now all gone. Around our present camp have seen no traces of men except one stick that was probably used as a chopping block (by Richardson's party?), axes were very sharp. Cuttings might be anything from six to sixty years old.

*June 1.* **House Ruins.** Before supper I took a fruitless walk west along the beach in search of traces of the former inhabitants. After supper I had a look east with better results. Half a mile east of camp is a tiny creek coming from the mountains (or foothills). Our camp is twenty yards east of another such creek. On the west bank of this creek, about fifteen feet above the creek and thirty or forty feet over the sea, is a little, flat-topped shelf of the hill nearest the coast, about one hundred fifty or two

hundred yards from the sea. On this shelf is the ruin of a sod-and-wood house of ovoid shape about eight by ten feet, in greatest transverse interior diameters. The greater end of the ovoid is towards the sea, and the door seems to have been in the middle of the seaward gable. There is no evidence of an alleyway of wood and earth such as is frequently in use in the Mackenzie. The main supports of the house have been in western style, the butt ends of small trees, the roots up to serve for crotches. That the structure cannot have been a cache is shown by the traces of a door, by the root bearing uprights which are now fallen, and by the fact that the walls were clearly partly of split sticks. One of the sticks still upright in the east wall was an adzed board about six inches wide whose end now sticks about two and a half feet up at an angle varying from the vertical about as Eskimo walls usually do, about  $15^{\circ}$  or  $20^{\circ}$ . Some of the wall timbers are decayed quite off even with the ground, others are still in fair preservation, difference no doubt due to differing age and sort of timbers originally used. No excavation possible on account of ground being frozen. About ten yards east of the house are a few scattered sticks probably of more recent date. They may however be remains of a work-shelter dating from the days of the house, or more likely, a more recent campsite. Judging by the ruins of Fort Confidence, making no allowance for difference in climate this house should have a minimum antiquity of over a hundred years.

About three hundred yards west of this house ruin, ten or twelve feet above the sea and fifty yards from the beach are the sites of two or more tents. There are no stone rings, but there are two fireplaces (flat stones now and perhaps originally all lying flat on the ground). There is one small stick by one fireplace that still has the charcoal on the end. There are many unshaped sticks scattered about. This is the interesting part, for the present people to the east never gather sticks about their camps except to dry on meat or fish. The western Eskimo however build windbreaks and smoke shelters of rough sticks. Date of these sites perhaps fifty or sixty years. Saw also three or more tent sites that would suit well the present eastern style of tent, merely some split sticks laid on the ground to be under the beds and some split rejects from implement making. None of these camps less than fifty years old. Adze and knife shavings have all disappeared from all the sites.

*June 3.* Buchanan River. Stone Graves. Saw four or more very old stone graves on the rising ground in the delta just east of the most westerly mouth of Buchanan River. Only artifact seen was a piece of a sled runner so rotten that it was in pieces where it lay. It was almost surely a piece of the short, western type sled, piece about eighteen inches long. Both ends missing and parts of side edges, one hole still showed, the sort

of hole used for the insertion of cross bars on Mackenzie sleds and not found at present towards Coppermine.

A half mile east of present camp some sticks brought together on bit of rising ground as if to use in camping, and by our camp a stick from which slivers have been split, these latter two not over fifty years old probably.

*June 4.* Near Roscoe River. I wanted to make our present camp at the old ruined village seen by my sled party May 2nd last year. I spied for it carefully every half mile with the glasses but never saw it. I think it must have been closer than we thought to our bear kill camp. With glasses saw every half mile or so east of Roscoe River some sort of remains, graves, tent sites, or caches. In one place where these were especially numerous I went ashore to see. There were ten or more (perhaps over twenty, some are hard to distinguish from natural formations) caches, evidently for whole meat. A pit a foot or two in depth had been dug, lined with stones in some cases, in some cases not, and covered with stones and earth. These had evidently been opened again by the owners. The caches are of the type used at Kittegaryuit to rot meat while the owners are there in residence to protect from animals, i. e., not made to keep out strong animals. The pits seem to have been in one case over four by six feet and in most cases about three by four. The only bones seen were those of whales, at least two whales of different sizes, both small. The bones seen were maxillary and vertebrae. No artifacts seen.

#### THE HORTON RIVER, 1911-12.

*June 6.* En route to Langton Bay. Distribution. Wherever we go ashore we see some works of man, chiefly tent sites, work places (split wood) caches, and tonight one grave by our camp. While B. cooked tea at the next point east of Point Keats I tried to open one of these caches. I thought it might be a grave. The size was about five or six feet, the longer diameter parallel to the sea. A hole had evidently been made by picking out (as we often do in making our own meat caches) the small stones of which the ground here mostly consists and shoveling out the dirt that remains. The contents of the cache, perhaps blubber as no bones were seen, had then been covered a foot or more deep with stones, averaging in size a little larger than a baseball. On top these had been placed one layer of heavy flat stones, making a complete cover for the cache. The cache had caved in so to be lowest in the middle, but the position of the flat stones of the roof showed neither man nor beast had opened the cache. The owner never returned for what he left, if indeed, this be not a grave. Sand had unfortunately blown in so

that I could not get off more than the stone roof and about nine inches of small stones, below that the stones were imbedded firmly in a matrix of wet frozen sand. To dig any ruin here it is necessary to have several days at one's disposal. When the top covering is removed, the sun soon thaws two or three inches farther; remove this, and another day given you, another two inches or so; in this manner only can structures be opened that do not consist entirely of stones on dry rock as a few at Parry do. There are usually many remains in a single neighborhood so the need of this method does not necessarily involve delays. With the ice decaying as fast on the sea as it is now, we cannot stop however.

Near our camp today I found a bow bender, evidently made for the occasion and thrown away. Found also a sled runner. Am taking both of these along. The runner is of the western type, short sled, though it is the longest I ever saw. It has five holes for cross bars where four are usual. It is thick at the top as compared with the bottom of the runners. There are wooden pegs by which the shoeing was fastened on and sockets for uprights in the top of the runner.

*June 7.* Near Point Pierce. Distribution. At camp here we found a nearly complete sled that had evidently been cached here. Four heavy stones had been placed on top to keep it from blowing away. The owner never returned for it and eventually the lashings gave way. The runners buckled under, the sled caved in. The four stones still rest on the four cross bars and the runners are almost in the position in which they fell. There are along the lagoon side of the spit remains of many small caches, probably for Ekallugyuak, western style. Sled of thoroughly western type, handle bars found about five yards from sled and not together probably carried by animals that ate off lashings. Possibly too, handle bars belonged to a second sled of which we found only one runner about ten yards from first. This runner of the same type, pieces of the rawhide lashings still remain on the sled runner.

*June 9.* Near Cape Lyon. Archaeology. Took a hasty look at the house sites on House Hill. One of the ruins forms a pile at least five feet above level of ground. There are, I believe, eight ruins, some older than others. The walls were of earth and blocks of the basalt rock of which the hill is composed. Found no artifacts but a heap of charred seal bone. Took a specimen of these. When B. saw it he said it was the bones of seals caught in nets. I asked him how he knew. He said his people (Pt. Clarence) always allowed dogs to chew at bones of seals otherwise killed, but the bones of netted seals were always burned so dogs should not eat them. He supposed Eskimo everywhere had the same practice.

Taboos. The Slavey of Bear Lake will not let dogs eat the bones of

caribou generally. Taking the cue from the white men there I thoughtlessly assumed this was because they thought the bones bad for the dog. More likely the reason is that they have a taboo against it, as the Coppermine people do with seal heads and the Point Clarence with netted seals. Jimmy "Soldat" did not mind dogs coming in at night and eating the charred bones out of the ashes, but the bones must be thrown in the fire to begin with. No doubt as they become "civilized" this practice will get some rational justification, such as that bones are bad for a dog, or else the practice will die.

Archaeology. A grave (?) of logs, one of the largest I ever saw, is here on the beach by our camp. B. feels sure it is a grave; to me it looks much like a fish cache. It is about five feet wide, length doubtful, of large logs. All around is a pile of sticks laid up against the box part of the cache, the big ends toward the cache, some have roots, some merely a butt, others seem to have rested on top the side logs, none laid so as to meet in the middle of the cache. I have not tried to look inside as there is ice among the lower logs.

*June 26.* Langton Bay. People East of Baillie Island. Ilavinirk learned the following from Panigyuk, about seventy-five years old, on his trip to Baillie last April.

Langton Bay harbor sandspit, Nuwuayuk; island (sandspit) off point next east of harbor, kalit "because" there once was an umiak towing a whale ashore when a menstruating woman looked at them and boatmen and whale turned to sandspits. Tīgat, the shoal southeast corner of Langton Bay, shoal because river enters it there; ilu, the southeast corner section of Langton Bay where used to seal in spring after the rivers began flowing, speared them through the breathing holes.

Ōmatalik, lake with an island in the middle on top plateau five miles southeast of Langton Bay harbor. Is called so because the island looks like a heart. People moved there when the bay ice thawed. They had stone caches there for meat. Camped on or by a small, flat-topped, stony knoll. This camping and cache place called īglītauayāt. Numerous deer bones about (saw them in Sept. 1909) and from this place in her girlhood lead a footpath to the ōmatalik fishing place so deep that it took a grown man more than half to the knee. From here can be seen southeast a sharp topped hill where lived a family who never came to the sea except to trade deerskins for oil and other things. They lived partly on fish, but mostly on deer all the year round. This was the only family she knew of who never hunted seals.

Akkīlīnak, the point opposite (north) from the ship harbor. "Kūgum paña" Ilavinirk reports her as saying was the only name they ever used for

the summer (and also winter) settlement at the mouth of the small river just north of Ōkat, the one from Darnley Bay.

Iglu lu aluit, the settlement on the sandspit just west of the Horton River mouth.

At two times many of the people around Langton Bay died, the first time of starvation; the second time of an epidemic. (Both these events seem to have happened between her birth and marriage, say fifteen years). After this the people "because they had become so few" divided and went in three directions. Those with whom her parents went turned west towards Baillie; some went north towards the tip of Parry, some went east to Lyon or beyond. Those who went east probably kept on farther and farther east for they never returned. What happened to the Parry contingent Ilavinirk is not clear. There always were people on Parry. In summer one settlement of them was at the bottom of the bay where I shot the two deer April 7, 1910. I saw remains of racks there but took them to be recent; I now believe them to be of ante-whaler origin as they looked older, if anything than the remains north of Okat which Ilav. found so rich in specimens last year.

Trade. The Langton Bay people never used to go west in a body to trade, but sometimes a single family or two went to Iglulualuit, but never beyond. These similarly never came in large parties to Baillie but occasionally one or two families. Whether western people went east, Ilavinirk has not found out. It is common knowledge at Baillie that people used to cross from Parry to Banks Island to trade. They crossed with light sleds in spring (March or April, usually the latter) and sometimes made land without camping, sometimes camped once.

*June 28.* Ilavinirk tells that at Point Hope when he visited the place first with his father, as well as later when he lived there, a very large cold storage house was owned by an old man there (whalers call him "the old chief"). This house had been built so long ago that its owner had no idea of the number of generations. When the owner died the storehouse passed to his son. The owner put into the house all the meat, etc., he had; if there was space left over he allowed others to fill it. In this way the house was used sometimes by two, sometimes by three men. When the owner had a whale he always used the entire house.

Once there were hard times at Point Hope but not real starvation for some of the people had food. This was when the large ice house was nearly new. There was in it considerable maktak among other things. The owner began to notice that someone was stealing from the house at night. There was an orphan, now a grown man, living with the owner of the storehouse. The owner told this man to watch for thieves while the rest slept.

He hid himself under one of two platform caches that stood one on each side of the house nearest the storehouse; the owner of the storehouse lived in the next house beyond, i. e., this house and the two racks were between the owner and the storehouse. The houses at Point Hope all have names. The name of the owner's house was *Kinō'tjiāk*. It was bright moonlight. All at once the watcher heard two men talking. He could see no one but the talk neared the ice house. Finally he saw the talkers. They were two men, dressed in long coats (half way from knee to ankle) whose hoods jutted forward and hid their faces like sunbonnets. He did not understand how it was he had been unable to see the men till they stood at the trapdoor of the icehouse. One was evidently afraid, the other was eager to steal. At last, the eager one descended and a little later the other followed. So soon as he was down, the boy ran forward, shoved the big flat stone lid upon the trapdoor and shouted with all his might for help. The owner's household appeared first, but soon the whole village had gathered. Some armed themselves when they knew what was going on, but some did not. The boy told there were two would-be thieves in the storehouse. The lid was removed and people looked warily in. At first they saw only the two pack bags the men had brought for their plunder. They were lying on the floor underneath the trapdoor. Then they saw the men but could not make out their faces on account of the forward-jutting hoods. They told them to take what meat they wanted, to fill their bags, and come up unafraid. They were welcome to all the food they would carry away. This was said to deceive the men into coming out, for the people were afraid to go in after them. The men were evidently distrustful and afraid but nevertheless they filled their packs and came up. They were then seized and led to a council house. When they got here the men asked that the window be uncovered. This was done. They then took up their packs, began walking in a circle (*kaivraxlugū*) underneath the window. As they walked they began to tread air and gradually rose higher and higher walking in spirals. Finally, they disappeared through the window. People rushed out but there was no sign of anyone. Many never saw their faces for the hoods hid them but some said they had one oblong eye that extended clear across the face, and but one pair of lids. When the eye winked, the natural unconscious opening and closing of the eye, the lids moved much more slowly than they do in ordinary men. Some said these had been *turñrat*, but the old owner of the storehouse who told *Ilavinirk* the story did not hold this view. He did not see these men for this was long before his time and he reasoned that if they had been *turñrat* the people who dealt with them would have died.

*June 30. Point of View. Monologue by B. with occasional comments by Ilavinirk and Mamayauk.* "The *Kañhiryuarmit* told me: 'When we

want to kill a man we stab him with a knife. We do not shoot men with bows. What is your practice?' I answered him: 'We shoot them with guns.' (Laughter, Ilav. and M. as well as narrator). But that is not a good way to kill people unless at long range. When I was a boy we children were playing outside and the people in all the tents slept. A man (name given) went with a gun into the next tent to ours and we heard he wanted to kill the man in the tent. Our parents did not know till afterwards; we did not awake them; it was none of our business. (Of course, it was n't, chorus I. and M.). The man who entered said: 'Sit up, I do not want to kill you lying flat (no intention to allow man a fighting chance, merely against etiquette apparently to kill him lying flat). But the man did not want to sit up; he did not want to die, that man (laughter from Il. and M.). His wife sat by, she did not say anything. Then the baby (boy about three years old) woke up. He began to cry as he did habitually. He was a great child to cry. Then his father thought he would not like to die for his boy would cry and he could not hear or see him. He sat up suddenly, seized a knife, struck aside the gunbarrel and stabbed the man to death. (Comments by Ilav.: "That man had no more sense than a dog that growls before he bites. It is not safe to give warning, except from a distance, when you are going to shoot a man." Approval from B. and M.— "A knife is much better than a gun. Though it does not kill so quickly, the knife, if of any size, will paralyze the stabbed man so he can do no harm, especially if the stab is in the abdomen." B.: "Yes, that is the best place, it is not so easy to hit the heart and a stab in the stomach serves all purposes." Further discussion along same line. B. explained, incidentally that both parties were good men. The quarrel was over a game of cards of the previous day. That he did not care much how matters went is shown by his doing nothing when he expected the man of the house to get killed, and expressing no regret when the other man suffered. No expression from anyone to the effect that it "served right" the one who began the affair.

A story of a theft or of Sabbath breaking cannot be told without expression of horror, nor do lax morals escape severe censure. All these have been condemned by the missionaries and the resulting divine punishment emphasized. It has never probably occurred to them to preach against patricide and murder. The fear of the police keeps that in check but the missionary prohibition would be more efficacious still if he chose to declare himself and assign an approximately severe divine punishment. I mean no sarcasm in saying this has not occurred to the missionaries. They are not accustomed to inveigh against murder among us and they do not know the need of doing so here. Against exposing children they have preached with good results.



Archaeology. Excavated two burials, with disappointing results so far as specimens are concerned. One had been so thoroughly turned topsy-turvy probably by bears (?) that it is not clear what it was like originally. The other was as follows: An oval outer ring of stones from a cubic foot in volume to half that size was about eight by ten feet in transverse diameter. In the center of this oval was a rectangular box about eighteen by thirty inches made of stones that had at least one flat face, flat side turned inward. These stones as large as three hundred pounds each, and from that down to one hundred pounds. Outside of box numerous flat and round stones propped against sides of box to keep the stones that formed it from falling outward. Apparently the two rings of stones had then been shoveled over with sand till they made an oval mound. Then some flat stones had been laid over the box as a roofing. The body was that of a middle-aged person, to judge by the teeth. The body had apparently been laid flat on the back with the legs so cramped as to bring the knees near the chin, with the hands folded over or below the knees so that one elbow was by each knee and the hand of one arm by the elbow of the other. As found, however, although the trunk and pelvis were flat on the back, the legs had so fallen over that all the long bones were at right angles to the vertebral column in the same horizontal plane, and the head had fallen on its side too. Knees and mouth faced southwest, axis of backbone, southeast-northwest (parallel to the sea beach) and the head to the southeast. Some fairly preserved small pieces of unworked wood lying around the grave; no signs of decayed wood or other decayed matter in the grave except all bones had more or less black mold about them, which I suppose represented the flesh and clothes. Found one piece of knife (?) blade of stone and two small articles, of antler of unknown use. These three are packed together and labeled. Grave on sand knoll — frost not within three feet of surface. Decay has therefore probably been rapid. Bones not badly decayed, most teeth loose in head. Antler pieces not decayed.

Ilavinirk says he found in Darnley Bay and burned for fuel a sled runner about ten feet long. There had apparently never been shoeing on it.

*July 3.* Archaeology. Took a walk two miles west along coast to glance at ruins. There are three or more house ruins, some of them barely distinguishable from accumulations of driftwood and some of them may be nothing but wave-deposited driftwood, on the sandspit that makes the first lagoon west of the harbor. There are also three or more at the east end of this sandspit on higher land. There are one or more graves east of and a little higher than these house ruins. None of these are so promising as those by ice house. Found on summer campsite a piece of chrySTALLINE rock from which some flakes had been struck, as well as one flake "reject" and

one "core." Near one house was a sled runner of western type. Ilav. found near one of these yesterday a piece of sled runner of antler. Collected also one broken sealing stool last night and saw one today.

Anatkut Beliefs. B. asserts tonight that he has seen in clear broad daylight an anatkok turn a stone pot inside out and back again without breaking it. Ilav. confirms, he has seen it too. Ilav. has seen a three inch long piece of file stretched till it was a fathom long; it was elastic and when man gradually allowed his hands to relax the file assumed its original shape and size. B. in turn confirms, has seen it. Unintentionally allowed them to see I did not believe this, both angry.

*July 5.* Archaeology. Pottery fragments found are a discovery of some interest. I have never heard of pottery being made east of the Bering coast of Alaska by Eskimo. B. and Ilav. say this is just like the pottery which they have seen made in their own localities and of which fragments are to be found "everywhere" in these parts.

*July 6.* Taboos. Ilav. tells that when he was young it was not allowed to cook in metal pots during a time when fishing with hooks was going on. The fishing was in the Kotzebue Sound "lagoon" but he thinks the prohibition would have held anywhere. It was not allowed at the spearing places to use spears that had metal barbs or any other parts of metal, at least iron. That was the only metal in question when he was young and he thinks that copper might have been allowable had there been any.

Pottery. Ilav. says pottery was always made by women. An expert woman could make five large pots in a day. Pots were made only on warm sunshiny summer days. The clay used was from a place south of Kigirk-taruk; any fine sand might be used; ptarmigan feathers were the third ingredient. A little sand was added to the clay "as salt is added to flour" and the dough of the three ingredients was worked as white cooks work bread. When properly mixed, one hand was thrust inside the dough and the pot shaped by beating the outside of the mass with a stick held in the other hand. When shaped, the pot was set beside a small fire and slowly dried, being turned a quarter round every little while. A pot would dry between morning and evening. These pots broke easily and spoiled in long spells of wet weather. When Ilav. was young metal pots were readily obtainable; the reason for making pottery was the prohibition against metal kettles when hooking for fish was going on. The pots were never burned, nor even allowed to get very hot in drying.

*July 7.* Preparing to start for the river mouth north of Okat. Shall send men thence to get our cache in Darn'ey Bay by boat up the river, while I dig the ruins there. The house sites here seem barren. Apparently the people had the fortune not to die of starvation, for they seem to have taken away with them all their goods.

*July 10.* Point Stevens. Archaeology. The house sites here seem very old. The best preserved rafters underground can easily be picked to pieces with the fingers, though ends that stick above the surface are harder. It seems not unlikely that the village has in part been carried off by the river, as Ilav. made most of his finds on the beach last year and this time we have found specimens under water ten yards from the cutbank. The house we first attacked was half gone. Other houses are still intact, unless there be some that are completely gone.

Our finds so far comprise several score specimens, none of which are perfect. There are knives without handles, handles without blades, arrows without shafts, broken clay pots, etc. One lance head found seems to be mammoth ivory, other such articles all horn. A large number of roughed-out stone implements and stone slivers evidently intended for implements, as well as cast-off splinters from the manufacturing. One lance (?) or ice pick (?) head has evidently held a metal point, probably copper.

The house first excavated appears to have been burnt down. Some of the timbers show no signs of fire and others only a little charring, but a few are burnt off so that only an eighteen or twenty inch stub remains. These seem to have been the rafters. Such a fire in an Eskimo earth-and-wood house it seems must have been intentionally kindled, a mass of fuel being carried indoors and ignited. There are no human bones, nor in fact any other bones inside the house. On the roof have been fragments of caribou, swan, ptarmigan, squirrel, and other bones. There are scattered on the beach a few ribs of very small whales. Most of the things found seem to have been on the roof when it caved in.

One lamp-place only could be definitely located by the oil soaked into the floor combined with flat stones on which the lamp evidently stood. This was on the right side of the door, in the corner (southwest corner, or rather south corner as house faced southeast). This is in conformity to Mackenzie custom. The alleyway appears to have been deeper than the house as in Mackenzie. Both excavated to some degree. Changes of surface level have evidently taken place since houses caved in probably chiefly by sand drift. It is therefore hardly worth while to guess how deep the excavation was—somewhere between one and eighteen inches for the house and the alleyway eighteen inches deeper perhaps.

Pottery. Both Ilav. and B. are familiar with western methods of pottery manufacture. They say that the clay is mixed only with the finest dry sand and ptarmigan feathers. Here broken rock seems to have been used, and no signs are seen of feathers, which they say should be in evidence.

*July 11.* Archaeology. Started on the second house today, the largest and the most westerly. All the other houses face southeast, but this faced north, the end of the alleyway being already cut off by the river. What

remained of the alleyway was about six feet long by three feet wide. The house is the usual "round cornered rectangle" the transverse diameters are approximately five m., twenty cm. by six m., ten cm. The difficulty of judging age of remains is well illustrated by the fact that from three to nine inches below the surface, caribou horn specimens are so rotten that some are hard to tell from rotten wood and can be picked to pieces easily with the fingers, while at a depth of eighteen inches (at the present upper level of frost) I found a piece of sealskin that is almost as "strong" as ordinary brown paper. Horn specimens over a foot underground are in fair condition.

*July 12.* Nagyuktogmiut. Mamayauk told today that she remembers hearing the old men tell about the Nagyuktogmiut: "Nuliasugmata nsgyugnik satkotioagmata Nagyuktogmiunik atiroaktuat. Sukañaiaktuatgok (sp.?) kugaktogmata." The same as to the "sukañaiaktuat" part was told me at Cape Smythe in 1909 by Kōpak (Oturkagmiut) with reference to the Indians. The story is recorded here as of interest in showing that the Kittgaryuit people knew of the Nagyuktogmiut before the whaling trips to Victoria Island in 1905.

*July 14.* Archaeology. I dug away at house ruin till five A. M. (July 15). Finds chiefly pot fragments. Did about one meter at right angles to river and full length of house, about forty cm. deep to ice. No finds within ten cm. of ice, so there may be nothing in the frost, though the black earth extends into it.

*July 15.* Archaeology. Finds are few, broken horn articles, fragments of pottery kettles, stone rejects and a few broken arrow-heads, etc., one not broken, long, slender, of ice-like quartz, found about forty cm. down. Two schist (?) knives (?) in the rough at depth of about thirty cm. In river bed Pal. found ulu of stone only slightly damaged and a seal spear head with fragment of bone point.

*July 16.* Place Names. Noahonirk, is small river south of Kuwuk (empties into Kuwuk?). Puiplirk is a high rocky spit south of Kigirktaruk inside the lagoon (Imarruk). Kogluktok, a large river somewhere in territory of Kuwūgmiut. General name for a waterfall there is Kogluktak (above river is tok) the river being called Kogluktalik adjectively. These are duplicated among Copper Eskimo.

Kotzebue Trade. The Kanñomavik trade place was at the middle of the long Kotzebue sandspit. Tribes which Ilav. knows were usually represented there were: Kotlit, Tigiragmiut, Sinaragmiut (Point Clarence), Kiñigmiut, Kaviaragmiut, Imarxlit, Okiuvūgmiut, Kuwūgmiut, Noatagmiut, Kugmiut (not Wainwright Inlet), Silivigmiut, Kugahigmiut (who were occasionally accompanied by a few Unalit), Kugrugmiut, Tapkarmiut

(Kotzebue Sound, a pretty long two days across the lagoon by sled from Kigirkarruk in winter), Kivalinirmiut, Nappaktogmiut (occasionally), Kañianermiut. Perhaps others, knew of one Indian once.

Burial Customs. Kittegaryumiut, Mamayauk tells: When a man died during the fore or middle part of the day, while yet there was daylight enough for the funeral, he was put away that day; if too late, the body remained till morning. People slept in the house with the dead if the body could not be moved before night. The body was completely covered with the dead man's own sleeping clothes while others slept. When the body was carried out all sleeping clothes (other clothes too, but she is not sure), and cooking gear was carried out just after the body and laid for a few minutes on the snow or on top the roof of the alleyway. These were then carried back into the house, being carried both out and in through the regular door; the body was not carried through this door but through an opening in the house wall made for the purpose, generally on one side of the real door. Only a few followed to the grave; the dead person's husband or wife sometimes followed, sometimes sat in the middle of the house floor with hood up. They often wept, but only from real grief. The children might or might not follow; some usually did. The sled was always drawn by men, not dogs. The body was usually dressed in new clothes, with new mittens on hands. The body lay on its back always and arms were sometimes folded at right angles to the humerus, sometimes down by each side the body. A knife was sometimes placed in the man's hand; the food utensils and special cooking pot used during the last illness and other articles such as a man traveling might need, were placed outside the grave. The dress was also the full traveling garb, including "tapsi" and was the best that could be afforded. The chief mourner did not go out of the house for five days, sat most or all the time on the middle of the house floor, never lowered his or her hood, and ate separately from the rest of the people. No one in the village must sew new garments (but old ones might be mended) for the same five days. There was no singing, drumming, hammering, or other loud noise. At the end of the five days, the chief mourner took off all clothes, and put on new and the old ones were carried out on the sea ice and thrown away. No members of the family might eat of the heads of any animal of land, sea, or air, until after the first anniversary of the death. At this anniversary there was a sort of celebration and singing and dancing. It was not held at the grave and might be held anywhere. "People feared the dead thinking they might become turnñrat." M. knows of nothing resembling a soul or spirit inside a man who is well, but a sick man is entered by a sōkōtāk which has usually or always been sent by a shaman's "wishing the man to die." This finally kills him, or leaves him through being driven

out by another shaman. She does not know what or where these sokotat are before or after being inside a sick man, or after the death of one they have killed. She thinks only one enters any one man at a time. He is not possessed by two at once. On a good many of these fine points she is uncertain. Those prohibited from eating heads are the surviving husband or wife and the couple's children or adopted children; but not persons attached to the family as a sort of "free servant," the parents, brothers, and sisters of the dead, but not the parents, brothers, etc., of the dead person's surviving wife or husband. A grandchild of the dead must not eat heads but the husband or wife of a grandchild may. Adopted children differ from real in that a son, say, must refrain from heads for a year, but are under the prohibition that bind the son. All those under the head-eating prohibition throw away their old clothes and don new ones when the chief mourner does and in the same manner. If the dead owns good clothes they are used by some other member of the family. There is no fear of sleeping in the dead's bed place. The house is not avoided or abandoned because death has occurred, except that occasionally in epidemics where a whole family is dead within the house, the house is allowed to cave in upon them.

Ilavinirk tells: At Kigirktaruk (Kotzebue) when a man died the body was wrapped in skins and placed on a temporary rack made of two rows of crossed sticks. During the next winter the relatives gradually accumulate a quantity of driftwood or other logs near the grave. An elevation is formed by laying short stubs of large logs crosswise; on top these a box is built log-cabin fashion sometimes to a height of say five feet (perhaps a three foot pile of logs underneath making the total eight feet say). The body is then placed in this, and outside the remaining wood is piled tipi fashion, about the grave. In some cases a platform inside the tipi pile takes the place of the box. The body is dressed up for traveling at burial, and what a traveler may need is placed by the grave. The grave is visited twice after this, i. e., twice dressed in fresh clothes after the first had time to become rotten.

When a man was supposed to be about to die all bedding was carried out of the house except what the sick was using. If he died so late that dark came before the house could be put in order, the people either slept without their bedding or else did not sleep. It was seen to that at least one person was always awake. Soon after daylight the body, dressed in new clothes, if they were available, else the best of the available used clothes, was lifted through the windows "for the hole in the floor was unhandy for such things" and taken to the burial place. As soon as the body was gone, the willow flooring was cleared out of the house, new willows replaced it, and the bedding was brought back in. About the same prohibition as at Kittergaryuit maintained for five days. The people of the mourning house entered

no other house and none others entered theirs. After that there were no restrictions, Ilav. thinks, except that the mourners, ate for a greater or less part of the next year only of food secured by themselves or at least cooked at home.

When Ilav. was young he twice accompanied a party which made a long pilgrimage in two skin boats to the place inland on a river where a couple had buried their ten year old daughter, an only child. They each year dressed the body in new clothes and set the grave to rights. So long as they were about the grave a fire was kept constantly burning, so near as could be without danger to the grave. They cooked over this fire when the work was done, but often ate before that, in which case usually of pre-cooked or dry food which was warmed up by the fire. As they commenced eating of some food of which the dead had been especially fond, a piece would be cut off or divided off and put in the fire, the fonder the dead had been of the sort in question the larger a portion was put in the fire. It was said this was food for the dead. If the dead was a tobacco user, tobacco was also burned. When all work was done about the grave and all had eaten what they wanted, the rest of what food had been brought near the grave was burned just before the people left.

Ignirkariaktuat was the expression for lighting a fire by a grave, feasting there, and for the subsequent head- or foot-lifting, if that was to be done. Some time, say, when a number of boats were passing the recent or old grave of an añatkok they would stop, make a fire beside the grave, put into it each family a share of every sort of food they were going to contribute to the feast. Then all ate and the rest of the food was put in the fire. When this was done the listeners usually crouched around the fire on hands and knees to listen to the voice from the fire which was built near the grave of the dead añatkok. Questions were asked by the men around the fire and answered from the fire by the spirit of the dead añatkok through the mediation of the living añatkok who sat outside the circle. "These answers sometimes came true and sometimes not." Another method which did not necessitate the presence of an añatkok, though one would officiate if he was there, was that anyone at all laid himself on his back near the grave of the dead añatkok and another person lifted his foot or his head by a stick. If the foot was light the answer to any question was "No," if heavy it was "Yes." Ignirkariaktuat was also applied to the mere setting to rights of the grave and feeding the dead, as described. No unburned food was ever left by the grave.

*July 17.* Swimming. Swimming at Kittegaryuit, or rather wading was by both sexes, but in separate places. Both swam without clothes. In one case of three boys bathing, one of them (brother of Memoranna —

Jimmy) was drowned in a river about fifty yards wide and deep only in a small hole in the middle. Ilav. never knew of both sexes bathing together after they were say ten years old. Only a few really swam and only when grown.

Customs. Ilav. tells when a man died the first of his relatives to have a child would name it for him. Soon after this event the dead's nearest relative, a son if there was one, would inquire of the three, four, or five persons who had worked at the first burial of the dead, at making the final grave, or had tended the sick just before death, what they wanted for presents. Generally it was a full suit of clothes where the prospective recipient prescribed the sort of each garment. He would then ask the child what sort of food it preferred. If not old enough to speak, the child was answered for by one of its parents. He also prescribed a suit. If the child asked for caribou marrow the chief mourner often undertook a journey of several weeks to the upper Nogatak to buy marrow bones or shoot deer. When all was ready people were bidden to a feast in the karrigi. The child and those who waited on the dying or handled the dead are placed in the center; the child first receives its gifts, then the others. After this come gifts to those who have sewed the gift clothes or otherwise helped to prepare the feast. In the aggregate the chief mourner gives away a large amount, often all he has but the guns, his other food-gathering implements, and cooking utensils. The bedding from his house is frequently all given away. When the gifts to these are over, outsiders, all nearby are bidden and some from afar, join in the feast but they receive no presents. Everyone who gets a present soon pays for it by presents back to the mourner, though nothing is thought ill of it if they are unable to do so. Those who feast only make presents of food. The aggregate received by the mourner is usually as much as he gave, or more. The mourner always protests against these return gifts, saying he was only paying for services done the dead. Ilav. himself has given one such feast for his mother. She died when he was about eight or ten, he gave the feast when sixteen or eighteen years old. One woman who had tended the sick could not be reached, she had moved to another place. He has still in mind paying her if he ever has the chance. The man who gives the feast "kōñirkērūāk" (koñoruat — the bereaved).

Child Betrothals. Children at Kittegaryuit are often betrothed when young, sometimes a few weeks after birth. These are called: "katitarigik." In many cases they marry others, but when they do marry each other the event takes place rather before than after the girl's first menstruation.

Trade. Ilav. tells "Talak apa añaña" (Kittegaryuit form is apagma) used to go from Kigirktaruk in winter (not fall) by sled to the sea near Icy Cape, thence to Cape Smythe, and back by the same route, being home



before spring. His purpose was to buy stone pots, lamps, and wolverines. His trade was chiefly Siberian tobacco, but also other Siberian goods. This man was dead before Ilav. was born. There are several relatives at Cape Smythe connected with these journeys: e. g., Seravanna and Sagavanna. Ilav.'s father told him first and later Seravanna and others told him at Cape Smythe.

*July 19.* Arlu. Ilav. tells the smallest arlut are a little larger than the common seal, the largest are about equal to the largest walrus. Their general appearance is somewhat that of fish, their teeth are long and interlock in the manner of tiger forceps; they have some black maktak (black skin). They feed chiefly on seals and white whale. When they hunt seal they surround it as wolves do caribou. The arlut get all around the seal while some get below it to keep it from diving. The white whales, for fear of the arlut which prefer deep water, sometimes swim so near shore that they crawl on the bottom while their backs are out of water. People say that wolves and arlut are avariksut ("chips of the same block"), equivalent, alike, equal. When wolves starve on land they go to their relatives in the sea and turn arlut; likewise the arlut when unable to find food in the sea go inland and become wolves. These wolves, as far as Ilav. knows, are in no way differentiable from ordinary ones.

The Kigirktarugmiut frequently see the arlut but do not kill them. They tell a story of four brothers of the Imarxlit people who were hunting walrus in a boat. When the elders were not looking the youngest speared an arlu. His brothers reprovved him, but nevertheless "seeing it was dead any how" took it home, cut it up, and ate some of it. That night several arlut kept walking around the house, weeping as people do in grief, while a multitude of others swam near the beach. The four brothers all died soon after. Among the Akuliakattagmiut the common name for wolf is arluk. They know, however, the word amarak. Ilav. never heard of a wolf being spoken of as an arluk when seen at a distance.

*Marriage by Capture.* His second wife, Illrok, was taken "forcibly against her will" by Ovayuak (Kittetaryuit), brought home to the house, and prevented from going home that day. Later she did not go home "for fear of making Ovayuak angry." Anaratjiak, his former wife, was in the house at the time, she apparently was glad of the acquisition of a seamstress. Illirk had a mother, an older brother, and other relatives present. None did anything.

Young girls were told by the old women: "If you don't marry soon some young man who wants you, some old man will carry you off to be his first wife's servant." They also told a story of a woman who would not marry. Several married men and widowers had had an eye on her for a long time.

One day one of them attempted to carry her off, others tried to get her away from him, wanting her for themselves. In the struggle the woman suffered several breaks of bones and died as a result (Mamayaux).

*July 20.* Taboos. Ilav. tells on upper Noatak when he was a boy, caribou caught in snares must be skinned with stone knives only (anmark). The ear cartilage must not be separated from the head, but the skin of the ears must be with the hide. The head must not be cut from the trunk, but the body was cut in halves through the thorax. Ilav. does not know how many ribs went with the head part. The meat of a snared deer must not be boiled in any but a pottery kettle (kī-kū) but it might be roasted or eaten raw. He does not know that women were forbidden to eat certain parts of these deer. Deer shot with guns might be skinned with iron knives and cooked in metal pots. He thinks deer shot with bows in the open might be cooked in metal pots, but those shot with bows in "kañirkat" in enclosures must, he thinks, be cooked in pottery pots. When he was there, most of the shooting was with guns, except bows were often used in the enclosures.

When Ilav. was young there were certain localities (fishing places) known differing from other fishing places in that "oxerok" (seal, whale, etc., oil or blubber) must not be eaten with fish caught in them. This applies especially to the mouth of the Kuwūk and to Imaryuak.

*July 21.* Taboos. A woman with child cooked her food in a separate small pot. Some women when with child must not eat seal. Some women with child became skin poor while others fared well because no allowable food was on hand. After childbirth those who bore male children were not allowed to drink water for four days, but were allowed a little meat broth as part of their food, allowed to eat only a small quantity. Mamayaux when sick was once forbidden by an "unīnoyuak" anatkot to eat caribou, another time to eat seal. Sick persons were frequently forbidden to eat fish bellies. "Nerigovinñok, dokonoaktutin." Boys were aglirktut on killing first ptarmigan, deer, etc. Does not know just what the provisions were. There were special restrictions on women whose children died just after or else before birth: they must not get water from fresh or salt source, they must not eat outdoors, and when fishing with a hook must never take off their mittens while near the fishing place.

Nappan. The "Innum nappata" was like a small man inside of one's body. When a man died this remained near the grave and wept loudly. Only the añatkut heard it. M. has heard of one case where a dead man's nappata entered another man. It made him very sick but did not kill him.

*July 22.* Implements used for scaling Fish. On Kotzebue Sound and everywhere near, caribou ribs sharpened on one edge were used for scaling

fish. Large numbers of these were always found by children when prying into old house ruins, as well as scattered around old campsites.

*July 27.* Sleep walking and nightmare seem both to be included at Kittingaryuit under the term *itivvliyuak*. When a person cries out loudly in his sleep, starts up out of bed, or walks off while yet asleep, an empty chamber should be placed on his head, cap fashion. Some do not do this, but wake them with a dash of cold water. Mam. has known of many children and young people who walk in their sleep, but never of grown persons, or at least not old ones.

*Sealing.* Sealing at breathing holes in winter is said in old days to have been done by women as well as men at Baillie Island and elsewhere. When a person of either sex caught his or her first seal they were *aglernaktut*, about the same taboo as for loss of relatives: must not eat out-of-doors, etc. When the novice had killed his fifth seal (or fifth animal of any single sort?) the taboo was removed from him and all his family (*Mamayaux*).

*Turnñrat.* The fall of 1907 just after the sun went away, there were many people staying in Alualuk's house, which was then at Kañionik. One evening, Oblutok and Alualuk's son, Pausanna, went out together. When they came in Pausanna fainted on the floor and Oblutok was so weak he could hardly stand. Alualuk, who was a shaman then "but has discarded his spirits now, for he fears having them on account of the missionary," performed an incantation but to no purpose and the boy died that night. He was fifteen years old. Oblutok told that when they went out together they had seen a *turnñrak*. Oblutok died after two or three days. Both were perfectly well when they went outdoors just before seeing the *turnñrak* (*Mamayaux*).

*Marriage.* Marriage at Kittingaryuit is not countenanced between adopted brother and sister. A man may have two sisters for wives, either simultaneously or successively. A half-sister or an adopted sister are considered exactly as near relatives as full sisters.

*July 28.* *Turnñrat.* *Turnñrat* are in general like people; men see their bodies but seldom or never see their heads. The *turnñrat* are of both sexes, they marry and have children. A human *añatkok* often has sexual relations with a female *turnñrak* but it is doubtful if children result from this. On the other hand, male *turnñrat* often visit ordinary women as well as women *añatkot* and children often result. It is not told that *turnñrat* ever die a natural death though some may be killed by powerful *anatkut* (?). M. has never heard of one being killed by an *añatkok*, but has heard of their being severely hurt in the process of being driven off (*Mamayaux*). Has never heard of *turnñrat* getting old though they must do so for they are born babies as humans are. Still she has known of several generations of sha-

mans who had the same old man (turn̄rak) or old woman each after the death of the shaman preceding. It is clear therefore that if they do get decrepit with old age, their lives must embrace at least a good many generations of humans (Mamayaux). In the case of sex relations with turn̄rat the humans, male or female, become unconscious or fall asleep at the approach of the turn̄rak and awake only after it is gone. Children who have turn̄rat for fathers are said to be better runners and walkers than other men and quicker in all their actions. They have no special supernatural powers (M.).

Beliefs. The smell of a white man, say of his hand after he has thoroughly washed it, is considered to be different from that of an Eskimo and those not used to it are said to dislike it very much. There was much talk of this a few years ago but there is little now, for one used to the smell does not dislike it (Mamayaux). Some Eskimo of both sexes are known as having a disagreeable smell.

*July 29.* Clothing. Coats of both sexes at Kittegaryuit were formerly ornamented where the red dots of yarn are now used with red spots made of the "eyebrow" patches of the male willow ptarmigan (ak̄igivik), on hood, front of shoulders, and around coat above the bottom fringe. The red spots now appear also on the arms of the coat below the shoulder, but this is a recent borrowing from the inlanders, formerly there was on the arm, but one unbroken band of white.

*July 31.* Terms of Relationship (Kittegaryuit). Brother and sister older than he "atkalualuk"; brother and sister younger than he, "naiyagik"; two brothers or two sisters, "nukarik"; "atkalualua" has of recent years gone out of fashion in favor of "anīnaralugik" which, so far as Mam. knows, is also a Kittegaryuit word, not borrowed in recent years. A brother will address an older sister often as "agaraluñ" and she may be spoken of as "agaralua." "Anīnaraluñ" is used by older sister to brother; "anīñ" by younger sister to brother (e. g. Nogasak to Palaiyak).

*August 1.* Clothing. At Kittegaryuit (Mam.) boots were always to just below knee and so socks. The boots coming above the knee a recent borrowing from the West. Between boots and socks a thin slipper of caribou leg. The sock was of caribou as now, the boot of caribou leg and seal, white fish or rarely thin caribou sole (hair clipped close, if long). The boots had pointed toes and made track different from the western boot. For this reason, Kittegaryuit used to say Uallinergmiut tracks were like a bear's. Women's artegi hoods always trimmed with wolf, men's with wolf or wolverine. Dog skins never used. Women used wolf for hood trimmings and sleeve, but wolverine for bottom fringe.

Taboos. Aglernaktok was the eating in one day of caribou meat and

any of the following: bowhead, seal, or ugrug. White whale and caribou were allowed in one day. The oils of above animals also taboo with caribou, except white whale. For a while at the beginning of the tea-drinking habit, tea and white whale in one day were taboo. No new caribou clothes were made during white fish hunt, but new sealskins might be sewed and any old garment mended.

*August 3.* Skin Dressing. Skins are never scraped by men at Kittingaryuit. Never heard of kayak skins being chewed (cf. Boas). They are rotted and sewn while wet. In fly time they are protected from blue bottles by being encased in a sealskin "pok." Men who had no wives sometimes scraped deer legs for boots, etc. M. thinks therefore scraping skins was not aglernaktok but the men were merely lazy.

Cannibalism. Cannibalism heard of by M. only in case of a man who had killed an Indian and who was told by a shaman to eat a piece of the dead Indian. M. does not know the reason, but is sure that there was no scarcity of food at the time.

Kayaks. Kayaks were occasionally made at Kittingaryuit of caribou skins, but were considered inferior to sealskin ones; the women said too that sewing them was more difficult. Parties of kayak men often went inland, carrying their kayaks; one woman usually accompanied each five or six men to cook and sew for them. The rest of the women stayed on the coast and fished.

Kittingaryuit. Kittingaryuit was a large village only in summer. In winter the people scattered as they do now. The white whale caches were drawn upon when needed, hauled by sleds to where the owners were wintering. It was rare that a man camped by his whitefish caches to eat them up.

Importance of Early Ethnological Work. Five years ago (1906) Memoranna (Roxy) pretended to give me minutely the difference in the Mackenzie system of counting used "long ago" from that used today. The differences were trifling. Today for the first time I happened to note the numerals in Petitot's "Monographie." They show an excellent system of counting and wholly different from that given by Roxy. I have no doubt Petitot is substantially right. Thus, in a few years, has been lost from people's memory an interesting and significant fact. Some of the people who accompanied Petitot to Good Hope were of Roxy's own family, uncles or aunts, I forget which.

Taboos. Mam. told today that her people (Kittingaryuit, etc.) are grateful to the missionaries for letting them know that Sunday is aglernaktok (taboo). The idea underlying this gratitude seems to be that they suppose many of their past ills to be due to violation of this taboo, the existence of which they did not know; now they know the taboo, can avoid breaking it, and hope thereby to escape many ills.

*August 4.* Cardinal Points. In reading today Thalbitzer's "Skraelingerne: Markland, etc.," p. 207, where he says the Labrador people thought the "Karaler" dwelt on the same side of Davis St. as they did i. e., in the north, whereas they really dwelt to the east, in south Greenland, I am reminded of an interesting thing told me by Ilav. several weeks ago: At Kotzebue Sound the old men used to say and all the people believed it, that the seacoast was as a whole straight and that bends in it (e. g., Pt. Hope) were only local like kinks in a fairly tightly stretched line. This fits in with their absolute (as I believe) lack of comprehension even today of our cardinal points. An Eskimo who started north along the Labrador coast and finally got to South Greenland by way of Smith Sound would think of himself as going east, north, or whatever the original direction was, the whole time, he would no more be conscious of changing direction than we would if we traveled around the earth on a meridian. To begin with, Kavuñamun, etc., does not mean "to the north," "to the south" "to the east," or anything else in terms of our points of the compass, it means "up the coast" or "down the coast" as nearly as it can be translated into our speech.

*August 7.* Clothing. Ornamental trimmings of a coat (Mam. tells): A wolverine añutisium (hood trimming for a man's coat) should be black on top the head for a space of about equal to the width between the man's eyes; below that on either side of the face come the light stripes of the wolverine, the wider the better, then the dark of the sides and belly. This sort of piece is obtained by cutting a transverse band just in front of the arnaksium, which is cut so as to include the bow of the U-shaped white band of the wolverine skin, i. e. the arnaksium should have an unbroken band of white over the top of the woman's head down to the middle of each cheek. An arnaksium is sometimes made out of an añutisium by removing the black middle piece and substituting one or more pieces of white, so as to make the horseshoe from cheek to cheek. The hide of the wolverine in front of the añutisium so far forward as it has white in it, is used to trim the lower edge (hem) of the coat, the whitest of it in front, the next whitest behind, and third choice for the sides of the hips, i. e. about where the hands would fall when hanging naturally. Darker still is used to trim the sleeves and the darkest of all for the pendant strips on the shoulders, back, etc., of "fancy" coats.

Of a wolfskin the arnaksium is a strip of skin about three inches wide (in the best wolf pelts) about over the hip joints. The requirements are that the hair shall be long, white at its base, black in the middle, and white at the tips. This piece is extravagantly valued, so that though it is barely enough for the hoods of two coats and though the rest of the skin is valued less than wolverine, yet good wolf may be worth as much as two or even

three wolverines. Wolverines are worth as high as five fox skins at Baillie when good and \$40 at Cape Smythe.

Face trimmings for hood, itirvik (woman's, arnaksiun; man's añutisiun); sinit (when not sewn, siniksat, hem trimmings; atjiksinak, sleeve trimmings (wrist); kaiyoarotik (Nogatak word), the "corporal's" shoulder strip on some coats; nigyat, the (wolverine or other) pendants; avatiktjak, itirvik + siniksat, a combination for selling purposes, a unit of trade. This does not include the sleeve trimmings, shoulder bands, or pendants.

*August 8.* Mammoth. Kilígvainnok tjaunñrit parkitarañamik auglir-(k)sok pakuat (Mam). Tusarsugivaktuami kolinik niulignik kilígvúgnik (Pal). Kilígvainñok nunamin nuiyarañamik tokovaktuat (Mam.) The bleeding was started by a blow on the nose or by pricking it with a straw.

*August 18.* Horton River. Turnñrat. Iyírka are turnñrat which "do not fear people" and are harmless. Their peculiarities are illustrated by the following: When people see coming a sled unaccompanied by people they know the iyírkat are coming. Dogs pull these sleds but men cannot see them, only the harness and the tight traces of the pulling dogs can be seen. The sled or sleds halt near the people's houses, the snow blocks seem to rise of themselves to form the snowhouses, for the builders at work cannot be seen, only when the house wall has become so high as to completely screen the builder, his snow knife can sometimes be seen as he "flenses" the key block into the dome of the house. Then lamps are lighted and food prepared. Anyone who cares to look may see all this with safety. It is an uncanny sight, however, for everything seems to be done of itself (Tannaumirk and Mamayaux tell).

Tan. says the aliúkkat are feared by all. The kēyukkat are not dangerous (they are the shaman's familiar spirits) except when sent by a shaman for the purpose of doing harm. The dangerous thing about aliúkkat is the sight of their faces; it does no one harm to see their bodies and many have seen them (including Tannaumirk). Those who see their faces die suddenly, fall as if shot.

*August 19.* The spirit of the fire (ígnērum napata) was fed with a little blubber, tallow, akutok, or other fat by Kittegaryuit after fire was built, saying, "Nanirk, oktjōviaktorin." "Iliat oktjōviaktorlit," was said by people in boats as they passed any grave except a recent one; as they said this some sort of fat was thrown into the water, or on the beach if the boat was so near shore that it could be done. "Iliat aviutjaktarlit" was the universal expression that covered such an offering not only of fat but of any sort of food; "aviutjak" was any sort of food intended for spirits. Water was similarly given the spirit of the grave by being poured out anywhere while the giver was in sight of the grave.

*August 20.* Bear liver, whether of brown or white bear, does not make a person particularly sick, but his skin turns permanently white. Several persons are cited who have white patches on their bodies from eating bear liver i. e., loss of pigmentation — a well known phenomenon in all races. (Mamayaux). Tan. never heard of this till this summer, but now firmly believes it.

Names. Names at Kittgaryuit were never given by persons themselves or even by bystanders. If a stranger wanted to know a person's name he would wait till that person was out of hearing and then ask someone. A person would not tell his parents' names, the name of wife (or husband) any more readily than his own. They would readily, however, tell the names of their brothers and sisters, and of their own children.

*August 23.* Whistling. Whistling (Tan. says and my observation confirms it, though I never thought to enquire) is not practised by the Copper Eskimo. They used to succeed in whistling, however, on seeing him do it; they kept continually asking him to whistle more. At Kittgaryuit whistling was probably "always" known he thinks. It was practised especially in hunting white whales, when one got near the whale (ũñiöktũäk, whistles once; uñöksöktuak, keeps whistling).

*August 24.* Names of Houses at Kittgaryuit. Kañilirk, Allirk, Sukarluktok, Nũtarmiok, Kimiaryuk, Kajigimiok. There were many more houses with names in winter (occupied in winter) but Tan. and Mam. remember only these. In summer there were no people in any houses, but there were name-bearing tent places though most people tented in nameless, indiscriminate places. When a winter house got old it was rebuilt, so far as T. and M. know always on the identical site, except that the new building might be larger, smaller, or of different shape from the old. The new building always bore the name of the old. They knew of no house being built on a new site, "for the houses always got fewer, never more numerous."

*August 24.* Beliefs. Arnakpũk (dual) are two women of great size that dwell somewhere in the sky. There is no formal unipkak about these. The añatkut tell fragmentary things about them after their spirit flights, on which they sometimes see them. There is no name for each separately, except that because one has a coat of fawnskin she is referred to as Nogayualik; the other is dressed in skins of grown deer and is called Nogayuañittok. They both have a loud, strident laugh that in general resembles the cry of the willow ptarmigan. Men (not women) fear both, but especially Nogayualik. They frequently steal men añotitogugmañnik; those that Nogayualik steals, never return; those that Nogayuañittok takes wake up naked outdoors (Kuyagtagërannik) and return naked and nearly frozen to their houses. While they have the men in their possession they artigiminun irtirtipagit, tajvaniillutik (Tannaumirk and Mamayaux).



The Stars. The stars must be living things because their excreta are often seen dropping to the ground. Those who have examined these say it is plain they feed on seals (Tan. and Mam.).

Sun and Moon. The sun and moon are brother and sister. The brother went out to get ice for water. He was getting very cold, and his sister took a firebrand to go look for him. Some say, to go make him a fire to warm him. He, carrying a big piece of ice became the moon, she carrying a firebrand became the sun. This is an abstract of a long tale which both T. and M. have heard told by old Kittegaryuit people, neither of them can tell the whole story.

*August 26.* Beliefs. Shadows and reflections were made objects of fear to children at Kittegaryuit though Mam. never knew just what the fearsome thing was. She thinks people may have been "playing" somewhat as white people do who scare children with imaginary creatures. Children were especially told not to bend over the seal oil dish in eating, for they might see their reflection if they did. She was frequently told "get your face away from that oil dish; your reflection (tarran) may smile at you." Some people used to say there was no danger in seeing your reflection in anything except oil, i. e., it was well enough to look for your reflection in a river or pond.

*August 27.* White Whale Hunting Customs. On the afternoon of each day a shout was raised by someone who had climbed to the roof of one of the two Kittegaryuit kajigis. This was a sign for the kayakers to gather on the roof of the kajigi to talk of who should be the head kayaker (sivulirk) for tomorrow. Generally, there was a new head each day, though a man who was considered "better" than the rest might serve several days. While a man was leader, it was incumbent on his wife to be careful her fire should never quite go out, and during the pursuit of whales she must not go outdoors from her tent until the last whale had been killed or had escaped. When a whale had been killed, a single straw that had grown upon a grave was stuck into the wound and withdrawn. If several wounds, all were treated with the same straw, M. thinks, but is not sure. She thinks the straw was then thrown away. The straw was referred to as ikimūn kaul-rōtiksak. A similar custom was observed with regard to caribou. A man who had killed a white whale (or caribou, or other large game animal) usually had his earholes pierced, and must not eat blubber till the holes had healed. It was kept from closing by the use of a small peg. No one who had lost a relative by death must eat within the following year any part of a whale uncooked. If they did the man who had killed that whale would never get another whale.

*August 31.* Beliefs. When the new moon is first seen a person should spill a cup of water saying that it is for the "tatkim inna" to drink (Kitte-

garyuit — Mamayaux). This water should be spilled on the ground in the direction of the moon.

*September 1.* Distribution. Campsites of Eskimo are numerous around here. There are two "tent rings" of stones at a creek mouth half a mile west of sled route river (seen by the natives only). I found in various places scattered rotten sticks and broken bones, indications that some one had camped (either Eskimo or Indian) between here and Isugluk, and about half way to Isugluk probably half a dozen tent sites, with stone fireplaces, pieces of kayak slats, etc., clearly showing they were of Eskimo origin. There are no deer swimming places near, so either the parties were en route somewhere, or they used kayaks to set nets. Found also campsite of ship's natives a mile southwest of Isugluk, plenty broken boxes, canned meat tins, etc. A half dozen long sticks of firewood I raised up in tipi frame style, thinking someone may need them sometimes for wood. These are in a hollow, at the north end of a small lake.

*September 3.* Customs. "Show me your tongue," (Okän nauñ?) is said at Kittetaryuit (especially to children, but also to older persons in jest) if one thinks the speaker may be telling fibs. They do not know why people speak so, they never heard of the tongues of fibbers looking otherwise than of those who tell the truth. Icelandic children are told, however, that if they fib, a black spot appears on the tongue, and "show me your tongue" is frequently said to them.

Beliefs. Tannaumirk was frequently told when small, not to eat standing up as it would make his feet weak and liable to swell up. Mam. was told not to sing when eating but she never knew the penalty.

*September 6.* Customs. Tan. tells in traveling, when camp was pitched, the sleds must stand over night only with their front ends pointing the direction the people were traveling, i. e., towards their destination. Snowhouses and tents had the door toward the sun, always between southeast and southwest, no matter how the coast trended. The snowhouses were built on the ice near shore, never on shore. The only exception to houses facing the sun was when several were built or tents pitched so as to have a common central kitchen. This might be done with from two to six houses. In summer, the kitchen was like an Indian tipi. The tipi poles for the ordinary tents were in sets of fours, fastened together, tripod fashion at the top by thongs passed through holes. The tipi poles for the common kitchen were not perforated at the top, but merely lashed together. They were crude and made afresh at each campsite; the house poles were slender, finished ones, and were always carried along in traveling. The tent poles we keep finding around our present hunting grounds cannot be Eskimo for they have no holes at the top ends, but instead a groove for the string about six inches from

the top of each. The length of poles found around Horton River usually about eight feet. These poles are therefore probably the traveling tipi poles of the Good Hope Indians. Eskimo do not throw away finished tent poles, we find these not only abandoned, on the return of the parties to the wooded river valley, no doubt, but also in many cases some have been used for firewood.

*September 10.* Snares. Snaring caribou was never practised at Kittingaryuit so far as Tan. and Mam. know. Ptarmigan and squirrels only snared.

*September 12.* Taboos. At Kittingaryuit during the beluga season all were forbidden to "work earth" i. e., holes or pits must not be dug, macu roots must not be gathered, etc. Berries might be gathered, however. Children at play were reprimanded whenever found breaking this taboo. The beluga skins were cut usually or always around the throat and the waist, i. e., the piece of skin between throat and waist was dried for bootsoles, canoe covers, lines, etc. The skin of the head and tail was eaten as maktak. When being dried this piece of skin was pegged on the ground as sealskins are. It was strictly required that the headward part of the skin should be towards inland, the tailward towards the sea. It was said if a skin were dried in the reverse position the beluga would cease visiting that part of the coast. During the beluga season no new deerskin garments must be made but old ones were mended; new sealskin clothes were made, however. New caribou clothes or clothes of muskrat (perhap other skins too) must not be made while the sun was absent. No one attempted hooking or otherwise catching fish during the dark days. Mam. never heard that there was a prohibition, but it was said none could be caught.

*Distribution.* Eskimo tent sites (two tents) seen Monday just east of the tree line about eight miles southeast of camp, stone fireplace and a few small sticks of firewood on top a stoneless woodless hill.

*September 13.* Beliefs. Growing girls were told that when they wake up in the morning they must not linger in bed but must go outdoors at once, if but for a moment. Some were not even allowed to dress, but were made to go out-doors naked or partly clad. They were told that doing this would make child delivery easy, while if they lingered in bed while young they would have slow and painful delivery when they came to have children. Growing boys were also made to go out-doors similarly but Mam. does not know what they were told would happen if they did not (Kittegaryuit).

*September 22.* Coal Creek. Beliefs. Aktlat know what people talk about (Ilav. Tan. Mam.). If a man boasts, "I am not afraid of aktlat; I could kill one with my knife," then aktlats will attack that man the first chance they get; but if a man speaks modestly and says he is afraid of bears,

they will not attack him. For this reason (Ilavinirk says) many who are really not afraid of bears always take care to pretend they are, as an additional precaution against danger from bears.

Originality. Mam. Tan., and Pal. say that people commonly say that the Kiligav<sup>ait</sup> refused to enter the ark when Noah invited them in, preferring to hide from the flood underground. This is a case of grafting on to the new Christian mythology a bit of their own folklore, which was merely to the effect that the Kiligav<sup>ait</sup> lived underground like moles. Some seem to have believed they all became extinct anciently; others that they still live underground mole fashion; are very rare animals, though not extinct, and come out only at night. All our Eskimo believe that the refusal of the mammoth to enter the ark is recorded in the bible. They have no notion it is an Eskimo emulation of the Jewish account.

*September 25.* Beliefs. The 'keel' of the breastbone of some ptarmigan is white uniformly; the egg from which this bird was born was laid in cloudless weather. If the 'keel' is unevenly colored (as seen held up against the light) the egg was laid in cloudy weather. (Mam., Kittegaryuit). Ilav. knows this belief for Kotzebue Sound, but says the clear 'keels' are those laid in cloudy weather and the spotted ones in clear weather.

Ptarmigan Snaring. Ptarmigan snaring in spring is practised by using a dead male or the skin of one for bait. The bird is set up as if alive and a net or snares put around. Another male bird will come up 'to fight' this one, and is caught. The ptarmigan thus used for a decoy, or any bird used for a decoy, or any model of a bird used so, is called 'Mittauyak' (Mam.).

*September 27.* Taboos. The brain of the moose killed by A.'s party in 1909 was aglernaktok to Nogasak, according to Tutak 'Auktälgum nuliaña' who is probably a Killirmiut. She said that no other part of the moose was aglernaktok and the brain only to girls not grown; may have been taboo to small boys too. There were none in the party.

*September 30.* Beliefs. A woman who has a child she wants to grow tall should sew the side seams of its coat with sinew from the neck of a swan (Kittegaryuit—Mam.). Sinew from the wing (breast) muscles of ptarmigan Mamayauk has known to be used, braided. One man she knows put a pair of soles in his boots with ptarmigan sinew.

*October 1.* Rattles. Children at Kittegaryuit used to play with rattles made of ptarmigan crops blown up. The rattle was produced with berries found in the crop. Children were reprimanded for making such playthings out of snared birds. Mam. thinks that this taboo applied only in the winter and spring, but is not sure.

*October 3.* Locality Names. At Kittegaryuit the people between the Mackenzie Delta and Herschel Island were Tuyörmiat. West of Herschel

to Demarcation Point were also Tuyõrmiat, Mam. thinks but is not sure. Apkvãrmiut were the people of Utkiawik and Nuvuk (Point Barrow). All other western people known (by hearsay chiefly) before the ships came were Nunatarmiut. To the east all people were Kañmalit. Those to the Baillie Islands were correctly known by place names; of those east Mam. heard only of Nagyuktogmiut and supposes east of Baillie bore this name. She heard of Akilinirmiut, but always supposed (never was told) that they were 'Kitegaryum akiani' i. e., across the sea (north) from Kitegaryuit. She heard it frequently told that the valuable beads came from the Akilinirmiut. This would make it seem likely that Akilinirk was Siberia, but Ilav. and Nat. never heard of such a name applied to any part of Siberia.

Bering Straits were crossed in winter by a dash being made when weather was especially favorable, from the mainland to the Diomedes. Here a wait usually took place, and another dash accomplished the remaining twenty miles or so to the Asiatic side. Sometimes the party returned the same day to the Diomedes, for fear of the ice moving. Only light sleds with plenty dogs were used, and the trip was seldom undertaken except when tobacco was scarce. The bulk of intercontinental traffic was by boats in summer (Ilavinirk).

Taboos. Tan. says that about the only taboo in which he now firmly believes and which he carefully observes is that against sitting on or over charcoal on a charred stick. A man who does this becomes prone to capsizing in a kayak.

*November 2.* Taboos. Food that has fallen to the ground or floor is taboo (God has forbidden us to eat it) unless in picking it up one describes with it a circle in front of one's face just before eating it. Some believe this applies only to tanuktak or white men's foods. They have asked — about this taboo and he never heard of it "but he may not know all God's commands" and so the taboo is kept. Licking off the blade of one's knife and passing food at table with the left hand are taboos ascribed to missionaries at Kitegaryuit (Ilav. and Mam.).

*November 5.* Raven and Crane Groups. Ilav. says his father and his contemporaries used to have heated arguments in the karrigi (Kigirktaruk) over which were more excellent birds, ravens or cranes. Those who favored ravens were said to "tuluganmuktoktut"; they who favored cranes, "tatiriganmuktoktut." The whole community took sides, made two parties. Sons did not always but often did belong to the party of their father. At one time when Ilav.'s father had tobacco, he placed a large pile of it in the karrigi, saying that anyone who admitted the superiority of the crane might help himself, and no other might take any. Only one man held out against this bribe. Arguments were based, so far as they had any solid basis, on

the crane's eating dirty things, stealing, etc. Those who favored cranes, would become angry on seeing a raven and would try hard to kill it, shooting at it at long range or on the wing. Cranes were similarly viewed by the raven party.

*November 21.* Influence of Missionaries. Ilav. and Tan. say all the missionaries have told them never to forget Jesus. If they do, he will not take them into heaven. Therefore neither of the two informants ever ceases to think about Jesus when awake, nor does any converted Eskimo even when angry, when hunting caribou, when dancing, singing etc. Probably from some such expression as "The Lord shall make the wicked to crawl in the dust" there has been evolved (Kittetaryuit and Baillie) a detailed account credited to — of how those who do not believe will after death have to crawl on their knees and elbows till all flesh is worn off and till finally, the leg and forearm bones are quite worn out and drop off.

*November 23.* Customs. All here are horrified at my telling of the Puiplirmiut that they pick frozen deer droppings off the snow, keep them in pails, and eat them like berries. Ilav. says that while this practice is repulsive the Puiplirmiut deer droppings are really a fine thing when boiled and used to thicken blood soup. This is much practised in Western Alaska.

*November 24.* Langton Bay. Langton Bay Inhabitants. From notes taken, August 10, 1911 at the Baillie Islands by Ilavinirk from Panigyuk, the oldest woman there. Langton Bay harbor sandspit called Nuvuayuk. Its people lived on whale, seal, caribou, and fish at different seasons. There were no fish nets while she was at Langton Bay (till about 1845) nor even at Baillie Island till later. Fish were hooked and speared. Another settlement was where we dug house ruins in July, 1911. There the people also had a "mine" of clay for pots. The Baillie Island river used to get their pot clay from a cutbank on the east bank of the mouth of "Macfarlane River," which place therefore has the name "kiku." Most people had only clay pots, but a few had stone ones. All stone pots and all lamps came from the east. A settlement north towards Parry was Annigak; a high hill near it is Piñogyuk (this place was seen by my men, when in April, 1910, I shot two young caribou bulls near it). It is marked by remains of platform caches. There were also people at Booth Islands and, she heard, everywhere east along the coast to the Nagyuktogmiut.

There were two years (not successive) where many people died (Ilav. did not know if of hunger or sickness); after the second all people left the vicinity of Langton Bay (about 1845, a little before Richardson's visit whom P. saw at Baillie), some went to Baillie, others east; nothing ever heard of those that went east. People used to hunt and fish southeast on top hill. How far they sometimes penetrated is not clear, I have seen camps

about eight miles southeast of our house in Coal Creek. The most frequented lakes she knew of were Omatilik (about six miles southeast of Nuvuayuk, a lake with a "heart shaped" island) and Amituaryuk, about five miles southeast of Monayuk. The sandspit settlement at Baillie was called Iglulualuit and Iglu was near the Smoking Mountains. Tutipkirk was the V-shaped river valley right by Capt. Wolki's house.

*December 6.* Beliefs. The word *tupilak* seems to have been introduced by the missionaries in the Mackenzie district and our Eskimo do not know just what it means. Artificial monsters are known to all of our Eskimo but do not seem to have a generic name. Ilav. tells the following story. Something over twenty years ago before Ilav. went to Point Hope there was living there Nasukpak, the father of an Okpik who used later to be at Herschel, who returned to Point Hope about five years ago, and who has since died. Was carried off on the ice, or had some other fatal misadventure while tending traps on the ice, at any rate went to traps and never returned. One night when Nasukpak was asleep, a polar bear entered through the window and bit off his ear. It then retreated, other people (not Nasukpak) pursued and killed it. It was found that the thing was a polar bearskin stuffed with shavings, and had intestines of thongs. In its stomach was found the ear it had bitten off Nasukpak. Such a monster is called *Nanuliak* (literally, a made nanuk). On account of this affair Okpik hunted bears with great vindictiveness, to revenge his father's loss of the ear. It was never discovered so far as Ilav. knows who had made the bear. Ilav. never heard of artificial monsters made by others than the *añatkut* of Point Hope. They also had the practices of "*piliruak*" (he makes them become wanting), a special sort of *añatkut* performance to deprive a man, a family, or a community of the power of securing food animals. Such performances were always secret, as they were not approved by the community. They were generally outdoors at night after the *anatkok's* housemates had gone to sleep. If a man was "caught in the act" he used to bribe or try to bribe the one who detected him into keeping silent. It is said some paid very heavy bribe money. The making of artificial bears and other monsters has been casually heard of by Mam. but she knows no details.

*December 10.* Beliefs. An *añatkuk* in Uñulivik on the shores of *Imaruk*, on the edge of the Mallemiut territory was Ilav.'s fathers "*arnakata*" (really *katta*, i. e., their fathers had exchanged wives). Out of his mind with drink he had shot his wife, of whom he was really very fond. There were three of her relatives present. They spread a skin over the murdered woman where she had fallen on the ground; then one of them wanted to kill the murderer at once, but the other two said this was no real murder, for the man was as if asleep and dreaming. They therefore deprived the

bloodthirsty man of all weapons and kept him away. The añatkok, Axañak, was told of the tragedy when he recovered from his drunk. When he knew what he had done he sent for the relatives of his wife and asked them to kill him at once, to place his body under the same skin with his wife and to bury them together. To this the bloodthirsty one at once agreed, the others protested, but the añatkok's will and the desires of the one relative overcame the objections of the other two, and they killed Axañak with a spear. They then cut off his head, and his arms at the shoulders. They put the head into a bag which Ilav. thinks was the man's own stomach, slit open his thorax along the sternum (one side of it) and put the head in. Then they left the body in a clump of willows. The cutting up, etc., was "for fear of the dead man's nappata." Ilav.'s father later gave the body the customary burial and took the head out of the chest. The three men "as was the custom with mankillers" drank some of the dead man's blood, to appease or confuse his soul (?). The bloodthirsty of the three brothers soon died of starvation apparently, though he always ate with a good appetite. He grew thin without being sick, and died. Another got sores which broke out on one part of his body when they healed on another, and he too soon died. The third lived a long time but was unlucky in most things he did, especially in that no animals were ever caught in his traps and he had great difficulty and rarely was successful in approaching any game animals. Ilav. never heard of eating the dead man's heart or of taking out his eyes. Cf. Rasmussen.

*December 11.* Taboos. Ilav. tells that (about 1885 or 1888) the use of any but antler ice picks was taboo for the making of holes through which it was intended to hook for fish on the "Lagoon" (Imarruk) in Kotzebue Sound at the mouth of Kuwûk and Selawik Rivers.

*December 16.* Coal Creek. Whales. The Coronation Gulf Eskimo uniformly told us that white whales (beluga) did not come into the gulf. They did not even know the name (so my Eskimo say) until Tan. described kilalukkat to them. Live bowheads are not seen but a dead one carrying a brass "whaling iron" was stranded on an island not far off shore from the mouth of the Kugaryuk and I saw a harpoon foreshaft made of the brass "iron." Several sleds there are shod with whalebone (lower maxillary). Walrus are known by hearsay from the east.

*December 22.* Beliefs. Pan. tells: About eighteen years ago there died at Cape Smythe a Point Hope man named Omigluk. He died suddenly after eating some maktak, but it was believed of natural causes, i. e., not through violating any taboo. It is well known that if a man dies while the maktak of a freshly killed whale is still in his stomach, the men who were engaged in the killing of that whale will not get another one unless the



stomach of the dead man is taken out and the maktak thrown back into the sea. This was not done with Omiglak, perhaps because the belief did not exist at Cape Smythe or had lapsed. The next season the men who had killed the whale of which Omiglak ate, were unable to get any whales. They knew then that the breaking of the taboo was the cause, and that summer a man was paid a large fee by Kallrélanna (Utkiavigmiut (?)) to cut the stomach out. He did so, and the next year his boat crew caught one or more whales. (Ilavinirk doubts some details of this story. He saw the man die.) It was in spring before Ilav.'s "umialik" had launched his boat for whaling, but others may have already been launched and he does not remember if any new maktak had been secured by anyone. He left Cape Smythe for Herschel the following summer and therefore O.'s stomach may have been cut out, though he never heard of it. At Point Hope, however, while Ilav. was there (about 1880 or '90 when Leavitt, Wolf, Brower, etc., were there) a man died in spring soon after eating maktak. He was Tarrénirk, Kivalinirgmiut, wife of a Point Hope man Kiktoriak. Many engaged in whaling contributed maktak, etc., to pay Amaroak (at Point Hope, a poor old woman who had always had this job) to cut out the stomach. She cut it out, threw the contents in the sea, and hung the stomach to dry on a stick over the grave. Ilav. knows no ceremonies connected with this.

The Nappan. The nappan visits distant or near places when we dream and then returns. Occasionally our nappan is absent even when one is awake. The person then feels cold. When a shaman is absent on a spirit flight his body is often so cold that hoar frost forms from his breath about his mouth and nostrils though he be lying in ever so hot a house. The following story brings out several points (Tan.).

Tan. borrowed a pup from Kenoranna, a Point Hope woman, since returned to Point Hope and dead. The pup got out of his harness when Tan. was fetching wood from the mainland south of Flanders Point (Herschel). The pup could not be caught, failed to follow the sled home, got into some one's deadfall and was killed. Through anger the woman cried all night and refused even two good dogs as pay for the one pup. All the rest of the winter, Tan. was well, except once for four days. That summer he returned to Kittegaryuit and towards fall he became sick, his heart beat fast and he was ill after eating, especially after a heavy meal. He got gradually worse towards the anniversary of the dog's death, after which he gradually improved towards spring and during the summer he was practically well, getting worse as winter came on. This went on for four years. At times he felt very cold, even when others felt warm. Many tried to find his nappan but none could discover where he had hidden it, for the Pt. Hope woman had stolen and hidden his "soul." Even Alualuk (considered a great

shaman) had tried several times and failed. Finally Alualuk's wife said she would try for five days. On the third day of her search she learned where it was. It was hidden in the jaw bone of a stranded whale. Really it was Alualuk who found it, while assisting his wife. The reason it had not been sooner found was that there was so much grease on the bone, a thing (oksūk) which always hinders shamans. When Alualuk had found where the soul was, his wife freed it of his anniaron. Tannaumim anniarote was probably, Tan. says, the Point Hope woman's turnūrak, which, he does not know which, had either been in Tan.'s body or else had been in Tan.'s soul, or on it while it was prisoner in the jawbone. Alualuk's wife took hold of Tan.'s hands when she told him he was freed of his anniaron and he felt the coldness leave him then, never to return. Tan. never knew where the jawbone was stranded. He used to dream the Point Hope woman frequently. Has rarely dreamt her since he got well. Alualuk said that people whose souls are hidden in whales' jawbones usually die, for the grease on the bone makes it almost impossible to find the soul. As Tan.'s illness had been long and serious he naturally thought of looking for his soul in whales' jawbones and finally he found it.

The Nappan. When sneezing one knows that one's nappan is about to return from somewhere, and one should say "uvaña kait kait kain." If a young child sneezes, someone present should name the "atka" (dead person whose "sauñra" the child is) saying e. g. "Nogasak kait kait kain." The expression kait kain (come here) may be used to call grown people to you, but is more often heard used in calling children, as "Karlik (a child's name), kait kain, nerrin" (Karlik, come here and eat something).

Cleanliness. Pan. tells: The people of the Neriktoglimiut (Yukon flats) are so lousy that even the dry fish they sell others is full of lice. Lice crawl all over their faces while they are eating and they lick them into their mouths when they come too near the lips. A dog sleeping on the house floor was killed in one night. These people wear clothes of fish and bird skins and of grass plaits. They call lice neriktit, hence their tribal name.

Nunivak is an island near the country of these lousy people. The Nunivak people sometimes come to St. Michael's to trade.

*December 27.* Beliefs. In Kotzebue Sound and elsewhere each fish net used to have its own añroak, usually the skin of some bird of prey. A feather of each particular net's patron bird was tied to the net when it was used in fishing. The better the charm, the more the net would catch (Ilav.).

Beliefs. Before eating tītālrk (losch) the lips and hands should be greased with oil (ōksok) which at Kittegaryuit, white fish oil (beluga) for losch skin sticks so easily to anything. Really this may not be so much a 'belief' as a practical device, though I never should prefer oil on my hands to the fish skin. There seems however, to be unusually much glue in losch.

*December 29.* Beliefs. In Kotzebue Sound a window of intestine strips must be so placed that the seams be lengthwise of the house i. e., from door to opposite gable. It was said if the seams were crosswise the frost on window would be rough, if lengthwise then smoother. They used to say: *tívarluñnaktok* of a window with seams crosswise.

Anatkok Beliefs. When a young boy Ilavinirk saw in Kotzebue Sound an old man who had when a boy seen the Kinannirk of whom the following is told (K. was probably a Kigirkarrumiut). K. was out walking alone when there appeared from the ground the head and shoulders of an ali-yugak (puitga, as a seal rises out of water). The A. spoke to K. telling him to follow it and he should become a great shaman. K. refused on the ground he did not want to risk leaving his child, of whom he was very fond. The A. said then it would appear again to give K. another chance. K. went home and told all this. At a corresponding time next year (puivia tikinman) it appeared as before. K. then asked it various questions, e. g., "If I take you for my spirit (keyugak) shall I be able to walk on water?" "Yes, if you care to." "Shall I be able to get deer, seals, etc., by magical means?" "Yes, that I can help you with easily." In this way K. asked about all the usual accomplishments of an anatkut and always got an affirmative answer, yet at the end he still refused to follow. The spirit disappeared (*nakkaktok*) saying it would come again; K. went home and told as before. The next year at a corresponding time the spirit appeared as before. Then K. asked it, "If I have you for my keyugak, shall I this summer when the people of various tribes assemble at the trading village, be able to walk through the air in the sight of everybody and fetch snow from the clouds?" "Now you have at last asked a difficult thing. I cannot help you do that. There may be some other spirit who can but I can't." K. then refused point blank to become a shaman. The A. now was angry and said, "Since you will not on any persuasion become a shaman, you shall cease to enjoy good food." K. then fainted and the A. went down. Soon it came up again with a man's fresh looking lower jaw in its mouth. K. awoke and found his jawbone missing. There was no wound to show how the bone had been removed. He now went home to people who were struck with wonder at his tale. After that he never could chew anything. He lived on fluid foods (soups, etc.). When he drank he had to take hold of his lower lip and hold his mouth in shape so he could have food poured into it. He lived this way many years. Note: As implied above, the Kotzebue Eskimo believed that certain clouds (woolbag clouds, especially) were snow, hence the idea of getting snow from the clouds.

*December 30.* Ceremonies. *Aktlā-kēyuat* was a "dark-days" ceremony at Kittetaryuit. Three, four, or even six men took part as chief performers. A brown bear's headskin was stuffed with wood shavings, something was

used to represent eyes and teeth, and a toktluk of wood was placed in the natural place (toktluk, voice box). A man would carry the bear's head in his mouth by holding the toktluk between his teeth. It was said the bear had entered the man and that the bear's head protruded from the man's mouth. The man also wore mittens of the front foot skin of the bear, claws attached. A crowd of men and women (no children) would flee before the bears into a house. The bears followed in and chased people around. At times there was laughing, but at times fear was simulated and children were always badly frightened. Habitually, naughty children were especially scared by the bears. Children used to carry pieces of itiptak in their mouths as protection against the bears (itiptak, the blubber hung up so as to drip into the lamp, a custom unknown (?) among Copper Eskimo). After a while people would flee out of the house and into another, followed by the bears. Thus they would enter every house. At the end of the performance, the bear heads and paws were hidden, probably under the bed clothes in the owner's house. The performance would be repeated every morning and evening while the sun was away. Polar bear heads were used as well as brown bear, and the performance of those who wore them was exactly as that of the brown bears. There was a preference for having at least one polar bear head in the performance, if possible. The brown bear headskins were sometimes replaced (if none were available, or not enough) by imitations made out of worn-out garments, etc. The men who took the leading parts were, so far as Mam. knows, any who cared to, some were old men, some young, and none she thinks were añaatkut. The same man might take a bear's part year after year, or another might take his place.

Sometimes when the bears went out of a house a woman was sent to try to get them to come back. She would put on a worthless coat, go out, come in, and as she came up through the door (kattak) she would report that no signs could be seen of the bears, they must be gone far off. Just then the bears (who had never really gone out but were hiding in the dark below the kattak) jump up, seize the woman by her coat, she struggles violently and tears the coat, leaving pieces of it in their hands. This is usually done as if in earnest, but occasionally there is laughter. These games were discontinued only five or six years ago (Mam.).

Taboos. At Selawik (Silavik) but not Kigirkarruk hares (but not bush rabbits) were taboo in the fall until all caribou clothes had been made. Hares killed were hung up in trees (willow, cottonwood, or birch, no spruce just there) not nearer the house than about half mile. When all caribou garments were made, the house floors were cleared of all loose stuff, new flooring was brought in (willows) and then the hares fetched home and the first meal of hare meat eaten. At Kigirkarruk seals and connies (sit)

were taboo till all caribou clothes were made. The sít were cached in ice block houses by the net holes till the taboo was off, usually till the dark days or even to the sun's return if the women had much sewing to do. Seals were hunted too occasionally, but must be cached on the ice and not brought ashore or used till all garments were sewn.

Kigirtarrumiut. Kigirtarrumiut embraced all who spoke that dialect, though some lived habitually as far as two sleeps from Kigirtarruk.

*December 31.* Sign Language. Among the Kittegaryuit a raising of the eyebrows means "Yes,"; a raising of the upper lip that produces vertical wrinkles along the nose as well as a wrinkling of the nose itself, means "No." Side stepping with arms raised above the head: caribou or other big game in sight. Standing with arms horizontal: come here. A motion with both hands as if to put something on the ground: stop, don't come closer. Among Copper Eskimo, running sidewise from the trail and back across it: strangers are coming. Hands above the head: we are unarmed (a sign of peace).

*January 2, 1912.* The Name. I have a thousand times at least heard Mamayauk address her daughter Nogasak as amañ or amamañ, and I have long known that ama and amama means his (her) mother. I have, however, in this case either let the word pass uninterpreted through my ears or else have (when occasionally I have conjectured a meaning) considered it analogous to a married man with us addressing his wife as "mother" copying the children's use of that word. Today I heard Nogasak speak of Memoranna's (Jimmy's) wife Sanikpiak as panniga (my daughter) and asked the explanation. I learned then that S. speaks of Nogasak as mother, the reason being that the name "Nogasak" is that of Sanikpiak's dead mother — the little girl Nogasak is by S. identified with her dead mother (Sanikpiak's). Nogasak also bears the name Pannigiok which is that of Mamayauk's mother. This makes Nogasak her own mother's "mother" and Mamayauk her own daughter's daughter though Nogasak never makes use of the word daughter to Mamayauk but only to Sanikpiak. This may be characterized as a sort of reincarnation theory where Nogasak is looked upon as being rather than representing two dead individuals.

Note: Compare this with "uvaña kait kain" (ante) used on sneezing (I myself, come here). If a mother uses this formula for her infant child she says: "Nogasak (e. g.) kait kain" where the Nogasak being addressed is not the child Nogasak but the dead person of that name, or the soul of that dead person. Later, when Nogasak has learned to speak and can use the formula for herself, uvaña, not what it would with us, but — the dead Nogasak, or her soul. The atka (name, soul) of the dead person is therefore *I myself*, somewhat as our ancestors used to speak of *my mind* and *my body*, as if the mind and body were not *I*, but merely the possessions of *I*.

*January 6.* Kotzebue Beliefs. The first time pieces of meat or blubber are taken out of a pok the first piece taken out is laid at one side of the platter where it won't get confused with the others, and when enough has been taken out of the bag the first piece is put back in the bag with a command (or entreaty) to the napotat of the pieces to return to the pok (inman tasořiũñ, is said). This prevents the contents of the bag from being quickly used up. This custom was identically observed at Kittegaryuit. In addition at Kittegaryuit the food bags had their special charms, some to prevent the food getting used up, others to prevent theft. Mam. does not know just what these charms were. They probably differed with different persons. One amulet that was much used on all sorts of bags and boxes was the skin of a "crazy" oldsquaw duck. Anyone who stole from a bag protected by such a charm would soon after lose his reason and in his wanderings would among other things tell about the theft. When Mam. caught her first fish with a hook (a counie) her father after it was dead, gouged out its eyes, with the intent to make M. thereby fortunate at hooking fish (Kotzebue). The first animal a boy killed of any given sort must not be eaten by himself or his family, but all neighbors should be invited in and each should have a piece, though a score of people might thus have to eat of a small ptarmigan. When the animal was small (and sometimes this was done even with a large animal) presents of tobacco, etc., were given "to make up for the smallness of the animal" Ilav. thinks, i. e., to pay people for the trouble of coming to an insufficient meal. In case of hunger, the young hunter and his family might eat of an animal, except they must on no condition touch the head (to eat of it). At Kittegaryuit there were feasts at a first killing of any animal and the young hunter must eat a part of the heart of the animal he killed (Kotzebue). The first bag of berries or roots picked up by a girl was subject to the same ceremonies as an animal killed by a boy.

*January 12.* Indians used to hunt to the head of Harroby Bay in summer when the caribou skins were thin. For that reason a place at the head of the bay is called Satoksiorvik (a cutbank, Ilav. thinks). The Eskimo did not for that reason hunt there and even today many Baillie Island people have never been to the head of Harroby Bay.

Beliefs. A few years ago when Aiaki and others came from the Colville to Herschel they told that when one killed a caribou on Sunday one should proceed as follows: — The hind legs must be dismembered at the hock joint and then the saddle in one piece removed from the trunk about the kidneys. The saddle must then be lifted up and hurled as far as one can from the skinning place. This is food for God. Next day the saddle may be picked up and used for food, but must on no condition be removed the day the

animal is killed (Sunday). This formula was said to have come to the Colville from Cape Smythe from Mr. — who was then missionary there.

Influence of Missionaries. Mr. — at Herschel told that when Noah invited the Kiligavûk (mammoth) to enter the ark he refused on the ground that the ark was too crowded, and that his legs were anyway long enough to keep his head above the water. The mammoth were therefore all exterminated by the flood and their bones only remain.

Baptism was explained by Mr. — as making a man's head and its surroundings shine so it could be seen in the dark like the light of a window. Ilav. saw one baptized man (Añusinnaaux) last summer, but the halo did not show because it was not dark; but he has no doubt it can be seen now that it is winter with dark nights.

Gifts or anything else handed by one man to another must be passed with the right hand. This is a religious commandment for which Mr. — is authority. Usua'yak, Oniak's father, is said to be the only Eskimo who has remained unconverted. For that reason his son makes him live in a tent by himself and eat with food utensils (plate, etc.) which no one else touches (Ilav.).

*January 13.* Adoption of Children. Child adoption at Kittegaryuit was always accompanied by a present, "any little thing," to the child's mother "to keep the child from becoming ill." There were usually presents in Kotzebue both at adoption and "now and then" after; if the real and adopted parents lived far apart, there were small presents to the real parents whenever they chanced to meet the adopters.

*Burials.* Burials often took place among Nogatogmiut before man was dead. Ilav. saw one man hauled out who sat up in the sled on the way, and there were said to be frequent cases of bundled up men (corpse fashion) who kept hungry dogs at bay for a while by saying "goh" at them.

*January 14.* Distribution. Pā'nigyok told Ilav. last summer that the largest house among those in which we dug last summer at the Okat village was not a clubhouse, but was occupied by a great many people all of whom were of one family, sons, sons-in-law, etc. Ilav. asked if houses were destroyed by fire of which we thought we found evidences. She thought not. They were still standing when she last knew (when she went west) and were therefore standing when the Parry Peninsula ceased to be populated. It seems the parting of the chain of population along the coast took place about Langton Bay — all east of that went east, west of that west, and the Langton Bay population itself divided, some going east, some west.

Beliefs. A man, Pallañaxlurak, a Napāktogmiut, told in Ilav.'s hearing that a "fire" once found him one forenoon when he was far from houses and pursued him all day till near dark when he got home and escaped into a

house. A "fire" (ignirk) is a "falling star" or meteor. They are considered living things and some at least are aňatkut on a spirit flight. They pursue people who are not protected by the proper charms.

*January 18.* Pottery. Kutukak told Ilav. last summer pottery was made in his time. Grass was mixed with the clay, as well as sand or crushed rock.

"Pains." Analogous to the "pains" of the Indians are sokotak. They enter the body and cause sickness. Our people have heard about them often but never heard them described, so they don't know what they are like. "Innum sokotaktlugu anniakitā" was frequently heard at Kittgaryuit so it is to be inferred they were either made magically and sent to make people sick, or that they were already in existence and the aňatkok merely gained power over them and then sent them. Shamans drove them out of sick men and thus cured them. "Sokerktok," he is sick on account of having a sokotak. This method of making people sick may be called the converse of the other one of stealing a man's soul (nappan). If a man fell and hurt himself or suffered some accident, his illness was not due to a sokotak, also wounds, frost bites, etc. Most other things were magically originated illnesses.

A Fake Shamanistic Performance. At Point Hope were several club houses; three in recent years, four was the number before. They are Karmaktok, Uňasiksikat, Kaňilirkpait. The men of Karmaktok were especially given to shamanism. When they were performing in the evening, men who wanted to go out used to see a frightful tupilak (meaning of word unknown to Ilav., not used by his people) in the hallway and fled back to the interior. A young man from curiosity hid himself on a platform cache and watched. Shortly after the performance began a man came out of an isolated house near Karmaktok and went in. Towards morning only he came out of the clubhouse and went home. This may be repeated three nights. On the third night the watcher peeped into the hallway and saw the man whom he had been watching squatted in the half-lit hallway. Next day the young man told. It came out the tupilak had been a man dressed in a birdskin coat, wearing a wooden mask and with hands stained red with ocher. No one's faith in shamanism was impaired by this incident.

Aňatkut Beliefs. Both at Kittgaryuit and Kotzebue certain dogs are aňatkut. They do not fly or perform many of the shamanistic tricks, but they drive away spirits just as human aňatkut do. Like humans, dogs differ greatly in their aňatkut powers. Almost any dog can be made an aňatkok by feeding him certain charms (aňroat) and by performing certain spells over him when a pup. He will then have special powers of seeing spirits and frightening them away and will protect his master and his house



from them. Whenever a dog barks "at the air" or howls, it is that he sees spirits.

*January 19.* Beliefs. At Kittegaryuit male children were prevented from walking on the house floor in their stocking feet or barefooted in the morning just after they got up. Some mothers only took care to have their boots well on, but others, even after the boots were on would carry them from the bed platform and set them down through the trap door into the alleyway, so the first thing their feet touched was the alleyway floor. After they had once been out of the house, they might the rest of the day walk about the floor barefooted or any other way they pleased. This custom is unknown at Kotzbue except that male children were carried or sent out of doors the first thing in the morning. They were often undressed all day. At Kittegaryuit the prohibition against walking on the floor without boots did not apply, the child was carried out-of-doors first, whether naked or half clad. At Kotzbue taking children outdoors early prevented laziness in later life and made them good food providers. Mam. does not know the reason or penalties at Kittegaryuit. Children were also prevented from drinking the water of the first spring thaws. This prohibition lasted for several days. The reason and penalty are unknown to Mam. and to Kotzbue.

*January 23.* Añatkut Beliefs. I asked Ilav. about the occurrence of the belief that persons can see through solid walls. I have always understood that in Iceland this meant that the walls or hills were transparent. The belief in the transparency of opaque objects seems wanting everywhere between Parry and the Yukon; añatkut only can see through walls and that is because the walls lift up, so they really don't see through the walls, but under them. Añatkut without sending their spirit or body off on a spirit flight can see things at any distance and whether present, past, or future. Sometimes they have this far sight in simple ecstasy, in others they employ certain paraphernalia. The common method in Alaska, so far as Ilav. knows was to take the drum baton and bore with it a hole in the floor equal to rather more than half the length of the baton. Looking down into this, the añatkok could see distant places in a bird's eye view, as if they were only a little way below him. He could thus see past and future things. Cf. Prince Albert Sound belief as shown by their taking my field glasses as an appliance for seeing caribou that would come tomorrow; they too asked me to turn them on the village to see inside which house our primus stove "needle" was hidden. These far sight beliefs were the same at Kittegaryuit so far as Mam. knows. They were experts there, Ilav. tells, in recent years in detecting small hidden articles. His stories mostly concern whisky. In one case a man with a small bottle hidden inside his coat came into a house where Ovayuak and Alualuk were dancing, a semi-conjuring event,

and no sooner had he entered than Alualuk proposed a treat to himself and Ovayuak "from the bottle which I see hidden inside your coat." Another story concerns Ilav.'s buying eight bottles when no one but himself and the whaling captain were there, he went home and saw no one on the way, put six bottles where they could be seen and two he hid. Then he invited others in and they drank up the six bottles. When they were emptied, Alualuk told him to bring out the other two "which you have hidden in that box."

*February 3.* Beliefs. If the first person who goes out of a morning comes back in with the report of "fine weather" (*sīla ā'si*) someone in the house should say: *tatkáni* (out there, outdoors). This will have the effect of keeping the weather good for that day. Another expression almost as effective may replace "*tatkáni*," — "*akana taima*." If there is a folk-tale behind this, it is at least not known to Mamayauk.

*February 7.* Vegetable Foods. All Eskimo known to me eat contents of stomachs and intestines of hares, rabbits, squirrels, ptarmigan, and stomachs of caribou. Sheep stomachs are eaten only in time of scarcity, as "they do not taste good." Berries, etc., found in black bear stomachs were eaten by Kotzebue people. Ilavinirk never knew of the roots from an *aktlak* stomach being eaten.

*Women's Hair.* Women's hair was never braided at Kittegaryuit. The hair of the top of the head, of an area corresponding to the men's tonsure, was done up in a "top knot" by folding it in about four inch lengths and binding the folded hair with a "ribbon" about half an inch wide made of strips of the legskin of white foxes without claws. These ribbons were seldom over eighteen inches long. To keep these ribbons from breaking, strips of caribou skin were sewed along the edges to double them. The top knot in some cases stood erect, in others it lolled over. All the hair not included in the top knot was divided by a parting down the front and back heads, was gathered as if for two braids, but was not braided. It was folded in six to eight inch folds, beginning at the tips of the hair and folding till the lower end of the hair was about even with the fifth rib. The hair was then tied with a band of beads into the bundles shown in many photographs. Many women, most, in fact, had false hair to augment the size of these bundles. Some had almost or quite as much false hair as would grow on a single female head naturally. As elsewhere noted, these sets of false hair were very expensive, in some cases equal to a new *umiak* in price. No one seems to know where this false hair came from. It is denied that it was clipped off the dead, and no one cut off hair to sell. Combing were kept and this may have been the source. In some cases at least the false hair was buried with the bodies of the dead (cf. my finds at Flander's Point).

Beliefs. Ki-ki, patīriaksinasuarin patirluñnik pati<sup>l</sup>katarlutin — so that your bones may pain you, go on and keep eating poor marrow. i. e., children (Kittgaryuit) were told to keep from eating marrow of animals not fat, as doing so would predispose them to pain in the bones (in the marrow of the bones).

*February 11.* Scalplocks. Boys were tonsured “so soon as they had hair enough” — e. g., at from two to three years of age. Some boys had a scalplock in the center of the tonsure, the roots of which occupied a circle about one fourth to one third inch in diameter. This scalplock was never discontinued, Mam. thinks, by those who once had it. She has seen old men with one. The lock was always braided, but never bore any ornaments and the end of the braid was tied with hairs belonging to the lock itself. Whether the lock had the nature of an anñroak or talisman Mam. does not know. One of those who had it was “little” Añusinnaauk (the one who has a Mamayauk for a wife — Mamayukpaluk); he did not discard it until recently he adopted the close cropped “white men’s” hair cut. The close crop is also an Alaskan Eskimo custom.

*February 12.* Mam. says that the old Kittgaryuit women used to tell her that when they boiled pounded caribou bones for grease, they found they always got less fat off the first potful than from the succeeding ones. M. says she did not use to believe this, but she has found it by experience to be true. This certainly seemed to work out today, there being more tallow from the second and third pots than from the first.

*February 14.* Blindness. Since about twenty years ago there has been but one case of blindness among the Kittgaryuit, an old woman named Pannimiranna. She became blind when old.

Ground Caches. Kiñni<sup>k</sup> kiñnak, kiñnerit. These were shallow pits in the ground used for white whale meat blubber and fish. They were covered with logs; if they contained white fish, there was put on top the logs a layer of straw to prevent earth falling in and over that two or three inches of earth.

*February 15.* En route to Langton Bay. Snowshoes. Snowshoes without any toe or heel (nulluksrak, babiche webbing) merely the frame and the thongs under the feet, were used by Kotzebue and other western tribes in spring during the period when the thaws crusted the snow. Otherwise fully webbed ones were used.

*February 16.* Food. Marrow (Ilav. says) was not eaten directly to any great extent by Nogatarmuit. The bones were pounded and boiled, the marrow was then mixed with the tallow. This sort of mess would get high in summer. This high taste some liked and some did not. Among Copper Eskimo it is considered a great delicacy when high.

Names. Names from vegetable kingdom: masu (a woman of mixed Oturkok, Napaktormiut and other blood) now at Cape Smythe; Napaktogluñnak (an old man now dead, Kuwûgmiut); Napaktulik (a woman, Selawik mother, Kañhirmiut father) named so from being born at a river called Napaktulik, a branch of the Silawik; Kuarak (Kuñmiut of mouth of Kuwûk, a woman perhaps now dead, but lived there twenty years ago); Asiak, wife of Putulerayak (Napaktormiut?); Akpek, several Alaskan tribes (Akpialuk, a big akpek; akpialurak, small akpek among Kuvûgmiut); Okpek, several tribes; a<sup>1</sup>kpeksrak (a young unripe akpek, Kûwûk), two men so called, Akpeksragruk, big Akpeksrak; Akpeksaurak, small akp.; Pauñraurak, an Oturk. woman, died at Cape Smythe; Kêruk, a woman who was at Nirlik, 1909, spring; and a man, Kugrugmiut father (Kotzebue Sound River) who is now at Mackenzie; Tivragluk, a Point Hope man; Oyarak, most Alaskan tribes.

Names from personal characters: Papkilak (a Kigirtarrumiut) called Piñerksak because when he first became familiar with iron he was so fond of hardening in fire any scrap of iron he found (from piñerksak, a hardened piece of iron; piñerksara — he hardens it.) Nïo<sup>r</sup>ksik called Oniyak because he in anger broke a sled belonging to another man (O. is Kañianermiut) now at Mackenzie. Siakuk called Napuīyak, because he stole the stanchions (napu') of the sled broken by Oniyak (Kañianermiut? Now at Mackenzie — an old man — father of Añasak). Nirlirk (?) called Kannoyak because he was fond of hammering ornaments for the shoulders of his coat out of copper and brass articles bought from whites (Kigirtarrimiut, long dead). Aiakerurak, called Kanaurak (logical reason not clear, meaning of Aiaki, not known) by Aiaki "because he was small" (Kanaruak, slope in a mountain that leads from one terrace to another on its slope, if the difference in level of the two terraces is small. If difference is great slope is called Kanirkpûk). Aiaki called Kanirkpûk by Aiakerrurak in revenge. First of these men at Flaxman, second in Mackenzie. Kapkanna, called Taktorotaiyak because he stole the kidneys and kidney tallow of a caribou shot by someone else and not skinned. He got kidneys by making a hole in the body near the rectum and thrusting his hand in. (The Kapkauna who was at Stokes Pt. in 1906-7. He is even now usually called Kapkauna). This sort of name is said to be wanting among Mackenzie people.

Names from vegetable kingdom are rare at Mackenzie. Gavlaluk (Man) a black berry larger than pauñrak grows on grass stem. Kittegaryumiut, dead over twenty years ago. Oyarak (stone) and all such names are wanting. There are dogs called Kuõarak at Baillie Island.

Names from birthplaces are rather common in many parts of Alaska. Auksarkerk, from a mountain near the Nogatak — a Noag. man whose

given name was *Kuiñirk* (Tartar pipe); *Errisiak*, a mountain (errirk, Kotzebue dialect, or errirk) his given name was forgotten, at least *Ilav.* never knew it — *Kigirktarrugmiut* — lives there now? *Kimik* from name of the end of a ridge cut by the *Nogatak* one day's sail from its mouth, a woman, a *Kigirktarrumiut*, though born on *Nogatak*. *Itkiliañnak*, called *Sarliak*, the mouth of a creek into *Kotzebue Sound*, *Ilav.*'s brother. Called *Sarliak* even now though real name is remembered and occasionally used. This sort of name seems unknown at *Mackenzie*.

*February 19.* *Taboos at Kotzebue Sound.* Those who ate *aktlak* at all would never bring in the meat through the door, but always lower it through the window of the house; in summer it might be brought in through the door. As a matter of fact it was brought into tents only in very rainy weather. Most of the *Kotzebue Sound* people would not eat from dishes or pots that had been used for bear meat. Those who did kill bears were *aglernaåtok* in different degree. Most of them would never bring the meat near the house; they made a cache, several hundred yards away; when they got home they took their old clothes off at once (indoors, though). Most of those who killed bears i. e., those *Kotzebue Sound* people who hunted inland at all for caribou or bear would go to the white whale station of the *Nogatarmiut* in summer (a long point with a narrow neck-point called *sisualik*). The bearskins and all guns, clothes, etc., that had been used with bears were cached on the opposite side of the point from the whaling station. None must be brought near the whaling ground at any time. When the whaling was over and people moved off, the skins, etc. were carried along. Bearskins were used for tent doors; when first used a cross of red paint (*ivisak*, burnt rock ground on a flat stone in water) was made on it, the strokes the full length and width of the hide.

Women were under taboos of *aktlak* much as *Killirmiut* of mountain sheep. They were forbidden that part of the pelvis around the tail, about half the ribs (the rear ones), the front end of the sternum, the meat of the backbone that faces into the body cavity; the meat of the inside of any ribs, any part of the head or the paws, etc. The man who killed the bear was not under special taboos other than that he must not grind or file iron, at least, *Ilav.* was put under no other taboo when he killed a bear. Some women may have been under taboo against the things inside the body cavity, but *Ilav.* knows his mother used to eat of the intestinal fat. Liver was always roasted. A boat which had been used one year ago to carry an undried bearskin was not used for whaling or brought to the whaling station. If the skin had been dried it might be used.

At *Kittetaryuit* a person who killed a bear was under the same taboos

as one who had lost a relative. All the insides were thrown away. Women ate the same parts as men, except those under special taboos. In Kotzebue and Alaska generally no woman from her first menstruation till after the birth of her second child must taste bear at all, nor must sucking children taste bear if their mother must not taste it.

*February 23.* Langton Bay. Baillie Islands. The following miscellany was gathered from Aliñnak today. Baillie Island people when they went so far out that the Smoky Mountains were on or below the horizon used to see what they thought might be land to seaward (Banks Island). Al. does not know if they knew anything about this land from hearsay.

All copper and lamps came from east, but they made pots of clay. Al. thinks there were no stone pots in use. Copper was used for "anything one wanted to make" but chiefly for points of arrows and spears, for crooked and other knives, ulus, etc.

Sealing in winter was in his father's time done by eastern methods, dog to smell out hole, etc.

A white man interpreter who was with ships that came (M'Clure) spoke like "the people to the east from whom we bought lamps" and must have learnt from them. He came from Labrador. The boats that came earlier (Richardson) had an Indian interpreter who knew some Eskimo (a mistake, he was a Hudson's Bay Eskimo). At that time "we did not understand about a whale party having a single master," but the old people used to say that the white man who seemed most inquisitive and talkative was named Nasilik (Richardson, cf. Copper Eskimo name for him, Nasinna).

Few white whales were killed. No systematic hunt for them. Skins for umiaks were brought from Kittegaryuit in winter. Ugrug never used for soles, always for lines. Bearskins were eaten. They were boiled after hair had been shaved off frozen skin with sharp knife or ulu. Sealskin was similarly treated and eaten, a quarter inch of blubber on it. Children sometimes were given raw pieces of such skin to chew. They were not generally eaten raw (cf. Cape Bexley custom).

Games. Nugluktaktut was played at Baillie especially by children but also by men and women, chiefly during the dark days "for men had little spare time later."

*February 24.* Presented me by Guninana, a slate fish hook sinker (okumailutak). The stone of which it is made is called errisñnak. Similar ones were in use in recent times, but this is an old specimen. It and two others were picked up in the tidewash of a cutbank where house ruins were caving into the sea at Korok, about half way between Baillie Island and Horton River. The hook tied to it was of the type of the specimens collected and made of horn or caribou marrow bone, the hook in many cases of

copper as late as twenty-five years ago at least (Guninana saw many). The whole was covered with a fish stomach or fish skin; these big hooks were chiefly used in lakes for Titalirk, sñāyoriak and kaluakpūk (-pāk). Length of specimen a trifle over 3.7 inches; such stones picked up at various places on sea beach.

*February 25.* Relations with Indians. Guninana tells that her father was Apsimirk whose father Īyanna had two tattoo lines (tumnerit, pl. only) on each side of his face. These ran from near the top of his nose just back of the alae to a point a little front of and below the ear. This was because he was an Indian killer, but G. does not know if he killed more than one, she thinks two for the lines were probably 'awarded' on the same basis as whaling lines, one for each whale killed. This killing was on the Anderson (McFarlane) River; G. also knows of the killing told of by Roxy and recorded by me (about as G. tells it) in 1906.

A woman named Arna-pluk (Arna-pluk -sic) the younger sister of Panigyuk (the old woman still living who was about fourteen in 1846 when Richardson passed) was carried off by Indians, violently, G. thinks. They heard she had become the second wife of a powerful Indian chief.

A young girl named Atañana was sold to some Indians by her dead mother's brother Karrayaluk for a new rifle. She was about six or eight years old at the time. It was said the buying was by the orders and for a white man at "the big houses" (Fort Good Hope). It is said that Mrs. McDonald of McPherson told later that this girl had been married to a white man "umialik" and had been taken by him far away.

Fish Nets. Fish nets of whale bone were in use (chiefly for kaktat) as late as about twenty years ago in some number at Nuvorak and Av-ak.

Nuvorak was the only "permanent" settlement about twenty years ago between the Delta and on Baillie Islands. People did not begin to live at Utkaluk until after ships commenced wintering at Baillie Island.

*February 27.* Names. Macfarlane was known by two names at Baillie and Nuvurak (Pt. Atkinson). The one that was most favored and which has now become the only one used is Misipalla. On one of his trips Macfarlane was accompanied back to the Fort by two Baillie Island men. One was Mamayak who died probably at Kittegaryuit in the last epidemic about eight years ago, the other may have been So'ka-luk, dead some twenty-five or thirty years ago. Mamayak always spoke of Misimikpala. This was considered by others to be a wrong pronunciation and was not followed. Nuvurak was inhabited permanently until the epidemic referred to (Guninana).

Names of Arrows. Kigujvak was a blunt-headed bird arrow (ptarmigan) with longitudinal grooves on the head which gave the arrow its name, i. e.,

the grooves resembled the tooth marks on crimped boot soles. Kigujvak kātālik (ka-ta-lik) was a kīgu-jvak the head of which had a socket for the arrow-shaft. Natkulik was a barbed arrow with bone or (usually) antler point; savilik was one with an iron point. Kīguivak agleralik was one the back of the head of which was split for the reception of the wedge-like end of the shaft. This sort of joint was wound with sinew, the Kata-lik was merely glued with blood, bird blood usually used. Arnañoalik was another sort of arrow — sort unknown (Guninana).

Cement was used in recent years for mending iron pots (holes and partial cracks); formerly it no doubt had analogous uses. The ingredients were bird blood, often ptarmigan or goose; any sort of liver, often seal or caribou; and ashes. The liver was generally used fresh; it was crushed by squeezing in the hands. The mixture was made thick by stirring and squeezing with the hand. The pot was dried by a slow fire till the cement was hard. This cement endured boiling well, was suitable for cooking pots. The same may have been used for wood, such as arrow-heads, wood and bone, wood and stone, etc., the informant thinks so, but does not know (Guninana).

*February 28.* Whaling. As late as twenty-five years ago, the people of Nuvurak used to go out in boats looking for bowhead whales, but they never got any since Guninana remembers, she is thirty or a little over. There was no systematic white whaling except at Kittegaryuit.

Net Taboos (Seal). At Nuvurak and Baillie seal nets like those described by Murdoch (Bureau report, p. 251) were used. They were set at seal holes and in tide cracks (iptinirk, if along shore; ayora<sup>r</sup>k, if at a distance from land and over, say a foot wide). Cracks less than a foot wide, frost cracks, are Ku<sup>r</sup>park. These were always, in Guninana's memory at least, of braided sinew, usually caribou, sometimes beluga. During the dark days was the most important netting time as the nets could then be down at all times; before the sun went and after it returned the nets were down only when there was little or no moonlight. There were a few sealing taboos for harpooned seal, but nothing like so many as for the netted. While netting was going on children too young to do useful things (nutar<sup>r</sup>kat, under seven or eight years) were forbidden to play on the floor; they might however play on the bed, iglirk, or outdoors. Children must not let any part of their lower extremities stick out or hang down over the edge of the bed. If the toes of one foot only stuck out over the floor some person would speak sharply to the child saying, si.tkoarnak, don't let your legs dangle. (sitkoak, knee cap). No pounding noise must be made and nothing heavy must be let drop within doors only; if some one dropped something on the floor, one present would say: añnirksak opgaktok aglum kola ni, a cake of old ice topples over (into water with a noise) above the



seal hole. In summer when ice topples into water with the noise at a distance so easily mistaken for that of a gun, the expression is: ãnirksak-palaktok. If an article fell on the sleeping skins and did not make a noise it was not a seriously offensive happening; it was the noise (Gun. says) that mattered. When a man netted a seal he was given a drink of water (as described below). If the meat was given out to several houses, which was usually the case according to the custom described elsewhere, nerkaitok-tuat for seal; pillag̃aktuat for beluga. Said of women of other families who come to successful hunter's houses or cutting-up place for a hand-out. Those who got it carefully saved all bones and returned them to the woman who had cut up the seal, usually the hunter's wife or the mother or other woman who took her rank in an unmarried man's house. When all bones had been returned they were carried loose on a platter and poured down through a tide crack. Gun. does not know of any formula accompanying this act, nor did she ever hear it said for what purpose this was done. "It was always done; that was the way it ought to be done. The old people may have known why. I never knew anyone to ask." The nose and bladder were treated as described below. The heads too were boiled as related below and meat was kept apart from caribou in general way.

General Sealing Customs. It was said that no animals (sea mammals) would allow themselves to be caught by man were it not for their thirst; they had no fresh water to drink where they lived in the sea. For this reason a seal was given water when brought into the house. Beluga and balaena were given water on being brought to shore. It is generally the wife who gives the seal water. She opens its mouth with her hands, takes water from the pail in the palm of one hand and lets it drip off her puckered finger tips into its mouth so that it runs down into its throat. As she does this she says: Īmeriaktoraktlutin, imirkkinuilluaktok, gilū, so that you may continually keep getting water to drink, come again; water is not a thing grudged you (you will not find need to beg for the water you get). The soul (ta-t-kok) of a seal thus treated will be grateful and when it has again become a seal it will allow itself to be caught by the same man, partly through gratitude, partly because it knows that at his house it is sure of a drink of fresh water. The water may be of any source, at Nuvurak it was generally either snow water or water made of an old sea ice cake.

No matter in what way killed, the seal's nose skin and bladder were saved. The bladder was inflated and hung up in the house with the nose skin attached to the same string; strings used were nearly always caribou sinew. If the seal was speared through ice (Kuna-<sup>r</sup>ktak) the bladder and nose hung to dry till all at the village had ceased catching seal in that manner (mauksoktok) for the year; then they were put down in the water through

a tide crack usually, but in some cases they were merely "thrown away" (igittut). This was done by the hunter's wife; Gun. does not know that there was any formula or set way of procedure. She thinks the bladders were pierced or the air let out in some way. If the seal was netted, kuyaktak, or harpooned from a kaiyak, aktligak, or speared on the ice, uktaktak (u'taktak in rapid speech), the bladder and nose were "thrown away" when the season for that sort of sealing was over (uktaktak also known as pamñoliaktak, pamñoktuak, he [a man] crawls, or auktak [autak]). Cf. auktok, he hunts seals by crawling up to them; cf. aukga, it melts, runs as snow, tallow, etc.

**Naming Nets.** When a net was first set for seal (not so for fish) the net was given a name which it bore thence till it was worn out. The name given was that of a dead man who had been a great seal hunter, or a successful hunter in general. They were usually the names of persons long dead; whether naming a child for the dead spoiled his name as one for a net G. does not know. Often the names were from "unipgat" or folk tales which to the Eskimo mind are literally history and to a degree sacred. Kilikiusi<sup>11</sup> was a favorite name for a net. All nets (fish or seal) had charms attached. Fish nets had no names. A favorite charm for seal nets was any sand or pebbles found attached to the body of any sea animal found stranded, whether self-dead or dead from wounds inflicted by an unknown person. These were placed in a bag tied to the seal net.

Gun. has heard that the Herschel Island people (tuyor'miat) i. e., those beyond the Mackenzie, used to burn the bones of seals to prevent dogs getting them. She thinks this applied only to netted seals, but does not know. Found charred seal bones at House Point, east of Pt. Pierce. No matter how seals were caught the heads when being boiled must have the foramen magnum towards the bottom of the pot. Was this with the same idea as facing drying beluga skins landwards so live ones would come to land: face seal's head up, and seals will rise to surface? Gun. never heard any reason given except the general one that the seals' ta-tkoit would become angry if the heads were turned upside down.

Netting for seals was carried on in spring only at the Iglualuit on the western edge of the Horton Delta. This was because water there was muddy. The nets were set in the widening tide cracks. The people as far east as Langton Bay used to get their next year's blubber here. When this sort of sealing was over the bladders and noses of seals caught in this way were put in the water, as described above. All netting customs and taboos applied.

**Seal Netting Taboos.** If there was meat of a netted seal in the house or if the people of the house have nets out for seal, there must be this pre-

caution observed in bringing any "high," or strong smelling meat into the house, e. g., summer killed beluga: the "high" meat must be so carried that a chamber pot can be and is held underneath it as one brings it in — held as if to catch drippings though there are none.

**Other Sea Animal Taboos.** Deerskins must not be sewed while there is in the house a seal not yet dismembered. The taboo is removed as soon as the seal is cut up. No new deerskins are sewn during the beluga or bowhead hunt, but old clothes may be mended and new sealskin ones made. "On account of the season falling when there was no need of very warm clothing, there were not the subterfuges reported to at Barrow, e. g., going inland to sew. New sealskin clothes were not made while deerskins were being worked. There must be no loud pounding during the beluga or bowhead season, and a man who went out sealing habitually would avoid doing much pounding, though he would do a little if he could get no one to do it for him. When compelled to do some taboo thing there may have been charms to counteract the effect. Guminana does not know.

**Caribou Taboos.** When caribou were being speared at swimming places any bones might be broken for marrow except the lowest marrow bone of the front leg (ayigaun or ajigaun). These must not be broken until the deer spearing was over for the season. No bones were hammered or boiled to extract the bone fat until this practice was learned from the Western Eskimo after the ships came. Any amount of hammering might be done when caribou were being hunted.

**Bear Taboos.** When a bear was killed its skin was hung up by the nose from the window casement. It was suspended usually by a white whale skin line, often the harpoon line. A few inches above the bear's nose between it and the casement was hung a bowdrill complete if the bear was a male, if a female there was suspended a needle case with needles (oyammak; dual oyammñit or -git). If a male the tatkok stays around the house one sleep. When it has been in the house about twenty-four hours, the wife of hunter removes the bowdrill, and using it as a hammer, she beats once around the walls of the house from the door to the door again. In her left hand she holds a cup of water. When she reaches the door the bear's spirit goes down into the passageway. The cup of water is then poured down the door hole and a certain formula pronounced (unknown to G.). The beating of the wall must proceed in the direction of the sun's motion in the sky. If the bear is female, the skin and the bear's soul remain in the house four days. The needle case hung above the bear's nose as in the preceding case when four days are completed is used as a club for beating the walls of the house. All proceedings as above. While the spirits are in the house, no loud pounding must be done, otherwise there are no taboos known to Gun.

The drill and needle case and needles become the property of the bears, i. e., the tatkok of the bear carries with it the tatkok of the neokton or oyammak. This will be his property and used not only while he is a mere ghost (tatkok) but also after he becomes a real bear. On being questioned Guminana says she always heard that the tatkok became a bear, but she never heard details; she supposes that it starts its new life by being a cub bear, but she does not know if it needs to be reborn from a female bear. This would, of course, be the analogy from what is known from Greenland, etc.

*March 1.* Red Ocher. Used for coloring the flesh side of wolverine skins, both now and formerly, was procured among other places, at the Smoking Mountains of Franklin Bay. Red coloring was also made of the ashes of certain sorts of driftwood, willows, cottonwood or spruce indifferently, it is said. Whether ocher or ashes, the coloring is mixed with water and rubbed on the flesh side of the skin generally with a swab of long-haired deerskin. The flesh side of no skin but wolverine was so colored, but certain articles of woodwork were colored. Arrows colored red were considered more effective weapons than uncolored ones.

*Coats.* Wolverine at the Mackenzie and Baillie was used chiefly by the men. Women's coats had wolverine around the bottom and around the sleeves at the wrist and sometimes wolverine pendants down the front of the coat; a fringe of wolf was used over the hoods in the manner shown in Stone's photographs (Museum Bull. Vol. XIV, 53-68). Men's coats had wolverine hood trimmings in the western manner and ornaments on the pants as shown in Murdoch's illustrations of breeches which he seems to think are Barrow made, but which were bought at the Mackenzie? There were also shoulder ornaments of wolverine on coats, and pendants, chiefly the heads and neck skins of loons (tulik), ravens and gulls and the skin of weasels.

*March 3.* Childbirth. The "vapor" (puyora) of a new-born child is likely to make people sick. For that reason immediately after the delivery of the child a hole is pierced in the window to let out the "vapor," a ceremonial act, for the hole is usually very small and the open ventilator of the house carries off far more warm air than this hole does. Some people are not afraid of the "vapors" of a childbirth provided the windows are pierced promptly; others will go outdoors and not come in till the child is delivered. There is no belief to the effect that these "vapors" make a hunter unsuccessful, they merely may cause illness.

When a woman is with child, she must keep all her food utensils very clean, else her child will be filthy, lousy, and prone to slovenly habits; she must not be lazy, for if she is, the child delivery will be slow and difficult.

For this reason she is especially instructed to run out-of-doors when visitors come or when sounds or other signs indicate that someone out-doors needs assistance, in hitching or unhitching dogs or for any other work (Mam. and Guninana).

Alaskan Eskimo generally, e. g., Nogatarmiut, believe that if a woman has difficult labor it is because she has had sexual relations with someone and failed to tell about it. For that reason a woman in labor will rehearse all her relations with men from her youth up, but especially any that have occurred during pregnancy. This custom was unknown at the Mackenzie so far as Gun. and Mam. know till after the ships began bringing western women. In general, among the Mackenzie Eskimo there was about the same subterfuge and secrecy about "illicit" sexual relations that there is among Europeans. Women, after marriage, would often, however, tell such things to other married women; things that had happened before marriage chiefly. This was looked upon as a "confidence"; the story often went far, however; but the husband was never informed by anyone. In general men did not keep so much secrecy, though they were not supposed to tell, and many never did. As a matter of fact women were, however, much better informed of the acts of their husbands than these were of the infidelity of their wives (Gun. and Mam.)

Alaskan Eskimo considered it a duty of both parties to tell at once; otherwise serious misfortunes would follow. "Illicit" sexual relations were seldom, if ever, kept secret among them. Among the Copper Eskimo there is a semblance of secrecy in some cases; in March, 1911, off the mouth of the Kogluktualuk, Ivarlualuk in the presence of the women, her husband and many others rehearsed the pre-matrimonial adventure of Anaktak, wife of Niakoptak. Ameraun's (Akuliakattak) relations with Ko-mirk were an "open secret." A.'s husband was jealous and used to beat her, but showed no ill will to Ko-mirk.

Windows. At Nuvurak windows were usually made of the pericardium of caribou, if not made of ice.

Trade Relations. White whale skin for bootsoles and boat covers were bought by the Nuvaragmiut from the Kittegaryumiut, as well as tobacco, beads, and latterly matches and other "Fort" goods. They bought these with caribou skins (two fawn skins were equal to one white whale skin), sealskins of various kinds, and latterly fox skins. Wolverines were also occasionally bought from the Kittegaryuit.

Hunting. It was rare any Nuvurak people joined the Kittegaryuit for the summer beluga hunt. They went in winter to buy skins only. In summer, they devoted their main energies to the caribou hunt, chiefly to the east of Nuvurak as far as Innuksuit. There were many caribou, especially

on the islands between Nuvurak and the river that runs out of the Eskimo lakes for that was part of the hunting ground of the Inuktuyu-t formerly and later of the Kittegaryuit. Some who intended to winter on the Kuga-luk to hunt foxes, etc., also hunted caribou there. There were several caribou spearing places, yet much hunting was with bows. Meat was thrown away and only the skins taken, when animals were killed far from camp. Large quantities of dried meat were made; umiaks used to return deep loaded with dry meat, fat, and skins from the hunt in the fall. Seal oil was the main fat source in winter. Only those of the Kittegaryuit who neglected the white whale hunt, and they were few, got any considerable number of deer during the season of suitability for clothing; hence, their need to buy skins.

Trade. Siberian reindeer skins in small numbers came as far east as Baillie Island, at least, before the whaling ships first came. They were considered much more "stylish" than caribou because of their rarity and cost much more (Gunina-na). One of the women figured by Stone (Bull. XIV) wears a reindeer coat, as shown by the white on the sleeve. This may have been from the ships, though. It is probable these came via the Colville.

*March 4.* Taboos. At Kittegaryuit caribou meat must not be cooked in the kitchen (igak), but by a fire outdoors; at Nuvuarak caribou might be cooked in the kitchen, but the fire for it was built a trifle to one side from the fireplace used for seals; at both Kittegaryuit and Nuvuarak birds were cooked over a fire built a trifle one side of that used for other food. Fish and seal cooked over fire built in same place.

*March 5.* Beliefs. As a commentary on the fragment of a story of Mûkta-luk (according to Mam.'s first version) or Mûkta-lum añuta (as Gun. and Mam. both have it now), Gunina-na says: When Mûktal-um añuta-eavesdropped on the women, what he heard one of them say was: "Mukta-lu-m añutâuññittok Igugaun." Why he should get angry at being named Igugaun appears from the following. When a man wants to make another sick or to kill him he makes a small hole into any article or implement which his victim will handle; into this hole he inserts a so'kotak or so'kotak. (Analogous to the Indian "pain.") This act is called igugara and the so'kotak so inserted is igugaun (from analogy to a bee and its sting, bee: igu'sak; the bee stings it; iguga. No other fly sting is so referred to; the poison inserted by a bee is not igugaun, however; only a so'kotak inserted by a man; most men, but not all, know how). Later, when the victim handles the article so treated, the so'kotak enters him. Calling a man Igugaun was, therefore, hinting that he was in the habit of making people sick by this method. It is said that in his anger M.'s father played this

identical trick on the woman who called him Īgugaun and she died that winter.

*March 6.* Beliefs. Few of the mysterious beings and processes in which the Eskimo believe are very clear or definite in their minds. Thus, though both Mam. and Gun. talk freely of ta·tkok, they cannot, when pressed give a coherent or consistent account of their attributes. Mam. tells (probably from Alaskan sources) that in the case of wolves and ar·lú (killer whale?) at least each has during lifetime its double, i. e., every wolf on land has a ta·tkok at sea that is an arlu. If the wolf has trouble in finding food on land he goes to sea and seeks his double, the arlu. Here Mam.'s knowledge becomes vague. This much she has heard, but she does not know if the wolf remains at sea as a wolf, if it merges with its double and they become one, or if it becomes an arlu so that there now are two arlus, the one that always was at sea and the other driven there by hunger. Guninana says the above must be information from western sources. She knows too that arlu are the ta·tkoks of wolves; she always supposed that it was only on the death of a wolf that its ta·tkok went to sea and became an arlú. Still "come to think of it" she has heard that arlu hunt caribou too, so evidently they are part of the time in wolf shape. She refers to her own story of the woman who lived with the arlu as the source of some of her information. She never heard of a wolf voluntarily going to sea to become an arlú because of hunger. She thinks that if an arlú were to die that would be the end of him, but she never heard of one dying. Both M. and G. have heard that bowhead whales are the tak·tkoit of musk-oxen.

*March 6.* Mam. says the name is the same thing as the nappan of some dead person, another name for the same thing. When a child is born it has a nappan of its own; when it gets one or more names the nappatait of those dead people come and "live with" the child. [Nor·asam ta·vyuma tokoyuam nappatan Nor·asakput na·iyuga, "soul" of that dead Nor·asak now lives by (near or in) our (daughter) Nor·asak]. The child gets as many "souls" to live with (or by) it as it gets names, but none of these are its soul properly speaking. The child's own nappata is the one it was born with. When the present Nor·asak shall die and her name shall pass on to a Nor·asak 3rd, the nappan that goes to that child will not be the nappan of N. but will be the nappan with which N. 2nd was born. Mam. and Gun. agree on this story. It is not of recent importation from the west. They have no idea what will become of the soul of N. 1st when N. 2nd dies, nor the other two souls (Nor·asak has three names) which now live with N. 2nd i. e., of the four souls of N. 2nd she now has only the one which "from always" (nutim) was hers. At her death this will be provided for by having a child named for it. They do not know what will become of it if no child

is named after it — “perhaps it gets lost.” Also it is not clear in the mind of either where the nappan goes in the case of several children being named for one dead man, as will happen if more than one child is born between two successive deaths. “Probably the nappan goes to the child first named” they guess. If a child is scolded, it is not only the baby that one scolds, but also the soul of the one whose name it bears; this will make the “name” (soul-nappan) angry and it will make the child sick or cause it to die. If habitually scolded, the soul or souls received by name (the child’s names) will (one, some or all of them) leave the child and go to a child that is not scolded. This will be to that child’s advantage, and will not much hurt the child that loses them. Yet to lose the soul thus seems to be considered a misfortune. But if the souls have no child to which they can flee, they will make the child sick through their discontent at having to stay in a child so badly treated. The only child a soul can go to for refuge, is one that also bears its name; i. e., a soul that has only one child named for it, has no refuge in case that child is badly treated. If two contemporaries bear the same name, let us call them  $A^1$  and  $a^1$ , and if at their death child  $A^2$  is named for  $A^1$  and child  $a^2$  for  $a^1$ , then, if child  $A^2$  be scolded the soul of  $A^1$  has no refuge; i. e., it can flee only to a child that has been named “for” it. In other words, if two children are named John after one John Smith, then the soul of either John can flee to the other in case of being scolded or badly treated, but it cannot flee to a child named John if that child was named so for a John Brown or for a John Smith other than the one in question. In Eskimo speech the “atka” of a child is the soul of the particular John after whom it was named: sometimes “atka” is used to refer to the person as opposed to “soul” for whom the child was named, or it may even refer to the corpse, as: “This is the grave of our son John’s atka.” This is what Kleinschmidt would call “caused by loose thinking.”

Beliefs. In a story which I have heard told by Gunina-na a woman becomes a seal. In connection with this she tells that if a woman who is sick should go to sleep while her husband is out sealing, especially if at breathing holes, her soul might leave, become a seal, and be speared by her husband. The moment the seal is speared the woman gives a quick motion in her sleep and for a moment sees a line before her eyes, a thong so placed that it is as if one end of it were fast to her breast or shoulder; i. e., the position of the taut harpoon line the moment after the seal is stabbed. This dream vision is momentary; the woman wakes with a start and does not know what woke her up. The dream is at once forgotten, but she feels uncomfortable and becomes sick; not necessarily in that part of the body corresponding to the harpoon wound of the seal, but in any part or organ at all. Usually, however, she has trouble in breathing. (All this told without



prompting. On being questioned G. says she does not feel any chills. Chills according to Tannaumirk are the infallible signs of the nappan's (soul's) absence.) When the seal is brought home and cut up, the woman dies "like the going-out of a lamp." If the seal is not cut up the day it is killed, the woman will die only when the day is over; i. e., she will die during the following night (Gunina-na).

Taboos. Mam. tells at Kittgaryuit during white whale hunts not only the wives of the hunters but also all those who were sick (except small children) should refrain from sleeping when the pursuit of the whales was in actual progress. If a sick person were asleep, some one who saw that a whale killing was imminent would wake the sleeper, saying: tu'pagin isak-siyait, tokoteriaksiyut: wake up, they are getting ready to strike them, they are about to kill them.

Origin of the Soul. Gunina-na has heard stories (unipgat) which relate that souls (nappan) enter women with the water they drink and from the ground when they urinate, but she does not think this was ever believed here to be the general rule. These stories were always taken by her as special incidents illustrating no general principle. She herself always thought the child's getting a soul was simultaneous with its birth. Mam. has always thought the soul came to the child during the pregnancy period sometime; how or when she does not know. Gun. says it was "always" said by her people that a woman would not become pregnant unless she had sexual relations with a man. Neither of them ever heard of shaman's magically causing pregnancy, a common story in Alaska.

Foot Lifting. Head lifting was not practised in the Mackenzie until recently westerners brought it in. Foot lifting and lifting a mitten took its place. No añatkut skill was required on the part of the performer in foot lifting: mitten lifting was practised generally when a person was alone and wanted to consult the powers. It was occasionally done in the presence of spectators. An affirmative answer was given by the leg or mitten becoming too heavy to lift. For foot lifting one end of a stick about two or two and a half feet long was tied by a woman's pants belt (tireksak) to the ankle of the foot to be lifted. If the one doing the lifting was a woman she used her own belt, if a man he used his wife's belt. The performer usually stripped to the waist, for he expected to tug hard trying to lift the foot. Only one end of the belt was used to tie the stick to the foot; the rest was wound in a spiral toward the loose end of the stick, being wound "towards" the one whose foot was to be lifted except in the cases cited below. The performer grasped the stick as one would a hay fork in trying to lift a heavy forkful. As in most añatkut performances, the questions are asked in an imperious or even an angry tone, the latter reproving or scolding the spirit

for not answering promptly or for answering in a way not desired, e. g., if he foretells any unpleasant event.

Occasionally, the foot is taken possession of by a spirit that is no proper "kēyugak" but a sokotak or by the nappan of a shaman ill-disposed towards the one whose foot is being lifted. This has come for no good purpose, i. e., to make the man sick, and will answer questions, but not truthfully. If the lifter suspects that the answers he is getting are not truthful he will blow his breath on the foot and say: *geayī, aullarin*, (or *Mani-nnak*: come, be off, don't remain here!). If the spirit is not one of the servants of men (*kēyugak*) he will leave and the foot becomes dispossessed; if he stays, it shows that the spirit is a genuine one and that the answers which the performer suspected of being false are really truthful. If it was a false spirit, a new spirit soon comes to take its place in the foot, a *kēyugak*, and the performer goes on. Sometimes no spirit at all will come to take possession of the foot or mitten. This shows nothing except that no *kēyugak* happens to be in the neighborhood.

Occasionally, a foot lifting performance is for a different purpose: to drive out of a house the spirit of a dead man; to get the spirit to go to the grave. It is a ceremony performed on the fifth day after a death, the day of death being counted as the first day. In Alaska it is on the fourth day for a man, fifth for a woman. When thus driven to a grave, the spirit stays there unless summoned to come to a child and be its name. It is said to be a very essential thing in this ceremony to wind the belt in a spiral *away* from the person whose foot is being lifted. Otherwise the spirit, instead of going to the grave, will stay in the house indefinitely.

What was said to be a typical foot lifting performance was given for my benefit by *Gunina-na* today. I did not copy the questions then, but the performance was repeated later for me to record, the only difference being that a mitten was used instead of a human foot. The end of a stick about two feet long was stuck into the mitten and grasped *hay fork* fashion. *Geata gīv agaittuña itkorluni unnirktuksamik!* *Geata gīvvagaksamaik aittuña, itkorluni unnirktuksamik!* (Come give me someone for me to lift, one who will tell the truth.) This is almost shouted imperiously, as if to someone at a distance. The mitten is lifted several times; then, after a pause: *inukpa* (is it occupied by the spirit). An attempt is then made to lift the mitten and it is found heavy. The answer is therefore, "Yes." *Kiñunñrin unneruñ a<sup>i</sup>n kiñunnatin kanok itpat*, or, more rarely *kiñunnatin unnikkit* (tell of the things you left behind you, won't you? i. e., tell about the place whence you came). Answer: No. (The mitten light).

*aktlamītauvi-t* (Are you an inhabitant of the air)?

*uluksami-n* (Do you come from the sea)? Yes.

unnerina<sup>1</sup>n (You will tell us things, won't you)? Yes. Implication; you won't fib, will you?

iliñnun (of yourself)? (If to a person the form would be iliñnik). No. uvamnun (of me)? (In common speech uvamnuk.) No.

uvva tuvirramun (of that man there omiña inuñmik, tuva<sup>2</sup>k is in daily use in the meaning only of companion, especially hunting companion). Yes.

kana, una anniarniakpa (is he going to be sick)? (Kana is in use as an exclamation, that's not the way at all! etc. Implies disapproval of the speech or conduct of the one addressed, e. g., if he tells untruths.) No.

amila (probable implication: You are naturally reluctant to tell, but the fact really is that he is going to be sick). No.

suyuak, suyuak unnerukpiñ (what about him do you want to tell? Answer: Yes i. e., there is something to be told).

kanaginikgan samma, anniaksarogiviñ, or anniallasinirkpaluka una (Do you think he is going to be sick. Cf. Kana above. For the ending-nikgan, cf. illvit pinikgan, it was you who did it. Samma is used here as among Copper Eskimo).

sivunikanun (of his future. In common speech either in-nik or in accusative case with transitive verb, sivuniksa). Yes.

suyuamun (of his being what, i. e., Do you want to tell something concerning him)? Yes.

suvluk tar miktogaksaitigun, tusa yaksaitigun (what he shall go and see, what he shall see in some distant place; tusa yaksaitigun koliarniakpit, would be correct every day idiom). Yes.

sumun-sumun (-sumik in every day speech, of what do you want to tell? This in especially angry tone. The questioner seems impatient that the answers do not give information more readily). Yes.

geata itkorlugu unneruñ, geata erkonak unneruñ (come, tell about it truthfully. itkorlugu would pass in daily speech, but is a rare word). Yes.

imma iyimiktulaita, imma takulaita (you want to tell of something he has not seen)? Yes.

iyimiktuyaksa takuyaksa (something he shall see). Yes.

suna-suna (something)? Yes.

upañniakpiñ (are you going to him)? Yes. (2).

geami, upaguñ (come, go to him). Yes.

añvillutin (shall I untie you)? No. (3)

naiyummitutin añvinnagu (though the spirit is spoken to, yet the meaning really is: shall the stick be unfastened from the leg or mitten)? No.

geayi upaguñ (come, go to him). Yes.

allauvit (are you another [kēyugok])? Yes. (4).

sivuliktin itkuktłuni unnirkpa (did the one before you tell the truth)? In common speech, sivullin erkonani okakpa). Yes.

illivilli unnirmiakpit (are you too going to tell things)? No.

namuñniakpit (where are you going — are you going somewhere)? Yes.

taumunñiakpit (are you going to a man)? No.

aktlamuñniakpit (are you going into the air)? Yes.

gi gi, aktlariksaktigutu (go on, give us good weather). Yes.

añivillutin (shall I untie you)? Yes.

iluarnermik (“may things be good,” or some such translation said in daily speech to have its equivalent in akana, excellent; bravo; an exclamation of approval and gladness. iluarnermik (cognate iluaktok, ilorriga) is said to be not addressed to the departing giv·agak but to be addressed to nothing in particular, as our exclamation: good luck).

Notes. (1) Giv·aga<sup>r</sup>k and kēyuga<sup>r</sup>k are names for the same sort of spirits. kēyuga<sup>r</sup>k is used by those carrying on regular shamanistic performances (oniñoyuak) by the aid of his own familiar spirits or spirit servants, as well as by others in referring to spirits so controlled. giv·aga<sup>r</sup>k is used by those who are doing foot or mitten-lifting. It seems to mean one who is to be lifted; from giv·aga, he lifts it with difficulty and not quite off the thing it rests on, as a man who lifts one end of a heavy log or one edge of a big flat stone; giviga; he lifts it up clear off what it rested on.

(2) The meaning is that the spirit will leave the foot or mitten and enter the body of the one concerning whose fortunes it has been telling. The one whom the spirit enters will not feel it enter nor notice its presence afterwards. Gun. says of the spirit that enters a man: Nallunaktokpa-luk, suittuatunittok it is a very difficult thing to notice; it is as if it were nothing.

(3) añivitga; he unties him; añivittok, he has been untied. añivillutin is the infinitive, second person suffix. The form does not indicate the subject, number, and person, therefore it may be translated with any subject e. g., I to untie you; he to untie you. “It to unfasten you” is a possible translation, the meaning then being that the untying of the stick from the foot or removing it from the mitten removes the magical bonds that hold the giv·aga<sup>r</sup>k to the foot, the stick or belt may then be considered the subject. This translation is favored by Gun. and Mam.’s understanding of the word, which they say: añivillugu, the stick to be untied; shall the stick be untied and the performance be ended? “He answers *no* because there is a second spirit waiting to take possession of the foot when the first is through.”

(4) Allauvi·t, the first giv·aga<sup>r</sup>k has entered the body of the man it was telling about, and another has taken possession of the mitten.

*March 7.* Cure of Disease. Certain persons of both sexes are endowed with the power of curing disease by blowing their breath on the sick person

or paining part of the body. This power is inborn, not acquired and is quite independent of añatkut powers or the possession of a kēyugak. Such a person is supillgoyok or anerillgoyok. One who has this gift discovers it by trying his breath some time on a sick person; if the person gets well, he knows the curative power is his; if the invalid fails to get better it is because the person who blew on him hasn't the power. Of course, after a man learns he has the power he may now and then fail to effect a cure through one of the myriad counteracting accidents and influences against which the shamans too must contend. A man does not need this power to blow away false spirits in foot lifting.

**The Giving of Names to Children.** A history of a typical name-giving will illustrate all in general. Mamayauk's daughter Norasak was born in a shelter tent in the presence of one woman who was a formal, not a blood relative. When she was born, and before anyone was told of the fact, Mamayauk said: "Panigiok, kait-kait-kain, Panigiok kait-kait-kain saunirksan taj-vata. Thus I called my mother's nappan to come to us and be my daughter's name.' A girl, Palaiyak's younger sister, three or four years old at this time, already bore Mam.'s mother's (Panigioks) name. When people were told of the child's birth, her father's stepmother came and said; "Norasak, kait-kait-kain saunirksan taj-vata. Thus she called the nappan of my husband's mother." Later that same day when the mother and child had been moved into the common dwelling tent Mam.'s husband's stepmother similarly summoned the nappan of Gúnnalik, the mother of Sanikpiak, Jimmy's second wife, to be the child's third name. All three names had previously been taken by other children. They were given to the present child so that if their first saunirks should be scolded, grugged, or denied what it asked for or cried for, or otherwise be badly treated the souls of the dead should have a refuge to flee to for better treatment.

**Name Securing Formula.** Norasa<sup>k</sup>, kait-kait-kain, norasa<sup>k</sup>, kait-kait-kain, saunirksan tajvata.

**Saunirk and Atka.** The atka of a person is the soul (nappan) of some dead person who has been summoned to a child to remain by it and be its companion, protector, or "guardian angel." The atka will, if the child be not scolded so as to offend the atka who takes to himself any words or acts towards the child, protect the child from illness, assist it, e. g., to learn to walk, will protect it from accidents, etc. The older the person gets the less the atka seems to help him, and people differ as to whether a boy's atka will help him in his first caribou hunt, i. e., the more able a child becomes to think or act for himself the less will the atka trouble about his welfare. The atka is sometimes in a child, sometimes near it, sometimes it goes quite away. When a child's atka gets farther from it than a fathom or so the child will

begin to cry and will not cease till the atka returns. Sometimes a shamanistic performance is resorted to, to get the atka to return. There seem to be no charms for this purpose which the mother or relatives can use; a shaman must always be called in. As the child attains age it becomes less and less unsafe to scold or reprimand it, for the atka gets less sensitive and less apt to take hard words, etc., as a personal affront.

Besides the above and other "practical" reasons for naming a child, there is also the further practical reason that a man whose father was A will consider the child A<sup>1</sup> as an embodiment of his father and will treat it accordingly, will make it gifts and do for it other things prompted by his filial feelings as well as by the dictates of custom. He will address the child as "father" instead of by such terms as "nephew," etc., used by other relatives.

There are too, reasons of love for the naming. A woman will name her daughter after her mother not only because she wants to provide for her mother's soul's welfare but because, as Mamayauk says, she wants "to have her mother near her because she is so fond of her." While the soul of a dead person is the child's atka, the child is that soul's saunñra. So far as the Mackenzie people are concerned there seems to have been no other idea of a pleasant abode for the soul. The character of this abode depended in no way on the dead person's merits in life, but only on the accident of how the child, his saunñra, was treated. It was a duty to relatives to provide them with saunirks. People of the Mackenzie, therefore named their children after relatives usually, but not always, of the sex of the child, and worried if there were no children to speedily provide the dead with homes pleasanter than their graves. Some persons had more prejudice than others against having the atka of a different sex from the child. Some would let their fathers go unprovided with saunirks rather than name a girl baby after them; but this was merely depriving the dead of one alternative refuge, as there was sure to be someone else's boy named for one's father. An añatkok was also saunirk to his familiar spirit; the spirit was his kēyuga<sup>r</sup>k.

The Soul. Mamayauk's story that the child is born with a soul which is its own, as opposed to the souls of others which merely live near the child, is partly discredited by the fact that when her daughter Norasak sneezes she (N.) says: "Uvaña kait-kait-kain" while M. while N. was small used to say when N. sneezed: "Norasak kait-kait-kain," i. e., she seems to have identified the name (atka) Norasak with her daughter. Questioning her on this point yields no result, for her thinking is very confused. It seems likely, too, that because she has always called her daughter Norasak, she has long ere now begun to think of this as we would, i. e., as the name for the entity which is her daughter. As noted elsewhere, she speaks to her daughter

habitually as "my mother" in which case she seems to identify her with Panigiok instead of Norasak.

Names. The name among the Mackenzie people while as yet little influenced by the westerners, was dropped by men and women at the birth of their first child as our women drop theirs at marriage. They would thereafter be known by the name of their eldest child, even after that child died, provided it had lived long enough to establish the impression of its individuality upon the community, according to M. and G., about ten years. If a child lived to be almost grown, its parents would be always called after it (A's father, A's mother) even though a child a year younger only were to survive it indefinitely. If an only child died before the age of eight or ten, the parents would cease being known as his father and his mother and would go back to their original names. The sex of the child was immaterial; the parents would be designated always by the name of a daughter who was a year older than their oldest son, no matter how prominent a man he became. This even held for twins; if a girl is born the earlier of the twins, her parents are known by her name if she lives, though her twin brother may stay with his parents and she be adopted even by people of another village. The names of some people were therefore completely unknown to a large part of the community in some cases where they attained great age. Mimirnak, the bearded man photographed by Stone in his report was known as Okgunam añota, from his eldest daughter. His next eldest child was Karli-k, also photographed by Stone, the one with two large labrets. He was the most prominent man in the Mackenzie community when Stone was there, yet Mimirnak was never referred to as Karli-k's, but always as Okguna<sup>r</sup>k's.

Mamayauk had lived near Mimirnak from birth until she had been married over two years, yet she never knew what his name was until after his death. A man or woman is never spoken of when dead as so-and-so's parent, but always by the name he or she used to be called by before the birth of their first child. The Kaviaragmiut and Kiñigmiut, and perhaps other Alaskans, had this same habit. The custom has grown into disuse the last twenty years under the combined influence of Alaskans and whites in the Mackenzie.

Names and terms of relationship are used in many parts of Alaska by all children in addressing any person at all. Among the Mackenzie people terms of relationship are used only for real relatives or for those whose relationship to the family is such as to make them seem like relatives. The people one addressed by terms of relationship are "ones to be ashamed before." A sister must never look her brother in the face squarely, to do so would be "a thing to be ashamed of" (kañ-onaktok); nor should she

do so with any male relative who is an adult. Some women do, however, and are said to be "shameless." It is a far greater offense to look a man in the eye, even though he be not a relative, than it would be to have illicit sexual relations with him; yet looking an unrelated man in the eye is less offensive than doing so with her own brother. A woman should not tell, even if asked, the name of any relative if that relative be present; nor the name of parent, brother, sister, or husband whether they be present or absent. She should look away modestly and appeal to a bystander to give the information. Such necessity arises only with whites, however; natives, Mackenzie Eskimo at least, would never make such enquiries, i. e., they would never ask "who is your husband" though they might stumble on forbidden things by such a question as "Who was the lame man I saw walking this morning?" Men have somewhat greater liberties in telling names of relatives, but they differ according to their "sense of modesty." Some will and some will not tell the names of their wives. A man will hospitably offer his wife for loan or exchange, but will be prevented by modesty from telling her name. It seems that the feeling is the same as that which we call modesty. No man should ask anyone the name of anyone present, but should wait till the subject of inquiry is out of sight and hearing. In general the "modesty" prohibitions on a woman are stronger with those relatives older than she than with those younger. Some women, without being ill thought of will speak of younger brothers by name. This applies really only to the rare cases where a woman has so many younger brothers that it would be difficult to differentiate them by terms of relationship.

*March 8.* Kēyugkat Dress. A man who had a familiar spirit in the shape of some human being, i. e., not a bear, etc., would dress like his spirit on all occasions when he summoned spirits and also usually when intending to go to the club house. Guninana has heard much talk of a Baillie Island man who died just before her memory, who had a kagmalik for a kēyugak. He wore a "swallow tail" coat in imitation of his spirit, an agoyalik (having a tail), as such a tail coat was called. These clothes were immediately taken off and put away at the end of a seance as soon as the Kēyugak had left. If the seance was in the clubhouse the clothes were donned and doffed there; the shaman would not walk home to his own house in his ceremonial dress. Those who wore the Inūrasuñat dress would not use a drum, but merely danced and sang songs consisting of words. They did not use the common form of wordless chants. All other aṅatkut, whatever their spirits were, always used in their seances both drums and wordless songs, but they also used songs with words now and then. Wordless songs, were prohibited to those who had Inūrasuñat spirits, at least they never used them, but songs with words were not prohibited other aṅatkut.



Kēyukgat do not differ in power according to the outer form they wear, but according to individuality. Not all bears (kīgutilik) are more powerful than eagles (tīnmisoktut). Some bears are more powerful than some eagles; some eagles are more powerful than some bears, but there is no information available as to which is more powerful, the mightiest eagle or the mightiest bear. There are no Master Spirits (atanūrat) among the Kēyukgat except that each group of Kēyukgat in relation to men, i. e., all the Kēyukgats that serve one añatkok has its master spirit. In one group of three Kēyukgats an eagle may be master of a stone and a bear, in another a stone may be master of a bear and eagle, in a third, a bear may be master of an eagle and a stone. If one añatkok has a group of spirits whose master (equivalent to the mate of ship whose captain is the añatkok, except that he is more insubordinate than mates usually are) is an Īptinirmiut and another has a group of spirits whose master is a bear, then it is not possible to tell in advance which is the more powerful spirit. A contest between the two añatkut would only determine whether this particular Īptinirmiut was stronger or weaker than this particular bear. Sometimes a man's chief kēyugak (the master) will get angry at the añatkok and not only refrain from coming when called, but also keep others of his spirits from coming. Occasionally, some of the subordinate spirits will come surreptitiously to the añatkok, but they do so in fear and trembling lest the master spirit find them out.

*March 9. To Become a Shaman.* A man or woman must, to begin with, be by nature fitted for it, i. e., the inside of his body must be of a light color. Some persons' bodies are dark inside and these the spirits avoid (cf. the Alaskan belief, e. g., Noratarmīut that women whose bodies are dark inside cannot become pregnant because the spirits that are to become children will not enter any woman, but one whose insides are white). The blackness of a woman's inside can be removed, in some cases at least, by shamans. Gunina-na never heard of the dark-inside theory being applied to barren women. A man cannot tell in advance if he is fitted for shaman-*and*om and he must go out and try. He should go to some places far from houses or people and cry out repeatedly: Nagliktaituña, nagliktaituña-ila. This should be in an appealing, grieving tone and the candidate should in general have a feeling that he is a poor unfortunate person in that he has no spirit to help him or sympathize with him and be sorry for his troubles. He should preferably weep, or at least should preserve consistently throughout his attempts, a demeanor of dejection, sorrow and worry, not only at times when he goes out to call for the spirits but also in his association with his companions. The longing for a spirit helper should never be out of his mind day or night, though his appeals remain for months unanswered. If destined to become a shaman, he will eventually dream that a spirit comes to

him. It may be in the form of a bear or other thing that does not ordinarily speak; if then it speaks to him he knows by that fact that it is a *kēyugak*. If it is in human form, he will know by some strangeness of dress, of manner, or by some hint dropped, that it is a *kēyugak*. It will not tell him directly that it wants to become his *kēyugak* or that it wants him for a *saunirk*, but it will tell something about itself, or will do something which reveals its nature or peculiarities; i. e., it may say: "I never eat caribou marrow," or "I never eat the marrow from the right hind leg of a male caribou," or "When I eat marrow I don't break the bone, but saw off its ends to get the marrow." If it says nothing of significance it will do something peculiar. It will put up its hands before eating, it will refuse to cut meat with a bone-handled knife or will insist that some one else cut up its food. If it sings a song or makes any set speech, the candidate should try to remember this. When he awakes, he should at once put himself under all prohibitions suggested by his spirit dream visitor's speech or actions and should in general imitate him in every detail: in dress, in the manner of carrying his knife or bow, etc. In general, he should refrain from hammering, pounding, or letting articles fall, this irrespective of anything the spirit says or does. (*Nagliḡark*, one who feels pity or compassion, from *nagliḡa*, he pities him. *Kin̄n̄raktok*, he summons, calls for, seeks spirits, as a candidate, i. e., the act of calling out "*nagliktaituñā*," give me some one to sympathize with me.)

If a man interprets aright and follows faithfully all the hints of his dream visitor, he will become his familiar spirit and can then be summoned in the regular *añatkut* way. If a man treats right the spirit first secured, other spirits looking for "*saunirit*" will learn of his good qualities and will come and offer themselves as his servants. On acquiring each fresh *kēyugak* the man must do certain things and subject himself to certain prohibitions. Some of these practices and prohibitions are temporary, others permanent. It is rare that the permanent prohibitions are onerous. They are usually such as refraining from breaking marrow bone, in any except a certain way; refraining from some not very important article of food, such as the meat of caribou shoulder blades, etc. The permanent practices required refer usually to wearing certain sorts of dress in summoning the spirit or to wearing certain ornaments on one's ordinary dress, e. g., an eagle feather, a belt of bear claws, etc. Probably no shaman had less than two familiars, *Gun*. thinks, some had five, some may have had more. She never heard of a shaman having two spirits of the same sort, if he had one *in̄rasuñak*, the others would not be *in̄rasuñak* but e. g., a bear, eagle, etc.

Every *kēyugak* has a *saunirk* except some that are temporarily free through the death of their *saunirk*. The group of spirits that serve one man recognize one among themselves as leader, whom they fear and obey. This

may or may not (usually not) be the spirit who came first of them all to the shaman; it is the most powerful of the spirits that serve that particular man, the others obey him because he is the strongest. It is the dress of this one, as well as all his peculiarities, which the shaman takes most pains to imitate. He would not wear it, if his chief spirit were a bear and the inūrasuna<sup>k</sup> merely one of the secondary ones. As noted above, there is no one sort of a kēyugak more powerful than the other as a class. In general it is this chief spirit the shaman summons; the spirit may in turn delegate the carrying out of the añatkut's wishes to others. In many cases, however, the shaman summons all his spirits, they enter his body in succession during the seance, he talks with all, questions all and appeals to each separately to do certain things. Therefore, if the search is for the soul of a sick man which another shaman has stolen and hidden, the shaman seeking to help the sick will command one of his spirits to search the sea, one to search the air, etc., in the hope of finding the stolen soul (nappan).

The effectiveness of a kēyugak's services depends not only on how powerful he is in his own nature, but also on how enthusiastically he serves the shaman, much as we think of a soldier as fighting better under the leadership of a Napoleon than of a less inspiring general. This is the chief reason why one shaman is more powerful than another. His greater power does not rest chiefly in the excellence of his spirit helpers, just as a less devotedly served man would have been less powerful than Napoleon though his army and its material equipment had been equally strong. The analogy between Napoleon and a great shaman is not in Napoleon's strategic genius as such, but in the loyalty and enthusiasm with which his men served him.

*March 10. To Become a Shaman.* A man may buy one of his spirits from a shaman who has many. Some men who do not themselves suspect it are particularly fitted for shamanism, their insides are very white. Spirits are eager to serve him, if he should call them they would come at once, while others have to call for them for weeks, months, and even years before there is any answer, according to the varying darkness of these men's insides.

This doctrine makes the missionary's phrase: black heart, black soul, a readily assimilable thing. In some cases the spirits come to these men without being called; in fact, the man or woman receives a call in this way: He puts aside in some place where it could not possibly be lost some article, e. g., he lays his pipe under his pillow on going to sleep; sticks his snow knife into the snowbank he is cutting and looks away for a moment. When he wants it, the pipe, knife, or other article, is gone. A spirit has taken it to notify him that it wants him for a saunirk. There are some men who do not care to become shamans and who do not heed even several calls of this sort. Gun. never heard of the refusal to become a shaman causing the

spirits anger. If the man wants to heed the call, which is usually the case, he begins at once observing the general prohibitions, e. g., refrains from pounding, soon will have a dream vision, and from thence the process is as described above.

**Purchase of Spirits.** A man who cannot get spirits to serve him in the regular way will sometimes buy one from a shaman who has it to spare. Before a sale, the shaman must ask his spirit if he is willing to be transferred; the answer is usually, if not always, affirmative, but it occasionally happens that the purchaser displeases the spirit and it returns to its original master without ever having manifested itself to the buyer. Interpreted from our point of view this means that certain men are honest enough to admit that they have seen no spirits nor become aware of the manifestations of any. These men are more or less looked down upon by the community. They are deficient in one of the essentials of a prominent man, and it takes a great deal of ability of another sort to make up for this weakness. A shaman never sells his chief spirit. When the spirit is sold the shaman is relieved from the taboos under which that *kēyugak* has placed him and these are transferred to the purchaser, who also undertakes the general taboos described above, against pounding, etc. As in the case of acquisition of familiars otherwise, some of the purchaser's taboos are permanent, others only temporary. Most or all general taboos are temporary, but Gun. and the rest of our people do not know the length of the period. They think it is till the season comes back to the same point next time, i. e., one year. A man *Gunuktuaryuk*, *Kittegaryumiut* (*Ilavinirk* tells) tried to purchase a spirit since *Ilav.* came east to *Herschel* first, since 1890 at any rate. At this time *Gunuktuaryuk* must have been over middle age for he is now and has been since 1906 the oldest living *Kittegaryuit* man. He paid one *Hudson Bay Company* double-barreled gun, a new double (twelve skin) deerskin tent, and several smaller articles, worth perhaps thirty or forty foxskins, or \$150 to \$200 altogether. The spirit never appeared to him, however; he never got back any of the price but the gun, and that only a year or two later when it was nearly worn out. A spirit that has been sold occasionally voluntarily visits its former master during seances and will even do his bidding, if not otherwise occupied through the commands of its new *saunirk*.

**Names of Spirits.** Spirits do not usually bear the same names as men, but in case a woman is barren, or in case she wants more children than she already has, she or her husband may pay an *añatkok* to perform a ceremony making her fruitful. This is merely an ordinary conjuring performance, such as he would perform to cure disease, bring good weather, or make the hunting season successful. When it appears that the woman is with child,

the añatkok may bring her a message from the spirit through whose agency she became fruitful saying he has made the child to grow within her and wants as part of his pay that the child be named for the spirit or by some name he has selected which may be the name of some dead human being, or a name from the spirit world. Gun. does not know any person named after a spirit but has often heard the above explained.

Oyuina is the name of one of Ovayuak's spirits, but not of his chief one. He is described as a small young man, very active and sprightly in movement (1) pitkoñáitok, (2) sa pañ·a·riktok. [(1) strong, able (2) well appearing, looking able, well dressed, presentable, etc.]

Fidelity of Keyukgat. At a shaman's death his familiar spirits will go with his body to the grave and remain there longer or shorter periods according to their affection for the dead. Some remain only a short while, some till the flesh is off the bones, and some stay forever. Gun., Mam. and Aliñnak consider it probable there are some kēyukgat still about the old graves here at Langton Bay though they are so old that most of them at least antedate the memory of Panigyuk.

Tupila<sup>r</sup>k. Aliñnak tells: The wife of Karlik was sick. Several shamans had been consulted and all agreed she had a tupila<sup>r</sup>k and would not get well while she had it. A man's complete suit of clothes, style and details unknown to Gun. who has this story by hearsay, was sewn. When this was ready, a young man (not a shaman) was selected to wear the suit, then given the name "tupila<sup>r</sup>k" and was so addressed by everybody. This was done when all the grown people present at Kittegaryuit and some of the children had gathered in the house of the sick woman. The ceremony began after dark. This was during the sunless days. Some ceremony was performed, the details of which Aliñnak does not know, to induce the tupila<sup>r</sup>k to leave the sick woman and enter the clothes, but not the person, of the one called tupila<sup>r</sup>k. At daylight the young man stripped off the tupila<sup>r</sup>k suit and it was burned. In this burning the tupila<sup>r</sup>k was burned to death. The woman improved but was not quite cured. She lived several years and died at the time of the last epidemic, together with her husband; she would probably have died soon but for the removing of the tupila<sup>r</sup>k that possessed her.

Guminana tells: When G. was small there was at Kittegaryuit a performance to free a sick woman of a tupila<sup>r</sup>k. This was during the dark days of winter. The woman was the mother of Karlik whose wife was the subject in the performance recorded above. All persons, except a few who stayed home to look after children, gathered in Karlik's house. All lamps were put out and a thick blanket was spread over the windows. There was no person dressed for a tupilak or representing a tupilak in any way. All

grown persons closed their eyes and held their hands over them; children had blankets over their heads, put there by their parents, unless the parents had complete faith that the child would keep his eyes shut. Gun. had a blanket put over her by her father. There was no beating of drums or other ceremony; people merely talked in low tones, saying the tupilak would come. Every now and then some grown person, not necessarily an añatkok, would go out and come in reporting the tupilak was not in sight. At length however, some one who went out saw the tupilak<sup>r</sup>k coming up from the sea beach. This man returned to the house in fearful haste. He reported he could not see what the tupilak<sup>r</sup>k looked like, but it seemed about the size of a moose. Soon some single person went to the trapdoor to listen. When he did so he heard in the hallway a voice making some sarcastic remark, pertinent to himself. This was the tupilak<sup>r</sup>k who was mocking him. No one but this man heard the remark, but he reported what was said so every one could hear, upon which there would be general laughter at his expense. Sample remarks of the tupilak<sup>r</sup>k are: "I wonder if that ugly scar on your nose makes you any homelier than you would be anyhow"; "your ears are full of dirt"; "get your wife to go hunting for the family, she'll get more seals than you," etc. When this had gone on for some time, when perhaps all or most of the grown men had taken their turn listening at the trapdoor (Gun. is not sure) the tupilak left the hallway and all grown persons of both sexes followed. No child must leave the house during performance and must not sleep; those children who stayed at home might sleep, but those who took care of them must not sleep and none of them must go outdoors till those at the seance came home. Those men who had songs of their own would hear them sung by the tupilak<sup>r</sup>k in a way to make the song and its owner ridiculous.

The people had gone out in a body; anyone who wanted to would step forward a few paces from the rest, who stood in a close knot near the house door, and listened; he would then hear his own song sung. When the song was finished he would return to the crowd and tell in what way the tupilak had mocked him, often singing the song in the way the tupilak had done. The tupilak never sang new songs, only well known songs of the people present. One man at a time would step forward and listen, and then return and tell, as the first had done, till all those who had songs were done. Those who owned no song, had nothing to listen for and did not step forward. All now returned to the sick house. The sick person under treatment was the only adult who did not go outdoors or in fact take any part in the performance. Gun. does not know if this was because illness prevented her, or for some other reason.

Shortly after returning to the house and before as yet the tupilak<sup>r</sup>k had

made any new manifestation, some men went outdoors, taking with them one end of a long thong and leaving it so that one end was out of the front door of the hallway while the body of the line was still in the house. These men returned to the house without seeing any sign of the tupila<sup>k</sup>, but soon he came and took hold of the line, starting to pull it out. When they became aware of this as many men as could took hold of the line and pulled against the tupilak. He was at first stronger than they and pulled them, in spite of their united efforts, to the trapdoor. At this point, however, his strength began to fail and finally he died. As his strength began to fail, the tupila<sup>k</sup> could be heard talking. His voice was that of a person being choked. This was the first time the tupila<sup>k</sup> made any noise loud enough for all to hear. Much of what he said Gun. did not understand because the utterance was "thick" through his being half choked; he spoke otherwise loud enough for all to hear, and used the Kitegaryuit dialect, not the keyukgat language. Part of what she did hear Gun. has forgotten; what she remembers is as follows (told in indirect discourse): Kagogo taima inoksakpa? tokotaksiganni unnirktluni, Keaplunilu. In direct discourse this would be: Kagogo taima inoksakpik? Tokotaksigaña. When he died the line became easy to haul in, and soon up through the gattak came a bundle of something. The lights were now lit and on the floor was seen a bundle of clothes about which the end of the line was tied, underneath the suit on the floor was found a kogvik and in it a raven's feather with sinew so attached that it was seen it had been someone's anñroak. It was covered with mould, had evidently been long in a damp place. When the tupilak died the sick woman was said to be freed of her tupilak.

During the whole performance all, old and young were very much in fear. Now all went home. Next morning many assembled near the sick person's house, not more than half of the people went to this performance, and the suit, kogvik, and feather were burned. Gun. did not go to this performance. She thinks there was no ceremony and that anyone at all made the fire and did the burning. The burning was for a reason not known to Gun. The tupilak was already dead. Perhaps, she thinks, it was to prevent his coming to life.

The tupilak<sup>7</sup> does not seem to have been a prominent figure in popular beliefs. Mamayauk who is well informed on spirits in general, first heard of tupila<sup>k</sup> from the white missionaries, who used it for some Christian character, perhaps for the devil, or for sin. She was positive they knew nothing of tupila<sup>k</sup> till the missionaries came. Alinñak never saw a performance and Gun. who is about forty never saw but the one described, and never heard much talk of tupila<sup>ks</sup>. Ilaviñirk never heard of tupilaks in Alaska except that other tribes used to tell there were tupilaks known to the Barrow

people. While at Barrow, however, he never heard a tupilak spoken of, though he spent a winter there. The artificial monsters made at Point Hope and elsewhere were not called tupila<sup>f</sup>k.

*March 11.* Customs. When the ground cracks from frost so as to give the house a perceptible shake one should say: "Gaktugut, Kañerktigut, agin tigluktlugulu." If translated according to the Kittingaryuit dialect this will be: "We are starving, pass over the roof of our house" and we hit the front of the bed platform as we spoke with our fist. By the Kotzebue dialect this would be: "We are starving, travel past our house without stopping," etc. The belief behind this saying is unknown to any of our people. The saying itself is unknown to Ilavinirk.

Cure of Disease. An añatkok who has several spirits will not delegate the chief of them to effect the cure. Each of these spirits has a pitokon, or sort of badge, perhaps of the nature of an añroak, which it wears attached to some part of its clothes. The pitokon of a man's chief spirit is worn in duplicate by the man, or worn on seance occasions only, and at other times carefully put away in his house or baggage. A pitokon so worn or kept is called a kinñraun; the spirit will come only at the call of one who has a kinñraun and will stay by such a one only. At the beginning of a seance the shaman dons his kinñraun which is a duplicate of the pitokon of his chief kēyugak. The chief spirit will then come and enter the shaman, upon which the shaman becomes that spirit, i. e., what he says and does thereafter are not the words and deeds of a man but those of a kēyuga<sup>f</sup>k. The possession, or identification, begins with the shaman's face and body undergoing as great a change as possible. The first words spoken are: "I am so-and-so," the name of the chief spirit. That the shaman is "possessed" by the spirit seems hardly the word; he is the spirit. According to Gun., if the chief spirit is A-līna, during the seance the voice that speaks is A-līna's, the tongue that utters the words is not a man's tongue but A's; the hand that gesticulates is not a man's hand but A's. This must be more or less vaguely apprehended doctrine, for they will simultaneously say: So-and-so is conjuring (onñoyuak). While yet in the person of the chief spirit the shaman according to Eskimo view the chief spirit will, among other things, order one of his subordinate spirits to go, stay by and cure the sick. It is only while in the person of the chief spirit that any orders are issued to the subordinate spirits, i. e., it is the chief spirit and not the shaman that orders the lesser spirits around.

Successively, the shaman may become each of his subordinate spirits, and while in their person, he will give out information as to the past and the future doings of the spirits and as to any past or future events in general. It is not necessary for the shaman to employ personally any kinñraun



except the duplicate of the pitokon of the chief spirit, the others will identify themselves with him so long as he wears the chief spirit's emblem.

So soon as the seance is over, the shaman will take a duplicate of the pitokon of the spirit whom the chief spirit ordered to cure the sick, and this he will give to the sick person to become his kinūraun. It will be attached to the sick person's clothes or hung up near or over his bed. The spirit designated will now enter the sick and drive out the anūiaron, if he can. When the anūiaron has been driven out, the spirit will remain by, but not inside, the sick for fear the anūiaron may return, which in fact it often does, in which case the kēyugak must defend his charge. Only after the anūiaron has ceased trying to return, may he abandon his protegé.

Some sokotaks are so powerful that the kēyugak when he tries to enter the sick is driven to retreat. In that case, he will return to the shaman and tell him he is afraid. In some cases the shaman will compel the kēyugak to return; this he does through a seance similar to the first. Each time the kēyugak is to return to a fresh attempt after failure, he must be made some small present of something he specially asks for to pay him for each effort. If he asks for a pair of mittens, mittens will be made, often of miniature size, and put under the sick person's bedding, hung over his head, or given to the shaman. The spirit will then have new mittens, which are the ta·tkoit of the mittens made for him. Only three things of those for which the spirits ask are ever made use of by the spirits: gloves, which are worn by the shaman when he becomes the spirit in the seance; primers of muzzle-loading guns, which the spirits want for drinking cups and which are usually sunk by the añatkok in a tide crack; and, lastly, women, whom the spirit in the person of the añatkok has for a bedfellow for one or more nights. This woman is usually a relative of the sick, but occasionally, if the patient be a woman, it is she herself after she has become well.

Besides this payment considered to be directly to the spirit there was a far more substantial fee paid the shaman himself. For one performance this often went as high as an umiak with equipment. For repeating the seance there must be more fees; not so much that they were demanded by the shaman, but rather that they were insisted on by the patient or his relatives, for "it was well known that no one could get cured unless he paid the shaman well." This not only made the shaman grateful and eager to help, but also made his familiar spirits grateful and willing, for they are so fond of their saunūrit that they are thankful for any favor done him. Besides this there seems to be a feeling that the size of the fee itself automatically increased the chances of cure. As noted elsewhere, the Alaskans had these same beliefs. Kakotak at Herschel in 1908 wanted to give me a valuable dog for the medicine I gave him, saying he knew well that the medi-

cine had no power unless it was well paid for. The shaman's fees were not returned, though a cure were not effected, provided the patient lived; but if he died within, say half a year of the payment, it was returned to his relatives. If the relatives were minors, the fee went back to those that housed them; if the man left a widow she got the fee; it was considered hers, though she usually surrendered its use (e. g., of a boat) to her male relatives. If the relatives of her dead husband asked her for gifts, she was not to grudge them, but anything she had left on hand when she married again went to her second husband. In some cases most of a man's property by his wife's wish was put on his grave: umiak, kayak, fish nets, sled, etc., besides the imperative knife, bow, tools, etc.

*March 3.* Beliefs. All our people told in concert today that formerly the kēyukgat used to be truthful in seances, friendly to men and generally well-disposed. Now since people have turned to Jesus the kēyukgat have become untruthful when they visit men in dreams or are questioned through foot lifting; they have become sulky and unfriendly in disposition, and as willing to do harm as they were formerly to do good.

*The Name.* Frequently a person before dying will give special instruction as to the bestowal of his soul as the atka of a child. These instructions consist usually, however, in specifying which he prefers, to be named after the first child born, whatever its sex, or after the first male child or first female child, in all cases, children of relatives. In case no instructions are left, only male children are named for male dead; an old man occasionally specifies he wants to have his soul become the name of a woman; women also occasionally prefer to become the name of males. In this relation children of families that have exchanged wives are relatives. A parent who has named his (or her) child after such a relative will address it: katañoti<sup>n</sup> or katañogalu<sup>n</sup>.

*March 12.* Visitors from Baillie Island arrived about sundown: Kommana, his wife Ituayok, their daughter Siksigak, and Aliñnak's father, Ijituaryuk. They came from Norarvik (where the people are) in five camps and seven days. Got two seals in cracks in the ice west of Horton River, but were out of food, had about half a breakfast. They tell that Tay-ok's wife, Inonūranna, who was in a sort of half-witted stupor when Dr. Anderson left Baillie in January, is now so insane that she no longer recognizes food or drink as such when set before her: sings, weeps, laughs, or talks, constantly. Kommana, named also Katpak, aged about forty-five, at Kittegaryuit, is also reported dead at Norarvik, apparently blood poison from an abscess on the leg, died Feb. 28th. Few foxes are being caught and no bears. Tulugak's elder girl, Anáyu, is said to have been near death with "dry throat" (palirktuak) which is their name for any disease in which the throat

swells more or less, feels dry, and the throat and tongue are in some cases coated white. Natkusiak's wife, Akējigiuna, is considered to have died of "dry throat," but the white men considered it pneumonia.

**Theory of Disease.** Our people tell in concert that whitening of the tonsils is sure to be fatal; some die in three or four days, some live for years and are periodically half-cured till at last they die of "palirktuak." There have been in Norasak's throat for a week or so two lozenge-shaped white spots about the size of an ordinary black bean. They have their long diameter at right angles to the axis of the mouth passage and are about even with the uvula. When they get white there is considered to be an open wound, "which sometimes bleeds, sometimes not." The wound will not heal unless the white is scraped off with the point of a sharp knife. This is a painful operation, but healing sometimes follows it. This healing is seldom or never permanent.

*March 14.* Nerrivik (Kommana says) is known here only as one of the favorite kēyugkat of shamans. He does not remember ever hearing what her characteristics were.

Tupilaks (Kommana tells) were anciently, he has heard, made by men out of dead matter, i. e., the tupilak was an artificial monster; but in his time this art was already lost and a man was dressed up to represent the tupilak. Sometimes the tupilak was killed by throwing something at it when it had entered the hall and was about to enter the house through the gattak. He (but no one else of our people) considers the killing of the tupilak to have been only make-believe. "They threw at the tupilak things that could not hurt if they did hit, and they did n't hit it anyway; the man who was tupilak just played at it." Kom. though older than Guninana (he may be forty-five or fifty) never saw a tupilak performance, but he heard of the ones told by Gun. and Alinñak, was at Baillie Island when both were performed. He does not remember hearing of any besides these two performances.

**Customs.** When a man had trapped or otherwise killed a fox and when he entered the house with the fox some one already in the house should say as soon as he sees the fox: "Kākaka, iyigerl." This referred to the custom of taking an atkon (lamp light-stick) and with the charred end of it drawing a line between the eyes of the fox. This, he thinks, was a custom based on an "unipgak, for most customs have a source (kañia) in an unipgak."

**Mode of Thought.** I have often tried to explain to Ilavinirk why it is that people in our country think that they would have been better off if whites had never come, i. e., now they are dying off, etc., through imported diseases, vices, houses, and food. He, however, refuses to believe that we can object to ships coming here on any other ground than that we grudge

the poor Eskimo the large quantity of flour, cloth, etc., that the ships carry up here. He thinks I fear scarcity of flour for the white people because whalers bring flour up here.

Sorts of Turnūrat. Five general classes of kēyukgat are known to Guminana.

1. Erkarmūtak, spirit of the inside of the earth, erka.<sup>r</sup>k.
2. Nivīa<sup>r</sup>miutak, spirit of a lake.
3. Īptinermūtak, spirit of the sea beach or rather of the tide crack portion of the sea near the beach (iptinirk called also Inūrasuñā<sup>r</sup>k).
4. Uluksarmūtak, spirit of the sea.
5. Attla<sup>r</sup>mūtak, spirit of the air.

The Iptinermūtat (or-miut) are the only ones who have a costume copied in detail by the shaman.

*March 16.* People preceding Eskimo such as are told of by most eastern Eskimo and as far west as Banks Island (called by Kañ. turūnrat) are unknown under any name here so far as I can find out.

*March 17.* Inūktuyut were the people of the Eskimo Lakes region. Some of them came to Kittegaryuit for the white whale season, some not. They are said to have their name from the fact that once long ago a man shot a kayak rower as he was about to land from pursuit of caribou. The murderer's older brother is said to have scolded him saying: "What did you kill him for? Were you so hungry you wanted to eat a man? If that was the reason, go ahead and eat him." Angered by this chiding, the murderer cut a piece of flesh and ate it. This gave the district of the Eskimo Lakes and not the one spot where this happened, the name Inūktuyut. In general, the Mackenzie people did not eat any of the flesh of a murdered man, but the murderer should lick his knife off at once. A man killer, whatever the circumstances, must do no work for five days, and must refrain from certain food for a year; insides of all animals and heads. In general, the taboos connected with man killing were the same as with whale killing. The taboos in whale killing affect only the man who struck the whale and the one who steered the boat, held the steering paddle. In man or whale killing the killer, but not the steerer, was entitled to a tattoo line across the face; the man killer, at least in case of Indians, had a line from nose to each ear, the whale killer from corners of mouth to ear. The boat steerer had whale badges, one line tattooed on each shoulder. Īyitua<sup>r</sup>yuk has seen Indians tattooed around the roots of the hair for having killed Eskimo.

Man Killing. Before Kommana's birth (is about forty-five) a man named Īpirktuak was killed by three men, Apsimirk (the father of Guminana), Tu-tigak, and Napigak. Soon after this the latter two were killed by relatives of Īpirktuak and Kommana never saw them. Apsimirk,

however, lived a long time and finally died of disease probably between 1885 and 1890.

Bows were still in use when K. was young and he killed his first caribou with a bow. There were two styles which were considered equally good. The one-piece bow was kiluinnak; the three-piece *isuálik*, or *tutisaraluak*. The bow was usually made of spruce of a bent log, the aim being to find a suitable bend for the main bend of the bow. This sort of stick is called *itgirk*. The backing was usually of caribou leg sinew; white whale sinew is considered as strong.

### TO POINT BARROW, 1912.

*March 20.* En route to Cape Smythe. Beliefs. Pups should be fed a pinch of "sikum oksoa," a white chalk-like substance found occasionally on sea ice and believed to be "the fat of the ice." This will make the dog easy to fatten and will make him keep his flesh well in times of scarcity.

The rainbow is the thing that keeps the sun from falling. It is "*sin-kinñrum aiyaguta*," or the prop of the sun (*aiyaguta* is used, e. g., of tent poles in an A or wall tent).

*March 21.* At River Jardine. Beliefs. Spirits (*turnñrat*) known as "*inñeryuit inuit*" inhabit the "smoking mts." and it is the smoke of their fires we see. Those near Baillie Island are harmless but those E. of Horton River are very dangerous, the Baillie Islanders say (*Mamayauk*).

Place Names. *Ivñañik*, *Ivñañeryuk*, is the name of the first hills E. of "R. Jardine." This is from their fancied resemblance to a young woman's breasts.

*March 23.* Horton River. Started about 7:15 A. M., Captain Wolki's two sleds and our three. Hauled along wood for camping and at about 5 P. M. got to Kurok, a creek mouth where sealers occasionally spend part of the winter, as open water is usually nearer here than anywhere else on Cape Bathurst peninsula or Baillie. Used to be two wooden houses here, but a year or two ago, they were broken up for wood. The creek mouth is about two miles E. of what is called "Whale Bluff," which in turn is called eighteen miles from Baillie Island.

*March 26.* Baillie Island. Beliefs. When a child is born its ears should be pierced at the same time the navel string is cut, "so that the ears and the navel may heal together." This practice was occasionally omitted with boys and of recent years with girls also. The hole is not in the lobe, but in the outer edge of the ear on a level with, or a trifle lower than the orifice. If the child is a girl, a piece of her navel string should be saved and worn by

her as an amulet. Then, if her husband strikes her with his fist or hand, his finger will swell up.

*March 28.* Tradition. Nauyavúk says once long ago at Kittingaryuit there were many kaiya<sup>r</sup>ks in pursuit of white fish. A man who had some grudge stabbed another and was in turn stabbed by a third with the whaling lances. More and more men joined in the fight and finally there were more killed men than the living and the water was red with blood. This was before the memory of any man who Nauyavúk has seen.

Illness. Nauyavúk says that before the ships (whalers) came there were some epidemics, but between times few were ever sick; no prevalence of swellings and running sores as now and colds were less frequent and less severe at any rate. He thinks there "were no colds." This corresponds pretty well with our present observations of the Eastern Eskimo.

Whaling. (Nayuava'luk). The small iñutok whales were preferred to the larger because they were easier to handle and the meat was more tender and tasted better.

*March 29.* Beliefs. If the anniaron or sokotak comes from afar, the disease is harder to cure than if it originates in the community, a sokotak sent by a shaman of another tribe is more dangerous than one sent by a neighbor. Today I told someone they were suffering with white men's diseases and that they were dangerous. Yes, they knew that of old, anni-rotit used to come from distant tribes and were deadly; now they come from the whites who are even farther off, so it is clear they must be more deadly still.

Songs of a different sort from the general were sung by two old women tonight in sick Añusuiñaoux's house. These were said to be songs of the kagmalit, learned from the Langton Bay people. They resemble much the songs of Coronation Gulf.

*March 31.* En route to Cape Smythe. Nauyavaluk says no fights with Indians took place in his time, but he saw many who had taken part. Pa-nigyuk's mother was Nagyuktogmiut, father probably from near Langton Bay. All tunirktak lamps and few pots from E., lamps were made also of stone from lowland towards foothills west of Mackenzie near Pokerk's place.

*April 8.* Point Atkinson. Helped Frye vaccinate people. Heard that Navalluk wife of Añusinnaaux, knew Nerrivik story.

*April 9.* Went ten miles S. E. to where Memoranna's and Añusinnaauxpa-luk's families are camped to get from Navalluk the story of Nerrivik. It turns out to be not the Sedna myth I hoped for, but an Eskimoized European tale.

*April 18.* Igloryuara-luit. Started 2:56 P. M. got to camp of Ivitkuna

at about 8: P. M. at Igloryuara-huit, about eighteen miles. They are living on ptarmigan alone, are in two round tents, eight people.

*April 19.* Crazy. Kuna-sak, a woman, Kittegaryuit, was crazy for about a year but is now all right. Kalurak's wife.

**Large Men.** An Indian named Sa-suk was shot by Si-patualum because he had carried off Si-patualum's wife. The Indian was so large that a man could dodge between his legs. Roxy and Ovayvok saw his grave. Uprights which were set up at head and feet were the length of two men apart. Another Eskimo named Īaryuak was so large he used to pick up caribou by the nape of the neck and examine them as one may a rabbit. He was a Kittegaryuit. People have seen his tracks in time of fathers of men still living.

*April 21.* Tunnunirk. Boys writing folklore for me. People live from hand to mouth, they can get rabbits when they want them. Yesterday they were too interested in us to hunt, and today we are all a little hungry for no one dares to shoot or fish (they hook connies here) on Sunday.

*April 22.* Started 11:30 A. M., lunch 4-5:30, about 6:30 came to camp of three families who are moving east for the summer to Kittegaryuit. They are Naipaktuana (30) and wife, Kittegaryuit; Mimirina (30), Baillie Island; Omauk (30), Herschel, his wife Atugauk (25), M. Kit., F. Herschel; Anara-siak (25), Inuktuyak (Pal.'s brother) and wife (25), Komigájuak (younger sister of Iguana (Fritz's) and Inunūiranna (crazy, wife of Taj-uk).

*April 23.* Started 12:30 P. M. cooked and stopped several times. After four and a half hours' travel came at about 7:30 P. M. to camp of Keruk and Itkitk (with I.'s wife and girl child about six years old). They are en route from up river to trade at ship. Camped near there. K. spent last winter near Nome.

The Eskimo language, Keruk says, has already been forgotten, or, rather, was never learned by a number of the younger generation at Nome.

In travelling from Point Hope to bottom of Kotzebue Sound he said, uanmuktuami. In talking about this later, Annaktok explained that uanmun was used no matter what direction as to the sun one had to curve in following the coast one way, and kivanun for the opposite way. He is the first Eskimo I ever saw who seems alive to the real difference between our points of the compass and their "up the coast," etc.

*May 2.* Herschel Island. Language. In talking with Artumirksinna I find his accent and vocabulary resemble Cape Smythe dialect; in fact his accent is closer to Cape Smythe than to Kittegaryuit. He is said to preserve the Herschel idiom (tuyormiat) correctly. This goes to show their closer relation with the west than I have suspected from their known Barter Island summer trading.

*May 5.* En route for Cape Smythe. Custom. A crazy woman (perhaps only out of her head from illness) named Kagrok, was abandoned in winter at Nuna-luk. She froze to death. This was B.'s first year at Herschel, when Comiskey was captain of the "Narwhal." Her relatives, those who abandoned her, including her brother who was older than she, are now dead. Woman was young, perhaps not full grown. At our camp tonight (two or four miles W. of Nuna-luk) is the grave of an old man Kisun (called Jags by whites) who was abandoned (the winter 1904-5?) to freeze in a tent. He had been alone between one and two weeks when he was found by Billy and Tapka-ruk who were hauling meat for the "Narwhal" (Captain Leavitt). He was then past speech and both legs were frozen to the knees or below. They camped by him. He died on third day and they put his body on a high rack. He was later buried by Cockney (white-footless) of Narwhal. He was abandoned by Saglu, Kurugak (now Rampart House) and Kipki'na, Mackenzie Delta. All these are inland Eskimo, probably Colville or Noatak. Saglu some sort of relative.

*May 9.* Near Icy Reef River. Started 12 noon, camped 9 P. M. Distance about eighteen miles, camped about ten miles W. of western outlet through reef of Icy Reef River, outlet is marked by two tipi-like frames of poles and a sort of white man's log cabin, old house, a few rods away from the tipis, all just E. of the break in the reef.

Meaning of Certain Place Names.

Tā'pkārk (many places, e. g., Shingle Point), sandspit.

Av'-vak (Baillie Island), something cut in halves; a half.

Ĕ-kāl-l'rk-p'ik (one of Colville mouths), to begin having, catching, or cooking fish.

Pū-tū (cross-snye of Colville), a hole, a hole through.

O-l'ik'tok (Beechy Point), he shivers, (therefore, shivering place).

Kak-to-v'ik (Barter Island), place of fishing with sweep nets.

Sha-vi-ō-v'ik (river), a knife place, probably, place where knives are to be had.

Shara-a(r)n'irktok or Shara va(r)nāktok, it is swift or it has swift current.

Tā-rak (Cape Smythe Utkiavirmiut; called by whites "The Terror" or Tā-ha), shadow, a reflected image, or one's face in water or mirror.

Person.

Kē'-rūk (Herschel; Kurruk on Bering somewhere), wood; a stick. Person.

Kē-g'irk'-tak (Herschel; Noatak?), island. Person.

Nū-wök (Point Barrow and many places), point of land, knife, needles.

Utkiāw'ik, said to have been settled by people from Nuwök, before settlement used to be called Uk-p'ar-w'ik, the owl place, and name later corrected to present form. This is popularly believed at Barrow and Smythe, and told by all men for fact.



Tūl-li-man-nīrk, (a sandspit near Point Tangent), a rib.

Ī-shūik (Cape Halkett), a point, end of a thing, land, lake, etc.

Ōk-pi-lak (river near Barter Island, name from Ok'-pĕk + i-lak), it is without willows.

Sī'-ku (old village on reef, approximately at "Icy Reef" of the maps), ice, possibly so called from huge "glacier" formed every year on the lowland behind it by the small river "Kan-er-kat."

At-tō'k-tuak (Cape Smythe, parents same), he sings.

Ī-mig'-luk (Herschel; M. Cape Smythe), lightning; a spark from a fire; a man who jumps (suddenly only?) "i-mig-luk-tok."

Na-gō'-rō-ak (Flaxman, adopted daughter of Uikhsrak and Tullik), he, she, it, is good.

Shūn'-gan-r''a-vīk (Cape Smythe, Oturkarmiut), a place where are, or a place where one gets beads, also labret stones, which are indeed usually the halves of a broken bead.

Am-mar-rō-ak (Cape Smythe, F. Nunatarmiut, M.'s father Nunat., mother Cape S.) Wolf, though form usually used for animal is a-ma-ōx, instr. case — a-mā-kō'-mīk.

Pan'-nī-rak (Mackenzie River, for parentage see diary for 1906, Oblutok and wife) Pannik, daughter; pannira, my daughter. On this stem are many names; Pannīk piu-rak (Ilav.'s father; Pannīkpūk, Cape Smythe.) Pannigabluk (several) Pannīgīōx (Ilav.'s girl, and Cape Smythe), Pannī-ū-lōk (Colville), etc. Pannīgluk says: "Attautjīt-tūnīttuat," all these and more names. Pannīhluk is also known to Pannigabluk by one case in her country of a man who is long dead.

Kau'-nark (F. Oturkarmiut? Cape Smythe) fat of deer, sheep, or moose.

Shag'-luk or Shag'-lu-ak, a man Billy knows who is now probably at Cape Nome. Tribe? Pan. has known several. Oturkarmiut of this name, liar, cf., Shagluktok, he tells lies.

Nān-nē-xrak, a girl who died at Flaxman a year ago last spring. Pronounced by Pt. Barrow people, Nān-nēx-srak and by whites Nan-nēg-rak. She was Nunatar (?), lamp-material, something to be used as a lamp.

Meaning of Certain Proper Names.

Kā'd-rī-vi-ak (at Cape Smythe — called Bismarck), the round patch on the sole (heel or toe) of a boot.

Ī-la-v'ī-nīrk (called Anderson; of our party; from Kotzebue), the remainder, part left over from s.

Ā'n-nak-tok (at or near Herschel, Kuwormiut?), he evacuates.

Kū'rū-rak (at Rampart House, F. Noatak? M. Kuwök?), pin-tail duck.

Tū'-lu-rak (around Herschel, Tribe?), raven.

Tū'llik (at Flaxman, from Tapkark, near Cape Prince of Wales), plover.

Ä-xä'-lirk (Sharavanirktok; second wife of Putulerayuk; tribe?) old-squaw duck.

O'-ya-rak (Flaxman; Kuwök), stone.

Kū'-kik (Herschel, F. Noatak, has no feet), finger or toe, nail.

Tag-lū'k-hsrak (Flaxman, F. Cape Smythe) snowshoe material; anything intended to go towards making snowshoes.

Kīs-sik (Flaxman, son of Taglukhsrak); hold-all bag; a skin bag in which men keep various tools, etc.

Arrīga-āitjōk (Barrow, parents also), handless, fingerless.

Ak'-pēk (Barrow, parents Colville); a sort of berry (salmon berry?)

Nau'-yak (Flaxman, Kuwök), seagull, the large white kind.

Kik-tō'-rī-ak (Colville, Pt. Hope), mosquito.

Shā'-vik (Cape Smythe, Noatak parents), iron; knife.

Kōñ-ō-sīrk (Cape Smythe, parents same), neck of man or animal.

Ka-yō'-tak (Flaxman, F. Cape Smythe, M. Point Hope), dipper.

Kō'-pa-ak (Flaxman, Kotzebue) the half of a thing split lengthwise, as a deerskin split nose to tail.

*May 15.* Taglukhsrak tells: He followed about a week ago the tracks of a large polar bear out on the sea ice. All at once the plain fresh trail ceased abruptly. On either side the last tracks and about nine or ten feet away from the tracks were the wing marks of a bird. For the last few rods the bear had been running hard. The bird had carried the bear off. Tag. has since been too afraid to go on ice, other natives here (3 men) also worried.

*May 16.* Taboos. Inyukuk's wife abstains from white men's food because she is with child. After delivery of child she may eat it. If no meat is obtainable she may eat a little bread, but no other "civilized" food. She is of Kuvūk and Nogatak parentage, brought up on Colville till two years ago.

*June 15.* Point Barrow. Whaling Practices. Brower bought today five slabs of whalebone from Sailagruk, a medicineman, which he got from Panniyunayuk for having magically assisted him in getting a whale, the performance was before the whaling season commenced.

*June 19.* Point Barrow. Bolas Throwing. Bolas throwing was practised by crowds of men at the "shooting station." From a big flock almost everyone sometimes got a duck and occasionally one bolas got two birds. When only one or two men had ammunition for shotguns they were not permitted to shoot from the shooting station.

*June 25.* Armor. Armor was worn, everybody here agrees, by the coast people but not by the inlanders in "times of war." It was of fish scale pattern, whalebone plates, each perforated at a corner (rectangular).

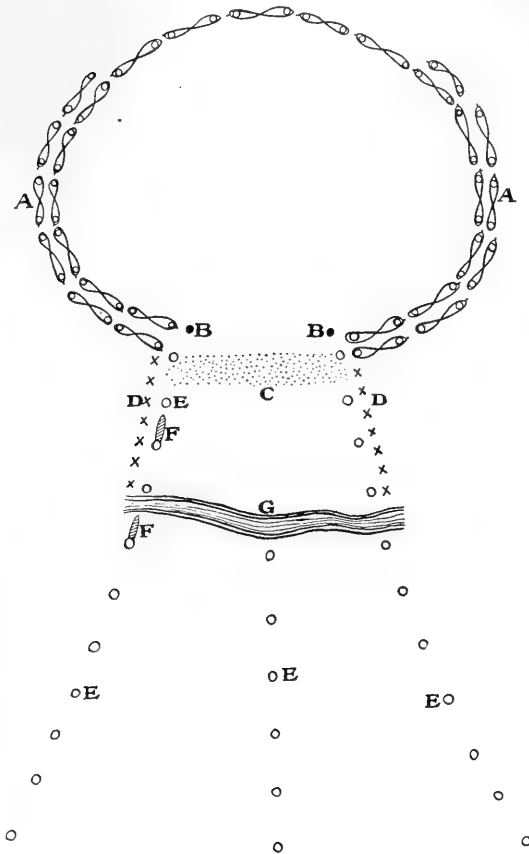

Fig. 93 (60.1-1034). Plan of a Caribou Drive, Point Barrow, drawn from a Model.

This kañierak (kañierkat) model is explained by the maker, Utuayuk, Tigiragmiut as follows: The center line of willows (e) or other slender sticks is about ten miles long. They might vary in distance apart from five to fifteen yards. They were about three or four feet high and only the ones nearer the snares were capped with earth, or preferably with moss that would flutter in the wind. The central line should overlap the side lines more than the model shows. The ends of the side lines are perhaps a mile or less from the central one and the end of the central one is about a third or half a mile from the side lines. The line G represents a river frozen over, not an essential, though usually a part of the scheme, and C is a ridge high enough to hide the snare posts. Innuksuit kitirarotit is the central line of poles; the side lines are simply innuksuit; the ones bent towards the enclosure are añarrat and are no farther apart than a man is broad (innumivva, the width of a man). The innuksuit get closer to each other as the lines converge to the entrance of the enclosure, the ones nearest the entrance have heads of moss, the entrance is about a quarter or a third of a mile wide. D represents bushes (okpeit). The poles holding up the snares (A) were slender, usually willow, and a little higher than a deer. They were stuck in the snow and fell over when a deer was snared (Fig. 94). The snares were in double rows on the sides of the enclosures, for the caribou broke out there. There are said to have been over two hundred snares. Some say if plenty caribou entered almost that many caribou were snared; often two in one

Plates were in rings around the body with strips over shoulders and protected trunk only; head and neck, arms and legs were unprotected.

*June 30.* Whaling Practices. The kiliokton or muktuk scraper was used only during whaling by crews of boats engaged in whaling or possibly by all who ate on ice. If blubber or muktuk were eaten unscrapered, there would be bad luck in whaling.

Childbirth. In cases of death at childbirth the foetus was removed from the dead woman. Mr. Brower saw one case at Point Hope. Two days after the woman's body had been placed in the graveyard two women went out and uncovered the body. One of them then made a cut well up on the abdomen, reached in with a hook and pulled the foetus out. The other woman fainted at the sight. The knife used was flint, the hook, he thinks, was ordinary blubber hook used for "pokes." Navel string also at childbirth always cut with flint.

Flint knives. Flint knives (anmark) were always used to "rip" the caribou in the skinning operation when Mr. Brower first lived at Cape

snare, especially female and fawn. There were two men in two circular (or other shaped)

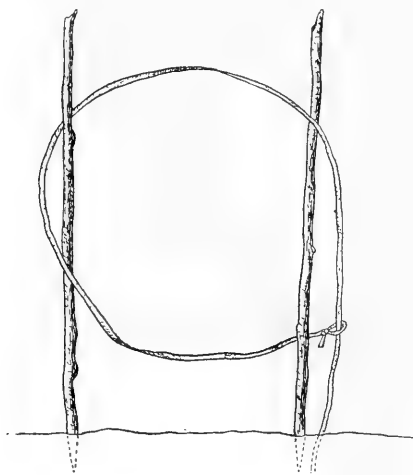

Fig. 94 (60.1-1034). The Caribou Snare.

snow rings about four feet high at F. F-F represent snow shields higher than the rest of the ring. Back of the willows other men are hiding. If the wind changes before deer come all go to opposite side of fence and make snow walls. The caribou are driven by two or so men; the driving is easy for caribou follow fences. When caribou have passed the river the two men jump forward with shouts and those behind the willows follow. The two seize the spears (B) at the entrance of the enclosure. These are called panna, the name of the whole weapon. The blade is of antler, the handle is of wood perhaps three or four feet long. Kiviuk tiñmiak-paum (down of an eagle) usually from under the eagle's tail, is used for an annroak on these spears, tied where the blade is lashed on to the handle. Tox-rumiutak (black lead) is used to make a black ring around the spear handle just above the head.

Two men were stationed beyond the corral to try to drive the frightened caribou back in a circle to enter again. In

this way a band might be run through several times. The drivers used loud shouts, etc. Dogs were never brought near till the killing was done.

Nakkak is the name of the upright that holds a snare up; niggak is the snare. The lower edge of a snare should be on a level with a caribou's knees.

Igariak is the river; mayoriak is the rise from the river to the savriuk or ridge at the entrance. The men who have hidden behind the willows start shooting with bows if caribou do not break out at once. Kifiaktak, an Ootukagmiut who often has used a kañerak says he has seen some double all over and treble at sides or even treble all over, the snares. (According to diary entry for July 3, 1912.)

Smythe. A steel knife might be used thereafter and generally or always was. Mr. Brower thought this was because flint was better for ripping than steel.

Beliefs. The a(g)orak was a charm, generally or always of speckled granite, resembling somewhat the weight of a steelyard. It was suspended from the roof and hung over the kattak about four feet above it. It protected all in the house from illness and probably from other spiritual visitors. If the owner's friends or relatives got sick, he often loaned the stone which in that case, as also if people in the owner's house did get sick in spite of its keeping the door, was used to tap the ailing parts lightly. This was done by anyone at all, not necessarily by a shaman, usually by a relative of the sick. This process "cured in some cases and failed in others."

In one case when Alalik was young she knew of an a(g)orak being used to commit theft. A great Cape Smythe shaman performed an incantation at night in the dark days of winter. He then dropped the a(g)orak with its attached ugrug thong (about four feet long) down through the kattak. After some time the stone came up of its own accord through the kattak, dragging after it a sealskin three quarters full of mûktûk. It had gone to Point Barrow, entered a storage box made of blocks of ice, had tied itself to one of the blubber bags and dragged it to Cape Smythe. Everyone in the dance house had feasted on the blubber and it was all eaten up except a small bit of the first piece taken out of the bag. This was pared off by the shaman and tossed down through the kattak, whereupon it went to Point Barrow and turned itself into a blubber bag in the ice chest from which it had come. The duplication of bags was perfect and no traces of the opening of the ice-box could be seen so the Barrow people suspected nothing.

Some time later, however, the story got to Point Barrow. A seance was then held, a shaman was tied in the ordinary spirit-flight fashion, except that his arms were made to meet at the elbows while his hands were as far apart as possible and held at an angle of about 45° with the body. The shaman then flew to Cape Smythe and returned with the angle between his arms and body filled with tobacco. (Siberian leaf). Alalik does not remember if anyone at Cape Smythe missed any tobacco.

The anña(k) was a perforated sandstone ball of nearly the same size and shape as the a(g)orak. It was heated and then applied, as hot as could be borne, to the ailing parts. It was used only "when the bones were ailing" and had no power to keep spirits out of a house, such as the a(g)orak had, nor was patting the sick part with it of curative value unless it were heated.

*July 3.* Cement for fastening beads on tutaks (Alalik says) was made of a mixture of kogliak (spruce gum) and ipi<sup>r</sup> or tutuñ (Cape Smythe forms; uak, Point Hope form; puya, Oturk. form). This (ipi<sup>r</sup>) was the dirt of a

man's hand which had gathered on a man's knife handle, especially on a form known as *yankakalirk iglutolik*, the first being its real proper name.

*July 4.* Whaling Practices. A special instrument, the *kiliokton* (used also for other things) was used by whalers while on the ice for scraping *mũktũk* or blubber before eating. Ordinarily the knife one ate with might be used for this purpose, but if a knife were used on the ice the float lines would get tangled and the whale would break away from the "poks" (*avatakpait*). *Sallin* was another name for the *kiliokton*, perhaps a more comprehensive word, cf. Mackenzie *sallumaga*, he cleans it.

Starvation. Starvation is known to have taken place at Cape Smythe several times. One time (perhaps the last) was after McGuire wintered at Barrow when a man who lived some years after Brower came to Cape Smythe, accompanied his father inland and was present at the killing of a band of fifteen musk-oxen, the last killed near Cape Smythe. When the news of the killing spread, many starving people went out from Cape Smythe and Point Barrow to feed on the musk-oxen. This was in winter, probably towards spring.

Reverence for Dead. Reverence for dead in the attenuated sense in which we have it is of course almost unknown among the Eskimo, but taboos in some cases apply. Still, at Cape Smythe, all wood from graves has been burned, all relics brought home and sold, and one man helped Mellhenny cut off the head of a recently "buried" body. People now kick skulls about with their feet, and Mr. Brower tells me he has over twenty-five years ago seen a large crowd at Point Hope using a skull as a target for rifle practice; he joined in this shooting.

Nets for Birds and Animals. One purchase today was a ptarmigan net made by an Ootukarmiut man, *Anñiak*, who died on the Colville nine years ago. He had had the net for years, so it is no doubt considerably over fifteen years old. Ptarmigan are driven into this sort of a net and picked out at once. This net is called *põ(r)oasiak*. A *põ(r)ok* is a larger net for any sort of fox or for rabbits. If used for foxes the hunter sets the net in a horseshoe around a bait, and watches himself at night from a snow hut. When the fox has entered the enclosure the hunter rushes out and the frightened fox runs into the net. He must be killed at once before he bites the net much. For rabbits the net may be set nearly straight and the animals are driven in; they too must be picked out at once. One man usually flanks the net at each end while others drive. This applies to bush rabbits.

Beads. The most expensive beads known to the Eskimo of this district were, in the order named (Ootukarmiut dialect) *suñaurakpũk*, *kumaroyuak*, and *ax<sup>a</sup>valuak*. The *suñaurakpuk* may be turquoise; I have bought seven of them with *tutaks*. The next [called *syoravala'* (or *-la*) by Cape Smythe]

is probably a manufactured bead, and so is the ax<sup>a</sup>valuak (called oksroaktak by Cape Smythe).

*July 5.* Names. Alalik calls her son Gusi<sup>r</sup>k, "Apa" (I cannot hear it Apañ). Mr. Brower says that he has noticed, though he never tried to explain to himself, that almost every person calls some younger one "father" or "mother," irrespective of the sex of child.

Colville Pepole. Aña(k) tells: This past winter (1911-12) there were no people anywhere on the Colville so far as he knows except at the three places where we saw them in 1908-9 at Itkillikpa (mouth of the Itkillik), Tueraurak, about two miles down stream on the east side from Itkillikpa, and where Attoakotak then lived across the Kupik from the mouth of the creek called Kugaurak (a creek five or eight yards wide), up stream three or four miles on the main river from Itkillikpa. Altogether there are eight families at these three places: Attoakotak, Aine<sup>u</sup>rak, Ax<sup>s</sup>eatak, Nuta<sup>r</sup>k-sēruak, Katairuarak, Alak, Kunagrak who lived on Smith Bay in 1908-9, and Tunña.

Towing Whales. Walrus and whale harpoons were in the old times used to furnish all the towing power in towing whales to the floe. Seal harpoons were too small.

Beliefs. When Mr. Brower first lived at Cape Smythe, wolf pups were often raised by hand. When their fur became good they were killed with flint-pointed arrows made for the purpose. The bow was then out of use for hunting generally, i. e., except by boys or for ptarmigan in an emergency.

Sea animals were given a drink by both Cape Smythe inlanders who hunted on sea and Point Hope people (symposium of both tribes and several others agreed to this today). Cape Smythe people only ones who gave drink also to caribou. Behind the lamp in the house was a stand (sort of a crane) — called paugusirk from which hung suspended by a strip of whalebone a small bucket of wood or whalebone called pirktagaurak. This always had water in it. The water was poured into a seal's mouth. When a whale was killed the bucket was fetched from the umialik's (killer's, owner of first boat to strike) house and poured on the whale's nose, not into his mouth or blowhole. At Cape Smythe and probably in most other coast communities, blubber was rubbed on caribou's hoofs and small pieces or a few drops of oil were put into their ears.

Coloring Person and Objects. The coloring matter used at Cape Smythe was plumbago called toxrumiutak (Oturkarmiut dialect). The practice applies at Cape Smythe as well. This was ground on a piece of "flint" (aunmark) called agiārviā. Stripes were made with this on the faces of whalers and their wives. There were different designs for men and women but apparently no set ones. Informant could give no coherent

account, or would not; telling these things many feel as our ancestors probably did about confessing witchcraft.

**Bows.** A komiktak was a small bow that could be hidden inside one's coat. It had small arrows to match it and was used for murders. The bow could be pulled from under one's coat and the arrow shot into a man's back if it were turned but for a moment. Generally the arrows had a peculiarly shaped flint head.

**Whaling Charms.** To prevent a whale from sinking there were many song spells, very nearly each boat owner had his own which few others or none knew. Another powerful agent to keep a whale from sinking was an avatakpûk made from the skin of an unborn common seal or ugrug. Into each of the fore-flippers of this avatakpûk should be lashed the first of the phalangeal bones of a man's hand. These are easily found in graveyards. If this sort of an avatakpûk got attached to a whale along with a large number of other floats he would not sink (Alalik).

*July 6.* **Marking Property.** Nallikam nallunaiyutaña, the mark of Nal., adopted father of Panniulak (both Killirmiut) appears on the handle of a *titalirk* hook bought today. There are three diagonal marks called kipuak and one titirak. One would describe any article marked by such a mark kipuanik piñah<sup>s</sup>unik titiramiglu pinah<sup>s</sup>unik nallunaitkotaxane<sup>f</sup>ksok (Killirk dialect).

**Titalirk** hooks may be baited by any sort of meat or fish. They are used as set hooks (kagrok).

**Commerce.** Kivianna, husband of Kittegaryuit woman Panniurak (yak), says that when in winter or summer the Utkiamigniut went to Point Hope they usually had tobacco-getting in view chiefly. They sold skins of wolf, wolverine, red fox, caribou, never white foxes as these were used for clothes at home occasionally. They bought tobacco, copper articles, and brass articles, e. g., copper thimbles, hooks, and bracelets (tallirak), iron knives, copper and brass pots, etc. Yankakali [if home made — gaukak (kan) were whaling shades bought from Siberia, kotlit.] If a boat came to Cape Smythe or went to Point Hope it would winter. Sleds would make a round trip; sleds seldom came to Cape Smythe. It was want of tobacco sent Cape Smythe people west. Double-edged iron knives came from west also.

**Itarrat.** Itarrat, the last bone of a bowhead whale was tied by a stout pendant to the head skin of a wolf. This was hidden on the cache (igirrak) all the year except during whaling, when it was brought out and suspended from the framework inside the stern of the boat. There were as many itarrat as the men had killed whales (the boat owners).

**Beliefs.** At Point Barrow "long ago" two men fought. They were not



shamans. One was armed with a double-edged copper knife (called simply *gluktolik*), the other with a double-edged knife of polar bear marrow bone (*Koksokpinirk'* of marrow tibia). The heat of their anger was such that when the copper knife entered the other's body making flesh wounds the heat softened the blade and it began to bend and to refuse to penetrate the man's flesh; the bone knife did not bend with the heat so the one who wielded it was victorious. After that those who wanted to kill a man preferred a knife of polar bear bone.

**Snowhouse Model.** Bought a model of a snowhouse with a *takusium*. The pole is long enough so dogs cannot get the lowest of the suspended things. There were on the string feathers of eagle, hawk, raven, etc.



Fig. 95 (60.1-2891a-b). The Hoop Game, Upper Colville River. Length, 32 cm.

*Kaiysalugak* is the larger hoop, *itirkorak* is the smaller. The counters are *nappaikkat*. *Nauligak* is the forked spear; *kannautik* is the fork. They should be so long they cannot get through the big hoop; *kannautailak* is the one without fork. The former one may be thrown either end, first. *Kaiysalugaktut* is playing this game (*Kaiv-gaiv*). Either spear may be used on either hoop. Each man may have one spear only or one spear of each, as he likes. Men and boys and unmarried women if they liked took part. The crowd was evenly divided in two groups about twenty-five yards apart. The large hoop was a foot or over in diameter, the smaller about four inches. The people of one party rolled these one after the other (the big first); those of the other tried to spear both at about three to five yards as they passed. For each hoop speared, the tally was one; there was no added credit for two spears through one hoop and no more for spearing little than big hoop. The counters were of an indefinite number, but were divided evenly in two piles. Winners took one from rollers' heap for each hoop speared. The game was over when one heap was exhausted, but another game was soon started. Game never played in summer, chiefly in dark days and thence till spring.

according to owner of house. There were also gifts. The *tatkoa* of the caribou used the feathers for charms and made more materialistic use of the other gifts which are in order from top of pole down: *akluna* (common seal), *nelluakartuñaksrak*, *kitkoerksak*, *artuñaksrok*, *oxsrogon*, *toxrogmiutak*. Seller thinks, that the *takusium* is not used except in hunting with *karrigisak*. It is taken down before camp moving only after all marrow bones are cracked. *Mañorvia* is the block of snow in which the *takusium* is planted on top the roof. Feather on end of snow probe always raven for Cape Smythe. *Talmonan* (wife) must wear a special type of a bead tied with thong in wrist during deer season. Besides this each family had rules peculiar to itself.

Arrows at Cape Smythe and among *Oturkarmiut* (and elsewhere proba-

bly inland) were of the length of the head plus the distance of the sternum to the second thumb joint of the left hand held in the position of shooting horizontally.

*July 26.* Ornaments. Some Cape Smythe men wore copper forehead pendants where most wore *anna<sup>u</sup>k*. Those who had copper on forehead of head band had copper fragment also in wrist shield.

*July 28.* Snares. Iñutak snares for hawks, owls, etc., often had their sides tied with grass blades to each other and to the forks of the stick to hold them in place. (*Kañianirk*, Upper Kuvúk, etc.)

Taboos. Mr. Brower says for a long time after 1884 no Eskimo would scrape deerskins for clothes before first snow fell. After sun came back no one would scrape them who intended to have anything to do with whaling next season.

Sealing Harpoons. Sealing harpoons among the Oturkarmiut for common seals occasionally had lines of caribou leg sinew braided round but usually had ugrug thongs. For ugrug and larger seal, ugrug thongs always used.

Sealing. Along the coast from Cape Smythe to Point Hope (including Oturkarmiut) and probably elsewhere, seals were not seldom caught with the hand by the flipper and stabbed with knives on ice in spring.

Knives at Cape Smythe. Attoktuak ("Shoofly") tells: Large copper knives were always so far as he knows, double-edged. Most of them had a midrib but some had a groove. Many of the double-edged iron knives had notches out of the blades, like some from Hudson Bay (Boas). He never saw a notch out of one side only; they were always symmetrically arranged and either two or four. He does not know what use these notches were and never heard anyone say they had any use. Such a knife was *iglu(k)tolik kiggalik*. A knife with a groove along the center of the blade was *iglu(k)tolik korlualik*. It was said that when a man was stabbed with such a knife the blood flowed out along the groove. This sort of knife caused more bleeding than a common one. Most double-edged knives in his time (since about 1860) came from the east (Mackenzie? or Colville?). The grooved ones he thinks came both from E. and W., probably therefore from Kotzebue via Colville and via Point Hope or overland from *Kañianirk*. Notched and unnotched (all but grooved) double-edged knives Attoktuak thinks came from *Kopuñmiut*.

Kalu Net. Was set in small creeks, flanked by willows or rocks. If there were two men, one drove the fish by throwing stones or whipping the creek with a willow, the other jerked up the net by the handle after fish had entered. One man often managed both driving and pulling up.

Names. A Noatak man, Negrun, got a *yaukukalirk* (-guga-), a large

knife, shaped like a Wilson skinning knife, of soft iron. Because the knife was a large one, better than other peoples' knives, a knife to be proud of, he always carried it in his hand. For this he was nicknamed Savikpallik. This soon became the only name he was called. About the time he died the present Savikpallik (a Noatak man at Cape Smythe, over forty years old, perhaps sixty) was born. He was named Negrún by his mother and was so called while she lived, but on her death people began to call him Savikpallik.

*July 28.* Stone Cutting. Among Noatagmiut (and most other tribes?) greenstone kuñirk bowls were drilled with flint and the top of the bowl made saucer-shaped and smooth with a round-headed drill of cottonwood and sand, some did not use sand, it is said. Attoktuak (of Point Barrow) says jade was cut into long strips with a sharp cottonwood stick the edge of which was occasionally dipped in water and then in dry sand. Noatak people say they never saw or heard of this method. Thin slabs of flint were used, the edge dipped now and then in water and then in dry sand. Holes in jade were drilled with flint drills without sand. Slabs of jade were smoothed by rubbing on a flat stone (sandstone) covered with sand. This smoothing practised inland and at Barrow, many of all tribes still living who saw jade worked.

*July 29.* Dippers. Dippers of sheep horn were made at Barrow in Mr. Brower's time. The horn was cut along one edge, boiled and gouged out, then pressed on a rounded post end turning it inside out, the post forming a mould for the bowl of the dipper.

*August 1.* Excavations at Birnirk. I dug into one mound at Birnirk. This mound is about twelve feet high and 126 paces in circumference at the base. It seems there are five house ruins indicated on top of this one mound. We dug in from the E. side along the alleyway of a house. No timbers were found though we finally got about three feet down; the alley was indicated merely by a depression in the sward at the surface, after one got below the sod nothing indicated an alleyway. To the right in the angle between the alley and the house right side of our coming out of the house, we found numerous fire-cracked stones, showing that the wooden igavaun was used for cooking here as at Okat, Parry Peninsula, or else hot stones were dropped in the clay pots. We do not know therefore if any wood was used in the framework of the houses, but whalebones were, especially scalp bones. We uncovered the spineward end of one which seemed to have formed a sort of post in the angle between house wall and alley wall to the right of one going out. Fish nets as shown by our digging and that of others, are absent. There are no sinkers, no floats, no mesh-sizers, and no remnants of nets. Pipes of all kinds (tobacco) are entirely absent; only one labret was found,

a stone one almost exact duplicate of those in the Peabody Museum found by me at Flaxman Island in 1907. Metals are quite absent.

Seal harpoon heads of two types absent from Cape Smythe and Point Barrow collections have been found. Pottery is abundant; fragments of potstone are very rare. Firestones (iron pyrites) and firedrills have been found. Slate and "flint" implements both fairly numerous, etc.

Tradition Vindicated. I was told "as matter of common knowledge" by various Cape Smythe and Point Barrow people that Birnirk was inhabited before either Utkiavik or Nuvuk were settled. At present the land at Birnirk is low and mostly covered with ponds. At one time, it is said, the land was higher and when the water began to rise and turn the village site into a swamp, the inhabitants gradually moved off and settled Cape Smythe and Nuvuk. Another story says that this is in a measure true, but that Nuvuk is a far older settlement than Utkiavik. There was a settlement at Uallikpa (called by whites Wallapai) contemporaneous with Birnirk I was told. This has been substantiated by the finding there of some harpoon heads of the Birnirk type. It is said that Point Barrow was once three or four miles longer than now, curving well to the E. and that the Kulugruak (Meade River) had its mouth between the point and Dead Man's Island. When the water rose so as to make Birnirk uninhabitable the delta of the Kulugruak turned to a lake (lagoon), it is said. Point Barrow since has been gradually breaking away so that the present village of Point Barrow is several miles farther S. than it was while Birnirk was yet inhabited. This is confirmed, in so far as can be by the finding of metal and implements of a recent type as deep down as Point Barrow diggings have gone.

Date of Cape Smythe village. Seeing net tools and pipes seem to go as deep as specimens are found at Cape Smythe, it is likely that it was founded about the time nets and pipes came in (since no net or pipe signs have been found at Barrow), we can date the village approximately. Nets came to Kittegaryuit not over 120 years ago at the most and never got to Langton Bay which was abandoned shortly before Richardson came (about 1840 perhaps), we get some idea of Cape Smythe foundation and abandonment of Birnirk.

Pottery and baskets are older than nets, pipes, or labrets in history of the Eskimo.

Absence of potstone fragments should be noted.

Whaling Ceremonies. I bought yesterday a piece of char which is said to be from a "sacrifice spot." Seller said that at Cape Smythe after whaling was over and after appropriate ceremonies in the dance house the whalerman took small pieces cut off the tips of the fins and tips of noses of whales killed, took them (going alone and secretly) inland and burned them with aid of small sticks.

Kitchens. Dr. Marsh has been told by Cape Smythe people that kitchens were invariably on one's left going out through the alley.

Birnirk. Houses. Seem to have faced in all directions. The one we dug faced east.

*August 2.* Edible earth. Bought tonight a tin full of "edible clay" from a cutbank on the Kañiani<sup>7</sup>k part of the Colville (S. bank) between the Killirk and Ninñolik branches. The specimen is in flakes and powder. Seller considered the clay a true food but says it is eaten in large quantities only at times of scarcity or when travelers run out of food. Many eat a little now and then, seller (Kañianirmiut woman) says she puts a little on her tongue almost every day and lets it soak up there till soft. She gets presents every year now of similar stuff up the coast but the sample sold me has been treasured for years. When clay is to be used in earnest as food, it should be let soak in water over night or longer; it then disintegrates and swells into a thick paste, seems to increase in bulk rather more than rice does in boiling. When about to be eaten this paste is mixed up in a little more water to make it thinner and then it is poured into hot water in a pot and cooked "like flour soup," i. e., brought to a boil. "This is good food if one has oil with it; otherwise it constipates you." The seller, however, considers the clay to be rich in a tasteless and smell-less oil which she says the old men say is old whale oil that soaked down the cutbank from whales whose bones (lower upper jaws shoulder blades, ribs, backbone, etc.) are seen near the top of the cutbank far above.

Mr. Brower says there is a "mine" of the same stuff west (up coast) of the Corwin cliff near the Cape Lisburne coal mine. A creek comes down near the house originally built there. One or two hundred yards up this creek from the beach and ten or twenty yards south of the creek is a hole a foot or two across. This is filled with an oily paste which natives eat. A pole may be pushed down into this hole at any time ten or twenty feet. It does not freeze in winter.

*August 8.* Customs. Teeth of old men were worn as wrist charms (taiyasiak) or as pendants around neck (oyamit koak), Cape Smythe and most other tribes.

*August 11.* Nets. Fish nets of spruce bark, twisted, were in use on the Kuvúk when Mr. Brower was there in the early eighties.

Walrus Harpoons. The massive okumailuta of a walrus spear was always made of the jawbone of a walrus and the line that held the harpoon point was passed through a nerve hold in the okumailuta. This of course does not apply to the pigleriak but only to the una<sup>7</sup>kpuk.

RD 14.71

BN









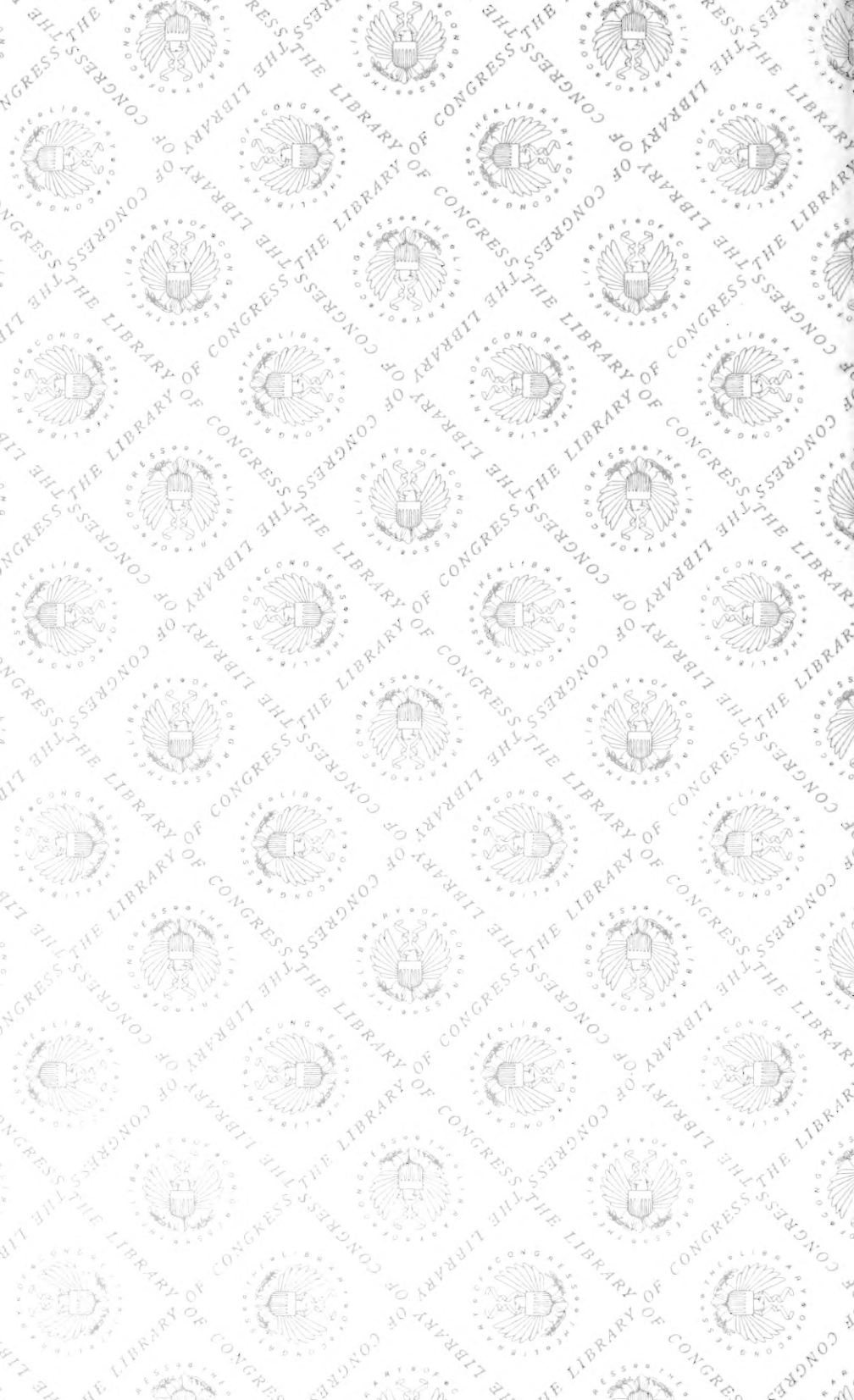



**DOBBS BROS.**  
LIBRARY BINDING

**ST. AUGUSTINE**  
FLA.





0 010 743 803 8

