

FOR THE PEOPLE  
FOR EDVCATION  
FOR SCIENCE

LIBRARY  
OF  
THE AMERICAN MUSEUM  
OF  
NATURAL HISTORY





# The Edinburgh Medical Series

*General Editor*—JOHN D. COMRIE,  
M.A., B.Sc., M.D., F.R.C.P.E.

## THE STRUCTURE OF THE FOWL

## AGENTS

- AMERICA . . THE MACMILLAN COMPANY  
64 & 66 FIFTH AVENUE, NEW YORK
- AUSTRALASIA THE OXFORD UNIVERSITY PRESS  
205 FLINDERS LANE, MELBOURNE
- CANADA . . THE MACMILLAN COMPANY OF CANADA, LTD.  
ST. MARTIN'S HOUSE, 70 BOND STREET, TORONTO
- INDIA . . . MACMILLAN & COMPANY, LTD.  
MACMILLAN BUILDING, BOMBAY  
309 BOW BAZAAR STREET, CALCUTTA

# THE STRUCTURE OF THE FOWL

BY

O. CHARNOCK BRADLEY

M.D., D.Sc., M.R.C.V.S.

PRINCIPAL OF THE ROYAL (DICK) VETERINARY COLLEGE, EDINBURGH

CONTAINING 73 ILLUSTRATIONS

A. & C. BLACK, LTD.

4, 5, & 6 SOHO SQUARE, LONDON, W.

1915





## P R E F A C E

STATED briefly, the primary object in view in the preparation of the following pages has been the production of a concise and not too elaborate account of naked-eye and microscopic structure which, it is hoped, may be of use to those who have to deal with the fowl in health and disease. It is a truism that to the student of avian and comparative pathology a knowledge of normal structure is essential to the appreciation of changes resulting from disease. And it is admitted that the student of scientific agriculture should know something of the build of the various animal machines with which he is concerned.

It is also hoped that the student of zoology and comparative anatomy may find herein a useful introduction to avian anatomy and embryology.

The main difficulty experienced by the writer has been the determination of what to

include and what to leave out, having regard to the fact that a student's manual was planned and not a specialist's book of reference. In deciding the scope of the book, much valuable help has been received in the form of suggestions made by friends of considerable teaching experience. To these and to Dr. John D. Comrie, the General Editor of the Series, I tender my thanks, and desire also to express my appreciation of the unfailing courtesy of the publishers.

O. CHARNOCK BRADLEY.

EDINBURGH, 1915.

# CONTENTS

	PAGE
I. INTRODUCTORY . . . . .	1
II. THE SKELETON . . . . .	9
III. THE MUSCULAR SYSTEM . . . . .	35
IV. THE DIGESTIVE SYSTEM . . . . .	40
V. THE RESPIRATORY ORGANS . . . . .	57
VI. THE URINARY ORGANS . . . . .	64
VII. THE REPRODUCTIVE ORGANS . . . . .	66
VIII. THE CIRCULATORY SYSTEM . . . . .	79
IX. THE NERVOUS SYSTEM . . . . .	89
X. THE EYE AND ITS APPENDAGES . . . . .	97
XI. THE EAR . . . . .	101
XII. THE SKIN AND ITS APPENDAGES . . . . .	104
XIII. DEVELOPMENT OF THE CHICK . . . . .	110
INDEX . . . . .	149

## LIST OF ILLUSTRATIONS

	PAGE
1. The Skeleton of the Fowl . . . . .	xii
2. Lateral View of the Sternum . . . . .	14
3. Skull, Lateral View . . . . .	16
4. Base of the Skull . . . . .	17
5. Hyoid Bone . . . . .	23
6. Skeleton of the Forearm and Manus . . . . .	28
7. Left Hip-Bone . . . . .	31
8. Right Tibia and Fibula . . . . .	33
9. Right Metatarsus . . . . .	34
10. Roof of Mouth and Pharynx . . . . .	41
11. Floor of Mouth and Pharynx . . . . .	41
12. Thoracic and Abdominal Viscera (Semi-diagrammatic) . . . . .	44
13. Section of Œsophagus . . . . . <i>Facing</i>	44
14. Section of Crop . . . . . „	44
15. Crop, Stomach, and Duodenum . . . . .	46
16. Section of Glandular Stomach . . . . . <i>Facing</i>	48
17. Mucous Membrane of Glandular Stomach „	48
18. Tubular Glands in the Submucous Tissue of the Glandular Stomach . . . . . <i>Facing</i>	49
19. Transverse Section of a Tubular Gland of the Stomach . . . . . <i>Facing</i>	49
20. Section (Naked-eye) of Gizzard . . . . . „	51
21. Section of Mucous Membrane of Gizzard „	51

# LIST OF ILLUSTRATIONS

ix

	PAGE
22. Cast of Abdominal Organs hardened <i>in situ</i> and viewed from the Ventral Aspect . . . . . <i>Facing</i>	51
23. The Cæca . . . . . „	52
24. Section of Small Intestine . . . . . „	52
25. Epithelium of Intestine . . . . . „	52
26. Section of Fold of Mucous Membrane in the Cæcum . . . . . <i>Facing</i>	54
27. Section of Liver of Young Chick . . . . . „	54
28. Section of Pancreas . . . . . „	54
29. Transverse Section of one of the Larger Ducts within the Pancreas . . . . . <i>Facing</i>	54
30. Section of the Trachea . . . . . „	54
31. Section of Lung . . . . . „	62
32. Section of Kidney under Low Magnification „	62
33. Cortical Substance of Kidney . . . . . „	64
34. Transverse Section of Straight Tubules of Kidney . . . . . <i>Facing</i>	64
35. Urinary and Reproductive Organs of the Male . . . . . <i>Facing</i>	65
36. Section of Testis . . . . . „	69
37. Diagrammatic Representation of the Different Cells of a Seminiferous Tubule . . . . . <i>Facing</i>	69
38. Section of Deferent Duct . . . . . „	69
39. Cast of Reproductive Organs of Hen during Laying Period . . . . . <i>Facing</i>	70
40. Section of Ovary . . . . . „	71
41. Section of Wall of Follicle containing an Ovum . . . . . <i>Facing</i>	71
42. Diagram of the Parts of a Fully-formed Egg .	72
43. Section of Infundibulum of Oviduct . <i>Facing</i>	71
44. Section of Albumen-secreting Part of Oviduct under Low Magnification . . . . . <i>Facing</i>	76

# X THE STRUCTURE OF THE FOWL

	PAGE
45. Section of Albumen-secreting Part of Oviduct showing the Opening of a Tubular Gland <i>Facing</i>	76
46. Epithelium from Albumen - secreting Part of Oviduct showing Ciliated Columnar and Goblet Cells . . . . . <i>Facing</i>	76
47. Diagram of the Chief Arteries . . . . .	82
48. Diagram of Chief Veins . . . . .	84
49. Brain seen from the Side . . . . .	91
50. Section through the Eyeball . . . . .	99
51. Section through Coats of the Eyeball at the Exit of the Optic Nerve, under Low Magnifica- tion . . . . . <i>Facing</i>	76
52. Diagram of the Parts of a Feather . . . . .	105
53. Diagram of Three Stages in the Growth of a Feather . . . . . <i>Facing</i>	108
54. Surface View of the Blastoderm showing the Lines of Segmentation . . . . .	114
55. Diagram of the Blastoderm within the Egg about the End of the First Day of Incubation . . . . .	117
56. Primitive Streak and its Surroundings . . . . .	118
57. Transverse Section through the Primitive Streak . . . . . <i>Facing</i>	108
58. Transverse Section through the Neural Groove <i>Facing</i>	118
59. Transverse Section of Embryo . . . . . „	118
60, 61, 62. Diagrams of Transverse Sections of Blastoderm to illustrate Extension and Splitting of Mesoderm . . . . . <i>Facing</i>	120
63, 64. Diagrams of Transverse Sections to illustrate the Separation of the Embryo from the rest of the Blastoderm . . . . . <i>Facing</i>	120

# LIST OF ILLUSTRATIONS

xi

PAGE

65. Diagram of Longitudinal Section to illustrate the Separation of the Embryo . . . . . <i>Facing</i>	120
66. Diagram showing the Mode of Development of the Embryonic Membranes. Early Stage .	124
67. Diagram showing the Mode of Development of the Embryonic Membranes. About Fourth Day . . . . .	125
68. Diagram showing the Mode of Development of the Embryonic Membranes. About Tenth Day . . . . .	126
69. Longitudinal Section of Tail End of Embryo showing Early Development of Allantois <i>Facing</i>	130
70. Embryonic Central Nervous System . . . . . „	130
71. Embryo after 4 Days 8 Hours' Incubation .	145
72. Embryo at the Seventh Day of Incubation .	145
73. Embryo at the Eighth Day of Incubation .	145

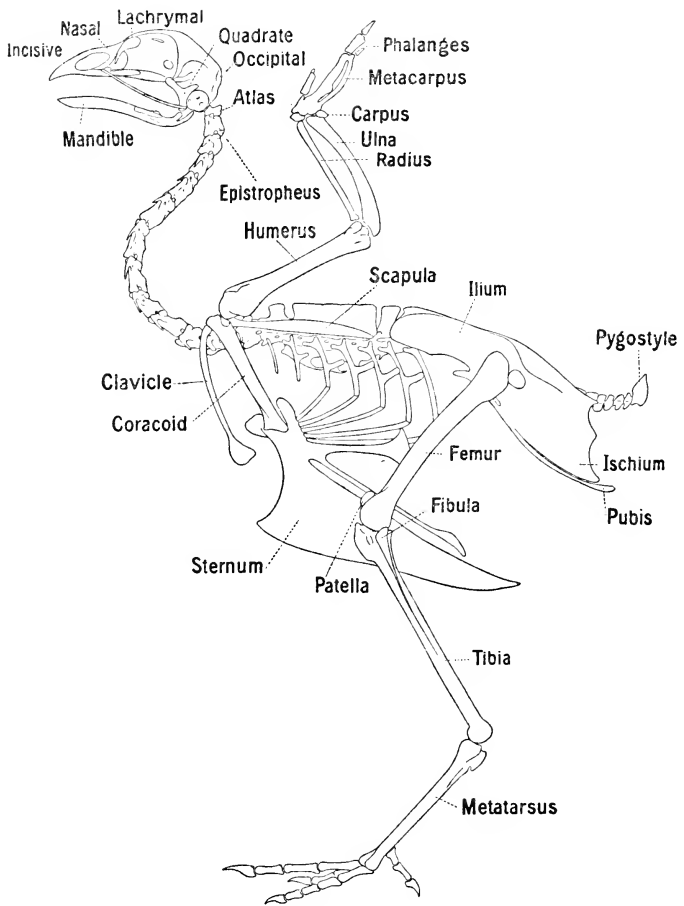

FIG. 1.—The Skeleton of the Fowl.



# THE STRUCTURE OF THE FOWL

## I

### INTRODUCTORY

THE zoological position of the class *Aves*, to which the fowl belongs, may be indicated briefly as follows :—

- I. *Invertebrates* ; animals without a backbone.
- II. *Vertebrates* ; animals possessed of a backbone or vertebral column.
  - (1) Cyclostomata, with no true jaws,  
*e.g.* the hag-fish and the lamprey.
  - (2) Fishes.
  - (3) Amphibians.
  - (4) Reptiles.
  - (5) Birds.
  - (6) Mammals.

It is generally admitted that birds may be divided in the first place into two major groups.

## 2 THE STRUCTURE OF THE FOWL

(1) The *Archæornithes* (primitive birds) contain only one known member, the fossil *Archæopteryx*. (2) The *Neornithes* (modern birds) are distinguished by shortness of tail and fusion of the metacarpal bones of the palm, and may be divided as follows :—

- (a) *Ratitæ*. Running birds with rudimentary wings and a flat breast-bone, *e.g.* the ostriches.
- (b) *Odontolcæ*. Extinct fossil birds with numerous teeth carried in long jaws, *e.g.* *Hesperornis*.
- (c) *Carinatae*. Flying birds with well-developed wings and a breast-bone provided with a keel to which the powerful muscles of flight are attached. It is in this division that the domestic fowl is included.

Structurally, birds share with mammals the distinction of being the most highly specialised of vertebrates. Many of their modifications are adaptations for flight. The fore-limb is changed into a wing on which are large feathers capable of offering a large elastic surface to the resistance of the air. A wing-membrane stretching between the arm and the forearm increases the area of this surface. In order

to render the limb more efficient as an organ of flight, the bones and musculature have undergone a change. The manus or hand has been reduced by the disappearance of digits and the consolidation of the metacarpus. The clavicles are joined together, and the coracoid is large to give firmness to the shoulder-girdle in order that it may serve as a substantial basis for the wing. Reduction in the manus, combined with comparative simplicity in the movements of the greater part of the limb, has removed the necessity for large and strong muscles in the forearm. The muscles of the pectoral region, on the contrary, need to be powerful, and an extensive surface for their attachment is provided by the presence of a deep keel on the sternum. In order that a firm foundation may be given to the wing, there has been extensive consolidation of the vertebral column.

With the capacity for flight must be associated certain peculiarities of the respiratory organs. The air-passages within the lungs are connected with large, thin-walled air-sacs in the thorax and abdomen, these being continuous with air-containing cavities within most of the bones of the skeleton. The lungs

#### 4 THE STRUCTURE OF THE FOWL

themselves are relatively small, firmly adherent to the wall of the chest, and, when compared with the lungs of mammals, remarkable in the possession of little elasticity. That important mammalian muscle of respiration, the diaphragm, moreover, is strikingly rudimentary. These peculiarities render the possession of air-sacs a necessity; not, as has been supposed, to render the body lighter, but to subserve the respiratory function.

At the same time it must be pointed out that the position of the lungs and air-sacs has a marked influence upon the position of the centre of gravity of the body, and thus contributes materially to the bird's ability to maintain its balance in the air. The light lungs and air-sacs are placed in the dorsal part of the body, while the heavy digestive organs and pectoral muscles are ventral in position.

The fore-limbs being useless for the purpose of walking, the bird, when on the ground, is forced to assume the upright position. The joint between the pelvis and the thigh is therefore so placed as to maintain the balance of the body on the two hinder limbs. There is considerable elongation of the ilium, and an extensive fusion of it to the vertebral column.

This provides a firm basis for the limb, which is all the more necessary since the two hip-bones are not united in the middle line ventrally. The tarsal joint is simplified and the metatarsal bones are united into a single rod.

The digestive apparatus also affords examples of purposive modification. No existing bird possesses teeth, their place being taken by the horny sheaths covering the jaws. Birds like the fowl have a dilatation of the œsophagus into which food is received, and in which it undergoes the preparatory maceration rendered necessary because of the absence of the preliminary process of chewing. The stomach is divided into two parts. Within the walls of the first part is a thick and complicated layer of glands; while the second part has powerful muscular walls and a horny lining in its interior. Here the food is subjected to a grinding process rendered more effective by the presence of hard substances such as small pebbles.

Some of the most important structural peculiarities of the fowl from the economic point of view are to be found in connection with the reproductive organs of the female. During a normal life-time a bird lays a large

## 6 THE STRUCTURE OF THE FOWL

quantity of eggs of considerable size. This means that the maintenance of even one ovary is an expensive affair. The retention of two ovaries would doubtless cost too much; one of them, therefore, dwindles and disappears. Moreover—and possibly this is a better reason—the bird's egg is a large one, and if two ovaries were present and extruded ova at or about the same time, the abdomen would have to be unduly large to contain two fully formed eggs.

The egg is large because it contains within itself enough food-material to support the growing chick until incubation is ended. The egg as it leaves the ovary is of goodly size and contains a considerable quantity of yolk. But more than 50 per cent of the total weight of the fully formed egg is produced by the physiological activity of the oviduct down which it travels on its way from the ovary to the exterior. Owing to its large size the egg could not be laid if the two hip-bones were joined together ventrally. In birds, therefore, there is no pelvic symphysis.

Many other features of avian anatomy—such as the large size of the eye, the single occipital condyle, the right aortic arch—will be revealed during the examination of the

architecture of the fowl. Many anatomical features point to the descent of birds from a reptilian ancestor, from which, it is generally held, mammals have also descended; birds and mammals having followed different lines of evolution in accordance with differences of environmental and physiological demand.

The more immediate ancestry of the domestic fowl is not without its obscurities; but it seems very likely that from *Gallus ferrugineus*, or Jungle-fowl, the domestic fowl had its origin. It must be admitted that this ancestry has not been universally accepted, but available evidence appears to lend greater support to this than to rival views. *Gallus ferrugineus* (or *bankiva*) occurs in northern India, Burma, Cochin China, the Malay Peninsula, Sumatra, the Celebes and Philippines, and some of the islands of the Malay Archipelago (e.g. Timor). The Jungle-fowl resembles the "black-red" game fowl, but carries the tail in a drooping position. Tradition points to Burma as the country in which the fowl was first domesticated. Then it passed eastwards into China about 1400 B.C., and, later, westwards into Persia and thence to Greece.

Its descent from the Jungle-fowl doubtless

## 8 THE STRUCTURE OF THE FOWL

partly accounts for the fact that the domestic fowl, though built on the lines of a flying and not a running bird, does not possess any notable capacity for flight. Haunting the jungle as it does, the wild progenitor of the common fowl makes little more use of its wings than is necessary to allow it to rise from the ground to its perch. Further, the effect of domestication and artificial selection has obviously been in a direction which discourages flight.



## II

### THE SKELETON

FOR descriptive purposes the skeleton may be divided into (1) the axial skeleton and (2) the skeleton of the limbs.

The axial skeleton includes the skull and vertebral column with the ribs and sternum ; while the skeleton of the limbs includes bones which have been characteristically modified in conformity with peculiar physiological requirements related to locomotion.

### THE VERTEBRAL COLUMN

The vertebral column, or back-bone, of the fowl is remarkable for several reasons. That part of it which forms the skeleton of the neck is long and very freely movable ; whereas the rest of it is rigid owing to the extensive fusion which takes place between the bones composing it. Some of the thoracic vertebræ

## 10 THE STRUCTURE OF THE FOWL

are bonily united in order that a firm foundation may be established for the wing. But the most extensive fusion occurs in the lumbar and sacral regions. Here, moreover, the hip-bone, throughout the greater part of its length, is immovably fixed to the vertebral column by a bony union.

Each vertebra consists of a rod-like *body*, surmounted by a *vertebral arch*; these circumscribing a *vertebral foramen* which forms part of the *vertebral canal* of the articulated skeleton. The ends of the body of a vertebra have saddle-shaped surfaces for articulation with adjacent vertebræ. The cranial surface is concave from side to side and convex in a dorso-ventral direction. The caudal surface, naturally, has its curves disposed in the reverse direction. In many vertebræ the ventral aspect of the body carries a median, flattened process. In a typical vertebra the arch is produced dorsally into a *spinous process*, and carries two cranial and two caudal *articular processes* with smooth surfaces for contact with similar processes on neighbouring bones. From each side of a vertebra projects a *transverse process* attaining a considerable length in the thoracic, lumbar, and sacral regions.

The vertebral column may be divided into cervical, thoracic, lumbar, sacral, and coccygeal regions ; but the limits of these are not as well defined as in mammals.

The **cervical vertebræ** (Fig. 1), forming the skeleton of the neck, are thirteen in number. They have long bodies, and, except towards the end of the series, poorly developed spinous processes. The ventral process is of considerable size in the last four or five bones, and an examination of the vertebræ in series will show that the process is produced by the union of projections separated off from the two transverse processes. The transverse processes are connected with the cranial articular processes, and are prolonged by thin, spicular projections (cervical ribs) pointing in a caudal direction. A *transverse foramen* pierces the root of each transverse process, this forming an outstanding characteristic of the cervical vertebræ.

The first cervical vertebra, or **atlas**, differs from all the rest in its small size and its narrow ring-like form. It possesses a deep concavity for articulation with the single occipital condyle of the skull ; and articulates with the second vertebra by three points—a single, convex, ventral surface, and two small lateral areas

## 12 THE STRUCTURE OF THE FOWL

comparable to the caudal articular processes of the other vertebræ.

The second vertebra, or **epistropheus**, is relatively short, and distinguished by the possession of a small process, the *dens*, which, projecting from the cranial end of the body, passes through the ring-like atlas and touches the occipital condyle. The cranial articular processes are small.

**Thoracic Vertebræ.**—The seven thoracic vertebræ of the fowl carry ribs. Each has a strong, but relatively short body, which, except in the case of the last, possesses a well-developed ventral process. Prominent transverse processes have smooth articular surfaces at their extremities. These, with projecting areas on the sides of the bodies of the vertebræ, afford points of attachments for the ribs. The second to the fifth vertebræ are fused together, their spinous and ventral processes being welded into prominent plate-like ridges. Thin bone fills the gaps between the transverse processes. The first and sixth thoracic vertebræ are free, and the seventh is blended with the first lumbar vertebra.

No distinction can be made between the lumbar and sacral vertebræ—about fourteen in

number—since they are merged into one bony mass in which are also incorporated the last thoracic and the first coccygeal vertebræ.<sup>1</sup> The composite bone has, at first, a ridge representing the fused spinous processes, but this disappears about the middle of the bone. On the ventral surface, ridges indicate the position of the transverse processes.

The **coccygeal region** contains five or six bones, of which the last—produced by the union of several vertebræ—is the largest, is known as the *pygostyle*, and forms a foundation for the feathers of the tail.

Of the seven pairs of ribs the first and second, and sometimes the seventh, do not reach the sternum. Each of the other ribs consists of two segments—a vertebral and a sternal. The proximal end of each rib consists of a *head*, separated from the rest of the bone by a *neck*, and a *tubercle*. The head articulates with the body and the tubercle with the transverse process of a vertebra. Most of the ribs—the first and last are excep-

<sup>1</sup> It seems probable that the sacrum is originally composed of two vertebræ only, with which all the lumbar and a considerable proportion of the coccygeal vertebræ subsequently coalesce. The development of this part of the vertebral column of the chick has not received sufficient attention to allow of a definite statement.

## 14 THE STRUCTURE OF THE FOWL

tions—have an *uncinate process* projecting backwards over the outer surface of the next rib and connected therewith by a ligament. The distal end of the sternal segment has an articular eminence which fits into a depression on the edge of the sternum.

The **sternum**, or breast-bone (Fig. 2), may

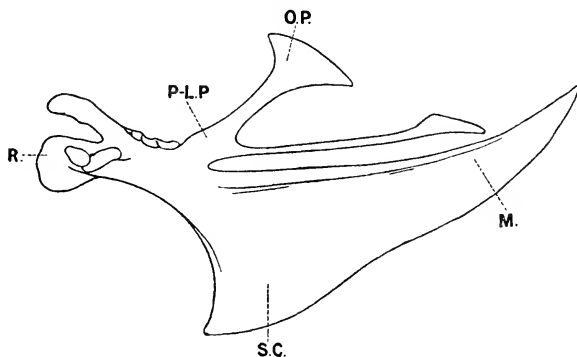

FIG. 2.—Lateral View of the Sternum.

R., rostrum ; P-L.P., posterior lateral process ; O.P., oblique process ;  
M., metasternum ; S.C., sternal crest.

be described as a quadrilateral, curved plate with processes projecting from each angle and from the middle of the cranial and caudal borders. The caudal medial projection or *metasternum* is the longest, and has a tall plate-like ridge—the *sternal crest*—running along its ventral surface. The crest serves the important function of increasing the bony

area for the attachment of the powerful muscles which move the wing. The cranial medial projection or *rostrum* is short, and pierced at its root by an opening from which extend two elongated, saddle-shaped depressions into which the end of the coracoid bones are received.

The plate-like process of bone (the *posterior lateral process*) which projects from the caudal angles of the sternum soon divides into two parts. The shorter of these (the *oblique process*) broadens towards its free end and covers the sternal segments of the last two ribs.

The lateral borders of the sternum are pitted by four or five depressions into which the sternal segments of the ribs are received.

The dorsal or inner surface of the bone is pierced by openings by which the air-sacs communicate with the interior.

### THE SKULL (Figs. 3 and 4)

The presence of large orbits, separated merely by a thin septum formed by the sphenoid and ethmoid bones, permits of ready distinction between the rounded **cranium** and the pointed, conical **face**. The cranial part

## 16 THE STRUCTURE OF THE FOWL

of the skull lodges the brain and contains the organ of hearing, while the facial part, placed in front of the cranium and movably connected therewith, comprises the skeleton of the jaws and the hyoid bone.

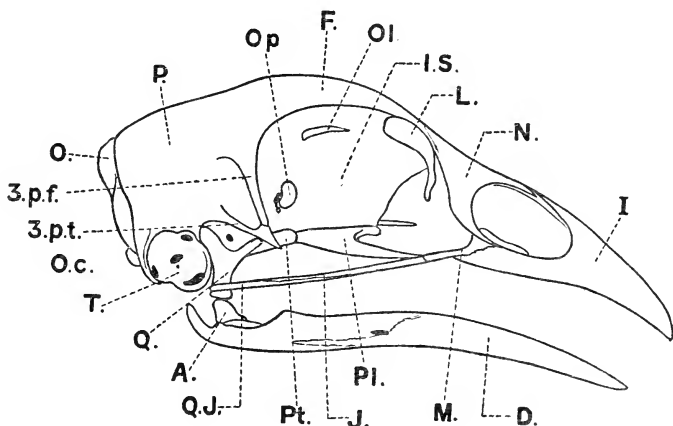

FIG. 3.—Skull, Lateral View.

O., occipital; P., parietal; Op., optic foramen; F., frontal; Ol., olfactory foramen; I.S., interorbital septum; L., lachrymal; N., nasal; I., incisive; Pl., palatine; T., tympanic cavity; Q., quadrate; Q.J., quadrato-jugal; J., Jugal; M., maxilla; Pt., pterygoid; Z.p.f., zygomatic process of frontal; Z.p.t., zygomatic process of temporal; O.c., occipital condyle; A., articular; D., dentary.

Early fusion of the individual bones causes them to lose their independence before the chick leaves the egg. Viewed from the exterior, the cranium conveys the impression that its internal capacity is greater than is actually the case. This is owing to the circumstance that its component bones are formed of two



thin, dense plates, separated by a considerable thickness of bone of a spongy texture. The spaces of the spongy bone contain air derived from the auditive tubes of Eustachius. A very noticeable feature of the skull is the presence of a large, hemispherical *tympanic cavity* on each side of the hinder part of the cranium. The cavity forms the drum of the ear when the soft structures of the head are in position.

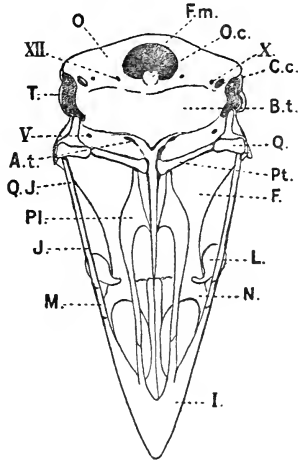

FIG. 4.—Base of the Skull.

### 1. Cranial Bones.—

The **occipital bone** forms the most posterior part of the skull, and originally consists of four parts—a basilar, two lateral, and a squamous

—grouped around a large opening, the *foramen magnum*, by which the cavity of the cranium is placed in communication with the vertebral canal. Immediately below the foramen is a single, rounded *condyle* for articulation with the

F.m., foramen magnum; O.c., occipital condyle; O., occipital; B.t., basitemporal; XII., foramen for hypoglossal nerve; X., foramen for vagus and glossopharyngeal nerves; C.c., carotid canal; T., tympanic cavity; V., foramen for trigeminal nerve; A.t., auditive tube; Q., quadrate; Pt., pterygoid; Q.J., quadrato-jugal; J., jugal; M., maxilla; Pl., palatine; F., frontal; L., lachrymal; N., nasal; I., incisive.

## 18 THE STRUCTURE OF THE FOWL

first cervical vertebra, or atlas. The fact that birds have only one occipital condyle permits of the well-known extensive rotation of the skull on the vertebral column. Each lateral part of the occipital bone is pierced by a common opening leading into the *jugular foramen* and the *carotid canal*.

The roughly triangular **sphenoid bone** forms the greater part of the base of the cranium, and consists of a posterior portion made up of a *body* and a pair of *temporal wings*, and an anterior part represented by a *body* only. On each side of the body there is a slightly projecting, smooth surface for articulation with the pterygoid bone. The two optic nerves leave the cranium by a single opening which represents the two optic foramina of mammals. The common aperture occurs opposite the edge of the interorbital septum by which the two optic nerves are separated immediately on leaving the cranium. It should be remarked that a wide **basi-temporal bone**, developed in membrane, covers a great part of the sphenoid, and forms the broad part of the cranium visible when this is viewed from the ventral aspect.

Filling the interval between the occipital

bone and the frontal bones are a pair of broad, short **parietal bones**. Each **frontal bone** is relatively large, and may be divided into frontal, nasal, and orbital parts. From the lateral limit of the bone springs a strong *zygomatic process* to join the like-named process of the temporal. On each side of the base of the cranium, and connected with the basilar portion of the occipital and the sphenoid, is a **temporal bone** consisting of a posterior part containing the essential organ of hearing, and an anterior part provided with an articular depression for the quadrate bone. A *zygomatic process* extends forwards to meet the zygomatic process of the frontal.

The **ethmoid bone** may be divided into a horizontal and a perpendicular plate. The former corresponds to the cribriform plate of mammals and has an opening on each side for the passage of the olfactory nerve into the nose. The perpendicular plate forms the inter-orbital septum in which is an opening confluent with the single optic foramen.

2. *Facial Bones*.—A pair of small rod-shaped **maxillæ** form the skeleton of part of the sides of the face and assist in the formation of the bony palate. The *palatine processes* of the

## 20 THE STRUCTURE OF THE FOWL

two bones do not, however, meet in the middle line, with the result that the palate presents a cleft in this position. The **nasal bones** are thin plates, and are notched at the anterior end by the opening into the nasal chamber. It should be noticed that these bones, because of their thinness, are pliable and are not rigidly joined to the frontals. The two **incisive bones**, which form the bony basis of the beak, are blended into one before the time of hatching. They partly circumscribe the openings into the nose and have a process insinuated between the two nasal bones. A very thin and elongated **zygomatic bone** is composed of an anterior *jugal bone* and a posterior *quadrato-jugal*. It forms a connecting link between the face and the cranium on each side of the skull and articulates posteriorly with the quadrate. Forming part of the margin of each orbit is a small **lachrymal bone**. Two **palatine bones** bound the posterior aperture of the nasal chambers, and are connected with the maxillæ and pterygoid bones. They unite in the middle line. A strong, rod-like **pterygoid bone** articulates medially with the sphenoid and laterally with the quadrate. Separating the two nasal chambers is a very slender

**vomer**, part of which is bony and part cartilaginous.

Though the **mandible** appears to be a single bone, it is really composed of right and left bones, each developed from five elements. The *articular* forms the posterior part of the mandible and is expanded. It carries a slightly concave surface for articulation with the quadrate, behind which the lower border of the bone is continued as a process with a curve in an upward direction. Continuing the articular forwards is the remains of Meckel's cartilage, the original cartilaginous bar of the mandibular arch, about which the remaining elements of the mandible are developed. The *angular* is a slender strip of bone lying below the articular and along the lower border of the jaw. The posterior third or more of the upper border of the mandible is formed by the *supra-angular*, on which there is a very small *coronoid process* a little anterior to the articular surface for the quadrate. The *splenial* is a thin plate of bone lying along the inner face of the mandible. The largest element of the mandible is the *dentary*, which forms the anterior half of the jaw and fuses firmly with its fellow of the opposite side.

## 22 THE STRUCTURE OF THE FOWL

The **quadrate** bone is irregularly quadrangular and intervenes between a concavity on the temporal bone, just in front of the tympanic cavity, and the mandible. In addition it is movably articulated with the quadrato-jugal and pterygoid.

The presence of the quadrate bones permits of the mechanical elevation of the skeleton of the upper part of the beak whenever the mandible is depressed. This is rendered possible by the absence of rigidity in the neighbourhood where the frontal, nasal, and incisive bones meet, and adds materially to the freedom with which the fowl can widely open the mouth. The elevation of the upper beak is brought about in the following manner. Depression of the mandible causes a forward motion to the lower end of the quadrate, and this is transmitted to the pterygoid, the inner end of which is movably articulated to the sphenoid. The palatine, being jointed to the pterygoid, is necessarily pushed forwards at the same time; thus the movement is communicated to the upper beak with which the anterior end of the palatine is connected.

Beneath the skull is the **hyoid bone** (Fig. 5), consisting of three medial segments and a pair

of thin, curved processes. The anterior medial segment, the *entoglossal bone*, is sagittate and contained within the tongue. A movable joint connects it with the body (*basi-hyal*), the next medial segment, which in its turn is joined by cartilage to a long, slender rod (*uro-hyal*)—partly bony, partly cartilaginous—which rests upon the larynx. Each of the lateral processes consists of two rods of bone (*basi-branchial* and *cerato-branchial*) joined by cartilage.

*Foramina of the Skull.*—The *foramen magnum* and the *optic foramen* have been noted already; but there remain to be mentioned a number of smaller openings. The small foramen of exit for the twelfth cerebral nerve lies immediately to the side of the occipital condyle. Still more lateral is another small opening which permits the ninth and tenth cerebral nerves to leave the cranium. Close to the margin of the tympanic cavity is a

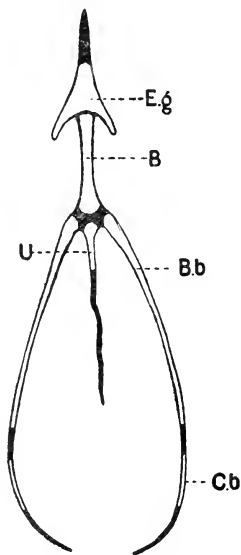

FIG. 5.—Hyoid Bone.

E.g., entoglossal; B., basi-hyal; U., uro-hyal; B.b., basi-branchial; C.b., cerato-branchial.

depression in which are several openings. The largest of these leads into the tympanic cavity, and the most inferior of them forms the entrance to the *carotid canal*. The other end of the canal is on the base of the skull at a short distance from the middle line. Within the tympanic cavity are several openings, three of which are of importance. Two of these are about the middle of the cavity. The upper one is the *fenestra vestibuli* into which the end of the *columella* fits. The lower is the *fenestra cochleæ*. From the lower and anterior part of the tympanic cavity a funnel-shaped depression leads into the bony *auditive* or *Eustachian tube*, the other end of which is a small opening close to the middle line and about the same level as the anterior opening of the carotid canal.

The foramen of exit for the fifth cerebral nerve is immediately below the concavity in the temporal bone with which the quadrate articulates. The small openings by which the third and fourth cerebral nerves leave the cranium are immediately lateral to the optic foramen, with which they not infrequently blend. The first cerebral or olfactory nerves leave the cranium by an opening in the middle



line continued forwards as a narrow opening between the frontal bones and the interorbital septum.

### THE SKELETON OF THE WING (Fig. 1)

The thoracic limb of birds is modified for purposes of flight and is commonly known as the wing. The wing and its skeleton may be divided into certain segments, as shown in the following table :—

(1) Shoulder-girdle . . .	{	Scapula.
		Coracoid.
		Clavicle.
(2) Free part of the limb—		
(a) Arm . . .		Humerus.
(b) Forearm . . .		Radius and Ulna.
(c) Manus.		
<i>a.</i> Carpus.		
<i>β.</i> Metacarpus.		
<i>γ.</i> Digits.		

The narrow, thin, slightly curved, and sabre-like **scapula**, or shoulder-blade, is placed nearly parallel to the vertebral column, reaches almost to the pelvis, and thus lies across most of the ribs. At its cranial end is a concavity which forms part of the articular depression for the

reception of the head of the humerus, and a projection which assists in forming an opening for the passage of the tendon of the supracoracoid muscle.

The rod-like **coracoid** is the strongest bone of the shoulder-girdle. One extremity is flattened and expanded with a saddle-shaped articular surface to fit into a concavity on the sternum. At this end there is also an opening, or foramen, leading into the interior and permitting a communication between the clavicular air-sac and the cavity within the bone. The other extremity is prolonged into a hook-like process which completes the opening (*foramen triosseum*) for the supracoracoid tendon and articulates with the clavicle. Below the hook is a depression which forms the greater part of the *glenoid cavity* for the reception of the head of the humerus.

The **clavicle** is thin, rod-like, and slightly bent. Its upper (dorsal) end is expanded and connected with the coracoid. Ventrally the two clavicles are united at an acute angle into a single, flattened expansion connected by ligament with the cranial medial process or rostrum of the sternum. The combined clavicles, therefore, form a continuous bone,

the *furcula*, capable of acting as a spring-like connection between the two shoulder-joints, and thus assisting in the formation of a firm basis of support for the wings.

The stout and slightly curved **humerus** has an ovoid *head* for articulation with the scapula and coracoid. On each side of the proximal end there is a prominent *tubercle*. Close to the medial tubercle is a large opening communicating with the cavity inside the bone and serving as an entrance for air from the clavicular air-sac. The distal extremity of the bone presents two convex articular areas and a prominence for muscular attachment.

Of the two bones of the forearm (Fig. 6) the **ulna** is the larger and carries a small projection, the *olecranon*, at its proximal and larger end. The slenderer **radius** is lateral to the ulna in position, the two bones enclosing a wide interosseous space. The proximal end of the radius can be distinguished by a concave articular surface of rounded outline.

It may be noted that when the wing is folded in rest the bones of the arm and forearm are almost parallel.

The **carpus** of the adult contains two bones only—a *radial* and an *ulnar*—which represent

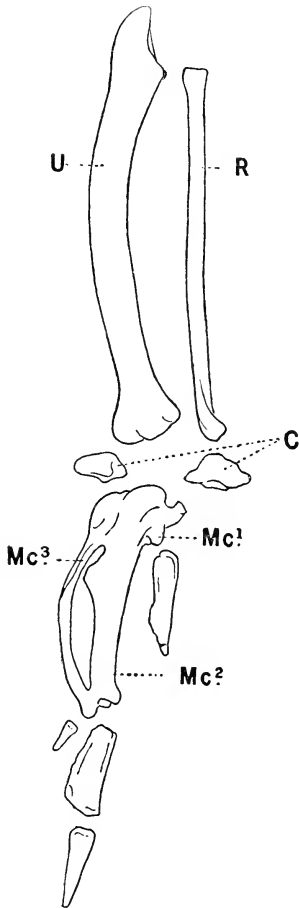

FIG. 6.—Skeleton of the Fore-arm and Manus.

U., ulna; R., radius; C., carpus; Mc.<sup>1</sup>, Mc.<sup>2</sup>, Mc.<sup>3</sup>, metacarpal bones.

the proximal row of mammalian carpal bones. In the embryo the distal row is also represented by cartilaginous nodules; but, as development proceeds, these fuse with the metacarpus.<sup>1</sup>

In the adult the **metacarpus** is in the form of a single bone, which has been produced by the union of three elements corresponding to the first, second, and third metacarpal bones of the mammalian limb.<sup>2</sup> The second

<sup>1</sup> According to embryological investigations, it appears that the embryonic carpus contains seven elements. Each of the two cartilaginous nodules of the proximal row contains two elements: a radiale and an intermedium have combined to form the radial nodule, and an ulnare and a centrale have in like manner coalesced to form the ulnar nodule. The distal row consists of three elements corresponding to the three persistent metacarpal bones.

<sup>2</sup> Some authorities are of opinion that the metacarpal bones of the adult fowl correspond to the second, third, and fourth bones of the mammalian limb. According to this

and third bones are blended at their ends only, the intervening shafts being separated by a narrow, elongated interval. The representative of the first metacarpal bone is small, and consists of a short projection at the proximal end of the composite bone. Of the three **digits** borne by the three metacarpal bones, the first and second have two phalanges, the third has one phalanx only.

### THE SKELETON OF THE LEG (Fig. 1)

The most remarkable features of the pelvic limb, or leg, are the firm and extensive fixation of the hip-bone to the vertebral column, the absence of a ventral union between the two hip-bones, and the absence of an independent tarsus. Like the wing, the leg may be divided into segments as follows :—

- |                            |    |      |   |                   |
|----------------------------|----|------|---|-------------------|
| (1) Pelvic-girdle          | or | hip- | { | Ilium.            |
| bone                       | .  | .    |   | Ischium.          |
|                            |    |      |   | Pubis.            |
| (2) Free part of the limb— |    |      |   |                   |
| (a) Thigh                  | .  | .    |   | Femur.            |
| (b) Leg                    | .  | .    |   | Tibia and Fibula. |

---

view, the small cartilaginous rudiments which represent the first and fifth metacarpal bones in the early chick embryo disappear during the subsequent stages of development.

(c) Pes.

*a.* Tarsus.

*β.* Metatarsus.

*γ.* Digits.

The term “girdle” when applied to the hip-bone of the fowl is a misnomer, inasmuch as, instead of the bones of opposite sides of the body meeting and uniting at a symphysis in the mid-ventral line of the body, they are most widely separated at this place. This arrangement is associated with the laying of relatively large eggs. Were the bony boundaries of the pelvis—the cavity within the hip-bones—complete, as they are in mammals, passage of the egg would be impossible unless the pelvis were of a relatively enormous size. In the existing condition the soft and yielding ventral wall of the cavity is adapted to the passage of an egg of considerable dimensions. The extensive fusion of the hip-bone with the vertebral column compensates the weakness which would otherwise result from the absence of a symphysis.

The hip-bone of birds (Fig. 7) resembles that of mammals in being composed of three elements—ilium, ischium, and pubis—meeting at the deep concavity—the acetabulum—into which

the head of the femur fits. The ilium is by far the largest segment, and is joined firmly to the transverse processes of that fused part of the vertebral column which contains the last thoracic, the lumbar, and the sacral vertebræ. So long as there are prominent spinous processes to the vertebræ, a thin plate

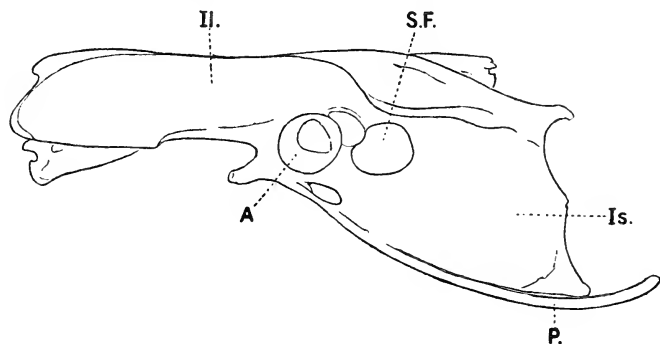

FIG. 7.—Left Hip-Bone.

Il., ilium; S.F., sciatic foramen; Is., ischium; P., pubis; A., acetabulum.

of bone joins the ilium to them, and thus is bounded a narrow canal between the ilium and the fused spinous processes. The cranial half of the outer surface of the ilium is in the form of a deep concavity in which lie the gluteal muscles, while the caudal half of the same surface is convex. The inner surface helps in the formation of a deep double concavity in which the kidneys are lodged.

The **ischium** is much smaller than the ilium, and, in the adult, continuous therewith except at a large, ovoid opening, the *sciatic foramen*.

The **pubis** is a thin and narrow strip of bone running along the border of the ischium to which it is joined for a short distance only. The free posterior end of the pubis projects backwards for a little distance beyond the ischium, while its anterior end forms a short projection in front of the acetabulum. Close to the acetabulum an oval *obturator foramen* separates the pubis and ischium.

The relatively large and deep *acetabulum* is pierced by a large foramen and receives the head of the femur. Immediately above the acetabulum a projection of the ilium carries an articular surface for contact with the femoral trochanter.

The stout, cylindrical, and somewhat bent **femur** has a prominent *head* at its proximal extremity. The head is much too small to fill the acetabulum completely, with the result that the articular surface of the femur extends beyond the head on to the *trochanter*—an irregular projection lateral to the head. The distal end carries a deep, pulley-shaped surface for the **patella**, or knee-cap, and two convex *condyles* for articulation with the bones of the



leg. The lateral condyle is grooved for the head of the fibula.

The **tibia** (Fig. 8) is a much longer bone than the femur, and is irregularly expanded at its proximal end, where it meets the bone of the thigh. The distal end has two articular elevations separated by a smooth groove. Strictly speaking, this part of the tibia represents the proximal row of the tarsal bones, and the whole bone should therefore be called the tibio-tarsus. The **fibula** is only feebly developed and consists of a slender spicule of bone expanded into a flattened *head*, which articulates with the lateral condyle of the femur.

In the adult there is no independent **tarsus**. In the embryo there are indications of two rows of elements; but before long the proximal row fuses with the tibia and the distal with the metatarsus.<sup>1</sup>

<sup>1</sup> In the embryo the tarsal elements of the proximal row are two in number, a tibial and a fibular. The distal row contains one element only.

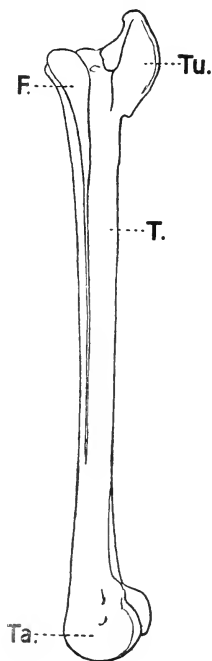

FIG. 8.—Right Tibia and Fibula.

Tu., tuberosity of tibia; F., fibula; T., tibia; Ta., tarsal part of tibia.

The adult **metatarsus**, or tarso-metatarsus (Fig. 9), is represented by one long bone composed of second, third, and fourth metatarsal bones in union. The proximal end is very irregular and provided with two concavities, which articulate with the tibia. In the male a conical and slightly curved projection from the medial side of the bone serves as a support for the spur. The distal end of the metatarsus divides into three articular projections, thus revealing the composite nature of the bone. A rudimentary first metatarsal bone is connected by ligament with the inner and posterior aspect of the distal part of the common bone. The fifth metatarsal bone is represented in the embryo by a small cartilaginous nodule which soon disappears.

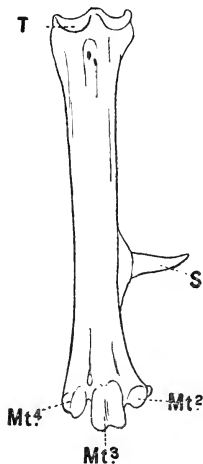

FIG. 9.—Right Meta-tarsus.

T., tarsal part; Mt.<sup>2</sup>, Mt.<sup>3</sup>, Mt.<sup>4</sup>, metatarsal bones; S., bony core of spur.

Of the four **digits** carried by the metatarsus, three project forwards, one backwards. The first digit, directed backwards, is composed of two phalanges; the second of three; the third of four; and the fourth of five phalanges.

### III

## THE MUSCULAR SYSTEM

THREE kinds of muscle are met with in the animal body. (1) The walls of the alimentary canal and the air-passages, the walls of blood-vessels and other tubular structures contain collections of spindle-shaped muscular cells or fibres whose action is beyond the control of the will. From this circumstance they are known as the *involuntary muscles*; and because, microscopically, the individual fibres do not possess a transverse striation, they are said to be unstriped. (2) The chief tissue of the heart is muscular (*cardiac muscle*), and possesses characters which have caused it to be placed in a class by itself. (3) The *voluntary* or *striped muscles* of the body move the various parts of the skeleton, and consist of minute thread-like muscle-fibres, grouped into bundles by sheaths of fibrous tissue. The exterior of

each muscle is covered by connective tissue, which may be of some density. The contractile, red, fleshy part of a muscle is connected with bones by tendons—sometimes of considerable length, sometimes extremely short.

By their presence and action, muscles produce marked effect on the surface of the bones to which they are attached or against which they press. Processes, ridges, and grooves on bones are often due to the presence and action of muscles.

A detailed description of the various muscles of the body would be out of place here; but to some attention may be directed on account of certain remarkable characteristics.

The **diaphragm** of the fowl is rudimentary, and does not form a partition between the thoracic and abdominal cavities as in mammals. The muscle is represented by a tendinous membrane, lying on the ventral surface of the lungs, and certain feeble muscular bundles springing from the ribs.

In the limbs special muscular arrangements are to be expected as a consequence of the modifications necessitated by specialised function. The immense and powerful mass of muscles associated with the pectoral region

forms an outstanding feature in the mechanism of the wing. An idea of the magnitude of this mass may be gathered from the statement that the muscles composing it weigh about as much as do all the rest of the muscles of the body together, and that they contribute about one-twelfth of the weight of the entire body. The most important members of the pectoral group are two in number—the pectoral proper and the supracoracoid.

The **pectoral muscle** has an extensive origin from the clavicle, the ligamentous membrane joining the clavicle to the sternum, a narrow strip of the sternal crest close to its ventral edge, the posterior-lateral process (including its oblique process) of the sternum and the membrane between this process and the metasternum. A few fibres also arise from the ribs close to the oblique process. Convergence of the fibres towards the shoulder-joint allows of insertion into the projecting greater (lateral) tubercle near the head of the humerus. The action of the muscle is to depress the wing.

The **supracoracoid muscle** is entirely covered by the preceding, compared with which it is much smaller. Its origin is from the whole of the sternum (including the rostrum) not

## 38 THE STRUCTURE OF THE FOWL

occupied by the pectoral muscle. In addition, part of it arises from the broad distal end of the clavicle, and from the membrane between this bone and the sternum. A strong, rounded tendon passes through the foramen triosseum, and is inserted into the humerus on that side of the greater tubercle immediately opposite to the attachment of the pectoral muscle. The action of the supracoracoid muscle is to raise the wing by producing a rotation of the humerus.

Associated with the muscular apparatus of the wing is a fold of skin, the **ptagium**, stretching from the trunk to the arm, and filling the angle between the arm and the forearm. Within the fold is an elastic membrane and muscular tissue, these being concerned in folding the wing after it has been outstretched.

The numerous muscles of the leg offer the peculiarity that ossification is of common occurrence within the long tendons of those which move the toes. Another feature of some moment is an arrangement by which the toes are mechanically flexed when the intertarsal joint is bent, whereby the fowl grasps the perch without effort. It is generally stated that the **ambiens muscle** plays an important

part in this mechanism. The muscle is long and triangular, and lies on the medial side of the thigh practically parallel to the femur. Its origin is from the projection of the hip-bone immediately in front of the acetabulum. A thin tendon crosses the front of the knee-joint obliquely, just distal to the patella, and thus gains the lateral side of the head of the tibia, where it joins the flexor muscle of the second and third digits.

Since the ambiens muscle is connected with two digits only, it seems obvious that it cannot constitute the only factor in the perching mechanism. Flexion of the toes, further, appears to depend greatly upon bending of the intertarsal joint. It seems very probable, therefore, that the passage of the flexor tendons over the grooved surface at the back of the distal end of the tibia is an important factor.

## IV

### THE DIGESTIVE SYSTEM

IN the fowl the lips and cheeks are replaced by the beak, an area of dense and horny skin lying over the incisive bones and the mandible, which serve as a bony foundation. Owing to the absence of anything homologous with the soft palate of mammals, the posterior limit of the mouth cavity of birds is not exactly defined; but for convenience may be taken as indicated by a prominent row of papillæ on the tongue and the last row of papillæ on the hard palate (Figs. 10 and 11). The true embryological limit appears to be slightly farther back; or, in other words, approximately on a level with the opening into the larynx. The difficulty of giving an exact definition is rendered all the greater by the assertion of embryologists that the tongue is developmentally a pharyngeal structure, and, therefore, does not strictly belong to the mouth.



No modern bird possesses teeth ; but very rudimentary enamel organs have been described in the embryos of some birds.

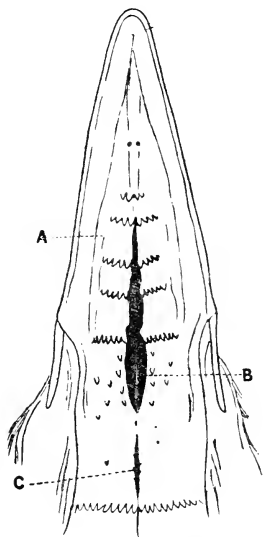

FIG. 10.—Roof of Mouth and Pharynx.

A, hard palate ; B, opening from nose ; C, common opening of the Eustachian tubes.

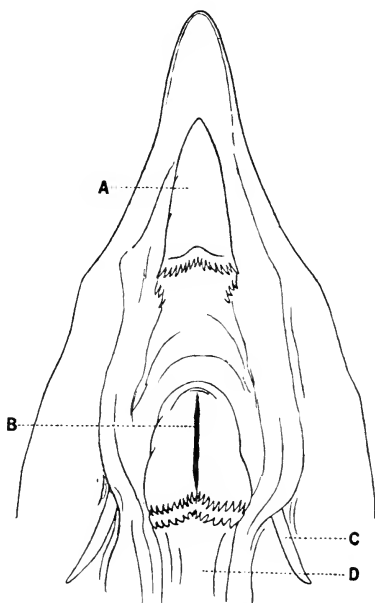

FIG. 11.—Floor of Mouth and Pharynx.

A, tongue ; B, opening into larynx ; C, hyoid bone ; D, œsophagus.

The **tongue** (Fig. 11) is narrow and pointed in conformity with the shape of the beak. The epithelium is thick and horny, especially towards the tip of the tongue ; and the posterior

part carries a transverse row of simple, large, and horny papillæ with apices directed towards the pharynx.<sup>1</sup> The intrinsic lingual muscles are rudimentary, as would be expected from the unyielding nature of the mucous membrane; but the muscles connected with the hyoid bone are well developed.

The **hard palate** (Fig. 10), which forms the roof of the mouth, presents a long, narrow, median slit, communicating with the nasal cavities, and is beset with transverse rows of horny, conical papillæ with apices directed backwards.

As already stated, the **pharynx** is directly continuous with the mouth. In the middle of its dorsal wall is the narrow slit-like opening common to the two auditive tubes of Eustachius by which air gains access to the drum of the ear and the interior of the spongy bones of the skull. Immediately behind this opening is a transverse row of conical papillæ.

The floor, or ventral wall, of the pharynx presents the narrow orifice leading into the larynx, and, behind this, a double row of papillæ.

The mucous membrane lining the whole of

<sup>1</sup> A study of the development of the tongue leads to the conclusion that its true posterior limit is behind this row of papillæ.

the mouth and pharynx is covered by a stratified epithelium, the surface layers of which are scaly and horny. At the margins of the openings into the nasal chambers and the larynx the epithelium is continuous with the columnar and ciliated cells covering the mucous membrane of these cavities. The oral and pharyngeal mucous membrane itself contains no glands, but in the underlying submucous tissue Heidrich has demonstrated the presence of the following :—(1) *Maxillary glands* in the roof of the mouth ; (2) *palatine glands* on each side of the common opening from the nasal chambers ; (3) *spheno-ptyergoid glands* in the roof of the pharynx on each side of the common opening of the auditive tubes ; (4) *anterior submaxillary glands* in the angle formed by the union of the two halves of the mandible ; (5) *posterior submaxillary glands*, arranged in three groups ; (6) *lingual glands* in the tongue ; (7) *crico-arytenoid glands* about the opening into the larynx ; and (8) a gland at the angle of the mouth.

According to Heidrich, all these glands produce a mucous secretion ; *i.e.* none of them are structurally or physiologically equivalent to the parotid gland of mammals.

# 44 THE STRUCTURE OF THE FOWL

The relatively wide and distensible œsophagus

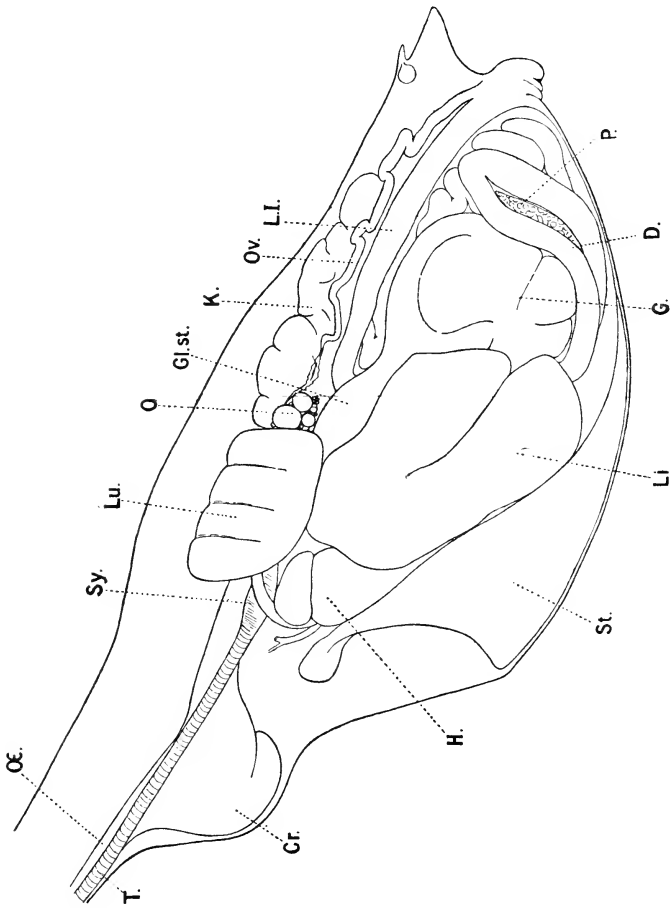

FIG. 12.—Thoracic and Abdominal Viscera (Semi-diagrammatic).

œ., œsophagus; T., trachea; Cr., crop; Sy., syrinx; Lu., lung; H., heart; O., ovary; Gl.st., glandular stomach; K., kidney; Ov., oviduct; L.I., large intestine; St., sternum; Li., liver; G., gizzard; D., duodenum; P., pancreas.

(Fig. 12) passes down the neck into the thorax to end in the glandular stomach. At first it

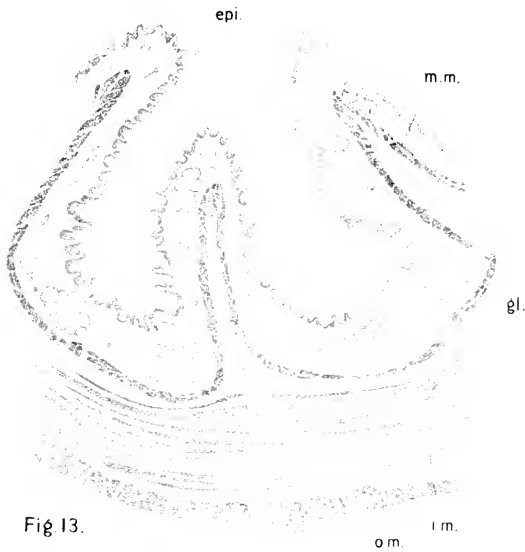

Fig 13.

Section of Œsophagus.

epi., epithelium ; m.m., muscularis mucosæ ; gl., gland ; i.m., inner stratum of muscle ; o.m., outer stratum of muscle.



Fig. 14.

Section of Crop.

epi., epithelium ; m.m., muscularis mucosæ ; s.m., submucous tissue ; i.m., inner stratum of muscle ; o.m., outer stratum of muscle.



is dorsal to the trachea, but soon it deviates towards the right of the middle line of the body. At the thoracic entrance a considerable dilatation, the *crop*, lies to the right. Beyond this the œsophagus narrows somewhat before its mergence into the stomach.

Structurally, the wall of the œsophagus is composed of four layers of tissue. The outermost is a loose and rather sparse fibrous investment, which serves to connect the tube with its immediate surroundings. The next tunic contains muscular tissue, and may be divided into two strata (Fig. 13). The outer stratum contains muscular fibres running for the most part longitudinally. The fibres of the inner stratum are circular. A loose layer of submucous tissue joins the innermost tunic, the mucous membrane, and the muscular layer. The mucous membrane is of considerable thickness, and, when the œsophagus is empty, is thrown into longitudinal folds. The epithelium is thick and composed of many layers of cells, of which the most superficial are flattened and horny. Numerous conspicuous alveolar glands occupy the tissue underlying the epithelium, and are provided with ducts which open on the free surface of the mucous

membrane. The secretory epithelium of these glands is clear and columnar. The deepest

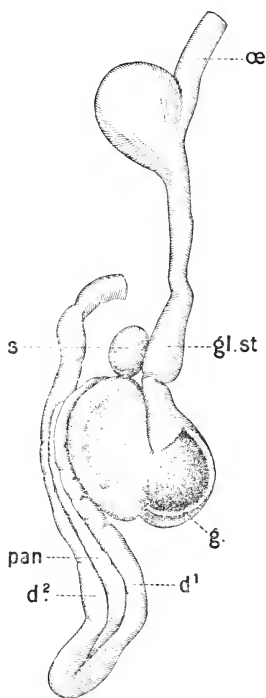

FIG. 15.—Crop, Stomach, and Duodenum.

œ., œsophagus; gl.st., glandular stomach; g., gizzard; d.<sup>1</sup>, first part of duodenum; d.<sup>2</sup>, second part of duodenum; pan., pancreas; s., spleen.

part of the mucous membrane contains a considerable amount of muscular tissue constituting the muscularis mucosæ.

The crop (Fig. 14) possesses the same structure as the rest of the œsophagus, except that glands are absent.

The stomach (Fig. 15) of the fowl consists of two portions, differing widely both in structure and function.

1. The *glandular stomach* is relatively small and tubular, and on superficial examination appears to be little more than a wider continuation of the œsophagus. On manipulation, however, it is discovered that the wall of the tube is of considerable thickness. The position of this stomach is median and between the



two lobes of the liver. Its long axis slopes slightly from right to left.

On microscopic examination this part of the digestive tract is found to contain the same layers as does the œsophagus. A loose adventitious coat covers the outside of the organ. The muscular tunic can be resolved into three strata; two thin longitudinal layers with a thick circular stratum interposed.

The mucous membrane and the glands associated with it are remarkable (Fig. 17). The membrane is raised into folds covered by a simple columnar epithelium. Between the folds open numerous simple, and relatively short, tubular glands. A considerable amount of lymphoid tissue is present in the membrane, and a distinct layer of muscle—the muscularis mucosæ—can be demonstrated. Beyond the muscularis mucosæ, *i.e.* between it and the proper muscular tunic of the stomach, is a thick and remarkable layer of glands which form the greater part of the thickness of the organ. The glands are grouped together, and the members of each group, or lobule, converge towards the centre and open into a common cavity (Fig. 18). Each gland is simple and tubular, and has a lining of low columnar cells

partly separated from each other by considerable clefts (Fig. 19). The common cavity into which the cluster, or lobule, of glands opens is lined by columnar cells, and has a relatively narrow duct—the walls of which are folded—opening on the surface of the mucous membrane.

2. The *muscular stomach*, or gizzard (Figs. 12, 15, and 22), immediately succeeds the glandular stomach, from which it is separated merely by a constriction. Placed partly between the two lobes of the liver and partly behind the left lobe, the gizzard is flattened and rounded somewhat like a bi-convex lens—one diameter, however, slightly exceeding the other. Each surface is covered by a glistening tendinous layer, thicker at the centre of the surface and thinning away towards the margins. A section of the organ along its greatest, or antero-posterior, diameter shows that the centre of each surface contains no muscle (Fig. 20); while the cranial and caudal extremities are formed by two powerful masses of red muscular tissue, united by a much thinner stratum along the borders of the gizzard. The interior is furnished with a pale, thick, and horny lining, raised into ridges; and almost always contains hard substances, such as small pebbles, etc.,

m.

m.m.

l.m.<sup>1</sup>  
c.m.

gl. lob.

l.m.<sup>2</sup>

Fig. 16.

Section of Glandular Stomach.

m., mucous membrane; m.m., muscularis mucosae; gl. lob., lobule of glands; l.m.<sup>1</sup>, inner stratum of longitudinal muscle; l.m.<sup>2</sup>, outer stratum of longitudinal muscle; c.m., stratum of circular muscle.

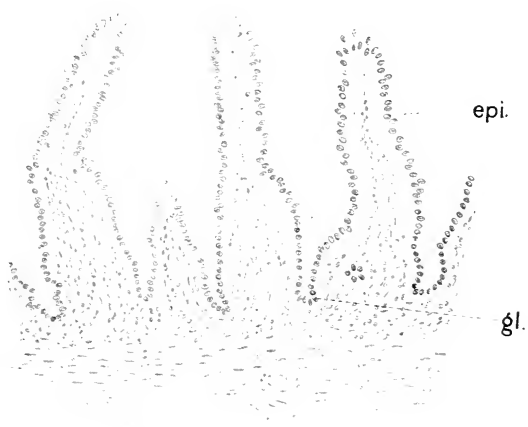

Fig. 17.

v.

Mucous Membrane of Glandular Stomach.

epi., epithelium; gl., tubular gland; m.m., muscularis mucosae; v., vein.





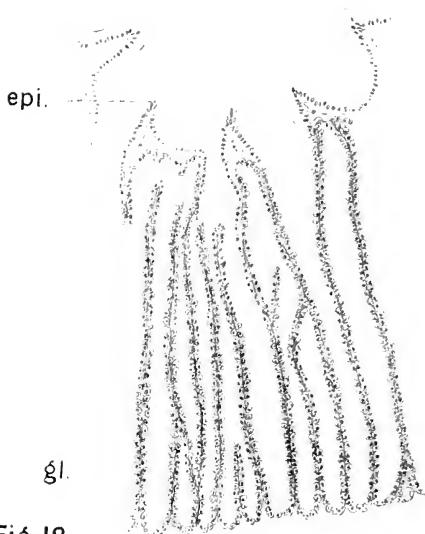

**Fig. 18.**

Tubular Glands in the Submucous Tissue of the Glandular Stomach.

epi., epithelium of the common cavity into which the glands of the lobule open ;  
gl., longitudinal section of one of the glands.



**Fig. 19**

Transverse Section of a Tubular Gland of the Stomach.

which assist in the disintegration of the food. The entrance to the cavity from the œsophagus and the exit into the duodenum are close together, and dorsal in position.

A microscopic examination of the lining membrane of the gizzard shows that much of its thickness is due to the presence of the dense horny lining (Fig. 21). Beneath this are long, narrow, and simple glands, which reveal a certain degree of grouping in their arrangement. It is from these glands that the horny surface layer of the mucous membrane is produced: that is to say, the lining of the gizzard is formed by hardened glandular secretion.

Succeeding the stomach are the intestines, generally measuring five or six times the length of the body. Though the intestinal tube varies little in width, it is customary to distinguish small and large intestines.

The *small intestine*, which begins at the exit from the muscular stomach, is relatively long and of uniform calibre throughout. Of the three parts of the mammalian intestine—duodenum, jejunum, and ileum—only the first can be distinguished. There is no demarcation between the jejunum and ileum, which are disposed in coils and suspended from the

dorsal wall of the abdomen by a thin membrane, the *mesentery*. The *duodenum*, on the contrary, is very readily recognised (Figs. 12, 15, and 22). Beginning at the right side of the muscular stomach it forms a long loop, consisting of descending and ascending limbs, extending as far as the entrance to the pelvis, and sloping somewhat obliquely from right to left.

The *large intestine* is very short, and does not differ very markedly from the small intestine in its calibre. It runs in an approximately straight line ventral to the vertebræ and ends in the cloaca (Fig. 12). Though unnecessary, it is sometimes the practice to describe the tube as consisting of two parts, the *colon* and the *rectum*, the latter name being then applied to the terminal part of the gut.

At the junction of small and large intestines are two *cæca*—long tubes, with somewhat wider blind extremities directed towards the liver (Fig. 23). The *cæca* always contain a larger or smaller amount of material, often of a dark colour.

Inasmuch as it is in the intestines that much of digestion and the whole of absorption take place, their structure is of importance.





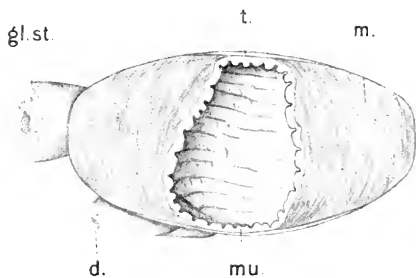

Fig. 20.

Section (Naked-eye) of Gizzard.

gl. st., glandular stomach; d., duodenum; t., tendon; m., muscle;  
mu., mucous membrane.

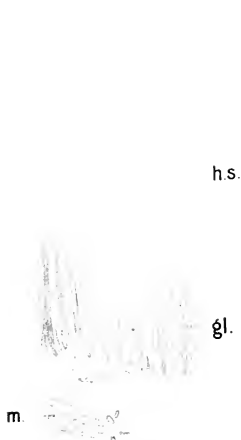

Fig. 21.

Section of Mucous Membrane of Gizzard.

h.s., horny secretion; gl., glands; m., muscle.

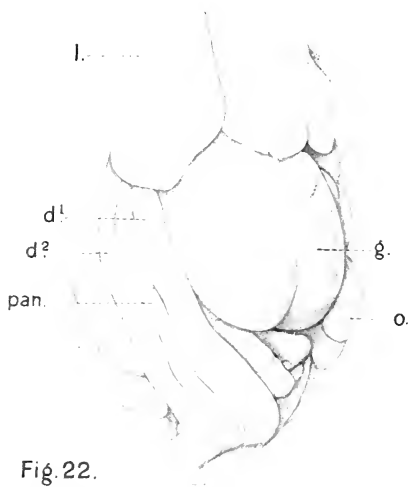

Fig. 22.

Cast of Abdominal Organs hardened *in situ* and viewed from the Ventral Aspect.

l., liver; d.1, first part of duodenum; d.2, second part of duodenum; pan., pancreas; g., gizzard; o., ovary.

Covering the outside of the tube and giving it its smooth, shining appearance, is a thin serous tunic derived from the peritoneum (Fig. 24). Under this is the muscular coat in which three strata can be recognised. The outermost and innermost strata consist of muscular fibres disposed in a longitudinal direction; whereas the middle stratum, much thicker than the other two, contains fibres arranged circularly.

Strictly speaking the innermost longitudinal layer should not be included in the proper muscular coat of the gut; but should be regarded as belonging to the mucous membrane. That is, it is *muscularis mucosæ*, and lies close to the circular stratum of the muscular tunic because of the sparsity of submucous tissue.

The thick, soft, and highly vascular mucous membrane which lines the intestine has a velvety appearance to the naked eye, especially if a piece of gut be sunk under water. This appearance is due to the presence of innumerable long, thin projections known as *villi*, actively concerned in the absorption of the nutritive part of the food. Each villus is covered by a single layer of epithelial cells, some of which are columnar in form, and others shaped like goblets (Fig. 25). The more

numerous columnar cells possess a thick striated border at their free ends. The goblet-cells produce a glairy, transparent material known as mucin, and are much more numerous in the large intestine than they are in the small gut. Goblet-cells are least numerous towards the summit of a villus.

In the interior of a villus, and composing the greater part of its bulk, is a cellular stroma containing small blood-vessels and an absorbent vessel. In addition, the villus contains a certain amount of muscular tissue, the cells of which are arranged parallel to its long axis.

In the duodenum, and in some regions of the cæca, the villi are replaced by definite folds of mucous membrane. In the duodenum in particular these folds are distinct, irregular in disposition, and frequently united to each other.

Between the villi are the openings of the simple, tubular *intestinal glands*, each lined by a single layer of granular epithelial cells, among which, especially in the large intestine, are goblet cells.

Throughout the whole of the intestine lymph nodules are present in the mucous membrane. In some places, notably in the cæca (Fig. 26), these are so numerous as to

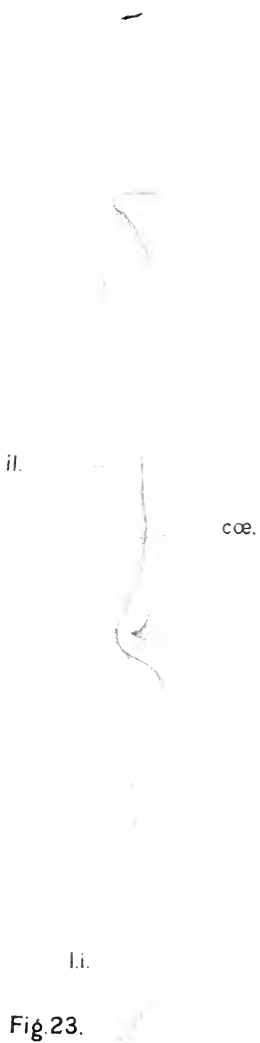

**Fig. 23.**  
 il., ileum; cae., caeca; li., large intestine.

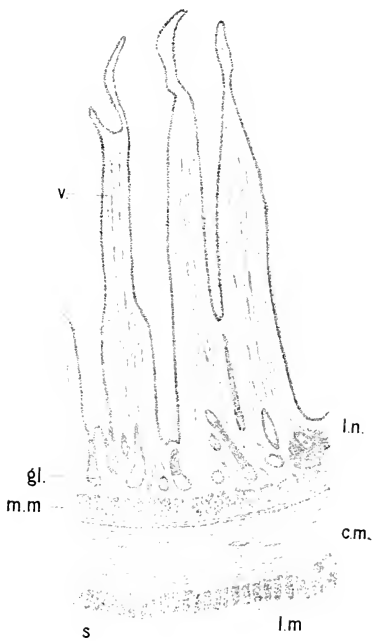

**Fig. 24.**

**Section of Small Intestine.**

v., villus; gl., gland; l.n., mass of lymphoid tissue; m.m., muscularis mucosae; c.m., circular stratum of muscle; l.m., longitudinal stratum of muscle; s., serous investment.



**Fig. 25.**

**Epithelium of Intestine.**

col., columnar epithelial cells with striated free border (st.br.); gob., goblet cell.



crowd out the other constituents of the membrane. Eberth has described an elevated body in each cæcum, about 4 mm. from its mouth, entirely composed of lymphoid tissue.

The **cloaca** is the tubular cavity opening on the exterior of the body and common to the digestive and uro-genital tracts. It is divisible into three parts. With the first, the *coprodæum*, the large intestine (rectum) is continuous; in the middle part, the *urodæum*, the ureters and the genital ducts terminate; and from the dorsal wall of the third and most external part, the *proctodæum*, an opening leads into a blind, rounded, and unpaired sac, the *bursa of Fabricius*. The function of the bursa is not clear, but it is known that it has its largest development in the fowl of about four months old, and that from this time it gradually shrivels until hardly any vestige remains by the time the animal has attained the age of one year. The fully developed bursa is lined by a folded membrane, and contains sac-like diverticula in its walls.

The large, dark-brown or chocolate-coloured **liver** (Figs. 12 and 22) lies ventral and caudal to the heart. Two lobes, connected by a comparatively narrow isthmus, are readily dis-

tinguishable, and of these the right is generally the larger. Two faces may be recognised : a parietal surface, convex and smooth, applied to the body-wall ; and an irregularly concave visceral surface moulded upon the adjacent organs. On the visceral surface is the *porta*, by which vessels and nerves reach the interior and bile ducts find exit.

The visceral surface of the right lobe carries the gall-bladder in which the bile is temporarily stored. Two ducts carry the bile into the terminal part of the duodenum. That from the right lobe possesses a diverticulum, the *gall-bladder* ; while the duct from the left lobe pursues an independent course. The presence of two ducts is accounted for by the mode of development of the liver. The first trace of the organ is in the form of two (anterior and posterior) solid buds thrust out from the epithelium of the gut. These ramify and become tubular, the definitive ducts marking the original connections with the intestine.

Microscopic examination of the liver of the adult fowl reveals little but a closely compacted mass of relatively large, polyhedral and granular cells, with blood-vessels of some size at intervals. There is none of the lobular

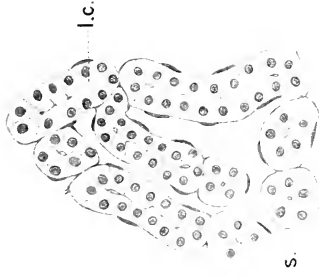



**Fig.26.**

Section of Fold of Mucous Membrane in the Caecum.

epi., epithelium ; gl., gland ; ln., mass of lymphoid tissue ; m.m., muscularis mucosae.



**Fig.27.**

Section of Liver of Young Chick.

l.c., liver cells ; s., sinusoid.



**Fig.28.**

Section of Pancreas.

c.i., cell islet ; al., alveolus ; d., duct.

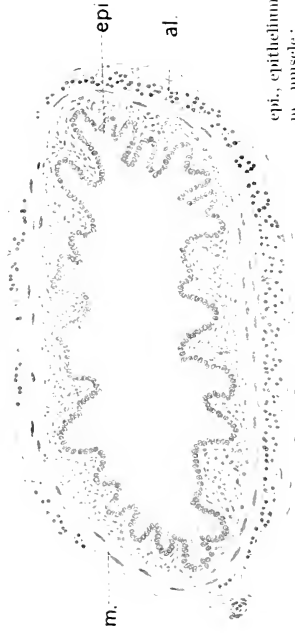

**Fig.29.**

Transverse Section of one of the Larger Ducts within the Pancreas.

epi., epithelium ;  
m., muscle ;  
al., alveoli.

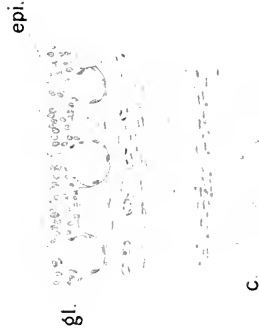

**Fig.30.**

Section of the Trachea.

epi., epithelium ; gl., gland ; c., cartilage.



arrangement found in the mammalian liver, nor are the outlines of the individual cells easily distinguished. The liver of the young chick, however, consists of anastomosing tubules, lined with cubical cells surrounding a narrow lumen (Fig. 27). Between the tubules are blood-spaces or sinusoids connected with larger vessels arranged in a more or less radial manner.

An elongated, thin, lobulated, and pale-yellow or reddish **pancreas** occupies the narrow interval between the two limbs of the duodenum (Figs. 12, 15, and 22). Two, or possibly more generally three, ducts carry the secretion of the gland into the ascending duodenal limb, where they open close beside the bile ducts. In structure the pancreas is a typical lobulated gland, with a framework of connective tissue supporting the secreting alveoli and the ducts by which the secretion is carried away. The alveoli are short tubules lined by a layer of granular epithelial cells surrounding a lumen of small diameter (Fig. 28). Small ducts, lined by low epithelium, are continuous with the mouths of the alveoli and join larger ducts in which the epithelium is taller. By repeated union the

ducts are reduced to the main tubes which open into the duodenum. The walls of the larger ducts contain muscular tissue and are lined by columnar epithelium (Fig. 29).

Throughout the pancreas, and between its alveoli, are clusters of polyhedral cells forming the *cell-islets* of Langerhans. These are evidently concerned in the production of a secretion which finds its way into the blood-stream and acts as a regulator of metabolism. The pancreas, therefore, has to be regarded as a double organ. In the first place it produces the digestive pancreatic secretion by the activity of the epithelium lining its alveoli. Secondly, the islets of Langerhans elaborate an internal secretion.

## V

### THE RESPIRATORY ORGANS

THE two rounded or oval *nostrils*, present at the base of the beak, lead into short and rather narrow **nasal cavities**. Each cavity is separated from its fellow by a septum, partly bony and partly cartilaginous, and contains three cartilaginous representatives of the turbinated bones or conchæ of mammals.

Associated with the nose is a small, flattened *nasal gland* lying on the frontal bone close to the medial angle of the eye. The duct of the gland runs for some distance on the lateral wall of the nasal cavity before opening into the interior.

In the floor of the pharynx is a comparatively narrow, elongated opening which leads into the **cranial larynx** (Fig. 11). The opening is not provided with any cartilaginous representative of the mammalian epiglottis,

but has a horseshoe-shaped fold of mucous membrane embracing its oral extremity. The skeleton of the cranial larynx consists of *cricoid* and *arytenoid* cartilages, both of which undergo extensive ossification. The cricoid is not in the form of a continuous cartilaginous ring, but consists of four segments—a dorsal, two lateral, and a ventral—arranged so as to form a ring. The segments ossify early in life.

The arytenoid cartilage consists of two slightly diverging rays united by their oral ends. The more ventral ray articulates with the dorsal segment of the cricoid, and is almost entirely converted into bone. The dorsal ray remains cartilaginous.

No thyroid cartilage and no vocal folds are present in the larynx of the fowl. Obviously the cranial larynx is not concerned in the production of voice.

A relatively long *trachea*, composed of complete rings of cartilage united by narrow membranous ligaments, connects the cranial larynx with the caudal larynx or syrinx (Fig. 12). Commonly, ossification takes place in the ventral part of the tracheal rings. Associated with the trachea are two pairs of muscles. The *ypsilo-tracheal muscles* arise either

from the clavicle or the syrinx and run along the entire length of the trachea. The *sterno-tracheal muscles* are shorter and more easily recognised as they pass from the sternum to the trachea. The trachea ends by dividing into the right and left *bronchi*; each bronchus entering the ventral surface of a lung.

The interior of the trachea is lined by a delicate mucous membrane, the surface of which is covered by ciliated, columnar epithelial cells (Fig. 30). Small saccular glands, lined by a clear epithelium, occur at frequent intervals. The cartilage of which the tracheal ring is composed is of the hyaline variety.

The *syrinx*, or broncho-tracheal larynx, is indicated by a lateral compression where the trachea divides into the two bronchi. Between the two bronchial openings is a ridge—generally ossified—supporting a crescentic or semi-lunar membrane. On each side of this is an elastic membrane (*internal tympaniform membrane*) projecting into the entrance to the bronchus, opposite a similar membrane (*external tympaniform membrane*) attached to the outer wall of the tube. The presence of the two membranes converts the entrance to the bronchus into a slit; the membranes themselves being

in a manner comparable to vocal folds of the mammalian larynx.

The bright-red **lungs** are closely applied by their dorsal surface to the vertebral column and the ribs. Consequently this face is deeply indented by grooves, each corresponding to a rib (Fig. 12). The ventral surface is free, and covered by pleura and the rudimentary and largely tendinous diaphragm. The narrow cranial end of each organ reaches as far as the first rib ; while the broader caudal end touches the kidney.

The ventral surface of each lung is pierced by a bronchus, which passes through the whole length of the lung and communicates finally with the abdominal air-sac. The extra-pulmonary part of the bronchus has its wall strengthened by half-rings of cartilage with membrane completing the tube.

Within the lung the main bronchus, or *mesobronchus*, gives off ten *secondary bronchi*—the first four large, the remaining six smaller—which communicate directly or indirectly with air-sacs, and from which *tertiary bronchi* or parabronchia pass in a radiate or pennate manner towards the surface of the lung where they end blindly. Muscular tissue is present



in the wall of all the different orders of bronchi.

Innumerable openings in the walls of the parabronchia lead into minute canals beset with dilatations corresponding to the air-vesicles of the mammalian lung, and, like them, separated from each other by thin septa containing a close-meshed network of capillary blood-vessels connecting the pulmonary artery and pulmonary vein.

Each tertiary bronchus forms the centre of a lobule of the lung (Fig. 31). Between adjacent lobules are septa of connective tissue in which the branches of the pulmonary artery ramify preparatory to sending twigs into the interior of the lobule.

Intimately associated with the respiratory organs are thin-walled and membranous sacs filled with air. These **air-sacs** communicate with the bronchi on the one hand, and, on the other, with the interior of many bones of the limbs and other parts of the skeleton. They are important respiratory organs, and by their presence confer lightness and buoyancy upon the body, and, since they are mainly dorsal in position, influence the position of the centre of gravity. Structurally, the walls of the sacs

are composed of a serous membrane externally with a mucous membrane within.

A single *clavicular sac* is placed between and behind the two limbs of the furcula, and is continued on each side as an *axillary sac*. The air contained within the clavicular and axillary sacs is obtained through two openings at the cranial end of each lung and is transmitted to the interior of the sternum, sternal ribs, shoulder-girdle, and humerus.

Enclosing the abdominal organs and lying against the walls of the abdomen are the large *abdominal sacs*, right and left, into which the mesobronchi open. From them air enters the hollows of the sacrum, hip-bone, and femur.

Lying partly in the neck and partly dorsal to the clavicular sac are the two *cervical sacs* which supply air to the cervical and thoracic vertebræ and the vertebral ribs. Within the chest are two *thoracic sacs*—cranial and caudal—on each side. These stretch from the clavicular to the abdominal sacs, and, unlike the other air-sacs, do not communicate with the interior of bones.

The air-sacs appear in the chick during the first seven or eight days of incubation as



Fig.31.

Section of Lung.

tr.br., tertiary bronchus ; a-v., air-vesicles ; a., branch of pulmonary artery.

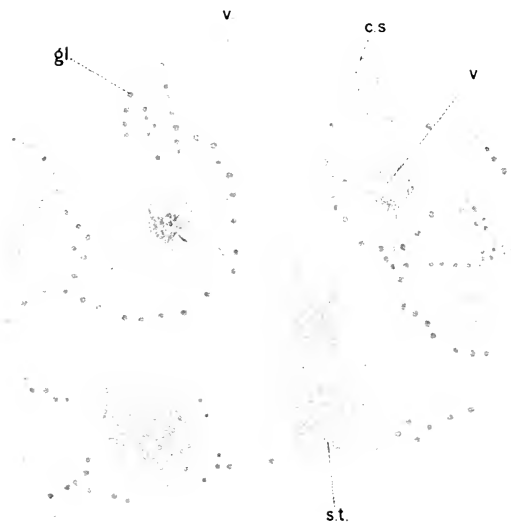

Fig.32.

Section of Kidney under Low Magnification.

c.s., cortical substance ; gl., glomerulus ; v., blood-vessels ; s.t., straight tubules.



terminal dilatations of the mesobronchus or the secondary bronchi. It is generally stated that the abdominal sac is the first to appear, and is early recognisable as a dilatation at the end of the mesobronchus. The caudal thoracic sac also arises from the mesobronchus, but not until after the seventh day. The cervical, clavicular, and cranial thoracic sacs begin to grow out from secondary bronchi on the fifth, sixth, and seventh days respectively. The axillary sac is a prolongation of the clavicular sac, and so has never an independent connection with bronchi.

It is to be noted that the cavities of the embryonic bones, which afterwards become pneumatic, are filled with marrow in the embryo. Their invasion by the air-sacs is a late development; Selenka, for example, stating that it only occurs in the humerus after the twenty-second day, when the bone is nearly full grown.

## VI

### THE URINARY ORGANS

THE urinary organs of the fowl consist of two kidneys, each with a ureter, by which the urine is conveyed to the cloaca. The three- or four-lobed **kidneys** (Figs. 12 and 35) are closely applied to the vertebral column, immediately caudal to the lungs and dorsal to the large intestine, and occupy the deep depressions formed by the vertebral column and the ilia. The organs are of brownish colour and of such a soft consistence as to be readily torn during the process of removal. From the medial border of each springs a comparatively straight and narrow **ureter**, which opens into the cloaca medial to the deferent duct of the male or the oviduct of the female. Within the substance of the kidney each ureter is formed by the union of several small branches.

A microscopic section of the kidney shows

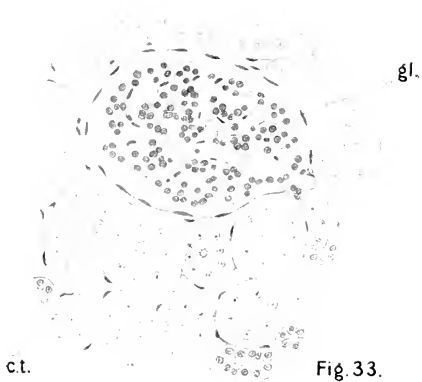

Cortical Substance of Kidney.

gl., glomerulus; c.t., convoluted tubule.



Fig 34.

Transverse Section of Straight Tubules of Kidney.

c., capillary blood-vessel.







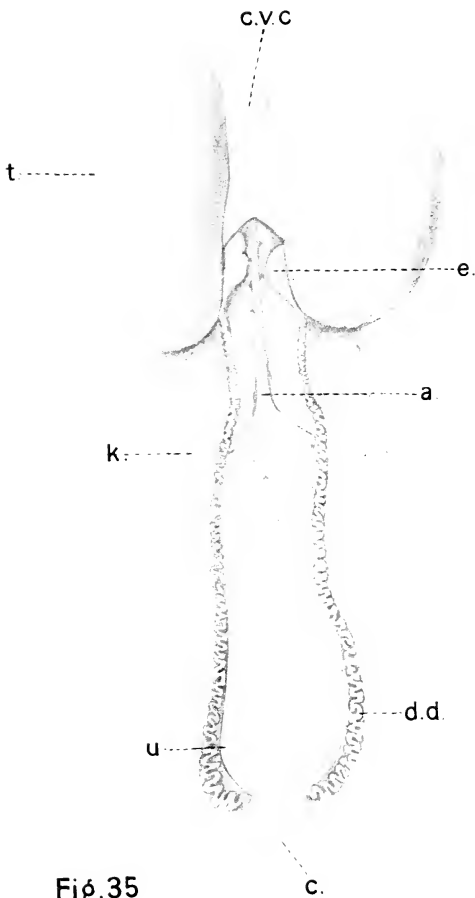

**Fig.35**

**Urinary and Reproductive Organs of the Male.**

c.v.c., caudal vena cava; t., testis; e., epididymis; a., aorta; k., kidney;  
d.d., deferent duct; u., ureter; c., cloaca.

that the organ is composed of numerous lobules, and that each lobule consists of a peripheral or cortical substance and a central or medullary substance (Fig. 32). Both substances contain small, branched *uriniferous tubules*, by the activity of which the constituents of the urine are derived from the blood. In the cortical substance the tubules are richly convoluted and lined by a layer of granular, polyhedral epithelial cells (Fig. 33). In this substance, also, are tufts of capillary blood-vessels—the *glomeruli*—each contained within a thin-walled capsule which is really the commencement of a uriniferous tubule. The tubules of the medullary substance are narrower and straight and lined by a clear, cubical epithelium surrounding a relatively wide lumen (Fig. 34). The straight tubules act as ducts which carry the urine into the radicles of the ureter.

The whole kidney is highly vascular in conformity with its function as a purifier of the blood. Capillary vessels form the glomeruli, and in addition are disposed as a network between the uriniferous tubules.

## VII

### THE REPRODUCTIVE ORGANS

THE male organs of reproduction are limited to the two testes, each with its deferent duct. In the fowl there is no homologue of the mammalian penis.

The testes are small ovoid organs, placed ventral to the anterior lobes of the kidneys (Fig. 35). Their size is not constant since they become larger during the breeding season. Nor are the two organs necessarily of equal volume, for the left is often somewhat larger than the right. The medial border of each testis is slightly concave, and carries a small flattened projection which represents the *epididymis* of mammals. From this arises the deferent duct, which pursues a wavy course lateral to the ureter and enters the cloaca, where it opens on the summit of a small papilla. The deferent duct is narrow at its

commencement, but gradually widens as it approaches the cloaca.

The surface of the testis is invested with a firm fibrous covering continuous with a supporting framework in the interior. The essential part of the organ consists of tortuous *seminiferous tubules* (Fig. 36) containing several layers of epithelial cells from which are derived the male germ-cells or *spermatozoa*. Lining each tubule is a continuous layer of mother-sperm cells, or *spermatogonia*, from which are derived all the other cells contained within the tubule. Within the spermatogonia, *i.e.* nearer the lumen of the tubule, are somewhat larger cells, the *spermatocytes*, which give origin to *spermatids*, the forerunners of the spermatozoa (Fig. 37).

The development of spermatozoa from spermatogonia is an interesting and important process. The male germ-cell in its genesis passes through stages comparable to those experienced by the female germ-cell; that is, spermatogenesis, of which a very short account may be fittingly given here, is comparable to oogenesis, of which an equally brief account will be given later. The phases through which both kinds of germ-cell pass are divisible into

periods of division or multiplication, growth, and maturation.

During the period of multiplication the spermatogonia divide repeatedly and rapidly by that process of mitosis which is undergone by animal cells in general. Innumerable small cells are produced, each containing in its nucleus the number of chromosomes, or stainable elements, typical of the ordinary body or somatic cells. In the second period growth in size takes the place of multiplication, and spermatocytes of the first order result. Then comes the period of maturation during which two rapidly succeeding divisions occur. The first division results in the formation of two cells exactly alike, spermatocytes of the second order, but differing from the somatic cells in containing only half the typical number of chromosomes. The second division produces two similar spermatids from one spermatocyte of the second order. That is to say, four spermatids precisely alike can claim descent from one spermatocyte of the first order.<sup>1</sup>

<sup>1</sup> In the maturation period of oogenesis an important difference will be noted (see p. 110). From one oocyte of the first order four cells are produced, but three of these, the polar bodies, are small and disappear; while one cell, the mature ovum, is very large and possesses the power to produce an embryo after fertilisation has taken place.



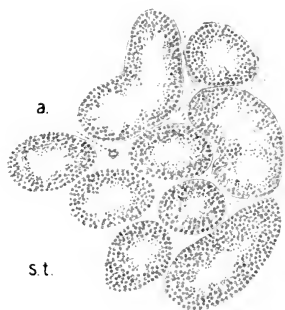

Fig 36.

Section of Testis.

f.c., fibrous covering; s.t., seminiferous tubule; a., small artery.

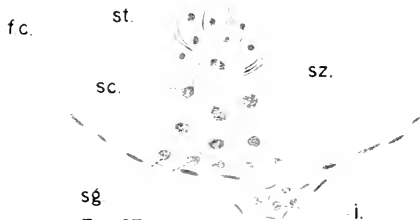

Fig 37.

Diagrammatic Representation of the Different Cells of a Seminiferous Tubule.

sg., spermatogonia; sc., spermatocytes; st., spermatid; sz., spermatozoa; i., interstitial cells.

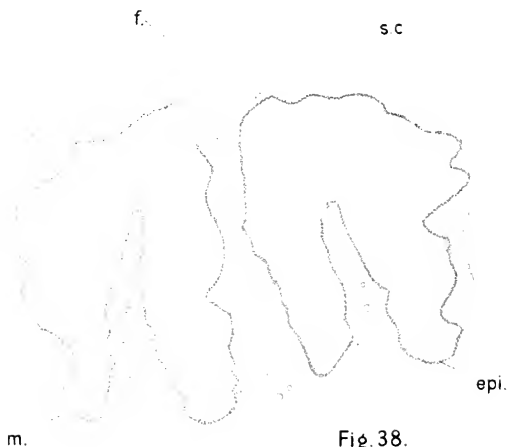

Fig 38.

Section of Deferent Duct.

s.c., serous covering; f., fat; epi., epithelium; m., muscle.



By a process of metamorphosis without further division the spermatids become spermatozoa.

The fully formed spermatozoon is a small elongated cell to which a long and actively motile flagellum is appended. A spermatozoon consists of three parts: a head, an intermediate part or neck, and a tail. The head contains the nucleus derived from the spermatid; while the neck contains the centrosomes. The tail has been described as consisting of three portions. A *pars conjunctionis* unites the tail to the neck; a *pars principalis* constitutes the main length of the tail; and a *pars terminalis* consists solely of an axial filament which traverses the entire tail and is surrounded by a protoplasmic sheath in the other two parts.

Here and there, in the connective tissue between the seminiferous tubules, are clusters of polyhedral cells, with rounded nuclei, apparently differing in character from the neighbouring cells. These are generally referred to as *interstitial cells*, and by some are held to be responsible for the production of the secondary sexual characters. In the active testis fat globules are demonstrable in the tissue between the seminiferous tubules, and even in the tubules themselves.

The seminiferous tubules join ducts which carry the spermatozoa into those numerous convoluted tubes which compose the epididymis and finally unite to form the deferent duct.

Microscopically the deferent duct has a wall formed by fibrous and muscular tissue and lined by columnar epithelium (Fig. 38). The duct contains no glands.

The reproductive organs of the hen are remarkable in that, though provision is made in the embryo for two ovaries and two oviducts, only the left ovary and its duct reach maturity.

The single ovary (Figs. 12 and 39) lies partly cranial and partly ventral to the left kidney, and consists of a mass of loosely-connected, yellowish, vascular and rounded objects each containing an ovum. The size of the bodies varies widely, dependent upon the stage of development of the contained ovum. In an ovary examined during the egg-laying period some of the vesicles will be of considerable dimensions; while during the resting-stage they will all be small. Microscopic examination shows that each ovum is surrounded by a granular membrane (*membrana granulosa*) composed of epithelial cells, whose duty is doubtless to act as



**Fig.39**

Cast of Reproductive Organs of Hen during Laying Period.  
o., ovary ; ov., oviduct ; ov.1, part of oviduct containing egg ; c., cloaca.





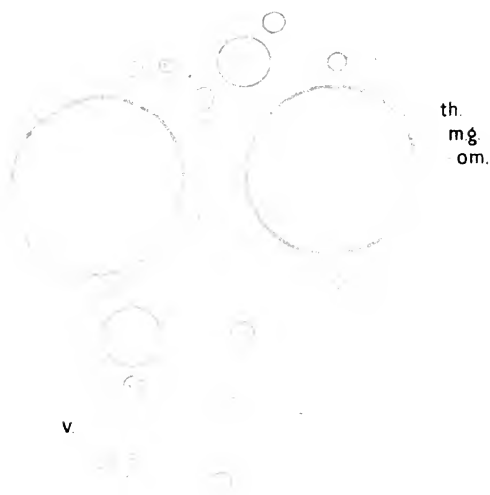

Fig 40.

Section of Ovary.

om., ovum ; m.g., granular membrane of follicle ; th., theca of follicle ; v., blood-vessels.

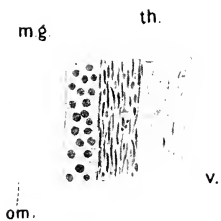

Fig 41.

Section of Wall of Follicle containing an Ovum.

v., blood-vessel ; th., theca ; m.g., granular membrane ; om., ovum (yolk).

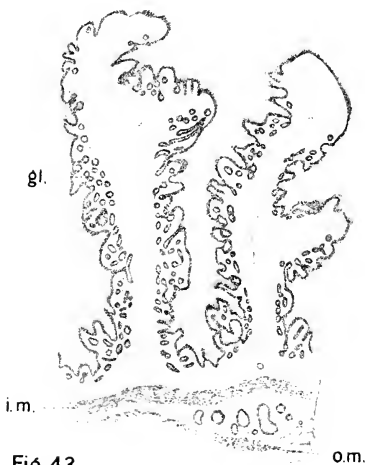

Fig 43.

Section of Infundibulum of Oviduct.

gl., gland ; i.m., inner stratum of muscle ; o.m., outer stratum of muscle.

nurse-cells to the egg (Figs. 40 and 41). The thickness of the stratum of cells depends upon the degree of development at which the ovum has arrived. A *theca* composed of spindle-shaped cells, consisting of a condensation of the connective-tissue stroma of the ovary, encloses the egg-follicle. The general ovarian stroma is somewhat scanty, and highly vascular, especially during the egg-laying season.

The ovary is so surrounded by other organs as to be enclosed in what Miss Curtis calls an "ovarian pocket," the only way out of which is by the infundibulum of the oviduct. An egg, after escaping from a follicle of the ovary, therefore, must of necessity pass into the oviduct. The dorsal wall of the "pocket" is formed by the body wall to which the ovary is attached. The other boundaries of the "pocket" are formed by the left abdominal air-sac, a part of the intestine and the mesentery.

*The Egg.*—The fully formed egg (Fig. 42), as one knows it after it has been laid and before it has been incubated, is covered externally by a porous shell in which three layers have been distinguished. The innermost or mammillary layer consists of minute conical masses of

## 72 THE STRUCTURE OF THE FOWL

calcareous material with small air-spaces between them. The outermost layer or shell cuticle is thin, delicate, and structureless, but porous; while the middle layer is spongy and formed of a meshwork of fibres. Within the shell is the shell-membrane, consisting of

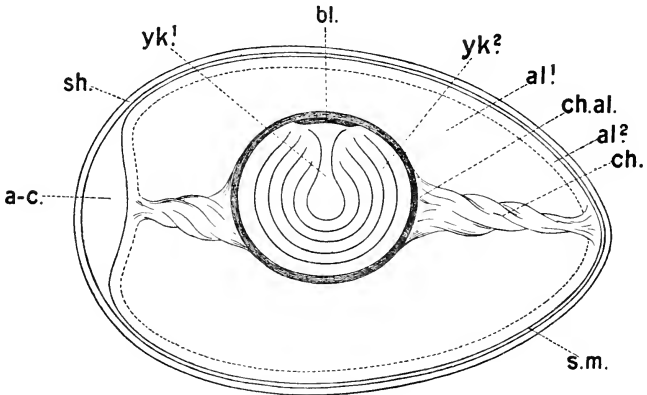

FIG. 42.—Diagram of the Parts of a fully formed Egg.

bl., blastoderm; yk.<sup>1</sup>, white yolk; yk.<sup>2</sup>, yellow yolk; ch.al., chalaziferous layer of albumen; al.<sup>1</sup>, dense albumen; al.<sup>2</sup>, fluid albumen; ch., chalaza; s.m., shell-membrane; sh., shell; a-c., air-chamber.

an outer thick and an inner thin layer. At the broader end of the egg the two layers of the shell-membrane are separated from each other to form the air-chamber—a space of considerable importance in relation to the respiration of the unhatched chick. Within the shell-membrane is the albumen, or “white



of egg," in which are two twisted cords or *chalazæ* (so named from their supposed resemblance to hailstones), generally regarded as produced by the rotation of the egg as it passes down the oviduct.

Four layers of albumen have been distinguished. (a) The thin chalaziferous layer is dense and lies next to the yolk at the poles of which it is continuous with the chalazæ. (b) An inner layer of fluid albumen has been described as surrounding the chalaziferous layer, but Dr. Raymond Pearl and Miss Curtis cast doubt upon its existence. (c) The bulk of the "white of egg" is formed of dense albumen, consisting of a close network of interlaced, dense albumen fibres, with fluid albumen in the meshes. (d) Finally, the outermost layer of the "white" consists of fluid albumen.

The yolk of the egg, surrounded by a thin vitelline membrane, is not homogeneous but is composed of yellow and white material. The white yolk forms a flask-shaped mass, centrally placed, and thin concentric layers separating thick layers of yellow yolk. Both white and yellow yolk are composed of small spherules or granules unseparated by any

intervening fluid. The granules of the white yolk are exceedingly fine, those of the yellow yolk being coarser.

In whatever position the egg be placed, the upper surface of the yolk is occupied by a small, circular white patch, the *blastoderm* (cicatrix or "tread"). This consists of a disc of cells from which, and from which alone, the chick develops. The yolk and the blastoderm are the only parts of the egg which have their origin in the ovary. The albumen, shell-membrane, and shell, which form more than half of the total weight of a fully formed and normal egg, are produced by the oviduct. The importance of the oviduct is thus manifest.

The **oviduct** (Figs. 12 and 39) is a convoluted tube possessing considerable capacity for dilatation. It is suspended between the two layers of a fold of peritoneum which forms the membranous dorsal and ventral *ligaments of the oviduct*. The dorsal ligament has one of its borders attached to the duct while the other is fixed to the dorsal wall of the body from the caudal end of the body-cavity to the fourth thoracic rib. The ventral ligament has a free ventral border which is thick and muscular.

The oviduct may be divided into five parts,

each possessing its own particular physiological function. The first part lies immediately ventral to the ovary and is known as the *infundibulum* from its funnel-like form. Its anterior end is expanded into long processes which fringe an elongated, oblique slit-like opening by which the ovum gains entrance to the tube. Immediately succeeding the *infundibulum* is the *albumen-secreting part* of the oviduct. This forms more than half of the total length of the tube, and is remarkable for the thickness of its wall. The *isthmus* connects the albumen region with a thinner walled *uterus*; and this is continued by a comparatively narrow *vagina*, which opens into the cloaca.

Microscopically, the wall of the oviduct consists of the following layers:—(1) A serous investment furnished by the peritoneum. (2) A muscular tunic divided into two strata. The outer stratum consists of longitudinal and spiral fibres, continuous, as shown by Miss Curtis, with the muscular tissue in the dorsal and ventral ligaments of the oviduct.<sup>1</sup> The

<sup>1</sup> Miss Curtis was led to study the structure of the ligaments by the observation "that there is apparently a great disproportion between the amount of musculature in the walls of the duct (except in the uterus and vagina) and the degree of physiological activity

## 76 THE STRUCTURE OF THE FOWL

inner stratum of muscle is composed of fibres arranged mainly circularly. Separating the two muscular strata is a layer of connective tissue. In the thin-walled infundibulum muscular tissue is scanty, and two definite strata cannot be distinguished (Fig. 43). The amount of muscle gradually increases until in the uterus it is abundant, and forms a sphincter where the uterus ends and the vagina begins. In the vagina the outer stratum consists of scattered bundles of fibres, but the inner circular stratum is remarkably thick. (3) Submucous connective tissue joins the muscular tunic to the lining membrane. (4) The mucous membrane constitutes the most important part of the oviduct, since it is from the glands therein that the albumen, shell-membrane, and shell are derived.

Examined with the naked eye the mucous membrane is seen to be beset with longitudinally and slightly spiral folds on the sides of which are secondary folds. The folds are highest in the albumen-secreting part of the duct (Fig. 44) and least decidedly longitudinal

---

of this organ." It seems possible that the muscle within the ligaments—especially abundant at the caudal end of the ventral ligament—may assist in the movement of the egg along the duct.

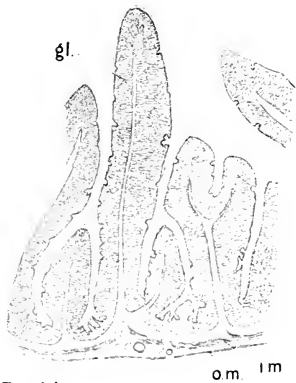

Fig 44.

Section of Albumen-secreting Part of Oviduct under Low Magnification.

gl., fold of mucous membrane containing numerous tubular glands; i.m., inner stratum of muscle; o.m., outer stratum of muscle.

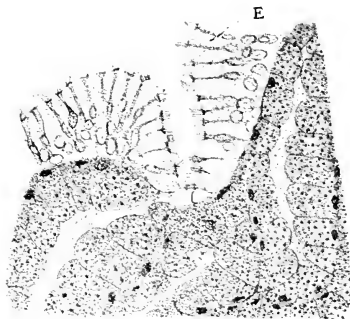

Fig 45

Section of Albumen-secreting Part of Oviduct showing the Opening of a Tubular Gland. (Frank M. Surface.)

E. goblet-cell.



Fig-46

Epithelium from albumen-secreting Part of Oviduct showing Ciliated Columnar and Goblet Cells. (Frank M. Surface.)



Fig 51.

Section through Coats of the Eyeball at the Exit of the Optic Nerve, under Low Magnification.

r., retina; ch., choroid; s., sclera; cart., cartilage; o.n., optic nerve.

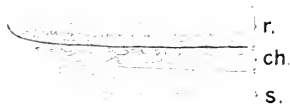

o.n.



in the uterus where they are broken into a network by transverse and oblique folds.

Microscopically, the free surface of the membrane is covered by a layer of columnar epithelial cells which, according to Dr. F. M. Surface, are of two different kinds. Ciliated columnar cells are intermixed with goblet-cells in about equal proportion (Fig. 46). In the first part of the infundibulum goblet-cells are apparently absent, this region being lined by ciliated cells only. The bulk of the thickness of the mucous membrane is composed of glands. According to Surface these are shallow depressions in the infundibulum, are absent in the vagina, and are few or absent in a narrow area sharply separating the albumen-secreting region from the isthmus. In the other parts of the oviduct the glands are large and so abundant as to be closely packed together. Each gland is very long, tubular, and branched, and lined by a granular epithelium. Before secretion actually takes place the granules of the epithelium are large; but after the egg has passed on its way towards the vagina they are much finer. The albumen of the egg is secreted by the albumen region of the oviduct; the shell-membrane by the isthmus;

and the shell itself by the uterus.<sup>1</sup> Possibly the shell-cuticle and some of the colouring matter is formed by the vagina.

Though the right oviduct is abortive and functionless, it is often represented by a rudimentary tube opening into the cloaca.

<sup>1</sup> Dr. Raymond Pearl and Miss Curtis, from their observations on the amount of albumen present at different periods before the laying of the egg, have come to the conclusion that fluid albumen enters by osmosis through the shell-membrane even when the egg has reached the uterus. Accordingly, albumen may continue to be added to the egg until so much shell has been deposited as to stop the process.



## VIII

### THE CIRCULATORY SYSTEM

THE relatively large **heart** (Fig. 12) is enclosed in a thin, membranous *pericardium*, and lies partly between the two lobes of the liver, partly cranial to that organ. Conical in form, its apex is directed in a caudal direction and slightly to the left of the median plane. The exterior shows a shallow groove indicating a division into two atria, forming the base, and two ventricles constituting the greater part of the bulk of the organ. The walls of the atrial portion are thin, while those of the ventricles are much thicker.

Into the *right atrium* open the large veins—a caudal vena cava and two cranial venæ cavæ—by which the blood is drained from all parts of the body with the exception of the lungs. A muscular fold, known as the Eustachian valve, lies to the right of the

caudal caval opening. The opening from the right atrium into the right ventricle is crescentic in outline, and is provided with a strong muscular plate, which replaces the membranous tricuspid valve of mammals.

In the *left atrium* is a common opening through which the two pulmonary veins pour the blood after it has passed through the lungs. The opening from this atrium into the left ventricle is circular in outline and is guarded by membranous flaps corresponding to the bicuspid valve of mammals. The septum between the two atria is thin and has a still thinner oval area—the *fossa ovalis*—near its centre.

The wall of the *right ventricle* is much thinner than that of the left, and the septum between the two cavities bulges towards the right, with the result that, if a transverse section be made of the ventricular mass, the left cavity is circular in outline while the right is crescentic. At the base of the right ventricle is the opening into the pulmonary artery guarded by three pocket-like semilunar valves, the open mouths of which look away from the heart.

The *left ventricle* has thick walls except at the apex. The aorta leaves the base of the

cavity and has semilunar valves similar to those in the pulmonary artery. Tendinous cords (*chordæ tendineæ*) are attached to the bicuspid valve on the one hand and to papillary muscular elevations of the ventricular wall (*musculi papillares*) on the other.

### THE ARTERIES (FIG. 47)

The single **pulmonary artery**, arising from the right ventricle, soon divides into right and left branches, each entering one of the lungs.

The **aorta** leaves the base of the left ventricle and immediately supplies two *coronary arteries* to the substance of the wall of the heart itself. After a very short course, the aorta appears to divide into two almost equal branches. The right of these, however, is the true continuation of the aorta, as will be evident if it is followed as it curves round the right bronchus to pursue an approximately median course through the thorax and abdomen. The aorta, therefore, before bending round the bronchus, gives off two large branches:—first the *left brachiocephalic artery*, and later the *right brachiocephalic artery*. Each of these divides into a common carotid and a subclavian artery. The *common carotid artery* supplies blood to

the head and neck; while the *subclavian* divides into a *brachial artery* for the wing and a large *pectoral artery* chiefly concerned in carrying blood to the large pectoral muscular mass.

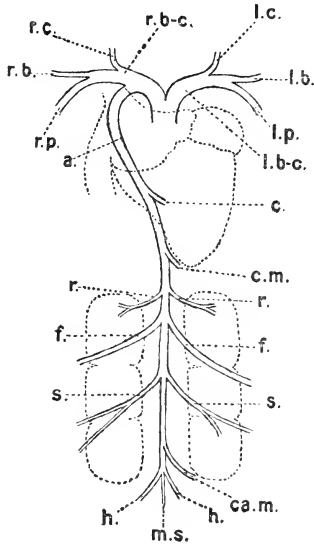

FIG. 47.—Diagram of the chief Arteries.

r.b-c., right brachio-cephalic; l.b-c., left brachio-cephalic; r.c., right carotid; l.c., left carotid; r.b., right brachial; l.b., left brachial; r.p., right pectoral; l.p., left pectoral; a., aorta; c., coeliac; c.m., cranial mesenteric; r., renal; f., femoral; s., sciatic; ca.m., caudal mesenteric; h., hypogastric; m.s., middle sacral.

From the neighbourhood of the right bronchus, the aorta passes backwards ventral to the vertebral column, supplying paired *intercostal* and *lumbar arteries* corresponding to the intervals between the vertebræ. The following arteries are also furnished to the organs within the abdomen and pelvis and to the legs. The single *coeliac artery* supplies

the liver, spleen, glandular stomach, gizzard, and a part of the intestine. The *cranial mesenteric artery*, also single, furnishes blood to most of the intestine. The paired *renal*

*arteries* enter the anterior lobe of the kidneys. The *femoral* and *sciatic arteries* pass into the leg, the latter also supplying the middle and posterior lobes of the kidney. A single *caudal mesenteric artery* goes to the rectum and cloaca, and a pair of *hypogastric arteries* supply the walls of the pelvis. The aorta terminates as a single caudal or *middle sacral artery* which passes into the tail.

### THE VEINS (FIG. 48)

Each lung is drained by a **pulmonary vein** which joins its fellow just before reaching the left atrium into which they open in common. The blood from the rest of the body is carried to the right atrium by the three *venæ cavæ*. Each of the two **cranial venæ cavæ** is formed by the union of a *jugular vein*, which drains the head and neck, and a *subclavian vein* corresponding to the artery of the same name.

The comparatively short **caudal vena cava** is formed by the union of the right and left *common iliac veins* just cranial to the kidneys. It runs towards the heart, buried more or less in the right lobe of the liver, and opens into the right atrium. *Hepatic veins* convey the blood from the liver into the vena cava, and

open into this vessel close to the point where it leaves the liver.

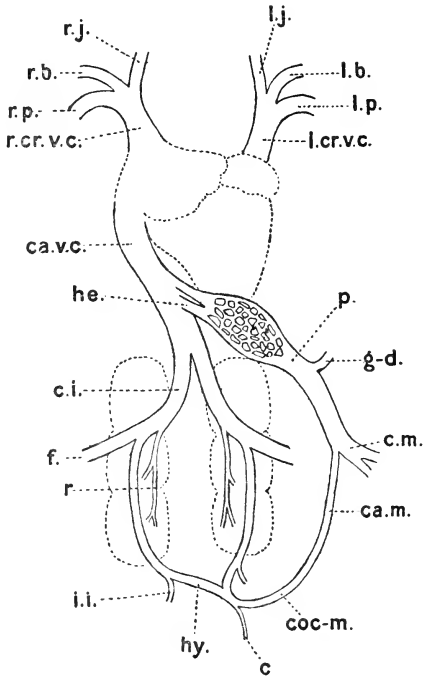

FIG. 48.—Diagram of chief Veins.

r.j., right jugular; l.j., left jugular; r.b., right brachial; l.b., left brachial; r.p., right pectoral; l.p., left pectoral; r.cr.v.c., right cranial vena cava; l.cr.v.c., left cranial vena cava; ca.v.c., caudal vena cava; he., hepatic; p., portal; g-d., gastro-duodenal; c.i., common iliac; c.m., cranial mesenteric; ca.m., caudal mesenteric; coc-m., coccygeo-mesenteric; f., femoral; i.i., internal iliac; r., renal; hy., hypo-gastric; c., caudal.

The arrangement of veins in the region of the kidneys is somewhat complicated. A comparatively small and single *caudal vein* is

reinforced by a vessel—the *coccygeo-mesenteric vein*—which communicates with the caudal mesenteric vein. After this union, the caudal vein divides into the two *hypogastric veins*, each of which is joined by an *internal iliac vein* from the wall of the pelvis. The hypogastric vein enters the kidney and traverses its posterior and middle lobes to join the *femoral vein* in the groove between the middle and anterior lobes. The femoral vein returns the blood from the leg, and, after uniting with the hypogastric, is joined by the *renal vein*, thus becoming the *common iliac vein*.

As in mammals the blood is carried from the stomach and intestines to the liver by the *portal vein*, which is formed by the union of *gastro-duodenal*, *cranial mesenteric*, and *caudal mesenteric veins*; the last named being connected with the vessels about the kidneys by means of the coccygeo-mesenteric vein.

**Lymph-vessels.**—The body of the fowl is richly furnished with lymph-vessels, the largest of which are the right and left *thoracic ducts*. These run towards the neck on each side of the vertebral column and open into the jugular veins. Though lymph-vessels are numerous, lymph-glands are few and small.

ORGANS ASSOCIATED WITH THE  
CIRCULATORY SYSTEM

The body contains several organs which, though not strictly a part of the circulatory system, are so intimately connected therewith as to justify a short description of them in this place. One of these organs, the spleen, may be regarded as interpolated in the path of the blood-stream between the splenic artery and the splenic vein. Other organs, such as the thyroid and adrenal, may be looked upon as glands without ducts for the transference of the material they elaborate to a free surface. This heterogeneous group of structures, frequently designated the *ductless glands*, have this feature in common: they discharge the products of their activity directly into the vascular system. Some of them produce substances known as hormones, which are capable of producing marked effects upon the metabolic or nutritive processes of the body.

The spleen (Fig. 15) lies immediately to the right of the junction of the glandular and muscular stomachs. In colour it is reddish brown, and in form it is generally rounded. Under the peritoneum, which forms a thin serous invest-



ment to the organ, the spleen is surrounded by a fibrous and muscular capsule, from which sparse trabeculæ are continued into the interior to form a coarse net-like fibrous skeleton. A very delicate reticulum, running throughout the whole organ, contains spleen-pulp within its meshes. Collections of lymphoid tissue are associated with the smaller branches of the splenic artery. The walls of the terminal branches of the artery become defective and thus permit the escape of blood into the spleen-pulp, which is consequently largely composed of blood corpuscles.

The **thyroid gland** is composed of two lateral lobes which may be found internal to the jugular vein in the angle formed by the divergence of the subclavian and common carotid arteries. The thyroid consists of microscopic closed vesicles lined by epithelium and containing a homogeneous colloid material.

The **thymus** is only present at its maximum in young chicks, where it is in the form of a lobulated body extending along the entire length of the neck. It diminishes in size with age, and in old birds may be entirely absent.

The **adrenals** in the adult are oval or elongated bodies (from 8 to 10 mm. long) lying

medial to the anterior lobe of the kidneys. In mammals distinct and separate cortical and medullary portions can be distinguished; but in the fowl cortical and medullary cords of polyhedral cells are irregularly intermingled. The cells composing the medullary cords have an affinity for chromic acid and are consequently designated chromaffin. Apparently the adrenal is a dual organ with a double embryonic origin. According to current views, the cortical cells are derived from ingrowths of the peritoneum, while the medullary cords are developed from sympathetic ganglia.

## IX

### THE NERVOUS SYSTEM

THE nervous system consists of central organs—the brain and spinal cord—and peripheral nerves and ganglia. In addition to the protection afforded by the bones of the cranium and vertebral column, the central nervous system is surrounded by a membranous investment which not only serves a protective function but also furnishes a distributing area for blood-vessels previous to their entry into the substance of the nerve masses.

The membranes, or **meninges**, of the brain and spinal cord consist of an outer, strong, fibrous investment, the *dura mater*, and a more delicate vascular membrane, the *pia mater*, closely applied to the surface of the brain and cord. Between these membranes is a scanty representative of the mammalian arachnoid mater.

The **spinal cord** is a bilaterally symmetrical column of nerve-matter extending through the greater part of the vertebral column from the foramen magnum of the occipital bone where it is continuous with the brain. The diameter of the cord is not uniform inasmuch as there are swollen sections with which the nerves of the limbs are connected, and its caudal extremity in the sacrum is tapering and finely thread-like. On the dorsal surface of the enlargement (lumbar) from which the nerves of the leg arise, the two halves of the cord separate to enclose an elliptical sinus in which is contained a gelatinous substance.

A transverse section shows that the cord consists of two symmetrical halves, and reveals the presence of a minute *central canal* traversing its whole length. The section also demonstrates that two kinds of nerve-tissue enter into its formation. White nerve-matter, composed essentially of nerve-fibres, forms an outer covering to grey matter within. The grey matter is arranged in the form (in transverse sections) of two masses, shaped something like a comma, one in each half of the cord, placed back to back and connected by a transverse grey band embracing the central

canal. Grey nerve-matter contains nerve-cells, the largest of which are found in the ventral part of the mass and give origin to motor nerve-fibres.

The Brain (Fig. 49).—In accordance with its

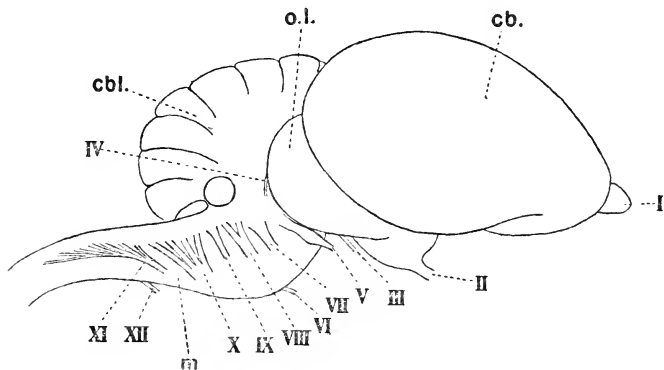

FIG. 49.—Brain seen from the Side.

cb., cerebral hemisphere ; o.l., optic lobe ; cbl., cerebellum ; m., medulla oblongata ; I., olfactory lobe ; II. to XII., 2nd to 12th cerebral nerves.

development from three hollow dilatations of the embryonic neural tube (see p. 130), the brain may be divided into three main parts—the hind-brain, the mid-brain, and the fore-brain. The original cavities of the embryonic vesicles are represented by the ventricles and the aqueduct, which are continuous with the central canal of the spinal cord.

The chief structures of the adult brain may be tabulated as follows :—

Hind-Brain	{	Medulla oblongata. Cerebellum. Fourth ventricle.
Mid-Brain	{	Peduncles of the cerebrum. Optic lobes. Aqueduct.
Fore-Brain	{	Thalamus. Pineal body. Infundibulum. Hypophysis. Optic tracts and chiasma. Cerebral hemispheres. Olfactory lobes. Third ventricle. Lateral ventricles.

The *medulla oblongata* bears a close resemblance to the spinal cord, with which it is continuous at a somewhat abrupt bend. The medulla, however, is wider than the cord, and in it the central canal widens out into the *fourth ventricle*.

The *cerebellum* lies upon and is connected with the medulla oblongata. In front it is in contact with the cerebral hemispheres. Elongated and

oval in form, the cerebellum is composed of a row of transverse folia, and carries a small appendage or *flocculus* on its lateral surface.

The term *peduncles of the cerebrum* is applied to those slightly diverging columns of nerve-tissue which form the forward continuation of the medulla oblongata and disappear under the optic tracts and chiasma. Lateral to each peduncle, and between it and the cerebral hemisphere, appears one of the *optic lobes* from which an optic tract apparently takes origin.

If the two cerebral hemispheres be separated from each other, two rounded eminences, the *thalami*, will be revealed; and behind these is disclosed a small, single, and median object, the *pineal body*.

On the ventral surface of the brain there is little difficulty in determining the presence of two *optic tracts* which appear to be directly derived from the optic lobes. Each tract sweeps forwards and towards the middle line to meet and fuse with its fellow at the *chiasma*, whence spring the diverging optic nerves which pass to the eyeballs.

The term *hypophysis* is applied to a rounded object suspended from the rest of the brain by

a hollow stalk, the *infundibulum*, and placed immediately behind the optic chiasma.

The two *cerebral hemispheres* form the most conspicuous parts of the brain. Each presents a convex surface looking towards the bones of the cranium. With the exception of a shallow groove, which possibly represents the lateral fissure (of Sylvius) of the mammalian brain, this surface is smooth. The hemispheres are applied to each other by flat faces, and are connected by a transverse band of nerve-fibres known as the *anterior commissure*.

The *olfactory lobe* of the fowl's brain forms a projection in advance of the anterior end of each cerebral hemisphere. From the lobe the olfactory nerves take origin to pass to the mucous membrane of the nasal cavity.

The cavity of the embryonic vesicles is represented in the adult brain by the ventricles and the aqueduct. The *lateral ventricles* are contained within the cerebral hemispheres, and in the floor of each is an eminence, the *corpus striatum*. An opening, the *interventricular foramen*, connects the lateral ventricles with the *third ventricle* which separates the two thalami from each other. The *aqueduct* runs through the mid-brain and forms a



considerable cavity within the optic lobes. It forms a connection between the third and fourth ventricles. The last-named occurs between the medulla oblongata and the cerebellum and into it opens the minute central canal of the spinal cord.

Twelve pairs of **cerebral nerves** take origin from the brain. They are named in the same manner as the mammalian nerves and have essentially the same distribution, namely:—I., *olfactory*; II., *optic*; III., *oculo-motor*; IV., *trochlear*; V., *trigeminal*; VI., *abducent*; VII., *facial*; VIII., *acoustic*; IX., *glosso-pharyngeal*; X., *vagus*; XI., *accessory*; XII., *hypoglossal*.

**Spinal nerves**, each arising by two roots from the spinal cord, agree in name and number with the vertebræ. The dorsal root of each nerve possesses a *spinal ganglion* as in mammals. The last two or three cervical and the first one or two thoracic nerves join in the formation of a *brachial plexus* from which the nerves supplying the wing are derived. The sacral nerves form two plexuses which furnish the nerves of the leg.

The **sympathetic system** of nerves consists of a double chain of ganglia lying immediately ventral to the vertebral column. The ganglia

are linked together by longitudinal fibres, and are connected with the spinal nerves by communicating branches. From the ganglia fine grey nerves arise and are distributed to the alimentary, respiratory, reproductive, and circulatory organs.

## X

### THE EYE AND ITS APPENDAGES

THE eye of birds is relatively large, and is lodged in an orbit with indifferently developed bony walls. The bony margin of the orbit is incomplete, and the two orbital cavities, in the dried skull, communicate with each other through a defect in the interorbital septum which forms a thin partition between them.

Of the two eyelids, the lower is the better developed and the more movable. A thin *nictitating membrane*, or third eyelid, is mainly concealed within the medial angle of the eye when not in use. It is, however, so extensive as to be capable of covering the whole anterior surface of the eyeball, its movements being effected with great rapidity through the action of the pyramidal and quadrate muscles. Associated with the membrane is a gland of some size. A delicate and exquisitely sensitive

membrane, the **conjunctiva**, covers the front of the eyeball and the inner surface of the eyelids, a continuous secretion of tears keeping the opposed surfaces moist. The **lachrymal gland**, by which the tears are secreted, lies above and to the lateral side of the eyeball. The tears are drained away from the front of the eyeball by two small canals which lead into a lachrymal sac. Thence they travel into the nasal cavity by way of the nasolachrymal duct.

The movements of the eyeballs are effected by four straight and two oblique muscles, comparable to those of mammals, except that the superior oblique does not play through a pulley.

In shape the **eyeball** of the fowl (Fig. 50) may be said to consist of the segments of two spheres of different curvature, connected by a conical intermediate portion. The posterior segment corresponds to the greater part of the sclera; the anterior segment is formed by the cornea; and the conical connection consists of that part of the sclera in which the bony scleral ring is developed. The *cornea* is of horny consistence and transparent, and thus offers no obstacle to the passage of light into the interior of the eyeball. The *sclera* is dense and white, and

consists of an internal layer of hyaline cartilage with a superposed layer of fibrous tissue. Close to its junction with the cornea the sclera contains a bony *scleral ring*.

Within the sclera is a vascular and pigmented tunic divisible into choroid, ciliary body, and iris. The *choroid* is a thin, dark-coloured

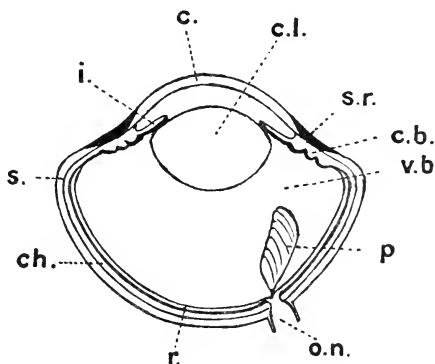

FIG. 50.—Section through the Eyeball.

c., cornea; c.l., crystalline lens; i., iris; s.r., scleral ring; c.b., ciliary body; v.b., vitreous body; s., sclera; ch., choroid; r., retina; p., pecten; o.n., optic nerve.

membrane lining the posterior part of the eyeball. The *ciliary body* is the thickened and radially folded anterior part of the choroid. Associated with it is the *ciliary muscle*, composed of striated fibres, upon which depends the rapidly effected accommodation of the eye for near or distant objects. A remarkable structure, known as the *pecten*, projects into

the interior of the eyeball from the region of the entrance of the optic nerve. The pecten is folded in a fan-like manner, and is pigmented and vascular like the choroid, of which it may be regarded as an appendage.

Continuous with the choroid is the *iris*, a pigmented diaphragm pierced by a round *pupil*. The yellow colour of the iris of the fowl is apparently dependent upon the presence of fat-globules contained within its cells. The contraction and dilatation of the pupil is brought about by the action of sphincter and dilator muscle-fibres embedded in the substance of the iris.

Within the choroid is the thin *retina*, consisting of nerve-cells and fibres directly or indirectly continuous with the optic nerve and arranged in layers as in the mammalian eye. The *crystalline lens* is a colourless, transparent, biconvex object with a posterior surface somewhat more convex than the anterior. The lens is connected with the ciliary body, and, being elastic, its convexity can be modified through the agency of the ciliary muscle.

The eyeball in front of the lens contains a watery fluid; while behind the lens the cavity is occupied by a clear, jelly-like *vitreous body*.

## XI

### THE EAR

IN birds, the ear does not form any external appendage to the head. An opening, surrounded by a fringe of feathers, leads into a canal which ends at the *tympanic membrane*, a thin partition separating the external passage from the tympanic cavity. The **tympanum**, or drum of the ear, is an irregular cavity in the temporal bone placed in communication with the throat by the *auditive* or *Eustachian tube*, which opens in common with its fellow of the opposite side of the head. Across the tympanic cavity stretches a rod-like bone, the *columella*, one end of which is in contact with the tympanic membrane, while the other, somewhat expanded and disc-like, fits into an oval opening, the *fenestra vestibuli*, in the inner wall of the cavity.

The **inner ear**, containing the essential parts of the organ of hearing, is embedded in the temporal bone medial to the tympanum and consists of a bony and a membranous labyrinth. The former consists of a central cavity, or *vestibule*, from which proceed three *semi-circular canals* and a *cochlea*. The cochlea differs from the corresponding tube of mammals in being short and only slightly curved instead of spirally coiled. The membranous labyrinth is divisible into two parts. The superior part consists of a *utricle* and two *sinuses* (posterior and superior) and three *semicircular ducts*, each with an *ampulla*. The semicircular ducts are superior, posterior, and lateral, and are arranged along different planes of the head. The superior duct is in a vertical and longitudinal plane; the posterior duct lies in a transverse and vertical plane; the lateral duct is practically horizontal. The inferior part of the membranous labyrinth consists of a *cochlear duct* and a *saccul*e with which is connected an *endolymphatic duct* ending as a small sac in the dura mater within the cranium. The saccule may be regarded as an appendage to the utricle. The cochlear duct contains the essential organ by which sound waves are



transmuted into nerve-impulses, and is the only part of the labyrinth actually concerned in hearing. The other parts of the labyrinth are apparently related to equilibration.

## XII

### THE SKIN AND ITS APPENDAGES

THE skin of birds is very thin and contains no glands except the *uropygial* or oil gland which lies over the last vertebra. This is two-lobed and about the size of a pea in the fowl. The oily secretion used by the bird to dress the feathers is produced by numerous tubules which pour their secretion into a common cavity, from which it gains the surface by an opening at the summit of a nipple-like projection of the skin.

A thin, dry, and scurfy epidermis covers those parts of the skin on which feathers grow, while the naked part of the leg is clothed with scales. The toes carry claws, and a horny sheath covers the beak.

The skin is very sensitive in virtue of the numerous nerve-endings associated with it generally and more especially with the roots

of the feathers. Bundles of muscle-fibres are so arranged that their contraction erects the feathers. For the most part the corium or dermis of the skin is not very vascular, the comb and wattles, however, forming an exception.

Feathers are epidermic structures partly embedded in follicles of the skin. A typical feather (Fig. 52) consists of an axis or *scapus* and a *vexillum* or vane. The lower part of the axis is known as the *calamus* or quill, and is rounded, transparent, and hollow, with a series of conical scales in its interior. At the end of the quill is a small opening, the *inferior umbilicus*, into which projected a papilla of the dermis

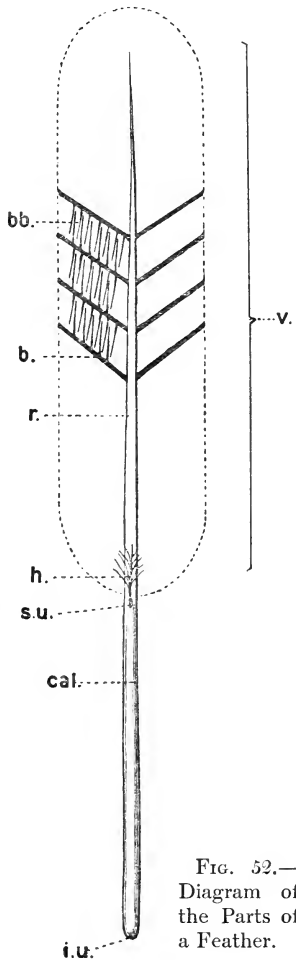

FIG. 52.—  
Diagram of  
the Parts of  
a Feather.

v., vexillum; b., barb; bb., barbules; r., rachis; h., hyporhachis; s.u., superior umbilicus; cal., calamus; i.u., inferior umbilicus.

during the period of development of the feather. About the junction of the quill and the vane is another small opening, the *superior umbilicus*, and in this region arises a small, variable tuft, the *aftershaft* or hyporhachis.

The axis of the vane, the *rhachis*, is solid, four-sided, tapering, and elastic, with a longitudinal groove running along that surface which looks towards the body when the feather is in position. The vane itself consists of two rows of narrow, slender lamellæ, or *barbs*, springing from the rhachis and sloping obliquely outwards and towards the tip of the feather. Each barb, in its turn, carries two rows of *barbules*. The barbules of the distal row, *i.e.* those which grow from that side of the barb which looks towards the tip of the feather, are provided with microscopic hooklets which hook on to the doubled-over edge of the barbules of the proximal row. By this interlocking of the barbules, the vane is converted into a continuous elastic whole, capable of offering the necessary resistance to the air during flight.

All the feathers of the body are not of the same size or form. The largest are the *remiges* of the wing and the *rectrices* of the tail. The

remiges have the posterior portion of the vane broader than the anterior and are divided into *primaries*, borne by the second and third metacarpal bones and the digits continuous therewith, and the *secondaries* arranged along the ulnar side of the forearm. The first digit or thumb supports an independent tuft of feathers known as the *false wing* (*ala spuria*). The rectrices, or quill feathers, of the tail have the two sides of the vane about equal in breadth.

The bases of the remiges and rectrices are concealed by *covert feathers*—the wing coverts and the tail coverts. Over the rest of the body are *contour feathers*, and under them the small feathers, known as *plumules*, which constitute the down. The last-named differ from the largest feathers in being of softer and slender structure, and in having no interlocking hooklets on their barbules. There are still smaller feathers called *filoplumes* with hair-like scapes and very rudimentary vanes.

As may be readily determined by the examination of a plucked fowl, the feathers are arranged along definite lines and areas, which have been named *pterylæ*; the intervening tracts devoid of feathers being known as *apteria*.

The epidermic nature of the feathers is very evident when their development is watched (Fig. 53). The first indication of feather-formation is an upward growth of the dermis or sensitive and vascular part of the skin, and the consequent production of a papilla. Next, the skin immediately around the papilla sinks downwards as a moat-like depression, so that before long the papilla comes to be enclosed in a follicle in the skin. The epidermis over the papilla, like that over the rest of the skin, consists of two layers :—(a) a horny outer layer, and (b) a deep germinative layer composed of cells which are soft at first but finally become horny. The horny outer layer of epidermis forms a protective sheath for the growing feather and is cast off when the feather is formed. The feather itself develops from the underlying germinative layer, which, as it grows, forms a cylinder of cells. The lower part of this cylinder embraces the dermic papilla, and, retaining its cylindrical form, ultimately becomes the calamus or quill : while the upper part of the cylinder develops ridges, these subsequently separating to form the barbs of the vane. When the feather is fully grown the dermic papilla upon which it has

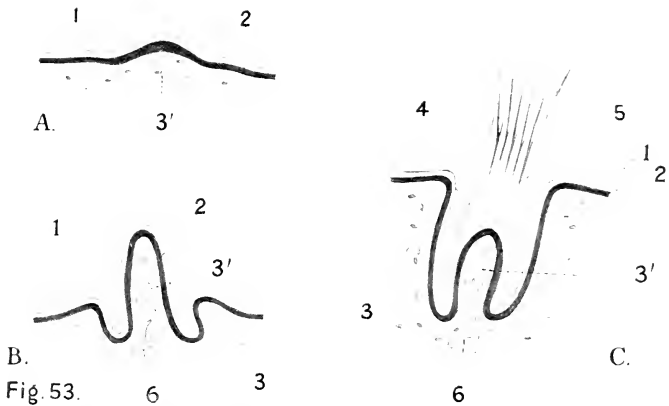

Diagram of Three Stages, A, B and C, in the Growth of a Feather.

1, horny layer of epidermis ; 2, germinative layer of epidermis ; 3, dermis which forms a papilla at 3' ; 4, follicle containing feather ; 5, young feather ; 6, blood-vessels.

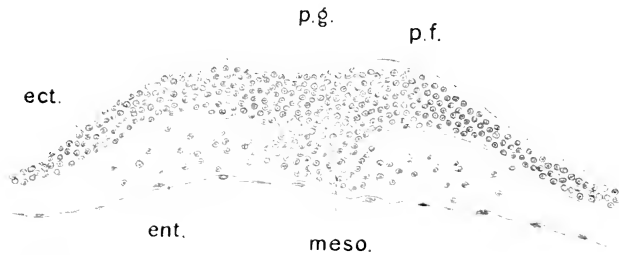

Fig. 57.

Transverse Section through the Primitive Streak.

p.g., primitive groove ; p.f., primitive fold ; ect., ectoderm ; ent., entoderm ; meso., mesoderm.





developed and from which it has derived its nourishment, is withdrawn from the cavity of the quill, and the inferior umbilicus is plugged by some of the conical scales which occupy the interior of the quill. When the time comes for the old feathers to be moulted, the feather-follicle again becomes active. A new feather is formed and pushes out the old feather.

## XIII

### DEVELOPMENT OF THE CHICK

**Oogenesis.**—The egg during its genesis passes through three stages—division, growth, and maturation. The first stage takes place before the female chick is hatched, and comes to an end about the time of hatching. It consists of the rapid increase of small ova by repeated division; with the result that the ovary of the newly-hatched chick contains a large number of large cells from which the eggs, as we know them when laid, are to be produced.

About the time of hatching the ova enter into the second stage, during which there is a considerable increase in size accompanied by the formation of yolk. The ova are now contained in definite follicles within the ovary. Each ovum is surrounded by a layer of cubical epithelial cells (Figs. 40 and 41), and the follicle is provided with a *theca* formed by a con-

centric arrangement of the fibres of the adjacent stroma. Examination of the ovary of a laying hen shows that there is a regulation of the degree of growth of the ova, since all sizes are present from the smallest to one or two of such dimensions as to lead to the conclusion that they are almost or quite ready to escape into the oviduct.

The third period of oogenesis, or stage of maturation, takes place partly while the ovum is still within the ovarian follicle and partly after it has escaped into the oviduct and is undergoing fertilisation. Maturation consists of two unequal divisions. By each division the ovum is split into a small cell—known as the *polar body*—and a large cell which will be regarded as the ovum proper. The two polar bodies do not contribute to the formation of the embryo, but degenerate and disappear. Their production has for its object a reduction in the number of chromosomes, or stainable elements, of the nucleus of the ovum. The mature ovum, therefore, is deficient in chromosomes, the normal number being restored only when the nucleus of the spermatozoon—which has also lost chromosomes during a comparable process of maturation—combines

with the nucleus of the ovum in the process of fertilisation.

The later phases of the stage of growth produce an increasing projection of the follicle within which the ovum is contained, with the result that its connection with the main ovarian mass is ultimately reduced to a narrow pedicle. The follicle finally ruptures along a predestined linear *stigma*, and the ovum, surrounded itself with a *vitelline membrane*, falls into the wide infundibulum of the oviduct. The follicle now shrivels up without the formation of anything comparable to the corpus luteum of mammals.

The ovum is propelled along the oviduct in a spiral manner by the contractions of the walls of the tube, and during its passage receives the albumen, shell-membranes, and shell. In the oviduct, also, fertilisation occurs and a certain amount of division, or segmentation, takes place.

**Fertilisation.**—The process of fertilisation consists of the union of the ovum and spermatozoa. Spermatozoa are capable of travelling the entire length of the oviduct and lie in wait for the newly-extruded ova in the region of the infundibulum. It is evident that they

can retain their vitality for a considerable time, for it is known that hens may lay fertile eggs for three weeks or longer after the last commerce with the male bird. In birds, as well as in other animals in which the egg is large, it is apparently the normal condition for several spermatozoa to enter one egg (polyspermy). In mammals polyspermy is regarded as abnormal.

Immediately after the ovum has escaped from the ovarian follicle it is surrounded by a crowd of spermatozoa, a number of which pierce the egg-membrane and enter the germinal disc. What becomes of the tails of the spermatozoa is not known with certainty. The heads, however, enlarge and become *sperm-nuclei*, which remain quiescent until the ovum has completed the formation of polar bodies. Then the egg-nucleus approaches the sperm-nucleus and the two fuse to form a common nuclear mass—the *first segmentation nucleus*—which, after a short resting stage, begins to divide by that process of mitosis commonly followed by animal cells in general.

**Segmentation.**—The fertilised egg is morphologically a single cell in which the bulk of the protoplasm, with the nucleus, is confined to

## 114 THE STRUCTURE OF THE FOWL

the germinal disc. The remainder of the egg consists of food material which takes no part in the division of the cell, but, by its presence, limits division or cleavage to the germinal disc.

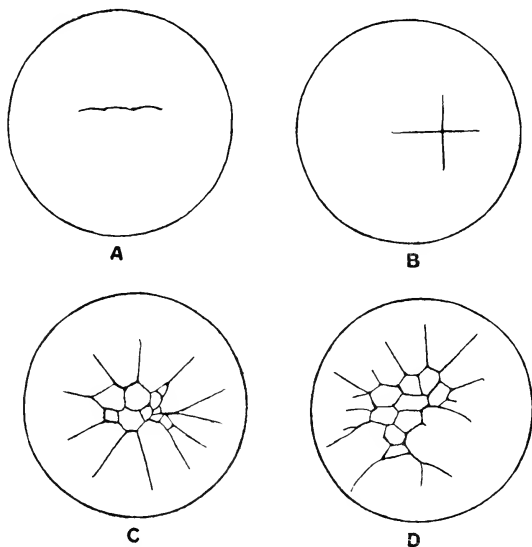

FIG. 54.—Surface View of the Blastoderm showing the Lines of Segmentation.

A, first line of segmentation ; B, second line of segmentation producing the 4-celled stage ; C and D, later stages.

The first division in the disc (Fig. 54 A) occurs along a vertical plane at right angles to the long axis of the egg, and results in the production of two cells very imperfectly separated from each other. The second cleavage (Fig. 54 B)

is along a plane at right angles to the first. As the result of repeated synchronous division, it comes to pass that the germinal disc is composed successively of 2, 4, 8, 16, 32, etc., cells. A point is ultimately reached when division ceases to be so regular and multiplication of cells in geometrical progression ceases to obtain.

At first the cells are not completely separated from each other because the earlier processes of cleavage affect only the surface of the germinal disc. In other words, up to the 16- or 32-cell stage segmentation is effected by the multiplication of nuclei separated from each other by furrows which indent the surface of the germinal disc, but are not continued on the deeper surface of the cells. After the 16- or 32-cell stage the more central cells begin to divide in such a fashion that new cells are produced underneath them. That is to say, the cleavage, which at first affected only the surface of the germinal disc, begins to invade the deeper parts. In this way the central portion of the disc becomes changed into a cellular mass separated from the underlying white yolk by a small, fluid-containing space known as the *segmentation* or *subgerminal*

*cavity*. By extension of the process of segmentation in a peripheral direction, a disc of cells, the *blastoderm*, is produced before the egg is laid. In some manner, not as yet perfectly understood, the cells of the blastoderm are differentiated into two strata—a superficial *ectoderm* and a deeper *entoderm*. When the egg is laid and the temperature falls in consequence, development of the blastoderm is arrested until such time as the temperature is again raised by incubation.

The unincubated blastoderm is a whitish disc, some 4 mm. in diameter, which presents a central and more transparent area, the *area pellucida*, over the region of the subgerminal cavity, and a peripheral and less transparent zone distinguished as the *area opaca*. The embryo itself develops within the *area pellucida*; while from the rest of the blastoderm spring those extra-embryonic membranes whose function is concerned with respiration, nutrition, and protection.

The first four days of incubation are marked by the rapid extension of the blastoderm, which, by the fourth day, has spread beyond the confines of the original germinal disc and covers a great part of the surface of the yolk



(Fig. 55). The area opaca becomes differentiated

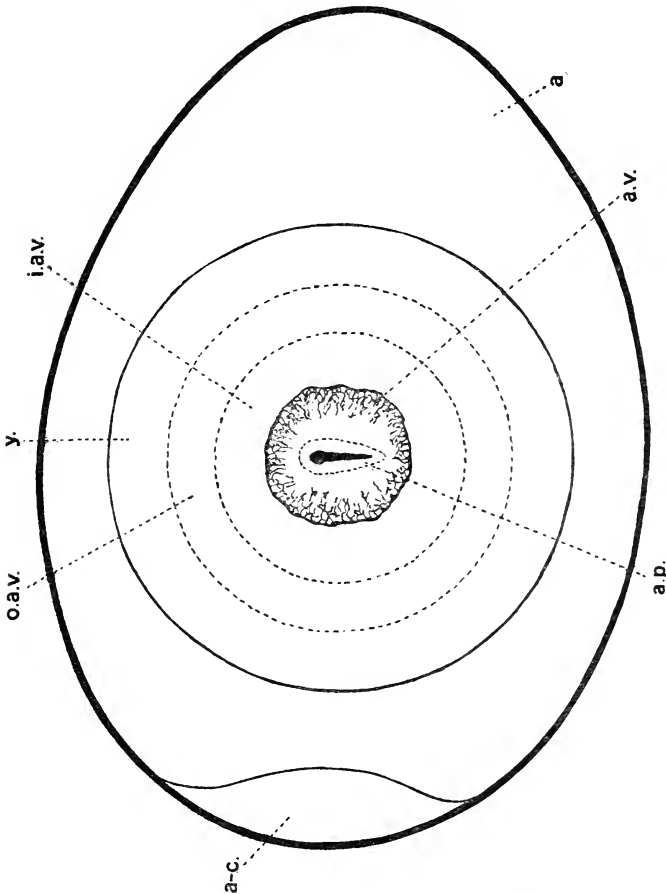

FIG. 55.—Diagram of the Blastoderm within the Egg about the End of the First Day of Incubation.

a.p., area pellucida containing the embryo; a.v., area vasculosa of opaque area; i.a.v. and o.a.v., inner and outer vitelline zones of the opaque area; y., yolk still uncovered by blastoderm; a., albumen; a-c., air-chamber.

into two zones. In the innermost of these, the *area vasculosa*, blood-vessels are developed. The surrounding zone is known as the *vitelline*

*area*, and is itself divisible into inner and outer zones.

**Primitive Streak (Fig. 56).**—During the first day of incubation, an elongated, dim band, the primitive streak, makes its appearance in the pellucid area. The anterior end of the streak

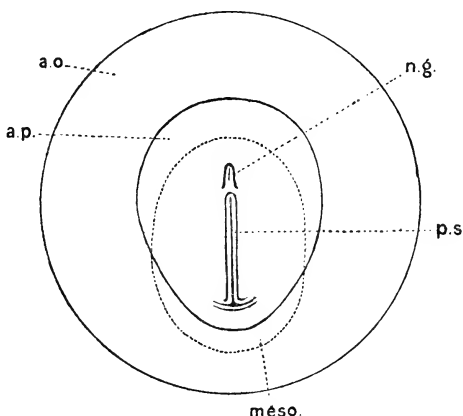

FIG. 56.—Primitive Streak and its Surroundings.

p.s., primitive streak ; n.g., neural groove ; a.p., area pellucida ;  
a.o., area opaca ; meso., mesoderm.

as a rule is placed near the centre of the pellucid area ; while the posterior end, somewhat broader, is less definite. It is now generally accepted that the primitive streak is produced by a linear thickening of the ectoderm.

As development proceeds the primitive

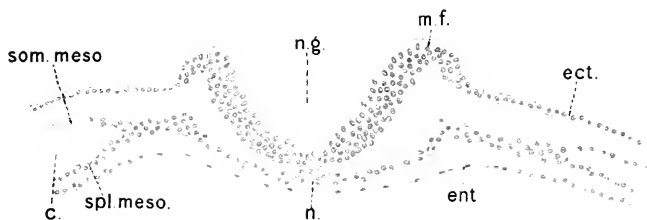

Fig. 58.

### Transverse Section through the Neural Groove.

n.g., neural groove; m.f., medullary fold; n., notochord; ect., ectoderm; ent., entoderm; som.meso., somatic mesoblast; spl.meso., splanchnic mesoblast; c., coelome.

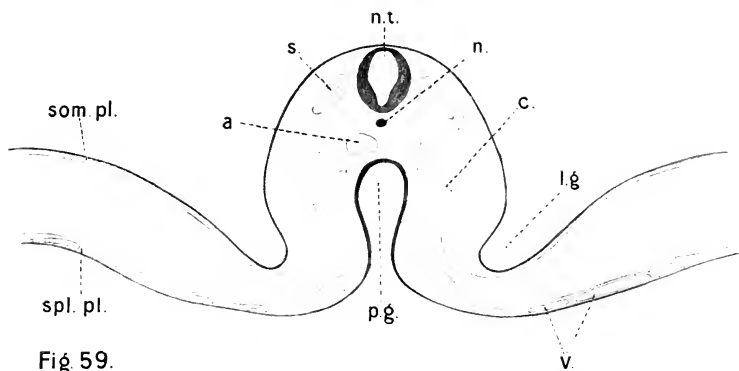

Fig. 59.

### Transverse Section of Embryo.

n.t., neural tube; n., notochord; s., somite; a., aorta; c., coelome; l.g., lateral limiting groove; som.pl., somatopleure; spl.pl., splanchnopleure; p.g., primitive gut; v., blood-vessel.



streak elongates in a posterior direction, the pellucid area elongating commensurately. In this way the area becomes first oval and then pear-shaped. During its elongation the streak develops a *primitive groove* on its surface. The groove is bounded laterally by the *primitive folds* (Fig. 57) and ends anteriorly in the *primitive pit*. The anterior extremity of the primitive streak does not become invaded by the groove.

The embryo itself makes its appearance in front of the primitive streak, which gradually diminishes in length as the embryo elongates. How much of the embryo is represented in the primitive streak is still open to question; but it seems certain that the view formerly held that the streak contributes nothing to the formation of the embryo is no longer tenable.

**Separation of the Embryo.**—The formation of the embryo is first indicated on the surface of the blastoderm by the appearance, during the second half of the first day of incubation, of a *neural groove* (Fig. 58) bounded laterally by the longitudinal *medullary folds*. The folds meet each other and fuse, thus converting the groove into the *neural tube* (Fig. 59) from which arise the brain and spinal cord. The union of the folds is first effected in that region which will

later become the mid-brain or the anterior part of the hind-brain. From this point the conversion of the groove into the neural tube spreads forwards and backwards, but is not completed posteriorly until after the entire disappearance of the primitive streak. The final point of closure at the anterior end of the embryo is known as the *neuropore* and is regarded as of great morphological importance.

During the early stages of development there is no distinction between the limits of the embryo and the rest of the blastoderm. Before the end of the first day, however, a crescentic infolding, or *head-fold*, makes its appearance at the head end of the embryo. This, and a similar but shallower *tail-fold* with a pair of *lateral folds* finally produce a continuous furrow all round the embryo, which is thus marked off from the rest of the blastoderm (Figs. 63, 64, and 65). From that part of the blastoderm outside the furrow extra-embryonic membranes are produced. By this time the *notochord*, a very important structure characteristic of all vertebrate embryos and the forerunner of the vertebral column, has made its appearance beneath the neural groove.

**Orientation of the Embryo.**—The developing

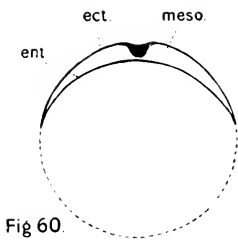

Fig 60.

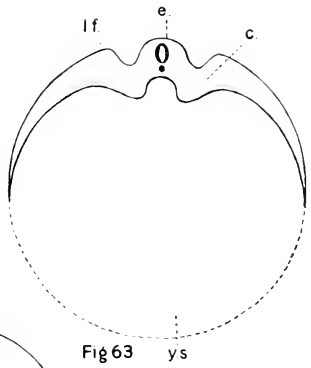

Fig 63

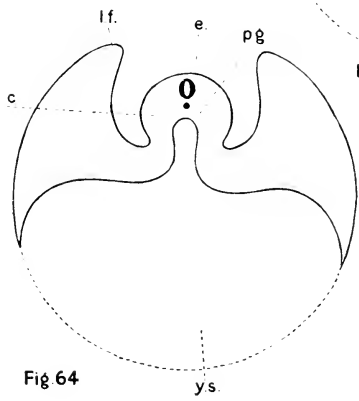

Fig 64

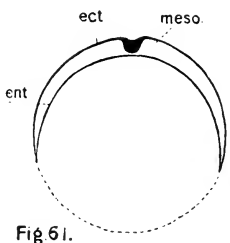

Fig 61.

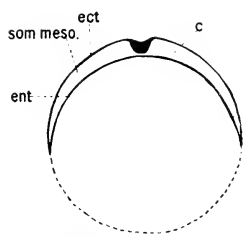

Fig 62.

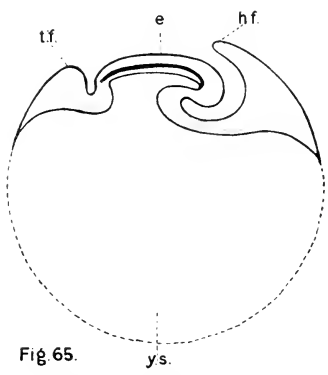

Fig 65.

FIGS. 60, 61 and 62.—Diagrams of Transverse Sections of Blastoderm to illustrate Extension and Splitting of Mesoderm.  
 ect., ectoderm ; ent., entoderm ; meso., mesoderm ; som. meso., somatic mesoblast ; c., coelome.

FIGS. 63 and 64.—Diagrams of Transverse Sections to illustrate the Separation of the Embryo from the rest of the Blastoderm.  
 e., embryo ; l.f., lateral fold of amnion ; c., coelome ; p.g., primitive gut ; y.s., yolk sac.

FIG. 65.—Diagram of Longitudinal Section to illustrate the Separation of the Embryo.  
 e., embryo ; h.f., head fold of amnion ; t.f., tail fold of amnion ; y.s., yolk sac.





embryo has a definite and nearly constant orientation in relation to the long axis of the egg. However the egg may lie, the developing embryo, like the germinal disc which it replaces, will be above. The long axis of the embryo, moreover, lies at right angles to the long axis of the egg, and if the latter be placed on a table with its broad end away from the observer the head end of the embryo will be towards the right. Though this position is not absolutely constant, it is sufficiently so to render it possible with considerable certainty to distinguish the anterior and posterior ends of the blastoderm before a definite embryo has made its appearance.

**Mesoderm.**—During the early hours of incubation a third layer of the blastoderm begins to form between the ectoderm and the entoderm. This is the *mesoderm* (Fig. 57), and consists of cells derived from the thickened ectoderm which forms the primitive streak and from the so-called head-process of the blastoderm immediately in front of the streak. The mesoderm gradually extends to the edge of the pellucid area and then invades the opaque area (Fig. 56).

In the mesoderm of the opaque area blood-

islands — the predecessors of blood - vessels — make their appearance and the vascular area thus comes into existence. Towards the end of the first day a distinction can be made between the mesoderm in the immediate vicinity of the neural groove and notochord and that which is more lateral. The mesoderm in the region of the notochord constitutes the *paraxial mesoblast*, while the more peripheral mesoderm is known as the *lateral plate*. Very soon after the formation of the head-fold, the paraxial mesoblast begins to be invaded by transverse clefts, and is thus cut up into blocks or segregations of cells known as the *mesoblastic somites*. The first somite to be formed lies close to the anterior end of the primitive streak, and the others form in succession behind it. Nevertheless there is always a certain amount of unsegmented mesoblast between the anterior end of the primitive streak and the somite last formed.

Within the lateral plate of the mesoblast a splitting also takes place, but in a horizontal instead of a transverse direction. A series of small cavities appear within the plate, and by their fusion divide it into an outer *somatic layer* (Figs. 60, 61, and 62) and an inner or

*splanchnic layer*. The somatic layer becomes closely associated with the ectoderm and thus forms the *somatopleure*, while the splanchnic layer similarly unites with the entoderm to form the *splanchnopleure* (Fig. 59). The space between somatopleure and splanchnopleure is the *body-cavity* or *cœlome*.

Between the somites and the lateral plate is a narrow zone of mesoblastic cells forming the *nephrotome* or *intermediate cell-mass* from which urinary and reproductive organs develop.

By the extension of the mesoblast round the yolk, and as a consequence of the splitting of the lateral plate of the mesoblast, it follows that ultimately the splanchnopleure immediately over the yolk is separated by cœlome from the somatopleure and becomes the wall of a sac containing the yolk and therefore known as the *yolk-sac*. Associated with this is the gradual accentuation of the head-, tail-, and lateral-folds, which result in a tucking-in of the body-wall underneath the embryo. In this way the opening on the under surface of the embryo is gradually reduced and the embryo is connected by a comparatively narrow stalk with the extra-embryonic structures derived from the rest of the blastoderm. From

the circumstance that the coelome is not limited to the embryo, but also invades extra-embryonic territory, it follows that the stalk consists of two tubes, one within the other. The outer tube forms a connection

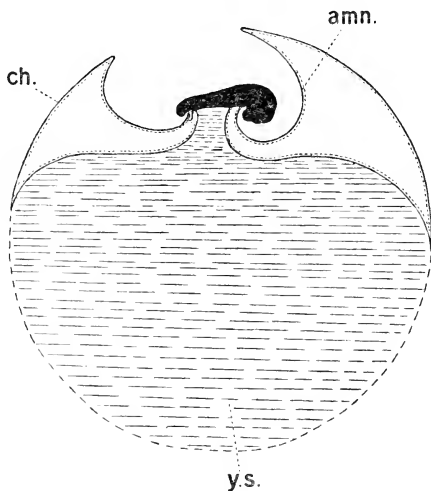

FIG. 66.—Diagram showing the Mode of Development of the Embryonic Membranes. Early stage.

ch., chorion; amn., amnion; y.s., yolk-sac.

between the somatopleure or body-wall of the embryo and the extra-embryonic somatopleure. The inner tube connects the yolk-sac with the intra-embryonic part of the splanchnopleure, *i.e.* with the primitive gut (Fig. 64). The space between the two tubes is a part of the

cœlome, and the opening in the body-wall of the embryo is the *umbilicus*.

**Formation of Embryonic Membranes (Figs. 66, 67, and 68).—**The fully formed membranous in-

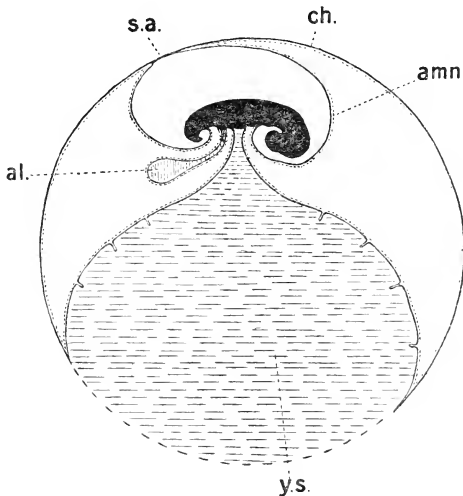

FIG. 67.—Diagram showing the Mode of Development of the Embryonic Membranes. About fourth day.

ch., chorion; amn., amnion; al., allantois; y.s., yolk-sac;  
s.a., sero-amniotic connection.

vestments of the embryo are three in number—*chorion*, *amnion*, and *allantois*—to which may be added the yolk-sac. The chorion and amnion are formed by the extra-embryonic somatopleure in the following manner. A fold of the somatopleure rises up in front of and folds over the

head of the embryo. This is the head-fold of the amnion. The side arms of the fold extend backwards along the sides of the embryo, where they likewise rise upwards and fold over

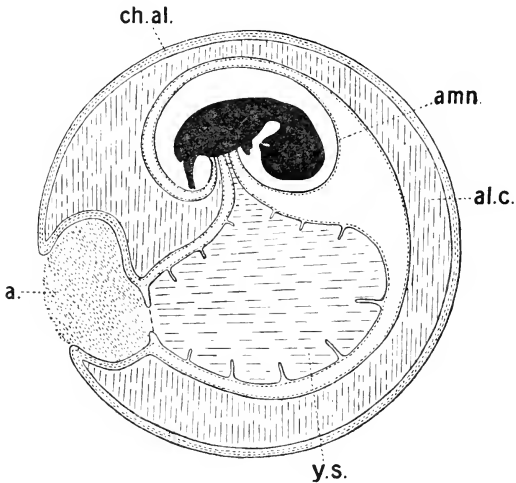

FIG. 68.—Diagram showing the Mode of Development of the Embryonic Membranes. About tenth day.

amn., amnion ; y.s., yolk-sac ; ch.al., fused chorion and allantois ; a., remains of albumen ; al.c., allantoic cavity.

the back of the embryo. A similar tail-fold makes its appearance and curves over the hinder end of the embryo to coalesce with the lateral- and head-folds. Confluence of the folds results in the enclosure of the embryo within two membranous sacs—an inner, the

amnion, and an outer, the chorion—separated from each other everywhere except at the *sero-amniotic connection*, marking the last point at which the various folds became continuous with each other.

The amnion is connected with the body-wall of the embryo at the ever-narrowing umbilicus. Between the embryo and the amnion the *amniotic fluid* accumulates. The chorion is at first surrounded by the albumen of the egg; but as this becomes absorbed the chorion approaches and finally comes into contact with the inner shell-membrane.

It is clear from their mode of formation that the chorion must consist of ectoderm on the outside with an inner lining of mesoblast, while the amnion must be formed by mesoblast on the outside with ectoderm on the side looking towards the embryo.

The allantois has an altogether different origin inasmuch as it springs originally from the embryo itself. Soon after the production of the tail-fold of the embryo a hollow bud makes its appearance in the ventral wall of the primitive gut (Fig. 69). During the fourth day of incubation this bud, the rudiment of the allantois, grows out into the extra-embryonic

cœlome and quickly extends round the hinder end of the embryo as a pear-shaped bladder. It then rapidly enlarges and forms a flattened sac between the chorion and amnion, with both of which it enters into intimate union. From the beginning the allantois is very vascular, and consequently acts as an organ of respiration and for the absorption of albumen. At the same time it receives the excretion produced by the embryonic kidneys.

Seeing that the allantois is derived from the splanchnopleure, it follows that it will consist of mesoblast with an inner lining of entoderm.

Though the yolk-sac may be included among the embryonic membranes, it differs materially in origin and fate from the chorion, amnion, and allantois. It commences as the splanchnopleure surrounding the mass of the yolk, but as development proceeds it necessarily becomes gradually smaller consequent upon the absorption of the yolk. At first it is a simple rounded bag, but the folding-in of the body-wall results in the pinching off of a portion of the original sac and the inclusion of this part within the embryo, where it forms the rudiment of the alimentary canal. By



the narrowing of the umbilicus the communication between the gut and the yolk-sac becomes obliterated. The yolk is dissolved and absorbed by the entodermal lining of the sac, and is thereupon carried to the embryo by veins—the *vitelline veins*—which ramify in the wall of the sac. Towards the end of incubation the yolk-sac is retracted into the body-cavity through the umbilicus, which then closes.

Although the yolk-sac becomes smaller as incubation proceeds, it has been shown that, at the same time, it develops into a more complex organ of absorption in order to keep pace with the needs of the rapidly growing embryo. The interior of the sac, originally smooth, early develops folds and ridges which become taller as incubation proceeds. There seems good reason to believe that these folds are produced in order to facilitate the absorption of the yolk.

Until such time as the allantois is formed, the yolk-sac acts as a respiratory organ as well as one concerned in the absorption of food material.

**Nervous System.**—The first indication of the development of the nervous system appears

before the end of the first day of incubation in the form of the neural groove bounded on each side by a medullary fold (Fig. 58). By approximation and union of the folds the groove is converted into a tube. Three dilatations or vesicles are produced in that part of the tube which will ultimately become the brain; the rest of the tube—from which the spinal cord develops—remaining of fairly uniform calibre throughout. The three primary dilatations are known as the *fore-brain*, the *mid-brain*, and the *hind-brain* vesicles (Fig. 70), and from each certain definite parts of the adult brain are formed. The wall of the hind-brain vesicle is early marked by transverse constrictions demarcating segments known as *neuromeres*, six in number. Three comparable neuromeres have been described as occurring in the fore-brain, and two in the mid-brain: making eleven in all. The original lumen of the neural tube is represented in the adult by the central canal of the spinal cord and the ventricles of the brain.

Even before the union of the medullary folds is effected, lateral expansions of the wall of the anterior end of the neural tube mark the first traces of the *optic vesicles* from which

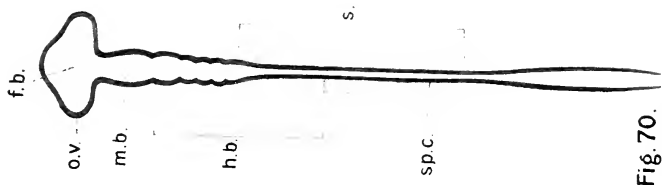

**Fig. 70.**

Embryonic Central Nervous System.

f.b., fore-brain; o.v., optic vesicle; m.b., mid-brain; h.b., hind-brain; sp.c., spinal cord; s., somites.

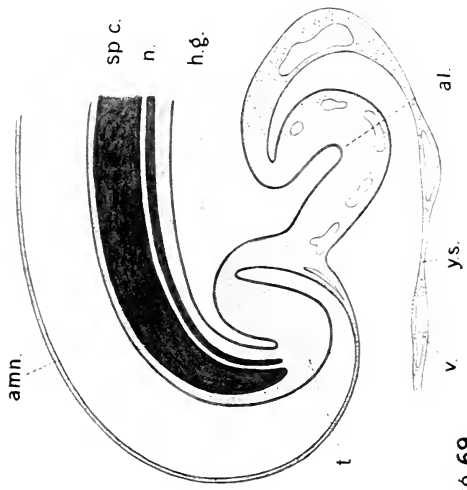

**Fig. 69.**

Longitudinal Section of Tail End of Embryo showing Early Development of Allantois.

al., allantois; h.g., hind gut; n., notochord; sp.c., spinal cord; t., tail; amn., amnion; y.s., wall of yolk sac; v., blood-vessel.



the nervous elements of the eyes are produced. The cavity of the optic vesicle is at first widely continuous with the cavity of the fore-brain, but as development proceeds the connection is narrowed and a hollow *optic stalk* is produced. The optic vesicle is converted into a cup by an invagination of its more distal part. The cavity between the two walls of the cup thus produced is obliterated and the hollow of the optic stalk disappears as a consequence of the formation of the fibres of the optic nerve. The inner layer of the cup becomes the retina of the fully formed eye.

The ectoderm of the surface of the head becomes invaginated and thickened opposite the optic cup, thus producing a pit which soon closes and forms a sac. The cavity of the sac disappears, the cells composing the wall of the sac become modified, and the lens is formed.

Opposite the ninth, tenth, and eleventh neuromeres the surface ectoderm begins to thicken about the time when twelve mesoblastic somites have been formed. An *auditory pit* is thus produced by invagination, and, by the gradual closing of the mouth of the pit,

an *auditory sac*, or *otocyst*, is formed. This is the rudiment from which the labyrinth of the ear is developed.

**Alimentary and Respiratory Tracts.**—With the formation of the head- and tail-folds of the embryo, the intra-embryonic splanchnopleure is constrained to take a tubular form which becomes more pronounced as development proceeds. Narrowing of the umbilicus produces a growing constriction between the splanchnopleure within and the yolk-sac outside the embryo. The primitive gut thus formed ends blindly at the head and the tail end of the embryo, where ectodermal pits, the *stomodæum* and *proctodæum* respectively, grow inwards to meet and ultimately become continuous with the ends of the gut.

The primitive gut may be divided into three parts :—(1) the mid-gut connected with the yolk-sac ; (2) the fore-gut from which is formed the pharynx, œsophagus, the respiratory tract, the stomach, and the duodenum, as well as out-growths which result in the thyroid, thymus, liver, and pancreas ; (3) the hind-gut, which develops into the large intestine with its cæca, and from which the allantois grows in the embryo.

Early in development the wall of the pharynx is marked by four visceral pouches corresponding to each of which is an ectodermal invagination (visceral furrow) on the surface of the embryo. The ectoderm of the furrows comes into contact with the entoderm of the pouches, and for a short time there are actual clefts placing the cavity of the pharynx in communication with the exterior. On the third day an evident constriction, corresponding to the œsophagus, appears immediately behind the pharynx, while beyond this is a fusiform dilatation which will develop into the stomach. By the eighth day a crop is readily distinguishable as a dilatation of the œsophagus. Up to the fifth day no difference can be detected between the glandular stomach and the gizzard, but after this time structural changes occur in the embryonic stomach which permit of the distinction being made. On the sixth day the duodenal loop begins to form. From this time onwards the small intestine undergoes rapid elongation, that part of it with which the yolk-sac is connected forming coils which lie outside the abdomen until, about the fifteenth day, they are drawn within the body. The two cæca begin to grow out

from the hind-gut on the seventh day and elongate rapidly.

The liver arises from the entoderm of the duodenum in the form of two diverticula, anterior and posterior, growing outwards as ramifying solid entodermal cords which invade veins. The lumen of the venous cavities is thus converted into numerous cleft-like spaces or *sinusoids*. The solid cords later become converted into hollow tubes by excavation of their interior, the lumina constituting the bile-channels.

The pancreas begins to form at about the seventy-second hour. It arises from the duodenal entoderm as three diverticula—dorsal and right and left ventral—which branch repeatedly without intercommunication.

On the ventral wall of the pharynx a groove makes its appearance. From this right and left diverticula are developed. The groove becomes the larynx and trachea, and the diverticula develop into the two bronchi and the various air-passages of the lungs.

**Urinary Organs.**—The embryonic urinary organs of birds are represented by three structures which appear in succession.

1. The *pronephros* or *head-kidney* develops



from the intermediate cell-mass lying between the paraxial and lateral mesoblast. It consists of tubules apparently of no functional value, and disappears after the fourth day. Associated with the pronephros is the *Wolffian duct*, which, from its mode of formation, may be divided into two parts. The anterior part is produced by the union of pronephric tubules, while the posterior portion consists of an extension of the anterior part backwards to the cloaca.

2. The *mesonephros* or *Wolffian body* is of importance since it acts as a urinary organ during a certain part of embryonic life. Some of its tubules, moreover, contribute to the formation of the male reproductive organs. The origin of the mesonephros is from epithelial vesicles, which make their appearance in the intermediate cell-mass. The vesicles elongate into tubules, one end of which joins the *Wolffian duct*. The other end of each tubule becomes invaginated to form a capsule enclosing a glomerulus of blood-vessels: that is to say, Malpighian corpuscles are formed comparable to those present in the adult kidney. Additional mesonephric tubules form until the fifth day, when new formation ceases. De-

generation of the tubules begins on the tenth or eleventh day, but they do not completely disappear until about the time of hatching. It is evident that the mesonephros or Wolffian body functions as an excretory organ until the permanent kidneys are capable of taking over the duty.

3. The *metanephros* or permanent kidney has a double mode of formation. The true kidney tissue is formed from two or three somites of the trunk, while the collecting tubules and the definitive ureter are produced by the elongation and branching of a diverticulum from the posterior part of the Wolffian duct.

**Reproductive Organs.**—In the development of the reproductive system there is an indifferent stage during which it is impossible to determine whether the embryo is male or female. During this period gonads and reproductive ducts are present, but there is no indication of the kind of germ-cells to be produced by the gonads, nor which set of ducts will persist and which degenerate.

The gonads are produced on the medial side of the Wolffian body, their germ-cells being derived from an area of peritoneal epithelium

known as the *germinal epithelium*. The reproductive tubes are the *Wolffian* and *Müllerian ducts*. The former originates in connection with the urinary organs (pronephros) as already stated. The first trace of the Müllerian duct is present on the fourth day in the form of a thickened ridge of peritoneum on the lateral aspect of the Wolffian body. The ridge becomes grooved and the groove closes into a tube. The tube grows slowly backwards and reaches the neighbourhood of the cloaca on the seventh day. In the male the development of this duct ceases on the eighth day, and it never opens into the cavity of the cloaca. In the female the right duct ceases to grow after the eighth day, and thereafter soon degenerates. The left female duct ultimately opens into the cloaca.

In the male the gonads become testes; the Wolffian ducts develop into the deferent ducts; and the tubules of the anterior part of the Wolffian bodies form the epididymides. The Müllerian ducts become rudimentary and disappear.

In the female the left gonad becomes the left ovary; the right atrophies. The Wolffian ducts disappear; the left Müllerian duct develops into

the oviduct; the right atrophies; and the tubules of the Wolffian bodies degenerate.

**The Embryonic Circulatory System.**—The first indication of a blood-vascular system is the appearance, at an early period, of “blood-islands” in the opaque area of the blastoderm. These become confluent and bounded by a peripheral *venous terminal sinus*, and thus give distinctive character to the area vasculosa of the blastoderm. When the horizontal splitting of the mesoblast takes place, and the somatopleure and splanchnopleure separate from each other, the primitive blood-vessels are confined to the splanchnopleure, *i.e.* they are present only in that extra-embryonic membrane which surrounds the yolk. The vascular network produced by the confluence of the “blood-islands” gradually extends inwards from the opaque area until the embryo itself is invaded.

During the first half of the second day the initial steps in the formation of the heart take place. The heart arises in the form of two thin-walled vessels running parallel to the long axis of the embryo about the place where vessels first reach the embryo from the vascular area. The two tubes approach each other

and fuse into one, which begins to beat slowly at first and then more rapidly. Into the posterior end of the single tube open two vitelline veins from the vascular area, and from the anterior end leave the two *primitive aortæ* (right and left), which bend upwards along the sides of the fore-gut and then course backwards towards the tail of the embryo. From the aortæ arise the two *vitelline arteries* which carry the blood back to the vascular area. Thus is established a circulation of blood from the yolk-sac to the embryo and from the embryo to the yolk-sac.

Elongation of the tubular heart, fixed at its two ends by its connection with vessels, causes it to become bent in an S-shaped manner, and so the arterial and venous ends are brought relatively close together. By the growth of septa the cavities of the adult heart are defined, but in the interatrial septum secondary perforations are formed which result in the production of a communication between the right and left atria—the *foramen ovale*—which remains patent until hatching has taken place. The septa between the cavities of the heart are completed by the end of the fifth or the beginning of the sixth day.

By this time important changes have taken place in the vessels of the embryo. The two primitive aortæ have united to form a single *dorsal aorta* arising from the heart as the right and left *aortic arches*. Other arches (making a total of six) appear in the region of the neck, but only three or four are present at one time. The first, second, and fifth arches do not remain long. The third arch ultimately forms the carotid artery, and from it springs the subclavian. The fourth arch on the left side disappears; while the corresponding arch on the right becomes the single aortic arch of the adult. Part of the sixth arch becomes the pulmonary artery. The *truncus arteriosus* or common origin of the aortic arches is divided longitudinally into the aorta and pulmonary artery. Complicated changes of the venous system within the embryo also occur.

The formation of an extra-embryonic system of vessels in the wall of the yolk-sac takes place, as has been said, at an early period. The formation of the allantois results in a second extra-embryonic circulation. The allantois carries arteries from the dorsal aorta to the chorion, which is thus rendered capable

of acting as an organ of respiration. After oxidation the blood is returned to the embryo by veins which ultimately (at the end of the third day) become continuous with the *umbilical veins*. These convey the blood to the liver, whence it finds its way by the caudal vena cava to the heart.

Obviously the embryonic circulation differs in several important respects from the circulation in the adult. As early as the eighth day of incubation a definite route has been assumed by the blood. The vitelline or omphalomesenteric veins carry blood laden with nutriment from the yolk-sac to the liver, where it is mixed with blood drained from the intestines by the portal vein. Within the liver the absorbed yolk doubtless undergoes some form of change, but exactly what or how is not clear. The right and left hepatic veins leave the liver and join the caudal vena cava, which opens into the right atrium of the heart. It seems more than probable, however, that little, if any, of the blood brought to the heart by the caudal vena cava actually enters the main cavity of the right atrium. Most, if not all, of it passes through the foramen ovale into the left atrium. From the left

atrium it enters the left ventricle, and thence is pumped into the aorta and supplies the body by arteries corresponding to those of the adult. The aorta of the embryo, however, gives off *omphalo-mesenteric arteries*, which carry blood to the yolk-sac—there to receive a fresh supply of nutriment—and *umbilical arteries*, conveying blood to the allantois in order that it may receive oxygen and get rid of carbon dioxide.

The blood carried by the carotid and sub-clavian arteries to the head, wing, and side of the thorax is returned to the right atrium by the two cranial venæ cavæ. From the atrium it passes into the right ventricle and so into the pulmonary trunk, which divides into right and left pulmonary arteries. The lungs, however, being as yet without function, admit of the passage of very little blood. Almost all the blood of the pulmonary artery is transferred into the aorta through a connection with this vessel known as the *ductus arteriosus*.

Purified blood is returned to the embryo from the allantois by an umbilical vein—the left of the two veins originally present—which joins the left hepatic vein. Clearly the purest



blood and the richest in nutriment is that which is carried to the heart by the caudal vena cava.

**Conformation of the Embryo.**—The external form of the embryo may be said to be dominated by three sets of factors. (1) In the early stages of development the central nervous system and the somites produce the elongated and curved character of the early embryo. (2) With the appearance of viscera, such as the heart, intestines, and liver, the external embryonic features are altered. (3) The development of the skeleton and muscles serves to produce definite avian external character, which gradually mask the outlines of the internal organs.

Prior to the sixth day the embryo presents no features by which it can be distinguished as avian in character. On the third or fourth day (Fig. 71) the whole embryo is much bent upon itself. A cervical flexure is very pronounced, but there is no definite neck. The brain gives distinct prominence to the head, especially in the region of the mid-brain. Eyes are present, and there are visceral clefts. The heart produces an external protuberance, and limbs are represented by bud-like outgrowths.

On the fifth day the embryo, lying on its left side, is still very much curved. The limb buds have elongated, and the position of the elbow- and knee-joints is indicated.

By the seventh day (Fig. 72) the cervical flexure is almost absent, and there is a well-defined neck. The eye is prominent, the mid-brain produces less bulging on the summit of the head, and the formation of a beak is recognisable. Development of viscera has resulted in prominence of the abdomen. The limbs have further elongated, and there are indications of digits.

On the eighth day (Fig. 73) the embryo is more definitely bird-like. Papillæ from which the feathers will grow are clearly visible and arranged along specific areas. The eyes are very prominent; but the mid-brain has almost entirely ceased to cause a protrusion on the summit of the head.

By the tenth day the fore-limb has assumed the characters of a wing, and the digits of the foot are completely separated.

Recognisable feathers have appeared by the thirteenth day.

**Hatching.**—The following is a brief account of the process of hatching as described by von

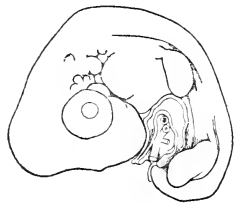

FIG. 71.

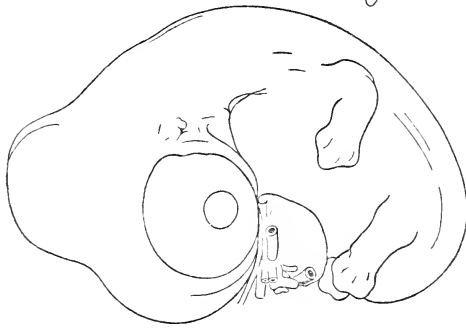

FIG. 72.

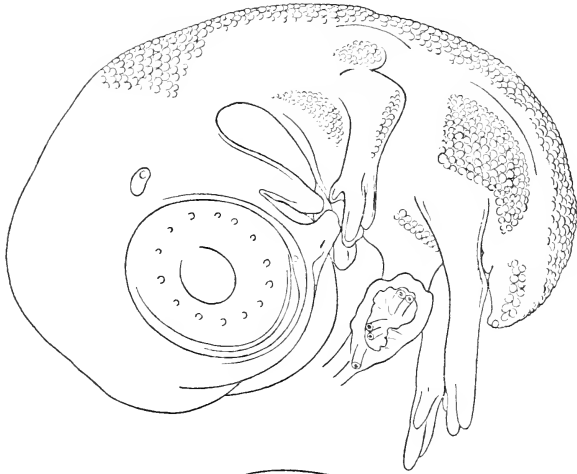

FIG. 73.

FIG. 71.—Embryo after 4 days' incubation. FIG. 72.—Embryo after 8 days' incubation. FIG. 73.—Embryo at the seventh day of incubation.

Baer. Some time about the fourteenth day the chick arranges itself lengthwise within the egg so that the head is towards the broad end and near the air-chamber. The head is bent upon the chest and usually tucked under the right wing. A few days later the neck assumes a double curve which brings the head forwards and the beak close to the inner shell-membrane enclosing the air-chamber. During this change the amniotic fluid diminishes in quantity. About the fifteenth day the coils of intestine, previously protruding through the umbilicus, are withdrawn into the abdomen. On the nineteenth day the yolk-sac also begins to retract, and by the twentieth day has entirely entered the abdomen. Thereupon the umbilicus becomes occluded.

On the twentieth day also the chick thrusts its beak—armed with a horny excrescence known as the “egg-tooth”—through the inner shell-membrane into the air-chamber, and begins to breathe by the lungs. The function of the allantois now being superseded, the umbilical vessels become occluded, and the membrane shrivels up and becomes detached at the umbilicus. That breathing by the lungs is initiated some time (possibly two days)

before hatching is evidenced by the chirping sounds which may be occasionally heard.

With the help of the “ egg-tooth ” the chick makes a small hole in the shell of the egg, and pulmonary respiration is fully established. The initial small opening is rapidly enlarged, and on the twenty-first day the chick emerges from the shell.



## INDEX

- Abdominal air-sacs, 62  
 Acetabulum, 32  
 Adrenals, 87  
 Aftershaft, 106  
 Air-sacs, 61  
 Albumen of egg, 72  
 Albumen-secreting part of oviduct, 75  
 Allantois, 125  
 Amnion, 125  
 Amniotic fluid, 127  
 Ampullæ, 102  
 Angular bone, 21  
 Anterior commissure, 94  
 Aortic arches, 140  
 Apteria, 107  
 Aqueduct of brain, 94  
 Arachnoid mater, 89  
 Area opaca, 116  
 Area pellucida, 116  
 Area vasculosa, 117  
 Artery or arteries—  
   aorta, 81  
   brachial, 82  
   brachio-cephalic, 81  
   caudal mesenteric, 83  
   cæliac, 82  
   common carotid, 81  
   coronary, 81  
   cranial mesenteric, 82  
   dorsal aorta, 140  
   femoral, 83  
   hypogastric, 83  
   intercostal, 82  
   lumbar, 82  
   middle sacral, 83  
   omphalo-mesenteric, 142  
   pectoral, 82  
   pulmonary, 81
- Artery or arteries (*contd.*)—  
   renal, 82  
   sciatic, 83  
   subclavian, 82  
   umbilical, 142  
   vitelline, 139  
 Articular bone, 21  
 Arytenoid cartilage, 58  
 Atlas, 11  
 Atria of heart, 79  
 Auditive tube, 24, 101  
 Auditory pit, 131  
 Auditory sac, 132  
 Aves, zoological position, 1  
 Axillary air-sac, 62
- Barbs of feather, 106  
 Barbules of feather, 106  
 Basi-branchial bone, 23  
 Basi-hyal bone, 23  
 Basi-temporal bone, 18  
 Blastoderm, 74, 116  
 Bones—  
   of the cranium, 17  
   of the face, 19  
   of the leg, 29  
   of the vertebral column, 9  
   of the wing, 25  
 Brachial plexus, 95  
 Brain, 91  
 Bronchi, 60  
 Bursa of Fabricius, 53
- Cæca, 50  
 Calamus of feather, 105  
 Carotid canal, 18, 24  
 Carpus, 27  
 Cartilages of larynx, 58  
 Cell-islets of Langerhans, 56

# 150 THE STRUCTURE OF THE FOWL

- Central canal of spinal cord, 90  
 Cerato-branchial bone, 23  
 Cerebellum, 92  
 Cerebral hemispheres, 94  
 Cerebral nerves, 95  
 Cervical air-sacs, 62  
 Cervical vertebræ, 11  
 Chalazæ, 73  
 Chalaziferous layer of albumen, 73  
 Chiasma, 93  
 Chordæ tendineæ, 81  
 Chorion, 125  
 Choroid, 99  
 Ciliary body, 99  
 Clavicle, 26  
 Clavicular air-sac, 62  
 Cloaca, 53  
 Coccygeal vertebræ, 13  
 Cochlea, 102  
 Cochlear duct, 102  
 Colon, 50  
 Columella, 101  
 Conformation of embryo, 143  
 Conjunctiva, 98  
 Contour feathers, 107  
 Coprodæum, 53  
 Coracoid, 26  
 Cornea, 98  
 Corpus striatum, 94  
 Covert feathers, 107  
 Cranial bones, 17  
 Cranial larynx, 57  
 Cricoid cartilage, 58  
 Crop, 45  
 Crystalline lens, 100  
  
 Deferent duct, 66  
 Dentary bone, 21  
 Development—  
   of adrenals, 88  
   of air-sacs, 62  
   of alimentary tract, 132  
   of circulatory system, 138  
   of ear, 131  
   of embryonic membranes, 125  
   of eye, 130  
   of feathers, 108  
   of intestines, 133  
   of kidneys, 134  
   of liver, 134  
   of nervous system, 129  
  
 Development (*contd.*)—  
   of pancreas, 134  
   of pharynx, 133  
   of reproductive organs, 136  
   of respiratory tract, 134  
   of spermatozoa, 67  
   of stomach, 133  
 Digits, 29, 34  
 Ducts of liver, 54  
 Ducts of pancreas, 55  
 Ducts of the testis, 70  
 Ductless glands, 86  
 Ductus arteriosus, 142  
 Duodenum, 50  
 Dura mater, 89  
  
 Ear, 101  
 Ectoderm, 116  
 Egg, 71  
 Egg-follicles, 70  
 Embryonic circulation, 141  
 Embryonic membranes, 124  
 Endolymphatic duct, 102  
 Entoderm, 116  
 Entoglossal bone, 23  
 Epididymis, 66  
 Epistropheus, 12  
 Ethmoid bone, 19  
 Eustachian tube, 24, 101  
 External tympaniform membrane, 59  
 Eye, 97  
 Eyeball, 98  
 Eyelids, 97  
  
 Fabricius, bursa of, 53  
 Facial bones, 19  
 False wing, 107  
 Feathers, 105  
 Femur, 32  
 Fenestra cochleæ, 24  
 Fenestra vestibuli, 24  
 Fertilisation, 112  
 Fibula, 33  
 Filoplumes, 107  
 First segmentation nucleus, 113  
 Flocculus, 93  
 Follicles of ovary, 70  
 Foramen magnum, 17, 23  
 Foramen ovale, 139  
 Foramen triosseum, 26  
 Foramina of the skull, 23



- Fore-brain, 91, 92  
 Fourth ventricle, 92  
 Frontal bones, 19  
 Fossa ovalis, 80  
  
 Gall-bladder, 54  
 Gallus ferrugineus (*bankiva*), 7  
 Germinal epithelium, 137  
 Gizzard, 48  
 Gland, nasal, 57  
 Glands—  
   of gizzard, 49  
   of intestine, 52  
   of mouth and pharynx, 43  
   of oviduct, 77  
   of stomach, 47  
   of trachea, 59  
 Glandular stomach, 46  
 Glomeruli of kidney, 65  
  
 Hard palate, 42  
 Hatching, 144  
 Head-kidney, 134  
 Heart, 79  
 Hind-brain, 91, 92  
 Hip bone, 30  
 Humerus, 27  
 Hyoid bone, 22  
 Hypophysis, 93  
  
 Ileum, 49  
 Ilium, 31  
 Incisive bones, 20  
 Inferior umbilicus of feather, 105  
 Infundibulum of brain, 94  
 Infundibulum of oviduct, 75  
 Inner ear, 102  
 Intermediate cell-mass, 123  
 Internal tympaniform membrane, 59  
 Interstitial cells of testis, 69  
 Interventricular foramen, 94  
 Intestines, 49  
 Iris, 100  
 Ischium, 32  
 Isthmus of oviduct, 75  
  
 Jejunum, 49  
 Jugal bone, 20  
 Jugular foramen, 18  
  
 Kidneys, 64  
  
 Lachrymal bone, 20  
 Lachrymal gland, 98  
 Lachrymal sac, 98  
 Langerhans, cell-islets of, 56  
 Large intestine, 50  
 Larynx, broncho-tracheal, 59  
 Larynx, cranial, 57  
 Lateral plate of mesoblast, 122  
 Lateral ventricles, 94  
 Ligaments of oviduct, 74  
 Liver, 53  
 Lobules of lung, 61  
 Lumbar vertebræ, 12  
 Lungs, 60  
 Lymph-glands, 85  
 Lymph-vessels, 85  
  
 Mandible, 21  
 Maxillæ, 19  
 Medulla oblongata, 92  
 Medullary folds, 119  
 Meninges of brain and cord, 89  
 Mesentery, 50  
 Mesoblastic somites, 122  
 Mesobronchus, 60  
 Mesoderm, 121  
 Mesonephros, 135  
 Metacarpus, 28  
 Metanephros, 136  
 Metatarsus, 34  
 Microscopic structure—  
   of adrenals, 88  
   of deferent duct, 70  
   of gizzard, 49  
   of glandular stomach, 47  
   of intestines, 50  
   of kidney, 64  
   of liver, 54  
   of lung, 60  
   of œsophagus, 45  
   of ovary, 70  
   of oviduct, 75  
   of pancreas, 55  
   of spleen, 87  
   of testis, 67  
   of trachea, 59  
 Mid-brain, 91, 92  
 Mouth, 40  
 Müllerian duct, 137  
 Muscle or muscles—  
   ambiens, 38  
   cardiac, 35

# 152 THE STRUCTURE OF THE FOWL

## Muscle or muscles (*contd.*)—

ciliary, 99  
 diaphragm, 36  
 involuntary, 35  
 of eyeball, 98  
 of iris, 100  
 pectoral, 37  
 pyramidal, 97  
 quadrate, 97  
 sterno-tracheal, 59  
 supracoracoid, 37  
 voluntary, 35  
 ypsilo-tracheal, 58  
 Muscular stomach, 48  
 Musculi papillares, 81  
 Nasal bones, 20  
 Nasal cavities, 57  
 Nasal gland, 57  
 Nephrotome, 123  
 Nerves, cerebral, 95  
     spinal, 95  
     sympathetic, 95  
 Neural groove, 119  
 Neural tube, 119  
 Neuromeres, 130  
 Neuropore, 120  
 Nictitating membrane, 97  
 Nostrils, 57  
 Notochord, 120  
 Obturator foramen, 32  
 Occipital bone, 17  
 Oesophagus, 44  
 Olecranon, 27  
 Olfactory lobe, 94  
 Oogenesis, 110  
 Optic foramen, 23  
 Optic lobes, 93  
 Optic stalk, 131  
 Optic tracts, 93  
 Optic vesicles, 130  
 Orbit, 97  
 Orientation of embryo, 120  
 Otocyst, 132  
 Ovary, 70  
 Oviduct, 74  
 Palatine bone, 20  
 Pancreas, 55  
 Parabronchia, 60  
 Paraxial mesoblast, 122  
 Parietal bones, 19

Patella, 32  
 Pecten, 99  
 Peduncles of cerebrum, 93  
 Pelvic girdle, 29  
 Perching mechanism, 38  
 Pericardium, 79  
 Pharynx, 42  
 Pia mater, 89  
 Pineal body, 93  
 Plumules, 107  
 Polar bodies, 111  
 Porta, 54  
 Primaries (feathers), 107  
 Primitive aortæ, 139  
 Primitive folds, 119  
 Primitive groove, 119  
 Primitive pit, 119  
 Primitive streak, 118  
 Proctodæum, 53, 132  
 Pronephros, 134  
 Ptanium, 38  
 Pterygoid bone, 20  
 Pterygiæ, 107  
 Pubis, 32  
 Pupil, 100  
 Pygostyle, 13  
 Quadrate bone, 22  
 Quadrato-jugal bone, 20  
 Quill feathers, 106  
 Radius, 27  
 Rectrices, 106  
 Rectum, 50  
 Remiges, 106  
 Retina, 100  
 Rhachis of feather, 106  
 Ribs, 13  
 Saccule, 102  
 Sacral vertebræ, 12  
 Scapula, 25  
 Scapus of feather, 105  
 Sciatic foramen, 32  
 Sclera, 98  
 Scleral ring, 99  
 Secondaries (feathers), 107  
 Secondary bronchi, 60  
 Segmentation, 113  
 Segmentation cavity, 115  
 Semicircular canals, 102  
 Semicircular ducts, 102

Seminiferous tubules, 67  
 Sero-amniotic connection, 127  
 Shell-membrane, 72  
 Shell of egg, 71  
 Shoulder girdle, 25  
 Sinuses of inner ear, 102  
 Sinusoids of liver, 55, 134  
 Skin, 104  
 Skull, 15  
 Small intestine, 49  
 Somatopleure, 123  
 Somites, 122  
 Spermatids, 67  
 Spermatocytes, 67  
 Spermatogonia, 67  
 Spermatozoa, 67, 69  
 Sperm-nuclei, 113  
 Sphenoid bone, 18  
 Spinal cord, 90  
 Spinal ganglion, 95  
 Splanchnopleure, 123  
 Spleen, 86  
 Splenial bone, 21  
 Sternum, 14  
 Stigma, 112  
 Stomach, 46  
 Stomodæum, 132  
 Subgerminal cavity, 115  
 Superior umbilicus of feather, 106  
 Supra-angular bone, 21  
 Syrinx, 59  
  
 Tarsus, 33  
 Temporal bones, 19  
 Tertiary bronchi, 60  
 Testes, 66  
 Thalami, 93  
 Third ventricle, 94  
 Thoracic air-sacs, 62  
 Thoracic ducts, 85  
 Thoracic vertebræ, 12  
 Thymus, 87  
 Thyroid, 87  
 Tibia, 33  
 Tongue, 41  
 Trachea, 58  
 Truncus arteriosus, 140  
 Tympanic cavity, 17  
 Tympanic membrane, 101  
 Tympaniform membranes, 59  
 Tympanum, 101

Ulna, 27  
 Ureter, 64  
 Uriniferous tubules, 65  
 Urodæum, 53  
 Uro-hyal bone, 23  
 Uropygial gland, 104  
 Uterus, 75  
 Utricle, 102  
  
 Vagina, 75  
 Vein or veins—  
   caudal, 84  
   caudal mesenteric, 85  
   caudal vena cava, 83  
   coccygeo-mesenteric, 85  
   common iliac, 83, 85  
   cranial mesenteric, 85  
   cranial vena cava, 83  
   femoral, 85  
   gastro-duodenal, 85  
   hepatic, 83  
   hypogastric, 85  
   internal iliac, 85  
   jugular, 83  
   portal, 85  
   pulmonary, 83  
   renal, 85  
   subclavian, 83  
   umbilical, 141  
   vitelline, 129  
 Venous terminal sinus, 138  
 Ventricles of brain, 91, 92,  
   94  
 Ventricles of heart, 80  
 Vertebral column, 9  
 Vestibule of ear, 102  
 Vexillum of feather, 105  
 Villi, 51  
 Vitelline area, 117  
 Vitelline membrane, 112  
 Vitreous body, 100  
  
 Wolffian body, 135  
 Wolffian duct, 135  
  
 Yolk of egg, 73  
 Yolk-sac, 123  
  
 Zoological position of fowl, 1  
 Zygomatic bone, 20

*Printed by R. & R. CLARK, LIMITED, Edinburgh.*

# Other Volumes in the Edinburgh Medical Series FOR STUDENTS AND PRACTITIONERS.

EDITED BY JOHN D. COMRIE, M.A., B.Sc., F.R.C.P.E.

**MEDICAL APPLIED ANATOMY.** By T. B. JOHNSTON, M.B., Ch.B. Lecturer on Anatomy, University College, London; lately Lecturer on Anatomy, University of Edinburgh; and Lecturer on Medical Applied Anatomy Edinburgh Post-Graduate Courses in Medicine and Surgery. Crown 8vo, Cloth, with 149 Illustrations (3 full-page in Colour). Price **7s. 6d.** net. (By Post, 7s. 10d.)

"The work bears the impress of a careful study of the Anatomical requirements of the medical practitioner by a teacher of extensive experience who presents the essential facts of his subject in a concise and lucid manner. We can confidently recommend the work as a sound guide on Medical Applied Anatomy."—*Birmingham Medical Review*.

"The book deserves success on account both of its practical nature and of its originality. It should prove a distinct acquisition to student and practitioner, and we can with confidence recommend it."—*The Prescriber*.

**A TEXT-BOOK OF MIDWIFERY.** By R. W. JOHNSTONE, M.A., M.D., F.R.C.S.E., M.R.C.P.E. Assistant to the Professor of Midwifery and to the Lecturer on Gynæcology in the University of Edinburgh; Extern Assistant Physician, Royal Maternity Hospital; Obstetric Physician, New Town Dispensary; University Clinical Tutor in Gynæcology, Royal Infirmary; Gynæcologist, Livingstone Dispensary, Edinburgh. Crown 8vo, Cloth, containing 264 Illustrations (3 in Colour). Price **10s. 6d.** net. (By Post, 10s. 11d.)

"This excellent and clearly written text-book is published opportunely, and supplies just what is wanted in a convenient size for the student who desires an up-to-date compendium on the art of obstetrics."—*Edinburgh Medical Journal*.

"To take the chapter on 'Normal Labour,' we have seldom read such a practical and satisfactory account of this important subject. The chapter on 'The Toxæmias of Pregnancy' is attractively written, and the best methods of treating the hæmorrhages of pregnancy—accidental and unavoidable—are very fully discussed."—*Prescriber*.

**DISEASES AND INJURIES OF THE EYE.** By WILLIAM GEORGE SYM, M.D., F.R.C.S.E. Ophthalmic Surgeon, Edinburgh Royal Infirmary; Lecturer on Diseases of the Eye in the University of Edinburgh. Crown 8vo, Cloth, containing 25 full-page Illustrations, 16 of them in Colour, and 88 figures in the text; also a Type Test Card at the end of volume. Price **7s. 6d.** net. (By Post, 7s. 11d.)

"We may say at once that the book is a useful introduction to the subject to those for whom it is intended, as was only to be expected from one of wide experience obtained in as important a centre as Edinburgh."—*Lancet*.

"The text is excellent, and the various chapters deal efficiently with the subjects on which they treat."—*British Medical Journal*.

**PRACTICAL PATHOLOGY, MORBID ANATOMY, AND POST-MORTEM TECHNIQUE.** By JAMES MILLER, M.D., F.R.C.P.E. Assistant Pathologist to the Edinburgh Royal Infirmary; Lecturer on Pathology in the School of Medicine of the Royal Colleges, Edinburgh. Containing 111 Illustrations and a Frontispiece in Colour. Crown 8vo, bound in Cloth. Price **7s. 6d.** net. (By Post, 7s. 11d.)

"We have perused this book with much pleasure and interest, and can testify to its practical nature. We feel sure the book will score an instantaneous success which will be thoroughly deserved."—*Medical Times*.

"This is essentially a student's book, and one that we can cordially recommend."—*The Lancet*.

A. & C. BLACK, LTD., 4, 5, & 6 SOHO SQUARE, LONDON, W.

**RADIOGRAPHY, X-RAY THERAPEUTICS, AND RADIUM THERAPY.** By ROBERT KNOX, M.D. (Edin.), M.R.C.S. (Eng.), L.R.C.P. (Lond.), Hon. Radiographer, King's College Hospital; Director, Electrical and Radio-therapeutic Department, Cancer Hospital, London; Hon. Radiographer, Great Northern Central Hospital, London; Captain R.A.M.C. (T.), 4th London General Hospital (in Charge of X-Ray Department). With a Frontispiece in Colour, 64 full-page Plates, and 246 Illustrations in the Text. Super royal 8vo. Price **25s.** net. (By Post, 25s. 6d.)

"Dr. Robert Knox is well known in his profession as one of the highest authorities on radiography; and his great book is worthy of him, and of the splendid work which he is doing in this branch of the science and art of medicine and surgery. It is among the books which deserve to be called text-books. It is complete, well arranged, well written, and well illustrated."—*The Times*.

**TUBERCULOSIS OF BONES AND JOINTS IN CHILDREN.** By JOHN FRASER, M.D., F.R.C.S. Edin., Ch.M. Assistant Surgeon, Royal Hospital for Sick Children, Edinburgh. Super Royal 8vo, Cloth. Containing 51 full-page Plates (2 in Colour) and 164 figures in the text. Price **15s.** net. (By Post, 15s. 6d.)

"The special section is uniformly good on conventional lines. The whole monograph will repay reading, and must prove of value both to students and surgeons of experience."—*The Lancet*.

"Altogether the book may be regarded as a mine of valuable and reliable information, and it should be in the hands of every one who is liable to be called upon to treat bone or joint tuberculosis."—*The Prescriber*.

**THE LAWS OF HEALTH FOR SCHOOLS.** By A. M. MALCOLMSON, M.D. Small Crown 8vo, Cloth, Illustrated. Price **1s. 6d.**

"The book should prove altogether a concise and interesting instructor upon one of the most important subjects of present-day education for the young—the proper care and training of the body."—*Practical Medicine*.

"The whole forms a very useful text-book, and can be recommended with confidence. There are questions at the end of each chapter which increase its utility."—*The Academy*.

**BLACK'S MEDICAL DICTIONARY.** Fifth Edition. Completing thirty thousand. EDITED BY JOHN D. COMRIE, M.A., B.Sc., M.D., F.R.C.P.E. Editor of "The Edinburgh Medical Series." Demy 8vo, bound in Cloth. Containing 425 Illustrations, 12 being full-page in Colour. Price **7s. 6d.** net. (By Post, 8s.)

"No one could read it through without acquiring a large amount of sound information, not only in regard to the organs of the human body, their functions, and the diseases to which they are liable, but also a good deal of learning in regard to such important matters as clothing, diet, exercise, sanitation, and ventilation. It is a thoroughly practical, useful book, singularly complete."—*Scotsman*.

"The best manual for its purpose that we have seen."—*Observer*.

### Medical History Manuals.

**PASTEUR AND AFTER PASTEUR.** By STEPHEN PAGET, F.R.C.S. Crown 8vo, Cloth. With Eight Pages of Illustrations. Price **3s. 6d.** net. (By Post, 3s. 10d.)

"An admirable volume."—*The Times*.

"We heartily commend this fascinating volume, which records the achievements of a great scientist with knowledge, sympathy, and skill."—*Aberdeen Free Press*.

"The whole book forms a clear and convincing summary of the achievements of the experimental method in the region of infective diseases."—*British Journal of Surgery*.







B1

AMNH LIBRARY



100069919