



Class SF65

Book .P65

Copyright N^o _____

COPYRIGHT DEPOSIT.

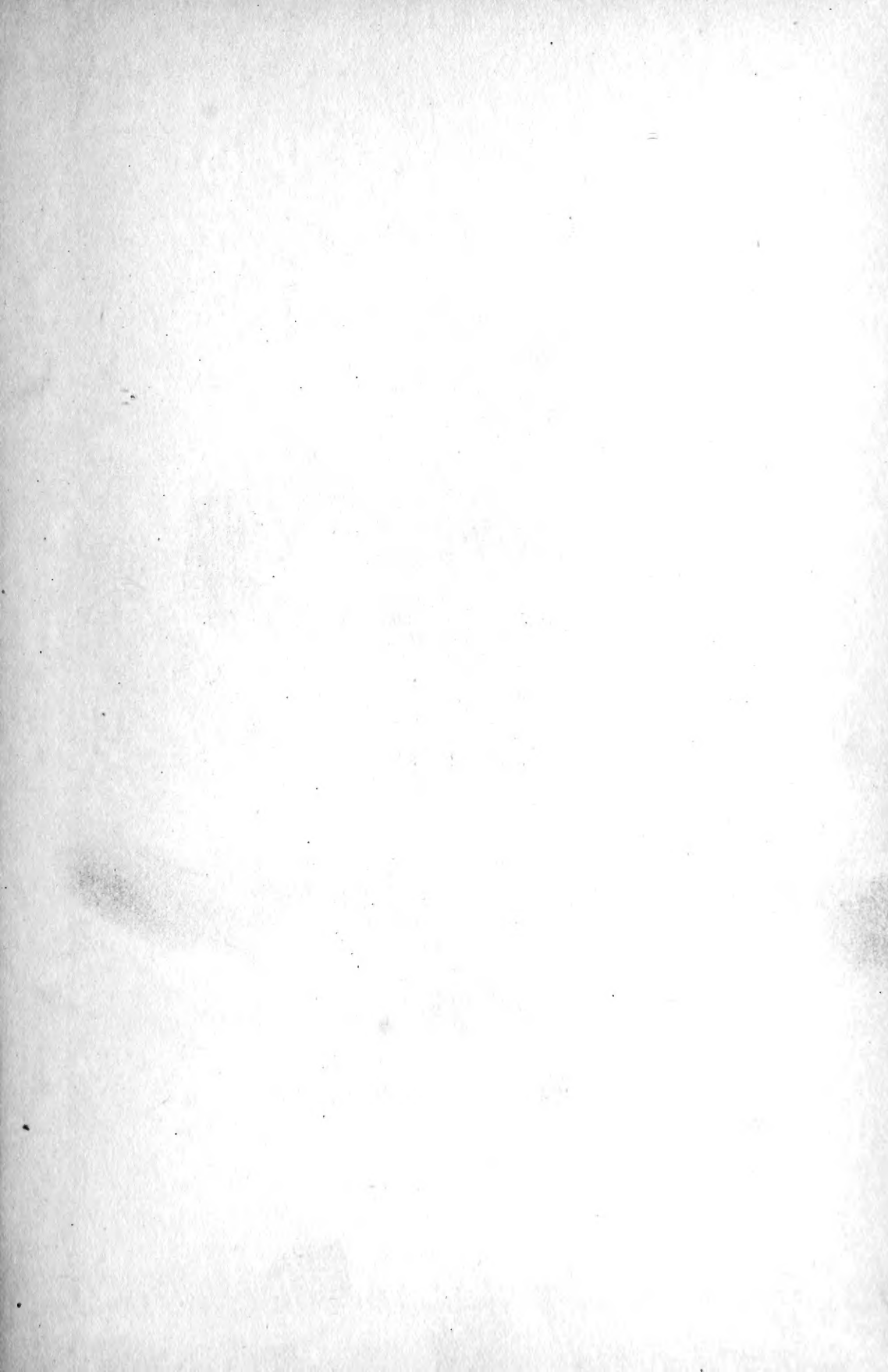

BOOKS WRITTEN BY CHARLES S. PLUMB

- A BIOGRAPHICAL DIRECTORY OF AMERICAN AGRICULTURAL SCIENTISTS.
Edited and published at Knoxville, Tenn., 1889; pp. 100;
flexible cloth. The supply of this work is exhausted.
- INDIAN CORN CULTURE
Chicago: The Breeders' Gazette Print, 1895. Cloth;
pp. 243; figs. 63.
- LITTLE SKETCHES OF FAMOUS BEEF CATTLE
Columbus, Ohio: Published by the author, 1904. Cloth;
pp. 99.
- TYPES AND BREEDS OF FARM ANIMALS
Boston: Ginn & Co., 1906. Completely revised, 1920.
Cloth; pp. 820; figs. 365.
- A PARTIAL INDEX TO ANIMAL HUSBANDRY LITERATURE
Columbus, Ohio; Published by the author, 1911. Cloth;
pp. 94.
- BEGINNINGS IN ANIMAL HUSBANDRY
St. Paul, Minnesota: The Webb Publishing Co., 1912.
Cloth; pp. 393; figs. 217.
- JUDGING FARM ANIMALS
New York: Orange Judd Co., 1916. Cloth; pp. 590;
figs. 299.

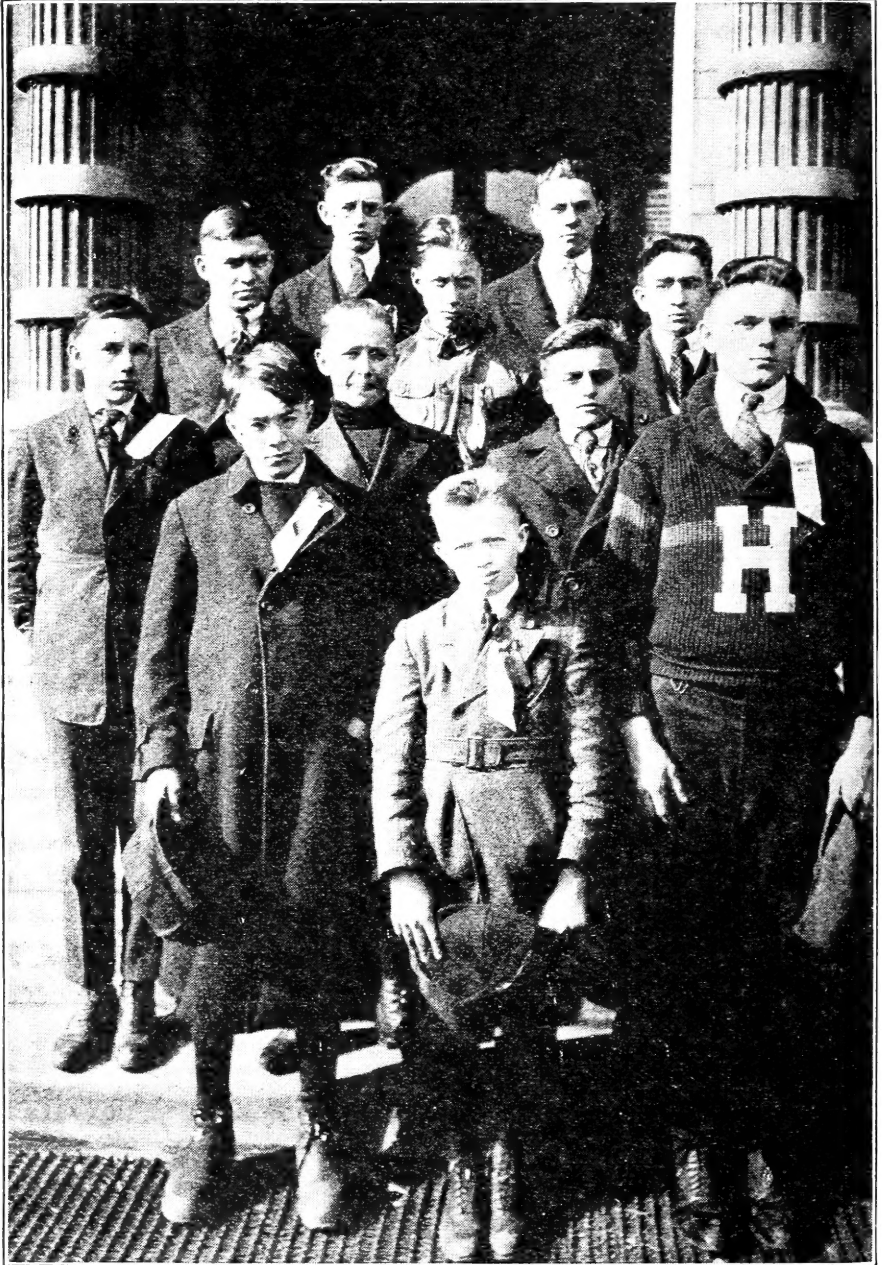

Frontispiece. This group consists of the champion judges in the boys' and girls' live stock clubs of Ohio in 1921. They won the championships at the Ohio State University, about 700 being in competition. From such lads much may be expected in the future, for the boys of to-day are to be the stockmen of to-morrow.

A STUDY
OF
FARM ANIMALS

BY

Charles S. Plumb

Professor of Animal Husbandry in the College
of Agriculture of the Ohio State University.
Author of "Types and Breeds of Farm Animals,"
"Judging Farm Animals," "Beginnings in Animal
Husbandry," etc.



The Webb Publishing Company
St. Paul, Minnesota
1922

SF 65
P 65

COPYRIGHT 1922
CHARLES S. PLUMB
W. 1
Made in U. S. A.



OCT -5 1922

©CLA686237

no 1

FOREWORD

During the past decade the subject of agricultural education for our secondary schools and colleges has received much attention. Prior to this period a number of general texts on agriculture for schools, elementary in character, prepared by men trained in general science or classics, were published. These texts had a limited distribution, partly because of lack of interest in the subject by teachers and pupils, and partly because of the methods of presentation. These authors saw no way of handling the subject, excepting by a more or less stereotyped style, in which chemistry, or some natural science, furnished the reasoning basis.

The establishment of agricultural colleges, equipped with farms, and working laboratories of greenhouses, orchards, gardens, field crops, and stables with their contents of farm animals and utensils, paved the way to a new and interesting treatment of agricultural subjects. The introduction of popular short winter courses about 1890, was the first important step in this direction. Simple laboratory exercises in dairying, horticulture, and live-stock judging, appealed to students, and added much to the popularity of the instruction. As an outgrowth of these has come the great popular movement in America in behalf of agricultural education. Not only the colleges, but many secondary schools have adopted agricultural courses, and some have been equipped with farms and laboratories, where the students are taught the relationship of principles to farm practice.

The evolution in agricultural education has been associated with the development of texts that have covered a wide range of instruction, and which have supplied a vital interest quite lacking in most of the books published prior to the year 1900. In fact, we have a new agricultural litera-

ture, the direct outgrowth of recent methods of education in the agricultural college, as well as the investigations of our experiment stations.

To meet what was regarded as a real need in secondary schools and short courses, in 1912 the author prepared a book entitled "Beginnings in Animal Husbandry," the first text of its kind in this field of education, prepared for students below college grade. The reception given this volume by educators was very gratifying to the author. In the passing years, however, much new material has accumulated, and courses of study have been introduced that were not generally given in 1912, and for which no provisions were made in "Beginnings in Animal Husbandry." The author has, therefore, seen fit to prepare a new text, that should more fully meet present needs. It not only discusses the feeding, care, and management of animals with some detail, as applied to horses, cattle, sheep, swine, and poultry, but considers other subjects of present-day importance. These include community breeding, something about wool, boys' and girls' live-stock clubs, co-operative live-stock shipping, and culling the poultry flock. It also contains besides these, all the more important matter relative to breeding, the breeds, and judging, as set forth in the first text. "Beginnings in Animal Husbandry" consisted of 28 chapters, including 393 pages and 217 illustrations, while the present text contains 44 chapters, 540 pages and 256 illustrations.

In conclusion the author would quote the final sentence of the Foreword in "Beginnings in Animal Husbandry": "It is his earnest hope that such lessons as either teacher or pupil shall find within these pages, may result in a desire for yet wider knowledge of and a more sympathetic interest in, farm animals."

Ohio State University
Columbus, Ohio

CHARLES S. PLUMB

June 1, 1922.

TABLE OF CONTENTS

CHAPTER	PAGE
I. THE IMPORTANCE OF FARM ANIMALS	9
II. HEREDITY: ITS MEANING AND INFLUENCE	21
III. SELECTION AND ITS IMPORTANCE	29
IV. PEDIGREES AND THEIR VALUE	38
V. SUGGESTIONS TO YOUNG BREEDERS	48
VI. COMMUNITY BREEDING OF FARM ANIMALS	57
VII. THE COMPOSITION OF PLANTS AND ANIMALS	65
VIII. THE PROCESS OF DIGESTION	74
IX. FEEDING STANDARDS: THEIR ORIGIN AND USE	84
X. CALCULATING FEEDING RATIONS	93
XI. COARSE FEEDS OR ROUGHAGE	100
XII. CONCENTRATED FEEDS	115
XIII. JUDGING FARM ANIMALS	125
XIV. ANIMAL TYPE AND ITS IMPORTANCE	138
XV. THE BREEDS OF HORSES	144
XVI. THE POINTS OF THE HORSE	164
XVII. JUDGING THE HORSE	183
XVIII. FEEDING THE HORSE	197
XIX. THE CARE OF HORSES	208
XX. BREEDS OF BEEF CATTLE	217
XXI. JUDGING BEEF CATTLE	233
XXII. FEEDING BEEF CATTLE	245
XXIII. SOME FACTORS INFLUENCING BEEF PRODUCTION	255
XXIV. BREEDS OF DAIRY CATTLE	269
XXV. JUDGING DAIRY CATTLE	288
XXVI. FACTORS INFLUENCING MILK PRODUCTION	300
XXVII. FEEDING DAIRY CATTLE	310
XXVIII. SOMETHING ABOUT WOOL	322
XXIX. THE BREEDS OF SHEEP	333
XXX. THE JUDGING OF SHEEP	356
XXXI. FEEDING SHEEP	367
XXXII. THE CARE OF SHEEP	379
XXXIII. THE BREEDS OF SWINE	389
XXXIV. JUDGING SWINE	404
XXXV. FEEDING SWINE	418
XXXVI. THE CARE OF SWINE	430
XXXVII. BOYS' AND GIRLS' LIVE-STOCK CLUBS	440
XXXVIII. COOPERATIVE LIVE STOCK SHIPPING ASSOCIATIONS	450
XXXIX. TYPES AND BREEDS OF POULTRY	459
XL. JUDGING POULTRY AND POULTRY PRODUCTS	473
XLI. CULLING THE POULTRY FLOCK	483
XLII. EGGS AND INCUBATION	491
XLIII. THE FEEDING OF POULTRY	503
XLIV. THE POULTRY HOUSE AND EQUIPMENT	515
APPENDIX	537
INDEX	541

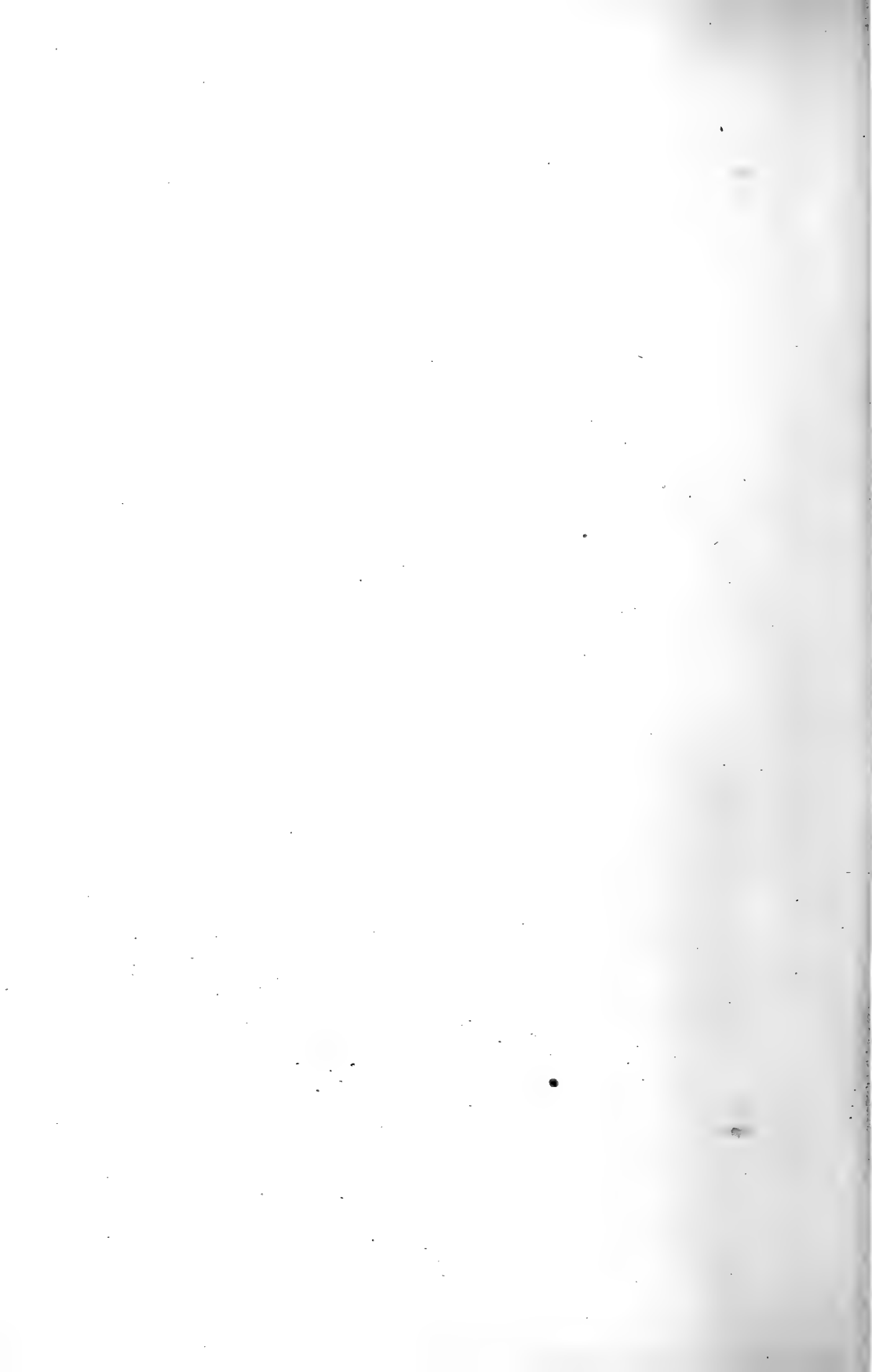

A STUDY OF FARM ANIMALS

CHAPTER I

THE IMPORTANCE OF FARM ANIMALS

The study of domestic animals may be considered both a pleasure and a duty—a pleasure, because of the natural-born interest man feels in all animals; and a duty on account of the service horses, cattle, sheep, and swine play in the



Figure 1.—Hereford bull, Avondale, champion at the 1914 Royal Agricultural Society Show, England, exhibited by King George V. Photograph by the author.

world's affairs. Between many people, and even nations, and their domestic animals, we find an affectionate, sympathetic relationship. The people of Great Britain, the world's leading stockmen, from the King and Queen to the humblest laborer, show a keen and kindly interest in everything

relating to farm live stock. One of the most interesting sights to be seen in Europe is the annual show of the Royal Agricultural Society of England, where live stock is made the leading feature, and where vast throngs of people go to inspect and talk over the animals and watch the judges at their work. The average Britisher is a lover of animals, and expresses a common, inherited sentiment. This disposition on the part of a people develops the finer, more sympathetic qualities, and broadens and strengthens character. In the same way, the boy or girl who shows a devotion to the animal given to his or her care becomes more sympathetic and broader minded, and is rendered more resourceful and capable. From another point of view, animals play a most important part on account of their uses for food and labor. The study of animals as relating to farm economy and the markets of the world becomes, therefore, a most important matter.

The commercial importance of the live stock industry is so great that only a brief reference can be made to it here. One is unable to comprehend the magnitude of the figures which relate to either numbers or values of farm animals. According to the report of the United States Census, on January 1, 1920, the farm animals in this country made the following showing in numbers.

Class of Live Stock	Number
Horses.....	21,848,000
Mules.....	5,829,000
Milch cows.....	20,892,000
Other cattle*.....	48,031,000
Sheep.....	35,435,000
Swine.....	62,007,000
	194,042,000

By these figures we see that we had in 1920 about 195 million animals on our farms, a number far too big to comprehend. The significant thing is simply to realize the vastness of our live-stock industry, and the enormous sum of

*Includes beef cattle of various kinds and oxen.

money here invested, besides the value of the animals themselves. The greatest live-stock producing section of the country includes the states of New York, Ohio, Indiana, Illinois, Michigan, Wisconsin, Minnesota, Iowa, Missouri, North Dakota, South Dakota, Nebraska, Kansas, Oklahoma, and Texas. The two states of most importance in numbers of each kind of live stock in the United States in 1920 are as follows:

Horses.....	{ Iowa first, with.....	1,386,000 head
	{ Nebraska second, with.....	1,322,000 "
Mules.....	{ Texas first, with.....	849,000 "
	{ Georgia second, with.....	407,000 "
Milch cows	{ Wisconsin first, with.....	2,763,000 "
	{ New York second, with.....	2,081,000 "
Other cattle	{ Texas first, with.....	4,768,000 "
	{ Iowa second, with.....	3,048,000 "
Sheep.....	{ Texas first, with.....	2,552,000 "
	{ California second, with.....	2,400,000 "
Swine.....	{ Iowa first, with.....	7,864,000 "
	{ Illinois second, with.....	4,640,000 "

We see from the above that Iowa ranks first with numbers of horses and swine, Texas with mules, sheep and other cattle, and Wisconsin with milch cows. The two states, however, that have the greatest numbers of superior farm animals of the different kinds are Iowa and Illinois.

The importance of our live stock may also be seen from another point of view in connection with our local markets. The city of Chicago is the largest live-stock market in the world. The Union Stock Yards of that city cover 500 acres, and received in 1920 a total of $15\frac{3}{4}$ millions of farm animals, valued at over 665 millions of dollars. Nearly 268,000 car loads of live stock were received in these yards in 1920. This is equal to about 734 cars a day, which, at an average length of 36 feet to a car, would make one solid train of live stock about 5 miles long. There are 300 miles of railway in and about the yards to handle all this great traffic. Some 100,000 people live about the yards and get their daily incomes from them. Here are immense

slaughter houses and meat-packing plants from which meats are shipped to all parts of the world. The Union Stock Yards and packing houses are noted features of the great city of Chicago and are daily visited by tourists from all over America and many other countries. In 1920 there were 1,897 slaughtering and meat-packing plants in the United States, in which were killed and prepared for food, under the supervision of United States inspectors, over 65 millions of farm animals. These figures are given simply to show the importance of the live-stock trade and the part it must play in American agriculture.



Figure 2.—A view in the Kansas City Stock Yards. Photograph by the author.

The first use of animals by man dates back to the days when there was no civilization, when no written records were made, and the people lived as ignorant savages. It was in prehistoric times, when the only implements used were very crude ones made by hand, of stone, iron or copper. That animals lived with man in these prehistoric days, we know, because the bones of man and those of horses, cattle, and other animals have been found mingled together in the remains of prehistoric villages in Europe. As man ascended

in the scale of civilization, we find that animals became more and more associated with him in his daily life. The oldest historical works make frequent reference to farm animals. In consulting the Bible, one will find in the Book of Genesis, dating back over 2,000 years before Christ, repeated reference to herdsmen and horses and asses, cattle, sheep, and goats. In fact, these people of early days were farmers, and depended largely on their live stock.

The importance of domestic animals to man is to be seen in several ways. There are some features of special interest to the student; namely, (a) the use of animals for clothing, (b) for food, (c) for labor, and (d) in relation to maintaining soil fertility. Each of these is of sufficient importance to justify special consideration.

The use of animals for clothing refers to the skin, hair, and wool or other hairy covering. Earliest man is supposed to have used the skins of animals for clothing, especially in the cooler regions or during the colder seasons of the year.

For thousands of years people have woven cloth from wool and the hair of camels and goats. At the present day the making of cloth from wool is a great industry in different parts of the world. Millions of sheep even now have their chief value in the wool that they produce. The leading industry of a number of English and American towns and cities is the converting of wool into clothing; so we find in them great mills employing thousands of people.

The use of animals for food is of first importance. It is for this purpose that cattle, sheep, and swine have been domesticated; and the final end of all farm animals except the horse, ass, and mule, must be for human food. Meat is a concentrated food, rich in the substances that give strong physical development. It is said that the meat-eating nations rule the world; and, when we realize that the people of North America, Great Britain, France, and Germany are the greatest consumers of this food, we are inclined to be-

lieve the statement to be true. The average person in the United States eats about 150 pounds of meat a year. With a population in excess of one hundred million people, it can be easily understood that an enormous number of animals must be slaughtered for food each year.

There is also another important source of food from animals, that of milk and its products. Cattle have been so improved since domestication began, that to-day we have cows producing remarkable yields of milk. A yield of 5,000 pounds of milk a year is very common; a large number of cows have produced 10,000 pounds; a yield of 15,000 pounds of milk in a year from a single animal is no longer remarkable. Milk is a very nutritious liquid food, and supplies a place in human diet unequaled by any other substance. From milk is manufactured cheese, a valuable food that in Europe very generally takes the place of meat among the laboring classes. Butter, also a product of milk, is so greatly in demand that thousands of creameries engage in its production. In 1920, there were over twenty million cows and heifers kept in the United States, primarily for milk. Ten states had over one million dairy cows each.

The use of animals for labor no doubt dates from prehistoric days when man subdued the horse. With the cultivation of the fields, both cattle and horses became beasts of burden and laborers in the fields. Cattle are commonly used for labor in parts of Europe, even dairy cows sometimes being employed to draw loads. Oxen were much used in pioneer days for draft work in America, but have been generally discarded on account of their slowness, yet even to-day they may be seen serving in place of horses in some parts of our country. In the pioneer settlement of America, the ox team proved a very important means of transportation through the forests and across the wide western prairies. The great endurance, steady habits, and ease of keep, make the ox a favorite with the pioneer.

In countries other than our own, where railways do not exist, the transportation of freight must be done by animals or on the shoulders of men. In many countries the people use the backs of animals for this purpose. In northern Africa, the camel is known as "the ship of the desert," for on its back is carried both man and freight from the interior to the coast. In parts of Asia, the elephant becomes a mighty beast of burden, performing wonderful draft service. The little donkey, regarded in America as simply a play-



Figure 3.—An ox team in Washington State. Photograph by Bert C. Thomas.

thing for children, is widely used over the world as a burden bearer of the most steady and dependable sort.

Thus it is seen that domestic animals, even to-day, play a very important part in moving merchandise and performing labor. Although the motor-truck has become an important medium for transporting freight in our towns and

cities, largely replacing the horse in this service, still the work horse, and especially the one suited for heavy draft, is here in constant demand. The tractor is well adapted to certain farm operations, supplanting the horse, but this animal is yet indispensable for many purposes on our farms, and will always be an important part of farm equipment. Professor T. F. Hunt states* that in England it is estimated that two horses will cultivate 80 acres of light and sandy soil or 60 acres of heavy, or clay, soil. In the United States, it appears that one horse or mule of working age is kept for every 30 acres of improved land; but in level prairie sections far more service than this indicates is expected.

The use of domestic animals in maintaining soil fertility has long been recognized as of great importance. The earliest writers on agriculture, who lived just prior to the Christian era, about two thousand years ago, wrote more or less of the value of manures in keeping the soil fertile. The farmer of those days learned from experience that, if he took a crop from the land one year, the next harvest from the same soil would be smaller unless manure was used to replace the fertility removed in the crop. Thus we see that twenty centuries ago the farmer learned that he must replace fertility in his soil if he expected to reap abundant harvests. To secure this necessary fertility, he used the manure provided by farm animals; and much was written about the value of the excrement from different kinds of animals, and the preservation of manures.

In very recent times, artificial fertilizers have come into extensive use. But, in spite of this fact, the natural manures of animals have been absolutely necessary to keep up the fertility of the soil of most regions where high-class farming is practiced. There are lands in Europe to-day, said to have been cultivated for 2,000 years, that grow great crops, made possible by the use of animal manures. This statement may be accepted as a fact, that, except in the case

*Cyclopedia of Agriculture, Vol. III, 1908, p. 11.

of some great river valleys, like the Nile, which are enriched by annual overflow, no agricultural region has continued to grow abundant harvests without the aid of manure from domestic animals. Each year the wheat fields of Canada and the corn fields of the Mississippi Valley yield in reduced amounts per acre, unless fertility replaces that removed by the crop. Experience has also shown that, where farmers keep the most live stock, there the crops are most abundant and the people most prosperous.

We purchase commercial fertilizers to restore fertility to the soil; but these lack one thing of great importance found in stable manures, and that is vegetable matter, which is as necessary to the soil as is the chemical nutriment. The rotted manure in the soil makes it more porous and mellow and permits the entrance of air and the growth of roots through it more freely than where no vegetable mould is present. Interesting experiments conducted for more than seventy continuous years on the same land, in England, at Rothamsted Experiment Station, showed that wheat grown on unmanured land yielded just about 12 bushels per acre, while a yield of about 40 bushels occurred where stable manure was used. A ton of average stable manure is regarded as containing about \$2.50 worth of plant food. Professor Roberts has figured* that the average value of the manure produced by a cow each day is 8 cents, while that of a horse is worth about a half cent less. The value of stable manure, however, depends upon the feed the animal gets. Feed rich in grain makes a more valuable manure than that from hay only, and so will return more fertility to the soil.

The animal is a machine for changing coarse into fine material. The ideal kind of farming combines the growing of grass and grain and the feeding of these to the animals of the farm. These raw crops are thus converted into concentrated and high priced products, as represented in meat, milk, butter, cheese, or breeding stock. A large percentage

*Bulletin 56, Cornell University Experiment Station.

of the food consumed returns to the farm to keep up its fertility. Some forms of stock farming remove but very little of the actual soil fertility. One reason why dairy-cattle farming meets with so much favor is because of the small amount of fertility sold from the farm in milk or butter. Professor Vivian states* that the fertilizing value of a ton of butter is but 44 cents, and that 5,000 pounds of milk contain but \$4.89 worth of fertility. As much as 80 or 85 per cent of the value of the food or crop becomes animal excrement, and which under a progressive system of agriculture is returned to the soil for its upbuilding.

When, as in case of dairy-cattle farming, much more grain is fed than is grown on the farm, then the land steadily improves in its producing capacity. The best examples of intelligent general farming are to be found where herds and flocks are kept as important features of a well-balanced farm system. Where the special business is stock farming, then the final product in its concentrated form will yield far more important and profitable returns in the long run than will any other method. One hundred acres of grain shipped a thousand miles require a large expenditure of labor and money, while this same crop, in the form of a concentrated product like butter or meat, may be transported at relatively much less expense.

Live stock farming is adapted to the cheaper and rougher lands. Much land that might not be used for other purposes can be devoted to pasturing farm animals. The grass on the hills is usually finer and sweeter than on the lowlands. In various parts of the world where the land is naturally poor or of a rough character, stock farming is an important industry. In fact, no other kind of farming is so well adapted to these conditions. On the Cheviot Hills of Scotland, the principal industry is that of sheep raising, grass and sheep being the two crops. In Switzerland, high up on the mountain sides are pastures which annually furnish feed

*First Principles of Soil Fertility, 1908, p. 120-121.

for many dairy cows. On the rough, cheap hillsides of New England, dairy cattle are the most important source of income to the farmer. On the high, grassy hills of eastern Ohio, western Pennsylvania, and West Virginia, are to be found the largest flocks of sheep in this country east of the Missouri river. In the Southwest and far West of the United States, on the cheaper rolling or broken lands, will be found extensive herds and flocks. In the Northwest, among the cut-over lands that have been deprived of their timber

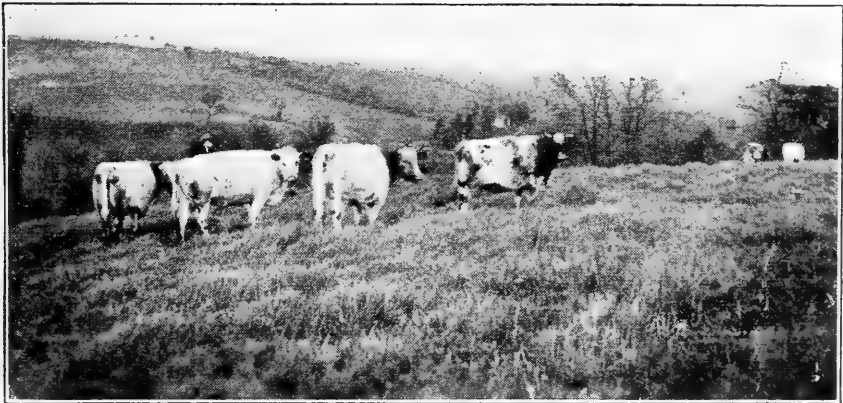

Figure 4.—Fat cattle on Ohio hills. Photograph by the author.

by the lumbermen, dairy cattle and dairymen are being developed on a greater scale than elsewhere in America. In fact, the farmer generally plans on the use of his cheaper, poorer lands as pasture for stock. Rightly handled, these lands in most cases greatly increase in producing capacity and value. Inasmuch as live stock also finds an appropriate place on the more fertile and level farms, we must recognize the fact that animals are adapted to greater extremes of soil and land conditions than are the staple crops. Thus animals in a world-wide sense become subjects of great importance and interest.

The class of people handling livestock, as a rule, represents the more intelligent and progressive farmers of the

community. Their homes and farm buildings indicate comfort and prosperity, when compared with what one sees on farms where live stock is not a part of the system of management. There is a pride in the ownership of a fine herd that creates a desire on the part of the owner to improve and beautify his home. Thus he becomes interested in community welfare, and often renders service of a public nature that is much to his credit. The most beautiful and attractive farm homes one sees in traveling through England and Scotland, are occupied by men who are owners of fine flocks and herds. In the United States the same condition prevails, whether we are in the blue-grass region of Kentucky, or the wide prairies of Illinois and Iowa, or the alfalfa fields of Kansas and Colorado. Should we not, therefore, do all we can to create an interest in farm animals, and thus develop a higher class of citizenship amongst us?

DO YOU KNOW

1. What people are especially interested in live stock?
2. How many farms animals we have in the United States?
3. What states lead in numbers of each kind of live stock?
4. How many car loads of stock enter Chicago market daily?
5. When man first domesticated animals?
6. How much meat we eat per capita a year?
7. What cattle are used for labor?
8. How live stock is related to farm fertility?
9. What a ton of stable manure is worth?
10. How the animal resembles a machine?

CHAPTER II

HEREDITY: ITS MEANING AND INFLUENCE

The word heredity has long been used by scientific men when discussing the important subject of breeding animals and plants. As commonly defined, it means the reproduction in the offspring of the characteristics of the parents. It means more than that, however, because the parentage of an animal or plant extends further back than one generation.

The degree or extent that characteristics may be inherited from parents, grandparents, and more distant generations, can not be absolutely determined. Yet, that animals and plants do inherit from other generations than the parents, is a matter of common knowledge. In fact, everything found in the animal, whether physical or mental, excepting certain diseases, has been transmitted through previous generations. We know that under average conditions there is a certain degree of resemblance between an animal and its various ancestors. Yet there are conditions which greatly affect heredity. Writing on "the complex nature of heredity," Davenport says:* "The most disconcerting principle in all improvement operations lies back of the obvious fact that the offspring is not like the parent. Having two parents, he could not of course be like them both. The fact is, however, that for the most part he is not like either one of them, nor yet is he like the two combined. The most that can be said is that the offspring *resembles* his parents, and that all his characters are to be found somewhere in his parentage."

The persistence of heredity is a most important factor in its influence on the offspring. The older and better established the family, the more uniform and certain is the transmission. We say that an animal, family, breed, or

*Domesticated Animals and Plants, 1910, p. 154.

race that transmits its special characteristics with much certainty, is *prepotent*. This word suggests power, and really means superior influence. Wild animals and birds represent the purest and most prepotent breeding. They live and develop under conditions that are most natural and uniform, thus resulting in the least change. One wild fox differs but little from other wild foxes of the same kind in form, color, and mental traits. In the opinion of scientists they must have had these characters for a great length of time. The same conclusion applies to any other one species, the product of wild conditions.

The most prepotent domestic animals are those that have been bred pure for long generations. A breed like Hereford cattle, the family relationship of which can be traced back for a hundred years, represents a comparatively well-established type and character. In a herd of these cattle we should expect to find the typical horn and head, the blocky form, the red body and white face, brisket, tail, and feet color so universally known. We have examples, however, of old breeds that have not been developed by great constructive breeders, and consequently a lack of individual excellence among a great number of the animals is found.

The importance of heredity in stock breeding has long been recognized. The men who have been most noted in the development of each of the great breeds have agreed that the saying, "like produces like," contains much truth. In fact, in breeding operations they have placed a premium on prepotency and uniformity of character. Bates, the great Shorthorn breeder, was a stickler for type and character. The same may be said of any other man who has become celebrated as a breeder of superior animals. If a man wishes to produce race horses, he must use race-horse blood, in which speed has been the important feature. Great records are being made among dairy cattle to-day, and certain families are noted producers. In studying the history of

the development of the modern dairy cow, one will find that the inheritance of milk or butter-fat production is a great prepotent feature. This prepotency is illustrated in a striking manner in the ancestry of the Holstein-Friesian cow De Kol Creamelle. She produced 780.4 pounds of milk in a week, her daughter Creamelle Vale 750.2 pounds, her granddaughter Dutchland Colantha Vale 765.3 pounds, and her great granddaughter Dutchland Pietertje Vale 750 pounds in a week, a remarkable series of records. Anyone

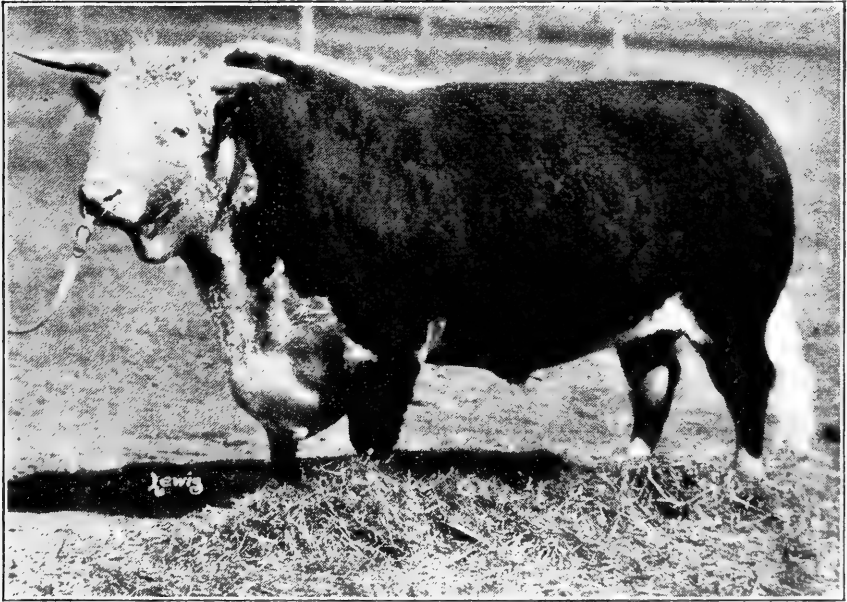

Figure 5.—Hereford bull, Disturber 12th, owned by Ferguson Brothers of Minnesota. Photograph from the owners.

who attempts to establish and develop a herd without being guided by our present-day knowledge of the influence of heredity will certainly fail in his breeding operations.

The importance of an ideal in breeding can not be overestimated. Men who have done much to assist in developing breeds and have become famous in this work are commonly called "constructive breeders." In the upbuilding of the Shorthorn, the Colling Brothers, Bates, the Booths, and

Cruickshank were all known as great constructive breeders. These men had their ideals or standards, and bred up to them as closely as possible. Two men start out with herds of cattle of equal merit. One man has ideals of what he should do. He carefully studies his cattle and the laws of heredity, and seeks constantly to improve his herd. At the end of 25 years he has a fine herd, that is a marked improvement over his foundation stock, and from which he derives much praiseworthy fame and substantial profit. The other man has no ideals or policy. He is satisfied with things as he receives them, he does not study his business, and, as might have been expected, his stock becomes inferior and unprofitable, he gets in debt, and ends possibly in bankruptcy. One man is a benefit to his community, the other is not; yet each had an equal chance at the start.

Certain useful and valuable forms of inheritance exist among the improved types and breeds of farm animals, and the perpetuation of these qualities is most important, if one is to make a success of breeding. Some of these forms that directly concern the stockman are the following:

(1) *Color markings.* One of the most important features of breed identification is the color. Some breeds possess a solid, uniform color, as the red of the Red Polled cattle, the black of the Aberdeen-Angus, the white of the Chester White and Large Yorkshire pigs, and the red of the Duroc-Jersey. Each breed has its standard color or colors, and anything varying from this, as a rule, causes disqualification.

(2) *Milk production.* The Holstein-Friesian breed is noted for the large milk flow of the cows. No other breed of cows equals these in heavy flow of milk, and no feature does more to make the Holstein-Friesian famous than that of milk production.

(3) *Fecundity* is especially a hereditary character. Shropshire sheep have been noted for many years for the large percentage of twins dropped by the ewes. The Large York-

shire and the Tamworth breeds of hogs are famous for the large litters farrowed by the sows, while of the lard-type breeds the Duroc-Jersey is prominent in this respect.

(4) *Temperament.* As a rule, animals of a heavy, fleshy type are more phlegmatic and less nervous than those of more muscular build. Draft horses, beef cattle, mutton sheep, and lard hogs all show to a certain extent this relationship of form to temperament.

(5) *Speed* is a striking feature of the horse of light and muscular conformation. A study of the pedigrees of running horses prominent to-day will in many cases show lines

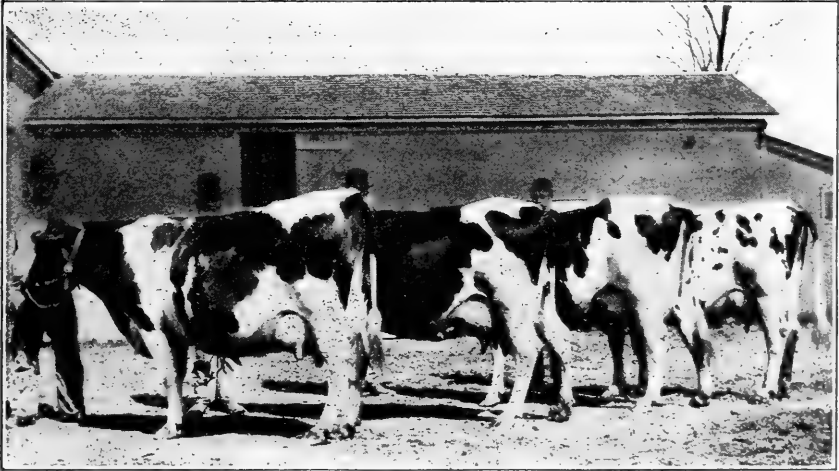

Figure 6.—Holstein Friesian cow Prilly 40082 at 13 years old, on the left, and her three daughters Beauty Pietertje, Cleopatra Gelsches, and Eliza Pietertje, all great producers. Photograph from their owner, H. A. Moyer.

of descent from the Darley Arabian, with long lists of celebrated racers in between, covering the period of over a century. In the same way, the record of inherited speed of the American trotter may be traced in a most interesting way from the present back to about 1822, when Bellfounder, the sire of the dam of Hambletonian 10, by many regarded as the most noted speed sire in the history of America, was imported to this country from England.

Peculiar or interesting characters are also transmitted from one generation to another. We are usually most impressed with the commonest things in animal inheritance, yet there are remarkable characteristics that are well worth attention, and such as demand consideration from the thoughtful stockman. Usually these are valued as breed features, yet in themselves they have no useful attributes. Some examples of these are the following: *The solid hoof in the hog* is a rare occurrence, except with one breed, the Mule Foot. This characteristic is of no special value, but it has been made the subject of much publicity, and many persons from curiosity have purchased specimens of Mule Foot hogs. *A pug-nosed, dished face* is a distinct feature of the Small Yorkshire breed of swine. Often these pigs are bred so that the lower jaw projects with an upward curve beyond the short, dished upper jaw, seriously affecting ease of eating. Berkshire breeders in America in late years have also had a tendency to breed these very short, turned-up faces. Such heads are monstrosities, in the same class with those of bull dogs and Boston terriers. *Five toes on each foot* are found on the Houdan and Dorking breeds of chickens. This number of toes commonly occurs on all good specimens of these two varieties of well-known European fowls, although four is the usual number with other breeds.

Latent hereditary characters exist in all animal life. By these are meant characteristics that are not visible in any form in one or more generations, yet have occurred in the past, and may again appear at some time in the future. During the past, students of heredity have called such occurrences "atavism," while stockmen have been in the habit of referring to them as "throwing back," or "breeding back." For example, we have a case of a family of Aberdeen-Angus cattle, which is a black breed. Very unexpectedly a red calf is dropped in a herd where not a red animal has been known. Yet a careful study of the history of this herd will

show that at a previous period there was a red ancestor. This red color was really hereditary, but lay dormant, or latent, as it is termed, for some generations, and then cropped out. The stockman usually calls this a "sport." Scientists speak of it as a "mutation." The important point, however, is that this character really was inherited from generation to generation, but did not appear until certain conditions were favorable. Many similar cases might be cited that have caused much comment among stockmen. In this connection, it may be noted that mutation occurs less frequently with old, well-established breeds than with those

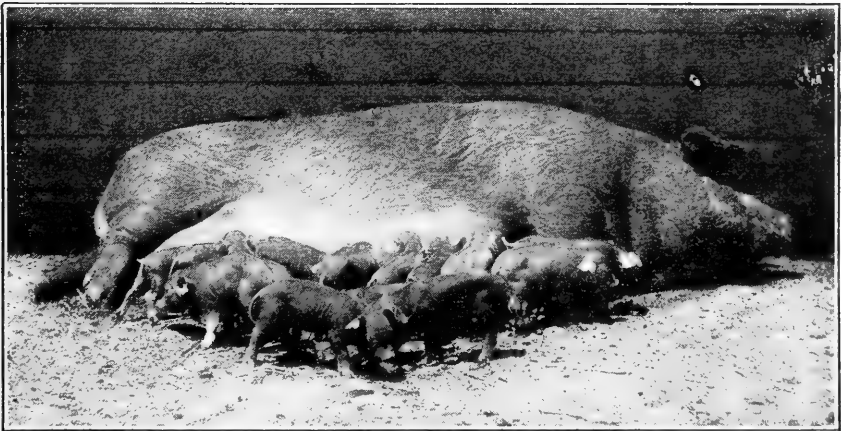

Figure 7.—A good example of fecundity, a Duroc-Jersey sow and litter of 14 pigs. Photograph from Ohio Experiment Station.

not so old and less under natural than under artificial conditions. It is also important to remember that sometimes mutation results in valuable variations from the parent type. Instances have occurred where intelligent breeders have recognized the value of such a "sport," and have succeeded in reproducing it through successive generations, until it became a fixed breed feature. More than one hornless breed of cattle and sheep have been founded by the unexpected appearance of a polled animal in a horned herd. This anomaly applies especially to Polled Jersey, Polled Hereford,

and Polled Shorthorn cattle, each of which breeds is now championed by a registry association for promoting the hornless head.

Variation in animal character is to be seen on every hand. No two animals are exactly alike. In a family of the same parentage we find marked differences. Within our intimate acquaintance, we are often impressed with the striking differences between members of the same family. Among our domestic animals differences also exist in no small degree, although our attention may not be attracted by them in the same manner as in the human family. Yet variation is a common occurrence in all life. It is due to this very fact that man has been able to improve and develop our farm animals to their present stage of perfection. Animal life is plastic and more or less susceptible to the influence of artificial conditions which man more or less controls. Food, habits, surroundings, the care of man, all affect the development of the dumb beast in a notable manner. It should be the business of the stockman to study these conditions and use them to the material improvement of his own herd.

IF YOU INHERIT A GOOD MEMORY, YOU SHOULD KNOW

1. The meaning of the word heredity.
2. Under what conditions prepotency is best seen.
3. Why a knowledge of heredity is important in stock breeding.
4. What is meant by constructive breeders.
5. The value of color markings in breed inheritance.
6. The relation of conformation and inherited speed.
7. Some peculiar forms of heredity.
8. The possible value of mutation.
9. What conditions influence variation.

FIND EXAMPLES OF INTERESTING CASES OF HEREDITY

10. Report on the best examples of heredity extending over at least two generations, in which very similar characters appear.
11. What is the most prepotent animal in the neighborhood, and why?
12. Report on any herd showing high ideals of the owner.
13. Interesting cases of fecundity among brood sows are not difficult to find. Look some up and report upon them.
14. What is the most interesting and peculiar case of heredity within your knowledge?
15. Find a case of atavism worth reporting.

CHAPTER III

SELECTION AND ITS IMPORTANCE

The principle of selection involves some method by which one or more animals are selected for specific purposes. The scientist recognizes two great classes of selection, one, natural; the other, artificial.

Natural selection is the process in operation among wild animals by which individuals choose or select their mates. Force is an important medium under such circumstances. A good example of the application of natural selection is found with the deer. The males fight among themselves to determine which shall be master of the herd, and the strongest, most masterful secures the leadership. This is what is sometimes termed "the survival of the fittest." Among all wild animals a similar method of selection exists to a more or less degree. This system weeds out the weakly, inferior animals and promotes the vitality of the race. Referring to this subject, Henry Drummond states:* "The object of the survival of the fittest is to produce fitness, and it does so, both negatively and positively. In the first place it produces fitness by killing off the unfit. Without the rigorous weeding out of the imperfect the progress of the world had not been possible. If fit and unfit indiscriminately had been allowed to live and reproduce their kind, every improvement which any individual might acquire would be degraded to the common level in the course of a few generations. Progress can start only by one or two individuals' shooting ahead of their species, and their life gain can be conserved only by their being shut off from their species or by their species being shut off from them." Again he says: "If a given number must die, that number must be singled

*The Ascent of Man.

out upon some principle, and we can not quarrel with the principle in physical nature which condemns to death the worst." Natural selection, therefore, represents a progressive development, with each succeeding generation somewhat stronger and better bred for meeting the requirements of existence. An especially interesting phase of natural selection is, that through it the species is developed so as to be best adapted to its purpose and condition of living.

Artificial selection involves the introduction of man. He controls the matter of selection, and thereby is able to cause the animal to vary more or less from the parent type. In the earliest times, no doubt man exercised some control over the animals that he found useful, and caused changes in



Figure 8.—The first prize Shorthorn herd, Ringmaster at head, the result of a policy in selection. Photograph from *The Farmer*.

their development. Thus man's ability to affect the purpose and value of dumb animals must have appeared evident to him long ago. The famous sculptures of Egypt and Nineveh, dating back thousands of years, show that domestic animals at that time must have been improved by man through the practice of selection. The Bible has been repeatedly quoted by writers on heredity, to show that the influence of selection was recognized prior to the time of Christ, as expressed in Genesis. Early writers like Plato, Pliny, and Columella, all refer to the improvement of live stock by selection. All through the intervening centuries up

to the present time, interesting references occur in history of the seeking of animal improvement through selection.

Methodical selection is a term used by Darwin to express the more systematic artificial process. In his most interesting work on "Animals and Plants Under Domestication," he presents much evidence to show the practical application of selection, and especially how by a methodical, carefully-planned system, remarkable results have been secured. Referring to this method, Darwin says: "Few persons, except breeders, are aware of the systematic care taken in selecting animals, and of the necessity of having a clear and almost prophetic vision into futurity. Lord Spencer's skill and judgment were well-known; and he writes: 'It is, therefore, very desirable, before any man commences to breed either cattle or sheep, that he should make up his mind to the shape and qualities he wishes to obtain, and steadily pursue this object.' Lord Somerville, in speaking of the marvelous improvement of the New Leicester sheep, effected by Bakewell and his successors, says: 'It would seem as if they had drawn a perfect form, and then given it life.' "

In connection with the practice of selection, it is important that the breeder keep in view certain things, if he is to be successful in accomplishing his purpose. He must place a premium on vigor or constitution, on digestive capacity, on superior quality, on conformation or a proper relationship of all the parts to the whole, and on the strong development of the particular thing desired, such as wool, milk, speed, etc., according to the class of animals.

A policy in selection is essential. Whether one is to breed one kind of live stock or another, one should not only have carefully considered plans, but should hold to them. One of the great reasons for non-success on the part of many breeders is the lack of a definite, well-founded policy. A man starts to breeding beef cattle, and after a time concludes he prefers a dairy breed; so he disposes of his beef stock.

Thus years of effort may be upset in a few days. More than one man in a vainglorious way has stated that he has tried all the breeds of this or that kind of stock, and that he knows all about them. Such a statement is evidence of superficial knowledge and policy, and that he will never amount to anything as a breeder.

Intelligent selection requires severe culling of the herd.

Men improve the average of the herd through the removal of the more undesirable animals. Some persons, however, find it difficult to do so, on the plea that they can not afford it, or that the misfit will do for the present. Yet the more uniform the excellence of the animals in a group, the more profitable the results to be secured. George A. Brown refers* to a practice followed in many parts of Australia, of employing an expert to cull and select the breeding animals in Merino stud flocks. Comment is made that, when the expert really understands his business, this plan has its advantages. A young stockman, by closely watching the methods of the expert, will gain a better insight into the business of selection for stud breeding than he could by any other means.

Selection as a means of securing desirable characters is one of the most easily applied practices. It is common to find certain recognized weaknesses or defects within a herd. It may be shown, for example, in a heavy, plain shoulder, or a weak, narrow back or an inferior hind quarter. The necessary thing to do under such circumstances is, first, to secure a sire that is especially strong where the females are weak; and, secondly, to dispose as rapidly as possible of the animals that possess these deficiencies in the most striking degree. In the most progressive live-stock communities, high-class breeding stock is greatly valued. In fact, we have no way of accurately measuring the value of a great, prepotent sire. It is understood by those familiar with many British flocks and herds that the best breeding animals can

*Studies in Stock Breeding, 1902, page 354.

not be purchased; they are not for sale. It is an old story that Edwin Hammond refused an enormous sum for the famous Merino ram Gold Drop, his reason being that he could not afford to sell his best ram at any price. Brown states that on one occasion a wealthy Tasmanian sheep breeder offered one of the most skillful island stud owners \$500 each for the pick of a score of ewes from his stud, and the offer was refused. These animals transmitted most valuable qualities to future generations, in no uncertain manner, the perpetuation of which qualities was of vital importance to the owner.

At the present time a great and increasing interest is shown in dairy cattle, and the marked improvement in producing capacity in many herds is evident through the use of sires that come from dams and families notable for milk or butter-fat records. Suppose a man desires to purchase a bull. Would it not be a fine investment to secure one from ancestry that would result in a herd of cows that would yield 400 pounds of butter-fat, each, per year, as compared with a sire producing cows giving only 200 pounds? Think of the difference in the final gain to the man and to the breed! One thing should be kept in mind in the effort to secure and hold desirable qualities, and that is not to breed with a narrow, one-sided policy, remembering that the greatest general perfection of form and function should always be the final object of the breeder.

Selection and environment have much in common. By environment is meant the conditions of climate, soil, shelter, etc. In very recent years the word "genetics" has come into use, and will no doubt become more common in the future. It refers to breeding scientifically, depending upon hereditary transmission, without regard to environment. When starting in the business of breeding, it is very generally regarded important that animals be selected that are suited to the special conditions under which they must live. While

it is true that domestic animals are adaptable, the different breeds are not equally so. Some, as, for example, the Shorthorn, seem to thrive under a wide range of conditions. Others are much less suited to change. Large, heavy animals are better adapted to the lower-lying lands and richer pastures; while the lighter, smaller type thrives in the hill country, where herbage is not so abundant. There are cases where men have persistently held to a breed under adverse conditions, and have selected until an adjustment was reached between the animal and the climate and the breeder.

Brown says that one of the great triumphs achieved by the husbandman, with the aid of selection, has been in stocking the "great thirst land of central Australia" with Merino sheep. When first taken to that country, they deteriorated greatly. The wool was reduced to less than half the original length, and became dry, very brittle, and open. Many sheep farmers gave up the attempt to produce the Merino as hopeless, but others persevered, and finally succeeded in producing sheep with fine forms and splendid fleeces. If one will carefully study breed distribution in America, it will be found that in some localities certain breeds are selected in preference to all others. For illustration, in the southern states Jersey cattle and Berkshire hogs are kept in preference to all other breeds. In warm climates a dark-skinned animal suffers from the heat less, and consequently hogs and cattle with dark skins prevail. Wisdom would justify no other policy of selection.

Feeding must also be recognized as an important factor in hereditary transmission. It is amply demonstrated that animals transferred from conditions of food scarcity to an environment of abundance through successive generations take on an increase in size. The Shetland pony on its native isles, subject to cold and more or less starvation, is a smaller, more inferior animal than that of the same ancestry, but which has passed through several generations in the

prairie country of America, where food is most abundant. Men may buy fine animals for their herds; but, unless properly fed and cared for, depreciation is sure to follow from generation to generation.

Uniformity in type of foundation stock should be most carefully considered. It is a common method for young men starting herds, to buy females without regard to uniformity of type. The result is that herds thus begun do not attain the standing they should, because of variation in the offspring, due to the lack of standards and of methodical selection at the start. One might far better begin with three females of uniform type and excellence than with a much larger number of no uniformity. The final outcome with the three would certainly encourage observers to pursue a similar method. No great herd was ever developed where the breeder did not lay special emphasis on uniformity of type from the beginning.

Rational selection is a thing greatly to be desired on the part of breeders. Too many persons are influenced in their selection by passing fads. In the past, men have insisted on maintaining herds of red Shorthorns or solid-colored Jerseys, allowing these fancy points to obscure more important ones. Hogs have been bred with such extreme dish of head as to make it impossible for them to eat in a natural way. Sheep have been bred with such heavy coverings of wool over the face as to prevent the use of the eyes. These features should never obscure the vision of the breeder. Rational selection requires putting a premium on constitutional vigor, size, and quality, and then wisely giving fancy characteristics of color, head, or covering of wool secondary consideration. It is not meant that these features should be ignored. In fact, they serve in part as factors in breed identity, but so also do other things. Nothing is so essential as vigorous constitution, and rational selection would naturally place a premium on this. One may strike the happy

medium on fancy points without detriment to his herd, and at the same time preserve the desirable qualities, thereby attracting buyers. But what could be more unwise than to neglect constitution in order to maintain some special color character? Yet more than one breeder has been guilty in this respect, to the positive injury of his herd.

A knowledge of breed character is requisite if one is to become an intelligent breeder. All our farm animals may be grouped into breeds, crosses, grades, or scrubs. Any improvement made must come through the breed, or pure-bred line. Our breeds are the outcome of systematic selection and improvement. Present-day standards are undoubtedly higher than ever, and breeders demand more and more



Figure 9.—Shropshire ewes heavily covered with wool. 1st prize pen Royal Society Show, England. Photograph from Sir William Cooper.

merit in breed representatives. Thus it is highly important that the stockman should be quite familiar with the scale of points, moulding all the desirable qualities into an ideal worthy of the breed, and then endeavor to produce animals that come nearest to that ideal. Such knowledge also calls for a keen discrimination in selecting the breeding stock by which the herd is maintained.

The selection of the pedigree. One can not practice selection and ignore pedigree. Persons familiar with lines of family breeding recognize that more merit exists in some

than in others. The men who have been most successful as breeders have always refrained from purchasing animals the pedigrees of which showed undesirable ancestry. Auction sales of live stock bring out various interesting features, chief among which is the relatively higher price paid for animals of recognized satisfactory pedigree. While it is true that in the past many animals have sold at high prices, largely on the basis of pedigree and without merit otherwise, the fact remains that, as a general rule, a combination of individual excellence and meritorious pedigree brings the highest price. The man who combines the capable judge and wise interpreter of pedigree is qualified to select his animals and improve his herd to the best advantage.

A SAMPLE SELECTION OF QUESTIONS ON SELECTION

1. What is natural selection?
2. What did Darwin say about methodical selection?
3. What is the Australian method of culling and selecting sheep?
4. How have great sires been valued by their owners?
5. What is the relation of animal development to soil and climate?
6. Why aim for uniformity of type in founding a herd?
7. What is rational selection? Illustrate.
8. How important is constitution?
9. What part should pedigree play in buying breeding animals?

SUGGESTIONS FOR INVESTIGATIONS IN SELECTION

10. Make a report on Charles Darwin as a student of selection.
11. What breeders that you know practice methodical selection?
12. Are there any sires in your county highly valued by their owners? If so, what are they, their value, and why so valued?
13. Give local examples of dairy cows having official records of milk or butter-fat production. Are these the result of careful selection?

CHAPTER IV

PEDIGREES AND THEIR VALUE

The pedigree of an animal shows the consecutive relationship of an animal to its ancestors. Of some animals we say that they are pure-breds, while others are known as scrubs or mongrels. The pure-bred has a known pedigree, while the scrub has not. Men have developed herds of

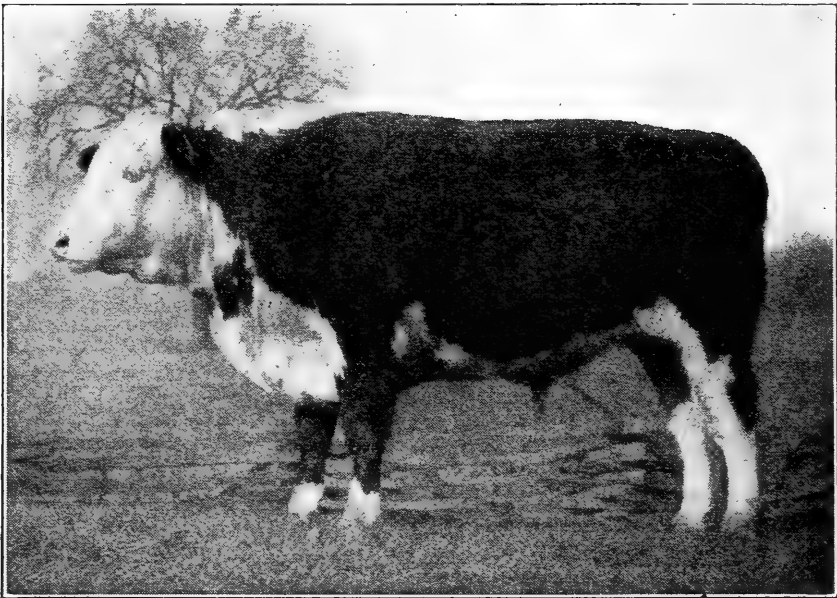

Figure 10.—Hereford grade steer, sired by pure-bred Hereford bull. Bred on the Texas range, fed at Ohio State University. Shows example of the influence of superior sire. Photograph by the author.

animals of similar character and ancestry from which they uniformly reproduce the parent type, and have kept careful records of the breeding. Such animals form a breed. To be pure-bred, an animal must show in its pedigree that it traces back wholly within the blood lines from which the

stock originated. If an animal is not pure-bred, it may combine in its pedigree widely differing blood lines that are more or less out of harmony with one another.

A cross-bred animal has a sire of one breed, and a dam of another. As a rule, cross-breeding is very undesirable, and should be carried only one generation, and then for the production of feeding-stock only. Some lines of cross-breeding, however, have been popular for many years. In Scotland what are known as blue-grays, famous for the quality of their beef, are crosses of white Shorthorns with black Galloways or Aberdeen-Angus. Another noted example of crossing breeds in Scotland is the mating of Border Leicester rams on Cheviot ewes, producing remarkably fine mutton. These two crosses are for meat production only, and extend but one generation.

A grade animal, in the large majority of cases, has a pure-bred sire, but is out of a dam that is not pure-bred. One often hears the expression *high grade*, which means that the animal referred to is by a pure-bred sire, and out of a dam that contains much pure blood stock. A high grade herd of Herefords would consist of a collection of animals that started with just common or scrub breeding stock, but in which for some generations none but pure-bred males were used as sires. Thus a systematic improvement of the herd would be made. The degree of improvement may be expressed as follows:

1st generation	=	Pure sire, scrub dam.	The offspring	=	$\frac{1}{2}$ blood
2nd	"	" " $\frac{1}{2}$ blood dam.	" "	=	$\frac{3}{4}$ "
3rd	"	" " $\frac{3}{4}$ " "	" "	=	$\frac{7}{8}$ "
4th	"	" " $\frac{7}{8}$ " "	" "	=	$\frac{15}{16}$ "
5th	"	" " $\frac{15}{16}$ " "	" "	=	$\frac{31}{32}$ "
6th	"	" " $\frac{31}{32}$ " "	" "	=	$\frac{63}{64}$ "

Thus it can be seen that in time a herd may become practically pure-bred, although one will not be able to register this high-grade stock in standard American breed registry associations. Yet all pedigrees really start from grade ancestry.

The value of the pure-bred sire on our American farms is far greater than most people seem to realize. When breeding males are not pure-bred, there is no standard of merit in the mind of the breeder. He is like a ship at sea without

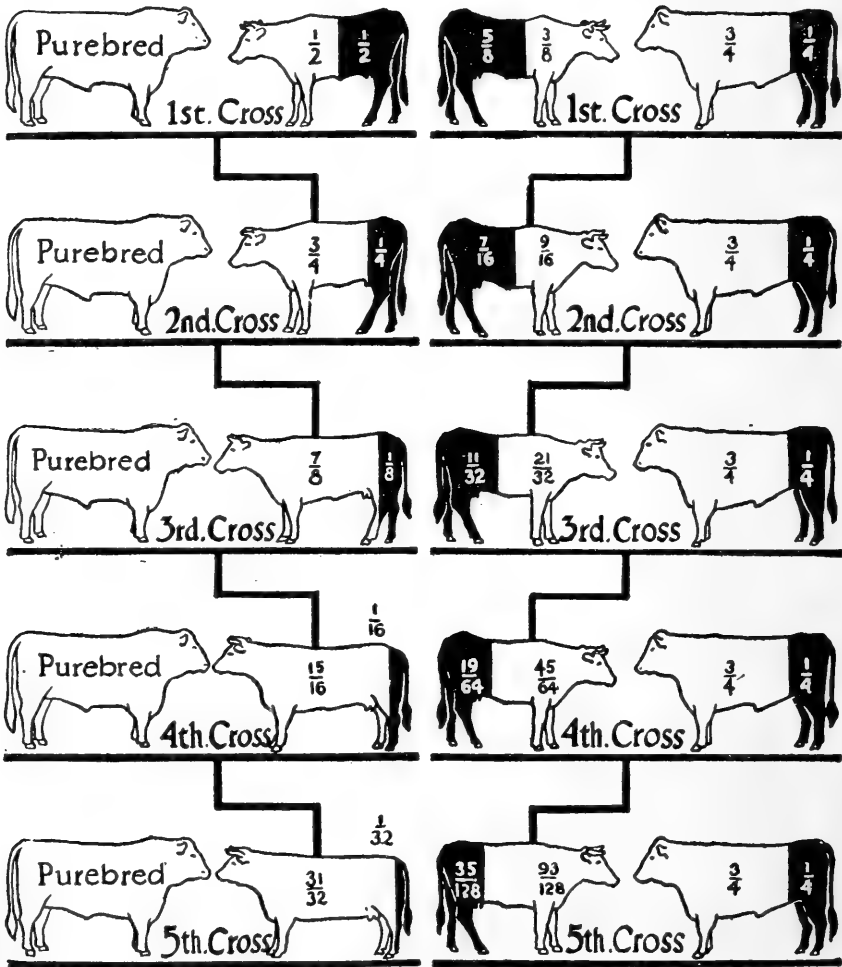

Figure 11.—This chart at the left side shows the influence of the pure-bred sire in improving the blood through five generations, as compared with the grade sire on the right side. Published by United States Dept. of Agriculture.

a rudder or an architect without a plan. Herd improvement can best be secured through the use of pure-bred sires of merit. This necessity has long been understood in Europe,

but in America a very large percentage of our breeders use only grade or scrub sires, which fact explains why one sees so many inferior animals on American farms. Recognizing the great importance of this subject, many of the American agricultural colleges and breed associations are doing everything possible to induce farmers to replace grades and scrubs with pure-breds. Surveys have been made in different parts of the country, to learn something of the number of pure-bred, grade, and scrub bulls in service. In Wisconsin breeders investigated the subject, and offered pure-bred bulls at especially low prices, in order to improve the live stock of the state. As a result of this special campaign it is estimated that more than 1,600 pure-bred bulls replaced grades and scrubs in Wisconsin, and as many as 191 found places in one county. In some counties in the United States the people have shown great interest in this matter, and have got rid of nearly all the sires but pure-bred ones. The Iowa experiment station conducted an interesting breeding problem to show improvement from the pure-bred sire. The station bought some very inferior scrub cows from a section of country where the people had never used pure-bred sires. The offspring of these by pure-bred sires, that is, the first cross, showed a great increase in milk production. In one case this amounted to 107 per cent milk and 112 per cent butter-fat. In the next generation, with 75 per cent pure-bred offspring, there was secured an increase of 194 per cent milk and 138 per cent fat over the original scrub cow parent. This experiment should be no surprise, because on every hand we see the wonderful influence of the pure-bred sire. In fact, whatever of merit we have in our herds and flocks to-day, we need not hesitate to say is due to the careful work of men who have used pure-breds only.

The bracket form of constructing a pedigree shows the family relationship by means of a series of brackets, after the following manner. This is the most common form in use.

DUROC-JERSEY BOAR, Orion Chief 13333	{	Orion II, 6539.	{	Orion 4901
				Ohio Anna 10068
		Mabel 22518	{	Longfellow 6815
				Agnes X 15250

In making this form of pedigree, the names of the males are at the top of each bracket, and the females at the bottom. This style may be extended from generation to generation, the number of ancestors doubling each remove to the right. This pedigree shows that Orion Chief, a noted Duroc-Jersey, had Orion II for sire and Mabel for dam. Going back another generation, it will be noted that, in the line of male descent, his grandsire was Orion and his grandam, Ohio Anna. On the dam's side, Longfellow is his grandsire and Agnes X, the grandam. If we now go back another generation, we have four great-grandfathers and four great-grandmothers. This form of pedigree shows the complete ancestry, and is the only one generally used by stockmen in giving the breeding of an animal. One may find many examples of this form of pedigree in the sale catalogues of breeders of dairy cattle and swine. These publications of pedigrees may usually be obtained on application to advertisers of such sales in live-stock and agricultural journals.

The ancestral line of the dam is another form of displaying a pedigree. This may be illustrated by the following pedigree of the Shorthorn bull Villager.

IMP. VILLAGER 295884.

Roan; calved March 1, 1906. Bred by C. H. Jolliffe, Darlington, England.

DAMS	BREEDERS OF DAMS	SIRES	BREEDERS OF SIRES
Rosy Cloud (Vol. 50E).....	C. H. Jolliffe	Village Beau 295883	Wm. Duthie
Rosy Dawn.....	C. H. Jolliffe	Chorister 295882	Wm. Duthie
Rose Blossom.....	S. Campbell	Misty Morning 153603	Wm. Duthie
Roselinty.....	S. Campbell	Clan Alpine 130852	Messrs. Nelson
Rosemary.....	S. Campbell	Gravesend 98361	A. Cruickshank
Roan Rosebud.....	S. Campbell	Banner Bearer 96034	Wm. Duthie
Rosebud.....	S. Campbell	Borough Member 64872	J. Bowman
Rosebud 1st.....	S. Campbell	Sir Christopher (22895)	R. Booth
Rosebud.....	S. Campbell	Diphong (17681)	A. Cruickshank
		Scarlet Velvet (16916)	A. Cruickshank

Villager is of special interest to Shorthorn breeders, because he is one of the most noted sires in the history of the

breed during the period between 1910 and 1920, being used during this time in very superior Ohio and Iowa herds.

This form of pedigree shows the bull Villager to be sired by Village Beau, a bull bred by William Duthie, a noted Scotch breeder. Villager's dam is Rosy Cloud. She was bred by C. H. Jolliffe, and her sire was Chorister, also bred by William Duthie. The grandam of Villager was Rosy Dawn; his great-grandam, Rose Blossom; his great-great-grandam, Roselinty; etc. This pedigree goes back ten generations, emphasizing the ancestry of Villager on his mother's side, with the sire of each female in this breeding. Except for the sire, the ancestry on that side of the pedigree is entirely left out, and with only a part of the breeding on the dam's side given. While it is true that the dam's pedigree is thus carried out much further than in the bracket form, what one should know most about is the near relationship all through, for at least four generations. A Shorthorn pedigree of this form shows to a more or less degree the tribe or family to which the animal belongs, which in this case is the Rosebud, which started in the herd of S. Campbell, a famous breeder of Kinellar, Scotland. In reference to this pedigree, after the name of each male a number is given. This indicates his registry number in the Shorthorn herd-book. When written in parenthesis, it is the English Shorthorn herd-book number. Formerly only the herd-book volume and page was given for Shorthorn cows, but now the females registered in America are given numbers, as is customary with all other breeds. The line of female descent pedigree is not the best, and breeders generally should use the bracket form.

The amount of ancestry shown in a pedigree naturally depends upon how far back it traces and its completeness from generation to generation. The following tabular statement is given by Davenport,* which shows in a rather striking way the percentages of blood in a pedigree at different points for ten generations.

*Principles of Breeding. E. Davenport, 1907, page 595.

Relative intensity of blood lines and approximately relative influence of different generations and individuals for ten generations backwards.

Generation backwards	Number of ancestors	Influence of generation Per cent	Influence of each individual Per cent
1	2	50.00	25.00
2	4	25.00	6.25
3	8	12.5	1.56 +
4	16	6.25	0.39 +
5	32	3.125	0.10—
6	64	1.5625	0.024 +
7	128	0.78125	0.006 +
8	256	0.390625	0.001 +
9	512	0.1953125	0.0004—
10	1024	0.09765625	0.0001—
Total	2046	99.90234375	

The statement set forth by this table shows how little influence is derived from one individual in the ancestry ten generations back. In fact, until recently a number of our live-stock associations promoting and registering pure-bred animals would accept for registry individuals that five generations back showed impure blood. Yet the value of blood lines depends also on the character of the breeding. If the ancestry contains the names of animals of distinction within the same family lines, then it will mean much more to the breeder who understands pedigrees than it will if the inheritance shows no family names of value.

The merit value of a pedigree is shown in the character of the records made by the different animals composing it. This phase of the pedigree receives very careful attention from the thoughtful breeder. Some of the most interesting examples of constructive breeding that have taken place in America in recent years, are clearly brought out in pedigrees where record of performance was ever kept in mind by the breeder. The following pedigree of Sophie's Bertha, one of the great Jersey cows of America, is an interesting illustration of such constructive breeding.

<p>Sophie's Bertha 313238..... Gold Medal cow. Ex-world champion 3-year-old—14,954. 2 lbs. milk, 829.54 lbs. fat; 13,242.8 lbs. milk, 771 lbs. fat at 2 yrs. 2 mos., 16,102.1 lbs. milk, 875.41 lbs. fat at 4 yrs. 9 mos. Dam of Sophie's Bertha 2d—13,393.4 lbs. milk, 691 lbs. fat.</p>	<p>Pogis 99th of H. F. 94502..... Champion A.J.C. C. Gold Medal bull. Sire of 82 R. of M. daughters including Sophie's Agnes, ex-champion, 1,000.07 lbs. fat.</p>	<p>H. F. Pogis 9th 55552. Ex-champion Jersey sire with 79 cows in R. of M., and 33 producing sons.</p>	<p>H. F. Pogis 40648 Sire of 15. Figgis 76106 19 lbs. 15 oz.</p>					
				<p>Lass 66th of H. F. 271896..... Gold Medal cow. World's champion senior 3-year-old, 17,793 lbs. milk, 910.60 lbs. fat.</p>	<p>Sophie 19th of H. F. 189748..... World's champion long-distance cow, 9 yrs. tests, 6,356 lbs. fat.</p>	<p>L. H. F. Chief 62859 Sire of 4 in R. of M. Phil's Scituatue 163456 A 22-quart cow.</p>		
							<p>H. F. Torono 60326... Gold Medal bull. Sire of 73 in R. of M., and 25 producing sons.</p>	<p>Torono 25204 Sire of 19 tested cows. Tormentor's Lass 59832 19 lbs 8½ oz.</p>

In a study of the pedigree of a race horse, one should find therein the names of many animals with speed records to their credit. In the case of a dairy breed of cattle, then milk or butter-fat records may be given, as well as the records of offspring of sires and dams. With some breeds, a statement is affixed showing prizes won in the show ring. In cases of animals selling at high prices, these facts are also sometimes inserted in the pedigree. The important thing is to show at different points in the ancestry the richness of the pedigree in production. At the present day, one should have no difficulty in securing the pedigrees of pure-bred animals that will give more or less specific information regarding performance on the part of individuals in the pedigree. The richer the ancestry in record-making achievement, the higher the price one usually pays for the animal purchased.

A pedigree score card suggesting the relative importance of near and remote ancestors has been proposed by Prof. F. R. Marshall.* In this score card, 24 points are given the sire (12 for siring good stock, and 12 for individual merit), and 24 points are given the dam (10 for her record as a producer, and 14 for individual merit), with 4 points on similarity of type of sire and dam. The grandparents are given a total of 24 points, ranging from four to two points each for records

*Breeding Farm Animals, 1911, page 110.

as producers, and individual merit. The great-grandparents are accorded one point each on production, individuality, and ancestry. This is an interesting score card, that may come into considerable use.

The accuracy of the pedigree is of first importance. It may not be accurate for two reasons; first, because of errors in writing it, due to carelessness or otherwise; and, second, from dishonesty. Mistakes will occur among the most careful and conscientious. The published herd-books of registry associations have in the past contained many errors, although conditions now are greatly improved. Also honest men have copied from sale catalogues pedigrees that contained mistakes, and have republished these errors. The most unfortunate pedigree is the "doctored," or crooked, one. Fraudulent pedigrees exist, and men have on more than one occasion been prohibited from doing business with registry associations on account of fraud. If guilty, the penitentiary is what they deserve. Integrity is the foundation on which the pure-bred live-stock business is based, and all premeditated cases of fraud should be regarded as of criminal character, and be punished accordingly.

A study of pedigree is a necessity, if one is to become a successful breeder of pure-bred stock. There are several ways by which one may become familiar with pedigrees. Suppose one is to breed Jersey cattle. Then, if in the business in a serious way, one should try to secure the herd-books published by the American Jersey Cattle Club. These are the original source from which all Jersey pedigrees are made up in the United States.

Bracketed pedigree blanks may be purchased from some of the larger associations registering live stock, and publishers of some of the special breed journals also supply them. With the herd-books at hand, and these blanks, one may, as a rule, trace out pedigrees without difficulty, after becoming acquainted with the method of doing so.

Sale catalogues should be saved by the breeder, for they will often be found valuable for reference, even though some of them are carelessly prepared. The register of merit should also be kept for reference, so that information may be at hand regarding official records of production. One also should read the current literature regarding the breed. Some of the more important breeds are represented by special journals, which contain a large amount of information concerning animals of distinction. By these various methods one may accumulate much knowledge regarding pedigrees of animals.

IN MAKING A STUDY OF THE PEDIGREE

1. What does it show?
2. What is a grade or high grade?
3. Explain the bracket form and its value.
4. What is meant by line of female descent?
5. How many ancestors does one have in the fifth generation back?
6. How important is the blood influence of an animal ten generations back?
7. What is merit value of pedigree?
8. Describe a pedigree score card.
9. Give two causes of inaccurate pedigrees?
10. How can one become familiar with pedigrees?

BRING TO THE CLASS

11. The pedigree of an animal with which you are acquainted.
12. An example of a bracketed pedigree.
13. A sample of a Shorthorn pedigree.
14. Pedigree showing merit, or performance of,
 - (a) Dairy cattle
 - (b) Race horses
15. A sale catalogue showing prices paid for animals.
16. A pedigree containing an error.

CHAPTER V

SUGGESTIONS TO YOUNG BREEDERS

A study of the principles of breeding should be made by the stockman who wishes to become eminent as a breeder. It is not necessary that one should dig deep into this subject, but a knowledge and application of the elementary principles are essential. No great constructive breeder ever lived, who did not carefully apply the law that "like produces like," in the development of his herd. The student should keep in mind, therefore, no matter in what kind of stock he is interested, that these pages are intended to serve as a help in producing better and more profitable animals. In this connection there are certain things that may well be emphasized in starting out to build up a herd.

Breed for a special purpose. The successful breeders of farm animals have always been specialists. The first thing to be considered is the purpose one has in mind. Some animals, such as beef cattle or swine, are primarily for meat; others, as some breeds of dairy cattle, have their chief value in yielding milk; the draft horse is of little use except for hauling great loads; while Merino sheep are notable for wool production. If mindful of these things, and directing energies rightly, one may not only secure fame as a breeder, but obtain wealth in the doing. A multitude of examples illustrating the policies of successful stockmen with the different breeds of farm animals might be given to show the results secured through breeding for special purpose.

Stick to a well planned policy. The breeders who have won the greatest success, have been persistent, and have not deserted the breed with which they began. One who endeavors to keep only a class of live stock that is selling at

long prices, closing out during depressed values, generally fails. Every business, including that of live-stock production, passes through periods of prosperity and of depression. Sheep have far too often gone through extremes of values. For example in February, 1920, live lambs sold on the Chicago market for about 20 cents a pound. During the next ten months they steadily declined in value until they reached $11\frac{1}{4}$ cents a pound in December. These great drops in prices are always accompanied by big losses, and thus, discouraged, many men go out of the business, disgusted. But here is just the time to stick. One will have no difficulty

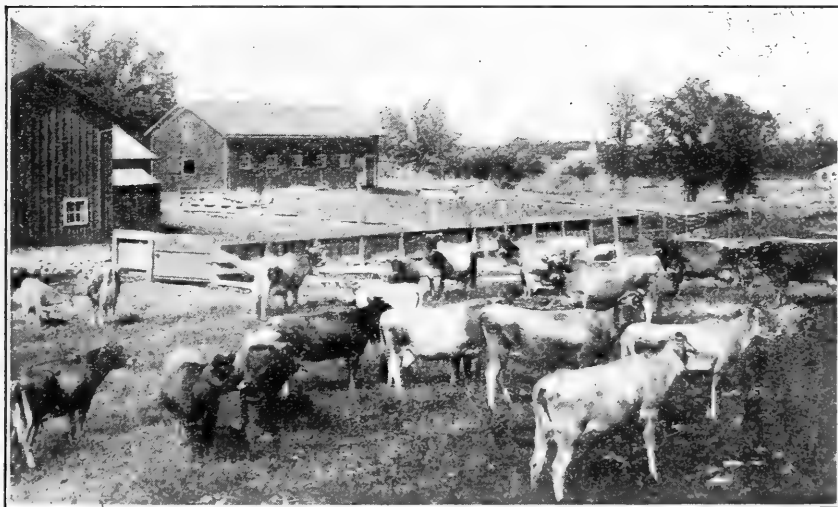

Figure 12.—“Keep a few good ones.” Photograph by Prof. John W. Decker.

in finding plenty of examples to demonstrate that the man who stays by his sheep through the years, whether prices are good or bad, makes a good profit on his long time investment and has a well established credit among his neighbors.

Keep a few good animals, rather than many that are inferior. One may perhaps make money breeding ordinary individuals, but the right kind of reputation comes to a breeder through his best animals. A buyer, as a rule, will try to purchase the choicest stock. If the breeder sells

these, he will follow the worst possible policy. As has been suggested elsewhere, he would better cull out the undesirable animals and rely on a smaller number of good ones to build up his herd. A group of uniformly good animals, whether grade or pure-bred, is always an attractive sight, and serves as an advertisement of the best kind. A motley herd, lacking character, is not attractive, and hurts the reputation of the breeder.

Pay a premium for merit when purchasing animals. Many breeders buy inferior animals because they are cheap. From a breeding point of view, one should select animals that combine individual merit and pedigree. If there is anything in the laws of breeding that has been helpful in the past, it is the knowledge that like produces like. Each year in the history of a herd should mark improvement, which is quite impossible if one purchases beasts of an inferior character. The influence of a new animal in the herd is usually far-reaching for either good or bad. One should carefully consider this, and be governed accordingly. Some of the most profitable breeding animals in history cost a high price. The Berkshire boar, Masterpiece, was purchased by Mr. W. S. Corsa for \$2,500, and proved to be a very profitable animal at what was then a record-breaking price.

Try to become a judge. If one is to be a breeder, one should understand the relation of form to purpose, and should be able to select intelligently the right breeding stock. It is impossible to conceive of a man's being a good breeder who is not capable of judging his own animals intelligently. There are many courses of instruction in our schools and colleges of to-day in which systematic training in judging may be secured. Good judgment in culling out the undesirable animals from the herd, and in the purchasing of new stock, is highly essential, whether for breeding or feeding purposes. Some practical feeders have the reputation of shipping only good fat stock to the market, and buyers

are always on the lookout for animals fed by them, for which they are very willing to pay the top price of the day.

Feed your animals well. One can not purchase high-class stock and keep them in good form and state of development, unless properly fed. Many persons buy animals in good condition, but neglect them after the animals come into their possession. Where men must buy feed, they too frequently neglect to give their new purchases enough to keep them in thrifty, healthy condition. Food is essential to maintain life and produce growth and vigor. It is a serious mistake to be niggardly in the use of feed. Furthermore, no herd can do other than go backward, if the animals are not fed wisely. Young growing stock, starved and neglected, become inferior in development, and in due season naturally reproduce inferior offspring. A true stockman always enjoys seeing his animals eat, and realizes that something is wrong if they do not show a hearty appetite.

Do not be led astray by fads. Develop a herd that combines the useful and beautiful in the highest possible degree, for these two important features naturally go together. Leave out of consideration pedigrees that do not stand for merit. Remember that peculiarities of form often are of little real value, and that it is not wise to go to extremes in these things. Do not make color a vital object with those breeds in which variation in this respect occurs. Whether an Ayrshire cow is one fourth or three fourths white, or a Shorthorn red or roan, is a very superficial matter. General conformation, constitution, and producing capacity are the important subjects to consider rather than the color fad.

Study your local conditions, and endeavor to learn with what class of live stock you will be most likely to succeed on your farm and with your surroundings. As a rule, it is best to keep the breed or kind of animals most common in the locality. One should know, however, that, as a rule, the heavier type of animals is native to low-lying, fertile coun-

tries. The largest British breeds were developed in the more level, fertile sections of England, while the smaller, more active breeds came to their own in the hill country or mountains. The farmer of New England should realize that his farm may not be suited to the same kind of live stock as a farm in Iowa. While for good reasons Merino sheep do remarkably well in Ohio, for climatic reasons they would not do so well in the far South. The markets are vitally important, and should influence one in directing breeding operations. The abundance and kind of food also play their part. Compare the type of hog of the corn belt with the sort most popular in Canada, where wheat, oats and barley prevail.

Become acquainted with the families or strains of the breed in which you are interested. It is important to know something of these. Those breeds that are represented by a large number of animals, include families of varying degrees of merit. These family traits may be regarded of much importance, and may greatly affect values. Prepotency, special forms of production, adaptability to certain conditions, temperament, etc., are features one or more of which are stronger in some families than in others. Old experienced breeders who are regarded as successful, consider carefully matters of this sort, and act accordingly.

Cultivate the acquaintance of breeders. The man who would succeed in his business must gather information from every legitimate source. Knowledge is a matter of accumulation. We accumulate through observation and personal contact. We get inspiration from those who succeed. It is a fine thing to enjoy the friendship of men who are leaders in the line of business in which we ourselves are interested. Darwin, one of the greatest scientists, gathered a fund of most valuable information from the English stockman and farmer, in whose acquaintance he took great pleasure. Thomas Bates, the noted English Shorthorn breeder, received much inspiration from his acquaintance with the

Colling Brothers, men who were doing much for these cattle while Bates was yet young. Furthermore, co-operate with your brother breeders in a generous way for the promotion and uplift of live-stock interests, whereby all will be benefited. Become a member of the local, state and national associations that promote the breed in which you are interested, whenever possible attend the meetings of these organizations, and be known as a progressive among your fellows. The compensation that comes from this contact can not be estimated in money, for it is expressed in friendship, in helpful service, and leads into the larger field of usefulness and efficiency to which every breeder with ideals should aspire.

A private herd record should be kept by every stockman owning a breeding herd. Such a record should contain a list of the animals in the herd, giving their correct names and registry numbers, dates of birth, names of sires and dams, and of the men who bred them. A record should also be kept of all animals produced on the farm, with facts of their parentage. One may keep a card catalogue with a card for each animal, giving the essential facts. There are private herd-books especially arranged, providing blank spaces for the various facts of importance, that can be purchased at a reasonable price. If desired, one can prepare his own style of private herd-book. The records which go in such a book are most important, and all men engaged in breeding should feel it a duty to keep them with care.

Methods of doing business with registry associations should be considered by the breeder. Each breed is represented by an association of men who prescribe the methods of registry and transfer of animals of that breed. It is the business of the secretary to furnish breeders with blank forms which they may fill out and file with the association, whereby they may register their stock from time to time. The secretary also furnishes the required rules and regulations for doing business with the association. It is not necessary for

a person to be a member of an association for promoting and registering a breed, but it is desirable that he should be. As a rule, members of registry associations do business with it for about half the cost to outsiders; and if one registers many animals, one would soon cover the cost of membership, which varies with the breeds from \$5 to \$100.

CERTIFICATE OF ENTRY IN THE HERD REGISTER OF		
The American Jersey Cattle Club		
COW		
<i>Name:</i>	Ohio Silver Lady	No. 296486
<i>Sire:</i>	Ohio Topnotcher	102294
<i>Dam:</i>	Ohio's Silverine	223947
<i>Dropped:</i>	June 22, 1913	<i>Registered</i> Sep 22, 1913
<i>Markings:</i>	Solid color; black tongue and aw.	
<i>Breeder:</i>	Ohio State University, Columbus, Ohio	
<i>Owner:</i>	Ohio State University	
<i>Entry fee paid:</i>	\$ 2	
		<i>A. M. Lyon</i>

Figure 13.—A reduced size example of a registry certificate, as issued by the American Jersey Cattle Club.

The identification of breeding stock on the farm is important. For this reason various methods are used to mark animals so that they can be identified. Metal ear tags, on which is stenciled the name or initials of the owner, with a number, are in common use. Such a tag is fastened in the ear, a hole being punched through which to pass a part of the tag. These tags are often torn out and lost, and so are not altogether popular. The tattooing of numbers within the ear, by means of a special needle and an indelible fluid, is also used to some extent. Hogs and sheep are commonly identified by notches cut in the thinner edge of the

ear, although metal tags are also frequently used with these animals. The hoofs of horses are at times stenciled with numbers, especially in case of importation. Sometimes the horns of cattle are marked in a similar way. On the ranges, cattle and horses are branded, and sheep are given marks with paint, by which ownership may be identified. Some of our breeds of dairy cattle, especially those of different body colors, are identified by the location of color marks on the body. For example, when applying for registry of a Holstein-Friesian, it is necessary to trace on a diagram showing the outline of

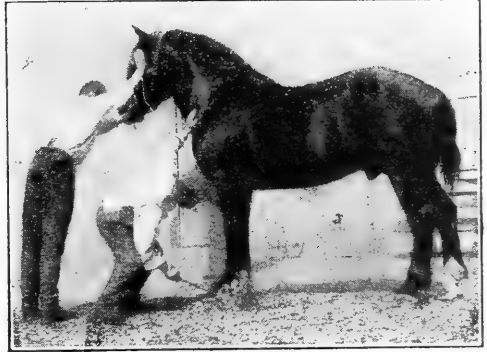

Figure 14.—Branding numbers on the hoof of a horse. Picture taken in France of a horse to be exported. Photograph by the author.

body form, the shape or outline of each black spot, or marking. A copy of these outlines is made on the certificate of registry, so that identification is made easy. Every breeder, as a matter of good policy, should have a system of individual identification of the animals in his herd.

Literature relating to the breeds should be made use of by every one who owns pure-bred live stock. There are standard books sold by publishing houses, in which one may obtain a large amount of valuable information regarding the breeds. There are also current periodicals devoted exclusively to promoting the interests of particular breeds, which should be well supported by the breeders of the same. Each of the different breed associations registering pure-breds, publishes herd-books, in which will be found the names and numbers of registered animals, with information as to dates of birth, names of breeders and owners of sires and dams, etc. These books should be on the shelves of the stockman

who is a student of blood lines or pedigrees. Breed associations also publish free literature concerning the breeds they are promoting, and as this is official, it is supposed to be accurate and desirable information. Real live-stock students should inform themselves, and it is to be regretted that there are many who know comparatively little about the history, development and breeding of their own herds.



Figure 15.—Southdown stock rams in England, showing numbers stenciled on the backs. Photograph by the author.

AS A MATTER OF GOOD BUSINESS

1. What reasons can you give for an established policy?
2. Give an example of paying a premium on merit.
3. Has feed much to do with herd improvement?
4. Explain the meaning of a live-stock "fad."
5. Why cultivate the acquaintance of breeders?
6. What advantage is there in the private herd-book?
7. Why be a member of a live-stock registry association?
8. Specify three kinds of identification marks for live stock.
9. What forms of literature are available for the stockman?

FIVE INTERESTING THINGS TO DO

10. Locate the man who has dealt in some one kind of live stock longer than anyone else in your section, and report on his methods, after making him a visit.
11. Report on the most uniform herd within five miles of school, giving facts of interest.
12. Make a sample page for a private herd record and bring to class.
13. Secure and bring to class samples of application for entry blanks for registering and transferring animals of some one breed.
14. Report on methods of marking animals for identification as used by stockmen in your neighborhood.

CHAPTER VI

COMMUNITY BREEDING OF FARM ANIMALS

What is community breeding? In the origin and improvement of the breeds of live stock, groups of people having certain things in common within limited areas have developed most of our breeds. A good example is found in the development of Hereford cattle in England. All the historical information we have shows that in the county of Hereford in England the farmers centuries ago kept a certain class of cattle famous for beef production, that were very hardy and well-suited to maintaining themselves on grass lands. The people in this English county studied their local conditions, and during the years greatly improved their cattle, until they became satisfied they had the best breed for their community. Very naturally some breeders were more intelligent and more progressive than others, which fact was reflected in the class of animals they produced. These men found themselves working towards a common end, even though the effort was free from organization. Thus in time this community became famous for the excellence of its herds. In Europe we find many sections in each of which a certain breed has developed that has seemed to be especially fitted to the local conditions. Many British breeds are named after the counties in which they originated, as, for example, Berkshire swine, Shropshire sheep, Devon cattle, Aberdeen-Angus cattle, Yorkshire swine, etc.

The importance of community breeding can hardly be overestimated, for it always represents improvement and progress in breed promotion. Co-operative breeding of farm animals has resulted from community breeding. The first co-operative movement for the systematic improvement and

promotion of a breed was probably with the people on the Island of Jersey, who in 1763, by legislative action, prohibited the bringing of other cattle to the island, unless for immediate slaughter. In 1833 the people on the island introduced the use of the scale of points whereby they might have a common standard for improving their cattle. In England through co-operative effort, as early as 1791, a book was published in which was given the names and breeding of Thoroughbred horses, and in 1822 a herd-book for Shorthorn cattle was published. These first two books of the kind were the outgrowth of community breeding. Eventually co-operative community organization became a necessity in promoting the established breeds; otherwise there would have been no means of standardizing the breed and through well-planned supervision of protecting its purity.

Community breeding of farm animals in the United States in an unorganized form perhaps first took place in Vermont, Pennsylvania, and Ohio, in the breeding of Merino sheep. Sheep husbandry in those states between 1810 and 1870 became a great industry, and the Merino was the universal sheep. This result was due to the fact that this breed or type of sheep supplied the great demand for fine wool, while the wool from other sheep was at a disadvantage in the market. So famous did Vermont become as a Merino center, that in far away Australia, to which many of these sheep were exported, the shepherds supposed all Merinos from America were grown in that state, and they were known as "Vermont Merinos." The first organized community breeding association in America was the Western Reserve Holstein-Friesian Association, organized at Burton, Ohio, in 1905. Later the name was changed to the Geauga County Holstein-Friesian Association. The purpose of this organization was to extend the interest in cattle of this breed and promote its welfare by all proper means. In 1906 the Waukesha County (Wisconsin) Guernsey Breeders' Associa-

tion organized, for promoting this breed of cattle. This association has had a remarkably successful career, and, largely due to its influence, Waukesha County has become the leading county in America for producing Guernseys, while Wisconsin has become the leading state in herds of this breed. Since the organization of these two community breeding associations many others have been started in America, so that now a great movement is taking place in important live-stock centers which must largely benefit individuals and local communities in which they exist.



Figure 16.—Geauga County (Ohio) Holstein-Friesian Association on annual picnic at the Watt Farm. Photograph by the author.

A well-planned method in breeding farm animals has not been customary with the American stockman. His herd more often than not consists of so-called representatives of more than one breed, and he develops it without plan or purpose. The work he does as a breeder makes less efficient and valuable the live stock on the average American farm. One may travel the length and breadth of the United States and find countless examples of destructive breeding of this sort. Operating against a host of such breeders of farm animals is a comparatively small number of men who with

fixity of purpose strive to produce pure-bred animals along well-planned lines. Their herds and flocks are the salvation of the whole live-stock business. It is in groups of community breeders that we find the people keenly interested in real merit, in efficiency of production, and in what we term constructive breeding.

One breed is better for a community than many. It has been well-established in Europe for many years, and more recently in America, that in those sections where but one breed of a class of animals exists the community is enriched thereby. The buyer has a much better chance to select from many herds in such a community than he has where the herds are few and far between. Buyers have shipped large numbers of Holstein-Friesian cattle from Geauga County, Ohio, and Guernseys from Waukesha County, Wisconsin, because they could find them among the many herds in these counties. If there is but one herd in the community, then the choice is limited, and the expense of a visit does not justify the buyer. Only men with narrow visions see no advantage in many herds of one breed in the neighborhood.

Community breeding stimulates prices and trade. In the locality where many herds or flocks of the same breed prevail, breeders take a keen personal interest in the different herds, and place a premium on animals of outstanding merit. Here one finds competition in purchase which naturally results in stimulating prices and a greater activity in trade. In one of our best live-stock communities in America annual or semi-annual sales have been held for some years, and the demands in most if not all of these places has been for more animals, with a healthy increase in values.

Community breeding promotes confidence in one another among the breeders. The primary purpose in breeding associations is co-operation. Working together toward a common end eliminates personal selfishness and jealousy. Suspicion and jealousy have done much harm among farmers,

which is a sad but true statement. Co-operation is an evidence of faith in the good intentions or motives of those co-operating, and, therefore, is highly commended. This spirit is better today than ever before.

Recognition comes to the man with the small herd in a community of interests, as would hardly be possible otherwise. In a well-established locality, where there are many herds, buyers secure lists of the breeders, and go about among

Let's Get Acquainted
 Come to the
First Annual Sale
 of the Lucas County Holstein-Friesian Club on
Thursday, Nov. 20, '19
 At 10:30 A. M. Terminal Bldg.,
 Cherry St., Toledo, Ohio
**80 Head of Choice, High Class,
 Registered Holstein-Friesian Cattle**
 will be sold to the highest bidder, without reserve. The consignments include cows, heifers, and bulls of the best breeding, and backed by men who stand behind every animal offered. ALL OVER SIX MONTHS TUBERCULIN TESTED. A. R. O. cows bred to 30-lb. bulls. Daughters and sons of A. R. O. cows. Some well bred serviceable young bulls, a lot of good young cows, and some choice yearlings and calves. Better plan to attend the sale. For information and catalog write,
Keith C. Hoover, Sale Mgr., West Toledo, O
 Col. D. L. Perry, Columbus, Ohio, Auctioneer.

**Ohio Guernsey
 Breeders Association**
 is consigning
**75 Ohio's Best Guernseys
 at Auction 75**
Columbus, Ohio, June 15, 1920
**A Golden Opportunity to Buy the
 Cow that Produces the
 Golden Product**
 Mar's Noble Galaxy (68637) just finished an A. R. record of 9,853.0 lbs. milk and 567.02 lbs. fat in the Roll of Honor Class E. E. milked twice a day under ordinary farm conditions. A Class leader.
 Chilmark Rival Antonnette (58644) Sired by Langwater Rival and out of a daughter of Imp. Mashers Galore, will complete her record by sale day with about 11,410 lbs. milk and 580 lbs. fat in C. C.
 These excellent cows together with 73 others of equal merit promising high production even under average conditions are features of the Ohio Guernsey Breeders' Association's first annual sale.
 CATALOGUES ON REQUEST
OHIO GUERNSEY BREEDERS' ASS'N.
 A. C. RAMSEYER, Sale Manager, Smithville, Ohio
 FRED W. ANDREWS & SON,
 Auctioneers New Philadelphia, O.

Figure 17.—Samples of community advertising in agricultural journals.

them and inspect their animals. Community publicity does not favor one breeder more than another. Each has his opportunity, and is not likely to be neglected.

Expense of advertising in community herds is less than otherwise. Joint advertising is often engaged in under the supervision of the secretary, who attends to publicity work. Some associations publish booklets containing the names and

addresses of the breeders comprising them. One county horse association has published a beautifully illustrated pamphlet, giving fine pictures of prominent horses owned among the members, with a complete list of the officers and all others belonging to the organization. Some members of community associations unite in co-operative advertising in standard breed or live-stock journals, thus reducing individual cost for each person. Following is an interesting example of community advertising as described in an article written by Mr. R. A. Hayne.*

“At Lake Mills, Wisconsin, there is a most unusual sight, unusual in size and subject, visible a quarter of a mile away, and worth no doubt to both town and county uncountable times what it cost. On the side of a large brick building right opposite the square and across the street from the town park, so plainly in sight that you can not go past or through the town without seeing it, is a huge painting of a Holstein cow in natural colors, and around her, also plainly visible at a distance, are the names of fourteen Holstein breeders and their locations. Who will say that Lake Mills did not act wisely in displaying such an advertisement instead of the famous trade mark of the amber fluid that made Milwaukee famous?”

Fine herds and flocks bring fame to a community, and add to the value of the land, two important assets that should not be underestimated. This point has been brought out in a marked degree in many places, as, for example, the saddle-horse industry in Kentucky and Missouri, the Percheron in Ohio and Illinois, the Guernsey in Wisconsin, the Aberdeen-Angus in Iowa, the Merino in Ohio, etc. More and more the public will learn of certain communities in America famous for their herds and flocks, where the opportunities for purchase are more attractive than elsewhere.

Community breeding encourages the interest of the young people, for where practiced we find the most progressive breeders, the very best examples of farm animals, and homes of comfort occupied by an intelligent, gentle people. In a community frequently visited by outside buyers who come to inspect the herds, the boys and girls learn to respect the importance of farm animals, and become deeply interested

*National Stockman and Farmer, August 10, 1918.

in their development. The future of our live-stock industry is dependent upon the active, intelligent interest of the young people of to-day who are to be the stockmen of to-morrow.

The methods of organizing community breeders' associations will vary according to conditions, but the process is not complicated or expensive. Five or six men may co-operate in a local-

ity, and agree to promote the breed they are handling, and help one another improve their herds and sell their surplus, with essentially no expense. They may not even have any written

a g r e e m e n t
among them-

selves. But, if many breeders co-operate, it may be a convenience to have constitution and by-laws, whereby they may fully understand just how they are related to each other. A common annual membership fee is one or two dollars, and an assessment is made for special advertising, for conducting a sale, or some similar purpose. In organizing it is customary to adopt a name, define the object of the association, provide for membership, establish dues, indicate the officers and their duties, making amendments, etc., as occasion demands. Special provisions may be made for holding periodical sales, etc. Through the extension department of the agricultural college in any of our states one should secure all necessary assistance in organizing a community breeding association.

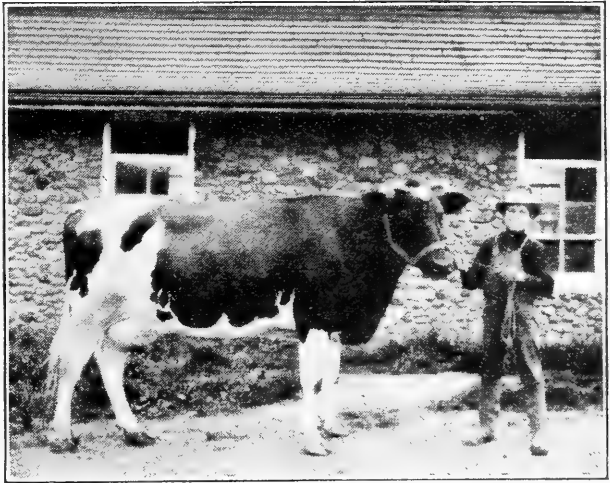

Figure 18.—“Community breeding encourages the young folks.” Photograph by the author.

CAN YOU ANSWER THESE QUESTIONS?

1. How did our breeds of live stock originate?
2. What important step took place in 1763 on Jersey Island?
3. When did community breeding first become established in America?
4. In what two localities in the United States and when did organized community breeding begin?
5. Who are doing most to improve our live-stock conditions?
6. Do you think one breed is better for a community than two? If so why?
7. What will overcome jealousy and suspicion among breeders?
8. What did Mr. Hayne see in Wisconsin?
9. How will community breeding influence young people on the farm?
10. To what extent is organization necessary in community breeding?

MAKE A COMMUNITY SURVEY, AND OBSERVE

11. To what extent are mongrels and grades bred.
12. If any community spirit in live-stock production prevails.
13. If any one breed is pre-eminent.
14. To what extent special advertising is attempted.
15. How much the young people interest themselves in live stock.
16. If buyers come in on account of superior opportunities for selection.

CHAPTER VII

THE COMPOSITION OF PLANTS AND ANIMALS

The plant as a source of food is of great interest to feeders of live stock. All our farm animals eat green plants with relish, just as a man enjoys celery. When plants are properly dried and cured as hay, their value for feed is not thereby affected. All our grains are products of plants; and from these directly, or indirectly by milling, we obtain some of our most valuable feeds for farm animals. So the facts are that the plant, in one form or another, really furnishes our horses, cattle, sheep, swine, and poultry with about all the food necessary for growth and production.

The material of which plants are made is taken from both soil and air, but largely from the soil. Like animals, plants must have food. Chemists say that all matter is composed of elements, about thirteen of which provide food for the plants. The names of some of these are common, such as iron, sulphur, and phosphorus. There are four others: carbon, hydrogen, oxygen, and nitrogen that are also important. Besides these, the plant needs potassium, calcium, sodium, magnesium, chlorine, and silica. Most of these elements are found in different combinations in the soil, more or less dissolved in the water. By means of its roots, the plant takes up the water and so carries this food through all its various parts. As this water or sap moves through the structure of the plant cells, the food in solution is used to promote growth. Carbon, oxygen, hydrogen, and nitrogen are gases in the air. The first two of these unite to form carbon dioxide, or carbonic acid gas, which the plant breathes in through the pores of the leaves. This gas in the plant goes through a change, and the oxygen is breathed out, and

the carbon is left to be made up into the solid part of the plant which serves as the more bulky material of food.

Nitrogen in the form of a compound is taken up by the plant through its roots; but plants of the legume group, such as the clovers, cowpeas or soy beans, aided by certain bacteria, have the power of using the nitrogen in the soil atmosphere. Nitrogen is a highly valued plant food, and the farmer often purchases it in fertilizer at a good price. These different elements unite with one or more others in the plant, and form combinations which are familiar to us under various names. Of these, the following are important when we come to consider the plant as food.

Water is a combination of hydrogen and oxygen. It is found in all plants, and even in very dry hay. To get the water entirely out of the plant, it must be driven out with artificial heat. The amount of water in plants differs greatly. Common timothy hay and red clover contain about 15 per cent, and ordinary corn meal has a similar amount. About 80 per cent of green pasture grass is water, and some of our roots, like the turnip, have 90 per cent. After the water is driven from the plant by heat, what is left is dry matter. The water in the plant is worth no more than any other water, its chief value being to carry food in solution through the plant from the root to the farthestmost leaf.

Ash, or mineral matter, of plants, we see, for example, in the ashes left from burned wood. When we burn a plant, we destroy its form, and all that which burns and disappears we call organic matter. That which is left is ash, or inorganic matter. There is much difference in the amount of ash in plants. Green or very young plants contain the least, and old ones the most. Common corn fodder contains about 3 per cent of ash, alfalfa about 10 per cent, and some of the roots as little as 1 per cent. The ash in plants is of value for food, if not too abundant. Hogs raised on feeds containing but little mineral matter, such as corn, for example, do

not have as good bone nor do they feed so well as when the corn is supplemented with other feeds containing more ash.

Protein in the plant is a combination in which nitrogen, especially, plays a very important part, and is combined with carbon, oxygen, hydrogen, and sulphur. There are different forms of protein, but we do not need to concern ourselves about that fact here. This substance is not usually abundant all through the plant. Rough stalks contain but little. Prairie grass hay has about 8 per cent, red clover hay 13 per cent, alfalfa hay 15 per cent, cottonseed 19 per cent, and soy beans 36 per cent. The growing plant usually has its greatest amount of protein when in bloom. Seeds are richest in this substance, for as the plant matures it shifts the protein to some extent from stalk to seed. In some of our mills where seeds are crushed or otherwise treated and the hulls removed, the by-products produced are very rich in protein. Cottonseed meal and peanut meal are good examples. Protein, whether used to feed plants or animals, is the highest priced food constituent the farmer can buy, when we consider the price he must pay on the market. Protein is expensive because it contains so much of the valuable element, nitrogen.

The carbohydrates are combinations of carbon, hydrogen, and oxygen, and contain no nitrogen. These are the most abundant of our food substances in plants. There are two kinds of carbohydrates, one known as nitrogen-free extract, consisting mostly of sugar, starch, and gums; the other called fiber or crude fiber, making up the woody part of the plant. Most of the fiber is cellulose, the material composing the walls of plant cells. The chemist may dissolve out the starch and the sugar from the plant cells; what is left is the fiber. The starch, sugar, and fiber are all carbohydrates, but the first two are much better for food, as they are very much more easily digested than the fiber. In general we see carbohydrates all about us in plants and plant products.

The most of the stalk of corn, or any growing plant, consists of carbohydrates. Common rice and potatoes are rich in this substance. Many of our hays contain from 60 to 70 per cent. This is, therefore, the cheapest as well as the most common constituent of animal feeds. Animals can not subsist on carbohydrates alone, although they are very valuable as a source of heat and energy. The farmer must depend largely, however, on materials rich in these substances to supply the great bulk of the feed for his stock.

The fat in the plant is composed of carbon, oxygen, and hydrogen in different combinations from which we find them in the carbohydrates. Fat, or ether extract, as it is also called, is not usually abundant in plants. One to 3 per cent is the usual amount with many plants. The seeds ordinarily contain the most, some of these like cottonseed, soy beans, and flax having large quantities, so that it is extracted for commercial purposes, and the by-product rich in protein is sold as cake or meal. Fat is of special value in the food, as it furnishes the animal both heat and energy.

The words roughage and concentrate are commonly used to-day by persons referring to feeding stuffs. When a farmer speaks of roughage, he means hay, corn fodder, or some coarse feed of that kind. By a concentrate, he means seeds that may be fed, or products made from them, such as bran, corn meal, oil meal, etc. Any form of feed for farm animals that does not contain a large amount of fiber, and is rich in protein or some form of nitrogen-free extract, such as starch as it occurs in the grain of rice, is usually regarded as a concentrate. Roots differ from roughages or concentrates in their general appearance, and, being succulent, contain a large amount of water, which often exceeds 90 per cent. Thus it may be seen they contain but little nutriment. On account of their composition in dry matter, and small amount of crude fiber, they are regarded by chemists as concentrates rather than roughages.

The following arrangement will show how the parts of the plant are related to one another:

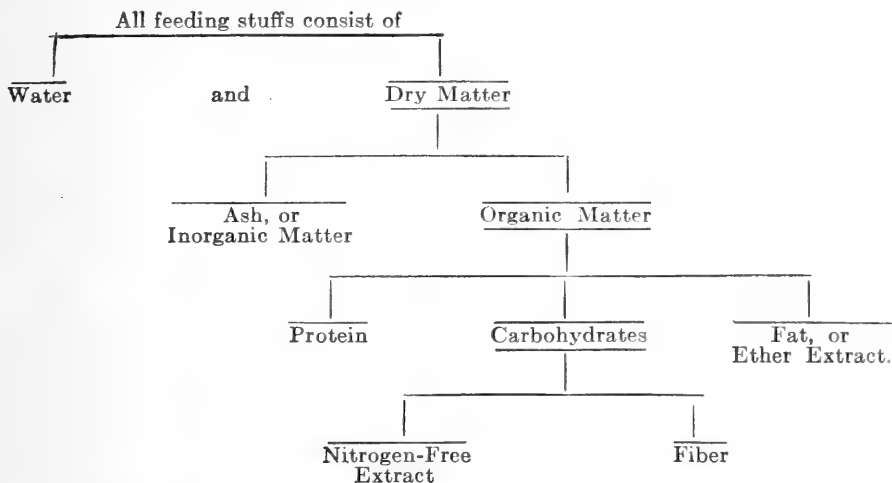

The material of which the animal is made is very similar to that used in building plant tissue. To begin with, the body of the animal is made up of water and dry matter. If the water is removed, dry matter is left. If this is burned entirely so that even the charcoal is destroyed, the organic part disappears and only ash is left. The organic matter, while made of chemical substances similar to those found in plants, consists mostly of protein and fat, with but little of the carbohydrates. The composition of the animal body may be well studied a little more in detail.

Water in the animal body is found in the blood, and in the fleshy and bony parts. The amount of water in the animal depends upon age and condition. Young animals have rather watery bodies. The older an animal becomes, or the fatter it gets, the less water is found in the body. For example, a calf a week old may consist of 60 per cent water, while a fat cow four years old may be but 45 per cent water. It will be fairly accurate to say that about 50 per cent of the body of an animal under usual conditions is water.

The mineral matter, or ash, in the animal is more or less

abundant, according to age and condition. Old animals always contain more than young ones, and those that are fat less than those that are lean. Usually we find a little over 3 pounds of ash for each 100 pounds of body weight. A fat, corn-fed hog, however, may be so short of ash in the body that the bone will hardly be strong enough to support its weight. The ash in the animal is made of the same substances as that found in plants.

The protein of the body is to be seen in the form of muscles, tendons, blood, nerves, the internal organs, hide, hair, horns, etc. Lean meat with no fat on it is protein, or nitrogenous material. The fatter the animal, the less the percentage of protein in the body. In the entire body of a farm animal under usual conditions we find about 13 or 14 per cent protein. In the dressed carcass, ready to be sold for meat, we find about 17 per cent.

The fat of the animal body is composed of carbon, hydrogen, and oxygen, or of the same chemical substances as the fat of plants, but differing in combination. The amount of fat in the body depends much on how an animal has been fed. If we take a young growing pig, the body may contain only 25 per cent of fat, or even less, but a hog that has been well fattened and is ready for the butcher may contain over 40 per cent. Not often do we find less than 6 per cent of fat in the body, or over 35 per cent. In the carcass ready for cutting up in the shop, we find about 20 per cent of fat, under usual conditions.

Carbohydrates in the animal body are but contained in it, not a part of it, and so this substance can not be regarded as a constituent of animal flesh. Carbohydrates, however, exist in the body in two forms; one, *glycogen*, similar to starch in composition, found in the liver and muscles; and the other, *lactose*, or the sugar of milk, found in milk. *Dextrose*, another form of sugar, is also found to a slight extent in the blood and tissues.

The vitamins. Within the past few years a new substance known as vitamins has received much attention from students of nutrition. Attention was first directed to this nutrient when it was shown that a disease of humans known as beriberi, caused by eating rice from which the husk had been removed, would not occur if the unpolished rice were eaten instead. Here was a new substance of nutrition. It was given the name of vitamin by Casimir Funk, who first investigated the subject. Other able scientists in America and Europe engaged in similar study, and it was finally agreed that there are three forms of vitamins, as follows:

(1) *Water-soluble vitamins*, widely distributed in vegetable foods, in germs of seeds, in vegetables and fresh fruits, but which seem to be quite lacking in polished rice, patent flour, and bolted corn meal;



Figure 19.—The effect of vitamins upon growth. The rat on the left was fed five per cent cottonseed oil, the one on the right one and one-half per cent of butter fat. Experiments by Dr. McCollum and others seem to show conclusively that there is no fat of plant origin that will take the place of butterfat in nutrition. Photograph from Wisconsin Experiment Station.

(2) *Fat-soluble vitamins*, found most abundant in milk, butter, egg yolk, germs of seeds, leafy vegetables and cod-liver oil, but lacking in the body fat or muscles of animals, and in vegetable oils; and

(3) *Anti-scorbutic vitamins*, that constituent of food which prevents the disease known as scurvy, especially found in oranges, lemons, potatoes and fresh fruits and vegetables. Cooking injures the vitamin value of this class of food.

The remarkable thing about the vitamins is, that they have never been actually separated out and isolated by themselves for study. Yet already a large amount of experimental feeding of human beings has clearly shown their existence and the important part they play in nutrition. Without question the vitamins influence the nutrition of farm animals. This fact has been brought out in feeding experiments on swine, notably by Prof. Evvard, of Iowa. In fact, we may assume that the vitamins in milk, green forage, and vegetables account in part for the great value credited to these substances by feeders of animals.

Comparing plants and animals, we see that the plant obtains its food from the air and from the mineral matter in the soil, from which it develops a form made up of cells that are largely carbohydrates. The farm animal obtains its nutriment from the plant, from which is created a form, also composed of cells, but, in this case, of nitrogenous material. During the day the plant sucks in carbon dioxide from the air through its leaves, and holds the carbon, and gives off the oxygen. The animal, on the contrary, draws the air into the lungs, uses the oxygen from it, and then breathes out carbon dioxide. Thus we see that these two great groups of living matter, the plants and animals, are of vital importance to each other, and have much in common. Without the plant or its products the animal under ordinary conditions could not live; while by feeding on it the beast converts the vegetable substance into a yet more concentrated and more valuable food material for men.

A part of this vegetable substance, however, is not taken up by the animal body; but, following a softening and reducing process, is excreted as manure. This excretion, placed in contact with the roots of the plant, furnishes nutriment and stimulates increased production. Thus the plant furnishes nourishment to both the animal and vegetable kingdom.

REAL FOUNDATION QUESTIONS

1. Name ten elements, tell where they occur and how taken up by plants.
2. How abundant and useful is water in the plant?
3. Discuss protein and its occurrence.
4. Name two kinds of carbohydrates.
5. Where in the plant is the fat most abundant?
6. What is a concentrate? Give three examples.
7. How much water is found in the animal body?
8. Of what use is the mineral matter in the animal?
9. What percentages of protein and fat are found in animals?
10. Where are the carbohydrates found in the animal?
11. What are the vitamins?

THINGS EASILY FOUND. LOOK FOR THEM

12. Specimens of elements.
13. Organic and inorganic matter.
14. Ashes of different kinds.
15. The protein of plants and also of animals.
16. Five kinds of fat.
17. Roughage and concentrates.

CHAPTER VIII

THE PROCESS OF DIGESTION

In order to understand how food is used in the body and the part it plays in maintaining life and producing results, it is necessary to discuss briefly the simpler features of digestion and more especially as applied to farm animals.

The process of digestion begins with the mouth, where the food is broken up and softened. The fluid called saliva flows from small glands at the base of the tongue, and the mixing of this with the food in the mouth is called insalivation. This fluid contains substances which act on the starch in the food and help change it to a form of sugar, so that it may be absorbed more readily. In swallowing, the food passes from the mouth through the esophagus, or gullet, into the stomach. The horse and hog have but one stomach, but cattle, sheep, and other animals that chew the cud, have four. The process of digestion, however, is similar in all stomachs. The cow chews a mouthful of grass very imperfectly at first and swallows it into the paunch, which is the largest of the four stomachs. From here, after more or less mixing, the food is forced into a second and smaller stomach, called the honeycomb. After it has been churned about and softened in these two stomachs, the animal forces back into the mouth as frequently as desired a small amount of food called the "cud," for further chewing. The cattleman calls this operation "chewing the cud." After a bit the cud is returned, and by a special movement, passes into the manyplies, or small third stomach, from which it passes on into the fourth, or true, stomach. While in the true stomach the food is churned about and mixed with gastric juice, which contains a little acid. These juices act on the food, dissolv-

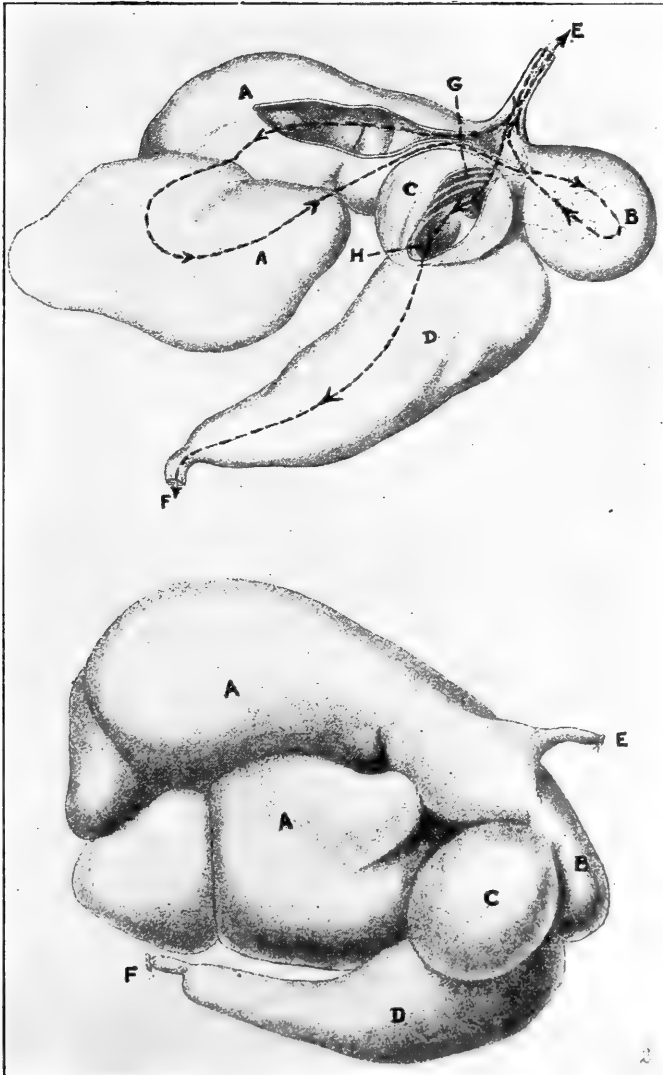

Figure 20.—The stomach of the ox. The lower figure shows (a) the rumen, (b) the reticulum; (c) the omasum, and (d) the abomasum, or true stomach. The upper figure shows by the dotted lines the direction of movement through the four sections. Reproduced from "Cattle and their Diseases," published by the U. S. Dept. of Agriculture.

ing and changing it so that it can pass through the walls of the digestive tract and be used in the body. From the stomach, by a peculiar wave-like motion, the food is forced at frequent intervals into the small intestines, where it is mixed with other fluids that aid digestion. The liver, which is the largest gland in the body, and the pancreas both pour fluids that aid digestion over the food as it moves along the way in the small intestine.

Thus it will be seen that from the time it is taken into the mouth the food is constantly acted on and changed for use in the body. Most of the food digested is absorbed from the small intestine but some passes on into the large one, where the last changes take place. During this trip in the body the protein, carbohydrates, and fat are changed into different smaller and simpler particles. When ready to be absorbed, they are taken into the circulation by the blood and lymph, and carried all through the body. Left in the cells, these particles of protein, etc., which are called *nutrients*, serve their final purpose of building up the body or producing milk or energy. This process of digestion and absorption is rather complicated, and includes many changes that need not be mentioned here.

The capacity of stomach and intestines is much greater than many persons realize. Careful study has been made of these organs of farm animals, and the following figures may be regarded as fairly accurate:

COMBINED CAPACITY OF STOMACH AND INTESTINES.

The ox.....	337 quarts, or about 2 barrels
The horse.....	224 quarts, or over 1 barrel
The sheep.....	47 quarts, or about 12 gallons
The hog.....	29 quarts, or about 7 gallons

It is to be noticed that the ox, with its compound stomach, has almost twice the capacity of the horse, and the sheep, in proportion to size, has much more capacity than the hog. The intestines of the ox are about 187 feet long, while those of the horse are but 98, and those of the sheep are 107 feet

long, compared with 77 feet in the hog. The facts brought out in these figures show that the horse and hog, with their simple stomachs, and smaller relative capacity, should be fed more concentrated, or more easily digested, food than the ox or the sheep.

The food in the body is used to maintain or support life, to produce growth or energy or to promote certain other features, as milk, fat, or wool. On this account persons who feed live stock should regulate the kind and amount of food, if they desire to secure the most satisfactory results.

The protein in the food during digestion is acted on by what are called digestive ferments. One of these, *pepsin*, assisted by a very small amount of *hydrochloric acid* attacks the protein in the stomach. The action of acid and pepsin changes the protein into two more soluble forms known as *proteoses* and *peptones*. These with any of the unchanged protein pass into the small intestine, where, by the aid of two other ferments, *trypsin* and *erepsin*, all is converted into a still more soluble form called *amino acid*. This latter passes through the walls of the intestines and into the blood, and thence throughout the body tissues. The animal can not take the protein in the plant and use it at once as body protein, but it must go through these changes in the digestive organs before it can be used. The protein in the food is changed to body protein, of which lean meat is the best example. To some extent it may also be changed into fat. Animals that depend entirely upon flesh for food can live on protein alone, if necessary. During starvation, the body loses a small but rather constant amount of protein. So we regard this substance especially valuable for building up the muscles, the hair, wool, internal organs, blood, and similar tissues that are closely related to the vital processes.

The carbohydrates in the food are largely changed into sugar during digestion. Thus they are more easily absorbed into the body. There are different kinds of sugars, but that

in the food is converted into *glucose*. This sugar is then taken up by the circulation and carried to the liver, where it is again changed somewhat, and from here is distributed over the body as needed. The carbohydrates are largely used in the system to furnish the energy necessary in work, and to make fat. Interesting experiments with animals show that more fat is stored in the body than can be supplied by the protein and fat in the food. Dr. W. H. Jordan, of the New York Experiment Station, proved that carbohydrates are used to form part of the fat in the milk of the cow. If animals are fed enough foods rich in digestible carbohydrates, the fat in the body will not tend to diminish in amount. In other words, such foods protect or conserve the body fat. The carbohydrates are also regarded as great sources of heat and energy. This phase of the subject will be explained a little further on. Feeds containing plenty of carbohydrates cost less for the dry matter in them than any other feeds, and are valuable for filling the stomach. Sheep and oxen must be fed a quantity of roughage, as a filler, if they are to do well.

The fat in the food undergoes no important change in the stomach, but in the small intestine, through action of the *bile* poured in from the liver, and the pancreatic juice, it is converted into *glycerine* and *fatty acids*. The alkali in the bile unites with the latter, forming a soap. In this changed form of glycerine and soap, the fat finds its way through the intestinal wall into very minute projections, known as *villi*, through which it enters into the *lacteals* and thence on as a milky fluid known as *chyle* into the blood circulation near the shoulder. In this changed form the fat of the food becomes a part of the body fat. The fat of the body is usually made from the fat and the carbohydrates of the feed, though it may be produced to a small extent from protein. There is usually but little fat in the roughages fed to stock

The mineral matter in the food is taken up in the small

intestine, and goes through no special digestive changes as with the other food substances. Mineral substances, such as lime and phosphorus, are regarded as of great importance in building up the body. Those foods that contain but little ash give poor results in feeding, unless the necessary mineral material is supplied. Years ago Professor W. A. Henry showed that hogs fed only corn had bone just about half as strong as hogs fed bone meal or hard-wood ashes with the corn. Farmers give ashes or coal to hogs because these animals make a better development when so fed. Without the ash, the body is not given proper nutrition. Corn lacks ash.

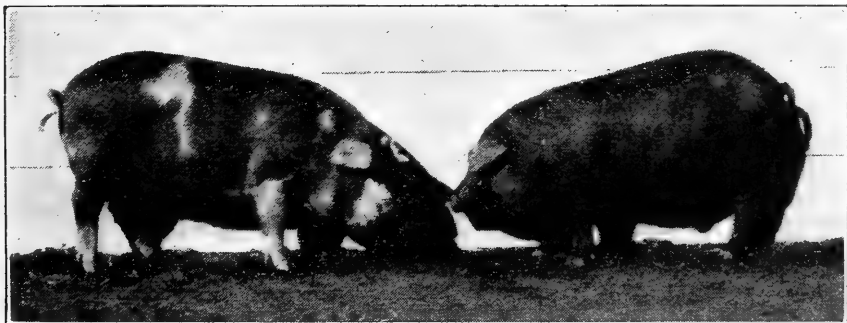

Figure 21.—The influence of minerals on the development of swine. The pig on the left received a ration with sufficient minerals, the other was given a ration deficient in minerals. Note the difference in bone and growth. Photograph from Iowa Experiment Station.

A hundred pounds of corn meal contains but a pound and a half of ash, while a hundred pounds of oats has more than twice that amount. All stockmen rate oats highly for producing hard, strong bone in growing animals. The legumes, such as clover and alfalfa, supply much needed mineral material in the food of farm animals and so their use should be generally advised, especially for cattle, sheep and swine.

All food has a heat value, just as coal has. If burned, coal gives off heat; so does food. All heat comes from the sun, and is stored up in the plant, ready to be set free. The word *calorie* represents a measure of heat given off by food. One calorie equals the amount of heat required to

raise the temperature of 1 pound of water 4° F. The word *therm* is now being adopted as more convenient for use in referring to stock feeding. A therm equals 1,000 calories. If we raise 1,000 pounds of water 4° F, that measures a therm. While food is being digested in the body, heat is produced by the process. Some foods contain more heat than others. The difference will depend largely on the amount of fat contained. Scientific men consider that the heat values of protein and carbohydrates are about alike, but that the heat value of fat is $2\frac{1}{4}$ times as great as either of these. This fact partly explains why the Eskimos in the cold North eat so much food that is nearly all fat, as the blubber of the whale. Corn contains more fat than any of our other common grains, which fact accounts in part for its use as a winter feed for horses, and also is a reason why it should not be fed heavily to stock in summer in the warm season.

Food has an energy value. When a substance is burned, the resulting energy furnishes power to do work. So it is understood that what we call a therm represents the energy or work necessary to raise 1,530 tons to a height of one foot. Part of the energy of the food, to be sure, is lost in the process of digestion, partly because not all the food is digested. But much of it is saved, and this is used to keep the engine of the body going. The horse that pulls the plow or hauls a load of hay gets his power from the stored-up energy in the food, which is set free in the body during oxidation in the process of digestion.

The heat and energy value of food has been worked out by scientific men, by means of a *calorimeter*. This is a very strong, round, hollow steel tube. A sample of a food is placed in this and burned, and the amount of heat given off is measured. Another instrument, called the *respiration calorimeter*, also is used, in which a live animal is placed. With this the investigator can study the value of foods, and can make a complete record of just what becomes of all

the energy produced. By means of the calorimeter, one measures the heat or energy used in labor, or thrown off from the body, or passed off as breath through the mouth. The application of this knowledge will be found in the next chapter. At the Pennsylvania and New Hampshire Experiment Stations there are respiration calorimeters made to hold the larger animals. In these there have been conducted very interesting experiments on the energy value of foods as fed to cattle under different conditions.

The palatability, or taste, of food is regarded very important in feeding animals. If the food is pleasing to the taste, the animal will digest it better, because the fluids used in digestion will flow more freely, and thus act more completely on the food. Nice sweet hay is greatly relished, while that which is somewhat mouldy, or has not been properly ripened, or cured, will be poorly eaten or entirely refused. The animal that feeds best has a good appetite, and eats plentifully. A great Russian physiologist named Pawlow, who conducted extensive experiments relating to the effects of the appetite on the forming of the digestive fluids in dogs, learned that digestion, appetite, and palatability all go together.

The use of water by the animal is very important. Water may keep the entire body in a healthy condition. The digestive fluids and blood need given amounts of water to do their work right, and water is needed to keep the intestines open and active, and to regulate body temperature. Experiments have shown that farm animals need a certain amount of water for every pound of dry matter eaten. For example, a horse or sheep needs from two to three pounds of water for each pound of dry matter consumed. With some foods more water is required than with others. The cow that eats corn silage will drink but little water compared with the one fed the dried plant or corn stover.

The nutritive ratio is frequently referred to in discussing the use of rations in practical feeding. This term is used to

express the ratio of the digestible protein to the digestible non-protein substances in the food, or the combined carbohydrates and fat to the protein. In order to compare these substances on an equal basis, they are reduced to the same heat valuation. Protein and the carbohydrates do have the same heat value, but a pound of fat is equivalent to about $2\frac{1}{4}$ pounds of either one of these. Consequently the chemist, in order to place them on an equal footing in heat value, multiplies the digestible fat by $2\frac{1}{4}$. The nutritive ratio is found by adding this to the amount of the carbohydrates, and then dividing the sum by the digestible protein content. The following example will illustrate the method of finding the nutritive ratio:

Oats contain 10.7 pounds of digestible protein, 50.3 pounds carbohydrates and 3.8 pounds fat. Then the ratio is worked out in this manner. $3.8 \text{ pounds fat} \times 2\frac{1}{4} = 8.55 = \text{the carbohydrate equivalent of the fat.}$

$$\begin{array}{r}
 50.3 + 8.55 = 58.85 \\
 10.7 \overline{) 58.85} \quad (5.5 \\
 \underline{53.5} \\
 535 \\
 \underline{535}
 \end{array}$$

Nutritive ratio, 1:5.5

The nutritive ratio is obtained in the same way for an entire ration, dividing the total amount of the digestible carbohydrates and fat by the total digestible protein. A nutritive ratio of 1:5.5 means that for each pound of digestible protein to be found in the ration there are 5.5 pounds of carbohydrates or its equivalent.

A *narrow* nutritive ratio is one in which the amount of carbohydrates and fat is not large in proportion to protein, such as 1:3, or 1:5; a moderate amount would be 1:8; while a *wide* ratio would be 1:12. Highly concentrated foods, such as tankage or oil meal, usually have narrow ratios; while coarse foods, like the common roughages, of which corn stover or timothy hay are good examples, have wide ratios.

DIGEST THESE QUESTIONS

1. What is meant by "chewing the cud?"
2. How is food taken into the circulation?
3. What is the capacity of the stomach of the ox?
4. What digestive fluids are present in the stomach?
5. How are the carbohydrates changed in digestion?
6. What is a "calorie"? a "therm"?
7. How can the energy value of food be shown?
8. Describe the calorimeter.
9. What has palatability of food to do with digestion?
10. Explain the term "nutritive ratio."

TAKE NOTE OF THESE THINGS

11. How often does a cow chew the cud? Watch to see.
12. If an opportunity occurs, measure the intestines of an animal that may be killed on the farm. Report.
13. Get samples of what you consider palatable and unpalatable foods for stock.
14. Figure out the nutritive ratio of three plants or other feed materials.

CHAPTER IX

FEEDING STANDARDS: THEIR ORIGIN AND USE

The process of analyzing a feeding stuff takes place in chemical laboratories especially equipped for this work. The chemist secures a fair sample of the feed and grinds it in a mill to a powder as fine as flour. He then takes a small sample of this and analyzes it in the laboratory. He dries a weighed portion in an oven and finds just how much water it contains, and the percentage of dry matter. Then with ether he dissolves out the fat, (ether extract) and weighs this. With other chemicals he also separates out the protein, the nitrogen-free extract, and the fiber. Another sample of the feed he burns to learn how much ash or mineral matter remains. Thus the chemist is able to determine just how many pounds of each of these substances there are in a given amount of feed. This investigation of the chemical composition is the first step taken by the chemist in studying the value of foods for animals.

The amount of digestible nutrients in a food, the simple chemical analysis, however, did not show. Then there was another step forward by the chemist, whereby he learned just how much of the total protein, carbohydrates, and fat in a given food an animal digested. After analyzing a sample of the feed, as much of it was fed as the animal would eat in a given time. During the experiment, all the solid and liquid excrement passed off by the animal was collected, and samples of these were also analyzed. Having learned how much protein, carbohydrates, and fat were lost in the manure, the chemist deducted these amounts from the total quantity consumed in the feed, and the difference was regarded as the amount digested by the animal. This method was not per-

fect, but it was a great step in advance. It enabled chemists to figure out the amount of each nutrient digested under different conditions, so that in time they were able to prepare for the use of farmers what is called "a table of digestible nutrients." This table showed the total amount of dry matter in 100 pounds of different kinds of feed, and also the number of pounds of digestible protein, carbohydrates, and fat in every 100 pounds. In this table, for convenient reference, foods of similar sorts are grouped by themselves. For example, roughage is all classed together, and this is divided into three groups: as dried roughage, fresh green roughage, and roots and tubers. Then the concentrates are arranged by themselves, and these are also divided into groups. The following is taken from a table of digestible nutrients, and is used here to illustrate what has just been explained. No attempt, however, is made below to group these feeds.

Name of feed	Total dry matter in 100 lbs.	Digestible nutrients in 100 lbs.			Nutritive ratio
		Protein	Carbohydrates	Fat	
Alfalfa hay	91.4	10.6	39.0	0.9	1:3.9
Timothy hay	88.4	3.	42.8	1.2	1:15.2
Lespedeza hay	88.2	8.6	41.1	1.1	1:7.6
Cowpea hay	90.3	13.1	33.7	1.0	1:2.7
Corn stover, medium ⁱⁿ water	81.0	2.1	42.4	0.7	1:21.0
Red clover-green	26.2	2.7	13.0	0.6	1:5.3
Rape-green	16.7	2.6	10.0	0.3	1:4.1
Corn silage	26.3	1.1	15.0	0.7	1:15.1
Corn, dent	89.5	7.5	67.8	4.6	1:10.4
Oats	90.8	9.7	52.1	3.8	1:6.3
Wheat bran	89.9	12.5	41.6	3.0	1:3.9
Cottonseed meal-good	92.1	31.6	25.6	7.8	1:1.4
Linseed meal o. p. . . .	90.9	30.2	32.6	6.7	1:1.6
Tankage-Over 60% protein	92.6	58.7	12.6	1:0.5
Skim milk-separator . .	9.9	3.6	5.1	0.2	1:1.5

This little table, which is made from a much longer one giving the digestible nutrients in about all the different kinds of food the American farmer is likely to feed,* shows that 100 pounds of alfalfa hay contains 91.4 pounds of dry matter.

*Feeds and Feeding. Henry and Morrison, 1917.

In this 91.4 pounds, of the digestible material of use to an animal, we find 10.6 pounds of protein, 39 pounds of carbohydrates, and nine tenths of a pound of fat. The nutritive ratio is also 1:3.9. Let us now look further and learn how such figures have a practical value to the feeder of animals.

The kind and amount of food required by an animal very naturally depend on the class to which it belongs, its age, and use. No one would expect to feed a calf the same as a horse, or a sheep like a milch cow. Each must be fed so as to supply its needs as completely as possible. As might be expected, scientists were a long time getting the necessary information to enable men to understand how to feed so as to get the best results.

What we know as feeding standards in the beginning were very simple and did not have any real value. The working out of useful standards began in Germany, and German chemists have done more than any one else to furnish us knowledge on this subject. The first plan attempted was to give meadow hay a fixed value, and then measure up other feeds with that as the standard. That plan originated about 1810. Some fifty years later, another German chemist suggested that animals be fed special amounts of protein, carbohydrates, and fat, according to certain conditions. His plan was not good, however, because he did not take into account the digestibility of the food. He was able to analyze a food, but he knew nothing of how much of each nutrient the animal digested. At that time there was considerable information of the chemical composition of feeding stuffs, but the digestibility of the foods had not been figured out. Then about 1864, another German chemist, by the name of Wolff, proposed that animals be fed daily certain amounts of digestible protein, carbohydrates, and fat, such as were actually required by the animals. Wolff was able to make this proposal because he had conducted many feeding tests with different animals, and had learned much of the digestibility

of feeds. His studies resulted in what are now known as

The Wolff feeding standards for farm animals. Two things were shown by this great scientist. One was the digestibility of the nutrients in different feeding stuffs, and the other was the amount of each of these required by farm animals under certain conditions. Wolff found that animals that were doing no labor, that were not being fattened, neither gaining nor losing in weight, required only sufficient food to keep the body and the internal organs healthy and vigorous. Such an animal required what he called a *maintenance ration*. A young animal needed a growing ration, and cattle intended for meat required a fattening ration. A cow producing a large amount of milk must be fed, first to supply the ordinary needs of the body, such as might be found in a maintenance ration, and, besides this, she must be fed still more to enable her to produce the milk of which the food is the source. The dry cow may be satisfied on a maintenance ration consisting of some form of roughage only, such as clover hay, for example; but, if she is yielding a good supply of milk, then rich concentrates must be fed, if the increased demands of milk production are to be met.

The standards of Wolff were not entirely satisfactory to the Germans, so in 1896 Dr. Lehmann, of the Berlin Agricultural High School, introduced some improvements which became known as the Wolff-Lehmann Feeding Standards.

Since Wolff first made known this most important discovery, many other chemists have experimented in the same field. Both European and American agricultural chemists have extensively studied the science of feeding, so that now we know much more than did the student or farmer in the days of Wolff. Animals have been carefully studied, and the invention of the respiration calorimeter has resulted in some wonderful investigations in the fields of chemistry and animal nutrition. The work of Wolff was that of a pioneer. For many years Americans relied on analyses of German

feeds, and made use of the standards that came to us from Europe. To-day we are able to use a table of digestible nutrients which is based on the composition of American feeds as studied by chemists of our own country. The Wolff standards as improved by Lehmann were introduced to America and for some years had extensive use. Wolff used 1,000 pounds as the standard of weight for animals, and assumed that a certain amount of dry matter, and of digestible protein, carbohydrates, and fat, were needed for that weight under given conditions. The animals were classified in groups, as oxen, fattening cattle, milch cows, sheep, horses, etc. Then those in a group were classified according to their purpose; as, for example, horses into light, medium, and heavy work; and dairy cows in four classes, according to the amount of milk made per day. The following figures, taken from the Wolff-Lehmann feeding standard, illustrate its arrangement:

Pounds required daily for each 1,000 lbs. live weight.

Kind of animal	Dry matter	Digestible nutrients			Nutritive ratio
		Protein	Carbohydrates	Fat	
Horses, light work. . . .	20	1.5	9.5	0.4	1:7.0
Horses, medium work.	24	2.0	11.0	0.6	1:6.2
Horses, heavy work. . .	26	2.5	13.3	0.8	1:6.0

This table means, for instance, that a horse at light work weighing 1,000 pounds requires 20 pounds of dry matter daily, containing $1\frac{1}{2}$ pound of protein, $9\frac{1}{2}$ pounds of carbohydrates, and 0.4 pound of fat, the ration having a nutritive ratio of 1:7. These exact standards of daily requirements did not stand the test in American feeding operations, and our scientists sought to improve them. As a result of the studies of Professors W. A. Henry and F. B. Morrison, of Wisconsin University, new standards were introduced.

Modified Wolff-Lehmann standards. These investigators recognized "that feeding standards are but approxima-

tions," or, in other words, it is impossible to feed an animal in common practice to the exact fraction of a pound, and give neither too little nor too much food for body requirements. So they adopted the plan of feeding within minimum and maximum quantities of dry matter, digestible crude protein and total digestible nutrients. In explanation of their modified form of the Wolff-Lehmann standards, the authors write as follows:*

"Since progressive feeders throughout the country now appreciate the significance of the nutritive ratio of a ration, the approximate upper and lower advisable limits of nutritive ratios for the different classes have been stated. To correspond with these standards, Appendix Table III contains a column showing the total digestible nutrients furnished in 100 pounds of each feed. Likewise so that one may see at a glance what feeds are high and which are low in protein, compared with carbohydrates and fat, the nutritive ratio for each food has been computed and given in the table. With these aids it is hoped that the standards presented may be of real assistance to students and feeders who desire to compute rations substantially in accordance with the Wolff-Lehmann method, while recognizing the results of later investigations in animal feeding."

The modified form of the Wolff-Lehmann standard, as applied to horses, compared with the table previously given in this chapter, is as follows:

Feeding standards for horses, 1,000 lbs. live weight, modified Wolff-Lehmann.

Kind of work	Dry matter per day	Digestible crude protein	Total digestible nutrients	Nutritive ratio
Light.....	15-22 lbs.	1.1-1.4 lbs.	10.0-13.1 lbs.	1:8.0-8.5
Medium.....	16-24 lbs.	1.4-1.7 lbs.	12.8-15.6 lbs.	1:7.8-8.3
Heavy.....	18-26 lbs.	2.0-2.2 lbs.	15.9-19.5 lbs.	1:7.0-8.0

By this we learn that a horse at medium work requires from 16 to 24 pounds of dry matter, from 1.4 to 1.7 pounds of protein, and from 12.8 to 15.6 pounds of digestible nutrients, with a nutritive ratio of 7.8 to 8.3. Compared with the old standards, we see that this ration provides a saving in protein, but allows for an increased use of total nutrients, with a somewhat wider nutritive ratio.

The practical application of Wolff-Lehmann feeding standards has been recognized on thousands of farms in America,

*Feeds and Feeding, 1917.

and to the great profit of those adopting them. Probably no class of people has studied the standard more carefully than feeders of dairy cattle, and it is among herds of this kind that we find Wolff-Lehmann standards most commonly used. It must be understood that one may not be able to feed one's stock so as to follow the standard perfectly, but there is no trouble in using it in a practical way as a guide. One may without difficulty feed within the limitations of the standard. When the animal is fed about right, according to the standard, then a *balanced ration* is being used, or one which, without waste, most perfectly meets the needs of the body. Many experiments have shown that the balanced ration can be relied upon for giving the best results.

Energy value feeding standards have recently attracted attention. Kellner, a German, and Dr. H. P. Armsby, a noted American investigator of feeding animals, about 1908 proposed that the feeding value of foods be measured by their energy contents, as shown by the therms of net energy they supply. These men accounted for the loss of a part of the food energy by the animal in the mastication of its food, and in the operations of the internal organs, etc. The energy left after digestion they called the *net energy* and this was used by the animal for supplying special needs. Armsby has published a set of figures showing the dry matter, digestible protein, and net energy value in therms in some of the most common feeding stuffs. He has also prepared a maintenance ration standard, and one for growing cattle and sheep. The following is made up from the latter, to show how this energy standard is arranged.

CATTLE

<i>Age</i>	<i>Live weight</i>	<i>Digestible protein</i>	<i>Net energy value</i>
3 mos.	275 lbs.	1.10 lb.	5.0 therms
12 mos.	650 lbs.	1.65 lb.	7.0 therms
24 mos.	1000 lbs.	1.75 lb.	8.0 therms

This table shows that a calf three months old and weighing about 275 pounds requires 1.1 pound of digestible pro-

tein per day, and that the total net energy in the ration will equal five therms. This new standard has hardly been long enough before the public to be well known, and has been used but little in practice but may grow in favor.

Feeding standards for dairy cows have received quite a large amount of special study, especially by Professors T. L. Haecker, of Minnesota Experiment Station, F. W. Woll, first of Wisconsin and later of the California station, G. C. Humphrey, of Wisconsin station, E. S. Savage, of Cornell University station in New York, and C. H. Eckles, of Missouri and Minnesota stations. Professor Haecker was the pioneer in this work, and, after many years of careful feeding of dairy cows, he concluded that the feed for a cow producing milk should be based not only on the daily yield of milk, but also on the amount of butter-fat the milk contained.

The Haecker standard for dairy cows first assumes that with a standard weight of 1,000 pounds, the cow independent of milk production requires a maintenance ration of 0.7 pound of crude protein, 7.0 pounds of carbohydrates and 0.1 pound of fat. Then for each 100 pounds live weight the cow exceeds or falls below 1,000 pounds, there is added or subtracted one tenth of the standard ration. The following is a part of the Haecker standard, given simply for illustration.

Haecker's Feeding Standard for a Dairy Cow.

Conditions for support or production	Daily allowance of digestible nutrients.		
	Crude protein	Carbohydrates	Fat
Support for 1,000 pound cow . . .	0.700 lb.	7.00 lbs.	0.100 lb.
<i>To the allowance for support</i>			
<i>add:</i>			
For each pound 3.0 per cent milk .	0.047 "	0.20 "	0.017 "
" " " 4.0 " " "	0.054 "	0.24 "	0.021 "
" " " 5.0 " " "	0.060 "	0.28 "	0.024 "

Prof. Savage has sought to improve this ration somewhat, by increasing the protein requirements per pound of

milk from 18 to 20 per cent, for in his experiments he found a need for this increased protein over that adopted by Haecker. American standards, and especially those applied to milk production, are a great step in advance over the standards introduced from Germany.

QUESTIONS ON KNOTTY THINGS

1. How does a chemist analyze a feeding stuff?
2. What is meant by digestible nutrients?
3. How are feeding tables arranged?
4. Trace the history of the feeding standards.
5. Explain meaning of a maintenance ration.
6. What standard of weight is used in feeding tables? Suppose an animal weighs more or less?
7. Discuss the practical use of Wolff-Lehmann standards.
8. What are the energy value feeding standards?
9. How does the Haecker standard for dairy cows differ from the Wolff-Lehmann?
10. How did Savage try to improve the Haecker standard?

CHAPTER X

CALCULATING FEEDING RATIONS

The selection of a feeding standard is the first thing necessary, when one plans to feed live stock on a scientific basis. The reader's attention has been called to several different standards, each of which has certain commendable features. The modified Wolff-Lehmann standard, however, is the one in most general use for horses, beef cattle, sheep and swine, and, in view of its simple application, is here recommended. For dairy cattle the Haecker standard as modified by Savage is especially good, and may be easily applied to a wide range of production.

The method of calculating a ration is very simple, and can easily be put in practice by anyone who knows how to add, multiply, and subtract. There is nothing complicated about it. The fact that many farmers with only common school training figure out the rations for their stock, is evidence enough to support this statement. Many men feeding dairy cows study carefully the composition and cost of feeds, and then figure out the best rations available, that will agree as nearly as possible with the standard.

THE MODIFIED WOLFF-LEHMANN STANDARD

The first step in calculating a ration is to find out the amounts of dry matter, digestible protein, total digestible nutrients, and the nutritive ratio in the ration one is feeding or is planning to feed. In this chapter, only the most common feeds used over much of the United States will be considered. We will go through the process of figuring out the ration for fattening a two-year-old steer weighing 1,200 pounds, during the first period of 50 to 60 days. (See feeding standard, Table B, Appendix.) According to the stand-

ard, a steer weighing 1,000 pounds would require from 22.0 to 25.0 pounds of dry matter, 2.0 to 2.3 pounds of protein, 18.0 to 20.0 pounds of digestible nutrients, and with a nutritive ratio of 1:7.0 to 1:7.8. Multiplying these requirements for 1,000 by 1.2, in order to determine the amount needed for the 1,200-pound steer, we find that he will require 26.4 to 30.0 pounds of dry matter, 2.4 to 2.76 pounds of protein, and 21.6 to 24.0 pounds of digestible nutrients. Let us plan to feed this steer a daily ration of 10 pounds of alfalfa hay, 30 pounds of corn silage, 10 pounds of corn and cob meal, and 3 pounds of bran. To use a good system in the starting of the work, we will arrange the different parts in proper order for study, which is as follows:

Ration for 1,200-pound Fattening Steer—First Period

Feeds.	Dry matter	Digestible protein	Total digestible nutrients	Nutritive ratio
Alfalfa hay, 10 lbs.....				
Corn silage, 30 lbs.....				
Corn and cob meal, 10 lbs.				
Bran, 3 lbs.....				

The second step in calculating the ration will be to find out how much dry matter, digestible protein, and total digestible nutrients, occur in each of the amounts of these different feeds, and write these figures in the proper blank places in the table. Turning now to Table A in the Appendix, you will find shown the amount of dry matter and digestible nutrients in 100 pounds of a number of different feeding stuffs. The composition of each to be fed this steer can be easily found. Let us take alfalfa hay for our first calculation.

ALFALFA HAY

	<i>Dry matter</i>	<i>Protein</i>	<i>Total nutrients</i>
100 lbs. contain	91.4 lbs.	10.6 lbs.	51.6 lbs.
Then 10 lbs. contain	9.14 lbs.	1.06 lbs.	5.16 lbs.

Figuring the *corn silage* next, we find that

		<i>Dry matter</i>	<i>Protein</i>	<i>Total nutrients</i>
	100 lbs. contain	26.3 lbs.	1.1 lb.	17.7 lbs.
Then	30 lbs. contain	7.89 lbs.	0.33 lb.	5.31 lbs.

Figuring the *Corn and cob meal* next, we find that

		<i>Dry matter</i>	<i>Protein</i>	<i>Total nutrients</i>
	100 lbs. contain	89.6 lbs.	6.1 lbs.	78.1 lbs.
Then	10 lbs. contain	8.96 lbs.	0.61 lb.	7.81 lb.

Coming last to *bran*, we learn that

		<i>Dry matter</i>	<i>Protein</i>	<i>Total nutrients</i>
	100 lbs. contain	89.9 lbs.	12.5 lbs.	60.9 lbs.
Then	3 lbs. contain	2.70 lbs.	0.37 lb.	1.82 lbs.

If we have copied these figures as worked out, into the blank places arranged for them in the table on page 94, then we shall have the following, after we have added up the totals.

Ration for 1,200-pound Fattening Steer—Partly Computed

Feeds	Dry matter	Digestible protein	Total digestible nutrients	Nutritive ratio
Alfalfa hay, 10 lbs.....	9.14 lbs.	1.06 lbs.	5.16 lbs.	
Corn silage, 30 lbs.....	7.89 "	0.33 "	5.31 "	
Corn and cob meal, 10 lbs..	8.96 "	0.61 "	7.81 "	
Bran, 3 lbs.....	2.70 "	0.37 "	1.82 "	
Total.....	28.69 "	2.37 "	20.10 "	1:8.5
Wolff-Lehmann standard..	26.4-30 "	2.4-2.76 "	21.6-24 "	1:7-1:7.8
A shortage of . . .		0.03-0.39"	1.5-3.9 "	

The above table shows that the proposed ration, compared with the standard, is satisfactory in the amount of dry matter, but is from 0.03 to 0.39 lb. short in digestible protein, and lacks from 1.5 to 3.9 pounds of total digestible nutrients, with a slightly wider nutritive ratio than the standard calls for.

The third step in computing the ration will be to correct or improve it so that it will compare favorably with the standard. Not much is really necessary to improve this ration, for the dry matter already supplied is properly adjusted, and there is but a small shortage in digestible protein. We should, however, have at least a pound and a half

more digestible nutrients, and make the nutritive ratio correspond closer to the standard. We might use a small amount of some commercial feed stuff, to adjust this ration, but suppose we use a common home-grown product, and add three pounds of oats and note the result. Turning to the table of the composition of feeding stuffs, Table A, Appendix, we find the following relating to oats.

	<i>Oats</i>	<i>Dry matter</i>	<i>Digestible protein</i>	<i>Total digestible nutrients</i>
	100 lbs. contain	90.3 lbs.	9.7 lbs.	70.4 lbs.
Then	3 lbs. contain	2.72 lbs.	.29 lbs.	2.11 lbs.

Adding this to the total in the original ration, we have the following:

	Dry matter	Digestible protein	Total dig. nutrients	Nutritive ratio
Total original.....	28.69 lbs.	2.37 lbs.	20.10 lbs.	1:8.5
3 lbs. oats.....	2.72 "	.29 "	2.11 "	
Total.....	31.41 "	2.66 "	22.21 "	1:8
Standard.....	26.4-30 "	2.4-2.76 "	21.6-24 "	1:7.1-7.8
Excess or deficit.....	+1.41 "	Balanced	Balanced	

This ration contains a slight excess of dry matter which is not at all serious, while it is actually balanced in its nutrients, and very nearly meets the nutritive ratio standard. We may, therefore, regard this ration properly calculated and corrected to suit the animal's needs. It also has the advantage of consisting of feeds easily produced or obtained over much of this country.

COMPUTING STANDARDS FOR DAIRY CATTLE

The feeding standards for dairy cattle as previously stated, are based on the yield of milk as well as the weight of the animal. Haecker adopted a standard in which he first established a maintenance ration for the support of a 1,000-pound cow, consisting of 0.7 pound digestible protein, 7.0 pounds digestible carbohydrates and 0.1 pound digestible

fat. He then allowed certain amounts of these nutrients in the ration, additional to that for maintenance, based on each pound of milk of definite butter-fat composition. The standard proposed by Haecker was a great step forward, but some investigators after extensive trials came to the conclusion that the nutrients recommended fell a trifle short of real requirements. Haecker's table was changed slightly by Savage, who approved of the maintenance standard, but who increased the percentage of protein required, from 18 to 20 per cent. Savage also combined the total nutrients, instead of computing carbohydrates and fat separately. In their modified form of the Wolff-Lehmann standard, Henry and Morrison arrange for dairy cattle by adopting the quantities of protein given in both Haecker and Savage standards, as for example 0.054—0.065 digestible protein for milk with 4.0 per cent fat. In this case, Haecker recommends 0.054 pound protein to be fed for each pound of 4.0 per cent milk produced, while Savage recommends 0.065 pound. The person figuring out a ration for a dairy cow will do well to see that the feed contains enough protein to come within the variations of the standard and the adjustment of this nutrient may well receive first consideration. There is no fixed standard for dry matter adopted in this case, but cows producing one pound of fat a day should receive from 21 to 25 pounds of dry matter for 1,000 pounds live weight.

A reference to Table B, Appendix, will show the modified Wolff-Lehmann standard given by Henry and Morrison.* The method of computing the amounts of dry matter, digestible protein and total digestible nutrients, applies the same in this case as in the example given with beef cattle. One must make a special computation, however, to establish one's standard, based on the number of pounds of milk daily, and its fat content, as previously stated. This is determined as follows:

*Feeds and Feeding, 1917.

As an example, we will take the case of a cow weighing 1,200 pounds, producing 30 pounds a day of milk testing 4.0 per cent fat.

	<i>Digestible protein</i>	<i>Total digestible nutrients</i>
A 1,000-pound cow requires for maintenance.....	0.70 lb.	7.925 lbs.
A 1,200-pound cow requires for maintenance.....	0.84 lb.	9.510 lbs.

If one pound of 4.0 per cent milk requires 0.054—0.065 pound protein, then 30 pounds would require 30 times 0.054—0.065 which would be 1.62—1.95 pounds protein.

If one pound of 4.0 per cent milk requires 0.346 pound digestive nutrients, then 30 pounds would require 30 times 0.346, or 10.38.

Adding these to the maintenance ration, we find that the required standard would be:

	<i>Digestible protein</i>	<i>Total digestible nutrients</i>
For maintenance 1,200-lb. dairy cow..	0.84 lb.	9.51 lbs.
To meet demands 30 lbs. 4.0% milk..	<u>1.62-1.95 lbs.</u>	<u>10.38 lbs.</u>
Total required.....	2.46-2.79 lbs.	19.89 lbs.

Thus we ascertain that a 1,200-pound cow producing 30 pounds of milk a day containing 4.0 per cent fat should receive daily a ration containing from 25 to 30 pounds of dry matter, 2.46 to 2.79 pounds of digestible protein, and 19.89 pounds total digestible nutrients, with a nutritive ratio from 1:7 to 1:8.

The adjustment of rations to the standard is not usually difficult. An increase in dry matter and carbohydrates is easily secured with the hays or most of our common feed stuffs. If a ration needs some adjustment in the protein, then some concentrate such as soy beans, cottonseed meal, linseed oil meal, or tankage may be selected. The cost of the feed is an important matter, and should be carefully considered. Some feeding stuffs, like cottonseed meal, oil meal, or tankage, that are not common in all localities, are easily purchased and shipped in by freight, and may often be used with much advantage and profit. These are high-class con-

centrates, and are extensively purchased by feeders of stock in countries where but a comparatively small amount of feed is grown, as in England and Holland, for example.

SOME RATION PROBLEMS

1. Given a 1,000-pound horse at medium work. He is fed 10 pounds oats, 10 pounds timothy hay, and 10 pounds ear corn a day. How does this agree with the Wolff-Lehmann standard?
2. A steer weighing 1,500 pounds, nearly fattened, consumes daily 20 pounds clover hay, 18 pounds corn-and-cob meal, and 5 pounds cottonseed meal. Is this ration satisfactory?
3. Make up a ration for a 500-pound brood sow, and figure out how it compares with the standard.
4. Feed 2 pounds alfalfa hay a day to a fattening sheep weighing 100 pounds. How much and what kind of grain will you feed to adjust the ration to standard?

CHAPTER XI

COARSE FEEDS, OR ROUGHAGE

The coarse feeds, or roughage, include the grasses and legumes of different kinds, the cereals (as forage), straws, silage, roots, rape, cabbage, or any similar feeds, whether green or dried as hay. Anything of a bulky nature, consisting largely of crude fiber, of which an animal must eat considerable to obtain much nutriment, is a coarse feed. In the dried form, like hay or corn stover, the western farmer has been accustomed to refer to them as roughage. In some sections of our country, farmers have certain feeds that are more common than in other parts of the country. Farmers in the North, for example, look to red clover or timothy hay for standard roughage; in the South, cowpea hay or Japanese clover is common; while in Kansas and Colorado alfalfa is a standard. Some plants, however, are more commonly grown than others, and so will receive special attention in a brief way in this chapter.

PASTURES, GREEN GRASSES AND HAYS

The value of the grasses depends upon their development. When grass is young and very green, especially in spring, it contains a large percentage of water, and is greatly relished by stock. As it matures, the amount of protein and total nutriment increases. Usually we find the food constituents, especially protein, most digestible when the plant is in full bloom. After that period the stalk and leaves grow more woody and less nutritious. When left to develop long after blooming, neither the pasture nor the hay is eaten with great relish. In experiments at the Missouri station, the protein in timothy cut for hay was greatest when the plant was in full bloom, there being 147 pounds to the acre. When

the seeds were formed, however, there was but 113 pounds of protein per acre, and this amount diminished to 92 pounds when the grass was cut for hay and the seeds were well ripened. The total digestible matter also fell off from 2,113 pounds per acre when the plant was in bloom, to 1,754 pounds when the stage of ripe seed was reached. This evidence suggests that the farmer should cut his grasses for hay before they become too mature.

Kentucky blue grass, or June grass, is one of the most nutritious and best pasture grasses. It grows extensively in the United States east of the Mississippi, though sparsely



Figure 20.—Shorthorn cows on blue-grass pasture. Photograph by the author.

in the Gulf states. It thrives especially on soils having a limestone foundation, and will not do so well elsewhere. No other grass is more relished for spring pasture by grazing animals. The roots spread out near the surface of the ground and form a beautiful sod. In moist weather and under fair conditions, the grass furnishes an abundance of fine leaves, supplying splendid pasture. During the summer, many pastures dry up and look as though dead, but fall rains revive them, and they again become green and vigorous. In some sections, stock is pastured on the dead blue

grass of winter, not much other feed being given, and with very good satisfaction. Kentucky blue grass is not usually valued for hay, but is known universally as a valuable pasture grass. The hay from this grass contains about 5 per cent of digestible protein, and 52 per cent of digestible nutrients when grown under average conditions.

Timothy is a standard grass commonly grown on the heavier soils of the North. It is frequently used for pasture, and makes a highly valued hay for horses. As a pasture grass, timothy is not the best. It does not stand trampling as well as some others, having small bulbs at the ground, with fine roots just beneath them, which are injured by heavy pasturing. This grass is generally somewhat coarse; but, if it is thickly seeded, more plants grow to the acre, and as a result they are finer and more palatable. Timothy cut and cured immediately after the pollen falls from the blossom makes better hay than that from an earlier or older cutting. Under usual conditions, this is an excellent hay for horses, but not so well suited to cattle and sheep. Care should be taken to see that timothy hay is bright and free from dust. Timothy in full bloom contains about 3.5 per cent of digestible protein and 51 per cent of total digestible nutrients.

Millet is grown in a number of varieties. Hungarian grass is the smallest form, and reaches a height usually of about two feet, with a single, small, bristly head. This makes very fair hay, containing about 5 per cent digestible protein. German millet is somewhat larger and coarser than Hungarian, and has a larger head, though of the same type. Both these millets may be sown in early summer, and under favorable conditions of heat and moisture they make a very rapid growth and furnish an abundant hay crop in a short season, usually maturing late in August or in September. Millets are not generally used in pastures. When heavily seeded they make very good hay for cattle and sheep. Caution should be used in feeding this hay to

horses, as it is thought by some to cause kidney trouble if fed very heavily. The millets may be grown over much of the country.

Redtop is a fine grass in appearance, and makes an excellent pasture. It is quite common in certain sections North and South, but is not generally abundant in the cooler grass-growing sections, probably doing better on the damper lowlands than elsewhere. It makes a very palatable and nutritious hay, with a chemical composition quite similar to Kentucky blue grass.

Orchard grass is common in some sections in the northeastern parts of the United States. It grows in tussocks, or bunches, so that the turf from this plant is somewhat uneven; hence it is not liked so well as some other grasses for pasture. It starts up early in spring, and has a strong, rather coarse growth, with hardly as smooth a stem as timothy. It is not quite as nutritious as timothy, ranking just below it. It may be grown to advantage with red clover, and often is, in the Middle West. It is best suited for horses and cattle, though it should be cut as hay before getting very ripe. While differing in size and growth from Kentucky blue grass, it has a similar composition in digestible protein and total digestible nutrients.

Brome grass in recent years has received considerable attention in the Northwest, especially in the Dakotas and in Western Canada. Here it has become a very important cultivated grass, occupying a position similar to that of timothy in the northern corn belt, but which grass it excels



Figure 22.—A good cover for the hay stack.
Photograph by Prof. A. G. McCall.

in contents of protein and total digestible nutrients. At the North Dakota station this was found to be the best grass for permanent pasture. It has the double merit of being palatable, and of being suited to semi-arid regions.

Bermuda grass in the South is a standard pasture. This plant grows a perfect network of roots near the surface, and covers the ground as with a mat. It is a very nutritious pasture plant, and has a most valuable place in southern agriculture. It will stand heavy pasturing, and may be used from March to November. If grown on rich soil, very heavy cuttings of hay may be expected. Bermuda hay contains over 4 per cent of digestible protein and about 43 per cent of carbohydrates, excelling in protein any other common grass.

Sudan grass is one of the new grasses of this country, being introduced in 1909. It is a tall grass, having stems of the size of a common lead pencil, and is related to the cultivated sorghums. It is especially suited to the southern states and irrigated regions of the Southwest. As an annual grass it will grow in Kansas, but can not survive the winter of the North. It seems destined to take the place of Johnson grass in the South, because it is fully as productive, and does not have the root-spreading habit. In the far South four cuttings of hay have been made in a season, yielding over seven tons of hay per acre, and a record of nearly nine and one half tons per acre is reported from Chico, California, these heavy yields coming from irrigation. In feeding value this plant ranks somewhat superior to timothy.

Mixed grasses are frequently sown for pasture in the northern states, timothy, redtop, orchard grass, and clover forming the usual combination. Prairie grass is usually a mixture, and somewhat resembles timothy in feeding value.

THE CEREALS AS FORAGE

Indian corn is perhaps the most common cultivated plant in American agriculture. Except on the arid lands, it thrives

from the Atlantic to the Pacific, and from the Gulf to Canada. It is the universal crop of the Mississippi Valley, and furnishes more food from an acre of ground than any other common crop. It is keenly relished by horses, cattle, and sheep, both in the green state and as dried roughage. No other plant in summer furnishes so much succulent feed as Indian corn. Grown somewhat thickly, the stalks are finer than common, and give a large yield of either green fodder or dried forage that is quite completely eaten by cattle and horses. In the North, corn produces a smaller plant than in the South, and gives a smaller yield of forage. Very large, heavy stalks, such as are frequently seen in the corn belt, are not



Figure 23.—Cutting corn with a harvester which ties the corn in bundles. Photograph from Minnesota Agricultural Experiment Station.

so desirable for feeding as those of more moderate size. About one third of the digestible food is found in the stalk, and two thirds in the ear. The complete cured plant and ear is commonly known as *corn fodder*, and after the ear is removed it is called *corn stover*. The dry stover, with the help of a little grain, is valuable for roughing stock through the winter, if much fattening is not desired. It is a bulky feed, and should not be fed heavily to animals from which much is expected. The plant contains the largest amount of nutriment when the kernels on the ear are beginning to glaze or harden, but it may be cut for feeding at any time

from the appearance of the silk to final ripening. Experiments have shown that an acre of field corn will yield a total of about three tons of digestible nutrients. Fodder left out in the shock during the winter is injured more or less in feeding value, losing in nutriment through mould and weathering.

Oats do best in the cooler sections of the North, but so-called winter oats do well in the South. This crop may be pastured or cut and fed green when of sufficient maturity. In New England many farmers grow oats to cut and cure as hay when the grain is in the milk. Oat straw is one of the best, both in nutritive value and in being relished by stock. A combination of oats and Canada field peas, from equal amounts of seed sowed early in spring, makes a very desirable green crop for feeding in June and July.

Rye has been much used both as fall and spring pasture. It mats up into a thick growth, and can be grazed with advantage to the grain yield if not pastured too long or too heavily, or it may be cut green and fed in the stable or feed lot. Many persons grow rye and turn stock on it to harvest it entirely. Hogs are frequently turned in, and they consume both stalk and grain. Dairy cattle should not be fed rye, except soon after milking, otherwise a strong and unpleasant odor in the plant will be likely to give a bad flavor to the milk. Rye straw is a very poor feed, having less than 1 per cent of protein and a great deal of fiber.

Wheat and barley may be used after the same manner as rye, and have much the same value, though they are not pastured as advantageously as the rye. Barley makes a nice soft hay, and is relished by stock of all kinds. Of the cereal straws, barley ranks close to oats as one of the best.

The sorghums represent a valuable group of forage plants, and are especially suited to the dry-farming lands of the West and Southwest. They will thrive under conditions of lack of moisture, when corn would not grow. There are

several varieties of sorghums, some of which are especially valuable for forage, notably Kafir, which has quite a leafy stem, and also yields well of seed. Some sorghums are valued for their sugar content, such as Amber cane, and this is more or less grown for feed in the upper Mississippi Valley. For forage, sorghum should be grown fairly close in rows wide enough for horse cultivation. The plant may be fed green or cut when the seed is ripe, and cured in shocks.

THE LEGUMES FOR FORAGE AND HAY

Legumes, which include the clovers, alfalfa, beans, peas, etc., grow easily over much of the United States. They are valuable chiefly because of the large percentage of protein they contain, and from the fact that they are highly relished by live stock. The lime in the legumes is also a valuable feature of these plants, for it is needed in building up the animal frame. The legumes have an extensive root development, and have the power of fixing the nitrogen of the air in the soil, through the agency of a kind of bacteria that are found especially in knots or nodules located on the roots. These nodules are rich in nitrogen, and, where legumes are grown, the land is increased in fertility and improved in texture.

Red clover is extremely common in the Mississippi Valley. One hundred pounds of the dried hay contain about $7\frac{1}{2}$ pounds of digestible protein and 50 of total digestible nutrients. As a feed for cattle and sheep, it is regarded as excellent. As a pasture it ranks high; and in the corn belt a combination of clover pasture in the late summer and fall, supplemented with ear corn, is a favorite ration for hogs. Brood sows and sheep do well on clover pasture. A large crop of green feed may be cut from a good stand of clover during the season, and this makes splendid feed for all kinds of farm stock. At the Wisconsin station, as much as 26 tons of green feed were obtained in 3 cuttings from an acre of red

clover. For hay, red clover should be cut when the blossoms are in full development, at which time it contains the most nutriment. Clover should be cured carefully and protected from the wet as much as possible after cutting. When clover hay is well cured and reasonably free from dust, it may be fed to horses with advantage.

Alfalfa is one of the most popular plants in America. In the irrigated sections of the West it has long been a leading crop. In recent years, its cultivation has been greatly extended, so that now it is grown with success over much of the United States, north and south, and also in parts of Canada. From two to five crops a year may be harvested.



Figure 24.—A field of alfalfa in Ohio. Photograph by the author.

At the New Jersey Experiment Station, 5 cuttings yielded $26\frac{1}{2}$ tons of green forage, equivalent to almost 6 tons of dry matter per acre. Alfalfa is a plant that is rich in protein, containing from 10 to 11 per cent in digestible form, and the dried hay is often compared with wheat bran in composition and feeding value. The fact is, that alfalfa is so close to bran in protein and carbohydrate content that in some sections of the West it is ground and fed in a meal-like form. Large quantities of special feed stuffs are made of this alfalfa meal, and are sold in nearly all parts of the country.

Alfalfa makes fine pasturage, especially for sheep and

hogs, but is not generally so used. It is undesirable to pasture it much, as heavy trampling injures the crowns of the roots. Neither should it be pastured very closely. A combination of alfalfa pasture and corn makes a splendid ration. When sheep or hogs are turned on this pasture, they should first have a good fill of hay, and should be kept constantly on the green feed from then on, by which method bloat may be prevented. When made into hay, the plants should be cut at about the time new shoots begin to appear about the crown of the root, and when the flowers are partly in bloom. The plant should be cured so as to hold as much bright green leaf as possible. As hay, this plant is unsurpassed. It is suited to horses, cattle, sheep, and hogs. All these animals like it, and do well on it. Corn is one of the best feeds to give with it. In the West, large numbers of sheep are fattened on corn and alfalfa. Brood sows do well on alfalfa hay and a little corn. This plant is one of the most valuable feeds used to-day on the stock farm.

The soy bean has rapidly grown in favor in recent years. It thrives over a wide extent of territory, and produces an excellent forage crop, and a seed rich in protein and fat. This plant combines well with corn, either for forage or the silo. It is easily grown and, when not too coarse, yields a large amount of very excellent forage or hay.

The cowpea is mostly grown in the South. It is planted to some extent in the middle Mississippi Valley, although it does not usually ripen seed in the North. It has a constant growth until frost, and so produces a great amount of forage, which is much valued for grazing and for plowing under for green manure. The peas are rich in protein, and the yield is often very heavy. This is one of the most valuable plants grown in the South, either for grazing, hay, or seed. The hay may be used to some extent as a substitute for bran.

Canada field peas in the northern part of the country make a valuable green crop for soiling, especially if planted

with oats early in spring. A seeding of oats, followed immediately by one of peas on the same land, using about one bushel and a half of each seed to the acre, gives one of the very best green feeds for early and middle summer use. This combination may be safely fed to farm animals generally, and it is much relished by horses, cattle, sheep and swine. If desired, it can easily be cured into a very superior hay.

SILAGE

Silage is a feed more or less green and succulent, preserved in a tall and usually circular structure known as a silo. Green feed is cut and stored in the silo, where it goes through a process of fermentation, with slight loss of its protein and carbohydrates. Under fair management this loss need not be over 10 per cent. The silo is one of the most valuable things on the stock farm, for in it a bulky feed can be stored more economically than in any other way.

Silage may be made from a variety of plants; but at the present time corn is used nearly altogether, because it combines the largest yield of the most easily stored and preserved forage crop generally relished by stock. Sorghum, clover, cowpeas, soy beans, and alfalfa are sometimes used. With the exception of sorghum, these plants are not always stored in the silo with satisfaction, as they may heat badly and sustain considerable loss in food value, unless well handled. For this reason, corn silage only will be discussed here. Sorghum and Kafir corn may be preserved in the silo equally well with corn, a feature of importance in the Southwest.

The importance of silage lies in the fact that it enables the stockman to give his cattle and sheep especially a succulent feed during the winter months of the year, and also when the pastures are dead and no green feed is obtainable. If one has plenty of silage, then one is quite independent of summer drouth. In fact, many owners of dairy cattle feed silage the year round. Because of its tender, succulent

nature and the convenience of handling, it is well adapted to all the seasons over most of the United States.

The corn crop is usually harvested when the kernels are turning into the glaze. It then is run through a forage cutter and cut into pieces about half an inch long. In this condition it is spread about in the silo and allowed to settle. As usually made, it contains about 1 per cent of digestible protein and 18 per cent total digestible nutrients. The dry matter in silage is worth no more than that in corn fodder, chemically considered; but cattle especially seem to respond to this feed with increase of milk flow and a better condition

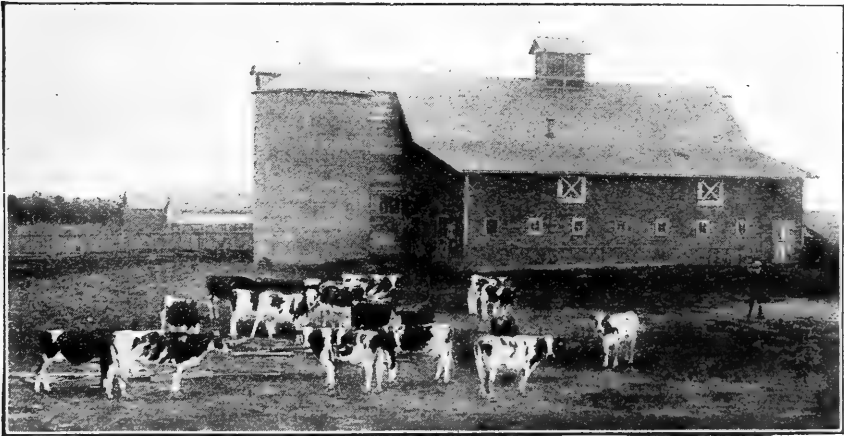

Figure 25.—A cement silo on a dairy farm. Photograph from *The Farmer*.

of body than when on dry fodder. Many feeding experiments have shown that corn silage is most desirable for dairy cows, and in recent years it has grown greatly in favor as a feed for beef production. It is well suited to sheep. Horses will do well on it when fed with moderation. For hogs, however, silage is too bulky and unsatisfactory and is rarely fed to them, and then with little benefit in most cases. In general, hay and some grain should be fed with silage. For cattle, from 25 to 35 pounds a day is a common ration, while for sheep from 3 to 4 pounds daily are ample.

Rape is a plant that belongs to the same family as the turnip and radish, and is grown for its succulent leaves. It is used exclusively for pasturage for sheep and hogs and is well suited to the cooler sections of the country or to cool seasons. In Canada and the northern United States rape is an extremely popular pasture plant among sheep breeders. Three or four pounds of seed per acre will do for a seeding, and stock may be turned on the field after the leaves have become large and succulent. Rape will stand considerable frost without damage. At the Michigan station, 15 acres of



Figure 26.—Pigs in a field of rape. Photograph from Purdue Agricultural Experiment Station.

rape pastured 128 lambs for $7\frac{1}{2}$ weeks, during which time they gained 2,890 pounds. From this trial it was established that 1 acre of rape pastured 9 lambs 7 weeks, producing 203 pounds of increase. For sheep and hogs, rape furnishes a most valuable late summer and fall pasture. It may also be sown in early spring, so that we may secure the pasture during the entire growing season. Green rape contains about $2\frac{3}{4}$ per cent of digestible protein, and compares very favorably in feeding value with most green clovers.

ROOT CROPS

Although all farm animals relish roots, these crops cannot usually be grown with profit in America, on account of the high cost of labor. In Canada and northern United States, roots may be grown with great success on fertile soils, but south of latitude 40, as a rule they do not yield so well.

The mangold, or mangel-wurzel, a large, coarse beet, is the most easily and cheaply grown of the roots used for stock feeding. The roots consist of about 90 per cent water, and of the dry matter only 1 per cent or even less is protein. A yield of 10 tons per acre is not uncommon. The chief virtue of the roots is that they are succulent and are most palatable, and keep the digestive organs of the animal in a healthy, open condition. They are usually fed after being run through a pulping or slicing machine, which puts the root in nice shape for feeding. Many feeders in England and Scotland, where roots are extensively used, mix the sliced root with chaffed hay or straw and grain, which combination makes a fine ration. One may feed cattle as high as 100 pounds of roots a day, but, as a rule, about 40 or 50 pounds is best. Sheep do especially well on roots, and in Great Britain and Canada from 5 to 7 pounds per day are commonly fed to these animals.

Carrots are slightly more nutritious than mangolds, but are more difficult to grow, and do not yield so large a crop. A large amount of labor is required in cultivating the carrot in its early growth, which serves to discourage the growing of this really excellent root. They are raised especially for horses, and fed to them with more success than other roots.

Swede turnips, flat turnips, and rutabagas are all good for stock and have much the same wholesome effect as mangels and carrots. They do not yield as heavily, however, as the mangold, and thus are more expensive to produce. Swede turnips are very popular among British stockmen, for they yield excellent crops, and are much relished by sheep.

CAN YOU TELL

1. Why the feeding value of a grass depends on its stage of development?
2. Why timothy is a standard grass for horses?
3. Why, in the opinion of some, millet should be fed with caution?
4. Where and why Bermuda grass is popular?
5. Why Indian corn is so valuable to the farmer?
6. How the legumes add to soil fertility?
7. Something about alfalfa?
8. Wherein lies the special value of silage?
9. Why roots are not grown more for stock in America?
10. How many pounds of roots a day should be fed the different kinds of farm animals?

SUGGESTIONS

11. Bring in small samples of different kinds of roughage used on the farm on which you live.
12. Bring to the class about a half-pound sample of average hay such as you are commonly using on the farm. Compare it with the other class samples.
13. Find the nitrogen-carrying nodules on legume roots.
14. Feed some green rye to a milch cow three hours before milking. Note whether the milk is unpleasantly affected.
15. Learn who puts up the best hay in your neighborhood, study his methods and report on them.
16. How many silos are there in your township or section, and to what animals is the silage fed?

CHAPTER XII

CONCENTRATED FEEDS

A concentrated feed, as one would naturally suppose, is just the opposite of a roughage. The two most common forms are seen in the grains of cereals and some other agricultural plants, and in the by-products of mills, where the cereals are converted into flour, breakfast foods, starch, etc. There are some other concentrates, that are products of such large manufacturing industries as the linseed and cottonseed oil mills, and the packing houses. In addition are also what are commonly known as "*commercial feeds*," these being combinations of various grains and concentrate by-products, and are sold under trade names on the market. These are all called concentrates, because, as a rule, they lack in coarse, fibrous structure, and contain larger percentages of protein and starchy matter than forage plants. For example, the grain of corn is a concentrate, one hundred pounds of which contains fully three times as much digestible protein and twice as much digestible carbohydrates as are found in corn fodder. Using another illustration, gluten feed, which is made as a by-product in the manufacturing of starch from corn, contains three times as much protein as the same weight of corn.

The cost of concentrated feeds is always much greater than that of roughages. In fact, the cost of most feeds sold on the market increases as the amount of protein in them increases. Feeds like cottonseed meal and tankage, containing large amounts of this nutrient, are usually high-priced, although that fact does not mean that they are expensive feeds to use. Sometimes the price of a certain concentrate is low on account of a glutted market or high because

the supply is exhausted. If, for example, the flaxseed crop of America is very poor, then linseed oil meal is likely to be high-priced, and perhaps would cost more than it is really worth. There is no special rule, however, about that matter, and sometimes business combinations control the prices of such feeds, so that one must pay without regard to the actual supply on the market. Market prices, however, are no guide as to the real value of feeds, and we have no satisfactory method of determining comparative values. The most satisfactory plan thus far devised is to ascertain the cost of each pound of total digestible nutrients in a ton of feed. For example; if a ton of corn, containing 85.7 per cent of digestible nutrients, costs \$20.00 on the market, then each pound of nutrients would cost 1.17 cents. If hominy feed of very similar composition, containing 84.6 per cent of digestible nutrients, costs \$26.00 a ton, then each nutrient will cost 1.54 cents per pound, which is a decided increase in cost for the nutrients in the hominy as compared with those in the corn. If one purchases high-priced protein feed, then it may be wise to base judgment in purchase on the relative cost of a pound of digestible protein from feeds of different kinds, as, for example, cottonseed meal and linseed meal. We can not, however, entirely determine the value of a feed from its chemical composition. Linseed meal is universally recognized as having a feed value beyond what is brought out by the chemist, as shown in its value in conditioning animals. Many feeders of roots also claim that a chemical analysis does not bring out their real feeding value, which is much greater than the figures indicate.

CEREALS AND THEIR BY-PRODUCTS

Indian corn is our most common grain. It is a food rich in carbohydrates and fat, and is especially valued for fattening animals. It is often called a heating food, on account of its heat or energy value. It is greatly relished by all farm

animals, and may be fed on the ear, shelled, or milled into pure meal, or the entire ear may be ground into what we call corn-and-cob-meal. While corn is rich in fattening material, it lacks in ash, or mineral matter, so that, when fed alone, it furnishes a rather one-sided ration. Except during the last part of the fattening period, it should be fed along with some feed rich in protein and ash, such as bran, middlings, etc.

There are *different races of corn*. In the more northern parts of the country, as in New England, a small to medium-sized plant, with a somewhat slender ear, covered with hard, flinty kernels, is grown. This is called *flint corn*. Over most of the country a larger plant, with thicker ears, covered with longer kernels, dented at the outer end, is grown. This is known as *dent corn*, and makes up most of the corn crop of the United States. Besides these two, we have *sugar*, or *sweet corn*, which has a rough-surfaced ear that may be very small or of medium size, covered with kernels that when dry are somewhat shriveled and tough. This sweet corn contains some glucose sugar, which accounts for the pleasant taste of the grain.

Corn meal is the ground grain without the cob. The usual run of such meal on the farm is rather coarse and is often cracked or crushed rather than finely ground. In some sections, the farmer calls it "corn chop." At the Wisconsin Experiment Station Professor Henry for ten consecutive winters fed two groups of pigs, one with corn meal and the other with shelled corn. On the average it required 501 pounds of whole corn and wheat middlings for 100 pounds of gain, and but 471 pounds of corn meal and middlings, a saving of 6 per cent. In feeding a bushel of 50-cent corn there would be a saving of three cents on a bushel, allowing nothing for labor or expense. Thus we can see that it usually does not pay to grind the grain, even though it is more completely digested than the whole kernel. Some special purpose grinding may be quite desirable.

Corn-and-cob meal is the kernel and cob ground up together. If the cob is not too coarse, such feed is excellent for cattle and sheep. Feeding experiments have shown that 100 pounds of corn-and-cob meal fed to these animals will give returns equal to 100 pounds of pure corn meal. The reason given for this is that the ground cob makes the meal more porous, allowing the fluids of the stomach in digesting the food to mix more easily with the corn and porous cob meal than with the pure meal, which is inclined to become heavy and soggy. This feed is not good for hogs, unless ground very fine, as it contains too much woody fiber.

Gluten feed is a product of factories where starch is made from corn. It consists of what is left of the grain after the starch and germ have been removed, and is quite rich in digestible protein, containing about 20 per cent. Cattle and sheep are fond of it, and it is a mill product of much value in balancing a ration for these animals. Gluten meal, another product of the starch factory, richer in protein than gluten feed, was formerly sold separately. At present it is usually ground in with the gluten feed.

Hominy feed is a by-product of the hominy mill. It resembles a fine whitish corn meal when made from white corn, and consists of the hulls and other parts of the corn grain ground up together. Its feeding value is quite the same as corn meal, and it is excellent for cattle, sheep, and hogs, all eating it with a relish. Hominy feed is quite popular in some sections of the country among men feeding dairy cattle in official testing for milk and butter-fat.

Wheat is not usually fed to animals, unless it is very low in price. It becomes somewhat pasty when ground in the mouth, as everyone knows who has lived in a wheat country. It contains about 9 per cent of digestible protein, and belongs in the class of feeds fairly rich in this substance. All animals are fond of wheat. It should, however, be crushed or cracked before feeding to horses, cattle, or hogs; but need

not be for sheep. Wheat tends to make animals muscular or lean and hence its feeding value is greatly improved by the addition of an equal amount of corn.

Wheat bran is the outer covering of the kernel. In the big flour mills, the kernel is crushed to obtain the flour, and the thin outer fibrous covering is removed as bran. This contains about 12 per cent of digestible protein, and is a standard concentrate for feeding horses, cattle, and sheep. We say that bran is a laxative, and keeps the digestive system cool and open, a very necessary condition for farm animals. Stockmen have always regarded bran as especially valuable. It has recently been found by chemists to contain an acid substance called *phytin*, which has beneficial laxative effects on the digestion. Wheat bran is well suited to mix with corn or oats or may be fed alone to stock. Many horsemen feed it in the form of a thick, wet, warm slop, called "bran mash." Bran is even more of a muscle and bone-making food than wheat, and most students of feeding use it for young, growing animals. There are brans made from spring wheat, such as is grown in the Northwest, and from winter wheat. There is not much difference between them, but the bran from winter wheat usually contains somewhat more flour than that from spring wheat.

Wheat middlings are also a by-product of the flour mill. They are commonly of two grades in the trade, flour, or white, middlings containing about $15\frac{1}{2}$ per cent of digestible protein, and standard middlings, containing about $13\frac{1}{2}$ per cent of protein. The total digestible nutrients as given by Henry and Morrison are 78.2 per cent for the former and 69.3 per cent for the latter. Standard middlings contain less flour than the other grade, and are quite similar to *shorts*, which is often reground bran. Flour middlings usually cost four or five dollars more a ton than the standard, and are much preferred to the latter by feeders of hogs, for which purpose middlings are mainly used by the farmer. On the

market middlings usually sell for several dollars more a ton than bran, especially when there is an active demand.

Wheat screenings usually consist of shrunken, broken grains of wheat, mixed with weed seeds, pieces of straw, etc. The value of screenings depends upon the amount of grain in it. They have been very extensively fed to fattening sheep in America, especially in the Northwest, near the flour mills. Sheep do well on screenings, and, if one can buy at a cheap enough price, they are a good feed to use.

Oats are a standard feed for farm animals in all agricultural countries. They contain about 10 per cent of digestible protein, as compared with about 9 in wheat, but have less carbohydrates and more fat than the wheat. It has often been thought that oats contained some substance that gives life and snap to animals beyond that furnished by any other grain, but chemists have not been able to find this mystical something. Still, it is generally agreed that oats do produce a most excellent effect on the horse, far better than any other grain. Some oats are more chaffy than others. Northern-grown oats are plumper and weigh more than southern ones. In fact, oats do better in the cooler sections of our country, and yield far larger crops. For horses no other feed is so widely used in America or Europe. It is not likely to cause indigestion, and is a safe feed. It is best suited to cattle and hogs when crushed or ground, while sheep will do equally well on it in any form. For young, growing animals it is one of the best feeds we have; for, like bran, it helps to build up a strong, muscular frame. Often oats are very expensive, and their purchase, which may become a serious problem with the feeder, should depend on the cost and the purpose for which they are intended.

Oat hulls are very poor as a feed stuff, for they contain but little nutriment, and are too largely fiber. They are frequently mixed with commercial feed stuffs to act as a "filler."

Barley is a very hard small grain, that as commonly

grown is covered with a strong husk. It is rich in carbohydrates, and has slightly more protein than corn. It is not commonly fed to farm animals in the United States, but is very popular in northern Europe. Horses will do well on barley, while barley meal as a feed for swine ranks very high in Canada and Europe. Experiments have shown that pigs fed barley make a superior quality of bacon. It should be crushed or ground before feeding.

Rye is quite similar to wheat in composition. It makes a good feed for the same purposes for which wheat is used. It has a somewhat stronger flavor than other grains, and, when fed to dairy cows, tends to give an objectionable taste to milk. If fed, it should be given right after milking.

Linseed meal is the product of flaxseed. This seed contains about 30 per cent of oil. The manufacturers of linseed oil grind the seed, and extract the oil by pressure, leaving long, brown, board-like cakes, as a by-product. These are broken up, or ground, and fed as linseed cake or linseed meal. It contains about 30 per cent of digestible protein and about 78 per cent of digestible nutrients. All farm animals are most fond of this product, and it is used to some extent by many feeders. It softens the skin of animals and gives a silky lustre to the hair. It is often used in so-called condition powders, to make up much of the bulk of them. It should form from one tenth to one fifth of the ration, according as the need exists for a highly concentrated feed to balance the ration.

Cottonseed meal is a by-product of the cottonseed oil mills. About one fifth of the seed is oil. The usual custom is to remove the hard covering, or hull, of the seed, and then press a dark brownish oil from the meats, which, when refined, becomes an attractive golden yellow. The by-product remains as long, yellow, board-like cakes. It is one of the most concentrated and valuable feeds that we have. Small particles of hulls are to be found in the cake, and the greater

the amount of hulls, the poorer the grade in protein of the cake. There are three recognized grades on the market, based on the protein content. These grades are as follows:

(1) *Choice cottonseed meal*, in perfect condition, sweet in odor, yellow in color rather than reddish or brown, free from excess lint, and containing at least 41 per cent of crude protein.

(2) *Prime cottonseed meal*, which must be sweet of odor, reasonably bright in color, and containing at least 38.6 per cent of crude protein.

(3) *Good cottonseed meal*, containing at least 36 per cent of crude protein, otherwise like the prime in character.

An excellent and justly popular balanced ration consists of a combination of corn silage or stover, with some shelled or ear corn, and cottonseed meal. Cottonseed meal is not a safe feed for pigs or calves, as it has a poisonous effect, which may result in serious sickness and death. Cottonseed meal is often one of the most economical protein foods that the cattle feeder can buy, considering the character of the nutriment it contains. It is fed to some extent in the South, along with the hulls, which largely consist of woody fiber, and fair gains in steer feeding have come from this combination. Milk from cows fed cottonseed meal produces a harder butter than when corn is used. The fat of steers that have been fed cottonseed meal is also harder than that of steers fed corn meal. One can easily see that in warm sections of the country, as a result of the use of this feed, butter will ship better than it might if some other feed were used.

Cottonseed feed is a mixture of cottonseed meal and hulls, containing less than 36 per cent of crude protein.

Cold pressed cottonseed cake is made by crushing the seed under great pressure while cold, thus extracting the oil. It contains considerable hulls, and shows about 21 per cent of digestible crude protein.

Tankage, or meat meal, is a product of the beef-packing house. It is made from inferior pieces of meat and the trim-

mings, and from diseased carcasses. This meat is sterilized, and dried in air-tight tanks, and is then ground to a meal. It is very rich in protein, containing usually from 50 to 60 per cent, and 11 or 12 per cent of fat. It is especially relished by hogs, and since 1900 has been much used in the West along with corn to balance up the ration. A mixture of 1 part of tankage and 6 to 10 of corn gives excellent results in hog feeding. While this feed is high-priced, it is no doubt one of the most important additions to the rations for swine. The glossy coat of hair and hearty appetite of the tankage-fed hog are evidences of the value of this feed.

Milk is not strictly a concentrated food, but will be briefly referred to here. As drawn from the cow it contains about $87\frac{1}{2}$ per cent of water and $12\frac{1}{2}$ per cent of solid material. Of the solids, about $3\frac{1}{2}$ to 4 per cent is usually fat and 4 to 5 per cent milk sugar. Milk is a most important food for all young animals during the earlier stages of growth. If new milk is fed, the young animals lay on flesh easily, and may take on a strong, muscular development. If the fat is taken from the milk, and skim milk is fed, a good frame may develop, but the animal will not look so well fed, the skin will not be so mellow, nor the hair so glossy. Pigs of any age will do well on a combination of milk and a grain rich in carbohydrates, which ration makes a very high-class pork. Buttermilk has much the same feeding value as skim milk, there being almost no fat in either. One should be careful to feed only clean milk, produced under healthful conditions. Skim milk from a creamery should not be fed, unless it is first pasteurized, so that disease germs may be destroyed.

Whey, a by-product of cheese-making, has a feeding value about half that of skim milk. In Europe it is commonly fed to swine. Used to best advantage, it should be fed with supplements rich in protein. Dried skim and buttermilk powders, mixed with water, are also used somewhat as substitutes for the standard products.

SOME CONCENTRATED QUESTIONS

1. What are concentrates?
2. Why is corn so valuable?
3. Which is better for cattle,—corn meal or corn-and-cob meal?
Why?
4. What special value has bran?
5. How do oats rank as feed for horses?
6. In what countries is barley a popular feed?
7. Why recommend linseed-oil meal?
8. What can you say about cottonseed meal?
9. Why feed tankage?
10. What is the average composition of milk?

HINTS AND SUGGESTIONS

11. Collect samples of concentrates fed in your neighborhood, and label with name, composition, and price.
12. Make up a sample ration, specifying on a card,—
 - (a) Pounds of each concentrate used.
 - (b) Cost of each concentrate.
 - (c) Nutritive ratio.
 - (d) Kind of stock for which prepared.
13. Learn what your neighbors are feeding for concentrates, cost, and how used. Can you suggest improvements?
14. Who feeds tankage, under what conditions, and with what results?
15. Investigate the conditions under which skim milk is sold for feed to creamery patrons in your locality, and report.

CHAPTER XIII

JUDGING FARM ANIMALS

The relationship of the animal form to its function is one of great importance and offers a most interesting study for the live-stock student who would know farm animals. The word *conformation* is used in a general reference to the arrangement of the parts of the form to one another. When

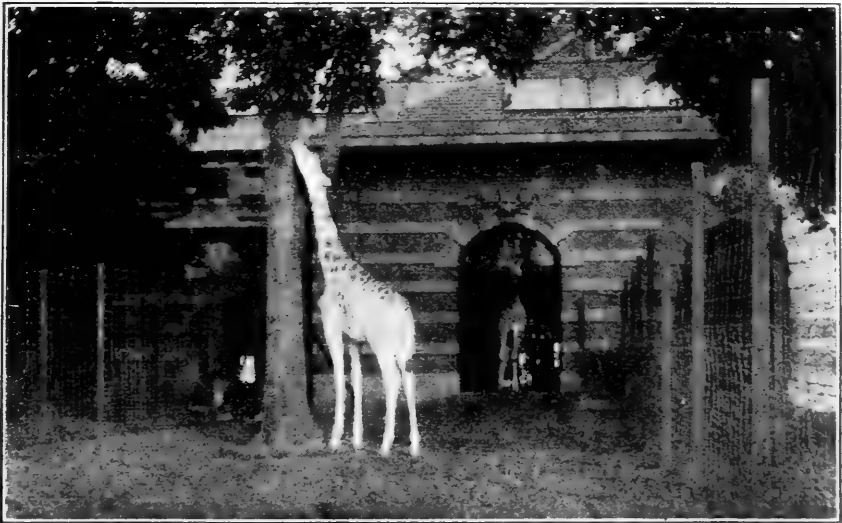

Figure 27.—Giraffes in the New York Zoo, Bronx Park. Photograph by the author.

one says an animal has a good conformation, one simply means that the different parts are well balanced and in harmony with one another. Scientific study has shown that all animals, no matter how odd they may seem, have conformations best suited to their needs and conditions of life. The giraffe, with excessively long neck, feeds on the twigs and leaves of the trees overhead; the lion, with cat-like form, slyly creeps up and springs upon its prey, and tears and cuts

away its flesh by means of its powerful jaws and teeth; the deer, light and most graceful of form, grazes on the grass and tender twigs, and bounds away to safety like a flash, when an enemy appears. Form, size and color, all have their special purposes. Our domestic animals have developed under artificial conditions, over which man has had large control, with the result that our horses, cattle, sheep, and swine become creatures of special purpose to a very unusual degree. The great speed of the Thoroughbred, the massive size of the Shire, the excessive milk development of the Holstein-Friesian, and the heavy fleece of the Merino, are all fine examples of this special-purpose development.

The most efficient judge of live stock is the student of animal form who can most clearly see and understand this relationship of form to function. The qualified judge obtains his knowledge in two ways: first, by environment, or his home surroundings; and, second, by education. The average British farmer is a great lover of animals and is usually a good judge of a beast, and his children inherit the same characteristics. It is second nature for him to measure up in a logical way the weak and strong points in an animal and judge their values. Yet one may become a capable, efficient judge by combination of a natural admiration for animals with systematic training in judging. The judge at all times should be able to compare the animal before him with what he knows to be the ideal or perfect one. The ability to compare differs in degree. Beginners are not supposed to be as proficient as experienced men, yet time and experience add to one's qualifications. Even if one lacks to some extent the desirable qualities to be found in a successful judge, one may, nevertheless, be qualified to pass in judgment on many occasions where the responsibilities are not the greatest, and where real service may be rendered.

The judgment of the stockman should enable him to buy and to develop his herd with intelligence. No man is quali-

fied to manage any business at the present day who does not know the difference in the values of the goods he handles. Then why should not the man who owns stock on the farm be capable of giving an intelligent judgment as to comparative values among his animals? A large number of herds of dairy cattle in the United States have been shown to be unprofitable. This fact is not, as a rule, due to the kind and amount of food given, but rather to the sort of animals kept. The man who knows how to select the right kind of dairy cows to build up a herd will find his knowledge a source of profit rather than loss, if he makes good use of the same. Without doubt, hundreds of thousands of dairy cows are unprofitable to their owners. This fact in itself is a good reason why one should study the relation of form to production and put into application the knowledge gained.

Important defects in animals are often passed by unnoticed by men who are not capable judges. The man who knows nothing of a horse and desires to purchase, if he depends on his own judgment, is liable to be deceived and to buy something he does not want. A side bone or a spavin may be a little thing to see, but its presence on the horse is a distinct imperfection, as one will quickly learn if one tries to sell such an animal. A good judge will discover these imperfections and let someone else be the purchaser. On every hand are men engaged in buying live stock who have given no serious study to qualify themselves for this work, hence they are often grievously disappointed.

Buying immature or green animals that give promise of great development is a specialty with some experts. Such men are keen students of animal form. It is not difficult to pass on the merits of a mature horse that stands before one in perfect condition, ready for the show ring. It is not so easy a matter, however, to go into the pasture and select the best prospect from a bunch of thin yearlings that have had no special care during the warm, dry summer days. The

man who goes to the stock-yards to buy a lot of steers for feeding is at the mercy of the dealers there, unless he has the necessary judgment, not only to know what kind of cattle he wants, but how to sort them out. The ability to select wisely the green, untrained colt or promising heifer has enabled more than one man to find what we sometimes call "a diamond in the rough."



Figure 28.—Select the best prospects from a herd of thin yearlings.
Photograph from Henry W. Vaughan.

Many capable live-stock judges in one community would indicate a superior general average of the animals there, with a high valuation from a commercial standpoint. An example of this condition is seen in England and Scotland, where good judges of stock are comparatively common. It is interesting to observe, not only that the flocks and herds of those countries are much superior to those of any other country, but that the people of the rest of the world for generations have been sending their gold to England and Scotland to exchange for superior stock. Most of our improved breeds came from Great Britain, and we sent there for them because their merit was seen and appreciated. Suppose the people of some one of our states were to give special attention to the improvement of their live stock, and the study of animal form became popular, what would result? Would there not be a great improvement in the live stock of that state, and

would not its wealth be thereby greatly increased? In the estimation of the unprejudiced stockman it most certainly would.

A natural interest by man in animals, as shown in sympathetic care and affection, offers a good reason for making them a subject of careful study. The greater the intelligence with which one can look an animal over, the more pleasure will be found in the occupation. A business that does not offer an incentive to greater effort can not profit a man much. The production of beautiful and useful animals can not but bring out the best there is in a man's character; while at the same time he is rendering a service to his fellow man by producing something that adds to the wealth of the community. We call a man a great artist who paints on canvas a beautiful picture of a magnificent horse, but what shall we say of the man who bred and raised this horse to his perfect state? Is he not the greater artist of the two?

The use of the scale of points, or score card, as it is often called, is a first step in the systematic education of the person who desires to learn how to judge live stock. The scale of points was first originated about 1828, on the island of Guernsey, we are told, *when the judges introduced it for comparison in judging their cattle. The people on the island of Jersey also felt that something should be done to improve their cattle. So they selected two cows, one of which they thought had the nearest perfect form in the front half of the body, while the other was considered to have a perfect rear half. Then they placed a numerical value on each of these best halves of the body, using these two cows to furnish a standard or model with which to judge other cows. They also selected two bulls, and made a score card for the males by the same process. As a result of this unique method, the people on Jersey adopted in 1834, "A scale of points for Jersey cows," as it was called. They gave the cows 27 points; and another scale gave the bulls, and the heifers not in milk, 25 points. The people on the

*The Guernsey Breed. Charles L. Hill, 1917, p. 52.

island made a practical application of the use of the scale by comparing their cattle with these standards. Much benefit came from this method of judging, and their cattle were gradually improved. They revised this scale on several occasions, and among other things finally adopted a uniform standard of 100 points for each sex.

Since that time score cards have been much used by men interested in other kinds of stock, and scales of points have been adopted for most of our improved breeds. Not only that, but score cards that apply only to types of stock, such as the draft horse, etc., are commonly used in agricultural schools and colleges. The following is a copy of a score card for Dorset Horn sheep, that was adopted many years ago. It is given here on account of its concise form and simplicity of expression.

THE DORSET HORN SHEEP SCALE OF POINTS

Points scored	Perfect score	Score of animal
GENERAL APPEARANCE. Head well up, eyes bright and alert; and standing square on legs	20	
HEAD. Small, face white, nostrils well expanded, nose and lips pink in color	5	
HORN. Neat, curving forward, and light in color	10	
FORETOP AND BELLY COVERING. Good foretop and well covered on belly and legs	10	
NECK. Short and round, set well on shoulders	5	
CHEST. Broad, full, brisket well forward	10	
BACK. Broad, straight, with well sprung ribs	15	
QUARTERS. Heavy, square, set on short, straight legs, well apart	10	
LEGS. White, with small, light colored hoof	5	
WOOL. Medium quality and good weight, presenting an even, smooth, white surface	10	
Total	100	

An example of the use of a scale of points is necessary, and this of the Dorset will serve our purpose. Under "points scored" it will be seen that there are ten things to which attention is directed. Each of these ten is given a brief description and a number, which represents what the stockman calls "points." The number 20 in the column named "perfect score" means that a Dorset sheep that

would exactly answer to the description of general appearance there given would score 20, or would be perfect in this one respect. If in scoring a sheep one had the opinion that each part was perfect, then one should give the full value in the blank space for "score of animal." In such a case the sheep would score 100, and hence by the scale of points would be perfect. But we have no such animal. It is rarely that one will score 90 points or above, and but few grade as high even as 80. Suppose you were scoring a Dorset ram. As you examine the animal, you are sure to find him inferior to perfection in some points. He may carry his head perfectly, the eye may be above criticism, but you may find good reason to criticise the way he stands on his feet. He may not be bad in this respect; so you give him 17 points for general appearance instead of 20. Narrow chests are very common, and our Dorset may show by the close way his front legs are placed together, that he lacks a broad, full chest; so after consideration you give him 7.5 points for this part, which you think is all the credit he should receive. Thus one goes through the list of points and examines the animal systematically and critically, putting down the score from part to part, finally adding the column made, and so getting the total points scored for comparison with the perfect Dorset.

The value of the score card lesson is seen in several ways. It trains the student to examine the animal systematically, and impresses on the mind the things that should be considered in studying form and character. Attention is first called to the animal as a whole, when character is considered, as it can be studied at no better time, and then the different parts in proper order are carefully examined and rated. So one learns to make first a general examination, to get the balance of parts, the breed character, the size, quality, and condition, and thus measure up the entire animal from the standpoint of appearance. Then comes the detailed study

of the head, next the neck, then the breast, and so on. The relationship of each part to the other must be considered so as to get a fair idea of the strong and weak points in the conformation. Thus in the first lessons in judging, systematic study becomes a feature in the use of the score card, which is a very important lesson in itself.

The relative value of the parts is also shown in the use of the score card. When a specimen of a breed is being studied, we must remember that we are using a scale of points that has probably been adopted, after much careful study and comparison, by a committee of experienced men most familiar with that breed. Thus we get the best measure possible of this breed, and in the scale we learn what parts are most highly regarded, and which least. If we are using a score card such as relates to a fat hog, where breed is not considered, such as is in common use in the agricultural schools, then we find that experts have made this up so as to give the proper values to the different parts of the body. No matter what kind of score card we are using, we may be quite sure that it will give a recognized place and value to each part or group of parts. The various breeds of live stock of much the same type have scales of points that place similar values on what may be called their most important characters. For example, all the dairy cattle score cards give many points to udder, etc., while those of beef cattle give special credit for breadth and thickness of back.

In the use of figures in scoring, it is not well to grade any part in too fine a degree. Suppose the ear is given one point. When so small a number is used to indicate perfection, grades of .25 or .50 or .75 may be used to express the score for that part, and .25 of one per cent is small enough to enable one to express reasonably accurate valuation of the ear. In any event, decimals should be used, and the person scoring should have his column of figures properly arranged, with the decimal points in line. When common fractions

are used, the figures in the column do not stand out so clearly in contrast as when the decimal fractions are employed.

The number of points cut is an expression sometimes used when referring to the number of points deducted from perfection. If a part in the perfect score is credited with 10, and one gives the animal in question 7 points, then we say it has been cut 3 points. Many judges write the 3 on the card instead of the 7. This practice is wrong. The points cut should not be written down. We are comparing the thing as it exists in the real animal, with the ideal, and this comparison is expressed numerically. To put down as points that which is lacking, is to compare nothing with something. With our two columns, however, one of the imperfect score, and the other of the perfect, we are able to draw a proper comparison all through.

The value of the score of an animal should not be regarded too highly. The chief importance of the score card lies in the first lessons in judging, in which the different parts of the animal, their location and relative value are impressed on the mind. It is difficult, however, to score an animal satisfactorily under the varying conditions of living flesh. To-day we may score an animal 75, and to-morrow perhaps 71. The horse we scored yesterday may show more character and style to-day than he showed 24 hours ago. We do not know how to express in cold figures these things we see in the beast before us. We can tell what we see, and, if we have two or more animals before us for judgment, it may be an easy thing to place them in their relative order of merit, and with good reasons. Yet these reasons can not be so clearly shown by a column of figures on a score card. On various occasions efforts have been made to judge animals on the basis of the scale of points, and to make showing awards accordingly. This plan has been carefully tried by many of our best judges, and has very generally proved unsatisfactory, and for the reason given. To-day the scor-

ing method is generally discarded, except at poultry shows, and here it has given such dissatisfaction that it has been abolished in many cases. In spite of this criticism, we must not lose sight of the value of the scale of points as a standard and what it may teach.

Judging by comparison is the next step to be taken after a few lessons with the score card. This means keeping in one's mind the essential features of the scale of points, and then studying one or more animals of a kind and placing mental values on the subject or subjects examined. A person should make himself familiar with the different types or breeds that he is interested in, and at every opportunity give personal study to individual animals. In a matter of comparison, it is necessary to keep in mind the important features to be considered, and then judge the animals as intelligently as possible. In judging by comparison, it is customary to line up the horses or cattle or sheep side by side, so that they will face in the same direction. Hogs are usually examined in small groups, being kept together with the help of hurdles.* The front feet should stand slightly higher than the hind feet, and there should be space enough for the judge to pass easily between the animals to make his inspection. The center of an open space, with a firm, clean floor, is most desirable.

When the heads are lined up, the other parts are in the best position for inspection. The judge then begins his comparison, first walking around the line of animals and noting from different points of view the general comparison of one with another. It is a good plan also to examine the animals in single file, one directly behind another. Thus one secures quite a different point of view, and obtains an outline of head, back and quarters, and easily notes the difference in depth of body and length of leg. In British shows the judges commonly have the animals parade before them, in

*A hurdle is similar to a small section of a light panel fence. Some hurdles weigh only 3 or 4 pounds and are easily handled. Others may be longer and heavier, requiring two men to handle.

order to study them when in motion, and detect unsoundness, poor action, etc. This custom is steadily growing in favor in America. The judge must necessarily place first in rank the animal that shows the most breed or type character, that has the most complete balance of parts, the most perfection in various details, and the least number of faults. Emphasis, however, must be placed on the special purpose of the animal under consideration, as weight in heavy draft horses, udder development with dairy cows, or character of fleece with Merino sheep. For example, most of the scales of points of the breeds of dairy cattle devote about one third of the total scale emphasizing the size, form, etc., of the udder,

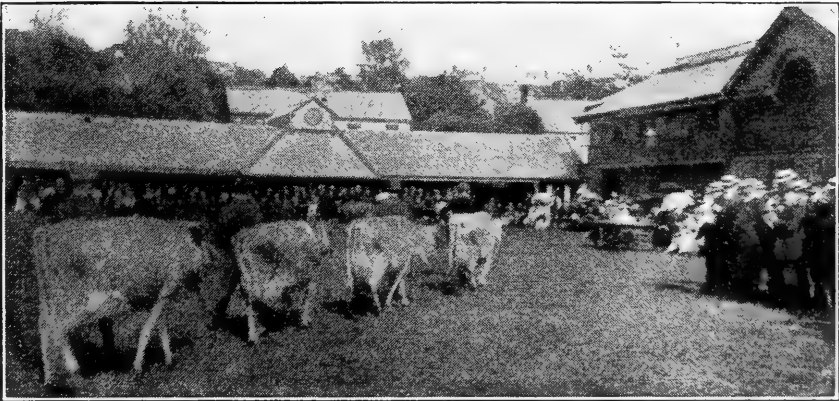

Figure 29.—“In British shows the judges commonly have the animals parade before them.” Photograph by the author on the Island of Jersey at the annual Spring show.

teats, milk veins, and wells. Such special features must be kept in mind by the judge as of real importance.

In placing the animals, it becomes a question of prompt decision in sorting out and getting the individuals in one, two, three order of relative merit. In large rings at livestock shows, judges often divide the animals into two groups, those that they consider worthy candidates for the prize list, and those that are not. The former group is frequently referred to as “the short leet,” a British expression for the

choicer individuals. After the short leet is selected, the other group is usually sent to the stalls. In most comparative rings, it is not difficult to find quickly the best animal; but as one deals with the stock farther down the line, it becomes necessary to decide on the relative demerits rather than the merits of each, and to place highest those that show the fewest undesirable features, a matter in which judges sometimes differ quite a bit. Naturally we do not all see things alike; and so the judge who does his work carefully and comes to a decision independently of the views of others, is assuming his responsibility in the right way.

Keeping notes on animals under comparison is a very good plan. It is customary in classes of stock judged by students to give each animal a number or letter. These marks may be written on common gummed paper labels, and stuck on the rumps of horses or cattle, on the tops of the heads of sheep, and on the backs of hogs. Then on a small card or folded slip of paper one may give space to each animal under its number, and make brief notes of certain features of importance. These notes are often instructive and suggestive, and aid the young judge in keeping things in mind. In the student's judging contests of to-day, the boys are allowed to take notes in this way and use them for reference up to the time of appearing before the judges to give their reasons.

In discussing an animal being judged, it is desirable to do so briefly and clearly, emphasizing the important things, such as character, general conformation, quality, back, body capacity, chest development, or hind quarters. Much, of course, will depend on the special case in hand. Then, if one is describing an animal, or is comparing two or more, the frequent use of such expressions as "he has a good back," or "she has the best quality," are to be discouraged. The words *good* or *best* in these cases really convey no specific information. Instead, if one says, "He has a long, wide,

muscular back;" or "She excels the other in quality, as seen in a fine, silky coat of hair and a mellow, elastic skin," then the reasons given will be clearer and convey more meaning than simply "good" and "best."

The decision of the judge is always open to criticism. Being only human, we see things from different points of view; so why should we not differ? The courts do not all agree, as is often seen, one court reversing the decision of another. Two things, however, on the part of a judge are most important: one is honesty; the other is knowledge of his business. If one has these qualifications, and then comes to decisions with independence, regardless of what anyone else thinks, one's work as a judge will, as a rule, be satisfactory and the judgments will command respect.

BY THE WAY, DO YOU RECALL

1. The meaning of the word conformation?
2. Why one man is a good judge and another is not?
3. The advantage that has come to England from having many good judges of live stock?
4. The condition under which the scale of points originated?
5. The general application of the scale of points?
6. How figures should be used in scoring?
7. The chief importance of the score card?
8. What is meant by judging by comparison?
9. What to emphasize in judging dairy cattle?
10. The most desirable method of discussing animal form?
11. Some desirable qualifications for a judge?

WOULD IT NOT INTEREST YOU TO KNOW

12. Who are the most intelligent judges in your county?
13. Who some of the judges were at your State Fair?
14. Who judges grade and cross-bred fat cattle at the International Live Stock Exposition?
15. On what basis men are selected as judges, especially at county fairs?

CHAPTER XIV

ANIMAL TYPE AND ITS IMPORTANCE

Farm animals in early days in America were usually very inferior. The settlers of New England and the older states did not give much attention to live stock. Until we had large cities we had no important live-stock markets. The farmers produced but little more than was needed for the local home sales. In 1830 the first railway was built in America. Before that time, people drove live stock long distances to market. As early as 1804, cattle were driven overland from Ohio to Baltimore to find buyers. West of the Mississippi, large herds of cattle and sheep developed with the settlement of the country. There were great drives of cattle and sheep overland to Kansas City, St. Louis, and other places. It was not till 1865 that the Union Stock Yards of Chicago opened for business. Now it is much the largest live-stock market in the world.

The study of animal form in a large way really began with the selling of stock in the market. At first people were not very particular. An increase in population, however, increased the demand for meat. Then men began to buy from the farmer and to sell animals in the markets. These sellers naturally noticed certain differences in their stock. They saw that some beasts served a given purpose better than others, and that some were really worth more than others for the same purpose. So the men who sold in the markets began to use special words to indicate the kind of stock under discussion. At first it was only a "good" animal, or a "poor" one. Then other words came into use to show still finer differences. If one examines the market quotations in the early numbers of the oldest agricultural papers,

one will find just such words as "good" and "poor", etc., used in references to market live stock. In the course of time, people began to see that farm animals differed in type.

The word type, as applied to live stock, refers to the special form or purpose of an animal. For example, we say that a horse is of the draft type. This term means that he is large and strong, and especially formed to haul heavy loads. As stockmen use this word, however, it does not mean that the animal referred to is perfect. It is simply an expression that the horse or cow, or whatever it may be, belongs to a special group in which we find others of various degrees of merit. The word type has not been used many years by stockmen. At the present time, however, all our farm animals may be separated into fairly distinct, well-known types. The more simple classifications are as follows:

HORSES

1. Draft type
2. Coach or carriage type
3. Light harness or speed type
4. Ponies

SHEEP

1. Mutton type
2. Wool, or Merino, type

CATTLE

1. Beef type
2. Dairy type
3. Dual or general-purpose type

SWINE

1. Lard type
2. Bacon type

All our farm animals may be sorted, and each one placed in a group representing one of these types. Each of our breeds of live stock, also, has one or more types. Where there is more than one type in a breed, it is the result of different lines of breeding.

The grouping of live stock on the market into classes was the final result of the development of the modern live-stock trade. As the population grew, the demand for variety and for special purposes increased as never before. There were new uses for horses, and meat animals were sold for a much greater variety of needs than used to be thought possible. So, to-day, we find in the big markets that all types of live stock are grouped into different commercial classes, and then each class is graded according to its merit. For example,

here we have the beef type, and within this a number of different classes. One class, known in the larger stock yards as *beef cattle*, is regarded as fattened and finished for the butcher, being ready for killing. Another class, known as *stockers and feeders*, is sold to go back to the farms for further feeding and fattening. Another class, called *butcher stock*, consists of fat cows and heifers. Then there are various other classes of stock, such as calves, butcher hogs, western lambs, feeding sheep, etc., all of which are included in the different types described.

The market grades of live stock are also important. Each class is divided into different grades. Beginning with

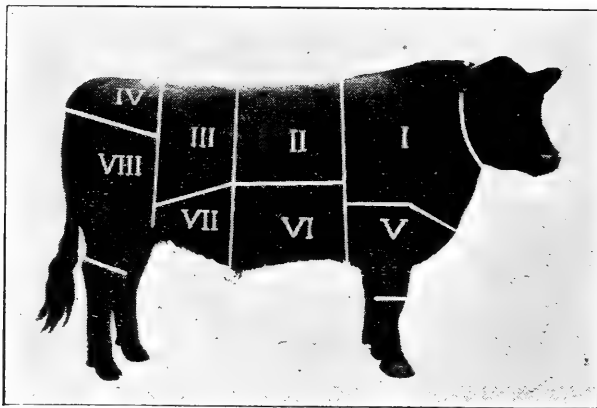

Figure 30.—Beef type, showing market cuts. I, Chuck; II, Prime of rib; III, Loin; IV, Rump; V, Shank; VI, Plate; VII, Flank; VIII, Round. Photograph from Prof. C. T. Conklin.

the best and grading toward the poorest, these grades with meat stock in general, in each class, are as follows: prime, choice, good, medium, common, inferior. Some other terms are often used, such as extra prime, good to medium,

etc. These special terms, of course, are used to express the relative values of animals of the same general class. A prime steer, for example, is one with the largest amount of high-priced meat that the butcher thinks will cut out to the best advantage. So, in the prime animal the buyer looks for a wide back, deep body, thick, meaty hind quarters, and a frame entirely covered with a smooth, thick layer of flesh that will cut up well with as little offal as possible. To ensure small waste, an animal must be what we call well-fattened,

and have no coarseness or heaviness of bone. As one goes down the line of grades, each of these desirable features is less to be seen. Thus an inferior steer would show a small percentage of high-priced cuts, would lack in condition and quality of flesh, and show much waste at slaughter. These grades have the same relative importance in live stock as similar terms have in grading corn or wheat. For comparison, we have dent corn for one type and sugar corn for another. Dent corn we classify into white and yellow, and then grade each of these as No. 1, No. 2, No. 3, etc., the best being No. 1, comparable to the term prime in live stock. Put in a simple diagram, the relation of the classes and grades may be shown as follows:



Figure 31.—The wool producing type. Photograph by the author.

CLASSES—	GRADES—																								
BEEF TYPE	<table style="border: none;"> <tr> <td style="font-size: 2em; padding-right: 5px;">{</td> <td style="padding-right: 5px;">Beef cattle.....</td> <td style="font-size: 2em; padding-right: 5px;">}</td> <td>Prime</td> </tr> <tr> <td style="font-size: 2em; padding-right: 5px;">{</td> <td style="padding-right: 5px;">Butcher stock</td> <td style="font-size: 2em; padding-right: 5px;">}</td> <td>Choice</td> </tr> <tr> <td style="font-size: 2em; padding-right: 5px;">{</td> <td style="padding-right: 5px;">Stockers and feeders</td> <td style="font-size: 2em; padding-right: 5px;">}</td> <td>Good</td> </tr> <tr> <td></td> <td></td> <td></td> <td>Medium</td> </tr> <tr> <td></td> <td></td> <td></td> <td>Common</td> </tr> <tr> <td></td> <td></td> <td></td> <td>Inferior</td> </tr> </table>	{	Beef cattle.....	}	Prime	{	Butcher stock	}	Choice	{	Stockers and feeders	}	Good				Medium				Common				Inferior
{	Beef cattle.....	}	Prime																						
{	Butcher stock	}	Choice																						
{	Stockers and feeders	}	Good																						
			Medium																						
			Common																						
			Inferior																						

All markets do not have exactly the same classes and grades of stock. The larger a market, the more the dealers divide animals into classes and grades, for the widest demand for different kinds here exist. In the small market not so much attention is paid to the details of class; but the dealers are quick to recognize the merits of a grade. In some markets we find the people more interested in one kind of stock than another. St. Louis is a noted horse market,

Buffalo has long been famous for sheep, and Chicago is the great hog center. These large markets, to a certain extent, require other markets, through a live-stock exchange, to classify and grade animals so that selling values are fairly comparable. In small towns without regular markets, merit in an animal is easily seen by men who buy if they have a fair knowledge of type and its meaning.

A knowledge of animal type is necessary if one wishes to understand why some animals serve one purpose and some another. There is a distinct relation of the form of the animal to its special use. The race horse is light of body,

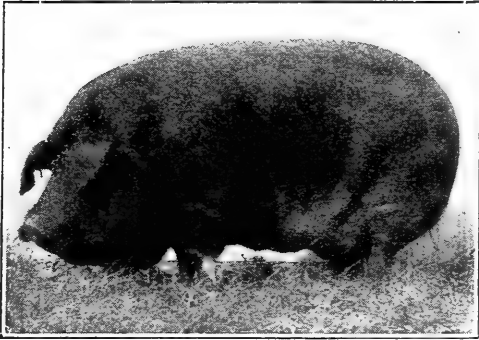

Figure 32.—The lard hog type. Photograph by the author.

narrow but deep of chest, has splendid lung capacity, has slender but strong legs, is very muscular, and is built for speed. The Arab horse, the British Thoroughbred, and the American trotter each has these features well marked, if he is a good specimen of the type. The less he has of these

qualities, the poorer he is as a race horse. A Merino sheep of the A type is rather narrow of back, long of rib, has short fine legs, is very muscular, and the entire body, including head and legs, is heavily covered in folds with a fine, greasy fleece. This type of sheep is formed to produce wool, and has very little value as meat. The Merino sheep of Spain, of Australia, or Ohio, if of the A type, are all similar, each producing wool of the finest sort. The more the inclination to mutton development, the less fine and heavy is the fleece. The hog best suited to lard production has a short neck, wide back, deep sides, large hams, and short legs; and when well fattened, his body is covered with a thick layer of fat.

This type of hog has been bred in America to produce fat in the extreme. The narrower his back, the longer his head, neck and legs, the less fat meat will he produce. The race horse, the Merino sheep and the lard type hog, each has been bred to serve its special purpose. The intelligent stockman can tell at a glance whether the animal he is looking at with the thought of purchase is of a desired type, whether it will command a high place in the market for value, or if its merits are such as to attract no special interest. The animals which most nearly represent the type are fewest in numbers, and bring the highest prices. One reason why we do not have more animals of the better kind is because farmers and stockmen themselves do not know the importance of type. Before one is capable of becoming a high-class breeder or feeder of live stock, it is necessary to understand this subject. One must know the relation of animal form to the purpose it will best serve.

AMONG OTHER THINGS, KEEP IN MIND

1. How they shipped cattle to market in early days.
2. The reason for studying animal form.
3. The meaning of the word "type."
4. The meaning of commercial classes of stock.
5. The relative importance of the grades of stock.
6. The class of stock in which certain markets specialize.
7. The relationship of form to purpose.

SUPPOSE YOU MAKE THESE OBSERVATIONS

8. How meat animals are shipped to market in your vicinity.
9. What market classes are reported in your local paper.
10. What types of horses do you find on the streets about town?
11. Compare the horses on the farm with which you are best acquainted.
12. What type of horse is most in demand near your home?
13. Which is the more popular, beef or dairy type in your county, and why?
14. Are there any feeders of stock within your acquaintance, and, if so, what type or types are they feeding?

CHAPTER XV

THE BREEDS OF HORSES

The origin of the horse was for many years not well understood. It used to be thought that the domestic horse was descended from the wild ass that lived in Africa and Asia. It is now pretty well agreed that the horse of to-day is descended from animals that lived in past geological times. Fossil remains of horses have been found in different parts of North and South America and in Europe. These are known as prehistoric horses, because they lived on the earth before man left any recorded history.

The prehistoric horse in the earliest geological times, say, three million years ago, was very small. He was probably about as big as a fox terrier, and is known as the "dawn horse." During the development of the earth's surface, the prehistoric horse passed through gradual and very important changes. There was an increase in size, and his body, legs, and head became more and more like those of the modern horse. The skeletons of these early horses have been found in different parts of the world, but more especially in North America, in the far West, in Wyoming and the Bad Lands of that section. Scientific men have put the fossil parts of these horses together so completely that their development is clearly understood. From this first period up to the last, skeletons more or less complete have been found, showing the gradual increase in size and general development through which this prehistoric horse passed. In the **American Museum of Natural History** in **New York City** is a remarkable collection of skeletons of the horse, from the earliest form through the several stages up to the present day form. These prehistoric skeletons are grouped in their

natural order, thus forming a most instructive collection.

So we know that the horse has lived in America for millions of years. Before the time of Columbus and the early explorers nothing is known of the use of domesticated animals either in North or South America.

The first use of the horse by man is supposed to have



Figure 33.—A wild pony captured in Central Asia, owned by the New York Zoological Park. Photograph by Edwin R. Sanborn.

been for food. Later he became domesticated, and was used for bearing burdens on his back. There are some forms of ponies at the present time that are supposed to be closely related in appearance to the more recent prehistoric horse. Some years ago in central Asia, true wild horses of pony size were discovered by a famous Russian explorer. These and

the rough ponies of Iceland and northern Europe are probably closely related to the later form of prehistoric horses.

The development of the breeds of horses has been due to different conditions. Climate, food, and man, have each had a very important influence. A mild climate and abundant food no doubt caused the horse to become gradually larger than where the climate was cold and food not abundant. The Shetland pony comes from a region in the North Sea where the weather is very severe and food is never plentiful. So this pony on its native island is very small. In his American home, however, on the western prairie, where food is abundant, and the climate mild, he develops into a greater size. The horses from hot climates have always been more active than those from cold. Thus in northern Africa the Arab horse has developed into an animal full of grace and activity. So we see that breeds probably gradually developed in certain localities, and that different causes helped to bring about the final result. There are many breeds of horses and ponies in different parts of the world. The following, however, are the only ones common in America, that should especially interest us.

The Arab horse originated in the desert region of northern Africa, where it has been known since long before the time of Christ. The Arab is a saddle horse, but usually is a pony in size. The horses from Arabia and the Orient have had a great deal to do with the improvement of the horse in Europe. Between 1700 and 1800, many Oriental horses were taken to England. Their blood was mingled with the horses of that country, and especially with the race-horse type, by which a great improvement in form and speed was secured. Arab horses should be from 14 to 14½ hands high, have beautiful, intelligent heads; backs especially suited to the saddle; and have strong, muscular quarters and legs. The pure Arabian may be gray, white, bay, chestnut, or black. He is not of special value in America. He was first brought

to this country about 1760, though but few pure-bred ones are here now, and the breed has not grown in favor. The white or spotted horses often seen with circuses are rarely pure-bred, and perhaps come from Turkey, Barbary, or elsewhere in the Orient, or have been foaled in America.

The Thoroughbred horse is of British breeding. In early days in England the horse was used largely for war. He had to be strong, in order to carry men who wore heavy coats of mail. After armor became unpopular, the people began to make more use

of horses for other purposes. King James I., at the beginning of the 17th century, established the race track, and since then horse racing has been very popular in that country and in France. It was then that the development of the Thoroughbred began. The people wanted a race horse. They took their native light horses

that showed speed and improved them by the use of Arab, Turk, and other racing blood imported from Africa, Turkey, and France. The people became much interested in breeding these running horses, and, as a result, developed the Thoroughbred into the fastest and best-bred horse in the world. Three imported Oriental horses, the Darley Arabian, the Byerly Turk, and the Godolphin Barb played a most important part in improving the early race-horse stock in England. Descended from these were three English-bred horses, Herod, Eclipse, and Matchem, that are very famous ancestors of modern Thoroughbreds. This breed of horses has a fine, lean, medium-sized head; a long, slender neck; a



Figure 34. Thoroughbred horse, Hanover, one of the greatest American sires of the breed. Photograph by the author.

narrow, deep chest; a long, sloping shoulder; a short, strong back; very long, muscular hind parts; and legs that are short, lean, and strong, with the best of feet. The skin is thin, and the hair fine and silky. The most desired height is 15 to 15½ hands, and the most common colors are bay, brown, chestnut, or black, though there are other colors. A fine disposition and great courage are features of this noted breed.

The Thoroughbred was first brought to America in 1730, and since then, until recently, large numbers have been imported. This horse is raced under the saddle with a man called a jockey on his back. The fastest record of a horse race of any kind was made by Roamer at Saratoga, New York, in 1918, he running a mile in 1:34 4-5. Thoroughbreds have sold for enormous sums, a number of them having changed hands at prices ranging from \$100,000 to \$200,000. The Thoroughbred has been much used in the past in America to improve our racing stock, but at present is not popular excepting for running races in which gambling is a prominent feature. As betting at horse races is to-day a violation of the law in most states, this fact has done much to discourage the breeding of Thoroughbreds in America. In England and France, conditions are different. This breed has had a great history, and it is unfortunate that it can not be popular in America, except as connected with gambling. Many persons in speaking of live stock use the word "thoroughbred," when they mean *pure-bred*. Thoroughbred, as applied to animals, is correct only when referring to this breed of horses, which fact the student of live stock should remember.

The American saddle horse is a breed that has developed in the United States, especially in Virginia, Kentucky, Tennessee, and Missouri. Its ancestry comes with the mingling of the blood of the Thoroughbred and well made, easy-moving, native saddle stock. A Thoroughbred horse named Denmark, sired by an imported horse, was one of the most famous early sires of this breed. The American saddle

horse shows much style in carriage of head and arch of neck and tail. He stands from 15 to 15½ hands high, and often weighs about 1,000 pounds. His most frequent colors are bay, brown, or black. This breed of horses is growing more and more into favor on account of its extremely easy gait. Saddlers may be divided into two classes. One has the walk-



Figure 35.—American Saddle Horse, Kentucky's Choice. Photograph from *The National Stockman and Farmer*.

trot-canter gaits common with all saddle horses. The other class has five gaits, the walk-trot-canter, the rack, and the running walk, or fox trot, gaits especially found with this breed. If a horse can show these five gaits, he is called a *gaited horse*. If he has only the first three, he is known as

plain gaited. American saddle horses are very popular in certain parts of the country. Those of the better class, and educated to show their gaits well, bring high prices. In 1913 the horse My Major Dare sold for \$10,000.

The American trotter or pacer has its origin in the light-weight trotting and running horses of Great Britain first brought to America. One of these, a Thoroughbred named Messenger, imported in 1788, through his great-grandson, Hambletonian 10, did much for trotting blood. For many years we have had in this country what are known as *light harness horses* which are commonly referred to as trotters. They were so called because, when they moved faster than a walk, their gait was a trot, a movement of the front foot on one side and the hind foot on the opposite side at about the same time. The pacer moves back or forward at the same time, the feet on the same side of the body. The pace is about three seconds faster as a gait than the trot, but is not regarded as an attractive movement. Occasionally a horse may be taught to trot or pace as desired. Some famous race horses have both trotting and pacing records.

The trotter or pacer is not a true example of a breed, because he has been mixed so much in the past in this country with all kinds of blood ancestry. The principal idea seems to have been to get speed. Trotters of this sort are often referred to as "Standard Bred." That means that they have official records of 2:30 (2 minutes, 30 seconds), or better, or are from stock registered in the American Trotting Register. A nice type of trotter or pacer should weigh around 1,000 pounds, and have a lean, intelligent head; a refined and graceful neck; sloping, well laid shoulders; be narrow on top over the shoulders; have a strong, fairly level back; a muscular rump with tail set high; a deep, round body; and legs short, clean, and fine-boned and good feet. This horse picks up his feet with snap, and moves off smoothly and easily. The coat is of different colors, with bay or

brown most common. The disposition is generally good, though it naturally varies. This American-bred horse is the fastest trotter in the world. Peter Manning holds the world's trotting record for the mile, in $1:57\frac{3}{4}$ (one minute, $57\frac{3}{4}$ seconds); and Dan Patch the pacing record of $1:55\frac{1}{4}$ for the same distance. During 111 years, from August 25, 1810, when a horse named Boston trotted a mile in $2:48\frac{1}{2}$, to October 6, 1921, when Peter Manning trotted a mile in $1:57\frac{3}{4}$, the mile trotting record was reduced $50\frac{3}{4}$ seconds, or an average of hardly one half second a year. Lou Dillon, a beautiful little mare, long held the trotting record in a race against time, making a mile, in 1903, in $1:58\frac{1}{2}$. This record, however, was made with the aid of a shield to keep the wind from affecting her speed. There are many kinds of records, as half-mile, mile, two-mile, fastest new performer, fastest mare, etc. Thousands of horses have trotted a mile in $2:30$, or better, and many even as fast as $2:10$.

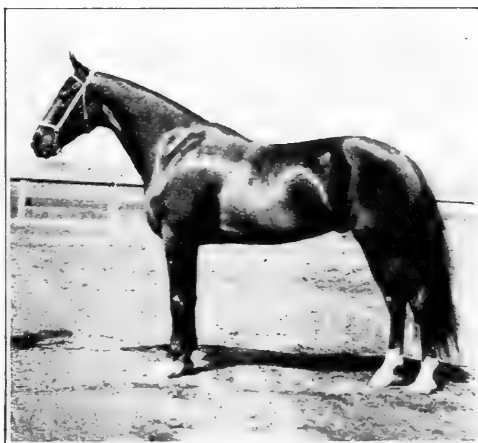

Figure 36.—Trotting horse Uhlan with record $1:58$. Photograph from *National Stockman and Farmer*.

There is a number of famous trotting and pacing families, of which the Hambletonian, Mambrino, Clay, Pilot, Hal, and Morgan are the best known. Among the most famous trotters that have lived in recent years are the following: Maud S. $2:08\frac{3}{4}$, Nancy Hanks $2:04$, Cresceus $2:02\frac{1}{4}$, The Harvester $2:01$, Lou Dillon $1:58\frac{1}{2}$, Uhlan $1:58$, and Peter Manning $1:57\frac{3}{4}$. Among pacers are Hal Pointer $2:05\frac{1}{4}$, Star Pointer $1:59\frac{1}{4}$, Minor Heir $1:59$, and Dan Patch $1:55\frac{1}{4}$. Trotters and pacers have sold for very high prices. Arion,

the trotter, sold for \$150,000, and Dan Patch, the pacer, was purchased for \$60,000. The automobile has largely displaced the trotting and pacing horse, so that they now have no great value outside of purposes for which horses of light weight can be used, such as driving, racing, and in certain kinds of business where no special draft power is required. Our people would be much better off to-day if we raised but a limited number of light harness horses, and only the higher class ones at that. Unless exhibiting remarkable speed, they command very low prices.

The Hackney horse is a breed that was first produced in eastern England, especially in Suffolk and Norfolk counties. In these regions the trotting gait has long been popular. The claim is made that this breed began important development about 1755, with a horse called Shales. He traced back to the Darley Arabian, to which the Thoroughbred is related. The Hackney is very common in England, but not in America. It is a breed that varies considerably in size, ranging from a pony to a good-sized carriage horse. When of suitable size, standing about 16 hands high, it is what is known as a heavy harness or carriage horse. A Hackney of good type is very attractive of head; has a long, arching neck; a fuller chest than a trotter; is strong and short of back; has a long, full-rounded hind quarter; a beautiful round, smooth body; and stands squarely on short, clean-cut legs, and good feet. Chestnut is a very popular color, as is bay, and brown. This horse is noted for the powerful manner in which he moves the legs in the trot. He has a bold stride, lifting the knees higher than any other breed, and carrying the hind legs forward with distinct power. The Hackney gait is a model in the opinion of many lovers of high-class carriage horses. If he is what is termed a high actor, that is, moves his knees up high rather than far forward, he will have a short stride which is somewhat slow, and is termed a "trappy gait." The movement is both ugly and undesirable.

The Hackney in his native land is rather noted as a horse with considerable speed, and most excellent records have been made in driving over country roads. This is the most popular breed in the stables of wealthy men who keep fine carriage teams, but in recent years the automobile has greatly injured the business of breeding such horses. No breed of coach horse is popular in America, and this is the only one at the present time that should be seriously considered. The Hackney has been extensively distributed over Europe, North and South America, and Australia.



Figure 37.—A Hackney in harness, giving a striking exhibition of action. Photograph from S. L. Howe, British Columbia.

The Percheron horse is of French origin. There is a small section of France called the Perche, which is nearly 100 miles southwest of Paris. It is a beautiful, rolling, or hilly, country, where the farmers have fine water, sweet grass, and fertile fields. In this region the Percheron originated. The breed is very old, and no doubt it has passed through important changes during the past century. Fifty years ago Percherons were not as big as now, and they could trot quite fast along the highways. The demands of Americans during the past 25 years have caused the French to develop a larger

size in these horses. It is now much the most popular draft breed in America. Mature stallions in ordinary condition weigh from 1,700 to 2,000 pounds, or more, and mature mares from 1,600 to 1,800 pounds. The height of stallions is from 16 to 17 hands, with mares slightly less. The color is usually either gray of some shade or black, though bay,

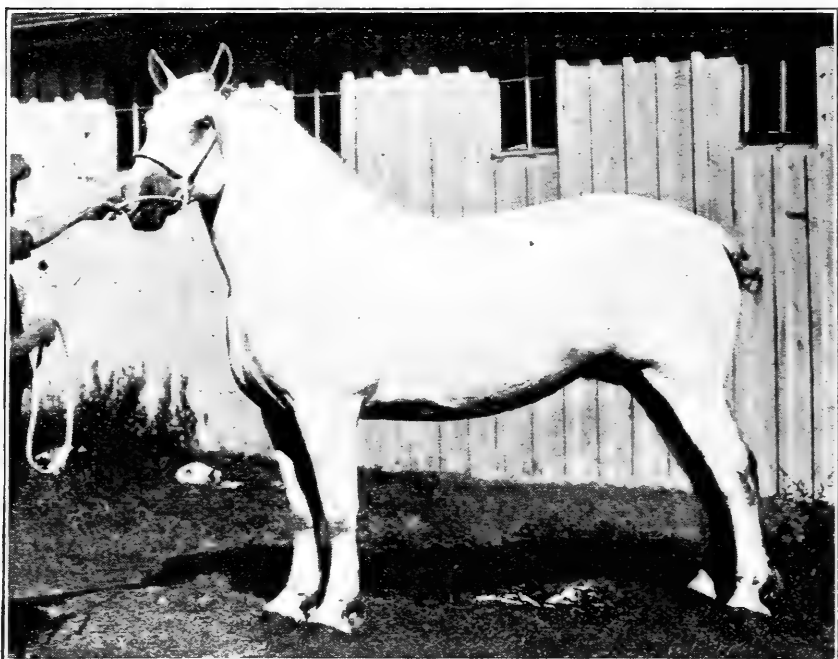

Figure 38.—Percheron mare, La Belle, a noted prize winner and brood mare, owned by W. H. Butler, Sandusky, Ohio. Photograph by Hildebrand.

brown, or chestnut occurs occasionally. These horses are very massive appearing, when of the best type, having big bodies, strong wide backs, powerful hind quarters, muscular legs, and splendid feet. The legs are free from long hairs, this being one of the smooth-legged breeds. The foot is shapely, of fine texture and proper size. Good specimens have a very active gait and move off well with a load.

No other draft breed in America has so many representatives as has this one. These horses are most abundant in

Illinois, Iowa, Ohio, Kansas, Nebraska, Minnesota, Indiana, and South Dakota, in about the order named. The two leading centers in the United States are in Delaware County, Ohio, and Tazewell County, Illinois. During the World War some of these horses were taken from France to England, where they have grown greatly in popularity. In spite of the depression in the horse industry, due to the automobile, good Percheron horses have been in demand at very satisfactory prices. Many work horses showing considerable Percheron character, have sold at from \$400 to \$500, and in 1910, Crouch and Son, of Indiana, bought a pair of Percheron geldings for \$2,025, a record price. The stallion Carnot, a noted prize winner and sire in France and America, was bought by W. S. Corsa, of Illinois, for \$10,000.

The Clydesdale horse is a breed that was developed in southwestern Scotland, where it has been known since about 1715. The Clydesdale is not quite so large as the largest draft breeds. It has certain features that perhaps are notable. To begin with the feet, they must be large, round, and wide behind at the heel, with a good, elastic frog. The bones of the legs should be hard and not round and meaty, but the arms and quarters must be heavily muscled. The Scotchman thinks his horse has the best of feet and legs, and, when either walking or trotting, that he has the best movement of any draft horse. It is a fact that many Clydesdale horses move with splendid action and carry their feet with snap and trueness. This is a hairy-legged breed, with long hair on the back of both front and hind legs from the knee and the hock down. The body of the Clydesdale is often deficient in massiveness, so that these horses appear shallow of body and correspondingly long of leg, the principal criticism of this breed to-day. The shoulders usually slope well into the back, which fact accounts for the easy movement of this horse. The color is usually bay or brown, with white markings on the face and on the lower

part of the legs. There are also chestnut, black, and grays occasionally to be found. The height is about $16\frac{1}{2}$ hands for the matured males. Typical Clydesdale mares weigh from 1,600 to 1,700 pounds, and the males two or three hundred pounds more.

Clydesdales were first brought to America in 1842, being taken to Canada, where they are quite common to-day.

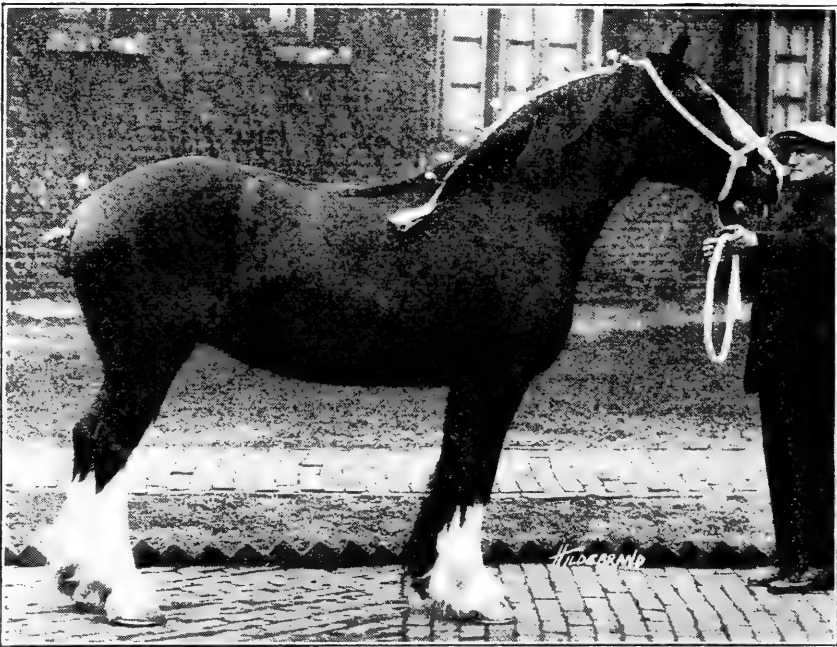

Figure 39.—Clydesdale mare, Fairholm Ruth, grand champion at 1918 International Exposition. Bred by R. A. Fairbairn of New Jersey. Photograph from Mr. Fairbairn.

The breed has a wide distribution in the United States, though it has not grown in popularity in this country, and there are comparatively few horses of the breed in any one state. Wherever the Scotch farmer has settled, we are likely to find these horses. The stallion Baron of Buchlyvie in 1911 sold for \$47,500, which is the record price of the breed.

The Shire horse is an English breed of much the same general character as the Clydesdale. It is one of the oldest

breeds in England, and is as popular with the Englishman as the Clydesdale is with the Scotchman. These horses differ in certain important respects, though they have the same color and markings, as a rule, and both have the hairy legs. The Shire is a somewhat larger and more massive breed than the Clydesdale, and has a wider back and deeper, heavier body. Mature stallions should stand about 17

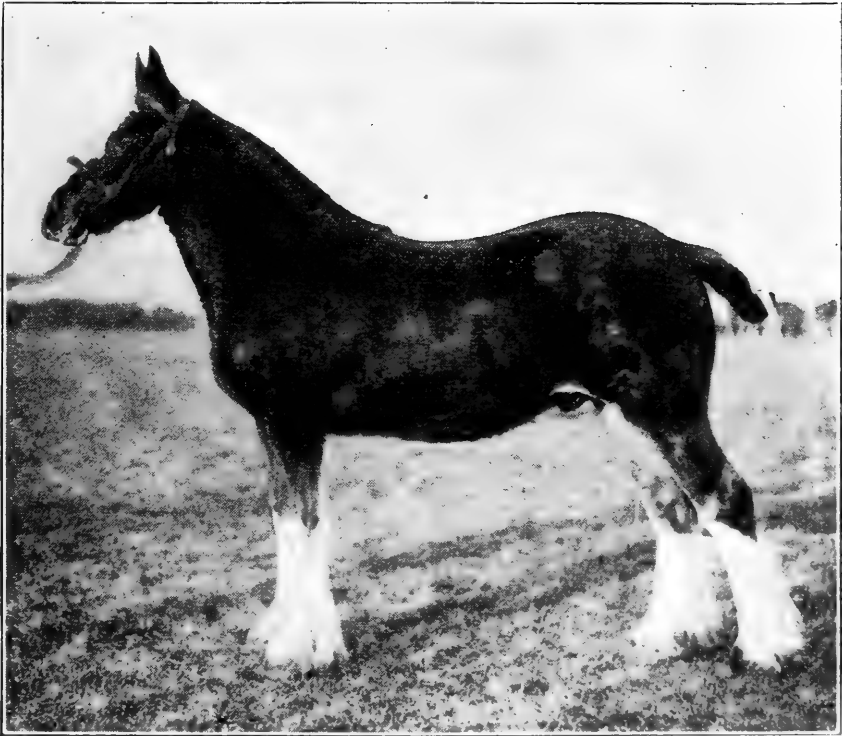

Figure 40.—Shire stallion, Rosco V, in yearling form, owned by University of Illinois. Photograph from Prof. J. L. Edmonds.

hands high and weigh from 1,800 to 2,000 pounds in ordinary condition. For many years the Shire was regarded as very slow in movement, and lacked good action and quality. In recent years, English breeders have done much to improve it, and the criticisms of slow movement and coarseness are not as correct as they once were. The criticism due to

the hairy legs is still made, and this breed, like the Clydesdale, is not at all common in America. These horses have been brought to America in small numbers since about 1836, when one was brought to Canada. Perhaps more of these horses are in Illinois and Iowa than in any of the other states. In 1910 a Shire stallion named Dan Patch sold at Chicago for \$10,000. In England these horses have commanded very high prices, and in 1913 the stallion Childwick Champion sold for \$20,664.

The Belgian horse comes from one of the smallest countries in Europe. Belgium has done much to improve the draft horse, and the government has paid out large sums of money to develop the breed. The people take much interest in their horses, and their annual draft-horse shows in Brussels are among the greatest exhibitions in Europe. Draft horses have been bred in Belgium for a very long time. Since 1850, however, the most marked improvement has taken place. The Belgian is a very compact, wide, deep, short-legged sort of draft horse. He has a small head, perhaps, for his size; has a broad chest; very wide, short back; a deep body; a rump which may be quite wide and muscular, yet somewhat steep; very heavily muscled, short legs; and medium-sized feet which have been criticised sometimes as being too small for such a heavy horse. The legs, like those of the Percheron, are free from hair. The Belgians show considerable activity when in motion, and are powerful draft animals for their weight, which ranges from 1,600 to 2,000 pounds, usually, according to sex. They stand about 16 hands high. In disposition these horses are very gentle and can be easily handled. Their color is usually bay, brown, chestnut, or roan. These horses were first brought to America in 1866. In recent years, a great many Belgians have been imported, and the breed has grown much in favor, being second in this regard, probably, to the Percheron. It is getting quite a foothold in the middle-western states.

During the World War the Belgian people suffered great losses through German confiscation of their horses, as they also suffered from destruction of their breeding operations. Some of the best horses, however, were taken to Holland, France and England early in the war, and these were carefully guarded, and later were returned to their own country. Once again the horse industry of Belgium is coming back to normal, and will soon be as firmly established as ever.

The Suffolk horse is an English draft breed that has been bred mainly in Suffolk county, on the east coast of

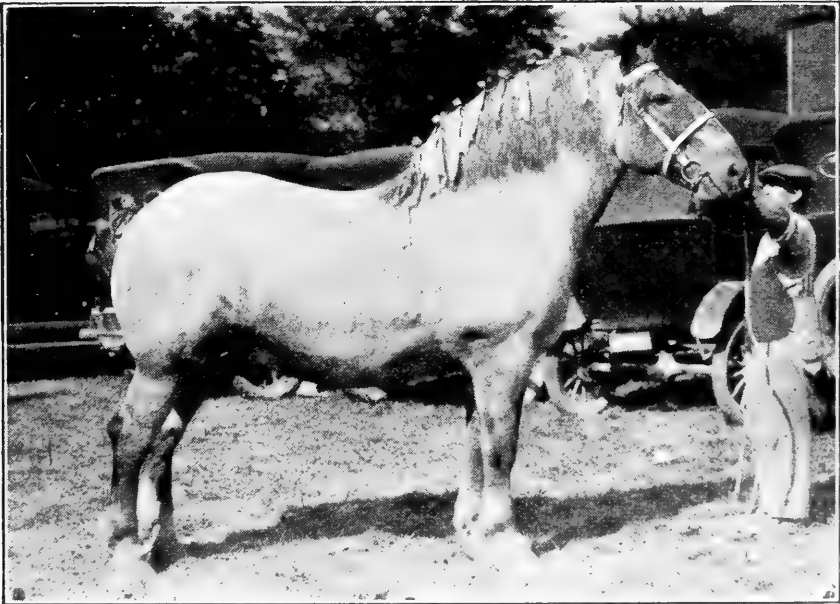

Figure 41.—Belgian stallion, John De Boise, champion at Ohio State Fair, 1920.
Photograph by J. C. Allen.

England, since about 1770. This is a very distinct breed. The color varies from light to dark chestnut, with slight white marks more or less, such as a star or blaze on the face, or white pasterns and ankles. Other characteristic features are the tendency to a Roman nose and small ear; an uncommonly wide, deep body, showing a paunchy tendency; strong quarters and hocks; freedom from long leg hairs; and

rather small feet for the size of horse. The height ranges from 16 to 16½ hands, and the weight from 1,800 to 1,900 pounds when in good condition. But few Suffolk horses have been brought to America, and the breed is not well known here. It is noted in England for its steadiness at draft work, and horses of the breed created much favorable comment by their work in France in the territory occupied by artillery in the World War. In recent years Suffolks have grown much in favor in England outside of their native county, and bid fair to receive more favorable consideration by American horsemen.

The Shetland pony has its native home on the Shetland Islands, about 200 miles north of Scotland. These are very

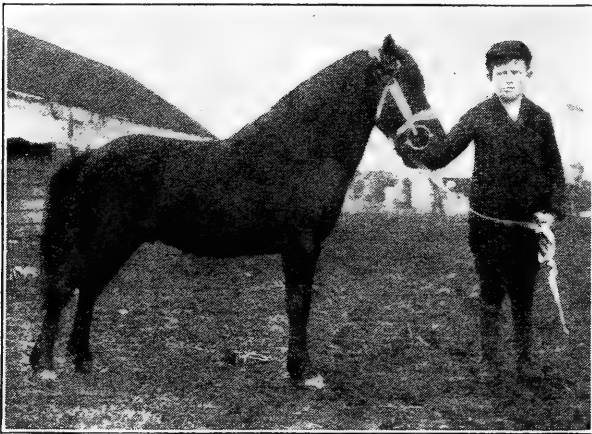

Figure 42.—A Shetland Pony, first prize at the Highland Show, Scotland. Photograph by the author.

rocky islands, and produce but little feed for live stock. The climate is very cold and rough, and the winters are most severe. There are about 120 islands, with a total area of approximately 550 square miles, and Mainland is the

largest of these. These ponies have been bred here perhaps for centuries. They vary quite a good deal in type. The best sort of Shetland stands from 36 to 42 inches high, and is a shaggy, drafty-looking little pony, especially in the winter. These ponies should show some of the characteristics of miniature draft horses, with full chests, wide backs, long ribs, and long, wide, level rumps. The modern type, however, is less drafty than formerly, with considerable tend-

ency to the carriage type. The head should not be too fine, and should have a broad forehead, and a nice, open, clear eye, showing the pleasant disposition usual with ponies of this breed. There are different colors, but bay, brown, and black are most frequent. Shetland ponies are common all over eastern America, and are great favorites with children. They are very patient and are safe pets for children of comparatively early age. In England, large numbers have been used in the coal mines to haul cars loaded with coal.

The ass is commonly referred to in America as the jack, this being the male, while the female is known as the jennet. This animal is descended from the wild ass of Africa and Asia. There are several breeds of the domestic ass, most of which were introduced to America from Spain. During the Revolutionary War, George Washington was presented with a male and female ass by the King of Spain. The American parent stock has largely come from Andalusia and Catalonia, Spain, and from Poitou, France. The jack usually stands about 15 hands high, and the jennets 14½. A weight of about 1,000 pounds is desirable for the jack. The hair is usually brown or black and sometimes gray, with a creamy shade around the muzzle or along the underside of the body. The ass has long, large ears, rather a large head for the body, a short, stubby mane, a round but not very large body, rather large legs, and small feet. The tail is fine, with simply a brush at the end. This animal is slow of movement, very patient, and is a beast of burden used mostly among poor people of southern Europe and parts of Africa and Asia. In America it is but little used excepting for breeding, and it is principally promoted and kept in Kentucky, Missouri, and the southern states.

The mule is the offspring of an ass and a mare. Mules differ much in size and value, and have features of both parents. The head, mane, tail, and feet resemble those of the ass. The mules also bray like the ass. Mules show more

fineness of bone and more activity than the ass, and are used mostly for draft purposes. Large, strong, heavy mules are worth more money than small ones. The best mules resemble the high-class draft horse in form. In the mule markets, these animals are classed according to their size and use, as plantation, lumber, railroad, mine, and levee mules. Plantation mules are especially suited to draft and farm work. There are two subclasses of plantation mules,—Sugar and Cotton. Sugar mules stand from 16 to 16½ hands high, weigh from 1,100 to 1,400 pounds, and are



Figure 43.—Donkey and a load of peat at Kildare, Ireland. Photograph by the author.

breedy looking and show quality and excellent bone. Cotton mules stand from 13½ to 15½ hands, weigh 900 to 1,100 pounds, and are not of so high quality as Sugar mules. St. Louis is the largest mule market in America. The average price for mules is higher than that for horses. Mules are invaluable for draft purposes, and are commonly used all over the southern states. They are more easily kept than horses, and possess more endurance and are always patient.

QUESTIONS AND SUGGESTIONS

1. What was the earliest form of the horse, and where was it found?
2. Give some of the conditions that influenced the development of breeds.
3. Why were Herod, Eclipse, and Matchem famous?
4. What is the difference between Thoroughbred and pure-bred.
5. Describe a Hackney horse and his gait.
6. Where is the Perche, and what is the nature of the country?
7. Describe a modern Percheron.
8. In what respect does the Scotchman think the Clydesdale a superior horse?
9. How do the Clydesdale and Belgian differ in color?
10. Tell of the Shetland Islands and their ponies.
11. Describe the special features of the ass.
12. What breeds of horses are found in your neighborhood?
13. Learn, if possible, of the most important draft horse that has been known in your community. Why was he important?
14. Find out the breeding, if any, of the saddle horses in use in your neighborhood.
15. Who owns the largest mule in your neighborhood? Can you give his height and weight?

CHAPTER XVI

THE POINTS OF THE HORSE

The exterior parts of the horse are referred to by horsemen in terms not familiar to all. In order to judge intelligently and to use the score card, one should know the location and importance of these special parts. The accompanying illustration makes the location of many of these clear. Without going into too much detail, the following is given regarding some of the points least understood.

The ears should be fine and not large for the animal, and be moderately close together. They should be carried in an alert, pleasing manner, indicating good disposition.

The poll is the top of the skull just back of the ears.

The forehead is the space below the ears and above the eyes. A prominent forehead indicates intelligence.

The cheek is the large flat side of the lower jaw.

The nose is the more prominent part between eyes and nostrils. A wide nose goes with full breathing capacity.

The muzzle includes the nostrils and mouth. Good feeders and animals of strong constitution usually have comparatively large muzzles.

The lower jaw should be wide and strong. A narrow jaw bespeaks a weak conformation and an inferior feeder.

The crest is the curved line of the neck from the poll to the withers. Males should show some crest, but on the females this feature is not prominent. Stallions frequently have a thick, muscular neck, with a strong crest. This is a sign of masculinity, and is objectionable on mares.

The throat latch is the part where the head and neck join on the lower side. At this point the throat should be neat and clearly defined. A throat latch that is thick and

full, is regarded as ugly and very undesirable, being usually associated with more or less restricted breathing.

The shoulders extend from the side of the breast, sloping nearly to the top of the back. The upper portion of the shoulder blade is wide and flat, and should be smoothly laid into the body. Muscles are attached to the shoulder blades and play an important part in ease of motion. A long, sloping, well laid-in shoulder gives the easiest and fastest motion.

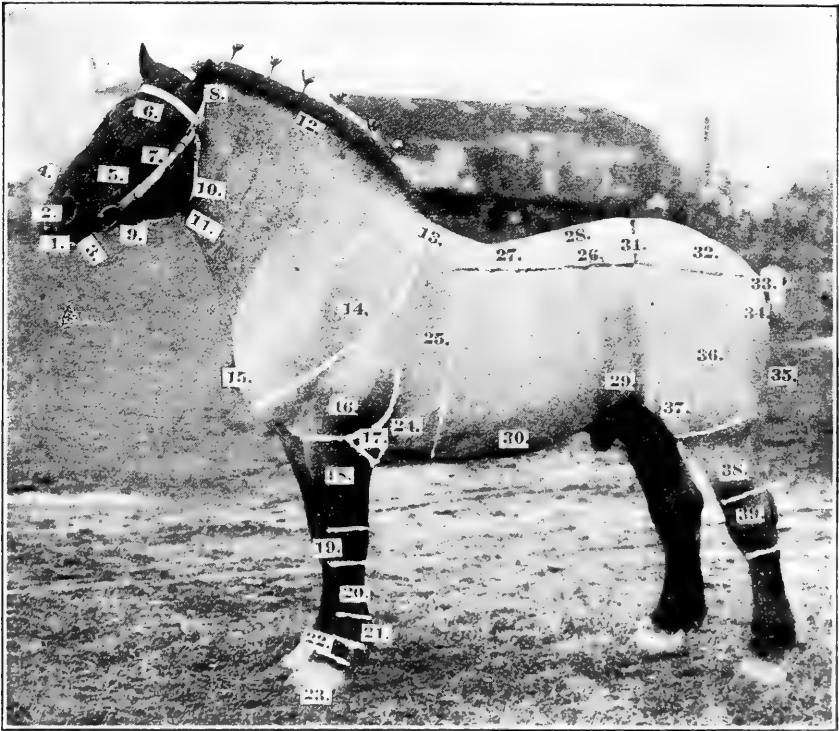

Figure 44.—*The points of the draft horse:* 1, mouth; 2, nostril; 3, chin; 4, nose; 5, face; 6, forehead; 7, eye; 8, ear; 9, lower jaw; 10, throat latch; 11, windpipe; 12, crest; 13, withers; 14, shoulder; 15, breast; 16, arm; 17, elbow; 18, forearm; 19, knee; 20, cannon; 21, fetlock joint; 22, pastern; 23, foot; 24, fore flank; 25, heart girth; 26, coupling; 27, back; 28, loin; 29, hind-flank; 30, belly; 31, hip; 32, croup; 33, tail; 34, buttocks; 35, quarters; 36, thigh; 37, stifle; 38, gaskin; 39, hock.

The withers, the crested, bony prominence between the shoulder tops, is the name given to the spine at this point. This part is important, being the point of attachment for

the ligaments or muscles which support and move the head and neck, move the shoulder blades and extend the ribs forward, promoting deep breathing and providing a powerful support to the entire back along the vertebrae.

The arm is the wider, more muscular part just below the shoulder. The width and covering of muscle of the arm, rather than its length, indicate its strength.

The forearm lies just below the arm and extends to the knee, and should be long and broadly muscular. A thin, narrow forearm is regarded as a weak conformation.

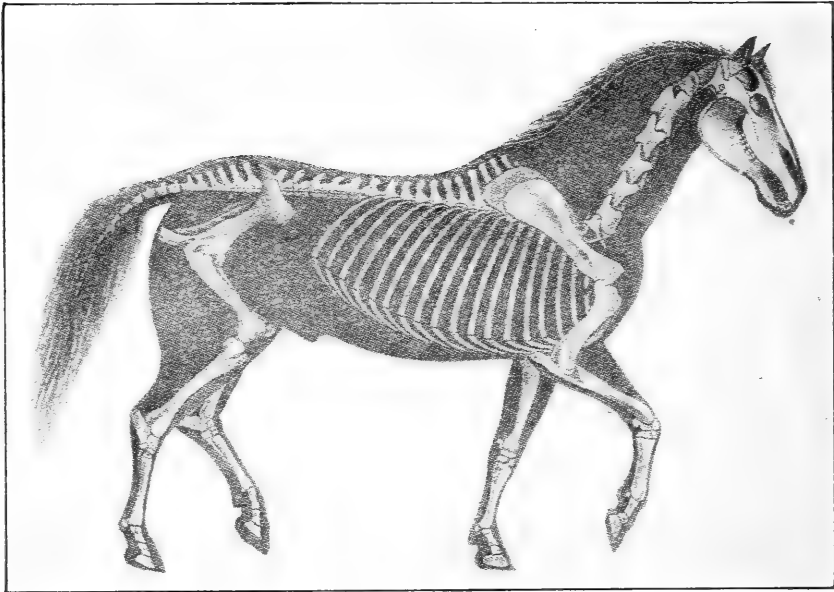

Figure 45.—The relationship of the skeleton of the horse to body conformation. Reproduced from "Diseases of the Horse," U. S. Dept. of Agriculture.

The knee should be broad in front, straight in position as viewed from in front, have a good depth, and be strongly supported below with a well-placed, superior cannon bone.

The cannon bone reaches to the joint above the foot, and consists of a round-fronted bone, with two small bones back of it. There are two tendons lying directly back of the cannon bone. The correct shape for the cannon bone is short

and somewhat flat, an important feature of a strong conformation. It is especially desirable that the bone below the knee be wide, and but slightly cut under at the knee.

The fetlock joint connects with the lower end of the cannon bone. This joint should be straight, deep through, and blend neatly and smoothly with the pastern below.

The pastern is in the main a combination of two short bones, and should stand at an incline, because it plays an important part in breaking the concussion which takes place when the horse is in motion. The shorter and more upright the pastern the more liable is the horse to have bone diseases and a hard gait. Carriage horses should have the pastern show a slope of about 45 degrees. Drafters are usually steeper of pastern than the light horse and consequently are often somewhat clumsy of gait. The pastern is sometimes too long, and lacks the strength to support the body correctly.

The foot consists of several parts. The hoof proper is a very tough, horny bone, and in form should be rather round, although the hind foot is never as round as the one in front. The top of the hoof should not be narrow and small, but should have some fullness compared with the lower part. The back part of the hoof makes a sudden turn forward underneath, forming a V-shaped portion known as the frog. This frog is somewhat elastic, and acts as a buffer on the surface of the ground, which under natural conditions it should just touch. The frog should never be pared by the blacksmith, excepting to remove tag ends or parts grown out of shape. A good frog saves the foot hard punishment on the road. The sole of the foot is the part between the outer wall of the hoof and the frog. This part is slightly concave or arched. The entire back part of the hoof is called the heel, and this should be neither low nor high, having only enough height above the standing surface to give the foot strength and protection. The heel should have about the same slope as the front part of the hoof, which is

from 45 to 50 degrees. The hoof should be free of cracks and not brittle, defects that are all too common. The pop-

ular sentiment is in favor of a dark colored hoof, most persons thinking it tougher than a white one and less liable to break.

The heart girth, or chest, is contained within the circumference of the body just back of the shoulders. A deep, full chest indicates vigor and strong constitution. A marked depression back of the shoulders is associated with narrow chest and cramped space for the heart and lungs.

The back should be straight and short with the ribs comparatively well sprung. A considerable depression, or sag, of the back is a sign of weakness. The back extends from the lower end of the withers to a

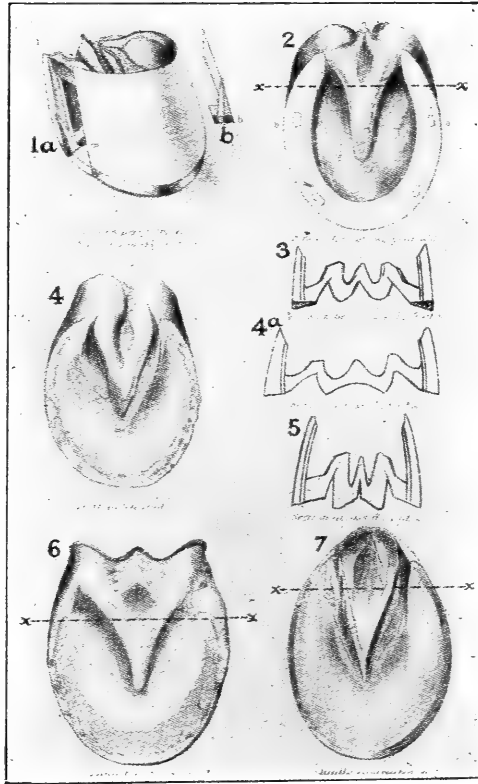

Figure 46.—The foot of the horse. 1. (a) nail properly driven; (b) improperly driven. 2, A sound foot. 3, A section across 2 at X. 4, A contracted hoof. 4a, a section across 6 at X. 5, A section across 7 at X. 6, A sound but flat hoof. 7, A badly contracted foot. Reproduced from "Diseases of the Horse," U. S. Dept. of Agriculture.

wide, somewhat level and muscular part called the loin.

The loin is the broadest and flattest part of the back, and lies between the last rib and the point of the hips. The strength of back lies in the loin, which should be short, wide, and heavily muscled. A long, narrow loin is a sign of weakness and inability to stand up under severe work.

The coupling is the space between the point of hip and

the last rib. A short coupling indicates strength and endurance, a condition much sought for by horsemen.

The hip is seen as a point more or less prominent on each side, just back of the coupling. The hips on mature females are usually more prominent than on the males. Symmetry of form calls for the hip to be nicely laid in, with a smooth covering of flesh. There are other good reasons for not having a wide placing of the points of the hips, which need not be discussed here.

The croup, or rump, is the long, muscular development from the point of the hips to the setting on of the tail. Great power and strength exist here, and so it is important that this part be long, wide, and fairly level. A steep rump is unsightly, though quite common on some draft horses, and a narrow one has less muscle than a wide one that is equally long. Length here is also desirable as affecting speed.

The thigh extends from the rump down to the large joint below, known as the hock. This part should be very muscular, and wide from the lower side of the croup to a joint below called the *stifle*. The upper part of the thigh is wide, while the lower portion, often termed the *gaskin*, is long, narrow, and very muscular. From the point of the hip to the hock one should look for considerable length.

The stifle joint is located in the front part of the thigh close to the body. This is comparable to the knee in the human skeleton. By means of tendons some of the strongest muscles of the upper thigh are connected with this joint.

The flanks refer to the parts where the legs join with the body. The front flank is just back of the arm, while the hind flank is the high part of the side above and beyond the stifle. A low, full flank goes with large body capacity and constitutional vigor. Horses high in the flanks usually appear long of leg and lacking in feeding capacity.

The hock is the large joint about half way down the hind leg. This is a very important part, and should be wide in

front, deep through from front to rear, and should be lean rather than fleshy. Large, heavy horses tend to have what are known as thick, meaty hocks. There are small bones in this joint, and they are most important in reducing the concussion which comes from the severe use thrown on the hind legs when in action.

The general features of the cannon, fetlock joint, pastern, and foot in the front legs are essentially the same as those behind, but the rear cannon bone is flatter and deeper from front to rear, and usually shows somewhat more length. The hind pasterns also are usually less sloping and somewhat shorter than those in front.

The position of the horse at rest should show the feet squarely placed and the legs as perpendicular as possible, as indicated by the position of the cannon bones. Horses' legs may take a variety of positions. Sometimes they toe in, or, perhaps, toe out. In such cases the legs are not straight. If the hocks nearly touch, then the hind feet usually point out; while, if there is considerable width between the hocks, the toes point in. A wide or bowed hock shows a very weak conformation, worse than one that is too close. Horsemen prefer the hocks to come close together rather than to be spread wide apart, for the closer position gives the better hock action of the two.

The horse at the walk should follow a straight line when led, not swinging the body to one side. The feet should be raised with snap, and carried forward and upward, and the knee and hock flexed, as it is termed. In this flexing movement, the foot describes a half circle before it strikes the ground. Heavy horses tend to swing the feet to one side, or paddle or wing, as it is sometimes called. When the feet in motion come too close together, the horse is said to "interfere," that is, the hoof of one foot will strike the ankle of another, interrupting smooth, uniform locomotion, and may cause lameness. As the foot is raised, a person

standing behind a horse in motion should be able to see the glisten of the shoe and note the carriage of the foot.

The movement of the feet in the trot is such that diagonally opposite ones are moved in the same direction; that is, the front right and left hind feet move forward together. The trot is known as a diagonal gait.

The movement of the feet in the pace shows the two legs on one side of the body in like motion at the same time.



Figure 47.—A good attitude and correct position of legs. Photograph from *The Farmer*.

The pace is a side gait of an unattractive character, and pacing horses are sometimes called “side-wheelers.”

The action of the horse is highly valued. A heavy draft horse that has a rapid and true walk will accomplish much more work than will the horse of slow movement. A fast trot is not necessary with the heavy horse; but, when moving faster than a walk, a horse should carry his legs with spirit and ease. A premium is always placed on the action

of the carriage horse for the city coach trade, high knee and hock action being especially valued. The roadster or trotter of first class must have a long, active, true stride, such as always goes with superior speed.

Quality in the horse is shown in the hair, the skin and bone, and in the general appearance. A fine, silky coat of hair; a thin, mellow skin; and fineness of bone, are features that show refinement, or quality. A big, rough head; large ears for the size of the body; wiry, heavy hair; too large joints and coarseness of bone, indicate lack of endurance and weakness of constitution. A large, coarse bone is more porous and less strong in proportion than one that is finer and smaller. Fineness and softness of skin is an indication of good secretions and healthy internal organs. In an animal of quality we find the most durability and stamina, or power of endurance.

The disposition of the horse is usually seen in the prominence and character of the eye and the carriage of the ears. If the eye is prominent, the whites clear, and the expression pleasant, the disposition will probably be good. A small, sunken eye indicates a bad temper. Too much emphasis can not be placed on the relationship of the eyes to the disposition, for in general here is an excellent indicator of the mental attitude of the horse. Ears that are usually carried erect or that point forward show a good temper, but, if the horse has a tendency to throw the ears back suddenly, a mean spirit is evident. A lopping about of the ears is evidence of laziness.

The height of the horse is usually expressed in "hands," a hand being equal to 4 inches. The height is measured in a vertical line from the ground to the top of the withers. A horse 16 hands high would stand 64 inches from the ground.

The weight of the horse, in a degree, indicates to what class he belongs. A mature horse weighing 2,000 pounds would naturally be a heavy draft animal. If weighing 1,000

pounds, it might be one of several types. In Europe, the height of the horse rather than his weight is looked upon as of the most importance.

The age of the horse is estimated by an examination of the teeth. It requires some experience to be quick in recognizing the age, which may be determined with fair accuracy up to eight years, after which it becomes a matter of guess work. The following items are the important guides to age.



Figure 48.—The age of the horse as shown by the teeth. 18 months old.

The colt's teeth. Seven or eight days after birth, two incisor teeth appear at the front and middle of both upper and lower jaws. In the course of five or six weeks, two more teeth appear in each jaw, one tooth coming in on each side of the two already present. Some time between the sixth and ninth month, two more appear, one by the side of each outer tooth. These six pairs are known as "nippers." They are the milk teeth, and are but temporary. They are not all equally level with one another at first, but in the course of twelve months or so they become uniform on the surface. The outside of the tooth is a very hard, white enamel. This covers a hard, ivory-like bone, while at the center is a soft, bony substance which more easily

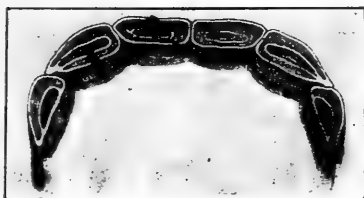

Figure 49.—Teeth showing 2½ years of age.

wears away, but is constantly renewed. The ends of the teeth have a ridged cutting surface, forming at the centers small depressions, or "cups," marks by which the age is determined. The cups in the central pair of nippers at first are dark of center; in the second year they begin to wear light in color, and these cups become smaller than those of the



Figure 50.—The teeth showing $3\frac{1}{2}$ years of age.

other four. Similar changes follow in order in the other pairs.

The teeth of the horse at three years show in the front of each jaw a pair of permanent incisors, larger than the nippers, occupying the place of the central pair, which they have pushed out.

The teeth of the horse at four years show the addition of two more permanent large incisors, one on each side of the central pair in each jaw, in place of the colt teeth.

The teeth of the horse at five years show the last pair of nippers in each jaw replaced by permanent incisors. At this age there appears in the mouth of the male four canine teeth, commonly known as "tushes." These teeth have roundish points, and there are two in each jaw, one being on each side of the permanent incisors, and a short distance back of them. After the fifth year the

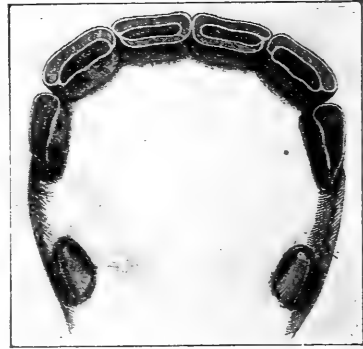

Figure 51.—The teeth showing 4 years of age.

age of the horse is determined by the extent to which the ends of the teeth and the cups previously referred to are worn down, the older teeth naturally showing the most wear.

The teeth of the horse at six years show the cups of the central permanent incisors in the lower jaw somewhat worn.

The teeth of the horse at seven years show that the cups of the second pair of permanent incisors in the lower jaw are worn away to a noticeable degree.

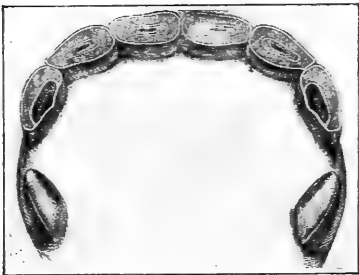

Figure 52.—The teeth showing 5 years of age.

The teeth of the horse at eight years show the cups of the third and last pair of incisors in each jaw worn off. By this time all the teeth have been worn about level, so that the mouth mark largely loses its value. The cups in the incisor teeth of the upper jaw wear off more slowly, however, those in the central pair disappearing at about nine years. This result is due to the fact that the cup in the upper incisors is deeper than in the lower ones, and so remains a longer time.

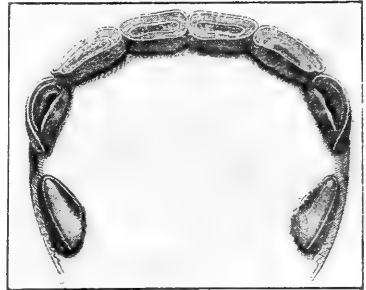

Figure 53.—The teeth showing 6 years of age.

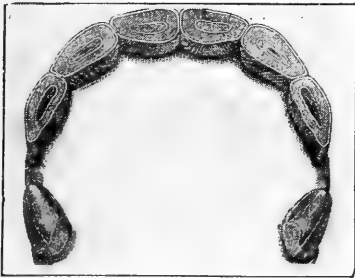

Figure 54.—The teeth showing 7 years of age.

have grown out longer. In horses from 12 to 16 years of age, the ends of the teeth become somewhat three-sided.

The soundness of the horse is regarded as very important. Many unsound horses are sold to men who think they are buying sound ones. Then, when the buyers attempt to sell, their horses often show a great loss on the purchase price. If, therefore, one is to be a capable judge, one must be able to distinguish cases of unsoundness. It is not always

The six permanent teeth in each jaw at first meet each other in much the same position, their ends butting directly together. As age increases, the teeth gradually take a more inclined or slanting position in each jaw, so that they come together at a sharper angle. The older teeth are also more worn off at the surface, but



Figure 55.—The teeth showing 8 years of age.

easy to do so. Some forms are not clearly apparent until well established. If the respiration is not good, this fault is brought out in some form of work, such as trotting, hauling a load, etc. In the sale markets, horses are hitched to wagons with brakes, so that they may be required to make quite an exertion in moving along. If a horse is lame, or has bad wind, these defects may be seen when he is in action.

Heaves is an unsoundness or trouble of the lungs which is brought on through dusty feed, bad ventilation, or indigestion. Broken wind or asthma is apparently much the same thing. When the horse expels wind from the chest, he lacks the muscular contraction of the lungs that characterizes the sound animal, and makes a wheezing noise, which is sometimes very loud.

Roaring is another disease in which the horse makes a loud noise during breathing. The larynx is affected, but not the lungs. This is caused by a paralysis of the nerves and muscles of the parts, which results in the noise in breathing. Roaring is manifested during exertion, yet a horse may be a roarer and be driven some distance without making much if any noise. The disease is one of progression, and gradually becomes worse. Roaring had always been regarded incurable until some years ago when Dr. Williams, of Cornell University, discovered a method of operating by which it might be cured. This is known as the Williams operation, and it is now performed with success in America and abroad.

Spavin, commonly referred to as bone spavin, is usually found on the inner side and in front of the hock joint. There are three forms of spavins.

- (a) The high, or true, spavin, the more serious one.
- (b) The low, or jack, spavin, and
- (c) The blind spavin, which affects the joint surface, but causes no enlargement.

The spavin is caused by a strain or injury, or may be due to heredity influences or faulty conformation. The high or low spavin is shown in a more or less thickening of the part, as compared with a sound hock. The occurrence of spavin is most easily seen by standing directly back of the horse and viewing the parts from the rear. Spavins cause lameness and a stiff gait, and are regarded as a serious unsoundness, greatly affecting sale values. They are more common on light than on heavy horses. The horse that has "a spavined gait," shows a slight hitch in the hip on the side affected, with a letting down of the opposite hip when in action. When the horse first starts this defect is most noticeable, for he naturally throws his weight on his sound leg. With exercise his gait becomes more natural; but, after resting and cooling, lameness again appears when he is required to move.

Curb is another unsoundness of the hock. When in perfect condition, the back of the hock, slightly below the point, has rather a vertical straight edge. If a curb exists, there is a bulging or outward curve a short distance below the point, that may be seen by viewing the hock from one side. Hocks that do not have curbs, yet tend to round out at this part of the leg, are said to have a curby confor-

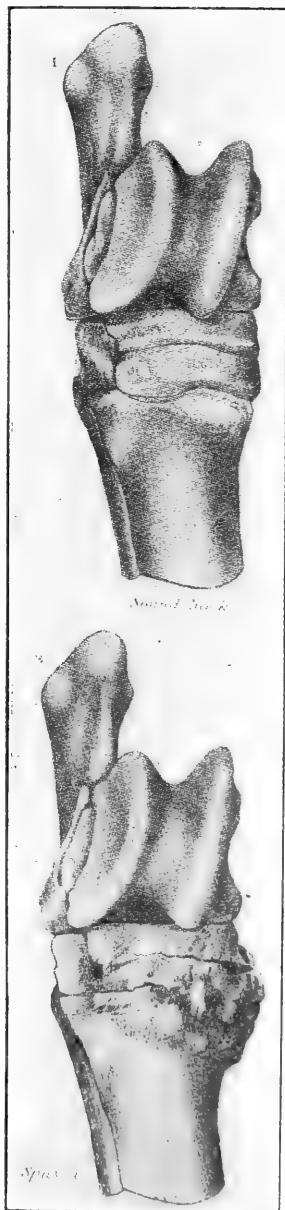

Figure 56.—The upper picture shows a sound hock joint; the lower, one with a spavin. Reproduced from "Diseases of the Horse," U. S. Dept. of Agriculture.

mation. Curbs are due to strains, and, while an unsoundness, as commonly seen, are not of a serious nature.

Bog spavin is an inflammation of the synovial sac, located in the front and inner side of the hock. If pressed, it may appear on the outside and rear part of the hock. According to Dr. F. B. Hadley,* while occurring in horses of all ages, it is most common in "loose-jointed" draft colts, and rarely results in lameness. Sometimes these swellings dis-



Figure 57.—The hock from one side, showing a bog spavin in front and a curb behind. Reproduced from "The Diseases of the Horse," U. S. Dept. of Agriculture.

appear without treatment, although this is rarely the case with old horses.

Thoroughpin is a swelling in the rear part of the hock at its thinnest point. Here, under ordinary conditions, the hock is curved to form graceful outlines with a pronounced depression. If thoroughpin occurs, a swelling will be noticeable on each side of the hock at this point. Bog spavins, thoroughpins, or a puffed condition about the hocks, are seen most frequently on large, heavy horses that have what are called thick, meaty hocks. Horse dealers are inclined

to refer to these as little puffs that will disappear with work, and so minimize their importance. It is true that heavy horses that stand in the stable, frequently swell in the lower half of the legs, a condition that exercise removes, but bogs and thoroughpins are distinct unsoundnesses that exercise will not drive away, and that injure the sale value of the horse, especially if the buyer is a dealer.

*The Horse in Health and Disease. 1915, p. 213

Sidebone is found in the rear part of the front foot on the coffin bone at the crown or top of the hoof. It is due to the hardening of cartilages, whereby they take on a bony character, which causes lameness. In well-defined cases, the sidebones appear as hard projections just beneath the skin, and can be plainly seen or felt. In their early stages,

sidebones are not so easily discovered, and one may buy a horse that appears sound, yet in a short time the trouble will become noticeable. Sidebones are most common on draft horses, and on those used on hard roads or pavements. This unsoundness is severely discriminated against

and shrewd men will not buy horses that have sidebones.

Ringbone is a bony deposit which in the form of a ring encircles the upper part of the foot or the pastern. On old horses this bony enlargement sometimes becomes very conspicuous. It may be due to hard labor, strains, bruises, etc.,

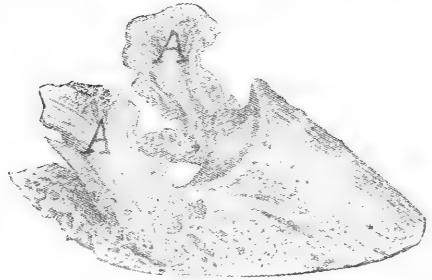

Figure 58.—Sidebone shown at A on bone in foot of horse. Reproduced from "Diseases of the Horse," U. S. Dept. of Agriculture.

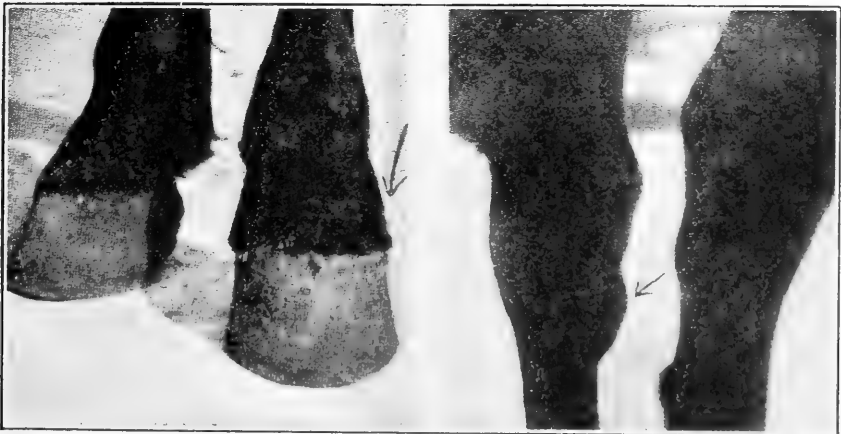

Figure 59.—Ring bone above the foot, as indicated by the arrow, and spavin at lower part of hock near point of arrow. Reproduced from Circular 29, Purdue University Experiment Station.

and, if well developed, causes serious lameness. Ring bones are fairly common, but when well developed are easily detected.

Splint is a bony projection or roughness usually found on the inside of the splint bone, which lies close in with the cannon bone of the front leg, and is commonly regarded as the cannon. This is not regarded as a distinct unsoundness, although very common and referred to quite frequently. Splints sometimes appear on young horses and then disappear with the mature development of the animals. Splints may often be easily seen while standing in front of the horse and looking at the inside of the legs at the cannons.

Quarter-crack is a splitting or cracking of the bony part of the hoof, usually of the front foot. This crack may extend the entire length of the hoof, and be so bad as to require fastening the parts with metal clamps or nails to keep the cracks from extending or widening.

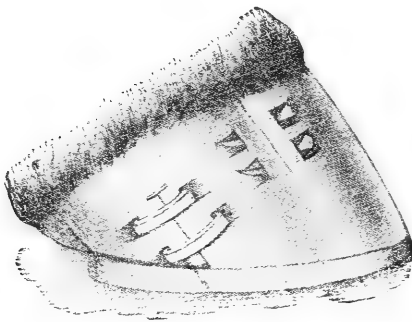

Figure 60.—Quarter crack. Reproduced from "Diseases of the Horse," U. S. Dept. of Agriculture.

Horses with brittle or soft hoofs are most affected with this trouble. Quarter-crack may develop so far as to break through the lower part of the foot and cause injury

and lameness, although this trouble is not usually serious.

Toe-crack is similar to quarter-crack, but is usually on the hind foot, in the front part, and often extends the length of the hoof.

Founder, or laminitis, as the veterinarian calls it, is an unsoundness of the feet. It is due to an inflammation of the delicate tissues within the hoof, and is usually found in the front feet. It is caused by a variety of conditions, such as overwork, overfeeding, exposure, etc. If well established, it is incurable and causes the horse much suffering. The common symptom of this trouble is lameness, which is often

very severe. When standing, the horse, as a rule, reaches the feet somewhat forward, resting the weight upon the heel. The hind feet, which carry most of the weight, are placed well under the body. The more perfect the foot, the less liable the horse is to suffer from founder. A very flat foot, or one with very high hoof walls, or a foot that is quite contracted, is liable to be affected with this trouble.

Navicular disease is an inflammation that occurs in the foot also, affecting the sesamoid sheath and the navicular bone. This occurs most commonly with race horses and those having great knee action. Usually but one forefoot suffers from the disease, which is caused by concussion and shock to the affected parts. The early stages of the disease are not commonly noticed. Attention is first directed to the "pointing" of the foot, which is extended forward, the weight resting on the toe, and, as the trouble develops, lameness is noticed, which increases with use of the horse. But few cases of navicular disease recover.

Cocked ankle, or knuckling, is a partial dislocation of the pastern or fetlock joint, in which case the pastern becomes more perpendicular than usual, throwing the joint forward out of natural position. This is not always an unsoundness, but is a defect, in that it causes stumbling and clumsy action.

There are some other forms of unsoundness that are not especially common. There are also some diseases that become chronic as external features, such as fistula and poll evil. These two are manifested by swelling and finally running sores at the withers or poll, as the case may be. When these two diseases are well established as running sores, they are difficult to cure, and frequently, in spite of medical treatment, extend over a long period of time. The various forms of unsoundness described, however, are those of common occurrence, and are most likely to attract attention.

IN DISCUSSING THE POINTS OF THE HORSE

1. Where is the muzzle, and why should it be of good size?
2. What kind of shoulder is most desirable?
3. Locate and describe the cannon bone.
4. Explain why the pastern should be sloping.
5. Describe the frog and its use.
6. Discuss good and bad croup conformation
7. Locate the hock, and discuss its form.
8. Explain the movement of the feet in trot and pace.
9. What is meant by a "hand?"
10. Explain the meaning of milk teeth, and their occurrence.
11. What are the cups?

A FEW OBSERVATIONS WORTH MAKING

12. Compare "points" on the home farm horses.
13. Compare horses on the town streets.
14. Examine feet when at rest.
15. Observe movements of the feet of horses driven on the road.
16. Inquire of blacksmiths if they shoe to affect the action.
17. Examine the teeth of colts and older horses, and obtain practice in judging age.
18. Report on any cases of chronic disease observed in neighborhood horses.

CHAPTER XVII

JUDGING THE HORSE

In the preceding chapter on "the points of the horse," the conformation of the horse has been discussed in some detail, and the relationship of form to function shown. In this chapter, the important purpose is to set forth the more distinct features the judge should emphasize in judging either the carriage or the draft horse.



Figure 61.—A fine example of high knee action. The mare Queen Pandora, owned by Mrs. C. C. Fillers. Photograph from *Bit and Spur*.

POINTS IN JUDGING CARRIAGE HORSES

The judging of carriage, or light harness, horses is done on the basis of their value for speed and the drawing of carriages and lighter vehicles. This type of horse is comparatively light of weight, is long and narrow rather than short and thick, yet has a muscular appearance. In this class we find somewhat striking differences in type, as is seen by comparing a high-class Hackney with a light type of trotter. The American saddle horse is also in this class, for he has many of the characteristics of form of the carriage

horse. In order to cause no confusion, a score card for carriage horses is given on page 185. There will be no difficulty in most communities in finding horses of this type which may be used for score-card practice. This score card is the style commonly in use, containing a blank column in which the student as judge may write his own score, with another column in which the score of the instructor may be written for comparison.

The height of the carriage horse may vary, but 16 hands is a good standard, with 1,100 to 1,200 pounds for weight.

The general appearance of the carriage horse can best be studied by standing at some distance, such as fifteen or twenty feet away, and making an inspection which will take in the entire form, the quality, and disposition. One should not be too close to the animal for this first examination. At a distance one also gets an impression of character, as shown by the head and neck, that can not be so easily noticed otherwise.

The head of the carriage horse is an important indicator of intelligence, disposition, and quality. The head, therefore, should be trim and neat, with refined, well-set ears, and carried in a proud, animated manner. Coarseness of head is very objectionable in this type of horse.

The neck of the carriage horse should tend to be fairly long and muscular, carried high and free, with much ease of movement. A thin, ewe neck,—one that is depressed on top—is not uncommon with the lighter type of carriage horse, and is regarded as a weakness.

The fore quarters of the carriage horse should show a smooth, well laid-in, yet muscular shoulder. While great strength is not essential, a wide, strong, muscular arm, and long, wide-topped forearm are favored. What is called a clean, smooth cannon bone is a very important feature. Cleanness and lightness of limb are much valued by buyers of this class of horses. Strength and quality go with legs of this kind.

CARRIAGE HORSE SCORE CARD

Scale of Points	Perfect score	Student's score	Corrected score
GENERAL APPEARANCE: Total points, 9.			
NOTE HEIGHT AND WEIGHT			
FORM, long, deep chested, muscular	4		
QUALITY, neat lean head; fine hair; mellow skin; clean bone and joints; disposition active and pleasant.	5		
HEAD AND NECK: Total points, 7.			
HEAD, well defined; forehead broad; eyes bright and prominent; muzzle fine, with large nostrils and thin lips; ears of medium size, and alert.	5		
NECK, somewhat long and refined	2		
FORE QUARTERS: Total points, 23.			
SHOULDERS, long smooth and oblique	2		
ARMS, short and muscular; forearm long	2		
KNEES, wide in front, straight, and deep through	2		
CANNONS, short, flat, strong	2		
FETLOCKS, wide, and pasterns strong, oblique 45 degrees	4		
FEET, medium size, slope like pastern; horn dense; frog large; heel wide	7		
LEGS, properly placed, and not too close together	4		
BODY: Total points, 12.			
WITHERS, muscular and well set back	1		
CHEST, deep, girth large	4		
BACK, strong, short, muscular, well carried; ribs long and arched; loin short and broad	6		
UNDERLINE, long, well down in the flank	1		
HIND QUARTERS: Total points, 29.			
HIPS, smooth, fairly wide apart	2		
CROUP, long, level and muscular, broad; tail attached high	3		
THIGHS, long, muscular; quarters strongly muscled, and lower thighs long and strong	6		
HOCKS, wide, deep, straight, clean cut	5		
CANNONS, short, wide, strong, clean	2		
FETLOCKS, straight and wide; pasterns oblique, strong	3		
FEET, medium size, slope like pasterns; horn dense; frog large; heel wide	4		
LEGS, properly placed for rapid speed, not too close together	4		
ACTION: Total points, 20.			
WALK, elastic, quick, balanced	5		
TROT, rapid, straight, with long stride	15		
Total score	100		

NAME OF ANIMAL BREED AGE
 OWNER
 SCORED BY DATE

The body of the carriage horse will appear deep but not thick, and will at its best have a sleek, well-rounded appearance. By standing off at one side, the judge will get a better view of proportions, and the fullness of chest, and depth of both front and hind flanks will be easily seen. A view from squarely in front will show the prominence of breast,

and the thickness and depth of body below the placing of neck, which should be smoothly blended into the body. There is quite a good deal of variation in the withers of driving horses. They should not be very sharp, but fairly well muscled and not appear too prominent. Notice whether the back is strong and well carried, with the loins broad and not much depressed below the level of the croup. The well-turned carriage horse will show a fullness of body from various points of view. The greater speed he is capable of making, the more muscular and angular he will appear. This point is illustrated by comparing a carriage horse and a working trotter, each being about the same size, but used for a different purpose.

The hind quarters of the carriage horse show power. As one stands at one side, the length of croup and its position are easily seen. A long, strong, high rather than low croup is desired, with the tail having a free, easy, and somewhat high carriage. The length from the hips to the point of the hocks should be considerable.

The distance from the hind flank diagonally across to the setting on of the tail also should be comparatively long. As one stands behind, one should be able to observe some thickness below the tail, where the hind legs merge together into the thick, muscular quarters. A driving horse is not likely to be too thick in the quarters. As one views the horse from behind, the legs should reach back, with the hocks separated about four inches, and the lower thighs showing a strong muscular development from both rear and side views. At the stifle joint, where the upper and lower thigh connect, fullness rather than depression should occur. The hocks should be inspected from the front, at one side, and from behind. It is important that they be clean, well-turned, and straight. Careful examination should be made of this part, for the hocks require much study. The occurrence of bone and bog spavins here, and often a puffy condi-

tion that is objectionable, may escape notice. A horse with weak or diseased hocks is a very undesirable animal to own.

The legs of the horse must be inspected from in front and from one side. A true carriage, in any event, is important. Standing in front enables one to see the straightness of limb, and in a way that shows the relation of each leg to its mate. From this view we judge whether the ankles will interfere when the horse is in motion. Thus we see if a true gait is possible. From one side we note the position of the legs, to determine balance of action. If front and hind legs are tucked too much beneath the body, they are liable to come in contact with each other when in rapid action. If there is too much stretch and separation between the limbs in front and behind, then the action will lack power. In a natural pose at rest, the front legs will incline very slightly under the body, with the hind legs correspondingly extended behind. The picture on page 171, illustrates the correct position.

A foot inspection of the horse begins with the foot at rest and in a natural position. Thus one is able to note the form, the placing on the ground, shape of heel, and the upper condition of foot, with its relation to the pastern and to the fetlock joint. The foot, however, should be examined on its under side, and so must be raised for inspection. The fore foot is usually started easily by running the hand nearest the horse down the shoulder and arm to the back of the cannon, and pressing on the tendons with the ends of the fingers, raising the leg at the same time, using the other hand to catch hold of the hoof as it is raised by the horse. With one hand the hoof may be easily held, while with the other any accumulated material under the foot may be removed by the use of a small pick of some sort. One may then easily examine the lower part of the foot. The hind foot is examined somewhat differently. If wishing to inspect the left hind foot, the left hand is placed on the croup and

quietly slipped down over the thigh to the muscle just above the hock, where a firm pressure with the fingers is given. At the same time the right hand is placed upon the pastern, and the foot and leg firmly but quietly raised upward and backward, reaching away from the body. The hoof is thus brought in front of the examiner, with its lower surface facing to the rear, and at about knee height. No great effort should be made in raising the feet, for the horse will easily support himself on his three other limbs. Young horses re-

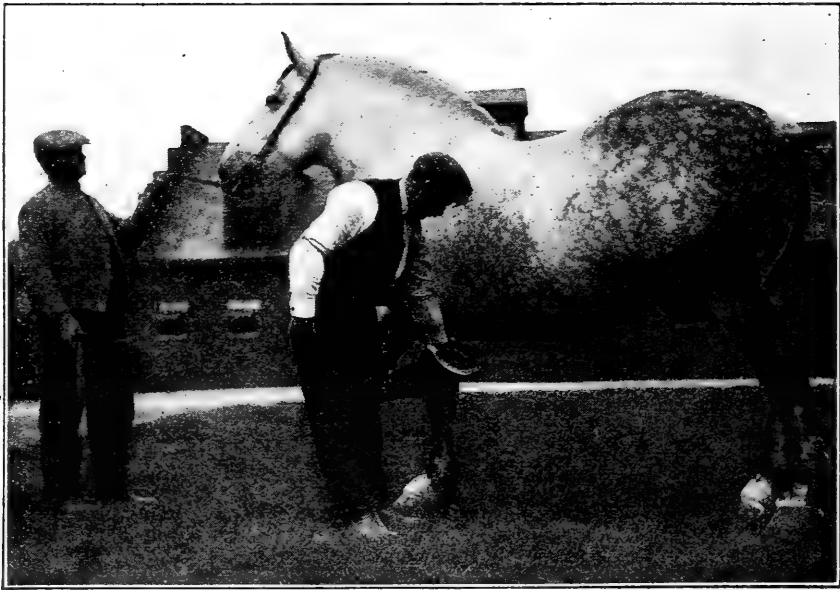

Figure 62.—Showing correct method of holding front foot for examination. Photograph by the author.

quire more patience than old ones in foot examination; but, after being shod a few times, a horse of good disposition may not be expected to give trouble. It is wise to move with care about the hind legs, especially directly behind, to avoid the chance of a kick.

The study of action in the carriage horse is most important. His market value largely depends upon his perfection of movement. All carriage horses, and race horses

in particular, are so shod as to regulate their action, if used by men who know the relation of form and weight of shoe to foot and leg movement. A fancy driver for a heavy carriage should show a snappy, stylish action, with the knees and hocks carried rather high and strong. A roadster or light race horse will show a longer, more powerful yet plainer gait, with not so high or short movement. When action is being inspected, the horse should first be led at a walk in a direct line toward and then away from the judge, who should carefully note the trueness of movement of the limbs and the way the feet are carried. Next the horse should pass by at a walk, so that the inspection may be made from one side, to observe the freedom of movement and flexing of the knees and hocks. The next step will be to require the horse to go and come at a gait faster than a walk, the judge assuming the same positions as before while the walking gait was being studied. See-

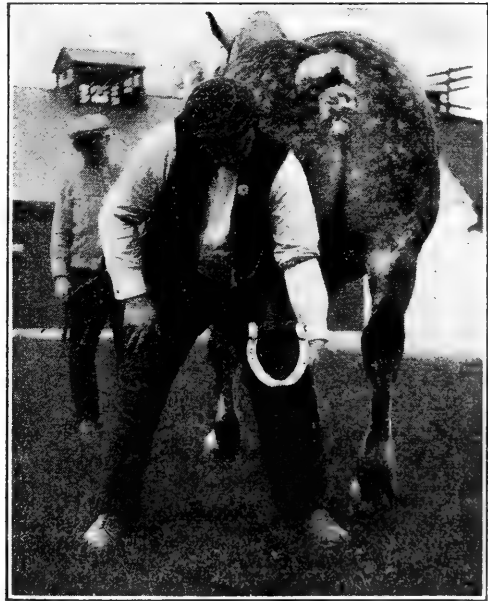

Figure 63.—Showing correct position for holding and examining the hind foot. Photograph by the author.

ing the horse at the walk and trot, or other rapid movement, will enable him to draw a conclusion as to the merits of the gait. As 20 points are credited to the action of the carriage horse on the score card, it may be seen that this feature is highly valued. Persons differ in their appreciation of action, and some are naturally much better judges than others. If, however, one will study the action from these three points of view, one will soon see how horses differ in this regard.

POINTS IN JUDGING DRAFT HORSES

The method of judging the draft horse is essentially the same as that applied to the carriage horse. The purpose of the true draft horse, however, is different, and one must have in mind at all times draftiness and conformation. The following score card on page 192 is arranged for a study of the heavy type of horse, such as the Percheron, for example.

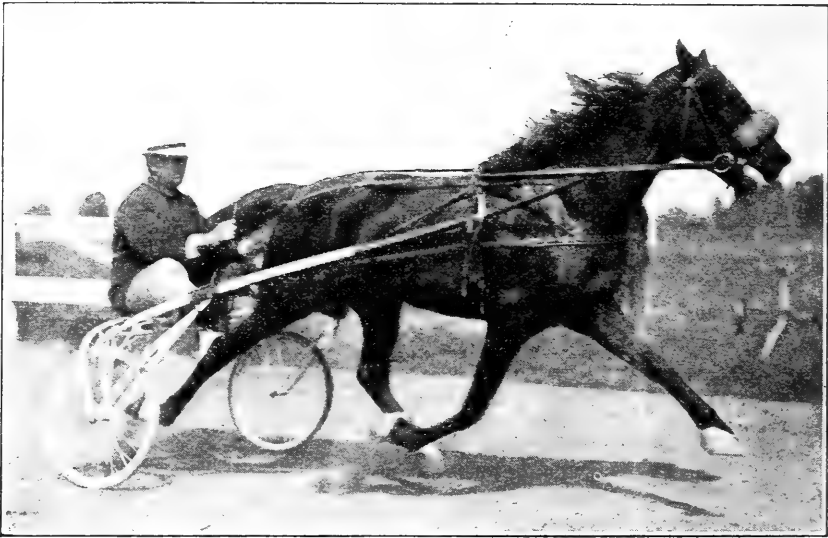

Figure 64.—An example of a long, powerful stride in a light harness horse. Notice but one foot is touching the ground.

The general appearance of the draft horse is massive, exhibiting great power in drawing a load. Weight and conformation, therefore, are two very important qualities necessary in draft form. The size must be large, and the nearer the weight to 1,800 or 2,000 pounds the better. Such a weight is associated with considerable height, and $16\frac{1}{2}$ to 17 hands will measure the height of many of these big horses. An examination from any point of view will show this horse to be deep and thick, both at the ends and in the middle, with a compact, powerful body set on rather short legs. In the following part of this chapter are some details the student should keep in mind in this examination.



Figure 65.—Judging horses. Study the action as the horse comes toward you, standing directly in front. Photograph from Purdue University.



Figure 66.—Judging horses. Study the action as the horse leaves you, standing directly behind. Photograph from Purdue University.



Figure 67.—Judging horses. As the horse goes by at one side, note the knee and hock action. Photograph from Purdue University.

DRAFT HORSE SCORE CARD

Scale of Points	Perfect score	Student's score	Corrected score
GENERAL APPEARANCE: Total points, 13.			
NOTE HEIGHT.....weight.....1600 lbs., or more			
FORM, low set, massive in proportion.....	6		
QUALITY, showing refinement in head, clean bone and joints, fine skin and hair.....	7		
HEAD AND NECK: Total points, 7.			
HEAD, lean, medium size; forehead broad; eyes bright and prominent; nostrils large; lips even; muzzle fine; ears medium size and well carried; disposition active and pleasant.....	5		
NECK, strongly muscled, carried high, not thick at throat latch.....	2		
FORE QUARTERS: Total points, 24.			
SHOULDERS, sloping, smooth, well set in back.....	2		
ARMS, short and wide; forearm, long, widely muscular	3		
KNEES, wide in front, straight, deep through.....	2		
CANNONS, short, inclined to be flat, lean.....	2		
FETLOCKS, wide, straight; pasterns oblique, strong...	3		
FEET, large, round, uniform; horn dense; frog large; heel wide.....	8		
LEGS, short, and carried in good form.....	4		
BODY: Total points, 9.			
CHEST, deep, wide, low.....	2		
BACK, broad, short, level; ribs long, well sprung; loin wide, strong.....	6		
UNDERLINE, flanks low.....	1		
HIND QUARTERS: Total points, 37.			
HIPS, smooth, wide.....	2		
CROUP, long, level, wide; tail attached high.....	4		
THIGHS, long, muscular; quarters heavily muscled; lower thighs wide, strong.....	6		
HOCKS, wide, deep, clean cut, straight, well supported	8		
CANNONS, short, wide, strong.....	2		
FETLOCKS, wide, straight; pasterns oblique, strong...	3		
FEET, large, round, uniform; horn dense; frog large; heel wide.....	7		
LEGS, short, carried in good form.....	5		
ACTION: Total points, 10.			
WALK, true, elastic, quick.....	6		
TROT, active for weight, regular.....	4		
Total score.....	100		

NAME OF ANIMAL.....BREED.....AGE.....
 OWNER.....
 SCORED BY.....DATE.....

The head and neck show considerable size, without the delicate chiseling of head of the lighter horse. The neck is heavily muscled and will not impress one as having as much length as seen in the carriage horse.

The shoulders of the draft horse are usually less sloping than those of the lighter type, and are not laid back in quite as smoothly. The slower, more moderate draft action is associated with this upright form of shoulder.

The cannon bone of the draft horse tends to be somewhat thick and round in the front leg, and flat and deep in the hind leg. The leg at this point lacks the refinement so often seen in the carriage horse. Emphasis should be placed on this bone's being short, comparatively flat, and deep from front to rear. A good big draft horse with plenty of bone may measure 10 inches around the front cannon.

The pasterns of the draft horse often appear short and rather erect. To give the easiest movement, they should have fair length, and a slope of about 45 degrees. Some draft breeds have a longer pastern than others, as, for example, the Clydesdale, which is noted for length and springy character in this respect. A short, stubby pastern is very undesirable, and goes with a hard gait that punishes the feet and causes trouble.

The feet of the draft horse must show considerable size. The fore feet in particular should not look too small in proportion to the rest of the body, and it is well to emphasize the quality of the hoof. The feet of horses of this type, especially those in front, are subject to severe strain, due to the great weight placed on them and the hard work on the road. This part should be most carefully examined. The old English saying, "No feet, no horse," has no greater application than with the drafter.

The hind quarters of the draft horse especially signify power. Great length and breadth of the croup, therefore, provide for thick, powerful muscles. As one looks at this part, one should be impressed with the power there avail-

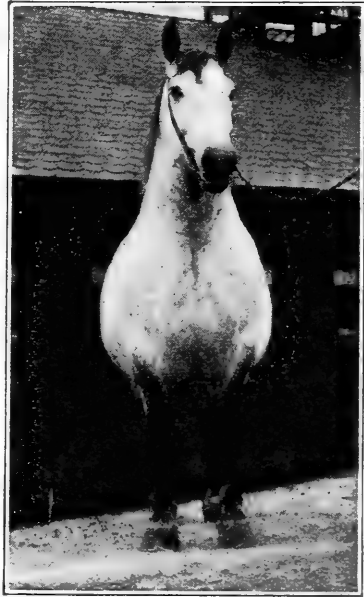

Figure 68.—Judging the horse. An excellent front position. Photograph by the author.

able. A common feature of the draft horse at this point is steepness of croup. This is easily seen whether one stands at one side or looks from behind. We do not have much information on the difference in power between horses with steep croups and those having them more level, but it is generally agreed that the most beautiful conformation goes with the more level condition. The greater the length and the more heavy the muscling from the hips to the hock, the more powerful will be the croup conformation.

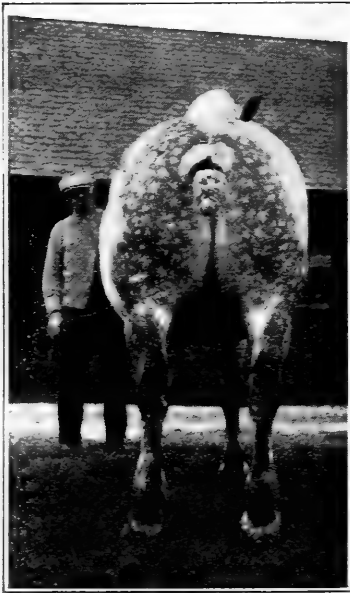

Figure 69.—Judging the horse.
Hind legs too wide apart.
Photograph by the author.

The legs of the drafter should not appear too wide apart at either hock or knee. Too much spread is a greater indication of weakness than is closeness. The limbs should come down in a well-placed position, to stand slightly under each corner of the body, as it were. In viewing the horse from in front, one is inclined to look for too great width, such as goes with a stiff or clumsy gait.

The action of the draft horse is studied in the same way as with the driver. More value, however, is in this case given to the walk than to a faster gait. A heavy draft horse is rarely required to move faster than a walk. He should have a quick walk, however, and be able to move four miles an hour in a free, easy manner. Many heavy horses tend to carry the feet to one side somewhat when in motion, and, in the language of the horse market, “paddle” or “wing.” This tendency is in a measure due to the straight, open-topped shoulder, and while such action is not defective, it is not as smooth and attractive as when the feet are properly

carried backward, with no side twist. When watching the horse in action, look for a strong, only moderately high knee and hock movement, but do not look for much speed. The heavy horse, however, inclines to drag his feet, a point the judge should carefully note. As one stands behind one should clearly see the glisten of the shoe as the foot is raised. There are as wide extremes in action among draft as among carriage horses, but not so much should be expected from the former as the latter. The horse with heavy body very naturally is unable to move with the lightness of step and activity shown by the horse that has no such weight to carry.

The opportunities to study horses are frequent, either in town or country. If one will notice the horses that are constantly passing, much information of value will reward the observation. Comparisons may be repeatedly made, for two-horse teams always furnish such a chance, while in many public places two or more horses are often to be seen standing side by side, interesting subjects for comparison. In every community will be found excellent horses of their class that are well fed and cared for. The owners of such horses usually take a just pride in them, and are always pleased to show them to those who are interested.

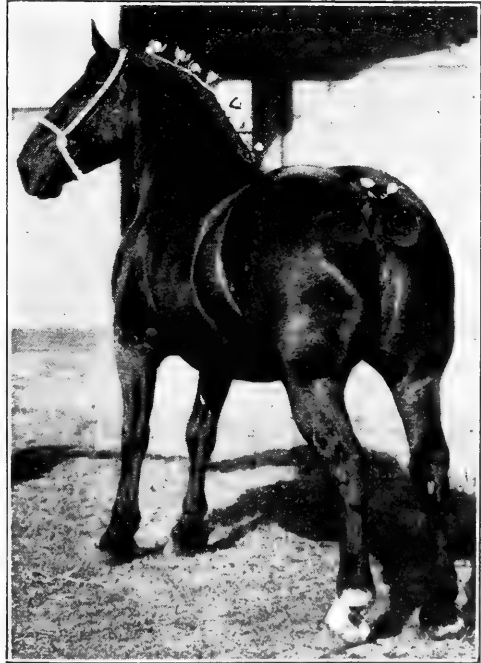

Figure 70.—Judging horses. A powerful draft conformation from behind. The camera being nearer the hind legs than the front, the former appear much too long and out of proportion. Photograph from *The Farmer*.

AS A JUDGE OF HORSES, WHAT

1. Features are given the most credit in the carriage horse score card?
2. Kind of head and neck should the carriage horse have?
3. Is the relationship of body form to carriage horse type?
4. Is the best method of inspecting the legs?
5. Manner of front foot examination is desirable?
6. Kind of action will be shown by a fancy driver?
7. Important differences exist in carriage and draft-horse score cards?
8. Size is desirable in the draft horse?
9. Slope should the pastern of the draft horse have, and why?
10. Description can you give of the croup of the draft horse?
11. Importance should be given draft horse action?

FOR OUTSIDE OBSERVATION AND STUDY

12. Make or get some score cards, and score a few of the horses at home or of the neighbors.
13. Get up a small horse show among the neighbors and have a judging contest. Interest the local horsemen.
14. Learn, if possible, who owns the best type of stallion in the community. Why is he best?
15. Report on the horse judging at some fair, if you have opportunity.

CHAPTER XVIII

FEEDING THE HORSE

The use of the horse, in spite of the automobile, is very general in both town and country. He is suited to do many things for which the motor is not fitted. He is a more economical producer of power in short hauls than is the motor, and he is as necessary as ever on the hill farms and where small areas are cultivated. According to the 1920 census we had in the United States some 20 million horses and over 5 million mules. These horses had a farm value of \$2,000,000,000, and the mules were valued at half a billion dollars, so we may see that the production of the horse in America is a great industry. Iowa, Nebraska, Illinois, Kansas, and Texas in 1920 were the leading horse-producing states, and in the order given, with Iowa having about a million and a third. Texas is the leading mule-producing state, with Georgia, Missouri, and Tennessee ranking after. The use of the mule is steadily growing in favor in the United States. The feeding of so many horses and mules involves great expense, and, to be intelligently done, requires careful study of the requirements of each animal.

The work of the horse and what he can accomplish depends upon his weight, his muscular development, and his endurance. What is known as *horse-power*, is the power necessary to raise 33,000 pounds at the rate of one foot a minute against gravity. The real measure of horse-power is based on the unit of a foot-pound, shown in the power manifested in raising a pound one foot. The horse works in different ways, no matter what his type, weight or size. These various forms of work are well expressed as follows by Henry and Morrison:*

*Feeds and Feeding, 1917.

“His work usually consists of a more or less complex combination of the following simple kinds:

“(1) *Locomotion*, or traveling along a level course without a load;

“(2) *Raising the body*, with or without a load, against the force of gravity in ascending a grade;

“(3) *Carrying a load*, draft, or hauling a load.

“A horse drawing a load up a hill combines all these types. He is (1) advancing and at the same time (2) raising his body. Likewise, he is (3) carrying the harness and (4) hauling the load. In descending the hill, the horse will be called upon to perform even a fifth type of labor, bracing himself to prevent too rapid a descent.”

Feeding standards for the horse have been in use for a long time, and, on the basis of what has already been stated, the necessity for different standards is very apparent. Here weight and work are the two vital factors. The following is the modified Wolff-Lehmann standard for horses, as given by Henry and Morrison.*

FEEDING STANDARDS FOR HORSES
Required per day per 1,000 lbs. live weight

Condition of work	Dry matter	Digestible crude protein	Total digestible nutrients	Nutritive ratio
Idle.....	13-18 lbs.	0.8-1.0 lb.	7.0-9.0 lbs.	8.0-9.0
Light.....	15-22 “	1.1-1.4 “	10.0-13.1 “	8.0-8.5
Medium.....	16-24 “	1.4-1.7 “	12.8-15.6 “	7.8-8.3
Heavy.....	18-26 “	2.0-2.2 “	15.9-19.5 “	7.0-8.0

It is interesting to note in this standard, that a horse at heavy work requires from 5 to 8 pounds more dry matter and from 8.9 to 10.5 pounds more total digestible solids than one that is idle. A substantial increase in work of a permanent nature should be accompanied by a marked increase in the protein and total digestible nutrients fed, with a narrowing of the nutritive ratio.

The preparation of the feed for a horse is important. The horse has a comparatively small stomach, and so, as his

*Feeds and Feeding. 1917

work increases, concentrates should more or less replace roughage. Food is prepared in several ways. Dry roughage is often chaffed, that is, cut or shredded. Chaffing reduces the work of the horse for the reason that the more the roughage is torn to pieces by mechanical means, the less labor will be required of the horse in breaking it up. Men who care for horses often make hay or straw more palatable by chaffing, then mixing with concentrates, and dampening the mass with a light sprinkling of water. Thus prepared, more roughage is consumed than would be the case otherwise, and the sprinkling reduces the dust, which is injurious to horses.

The grinding of grain for horses is not necessary, unless in the case of old animals with poor teeth. Whole grain is appetizing to the horse, he grinds and breaks it up easily with his teeth, and it digests efficiently as thus fed. Crushing grain may be desirable, and the author has known of city stables where oats were run through a mill and crushed, and as thus fed gave better returns, in the opinion of the management, than were secured from oats fed whole. Cooking of feed has been resorted to by horsemen in the past, more especially in Europe, but this process affects the digestibility of the proteids, so the practice is undesirable. What is known as a *bran mash*, that is, wetting bran with hot water to make a thick, fairly moist feed, is practiced. If fed at regular periods, as, for example, once a week, it has a cooling, laxative effect. Bran mash is relished by horses, and is popular as an occasional feed. The soaking of feed may sometimes be desirable, especially in spring when feeding very hard, dry corn or barley.

As a rule, it is best that the horse should be watered frequently. Drinking a little at a time, is better than having too much water at greater intervals, especially if an animal is overheated. The air temperature and kind of food will affect the amount of water drunk, but about a

gallon a day for each 100 pounds of live weight may be given under fair conditions.

The feeds most desirable for horses vary according to condition of age, work, and locality. Oats in the grain is the favorite food for horses both in America and Europe. There is no likelihood of danger from overeating oats, they are much relished, and from them the horseman looks for greater activity than from most feeds. Dry ear corn is popular in the corn-growing sections, especially in the South and Central West, where hundreds of thousands of horses see no other kind of grain. Experiments at the Ohio station, conducted by Prof. Carmichael, show no important difference in the feeding value of corn and oats, as fed work horses under equal conditions. Barley is fed horses in some parts of America, Europe, and northern Africa, and meets with favor. Wheat and rye are too pasty for satisfactory horse feed. Wheat bran has been fed mixed with oats and corn, and gives good results. Corn meal is too heavy for a horse feed, unless mixed with bran, oats or chaffed hay, when it will do very well. What is known as *chop feed* for horses in some sections consists of varying proportions of oats and cracked or crushed corn, the percentage of one to the other depending upon the value of each feed in the market. As a rule, two thirds oats and one third corn is a good proportion. Linseed meal is a most excellent feed to be given in small amount once daily, as, for example, a half pound a day. This is a fine appetizer, and tends to make the skin mellow and the hair sleek and glossy. Condition powders or prepared condimental stock foods are not to be recommended. The linseed meal will largely serve the same purpose and in fact is a popular conditioner.

Of all the dry roughages, timothy hay in the East is the leading favorite. It is usually free from dust and is relished by the horse. Any well cured, sweet grass, however, will usually prove satisfactory horse roughage. Good

dry corn stover is excellent horse feed. Alfalfa hay or red clover are rich in protein and lime, and may be fed to advantage when care is used. Dust must be avoided, and the leaves should be free of mildew or mould. A combination of alfalfa or clover with corn makes nearly a balanced ration for the work horse. There is considerable difference of opinion among American horsemen as to the suitability of these feeds for horses, but in France alfalfa has long been extensively fed to horses, while in the western United States it has been shown to be an excellent roughage for horses when well cured. Corn silage may be safely fed to horses in limited amounts, but it is important that it be bright and well cured, free of all mouldy matter; otherwise serious results may occur. Horses do well on pasture, especially of mixed grasses or of some sort of blue grass, of which Kentucky blue is the more common sort.

Feeding the brood mare. It is important to keep the brood mare in good condition. She should be kept at reasonably steady work, and fed so as not to lose in weight or appear thin and run-down prior to foaling. She may be fed as any work horse might be, and kept in good working order. If used for breeding purposes only, the brood mares are, as a rule, run on pasture for at least half the year, and are fed little grain if the grass is good, otherwise special feed is also given. A light feed of concentrates, especially oats or bran, is recommended. Only a light ration of these concentrates should be given just before foaling. The stall for foaling should be very clean and disinfected. At foaling time but a light mash should be given, to be followed by grain in small amount. If all goes well, the mare may gradually go on to regular full feed, and return to work in ten days or so. As the colt grows, the need for increasing the feed of the mare will become apparent. If she is a good mother, and nurses the colt well, furnishing plenty of milk, she will need much more good food than she would other-

wise. If one has some succulent feed, such as roots or silage, it will prove very good for the mare. The following are two good rations for a brood mare at work:

- (1) Corn 6 parts, oats 4, bran 4, timothy or prairie hay as desired.
- (2) Corn 6 parts, bran 3, alfalfa hay or clover as desired.



Figure 71.—A horse ration. (22) 60 lbs. corn, (26) 40 lbs. oats, (27) 40 lbs. bran. Photograph by the author.

Feeding the foal. For the first three or four weeks the foal will depend upon the mother's milk for food. When about three weeks old, it will begin to nibble grain

from the mother's feed box, if convenient. Then arrangements should be made to let the colt feed by itself. The mare may be tied, and a small feed box in which a little oatmeal is placed be fixed convenient to the colt. In a week or so some bran may be added to this. When about two months old the foal may receive a mixture of oats and bran in equal parts by weight. When in pasture a small



Figure 72.—Another horse ration. (26) corn, 60 lbs.; (27) bran, 30 lbs. Photograph by the author.

pen should be arranged in which the colt may be fed grain by itself. A common arrangement is to fence off with the lower rail high enough for the colt to pass under, but too low for the mare. At three months a mixture of equal parts

of cracked corn, crushed oats, and bran will be relished, to which may be added a small portion of oil meal, if desired. Bright, sweet, leafy clover or alfalfa hay in season should also be available to the foal, or, if these can not be supplied, then hay of fine quality is next best.

The colt in its younger days is kept close to the mare, and nurses as often as desired. It is not a wise plan, however, to drive the mare and foal to town and back on hot days or to cause unnecessary excitement for either. Also, the foal should not nurse the mother while she is heated and excited, else indigestion will be likely to occur. Foals are usually weaned at from four to six months of age, but the time of weaning depends on the amount of milk given by the mare and the condition of mother and colt. As a rule, the colt should nurse as long as there is an abundant supply of milk, for no other food can equal the mother's milk.

Feeding growing horses. After weaning it is important to keep the colt growing and building up a strong frame and body. Muscle-making foods, therefore, are what are needed, such as legumes, hays, and oats, bran, oil meal, cottonseed meal, and bean meal. Plenty of good roughage should be fed along with a small feed of grain.

At the Pennsylvania station Cochel and Severson fed some draft colts for a year and a half, during which time they made excellent development. The first winter the colts had a feed of 5 pounds of grain daily, in 2 feeds, consisting of 5 parts shelled corn, 3 parts oats, 2 parts wheat bran and 1 part linseed meal. At the end of 3 months this ration was increased to 7½ pounds per day. Silage and hay were also fed these colts. The second winter the grain consisted of shelled corn 6 parts, oats 2, and bran and linseed meal 1 part each. Emphasis is placed on the value of pasturage, and the wisdom of feeding all the grain the colts will consume when on pasture. Prof. J. L. Edmonds, of the Illinois station, who has conducted extensive experiments in feeding

horses, in reporting on feeding growing fillies, makes the following pertinent statement relative to feeding growing colts on Mississippi valley farms:*

“Alfalfa hay fed with corn and oats gave results of a character which indicates that there is little or no need of feeding purchased mill feeds to growing horses when alfalfa can be grown on the farm. When alfalfa hay is the roughage used, a considerable proportion of the grain ration may safely be corn. In this experiment the proportion was one half by weight.”

Feeding the work horse. Horses engaged in draft work should be fed a limited amount of roughage and sufficient concentrates to meet all needs. Of course the amount to be fed will depend upon the size of the horse and the work he is doing. It is recommended to feed from two to three pounds of food for each 100 pounds live weight, the amount of concentrates ranging from one half to two thirds of the total, according to the severity of the work. Hard working, farm or dray horses are usually fed roughage at morning and night, with concentrates at noon. The heaviest feed should be given at night, because the horse is then having his most restful period during 24 hours, and so should eat and digest his food to best advantage. Standard foods, common to the locality, and suited to horses, should be used. Oats meet with most favor in the stables of drayage companies, while on the farms of the South and Central West, corn is very generally used, supplemented in many cases with oats and a weekly bran mash. In reporting on feeding work horses at the Kansas station,† Dr. C. W. McCampbell states that the following daily rations were exceptionally well adapted for horses at hard work that weighed about 1,150 pounds:

- (1) Oats 4 lbs., corn 6 lbs., bran 4 lbs., timothy hay 12 lbs.
- (2) Corn 6 lbs., bran 3 lbs., linseed meal 1 lb., prairie hay 14 lbs.
- (3) Oats 2 lbs., corn 8 lbs., alfalfa hay 10 lbs.

Fattening horses. In some sections of the country, especially in Ohio, Indiana, Illinois, and Iowa, thin horses,

*Bulletin 192, Illinois Agr. Exp. Station. Feeding Pure-Bred Draft Fillies

†Bulletin 186 Kansas Agr. Exp. Station, 1912.

three to six years old of draft type, are bought and fattened by men who make a specialty of that business. Large numbers of such horses have been fed in northern Ohio, and then shipped to New York, Boston, and other eastern markets. These horses are usually placed in common stalls in the fall, and fed for about 100 days for the spring market. They are usually fed corn and oats heavily. They will often consume 2 pounds of grain for each 100 pounds live weight. When first put on feed fattened horses are given bran for a few days to cool them off and clean them out, after which they are put on a fattening ration of corn, oats, and bran and clover hay. When on full feed, a big draft horse will eat 10 or 12 good-sized ears of corn 3 times a day, 3 quarts of oats each morning and night, and 2 or 3 pounds of bran at noon. Horses thus fed are given very little if any exercise, and gain in weight about 3 pounds a day.

Watering the horse may be done at any time when he is not too warm, and even then a small amount may be



Figure 72.—The noonday drink. From a Scotch photograph.

allowed. It has been thought by some that horses should always be watered before rather than after feeding. Experiments have shown, however, that it really makes no difference. It is best to water frequently, so that the horse will not drink too much at one time. It is a good plan to water before feeding, and then again in two or three hours, if the horse is at regular work. "The one time at which a horse requires and appreciates a drink most," writes Dr. Carl W. Gay,* "yet is offered it least frequently, is the last thing at night, after having consumed his full allowance of roughage, and being ready to lie down to sleep. Every horse having worked through the day should be allowed an opportunity to drink at this time." Ordinarily water does not need to be warmed, but in winter in the colder North it is desirable to give water that has been warmed by a tank heater and is not icy cold. The amount of water a horse will drink will depend upon the temperature of the air, on his work, and food. A horse fed alfalfa will drink more than one fed timothy, and, if the food is succulent, such as silage or pasture, the amount of water is greatly reduced. Kellner reports† that a horse will drink for each pound of dry matter in its food from 4.5 to 6.5 pounds of water. Water is important in digestion, because it is the medium by which the food is softened, broken up, and moved through the digestive tract. As a part of the blood, water carries the nutrients throughout the entire body.

Salting the horse should be provided for, as he will eat a small amount of salt with relish. Salt is thought to aid digestion, and it makes palatable some feeding stuffs. Too much salt, however, stimulates drinking water in excess, and so may injure the digestive processes. Under ordinary conditions a work horse might eat an ounce or two a day to advantage. "Lick stones," or pressed cakes of salt have been largely sold in the past to men keeping ex-

*Productive Horse Husbandry, 1914, p. 243.

†The Scientific Feeding of Animals, By O. Kellner, 1910.

tensive stables of horses. These are placed in the manger subject to the use of the horse at all times.

THINGS THE HORSEMAN SHOULD KNOW

1. Where the horse industry is most prominent in America.
2. What is meant by horse-power.
3. The relationship of the ration to work performed.
4. Why some foods are better for horses than others.
5. The special value of linseed meal for horses.
6. How to feed the foal.
7. What feed to use to secure the best growth.
8. How much concentrates should be fed the work horse.
9. When the horse should be given water.
10. If salt is necessary for the horse.

MAKE A FEW OBSERVATIONS ON HORSE FEEDING ABOUT HOME

11. How many horses are there to the square mile in the county in which you live? Of what breeds or types are they?
12. Ascertain how many persons out of fifty in your section feed on the basis of the feeding standard.
13. What commercial feeds for horses are shipped in?
14. Can you report on any fattening of draft horses?
15. Study the methods men follow in giving their horses drink.
16. Report on the salting of horses among your farmer friends.

CHAPTER XIX

THE CARE OF HORSES

Many things might be written regarding the care of horses, because the subject is a very broad one and covers various items of interest and importance; but only a few of the more important features of management will be considered in the limited space here available.

Regularity in the care of the horse is very important. Under ordinary conditions when not on pasture he should be fed at the same hour. It is customary to feed three times daily at regular hours, and water before going to work and again upon return. Grooming also should be done at much the same time each day. Where daily exercise is necessary, as in the case of the stallion and horses not at work, it will be well to give this at regular periods. No animal on the farm adjusts itself to regular habits to more advantage than the horse.

The grooming of the horse is quite necessary if kept in the stable, although he always responds to this process. Dust and dirt on the skin tend to close up the pores, and thus to a certain extent affect the health and disposition of the animal. Body waste is thrown off in sweating, and a good brushing will remove this, stimulate the skin, and leave the pores open and in better condition to perform their work. If a horse is wet from sweat, it is a good plan to first rub him off with a half round scraper, following with a thorough rubbing with handfuls of dry straw. This rub leaves a horse in good condition for a final brushing. A hard metal currycomb is not a good tool for a horse, especially on his legs and more sensitive parts. It is better to brush him well with a good fiber or hair brush, although a dull curry-

comb may be used on the body. In connection with the grooming work, one should use a strong comb and brush for putting mane and tail in order. A heavy sponge is always useful for sponging off, and a strong linen towel makes a most useful dust cloth for polishing up the coat of hair. To clean out the hoofs, one may use a pick of some sort, such as a hay hook, for example.

Clipping the horse is necessary to remove the long hair in the spring, after it has begun to shed. Formerly this was done with hand clippers, but it is now usually performed with clippers propelled by machinery. Clipping is common-

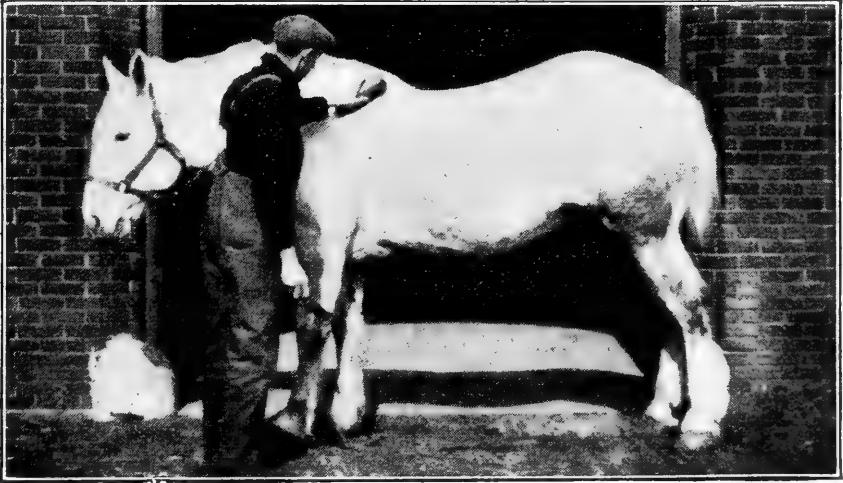

Figure 74.—Brushing off the brood mare. Photograph by the author.

ly done to get rid of the hairs which become annoying unless clipped, shedding off as they do by degrees, and more or less covering the clothing of persons driving. Vigorous brushing is a help, but long, thick hair had best be removed by the clippers. The horse feels better for it, there is less danger with a wet coat of his taking cold, and the obnoxious loose hair is done away with. The long hairs within the outer ear, which serve to keep out insects, should not be cut off. It is also desirable to leave the hair on the legs below knee and hock, for this gives protection to the

skin. If desired, clipping may be done in the fall, thus doing away with the necessity of this operation in spring.

Blanketing the horse is customary in winter in cold climates when the animal is unduly exposed. Special made horse blankets are used in cold stables, although these should not be necessary where the building is properly ventilated and drafts do not occur. Humane societies require the blanketing of horses in some localities, when exposed on the streets. A blanket keeps the coat of hair more sleek than when it is not used. In summer very light, durable blankets or nets are frequently used to give animals protection from flies. The man who blankets his horse to give protection from either cold or flies is no doubt kindly of nature and seeks to make his animals comfortable.

The care of the feet of the horse is of much importance. The foot of the horse is discussed on page 167. Its care is another matter. The hoofs should have a uniform development, and not lose their shape. Long toes, lack of uniformity of length of hoof on opposite sides, and low flat heels,—any one of these result in defective feet and improper gait. The hoof should be kept trimmed so as to secure a natural, uniform shape, with strong walls. The frog should never be cut, only the tag ends trimmed off, so that it may serve as a buffer when the foot hits the ground. The bars should not be cut down, and the sole made concave, a process which weakens the foot and narrows the heel, giving a more or less contracted foot. It is desirable to clean out each hoof with a pick every day and brush out all foreign matter.

If a horse stands on foul soil or manure, a disease called *thrush* may develop in the frog, and lameness result. Thrush appears as a dark colored pus of foul odor in the cleft of the frog, which presents a somewhat open appearance when it should be dry and close. For treatment the loose parts of the frog should be trimmed away, and the foot well cleaned and sterilized, after which copper sulphate may be packed

in the crevices of the foot. An absolutely clean, dry stall is a necessity for healthy, good feet. Sometimes the feet become too dry and brittle, in which case it is a good plan to soak them for a few hours at a time in a shallow pan or trough. Capable horsemen, who watch the feet of their horses carefully, occasionally rub neats-foot or sweet oil on the hoofs, which prevents their becoming too dry. The horse should be kept properly shod, and the feet inspected from time to time to note the condition of the shoes and see that they do not become loose.

The treatment of sores and wounds on the horse is a comparatively simple matter. A first requirement is cleanliness. In general a sore or wound should first be bathed with pure sterilized warm water. A wound or cut should be disinfected with some easily-obtained, healing solution. Common coal-tar sheep dip, or creolin, diluted 50 times, is a popular disinfectant. A three per cent solution of carbolic acid in soft water is also recommended for this purpose. Dr. Hadley states* that "bandages or other dressings must be changed as soon as they become saturated with the wound secretions. At this time the wound is cleaned with an antiseptic solution. The surface of the wound should be sopped instead of rubbed, to avoid irritation and injury to the newly formed granulation tissue. A dusting powder, composed of iodoform or boric acid, or equal parts of iodoform, boric acid, and tannic acid, may be sifted on the wound to check secretions and promote healing. If pus has a tendency to collect in pockets, these should be swabbed out daily or opened so as to allow free drainage." Tincture of iodine, as prepared by a druggist for bruises and wounds, is one of the most valuable healing and antiseptic remedies available. Where the harness rubs and tends to produce sores, as on the shoulders and neck, the pressure on the bruised part should be relieved. It is also a good plan to wash the shoulders, neck and withers morning and night with salt

*The Horse in Health and Disease, 1915.

water, using a tablespoonful of salt to a quart of water. In the case of serious sores or wounds the wisest policy will be to secure the services of a competent veterinarian for treatment if the expense incurred is not too great.

The sanitation of the horse stable is of much importance. In those stables where manure accumulates, and the floor is moist, a strong smell of ammonia is very common. Here we find an unsanitary condition, from which results a more or less unhealthy condition of the feet. The stall should be kept clean, the manure removed each day, and dry bedding of some form supplied. Bright straw or shavings are popular materials for bedding, and readily absorb moisture underfoot. Ventilation is especially important in the horse stable. The temperature of the horse stable should be cool rather than warm. Captain Hayes, a noted authority on horses, writing on the subject of the temperature of the stable, says:*

“I have had many opportunities in Russia for comparing the relative healthiness, during very cold weather, of hot stables and of those kept at a natural temperature. In large towns in Russia the practice throughout the winter is to have stables at a temperature of from 50 to 60 degrees Fahrenheit, the difference between the temperature inside and outside being not infrequently over 80 degrees Fahrenheit. Consequently, influenza, inflammation of the eyes, and diseases of the organs of breathing, especially roaring among big horses, are common in these abodes. In the Russian cavalry remount depots an entirely different course is pursued; for the stables at these places are immensely roomy, very lofty, and are ventilated so freely and kept so clean, that even in the early mornings, before the horses are taken out, the air inside is free from any suspicion of closeness. It is instructive to note that the horses kept in them maintain their health during the extremely cold winter in the same excellent manner they do in summer.”

The breaking and training of the colt is a most important feature of management. A few rules relating to this process is all that can be offered here. Colts differ widely in temperament and disposition, and each one is a problem in itself. It is a good plan to have a friendly relationship with the colt when it is very young, long before the process of training begins. It should be petted and made familiar with its future master, that confidence may be established. The

*Stable Management and Exercise, 1900.

use of the halter is first necessary, and it may be put on at a very early age, long before being weaned. Next, the colt should be taught to stand tied. Some colts, especially of the draft type, very readily adapt themselves to halter or bridle, as well as to the harness and work. Light horses of the hot-blooded sort, are not so easily educated. Prof. Roberts, an old horseman, says:*

“With rare exceptions, the colt on the farm is made usable if, for a few hours each day for a week, he is subjected to the restraints of a biting harness in the open paddock. The check and side-rein should

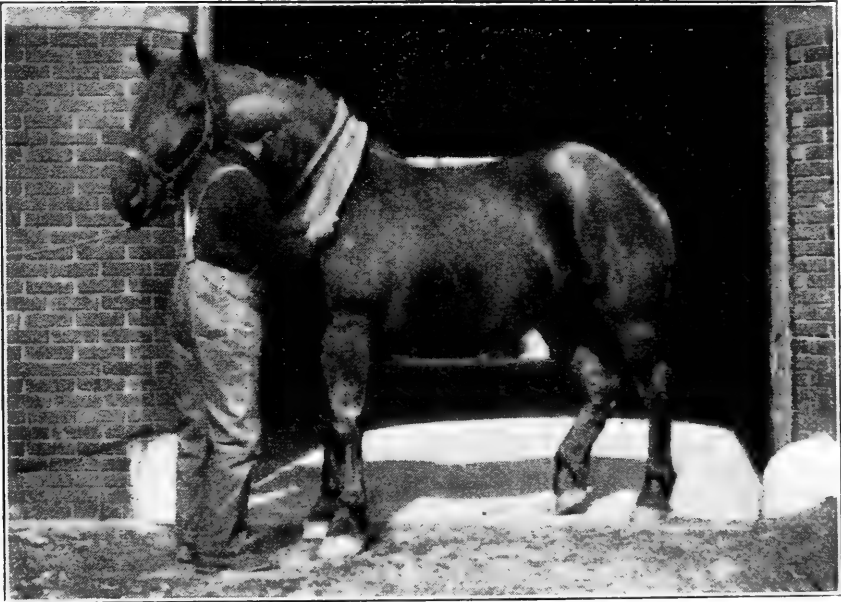

Figure 75.—Putting the collar on the young horse for the first time. Photograph by the author.

be left slack at first. Gradually from day to day the reins may be shortened; provided, however, they are never made so short as to place the head in an uncomfortable position or draw the bit so tightly into the corners of his mouth as to make them sore. After the biting, the colt may wear the harness and be driven with lines in the open field, without being attached to a vehicle. The next step is to drive him for a few hours each day by the side of a good-sized, staid, mature farm horse attached to a farm wagon, which should be furnished with a brake. The lesson of training should be continued without interruption until he knows what is expected of him. When given the command Whoa!, accompanied by a firm yet not rough pull on the lines, he should promptly stop. When the command “get up” is given, along with a slap of the

*The Horse—By Isaac Phillips Roberts, 1905.

reins, it means go forward. If it is desired that the horse back, then he is given the word "back," accompanied with a backward pull on the reins. The word "steady" is commonly used to caution a horse as to his movements, that he may not act too fast. With farm teams, the command "gee" signifies a turn to the right, while "haw" means a turn to the left. Ordinarily haw and gee are used in the field when the reins cannot easily be used, as in plowing, cultivating, etc. Horses should not be required to work until they have matured enough to bear the service without injury. If compelled to do hard work before he is four years old, his development may be much injured."

The harness of the horse in its simplest form, consists of three pieces, bridle, breast harness or collar, and saddle. These and their use may be briefly described as follows:



Figure 76.—A pair of draft horses in harness. Photograph by Prof. W. J. Decker.

The bridle consists of the bit, cheek straps, brow band, throatlatch, and checkrein. There may or may not be blinds. There are many kinds of bits, but under most conditions on the farm a plain single bar bit is all that is needed. Sometimes the bar is covered with leather or rubber as better suited to the tender mouth. By adjusting the length of the cheek pieces, the bit may be fitted to the mouth, so that it will be neither too loose nor too tight, crossing the bars of

the mouth just back of the tushes. Blinds are used by some persons, and some horses handle better with these on the harness than without them. A bridle without blinds is known as an "open bridle." The checkrein extends from the bits to the top of the saddle by way of the poll or through loops attached to the upper parts each side of the bridle. The checkrein is intended to assist the horse in holding up his head and neck in an easy, graceful manner, to keep him under restraint so he will not attempt to eat when at work, or move the head and neck about so as to disarrange the harness. A too tight check is punishment for the horse.

The breast harness consists of a flat strap which extends down over each side of the neck just in front of the withers, the ends supporting a breast piece, which connects with the tugs by means of which a light vehicle is pulled. The breast harness should be carefully adjusted, so that the breast piece will pull neither too high nor too low against the breast, interfering with free action of limbs or breathing.

The collar used in heavy work harnesses, in place of the breast harness, varies in the material. It should consist of a frame of leather or other material, shaped to fit the neck and shoulders. Most collars have sweat pads on top and sides, so that with work the neck and shoulders will not become sore. The exterior of the collar has a groove, in which fits a pair of hames. At the lower part of each hame is attached one end of the heavy tug of leather or other material, the other end of which is hooked to the vehicle or implement to be hauled. Much care must be used in the fit of collar. It should not chafe or bruise the skin or make the rougher parts of the shoulder or joint sore. The tugs should be so adjusted that when a load is drawn the animal's wind will not be shut off and the weight of the load will be properly distributed over the collar. Each horse should have his own collar, and care be taken to see that it fits the neck right. A new collar requires some time for adjustment.

The saddle extends over the back just behind the withers, on the top of which are two rings, through which the driving lines pass from the ends of the bits to the driver behind. The saddle, which crosses the back, is held in place by several pieces. The checkrein may slip over a hook at the saddle top. From the rear there extends a backstrap along over the spine to the center point between the hips, where another strap called the crupper is buckled, which passes under the tail. Thus we have a continuous line from mouth to root of tail, which assists in keeping the harness in place. The lower part of the saddle has its ends connected by means of a belly band, so that it may be held securely in place. A breeching piece which extends around back of the hind quarters, is supported in place by straps, the upper ends of which are attached to the backstrap at a point between the hips. There are many styles of harnesses and methods of harnessing; but, no matter what the style, it is of first importance that the harness fit right in all its parts, and that the horse or mule wearing it be made comfortable in its adjustment.

IN CARING FOR HORSES

1. How much regularity should be observed?
2. What is the effect of grooming?
3. When is clipping resorted to, and why?
4. How does a blanket affect the hair?
5. What should be done to prevent thrush?
6. Explain how you would treat a wound.
7. What attention should be given to stable temperature?
8. How should the colt be trained to use of the harness?
9. At what age should colts be compelled to do hard work?
10. What attention should be given to fit of the collar?

INTERVIEW SOME MEN ON THE CARE OF THEIR HORSES

11. How generally is regular grooming resorted to?
12. Is winter blanketing universal in your neighborhood?
13. Is the care of the foot left to the blacksmith alone?
14. What is commonly used for treating sores or wounds?
15. Are absorbents or disinfectants used in the stable?
16. How are colts "broken-in" by most horsemen?
17. What kind of bits are common, (a) for harness horses, (b) for draft horses?

CHAPTER XX

BREEDS OF BEEF CATTLE

The first cattle of which we have any information existed in Europe in prehistoric times. The bones and skeletons of two very different types of cattle have been found in Great Britain and parts of Europe. One of these was very much larger than the cattle of to-day, and has been called the Giant Ox. The other is much smaller and finer of bone. The skeletons of these two forms are quite similar to the cattle of our own time. Many bones of these animals have been found, and it is believed that even in the stone and the bronze age many thousands of years ago people had cattle more or less domesticated. Pliny and the earliest historians refer to swift and fierce wild bulls, called Uri, that were found in the forests and meadows of Germany and other parts of Europe at the beginning of the Christian era. The early Romans captured specimens of these wild bulls and took them to Rome and used them in their brutal festivities.

Wild White Cattle have been known in England, Scotland, and Wales since earliest historical times. These cattle lived in great parks. They had upright horns, were covered with shaggy hair, and were pure white in color, except the hair about the ears and muzzle, which was usually a dark red or black. Numerous small herds of these cattle are kept to-day in Great Britain, the most famous of which is at Chillingham Park in northeastern England. This herd, which numbers only 60 or 70 animals, runs wild on an estate of 1,100 acres. They have never been tamed, but live by themselves back among the hills in the forests and meadows. It is believed that these wild cattle are descended from the Giant Ox, and are the connecting link between the prehistoric

form and our domesticated cattle of the present time.

Shorthorn Cattle. This noted breed, formerly called Durham cattle, originated in northeast England, in the counties of Durham and York. The river Tees flows through a pretty valley, and for some distance is the boundary line between these two counties. This region, many years ago, was called the Teeswater country, and the large cattle found here in northern Yorkshire were known as "Teeswater Cattle." In southern Yorkshire, in what is called Holderness, was another kind of cattle having some things in common with the Teeswater. Many of these were black. There were also red or red-and-white cattle in other sections not far from here.



Figure 77.—A herd of Wild White Cattle at Vaynol Park, Wales. Photograph by the author.

Some cattle of superior milking qualities were brought over from Holland, also, in the middle of the 18th century. From these various sources came the Shorthorn. In this section of England the grazing was fine; and the city of Darlington, by the river Tees in Durham, became in time a great cattle market and gathering place for stockmen.

The improvement of the Shorthorn began over a century ago. Two brothers, Charles and Robert Colling, who lived on separate farms north of Darlington, did much to improve

the native stock between 1775 and 1820. Some have called them the founders of the Shorthorn breed, but this claim is probably incorrect. They improved the local cattle so that they matured earlier, fed better, and had less waste at slaughter than the parent stock with which they began.

Thomas Bates lived in this same region, east of Darlington, and he bred a type of large, handsome cattle, noted for both beef and milk production. Shorthorns of his breeding during the latter part of the nineteenth century were criticised for lack of vigor. He produced the Duchess, Waterloo, Wild Eyes, Oxford, and other families. Bates died in 1849.

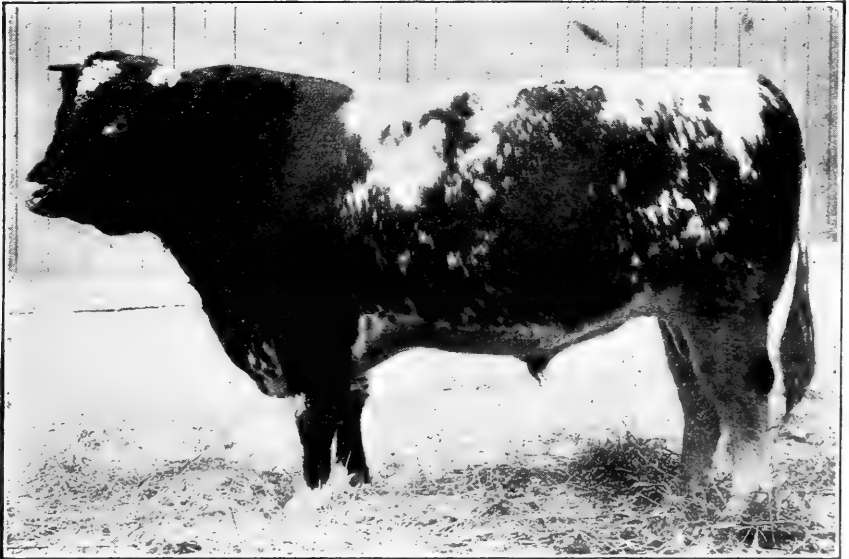

Figure 78.—Shorthorn bull Ringmaster, a noted champion bull and sire. Owned by White and Smith of Minnesota. Photograph from *The Farmer*.

Thomas Booth, another great breeder, began to keep Shorthorns about 1780 on a farm in Yorkshire, southeast of Darlington. He had two sons, John and Richard, who also became famous breeders. Their cattle had thicker chests, were somewhat rougher in form, and perhaps better feeders than the Bates cattle, and became very popular. The Booths produced the Anna, Isabella, Bracelet, Moss Rose, and some

other families. The Collings, Bates, and the Booths were famous as among the greatest improvers of Shorthorn cattle that have ever lived in England.

Early in the nineteenth century a Scotchman by the name of Robertson introduced the first Shorthorns to Scotland and began breeding them on his estate at Ladykirk on the banks of the Tweed. This was in the South. In 1829 Captain Barclay brought the first cattle of the breed to north Scotland. In 1837, up in Aberdeen, where the winters are cold and rough, and the soil not the richest, Amos Cruickshank began breeding Shorthorns, and at the time of his death was the greatest breeder in the history of Scotland. He developed what are known to-day as "Scotch Shorthorns." They are noted for their early maturity, compact forms, strong constitutions, and fine killing qualities. Scotch cattle seemed to produce less milk than those bred by Bates, but were thicker-fleshed, so that butchers liked them better. Cruickshank produced quite a number of the most popular families of to-day, among which the Brawith Bud, Clipper, Duchess of Gloster, Lovely, Orange Blossom, Spicy, Venus, Victoria, and Violet may be mentioned. Two other great Scotch breeders have played a leading part in Shorthorn history, on account of their constructive breeding, William Marr, of Uppermill, and William Duthie, of Collynie.

The distribution of Shorthorns is world-wide. It is the most common breed of English-speaking countries, and more great improvers of live stock have been found among Shorthorn breeders than any other one breed. So common is the Shorthorn, and so well is it suited to different conditions, that long ago it was nicknamed "The Universal Intruder."

The introduction of the Shorthorn to America occurred in 1783, when a few were imported into Virginia by Gough and Miller. These men imported still others about 1792. From this time on the Shorthorn continued to be brought to the American states along the Atlantic coast. In 1834 a very

important shipment came to Ohio, selected for the Ohio Importing Company. Since then many thousands of Shorthorns have been imported, and are found distributed widely in North and South America.

The characteristics of the Shorthorn are very marked. The color is red, red-and-white, pure white, or a mingling of red and white hair forming what is called a roan. No other breed possesses this peculiar Shorthorn roan color, which has long been very popular among the breeders. In size this is one of the largest breeds, and bulls at maturity should weigh in ordinary condition 2,000 pounds or more,



Figure 79.—A fine Shorthorn matron on an Ohio Farm. Photograph by the author.

and cows 1,400 pounds and upward. The head should be lean and shapely, and short from between the eyes to the muzzle, which should be of flesh color, dark noses being unpopular. The horns usually are of medium size and of a white or waxy color, in most cases curving around in front like a semicircle rather than standing upright. Shorthorns should have wide strong backs and large bodies. • The hind quarters are noted for their thick, meaty development, though the rump and tail head tend to be patchy and rough.

Shorthorns have been criticised for having plain, somewhat prominent shoulders, and for being rather long of leg. These criticisms, however, do not so generally apply to cattle of Scotch ancestry. In disposition the Shorthorn is unexcelled. As a butcher's beast fair examples of the breed rank high, the fattened animal dressing out well at slaughter and producing a superior quality of meat that is a favorite on the market. Although especially suited to the range, Shorthorns do almost equally well under conditions of arable farming, where extensive use of pasturage or range is not available.

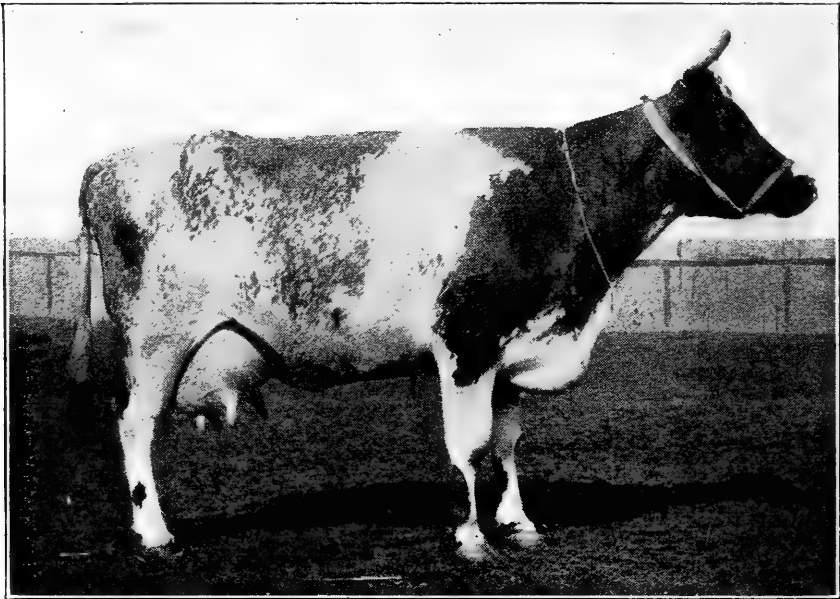

Figure 80.—A first prize Milking Shorthorn at the show of the Royal Agricultural Society of England. Photograph by the author.

The Shorthorn in milk production ranks at the top among the beef and so-called dual-purpose breeds. It is a common thing for dairy Shorthorns to produce 5,000 or 6,000 pounds of milk a year. Many cows of the breed have produced over 10,000 pounds, while Rose of Glenside made the wonderful record of 18,075 pounds in a year. There have been some remarkable records of production during continuous

years, among which Darlington Cranford 5th gave over 100,000 pounds of milk during ten years. Shorthorn milk tests around 4 per cent fat, and many excellent butter-fat records have been made. At least 300 pounds of fat should be made in a year by a fair example of the breed. An Australian cow, Melba VII, produced 868 pounds in a year, and Rose of Glenside, in her test above referred to, made 735 pounds of fat. Milking Shorthorns have grown greatly in popularity in recent years. Among the more favorably known families are the Clay, Waterloo, Kinsella, and Buttercup.

Remarkable prices have been paid for Shorthorn cattle now for over a century. In 1811 at the sale of Charles Colling the bull Comet sold for \$5,000. In 1873 at the New York Mills sale, 109 animals sold for \$381,990, an average of \$3,504, the cow Eighth Duchess of Geneva bringing the top price of history for a cow, \$40,600. In 1919 the bull Gartley Lancer sold in Scotland for \$23,750, while two other bulls brought \$21,000 each.

Polled Shorthorns are bred and registered separately, although from pure Shorthorn ancestry. They were first called Polled Durhams, but since 1919 have been known as Polled Shorthorns. They do not differ from ordinary Shorthorns except that they are polled. They have not greatly grown in popularity.

The Hereford breed of cattle originated in the county of Hereford, in southwest England. There are many beautiful meadows and grassy hills in this region. The cattle graze here the whole year and are rarely kept under roof. We know but little of the origin of this breed. Cattle have thrived in this part of England for centuries. One noted English judge of live stock over a hundred years ago gave the opinion that the Hereford might have been the first breed on the island. Some time before 1671, white-faced cattle were brought from Holland to Hereford, and some think the Herefords get their white faces from these cattle. Late in

the eighteenth century, the common color of the breed was red with a white face. As with the Shorthorn, a number of men became noted Hereford improvers and did much for these cattle. The Tomkins family is the most famous of early days. There was Benjamin the Elder, who died in 1789, and Benjamin the Younger, who died in 1815. These men produced many famous animals and did much for the breed. William Galliers, John Price, and John Hewer also



Figure 81.—Hereford bull, Richard Fairfax, purchased for \$50,000 by Ferguson Brothers of Minnesota from L. A. Pinnard. This is the highest price paid for a beef bull in the United States. Photograph from Ferguson Brothers.

did much to improve the Hereford. John Hewer sought for more size, quality, and uniformity of color. He bred many famous animals during the middle of the last century. Herefords were first brought to America by that famous statesman, Henry Clay, of Kentucky. He took much interest in pure-bred live stock. Mr. W. H. Sotham, a native of Hereford, who emigrated to America in 1840, brought some of

these cattle to Albany, New York. Mr. Sotham did much to make the breed popular in this country during the middle of the nineteenth century.

About 1875, men in Illinois, Indiana, and the West, who owned a great deal of land, became interested in the Hereford. Since then these cattle have become very popular in the grazing sections of the West, and are found in large numbers beyond the Mississippi, although choice breeding herds are to be found in Indiana, Kentucky, Minnesota, and Illinois. Recently the Hereford has obtained an important foothold in the Gulf Coast states east of the Mississippi.

The characteristics of the Hereford are very marked. The color is its most striking feature, the head being white, as is often also the top of the neck, the breast, brush of the tail, and legs below knees and hocks, the rest of the body being red. The red color varies from light to dark, the preference being for a bright cherry red. The skin at the muzzle should always be of a clear flesh color. The white head, which is short from muzzle to eye, often somewhat dished of face, and crowned with beautiful, forward curving waxy-white horns, represents the ideal for stamina, sex character, and feeding capacity. In size and weight the Hereford closely resembles the Shorthorn. Hereford cattle are conspicuous for their wide backs, deep bodies, and short legs. They frequently show considerable dewlap and brisket, and have beautiful smooth shoulders. The hind quarters, however, tend to be somewhat narrow and rough. They are noted for their hardiness and adaptability to all sorts of grazing conditions, thriving well with the least grain and shelter. The heavy curly winter coat of hair and thick mellow skin gives the Hereford protection which other breeds lack in an equal degree. Hereford cattle mature early and are noted for baby beef production, attaining 1,000 to 1,200 pounds when well fed, at less than two years of age. In the market Hereford steers are popular with buyers, and kill

out a high percentage of carcass to offal. The cows of the breed are inferior milkers, as a rule, though yielding an excellent grade of milk. In disposition Herefords tend to be more or less nervous and restless as compared with the Short-horn and are not so well suited to stable confinement.

The quality of "rustling," as they say in the West, fine constitution, and ability to make early beef, have made the breed extremely popular in the range country in the United States, Canada, Argentina, and Australia. Among the popular families are the Anxiety, Beau Donald, Corrector, Disturber, March On, Perfection, and Prime Lad. High prices have been paid for Herefords, and in 1917, 1918, and



Figure 82.—An exhibitor's herd of Herefords at the fair. Photograph from *The Farmer*.

1919 very high prices prevailed. In 1919 Mousel Brothers, of Nebraska, sold 50 head for an average price of \$3,845, and in 1919 W. T. McCray, of Indiana, sold 120 head for an average of \$3,635, the record for any breed of cattle. In 1919 the bull Richard Fairfax was bought by Ferguson Brothers, of Minnesota, for \$50,000, then the world's record price for a bull. Two bulls sold in 1918 in England, one, Ringer, for \$45,000 and the other, Resolute, for \$40,000.

Polled Hereford cattle of much merit are bred to-day in large numbers. This line of breeding first started with grade

cattle in Kansas. About 1900, through an effort to secure pure-bred stock from regular Hereford ancestry, a number of polled bulls and cows were secured by Warren Gammon, of Iowa. Since 1900, when a Polled Hereford Association was organized, cattle of this type have been built upon a pure foundation tracing back to horned Herefords. Polled Herefords are now widely bred in America, with Iowa the central point of importance.

The Aberdeen-Angus is a Scotch breed of cattle that was first developed in and about the county of Aberdeen, in northeast Scotland. This section is about a thousand miles north of the latitude of Chicago. The winter climate of this region is rather severe, and the soil is not the best, though the grazing is good. Some think these animals are descended from



Figure 83.—A Polled Hereford bull. Photograph by the author

the Wild White Cattle. It is a hornless breed. They first became celebrated through Hugh Watson, a tenant farmer at Keillor. He loved his cattle and studied carefully the improvement of his herd. As a result he produced more early-maturing, heavier-fleshed, and more compact cattle than had before been known in Scotland. He had a cow named "Old Grannie" that lived to be 36 years old, and was the mother of 25 calves, a wonderful record for a cow of any breed. William McCombie was another famous breeder of

Aberdeen-Angus cattle. He improved on the work of Watson, and his cattle became celebrated for the prizes they won in the shows of Scotland and France. Sir George McPherson Grant, who died in 1907, was the most noted breeder of recent days, and from his herd came some of the greatest cattle of the breed.

The first Aberdeen-Angus cattle were imported to America in 1873, by George Grant, of Kansas. Later in the seventies a few head were taken to Canada, New York,

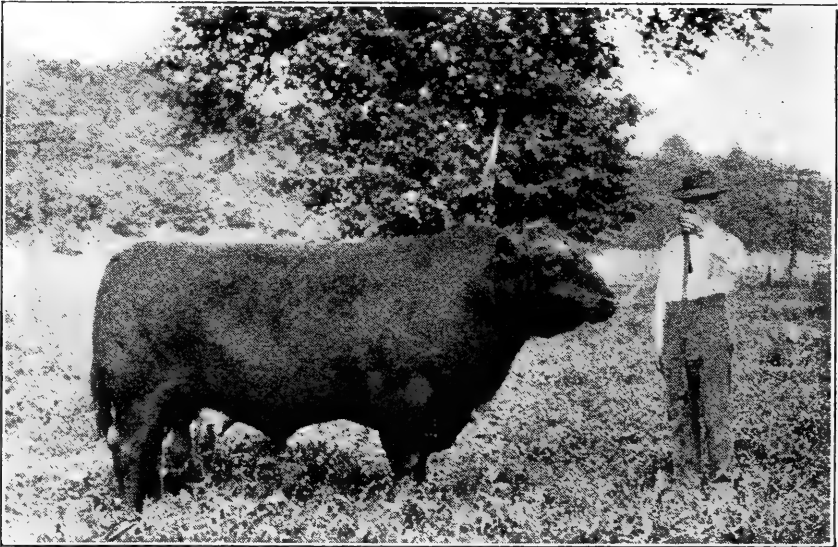

Figure 84.—Aberdeen-Angus bull, Balatum, owned by J. S. Caldwell & Son of Ohio. Photograph by the author.

Illinois, and other states of the central West. It is only in rather recent years that these cattle have become popular in America and recognized as one of the really great breeds.

The characteristics of Aberdeen-Angus cattle are especially marked in color, head character, and quality of flesh. The standard color is a hard, clear black, although at rare intervals red will occur. This red is inherited from past generations, for at one time there were many reds, browns, and brindles among the cattle of Aberdeen. The head is

polled, although abortive horns, or scurs, occasionally develop. Even though coming from pure-bred sire and dam, the red color or scurs prohibit registering in the books of the American Aberdeen-Angus Cattle Breeders' Association. In size, cattle of this breed are essentially in the same class as the Shorthorn and Hereford, although they in fact weigh slightly less under average conditions. Aged bulls will weigh about 2,000 pounds, and cows around 1,400, although it is claimed that some bulls of the breed have weighed up to 3,000 pounds, this weight being credited to the noted bull Justice.



Figure 85.—Aberdeen-Angus cow, Queen Milly of Sun Dance 3d, owned by C. D. and E. F. Caldwell of Missouri. Photograph from the owners.

In body conformation the Aberdeen-Angus cattle are inclined to be a trifle prominent in the shoulder, their backs are only moderately wide, the loin being rounding rather than flat like the Shorthorn and Hereford. There is a tendency towards a sag in the back, the hind quarters are round and full, though the tail-head is often somewhat prominent, due to a falling away on each side of the rump.

These cattle stand on short legs, and are very compact. They graze well, mature early, fatten smoothly, produce meat of the choicest grade, and kill out with the least waste. The Aberdeen-Angus is a great favorite with the butchers on account of the smoothness of carcass and small per cent of waste in dressing. In the fat stock shows in recent years, in America and England, no other breed has won so many grand championships. In slaughter tests the bullocks have dressed out 72 per cent carcass to offal, which is a very high record. Many of the cows are good milkers, and produce

an excellent grade of milk. In disposition the Aberdeen-Angus are notably nervous, more resembling the Hereford than the Short-horn in this respect.

These cattle are growing much in popularity. With Iowa

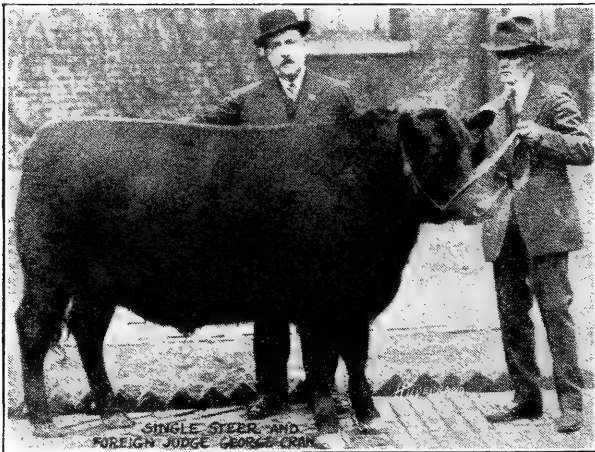

Figure 86.—Fyvie Knight 2d. Grand champion steer, 1918 International Live Stock Show. Shown by Purdue University, Indiana. Photograph from American Aberdeen-Angus Association.

as the great breeding center, many fine herds are found in the corn-belt states. There are some excellent herds in the southern states, where the breed has comparatively recently obtained a foothold. Among the more popular families of Aberdeen-Angus cattle are the Erica, Queen Mother, Pride, and Blackbird. During recent years very high prices have been paid for these cattle, the highest being for the bull Blackcap Bertram sold in 1919 for \$45,000. Some of the bulls have sold for over \$10,000 each, while this sum represents the highest price paid for a cow, being paid in 1919 for

Blackcap McHenry 151st. Aberdeen-Angus show steers topped the market many times, the highest price ever known, \$2.50 per pound live weight, being paid for the grand champion steer Fyvie Knight 2nd, exhibited by Purdue University at the 1918 International Live Stock Exposition.

The Galloway is a beef breed that originated in southwest Scotland in what is known as the Galloway country. It is a hilly region, with plenty of grass, and has a somewhat cool and rather moist climate. These cattle have been bred here for centuries. They are black, though other colors formerly occurred, are polled, have long, shaggy coats of curly hair, and are hardy and rather wild by nature. They are not quite as large nor so compact of body as the Aberdeen-Angus, and do not fatten so easily. They produce a very high grade of beef, fine of grain and inclined to be free from extra fat, such as is often found in highly fed Shorthorns or Herefords. The Gallo-



Figure 87.—A Galloway steer. Photograph by the author

way is a breed that can endure severe winter conditions better than most others, on account of the protection of a thick hide and a long, thick, silky coat of hair. Very beautiful robes are made from Galloway hides with the winter coat of hair. This breed was first brought to America about 1850, or perhaps some years before. It is not popular and the herds are rather scattered, more being in the northwestern states and in Canada than elsewhere. The exhibit of the breed at the fat-stock shows and fairs is usually small compared with the Shorthorn, Hereford, and Aberdeen-Angus.

**IMPORTANT POINTS TO REMEMBER ABOUT
THE BEEF BREEDS**

1. The relationship of Wild White Cattle to improved breeds of to-day.
2. The difference between Teeswater and Holderness cattle.
3. The parts played by the Collings, Bates, Booths, and Cruickshank.
 - (a) When and where did they live?
 - (b) What did they do?
 - (c) What families did they produce?
4. A few marked characteristics of the Shorthorn.
5. Striking points of identity of the Hereford.
6. Why the Hereford is a superior breed for the range.
7. What Hugh Watson and William McCombie did for the Aberdeen-Angus.
8. How the Aberdeen-Angus passes the killing test.
9. The conditions under which the Galloway originated.
10. The kind of coat worn by the Galloway.

ASSUME YOURSELF TO BE A CENSUS TAKER AND

11. Find out if any pure-bred herds, and what kind, occur in your neighborhood or township.
12. Make a map and locate the herds upon it.
13. Ascertain what kinds of pure-bred beef bulls are used in grade herds, and why?
14. Report on what you think the best pure-bred beef herd in the county, and your reason why?

CHAPTER XXI

JUDGING BEEF CATTLE

In judging beef cattle, we have different classes and conditions of animals. Examples of these may be found in mature bulls or cows, and young stock in breeding herds; and in fat cattle ready for the butcher, or in feeders that are not yet in condition for killing. If of about the same age and condition of flesh, however, we shall find that they

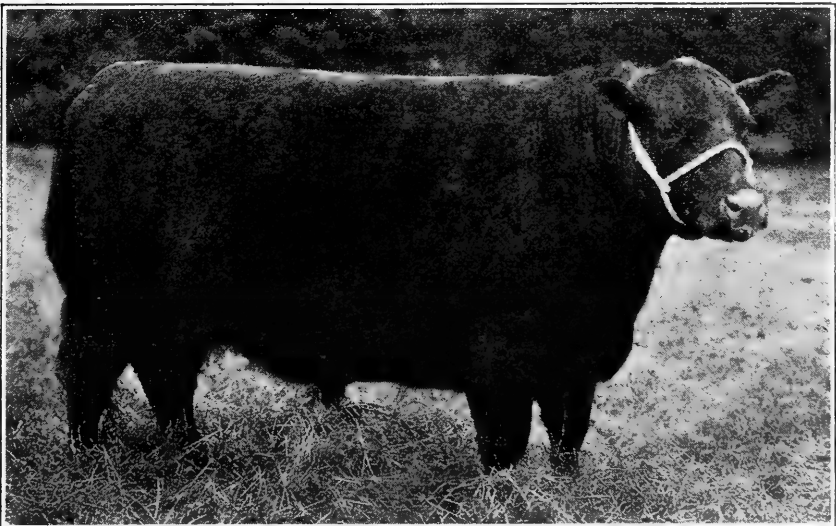

Figure 88.—Victor, Grand champion steer at the 1911 International Live Stock Exposition. Fed and shown by Iowa State College. Photograph from *The Farmer*.

have much in common in type and form. In a study of beef cattle through the use of the score card and the scale of points, it is customary for classroom work to make use of as good examples of such animals as are obtainable, judging them as fat cattle. The following scale of points is especially arranged for the scoring of fat cattle, and its use is discussed herewith.

A SCORE CARD FOR FAT CATTLE

<i>Scale of Points</i>	<i>Points of perfect score</i>	<i>Score of cattle judge</i>
GENERAL APPEARANCE, 38 Points.		
Weight, score according to age. At 12 months 850 lbs., at 24 months 1,250 lbs., at 30 months 1,500 lbs.	8
Form , broad, deep, compact, low set, top and underline straight.	10
Quality , fine bone, mellow elastic hide, soft and silky hair.	10
Condition , deep, even covering of smooth, firm flesh, the cod and flank indicating finish.	10
HEAD AND NECK, 7 Points.		
Muzzle , broad, mouth large, nostrils large.	1
Eyes , large and bright, with placid expression.	1
Face , short, wide, slightly dished; cheeks fleshy; jaw strong.	1
Forehead , broad, full.	1
Ears , medium size, not coarse, well set.	1
Neck , thick, short, throat clean, blending well with shoulders.	2
FORE QUARTERS, 9 Points.		
Shoulder vein , full and smooth.	2
Shoulders , well set, compact on top, smoothly covered with flesh.	3
Breast , wide and full, brisket extending forward, with little dewlap.	2
Legs , straight, short; arm full; shank fine, smooth; toes pointing directly forward.	2
BODY, 31 Points.		
Chest , deep, wide, girth large, crops full.	5
Back , broad, level, thickly and smoothly fleshed.	8
Loin , broad, thick.	8
Ribs , long, well arched, thickly and smoothly fleshed.	8
Flanks , deep, full, underline straight from front to rear.	2
HIND QUARTERS, 15 Points.		
Hips , smoothly covered, not wide apart, nor prominent.	1
Rump , long, wide, level, free of patchiness, tail head smooth.	4
Thighs , thick, broad, deep, full.	4
Twist , deep, full.	4
Legs , well placed, short; hocks straight; shank fine and smooth; toes pointing straight forward.	2
Total.	100

In judging fat cattle, either by the score card or otherwise, the general appearance should be first considered. As one walks about the animal, or as it may be observed in parade, the size is compared with what one thinks it should be for its age requirements, while special note is also taken as to the general form, quality, and condition. The subject of weight is a comparative one, but in judging it is customary to discriminate against the animal that is too small for its age or that shows evidence of being naturally undersized.

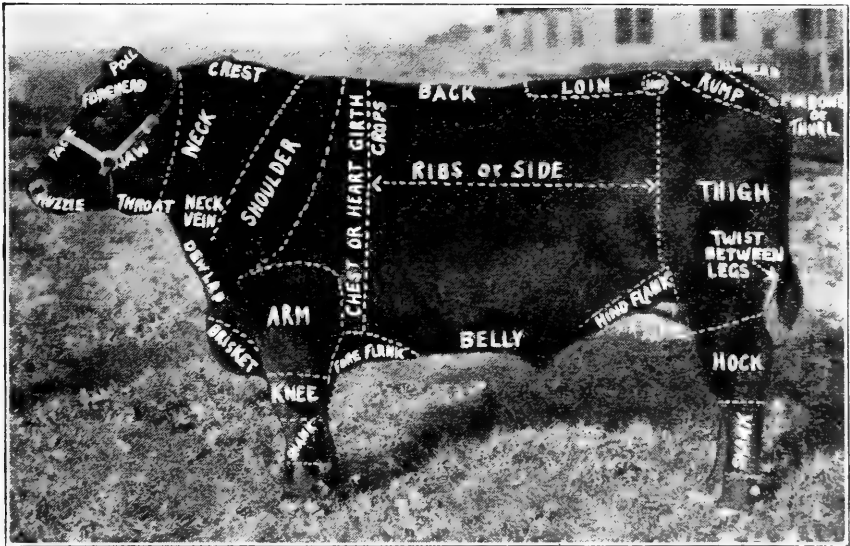

Figure 89.—The points of a beef animal. Reproduced from "Judging Farm Animals," by the author.

The form of the beef animal, as indicated by the score card, should show breadth, depth, and compactness. Then, if this includes an excellent degree of fatness over the body, known as condition, the butcher will obtain from such a carcass the greatest percentage of the most valuable cuts. Some writers on live stock have compared the body of fat cattle to a rectangle, when viewed from one side. The body of the animal, excepting the head, neck, and legs, would very well fill a rectangular form. Viewed from either the

front or the rear, the body should fill a square. Long ago English writers made use of this illustration of correct beef-cattle form, and judges of to-day very generally approve of the same description.

If we should examine a body that is usually described as "blocky", it would be noticed that those parts containing the highest-priced meats are well developed. The

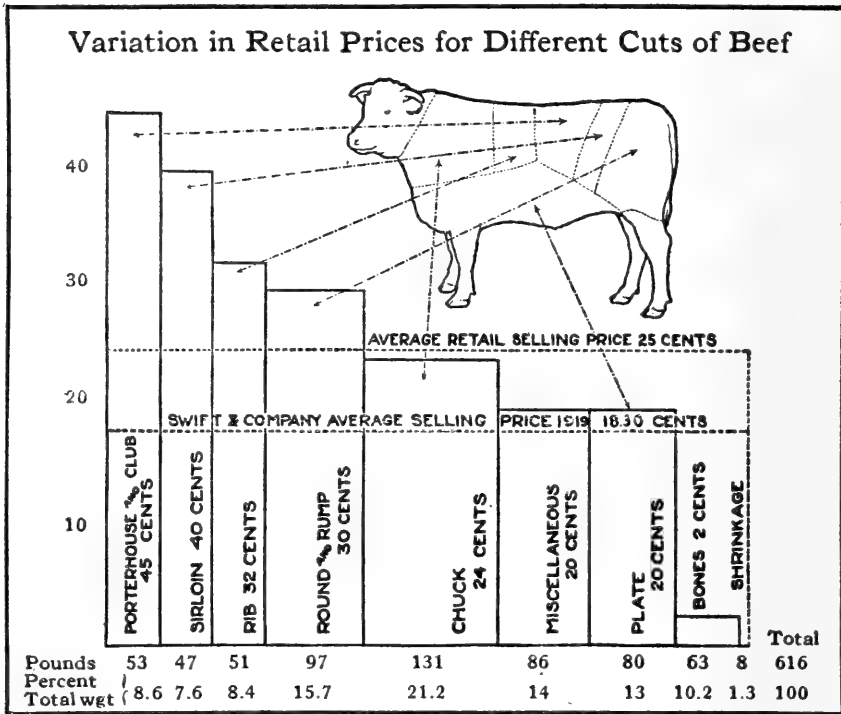

Figure 90.—Cuts of beef and their relative values in 1919. By courtesy of Swift & Company.

part from the hips forward to the last rib comprises the loin. The highest-priced meat is found here, and makes up about 16 per cent of the carcass. The section of the back and ribs from the loin up to the sixth rib, known as the rib or prime-of-rib cut, makes up about 9 per cent of the carcass, and is worth several cents less a pound than the loin. The part of the back at the shoulders, the chuck, makes up about 21 per

cent of the carcass, and is still cheaper than the prime-of-ribs. If we view the steer from behind, the rump and quarters fill out into one of the heaviest and meatiest parts, comprising 16 per cent of the carcass, and ranking third in value of the different cuts.

Thus it can easily be seen that the more completely the frame of the animal is developed in these parts and covered with a thick, smooth, uniform layer of good meat, the greater its value will be for beef. The head,

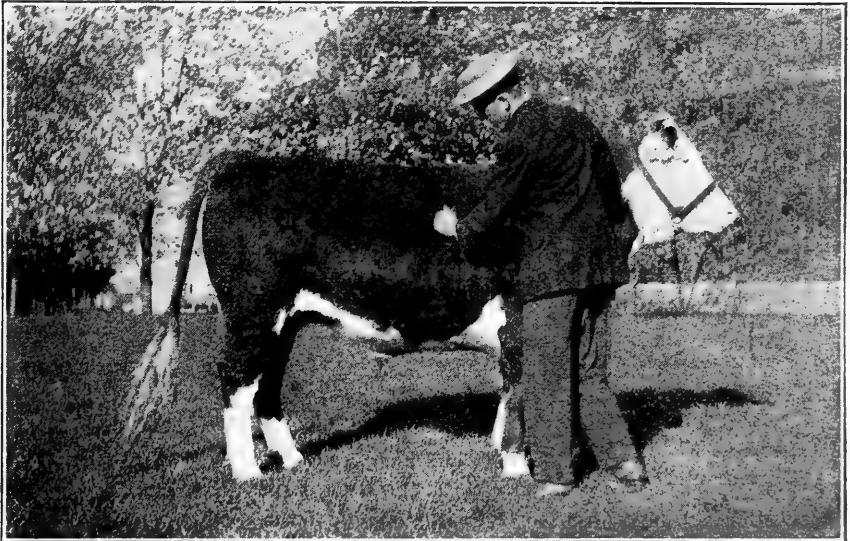

Figure 91.—Judging beef cattle. Handling the hide to study quality and thickness. Photograph by the author.

neck, belly, and legs are classed as cheap meat, and, therefore, these parts need not be heavily developed. The animal with big paunch and long leg is discriminated against by buyers, who realize that in killing considerable waste is sure to result. High-class fat cattle will kill out as much as 70 per cent, or even more, of carcass to offal, while a common or inferior animal of leggy conformation will dress around 50 per cent. Thus the butcher who caters to a discriminating trade usually prefers to buy the better class of animals, which dress out 60 per cent or more.

The indications of quality in beef cattle are fineness of bone; a silky, heavy coat of hair; a mellow, elastic skin; and refinement, as seen in the head in particular, and in the entire form in general. Large ears, heavy bones and joints, a hard thick skin, and coarse wiry hair are all evidences of a poor digestive capacity and lack of quality. In the case of beef cattle, smoothness and uniformity of covering are also indications of quality. In the carcass, fineness of grain of



Figure 92.—Judging beef cattle. Feeling for thickness of flank. Photograph by the author.

flesh and a good distribution of fat particles among the fibers are measures of the quality of the meat. If the ribs and back have lumps or rolls of fat, and the rump is also rough, then the quality of carcass will be of inferior grade. Such a condition should be easily observable.

The condition of a beef animal refers to the covering of flesh or degree of fatness. Thin animals are spoken of as in thin condition, while fat ones are in fat condition. The condition is determined mainly by the eye of the judge.

The well-fattened animal shows plumpness of body. His more exposed portions, like the hips and shoulder points, are covered with flesh. When a fat steer moves, the flesh about his breast and in his flanks shows more movement than is seen in a thin-fleshed animal. The hand may also assist the eye in inspecting fat cattle. When using the hand, the ends of the fingers are kept together, and are pressed along the middle of the back and on the sides over the ribs.

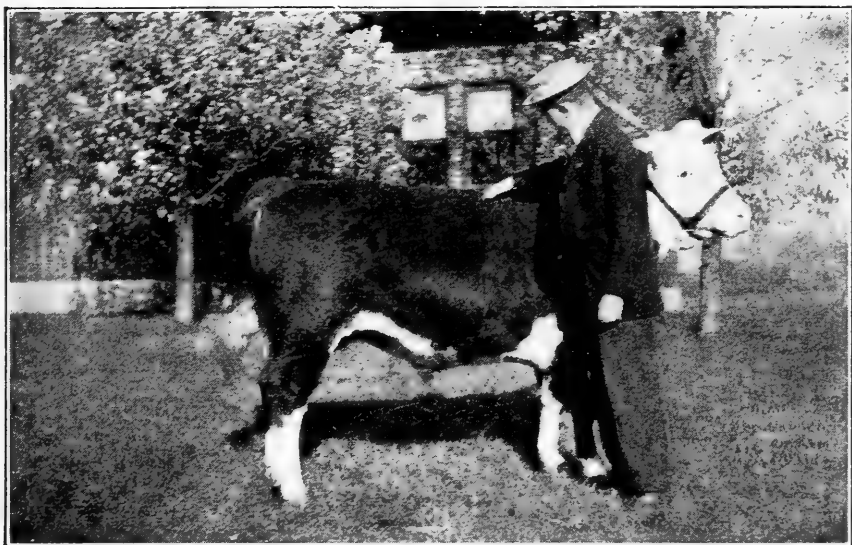

Figure 93.—Judging beef cattle. Feeling for depth of covering of the back. Photograph by the author.

The thickness and firmness of covering is easily determined by the touch. A mellow, yet firm resistance to the hand pressure should be felt. A common custom among buyers of fat cattle is also to feel the covering of the end of the rump and the point of the shoulder, and to grasp in the hand the hind flank, which should be low and full in a well-finished beast. A thin, hard covering at these points shows that the animal lacks in condition.

After giving the necessary consideration to general appearances, our attention will next be given to the detailed

features of conformation. Beginning with the head, we seek for evidences of the good feeder and a pleasant disposition. A broad muzzle, with shortness from this point to the eyes, usually indicates constitution and feeding capacity. A clear, prominent eye denotes a pleasant disposition; and the broad, full forehead, a comparatively high degree of intelligence. The eye is an important guide to the disposition, and should be carefully considered. The ears



Figure 94.—Judging beef cattle. Inspecting the rump and feeling for condition. Photograph by the author.

are a guide to quality; for, if large and thick and heavy at the base, they indicate coarseness. The reason for desiring a short neck is to reduce the amount of cheap meat. The short, thick neck is also an evidence of constitutional vigor, for it is connected with a wide, full breast. Back of this should be a capacious chest, with ample room for the vital organs. A strong, vigorous constitution is very important with all kinds

of stock. One must see the character of neck from the side and top, and may easily note the way it joins both head and shoulders. From the side, one notes the placing of shoulders, their slope and smoothness of covering, the blending of the neck with the shoulder at the so-called "shoulder vein," and the spread between the blades at the top. The wide-spread shoulder top is not desired, because it means lack of covering of flesh and indicates a narrow floor of the chest. From in front, the fullness of breast, the car-

riage of brisket, and length of leg are easily seen. The brisket, being the portion that extends forward between the fore legs, is the sternum proper, and with the best of fat cattle is usually thick and prominent. Beginning at the brisket, extending upward from the front of the neck, is a thin fold of skin known as the dewlap, which is undesirable to have in any great amount. As a rule, the dewlap is not prominent on beef cattle, being more in evidence on lighter-



Figure 95.—Judging beef cattle. Feeling covering at the shoulder. Photograph by the author.

fleshed stock, and in certain breeds. The front legs should be short, and the feet stand squarely on the ground, the toes pointing straight ahead. The bone just below the knee, known as the shank, which is termed the cannon bone with the horse, should be reasonably fine and short, an important indication of quality. When the front legs stand well apart, we usually find plenty of chest capacity. The body of the beef animal requires large size and capacity, the wide back giving room for the valuable cuts already described. Full-

ness and depth of body also go with the digestive capacity sought for in a good feeder. A study of the body capacity and value should be made from one side and from above the animal, to observe the thickness and spring of rib. Emphasis may be placed on this last feature, for a well-sprung, long rib means thickness and depth of body. Shortness of coupling from the hip to the nearest rib is also important, if we are to have compactness of form. An examination of the hind quarter is made from a point opposite the thigh, and from directly behind. Good length from the hips to the

end of the body near the tail, to what are called the pin-bones, is important; for here we find large, heavy muscles of very good quality for meat. The longer, broader, and fuller this part, the more flesh one should expect to find. The thighs, which extend to the hocks, should show length and thickness. From a side view, the distance from the point



Figure 96.—Roan James, reserve grand champion steer, 1910, International Live Stock Exposition. Photograph from *The Farmer*.

of hip to the hock should be great, with the hind flank appearing low down. From the rear, the thighs should appear thick and straight of edge on the outer part, with the space between filled in full and low. Between, where the thick lower part of the upper thigh meets the lower thigh, is located the twist. On high-class fat cattle, the twist has a very short, wide curve. The poorer the hind quarter from a beef standpoint, the less noticeable the twist. The hind legs, from behind, should appear straight, with the points of the hocks well separated and the toes directed straight

ahead. If the hocks touch at the points and the toes turn out, the animal is called "cow hocked." This bad position throws the thighs close together and prevents the desired thickness. It is also important that the shank bones, from a side view, stand nearly vertical, thereby supporting the parts above so as to provide the best conformation.

In judging breeding beef cattle, certain essentials should be kept in mind. Masculine character of head and neck are important with the males, and feminine features with the

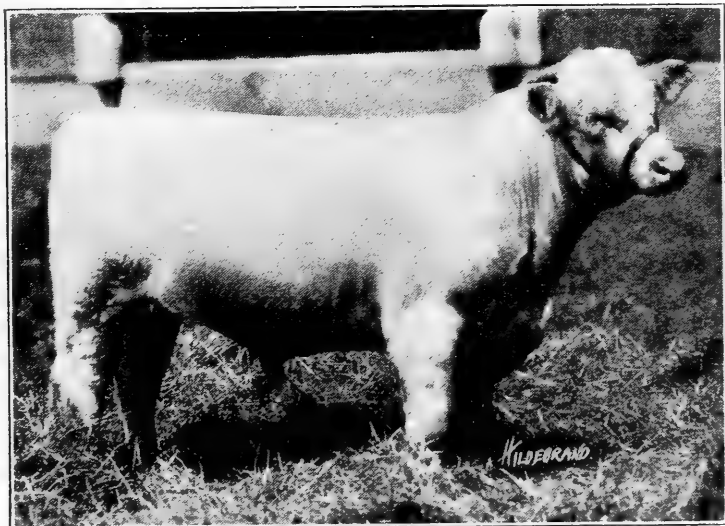

Figure 97.—Oakdale Pride 2nd, a masculine type of calf, owned by F. R. Edwards. Photograph by Hildebrand.

females. The head of the bull is usually large, is rough-haired at the forehead and poll, and carries a strong horn, if of the horned sort. The neck is also thicker and more crested than with the steer, and the shoulders usually are somewhat prominent, though not necessarily so. The cows have refined heads, with light horns, and the neck is of but medium thickness and length. The udder, also, should show plenty of capacity. In general form of body, breeding cattle should possess the important features already described, but should lack in flesh as compared with fat stock.

IN JUDGING BEEF CATTLE

1. What three features are given most credit in the scale of points?
What six the least?
2. Describe the generally approved form.
3. What is the relationship of paunch and leg to killing value?
4. What is condition, and how is it determined?
5. Why is a short neck desired?
6. How prominent is the dewlap on beef cattle?
7. What is the significance of shortness of coupling?
8. Why are "cow hocks" objectionable?
9. Wherein does the head of the bull differ from that of the cow?

INTERESTING THINGS TO DO

10. Score one beef animal or more on the home farm.
11. Make a comparative study of two or more animals without the use of the score card.
12. Organize a beef-cattle judging contest between two teams.
13. If in a beef calf club, study the conformation of the calves and note their comparative differences.

CHAPTER XXII

FEEDING BEEF CATTLE

In the feeding of beef cattle we have two distinct groups of animals, one used in the breeding herd, and the other to be fattened for the butcher. While the final end of all meat-producing animals is killing for human consumption, those used for breeding purposes should be of far greater value than for meat alone. Some breeding cattle have proven themselves of so great value, that it would be impossible to estimate their real worth to the breeds and herds they represent. One could have put a butcher's value on the great Shorthorn bull Avondale or the Hereford bull Perfection Fairfax, but their real value lies in what they have done in the improvement of Shorthorn and Hereford cattle.

The feeding standards for beef cattle will apply satisfactorily to either breeding or fattening cattle. The following table gives the essential requirements, as based on the modified Wolff-Lehmann standard.*

<i>Live weight.</i>	<i>As based on actual live weight</i>			
	<i>Dry matter</i>	<i>Digestible crude protein</i>	<i>Total digestible nutrients</i>	<i>Nutritive ratio</i>
<i>Growing, fattening steers</i>				
150 pounds	3.11 lbs.	0.49 lbs.	2.58 lbs.	1:4.2
250 "	6.40 "	0.74 "	4.42 "	1:4.9
400 "	9.72 "	0.87 "	6.32 "	1:6.2
500 "	11.95 "	1.04 "	7.88 "	1:6.5
700 "	15.83 "	1.41 "	10.35 "	1:6.4
900 "	18.17 "	1.78 "	12.22 "	1:5.8
1000 "	19.66 "	1.80 "	13.51 "	1:6.5
	<i>Per day per 1,000 lbs. live weight.</i>			
		<i>Digestible</i>	<i>Total</i>	
<i>Fattening 2-yr. old steers,</i>	<i>Dry matter</i>	<i>crude</i>	<i>digestible</i>	<i>Nutritive</i>
<i>full feed.</i>		<i>protein</i>	<i>nutrients</i>	<i>ratio</i>
First 50-60 days	22-25 lbs.	2.0-2.3 lbs.	18.0-20.0	1:7.0-7.8
Second 50-60 "	21-24 "	1.9-2.3 "	17.0-19.5	1:7.0-7.8
Third 50-60 "	18-22 "	1.8-2.1 "	16.0-18.5	1:7.0-7.8
Ox at rest in stall	13-21 "	0.6-0.8 "	8.4-10.4	1:10.0-16.0
Wintering cow in calf	14-25 "	0.7-0.9 "	9.0-12.0	1:10.0-15.0

*Quoted from Feeds and Feeding, Henry and Morrison, 1917.

This table brings out several facts of interest. As we might suppose, with increase of weight in growing fattening cattle comes an increased demand for nutrients, with the nutritive ratio very slightly widening from 400 to 1,000 pounds. On the basis of 1,000 pounds weight, however, there is a steady decrease in requirements of nutrients. In the case of the two-year-old fattening steer from the first to the third fattening periods, we note also a marked decrease in amounts of dry matter, protein, and total nutrients necessary, but with a constant nutritive ratio. The ox at rest in a stall or the breeding cow going through the winter in calf calls for a wide nutritive ratio and a comparatively small amount of protein and total nutrients.

The feeding of breeding beef cows is a comparatively simple matter. They should be kept in moderate flesh, but not allowed to become fat. Economical management requires the extensive use of roughage, pasture, forage crops and silage, with a light feed of grain except when nursing a good-sized, vigorous calf. If one has plenty of legume roughage, such as alfalfa or clover, it will be much relished, and with a very small grain portion will furnish most desirable feed. At the Illinois Experiment Station ten cows were fed 140 days during the winter on a daily ration of about 8 pounds of shock corn, (containing about 50 per cent ears), about 11 pounds of oat straw, and 3½ pounds of clover hay, and gained 106 pounds per head. At the Pennsylvania station extensive experiments on the use of corn silage for beef cattle has shown that breeding beef cows can be maintained in good condition on a ration of silage to suit the appetite, with 1 pound of cottonseed meal per day. At the Wyoming station breeding cows showed an average gain per week of 2½ pounds when fed 140 days on 10 pounds of alfalfa hay and 15 pounds of oats and pea silage, and no grain. When on good pasture grain need not be fed cows, except in hot weather. When flies are biting hard, some grain may be

profitably used to keep cows in proper condition, especially if nursing calves. During the growing season, when pasture is not abundant, it will pay to furnish the cows with green corn fodder, sorghum or any of the legumes palatable to cattle.

The beef bull, like the breeding cow, needs to be kept in good vigorous condition, but not fat. Care should be taken to see that he is not overfed; for, with some owners, lack of exercise and too much feed make the bull too fat and injures his value for breeding service. He should receive but a light amount of fattening food, relying mostly on roughages and protein concentrates. The beef bull is better off for having exercise, and should be given work, if possible, as is so commonly done in continental Europe.

The feeding of beef calves. For the first four months, and even more, the calf nurses its mother and receives such other feed as local conditions permit. On the range milk and grass make up the daily diet of the calf. Where farming is on smaller areas, the calves may or may not run with the cows. Very young calves, however, usually do, but in the hot days it is better to keep them in the darkened stable during the day, protected, if possible, from flies, allowing them to nurse the dams morning and night. In some beef herds, the calf is taken from the cow in three or four days, and given milk in a pail. Mr. J. Dean Willis, one of the most noted Shorthorn breeders in England, raises his calves on milk in the pail. The new milk may be given until the calf is about three or four weeks old, when skim milk may gradually replace the new milk substituting about a pound a day of the skim for the other, until nothing but skim milk is fed. It is important that this milk be sweet, and perfectly clean, and fed at blood temperature in absolutely clean buckets. A tablespoonful of dried blood in the bucket of milk once a day will assist in keeping the digestive tract of the calf in healthy condition, preventing scours.

One must guard against overfeeding. Ten or 12 pounds a day of milk at first, divided into three feeds for the first week or two, then gradually increasing, so that at six or eight weeks of age some 12 to 15 pounds of skim milk are fed, and this with age increased to 18 to 20 pounds a day, for vigorous, well-grown calves. Skim-milk calves, which should be weaned at four to six months old, grow strong frames, and produce growth more cheaply than with whole milk. Calves should be given bright clover or alfalfa or some other sweet hay to nibble at, and be taught to eat grain. Shelled corn is relished by the young calf, and fits well into a skim-milk diet. At first a mixture of equal parts



Figure 98.—Feeding beef calves.

corn meal, ground oats, and bran should be fed, after giving the milk. This mixture may later be changed to shelled corn and whole oats, two parts of the former to one of the latter, when the appetite for grain is well established. Thriving calves should gain from one and a half to two pounds daily.

Growing breeding cattle should be brought up to mature form with a strong and well-rounded-out frame. As a rule, calves dropped in early spring go through the following winter on a ration of some good roughage, preferably a

legume, and silage, with a comparatively small grain feed. It is important that the growth be constant during the winter, so that as a yearling the next spring it will go on grass in right condition. Over much of the country, if pastures hold out well, the yearlings get no grain, depending entirely on grass. In case of dry weather and short grass, however, it will pay to give some extra feed. Green corn or silage are invaluable at this time. In those sections where good blue-grass pastures prevail, cattle will do well, even though the grass lose much of its succulence. The second winter much the same treatment may be followed, with a larger feed of silage, but not much increase in grain. It is desirable to bring the breeding heifers up to calving as economically as is consistent with satisfactory growth. One should always keep in mind that the requirements for growth are protein foods, with suitable minerals therein, of which alfalfa, the clovers, and cowpeas are good examples.

The feeding of fattening cattle calls for other treatment than that used for the breeding herd. We have another purpose in preparing cattle for the butcher, hence a different combination of foods is needed. In the fattening of cattle we have several conditions under which feeders operate, namely, producing "baby" beef, summer feeding, fattening yearlings and two-year-olds, and preparing short-fed cattle. Each of these methods is herewith briefly considered.

"Baby" beef represents a class of cattle weighing from 800 to 1,200 pounds at 12 to 20 months of age, and are of superior beef blood, conformation, quality, and finish. To be finished as baby beef, these cattle must have been well fed from the start, and maintained their calf fat from the milk-diet period. In beef of this sort, it is necessary to feed a larger proportion of concentrates and a smaller amount of roughage than is fed to older fattening cattle. If one is to grow baby beef, it is preferable to have the calves come in the early spring. Begin grain feeding early, before weaning,

after which in fall put them on full feed, which should continue until the calves reach the desired condition and weight. Mr. E. S. Bayard recommends* 10 pounds of corn silage and 4 or 5 pounds of alfalfa or clover hay daily, along with a mixture of 6 parts shelled corn and 1 part of cottonseed meal, fed on the basis of 2 pounds for each 100 pounds of live weight. These spring calves should be ready for market by August of the next year. Fall calves should be carried through the winter in good condition, be turned on grass early in spring, and be fed during summer all the hay and grain they will eat, feeding 8 parts of corn to 1 part of cottonseed meal or linseed meal. Choice western calves, of superior beef breeding and condition, dropped in the spring,



Figure 99.—Making beef in comfortable quarters in the Corn Belt.

are often bought in the fall, at weights around 350 to 450 pounds, and are put in the feed lot, where they are fed for an early market, with silage, clover or alfalfa, and suitable grain mixture, corn and cottonseed meal being the favorite concentrates.

Summer feeding of steers relates to the practice of putting cattle on grass in the spring, and turning them off on the market in fall or early winter. These cattle may have been fed grass only or have received concentrates. Cattle

*Beef Production, Bulletin 235, Pennsylvania Dept. of Agriculture, 1913.

fed grass exclusively, as a rule, do not become fat as compared with those receiving grain. In some localities in the blue-grass sections of Virginia, West Virginia, Ohio, Pennsylvania, and Kentucky, thin cattle put on flesh rapidly and do remarkably well, but even then a ration of corn in addition produces a better class of fattening. In a study of this subject at the Missouri Experiment Station, conducted by Dr. H. J. Waters, where concentrates were fed on pasture, summer-fed cattle made an average daily gain of $2\frac{1}{3}$ pounds, covering a period of 209 days. It required about 8 pounds of grain for each pound of gain in live weight, as compared with 10 pounds with winter-fed cattle, a saving of $18\frac{1}{2}$ per cent in grain. Dr. Waters gives the following advantages of fattening on pasturage, compared with dry-lot feeding:*

1. Grass is cheaper than hay.
2. Summer gains require less grain than winter gains.
3. Steers fatten more quickly and can be made thick and prime on corn and grass with greater certainty, more uniformity, and the smaller use of expensive supplements like cottonseed meal and linseed meal.
4. Hogs following the steers make larger gains, and return more profit, with a lower death rate.
5. In summer the grain only is drawn; there is no roughage to handle.
6. The steers are usually fed but once daily.
7. The manure is scattered by the cattle themselves.

The feeding of yearlings or two-year-olds is commonly practiced where no attempt is made to produce baby beef. In this case calves usually come in the spring, and are carried on pasture the first summer, going through the first winter with dry roughage, such as corn stover, alfalfa, or clover, and perhaps silage, with a light feed of some concentrate, preferably cottonseed or linseed meal. The second summer is spent on grass without grain. The second winter the natural tendency would be to feed these cattle in the dry lot, and market them in the spring, when in fairly good condition. Some prefer to market them in the fall, following grass the third summer, while others feed corn on the grass, to get a better condition. Steers fed under these

*Circular 24, Missouri Experiment Station.

conditions should weigh 1,000 to 1,200 pounds when ready for the market, though, if finished off with grain, even more weight should be secured. Steer feeders who buy on the market select cattle thin in flesh in the fall, and feed them in the dry lot for a period of six months or more, marketing them as fat in the spring, or carrying them over through the summer, and then fattening as already explained. At the Purdue University Experiment Station during the years 1907, 1908, and 1909 a comparative study was made of groups of steers fed in the dry lot and those on pasture. The cattle in the dry lot were fed shelled corn and cottonseed meal,



Figure 100.—A herd of grade yearling steers at the Ohio Experiment Station. Photograph from Ohio Station.

and mixed clover and timothy hay. As based on this experimental feeding, Professors Skinner and Cochel state:*

“From the three years work it would be safe to conclude that high grade calves showing beef type, early maturity, quality and capacity for feed, can be profitably finished as prime yearlings if given full feed during a nine months period; that dry-lot feeding is superior to pasture feeding in finishing yearlings, is shown by the rate of gain, finish secured, profit per steer, price received per bushel for corn, and interest on the investment.”

Short-fed cattle are those that are given a heavy grain ration for a period of about three months. In such feeding, the cattle, if bought on the market, are comparatively soon, say within fifteen to twenty days, put on full feed. Short-

*Bulletin 142, Purdue University Agr. Expt. Station, 1910.

fed cattle, are usually heavier of weight at the beginning of feeding than are those fed for a longer period. In 1908 the Purdue station started a load of short-feds on feed on August 1st. At the end of the first 10 days these steers were eating 11 pounds shelled corn and 2 pounds cottonseed meal each daily. By September 1st they were eating per head $13\frac{1}{2}$ pounds of shelled corn, $31\frac{1}{2}$ pounds cottonseed meal and 25 pounds of silage. The heaviest grain feed given was on the third month, when 20 pounds of corn and 4 pounds of cottonseed meal were fed each steer, and the silage was reduced to 20 pounds. On November 27 these cattle were shipped to Chicago, where at the International Live Stock Exposition they won the short-fed carload championship.

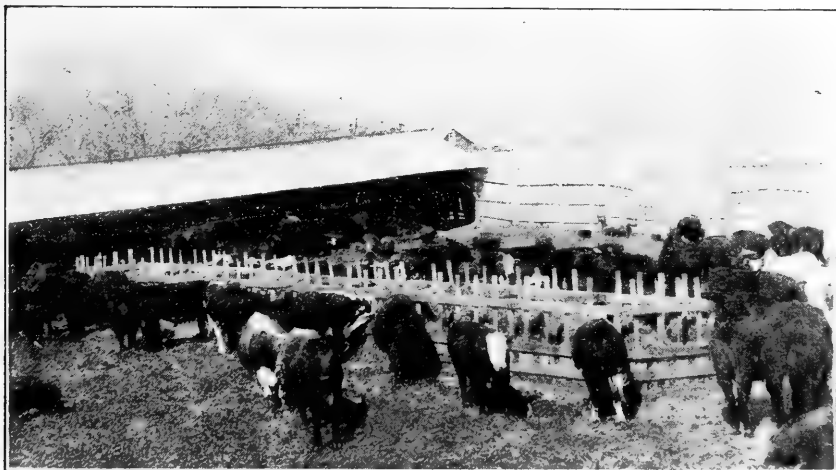

Figure 101.—Feeding roughage on the range.

The feeding of steers roughage in the early stages of fattening, may vary according to the purpose. Steers to be fed a long period may start in with roughage alone, and then gradually be brought to grain feed. At the Pennsylvania station, for example, one lot of steers was fed corn silage for roughage, and $2\frac{1}{2}$ pounds cottonseed meal each, for the first 56 days of the experiment, after which a feed of ear corn was given daily in addition to silage and cottonseed

meal. A second lot started with the complete ration of silage, cottonseed meal and ear corn, but did no better than the first lot, and in fact returned a less profit. It is desirable, however, to feed corn with the view of finish for market, and the addition of this grain to the roughage might well begin within a month after feeding begins. If one wishes to carry cattle over for a late market, a heavier feed of roughage than usual may be justified.

IN THE FEEDING OF BEEF CATTLE

1. What is the relationship of weight to nutritive ratio?
2. What ration was used for wintering cows at the Illinois station?
3. When should grain be fed on pasture?
4. How should the calves be handled with their dams?
5. Why is skim milk a valuable food for calves?
6. How should the spring-dropped calf be wintered?
7. What is meant by baby beef?
8. On what basis should grain be fed to baby beef?
9. To what extent should grain be fed to steers on pasture, if at all?
10. Give four of the advantages of pasture fattening as outlined by Dr. Waters.
11. What are short-feds?

TAKE NOTE OF THESE THINGS

12. To what extent beef production occurs in the vicinity of your home.
13. Whether or no local feeders use grain on pasture.
14. Do calves follow their dams at foot on pasture?
15. Who, if any one, in your section feeds baby beef?
16. Is beef production a profitable industry in your vicinity? If not, why not?

CHAPTER XXIII

SOME FACTORS INFLUENCING BEEF PRODUCTION

The person breeding and feeding beef cattle finds it necessary to consider a number of things which are factors in problems of management as well as feeding. Some of these are herewith considered in this chapter.

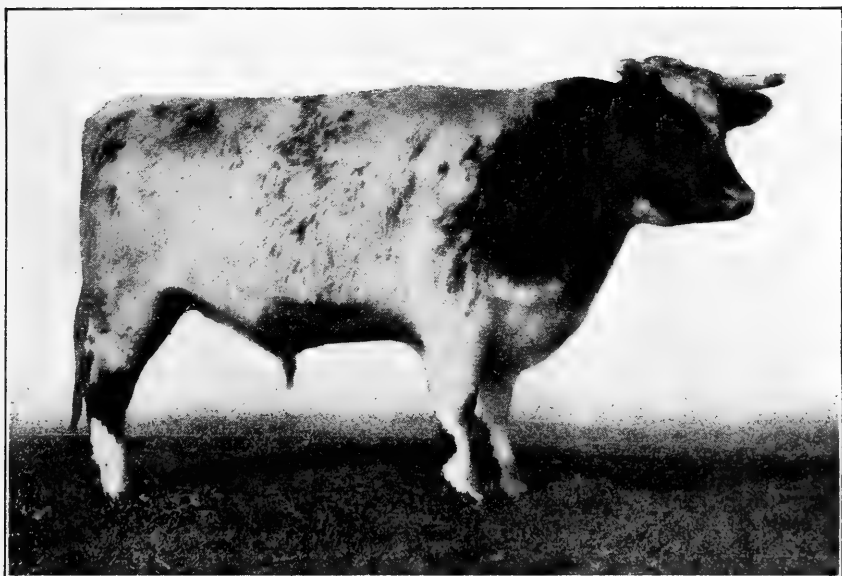

Figure 102.—An excellent type of Shorthorn steer. Photograph by the author.

The influence of type in beef production is manifest in several ways. Prime steers, representing the blockiest and best killing type of beef cattle, are especially valued for the high percentage of the more choice cuts, for the quality of the meat, and the superior dressing out of the carcass. Cattle of this type do not, however, necessarily show greater gains in weight from a given quantity of food than do inferior steers on the same ration. One may expect to sell the bet-

ter grades of cattle for the higher prices; but, if purchased as feeders, their initial cost may be so great as to result in a loss rather than profit. Several American experiment stations have proven this fact in feeding steers of different types. One of these of special interest was conducted by the Iowa station. Four steers of beef type and four of dairy type were fed during the year 1903. Two of the steers were pure-bred Aberdeen-Angus, two grade Herefords, two Jerseys, and two Holstein-Friesians. When the experiment started the average weight of the beef steers was 685 pounds, while the dairy-type steers averaged 574 pounds. It is interesting to note that the average gain of the beef steers was 606 pounds, while that of the dairy type was 598 pounds per head. The average cost of a pound of gain with the beef type was 7.81 cents, while that of the dairy type was but 7.63 cents. The average selling price per pound for the beef type, however, was 4.89 cents, while the dairy type brought but 3.75 cents per pound. In this Iowa experiment, it was demonstrated,

(1) That the gains made from food consumed, were much alike with each type.

(2) That the beef type uses his food to the best advantage in developing the more valuable cuts.

(3) That the beef type steer shows the greatest profit to the feeder.

(4) That the dairy type produces the most offal and the greatest amount of tallow.

(5) That while there is little difference in per cent of valuable cuts in the two types of steers, those of the beef type were thicker, better marbled and of superior color.

The influence of breed in beef production has been to some extent shown in the preceding section in type discussion. In this case steers of different breeds were compared; with the results noted. In various feeding experiments in beef production, in which the question of the comparative

merits of breeds was considered, no essential difference has been shown in the gains in weight and cost of production with cattle of several breeds of the beef type. The carcasses also have been shown to be quite similar in value. If, however, breeds of widely different types, such as beef and dairy, were compared, then it has invariably been shown that, while there might not be much difference in the gains in live weight and cost of the same, there was a marked difference, when it came to the slaughter test, in favor of the beef breeds in carcass value and percentage of offal.

The influence of age on beef production is quite marked. Quoting various experiments reported on by Henry and Morrison,* the older the age of the animal fed, the smaller the average daily gain and the greater the cost of production. At the Ontario Agricultural College, Prof. Zavitz fed a steer three years. It made an average daily gain of 2.2 pounds the first year, with a total gain of 785 pounds; the second year the average daily gain was 1.2 pound with a total gain of 456 pounds, while the third year the average gain per day was but 1 pound, the total gain for that year being 350 pounds. At the Ontario Experimental Farm at Ottawa, in four years of feeding, including 153 steers, the average cost for 100 pounds gain live weight was \$4.22 for the calves, \$5.31 for the yearlings, \$5.62 for the two-year-olds, and \$6.36 for the three-year-olds.

Two age factors are important in feeding operations to-day. The market demands a younger, lighter weight steer than was the case a few years ago, and heavy cattle around two years of age sell at a discount. A second factor is that of the condition of the animals when placed on feed. Cattle that are thin respond more quickly to feed than do those in good condition, so that many feeders prefer to buy thin yearlings or two-year-olds, on account of the greater gains that will be secured. If the condition of flesh were the same with cattle of different ages when put on feed, then

* Feeds and Feeding, 1917, pp. 432-434.

there would be a steady increase in the requirements of food from calthood to maturity to produce a pound of gain. Messrs. Skinner and Cochel made a survey of beef feeding in Indiana, in which they found that, of 929 feeders, 76 per cent fed two-year-olds, 16 per cent yearlings, and 7 per cent calves. The average weight desired in a two-year-old was 1,000 pounds. "Some feeders preferred steers three years old or over, the reason being that such cattle usually carry

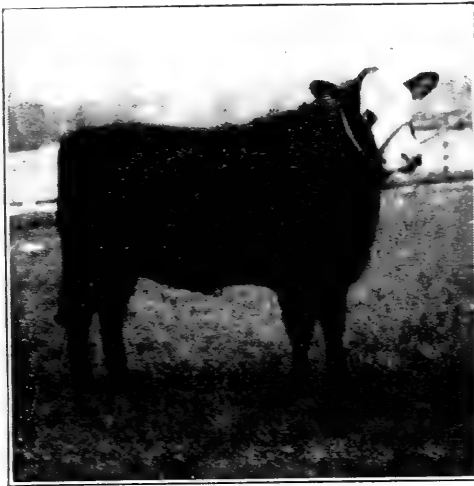

Figure 103.—A crossbred Hereford-Aberdeen-Angus steer, showing superior quality. Photograph by the author.

more flesh and make more rapid gains, thus requiring a shorter feeding period. They also need less grain to finish them, utilize coarser food, feed out more uniformly, and withstand severe weather better."

The influence of quality in beef production is of great importance. Animals that show coarse joints, heavy bone and hide, and marked paunchiness, lack in

quality and may be expected to dress out a comparatively large amount of offal, and have a carcass of inferior quality. When the more valuable cuts are thin and the fat is unevenly distributed in patchy form, then the carcass brings much less money than the one with thick and well-marbled cuts, with the external fat smoothly distributed. On all discriminating beef markets, this matter of quality plays an important part in values.

The influence of shelter in beef production has attracted attention among feeders for many years. Some breeds are better suited to exposure than others. Certainly the West

Highland cattle of Scotland, with their thick hides and heavy coats of hair, do not require the same shelter from inclemency of winter as would most other breeds. Even on our western prairies the need of shelter in winter would not be nearly so apparent for Hereford cattle as for Short-horn or Aberdeen-Angus, due to an ancestry of out-of-door living and a constitution especially suited to range conditions. Beef cattle, however, have comparatively thick, mellow hides, and heavy coats of hair in winter, and so do not need the warm stables usually provided for dairy cattle.

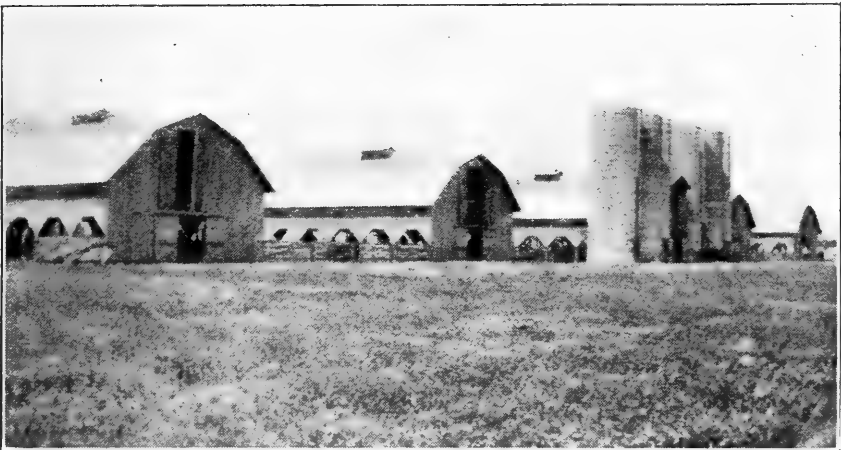

Figure 104.—Beef cattle barns and concrete silos at Curls' Neck Farm, Virginia, Photograph by the author.

Various experiments have shown that steers fed in open sheds, rather than barns, do better and gain more in weight, and at less cost than those confined in closed stables.

The self-feeder for beef cattle is a box-like affair called a hopper, with closely boarded sides, having a trough-like arrangement at the bottom on two sides. The hopper has a roof, to protect the contents, and inside the bottom inclines like an inverted V to each slot. Feed is put in through a door at the top and this by gravity settles down and works out through slots into feed troughs 24 to 30 inches

above the ground. Self-feeders of the smaller size may be portable so as to be moved from one point to another. This feature is an advantage when the ground about the feeder becomes muddy and unsuitable for cattle to stand in. Prof. Mumford gives a plan of a self-feeder* that is 12 feet 2 inches long, 5½ feet high, and 4 feet 4 inches broad, which holds about 180 bushels. Self-feeders for cattle are used to some extent, but are not in general use. Commenting on its use, Mumford says that its chief advantage is as a saving of labor, and that "where its proper use in the economy of cattle feeding is understood, it is not necessarily a wasteful or hazardous method of finishing cattle." In experiments with the self-feeder at the Illinois station, Mumford and Allison found that the self-fed steers consumed a slightly heavier concentrate allowance, and were brought to full feed in a shorter time than hand-fed ones. In the hands of a careful manager, if the cattle are brought to full feed before being turned to the self-feeder, the results will probably be satisfactory.

The paved feed lot for cattle is desirable rather than requiring them to move about in yards deep in mud and manure. It is a common thing during winter and spring to find cattle confined more or less in yards that are covered with wet manure or mud, absolutely unsanitary, a fine place for promoting disease. Lots may be paved with brick or concrete; in fact the latter material has come into considerable use for this purpose. In an experiment at the Illinois station, a carload of steers fed in a mud lot gained about the same as one fed in a paved lot, but brought ten cents less a hundred in the market, on account of their dirty appearance. Also pigs following steers in the paved lot made much better gains than those in the mud lot. In the Illinois experiment the steers in the mud lot had access to an open shed with bedding where they could lie down and be comfortable, which fact accounts for their making the good showing they

*Beef Production, 1908.

made. Prof. Mumford says, however, that "steers subjected to a mud lot with no suitable place to lie down must suffer, and when a steer is uncomfortable he is not making gain economically." He also believes that cattle will not drink as much water as they need, if obliged to wade through mud to obtain it.

The margin in beef-cattle selling is the difference between the cost per hundred of the feeder on the market and the price per hundred received for it when sold. For example,

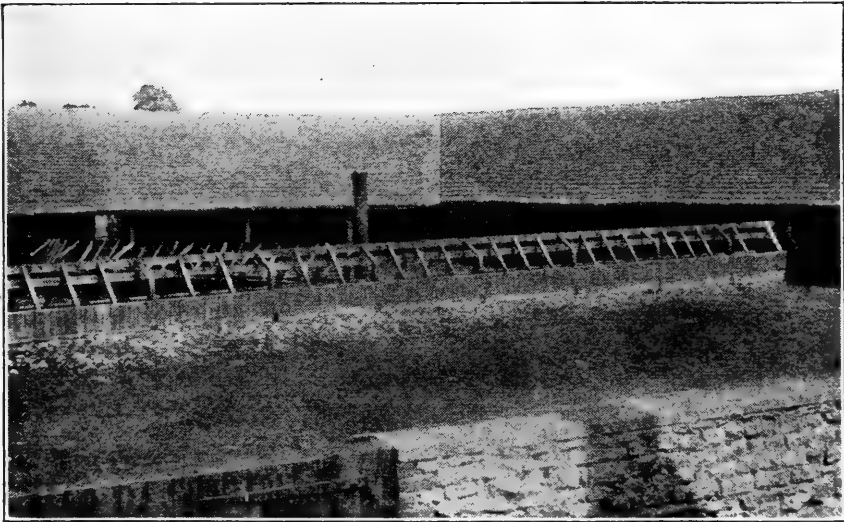

Figure 105.—An English feed lot near Faringdon, Oxfordshire, paved with macadam. Photograph by the author.

if a steer weighing 500 pounds costs \$6.00 per hundred when put on feed, its total cost would be \$30.00. Should it gain 500 pounds in live weight at a feed cost of \$35.00, then each 100 pounds of gain would cost \$7.00. Assuming the value of the manure will offset the cost of labor, the 1,000-pound steer has now cost the owner \$65.00, the equivalent of \$6.50 per hundred in the feed lot when ready to sell. In order to break even on this feeding transaction, the owner would need to obtain enough more at time of sale than the original cost of the steer, to offset its total cost per hundred, which

would be 50 cents, which is known as the “*necessary margin*” to prevent loss. If the steer is sold for \$8.00 per hundred, then we have an *actual margin* of \$1.50 per hundred, which is the difference between the actual price received at sale and the original purchase price.

There are numerous things which influence the margin, as already brought out, as first cost, first weight, cost of gain, delivery to feed lot and later marketing, and time of year and feed conditions. The heavier the cattle to be fed, and the better their condition when placed on feed, the narrower will be the necessary margin. The higher the price of feed stuffs, the wider should be the necessary margin, while cattle on pasture, making inexpensive gains, naturally require a narrower margin than winter-fed stock.

Separate care of beef cattle of different ages and sexes is given in all well-regulated herds. Young calves of both sexes may run together until three or four months old, after which time they should be fed and cared for separately. Heifers to be retained for breeding should be fed and cared for in lots by themselves. Cows with calves require very close attention in feed and care, while dry cows require less feed and supervision. Bulls should not run with the herd, but should be provided good yards, affording plenty of exercise.

Tuberculosis is one of the most common diseases affecting cattle. It is caused by a form of bacteria known as *Bacillus tuberculosis*, a very minute, slender rod-shaped organism, or what we commonly term a germ. A tubercular animal may be affected in various ways. The lungs, liver, spleen, small glands, udder and intestines in well-advanced stages develop lumps or tubers, containing cheesy-like matter. When the lungs are affected, animals cough and expectorate sputum, which contains the germs through which the disease is spread. Germs are also passed off in the excrement, and so may be found anywhere in manure that comes from tubercular cows. In advanced stages of the disease, cattle may

become very thin, the coat of hair is more or less harsh and staring, there is diarrhea, bloat and weakness, and coughing may ensue when rising after lying down.

Tuberculosis is very contagious, and one affected cow will spread the disease amongst a herd and ruin it. The germs live for a long time in dark stables, in mangers and manure trenches, etc. When the udder is affected, they also pass off in the milk, and, if this is fed to healthy calves or pigs, they usually contract the disease. The tubercular germ is killed by a few hours exposure to sunlight, and is destroyed in milk that is heated up to 145 degrees for 25 minutes, and then suddenly cooled to 40 degrees. For family use, milk heated to 165 degrees for 5 minutes and then cooled to about 40 degrees, will be safe to use.

The universal method of determining whether a cow has tuberculosis to-day is by the tuberculin test. A serum is produced in the laboratory by growing the germs of the disease, in a solution, which at a certain stage of development is boiled to destroy all germ life. If some of this solution is then injected beneath the skin of a tubercular cow, her temperature during a few succeeding hours will go through a rather steady rise of two degrees, and then fall. If she has no tuberculosis, her temperature will not change. There is also another test, the intradermal, in which the serum is injected between the outer and inner layers of skin, and still another test, the ophthalmic, in which tuberculin is applied in the eye.

Every herd should be tuberculin tested, and each reactor should be killed, subject to inspection. If the carcass itself is not affected, and the disease is confined to the organs that are removed, the meat is suitable for food. In 1921 at 10 Armour Packing Houses, 4,728 cattle were held by the Government inspectors for further examination, because of suspected tuberculosis. Of these 76.48 per cent were condemned as unfit for food.*

*Progressive Beef Cattle Raising. Published by Armour & Co. 1922.

Accredited herds are now being established all over the United States by the U. S. Bureau of Animal Industry, in co-operation with state veterinarians or cattle commissioners. An accredited herd must pass a 100 per cent tuberculin test for three successive years, showing it to be free from tuberculosis. There are now thousands of accredited herds in this country with interest in this subject steadily increasing.

As there is no known cure for tuberculosis, the thing for the stockman to do is to use preventive methods. The stable should be well lighted and ventilated. In making the highest grade of milk—that is, certified—it is recommended by the U. S. Bureau of Animal Industry that each cow be allowed at least 4 square feet of window light and 500 cubic feet of air space. Sunlight is a stable disinfectant. Water troughs and mangers should be kept clean, as the disease is distributed through these mediums. The stables should be kept whitewashed, or sprayed at frequent intervals with disinfectants, as, for example, a 5 per cent solution of creolin, which may be purchased at most drug stores.

Lump jaw is a disease that appears as a hard swelling or tumor on the jaws of cattle. It is caused by a fungous disease that grows on some forms of grasses and stubble. If the jaw is badly diseased, it becomes ulcerated, the cattle find it difficult to chew their food, and sometimes die. This disease is not communicated to other animals by one that is affected. What is known as iodine treatment may cure the disease in its early stages, but as a rule, it is recommended to fatten and slaughter cattle having this disease, as the carcass is suitable for food when only the head is affected. The udder of the hog is sometimes affected by this disease.

Blackleg is a very contagious disease caused by a germ known as the blackleg bacillus. The animal becomes infected through an abrasion on the skin, and the disease is transmitted by contaminated animals by discharges from the skin wounds. The symptoms are first a high fever and loss

of appetite, difficulty in breathing and in locomotion. The membranes of the mouth later become dark red or purple, and swellings appear on the more muscular parts, as thighs and shoulders, which may spread to other parts of the body. Under these swellings a bloody fluid develops, and the flesh of the legs takes on a dark color, hence the name blackleg. As the disease is not curable, preventive measures are adopted. Healthy cattle are vaccinated with a vaccine produced in the laboratory from the disease germs. This treatment is very effective in preventing the malady.

Foot and mouth disease especially affects cattle, although it may occur with swine and sheep. The disease is indicated by a fever, and by the appearance of water blisters on the mouth, a great flow of saliva, and sore feet. This is a very contagious disease, but is not usually fatal, although it does great damage to herds. While very prevalent on the continent of Europe, it has never had a permanent foothold in the United States, because of the fact that it has been stamped out by our government through a strict policy of quarantine and slaughter.

Foot rot of a contagious nature, which occurs with cattle and sheep, though more commonly with the latter, is due to germs which develop between the toes and under the hoofs. The foot becomes hot and swelled, and finally pus is formed and discharged when the swellings break. The sores develop under the shell-like part of the hoof, and in bad cases the outer horny layer may drop off. Naturally the animal becomes very lame, and may hardly be able to walk. The pus which comes from the sore scatters the disease among the healthy animals of the herd. For treatment the diseased tissue should be trimmed away, the foot thoroughly washed with strong disinfectants, and if need be bandaged. An excellent disinfectant is a strong solution of copper sulfate. Sometimes in extreme cases of diseased hoofs, pure copper sulfate crystals are packed about the hoof. Foot rot is very

hard to cure, and, when discovered in a herd, should be treated vigorously and the treatment repeated frequently enough to cure the trouble. For preventive measure cattle and sheep may be walked through shallow troughs containing a 5 per cent solution of copper sulfate, repeating the treatment every two or three weeks. Yards and stables heavy in manure and mud are great breeding grounds for foot rot.

Hemorrhagic septicemia occurs with cattle, sheep and swine. In swine it is a form of cholera. Little is known of the origin of the disease. Animals that are sick show a strong fever, swell about throat and brisket, and have difficulty in breathing. If the intestines are affected, the animal may act colicky, and the solid excrement may be bloody. After death hemorrhage is found under the skin and in the intestine walls, with bloody spots about the membranes of the heart and diaphragm in particular. The disease may be acute, which is very fatal, or sub-acute, when from five to fifteen per cent of the herd may die. This disease is most common with cattle on swampy pastures or where the drinking water is stagnant and unsanitary. Prevention is more satisfactory than treatment, and so stock should be kept on well-drained land and given good drinking water. Water troughs and mangers should be frequently cleaned, and disinfectants used liberally in the stable.

Anthrax, or charbon, is a germ disease that affects many kinds of animals, especially cattle, horses and sheep. It is most abundant in warm, moist climates. Low-lying, moist pastures may be infected with the disease for many years. There are several forms of the disease. One acts like apoplexy, in which the animal becomes suddenly sick, staggers, falls, and dies in convulsions. The abdominal form is associated with swelling and pain in the abdomen, diarrhea, etc. The thoracic form exhibits bloody discharge from the nostrils, salivation, swelling of the throat and rapid breathing. Swellings or carbuncles occur with each of these forms.

There is no known cure, but by vaccination animals may be made immune from the disease. All anthrax carcasses should be burned. Great care should be exercised by men in working among animals having anthrax, for the disease is readily communicated to humans through abrasions on the skin. Occasionally persons handling hides from foreign countries have contracted anthrax.

Warbles are caused by a large fly, which lays its eggs on the hair of cattle. The animal licks its hair and swallows the eggs, which hatch in the gullet, where the young grubs work their way through, finally to locate in the tissue just beneath the skin of the back. Here they develop, so that by spring one notices little tumors in the skin, in the center of which is a small hole. Through these holes the grub works its way and drops to the ground where it develops into a fly. The holes made by the grub greatly injure the hides for commercial use, if there at time of slaughter.

Milk-fever is a disease especially noticeable among cows that are heavy milkers and occurs most commonly after the third, fourth, and fifth calving. It usually occurs two or three days after the calf is born. There is no absolute knowledge as to the cause, although some think blood congests in the udder, while others believe it due to poisons developed in the milk. Cows sick with milk fever show the following symptoms, as described by Dr. F. B. Hadley.*

"The symptoms of milk fever start with excitement and end in complete loss of consciousness, the animal going through much the same stages as when given a general anesthetic, such as ether or chloroform. The patient has a wild look in the eye, switches her tail, trembles, weakens, staggers, lies or falls down, tries to rise but is unable to do so on account of paralysis of the muscles. She then loses all sensation and passes into a state of unconsciousness or coma, with her head tucked into the right flank. The breathing is deep and slow. Later the cow stretches out flat on her side."

Treatment for milk-fever is simple and effective, consisting in pumping air into the udder. It may be best applied by means of a milking tube on the end of rubber tubing, using a bicycle pump for inflation. The milking tube before

*Principles of Veterinary Science 1920 p. 346.

using should be thoroughly sterilized, and the ends of the teats cleaned and disinfected. Care should be taken not to pump too great a pressure of air in the udder. "To prevent escape of the air," writes Dr. Hadley, "the end of the teat is repeatedly pushed into itself until it stays of its own accord." Other veterinarians recommend tying strips of muslin or tape around the ends of the teats to prevent escape of the air. If recovery does not become apparent within four or five hours, the treatment should be repeated.

WHAT EFFECT HAVE THE FOLLOWING INFLUENCES ON BEEF PRODUCTION?

1. Type. (a) In making gains.
(b) In production of high priced cuts.
(c) In selling values.
2. Breed. What have feeding experiments shown?
3. Age. (a) Gains in weight.
(b) Cost of production.
4. Quality, and its relationship to values.
5. Shelter. (a) Comparing breeds.
(b) Types of shelter.
6. The self-feeder.
7. The paved feed lots compared with the dirt lot.
8. The margin; what is it, how affected.
9. Tuberculosis and lump jaw.

SUGGESTED OBSERVATIONS ON BEEF MAKING

10. The type of cattle fed in your neighborhood.
11. The popular ages in feed lots.
12. The kind of shelters provided.
13. The use of the self-feeder.

CHAPTER XXIV

BREEDS OF DAIRY CATTLE

The Jersey breed of cattle originated on an island of that name located off the coast of France in the English channel. There is a small group of what are known as the Channel Islands not far from the coast of Normandy. In fact, from Jersey on a clear day one may see the French

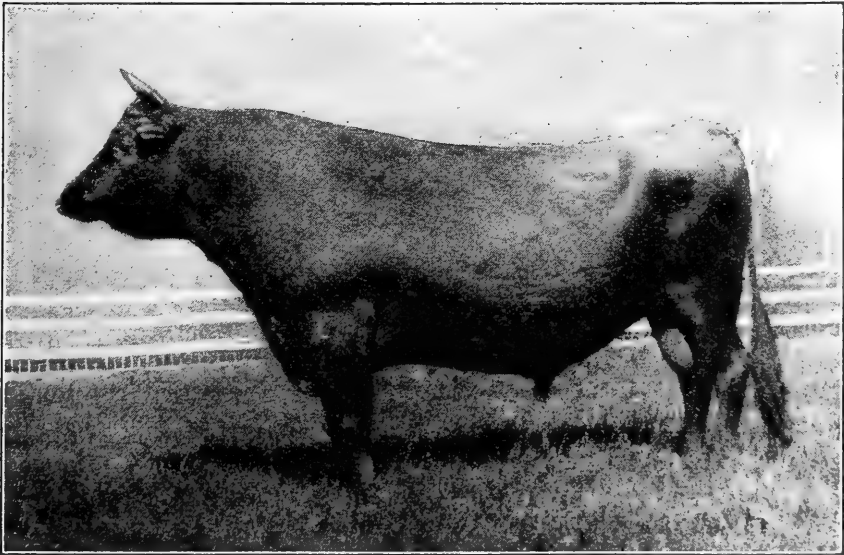

Figure 106.—Raleigh's Fairy Boy 83767, a famous Jersey buli, both as an individual and sire. Owned by C. I. Hudson of New York. Photograph by the author.

coast. There are four principal islands, of which Jersey, the largest, contains about 40,000 acres. The climate here is quite mild and balmy much of the year. The cattle, of which there are about 12,000, live out of doors during a very long season, each one grazing tethered by a chain and rope fastened to an iron pin in the ground. The herds are small, and these and potatoes are the chief sources of income on

Jersey. There are perhaps 60,000 people on the island.

Jersey cattle are supposed to have originated from stock in the neighboring districts of Normandy and Brittany in France. They have been kept pure of blood for much over a century. As early as 1763 the people on the island adopted laws to regulate the importation of cattle from France. For a very long time no foreign cattle have been allowed to enter Jersey, except such as were butchered within 24 hours after landing. In 1833 the people organized a society to improve the agriculture of the island, and the next year they drew up a scale of points for the bulls and cows. Since then it has been changed and improved a number of times. The people made notable progress in improving their cattle, and no doubt the competition of the show ring and the butter and milk tests which were established inspired them to study to secure this improvement.

The Jersey was first brought to America about 1850, Connecticut and Massachusetts men being the importers. Since then large numbers have been brought to this country, and have been widely distributed over the United States and Canada, so that now this is the most common dairy breed of cattle known in North America.

The characteristics of the Jersey are as follows: The size is medium, though many seem small. Mature bulls should weigh from 1,300 to 1,400 pounds, and cows 850 to 900 pounds, though many animals exceed these weights. The color is fawn, but of various shades, some being the color of the deer or lighter, others very dark, approaching black. White occurs, though it is not popular in America, and but comparatively few animals show distinct white markings. The form is distinctly of the dairy or triple wedge type. The head is very attractive, having a somewhat large and prominent eye, a dished face and small refined horn; the neck is thin and of medium length; the withers thin; shoulders somewhat prominent; body of moderate depth and feeding

capacity; rump of fair width and length, and thighs thin and incurving. There is a tendency for the hocks to stand somewhat close together, and the rump is often narrow and steep. The approved type of udder comes up high behind, is carried level and well forward along the belly, with the front quarters especially well developed. The teats should be of convenient size and squarely placed, to permit comfortable manipulation in milking. In recent years we have heard more or less about American-type and Island-type



Figure 107.—Jersey cow, Simple Interest 4th. Photograph taken in the field by the author on the Island of Jersey.

Jerseys. The former is somewhat larger, coarser, plainer-headed, and less symmetrical in udder than the latter. Many American-type Jerseys have udders that are poorly developed in front, showing the whole much out of balance.

The most striking features in the appearance of the Jersey are the color; the wedge form; the short, dished face; the prominent, beautiful eye; the fine bone, and the deer-like character of the calves. The disposition of the cows is very

good, but the bulls at maturity are liable to be nervous and are often cross. Jerseys mature very young, compared with other breeds.

The milk of the Jersey is usually yellow in color and rich in butter-fat. The skin of these cattle show something of this rich yellow color, especially in the small, wax-colored horns, in the ears, and about the udder. The Jersey of good breeding produces a fair amount of milk, and 5,000 pounds a year may be regarded as common, while many cows have produced over 10,000 pounds a year each. Up to May, 1921, over 1,500 two-year-old heifer records of Jerseys average 7,691 pounds of milk, while 1,459 cows five years old or over show an average of 9,701 pounds of milk.

The cow of this breed showing the most remarkable production is Sophie 19th, of Hood Farm, that during nine consecutive years produced 110,938 pounds of milk. The heaviest milk record of a Jersey cow in a year was 19,694 pounds by the cow Passport. Jersey milk usually contains $4\frac{1}{2}$ to 5 per cent of fat, and makes a high grade of butter. Many cows have produced enough milk in a week to yield 14 or more pounds of butter. Some few have records of over 20 pounds in a week. Many Jerseys have produced enough milk within a year to yield 500 pounds of butter, and some have even exceeded this. Up to May 1, 1921, the 1,543 two-year-olds noted above gave an average annual fat yield in the milk of 356 pounds, while the 1,459 aged cows averaged 510 pounds of fat. Up to 1921 three Jersey cows have produced 1,000 pounds or more of milk fat in a year, Plain Mary having 1,040 pounds and Vive La France 1,039 pounds, and Sophie's Agnes 1,000 pounds. In nine consecutive yearly records, Sophie 19th, of Hood Farm, produced a total of 6,354.6 pounds of milk fat.

There is a number of noted Jersey families, of which the Golden Lad, Oxford, Financial Interest, Signal, St. Lambert, Coomassie, Eurotas, Tormentor, and Owl-Interest are espe-

cially well-known; but many Jerseys in little known families have made remarkable milk and butter-fat records.

Prices for Jersey cattle under average conditions are very reasonable. In the past, however, many animals have brought what may be regarded as very high prices. In 1919 Edmond Butler broke Jersey price records, selling 47 head for \$158,250, an average of \$3,367.02. At this sale the bull Sybil's Gamboge was sold for \$65,000 to Mr. L. V. Walkley, the record for a male, while in 1921, at Mr. Walkley's sale,

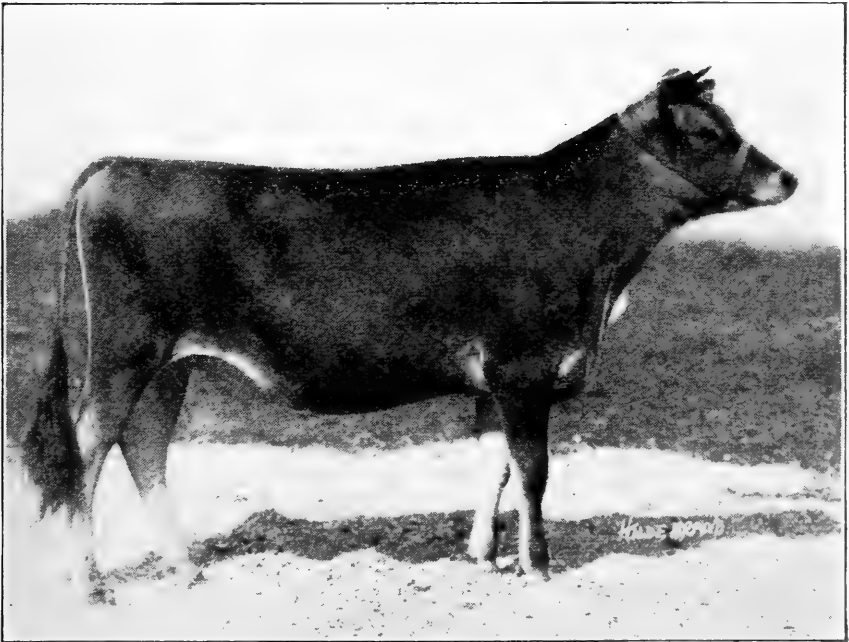

Figure 108.—Jersey heifer calf, Buttercup's Jasmine. Owned by C. I. Hudson of New York. Photograph from Mr. Hudson.

the cow Gamboge Oxford Gem sold for \$18,000, the high price for a cow of the breed.

The distribution of Jerseys is world-wide, but they are generally common in the United States and Canada. They have an especially strong foothold in the states of Ohio, Texas, Tennessee, Missouri, New York, Pennsylvania, and Oregon. The American Jersey Cattle Club, with head-

quarters in New York City, is the official national promoter of the breed. Activity in promoting Jerseys is shown in that up to May, 1921, there were organized 167 state and local Jersey clubs, 70 bull clubs, and 61 calf clubs.

The Holstein-Friesian breed of cattle came originally from Holland. Here the people have kept dairy cows for centuries. The country is very low, much of it lying below sea level, the water being held back by dykes. There are many meadows that are separated by canals. On long, narrow strips of pasture, with water on each side, one sees beautiful herds of black and white cattle, a most common

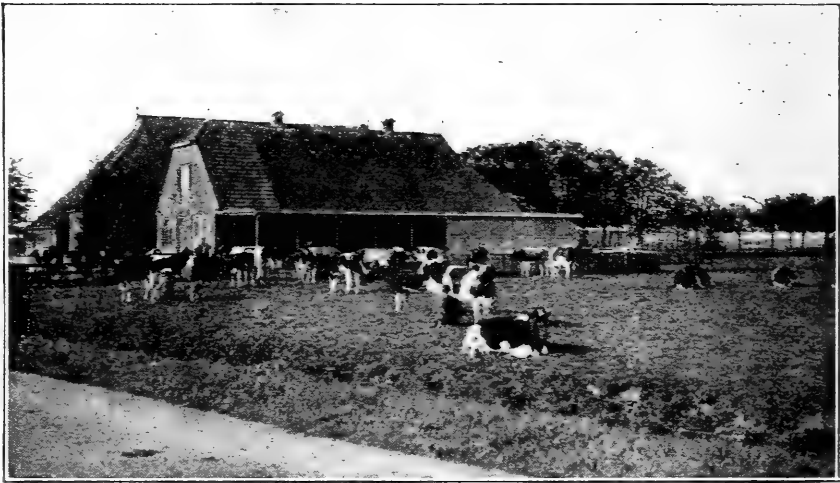

Figure 109.—The Kuperus herd and barn near Leuwarden, Holland. Photograph by the author.

summer sight in Holland. We do not know the origin of these cattle. They are perhaps descended from the Giant Ox. The present cattle are usually black and white, though red and white rarely occur. Cattle were brought to America from Holland by the early Dutch settlers of New York and vicinity. In 1795 the Holland Land Company sent some cattle to central New York. Later on, Dutch cattle were taken to Vermont and other eastern states. Along in the middle and later part of the last century many were imported

into America, but in recent years importation has been prohibited, owing to foot-and-mouth disease which is more or less prevalent at all times on the continent of Europe.

The characteristics of Holstein-Friesian cattle are as follows: in size they are the largest of the common dairy breeds, mature bulls often weighing from 2,000 to 2,500 pounds and cows from 1,200 to 1,500 pounds or more. The color, which is a striking feature of the breed, is black-and-white spotted, the amount of one color or the other varying greatly in dif-



Figure 110.—Holstein-Friesian bull calf, Carnation King Sylvia, bought in 1918 for the record price of \$106,000 by Carnation Stock Farms. Photograph from the owners.

ferent animals. In recent years, however, cattle that showed much more white than black have been in most favor. The heads incline to be a trifle long and narrow; the horns seeming small for such a large breed; the body is capacious; the rump is long and often steep; and the thighs are large and in many instances tend to be somewhat thick and beefy. The udder is a notable feature of the breed, tending to be pendant, and with age hanging low rather than being held

fairly close to the belly. In some cases the udder attains immense size and capacity.

There are three recognized types of this breed:

- (a) The thin-fleshed, wedge-shaped type;
- (b) Those that carry somewhat more flesh; and
- (c) Those that are rather broad over the withers and thick in the quarters, and show more beefiness than dairy cattle men usually admire.

Many persons approve the medium between the two extremes, if the cow is a satisfactory producer of milk. An animal of beefy form, with a thick pair of thighs, is not to be commended. Among the noted Holstein-Friesian sires one finds extremes in type, some animals possessing conformation that is far from what might be regarded as ideal.

The milk of the Holstein-Friesian is about average, or below, in quality, not being noted for butter-fat content. But in production of quantity of milk, this breed leads all others in a marked degree. A large number of cows have produced yields of over 100 pounds of milk in a day, Cascade Johanna Illustrites having the remarkable record of 161.4 pounds in 1 day and 3,546 pounds in 30 days. There are many records of over 25,000 pounds of milk in a year. Most remarkable among these is that of Tilly Alcartra, a California cow that has produced in eight consecutive yearly records a total of 201,138 pounds of milk, a yearly average of 25,142 pounds. The greatest yearly production of milk by a cow of the breed was by Segis Pietertje Prospect, of 37,381 pounds, completed in 1921.

Holstein-Friesian milk usually contains a small per cent of fat, 3 per cent being common, and 4 per cent unusual for cows not being in official test. Breeders, however, are steadily improving the breed in this respect, so that no doubt there will be an improvement in the average amount of fat. On account of the large milk yield, however, the butter-fat in one day may amount to a very important total.

In 1919 the cow Rolo Mercena De Kol produced 51.93 pounds of estimated 80% butter in her milk in a 7-day test, while during 30 days she produced 201.17 pounds. From 1915 to 1921 Duchess Skylark Ormsby held the world's record for a year's production of butter-fat, 1,205 pounds, or 1,506.36 pounds of estimated butter. In 1921 Bella Pontiac, however, completed a record for a year of 1,258.8 fat, equal to 1,587.5 pounds of butter. Up to 1922 there have been official advanced registry (A.R.O.) records made by 50 cows of 1,000 pounds or more of butter-fat in 365 days or

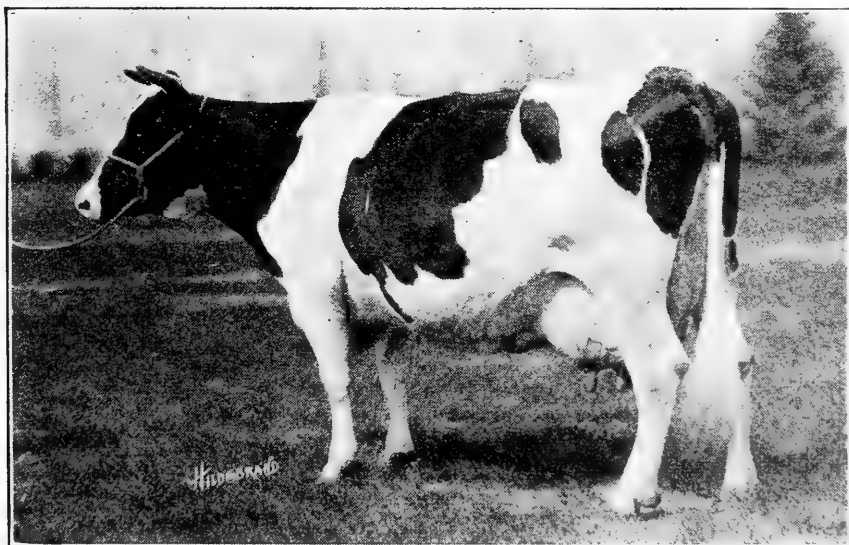

Figure 111.—Holstein-Friesian cow, Springbrook Bess Burke 2d, one of the most noted dams and producers of the breed. Photograph from the owners, E. C. Shroeder Farms, Minnesota.

less. In May 1921, the President of the Holstein-Friesian Association of America stated* that “the Advanced Registry contains milk and butter records to the number of 125,000, and last year there were added thereto about 17,000 records,” which showing is remarkable.

Among the noted Holstein-Friesian families are the Bess Burke, Clothilde, De Kol, Johanna, Korndyke, May Echo, Netherland, Ona, Pauline Paul, Pietertje, and Segis.

*Hoard's Dairyman, June 3. 1921.

Prices for Holstein-Friesian cattle range from ordinary to the highest that have been paid for cattle of any breed. A considerable number of animals sold during the period following the World War for from \$10,000 each or more. The bull Carnation King Sylvania, a son of the famous cow May Echo Sylvania, sold in 1918 for \$106,000.

The distribution of Holstein-Friesian cattle is very widespread. In the United States, New York holds first place as a center for the breed, with Wisconsin, Ohio, Pennsylvania, and Michigan ranking in numbers of animals in the order given. A large percentage of the cattle of this breed are located in the Middle Atlantic and Central States. The breed is promoted by the Holstein-Friesian Association of America, with about 20,000 members, and by many state and local breed associations. The breed has had a wonderful development in the United States, and is constantly growing in favor. The great feeding and producing capacity of the cows, and their quiet disposition, have added much to their popularity, especially among men supplying milk to creameries or the city trade. In recent years, especially during and since the World War, Holstein-Friesians or Friesians as they are termed there, have grown in great favor in Great Britain.

Guernsey cattle originated on the island of Guernsey, another of the Channel Islands, and come from much the same ancestry as the Jersey. The people of Guernsey adopted plans for keeping out foreign cattle, similar to those of Jersey. The earlier Guernsey cattle show less careful breeding, however, and, as a whole, have not been selected and improved as much as those on Jersey. Guernsey is a triangular, hilly island, of about 15,500 acres in area, and supports a population of perhaps 45,000 people. The climate is balmy and healthful. The people make a specialty of flowers, vegetables, and cattle. The island of Alderney is officially a part of Guernsey, and the cattle on this island

are the same as the Guernseys, being so regarded by Guernsey and American breeders. In early days, though not at present, all the cattle from the Channel Islands in England and America were called Alderneys. These cattle were first introduced to America, it is thought, in 1830.

The characteristics of Guernsey cattle are very comparable with the Jersey. The two breeds are certainly closely related in their origin. The Guernseys are somewhat larger, than the Jerseys, standard weights being 1,600 pounds for the mature bulls and 1,100 pounds for the cows. The color

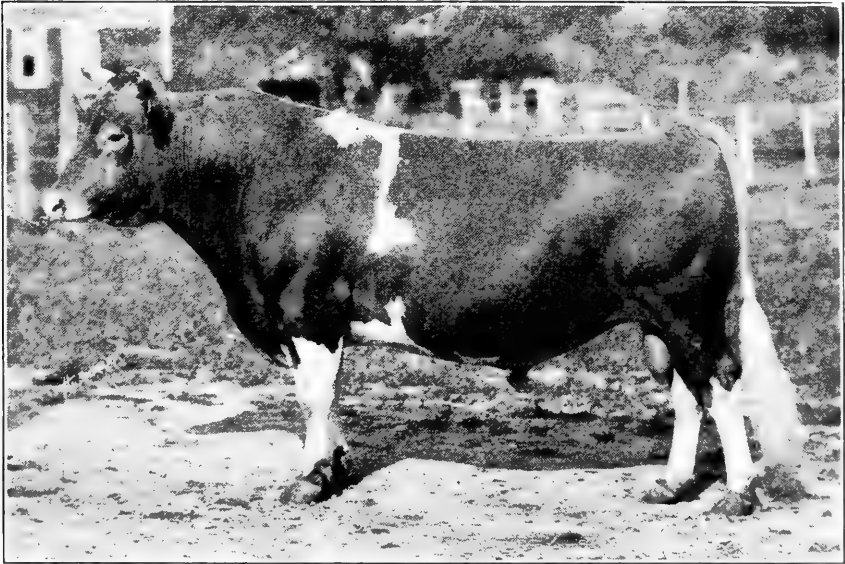

Figure 112.—Guernsey bull Langwater Advocate. Photograph from Langwater Farm, North Easton, Mass.

is usually yellow or red fawn, although white spots are very common, some of the most noted animals of the breed showing considerable white. The face is somewhat straighter than with the Jersey, and a very light creamy or “mealy” ring of hair extends around the muzzle and about the eyes. A flesh-colored muzzle is preferred by breeders, a dark slate color being decidedly unpopular. Guernseys are often plain of head and rough of shoulder, and lack the beautiful front

udder development so often found on the Island Jerseys. These cattle are noted for the yellow skin and secretions, the milk being especially high in color. Guernseys are usually of a quiet disposition, and the bulls are perhaps rather less nervous than are Jersey males.

The milk of the Guernsey from the standpoint of quality and butter-fat production is unsurpassed. The milk has a natural rich yellow color, and tests 5 per cent or better in butter-fat. The cows make surprisingly high yields of milk,

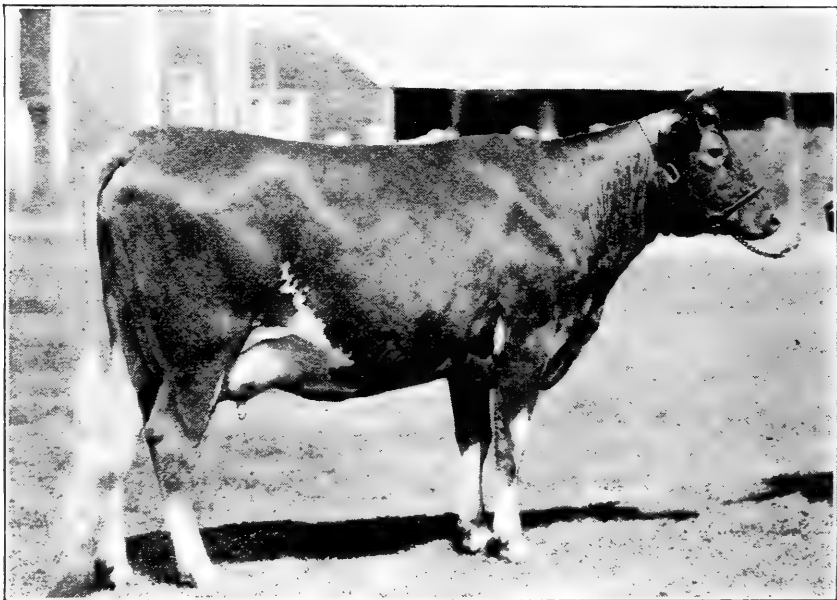

Figure 113.—Guernsey cow, Langwater Phyllis. Owned by F. L. Ames, Langwater Farms, Massachusetts. Photograph from Mr. Ames.

and some 10,000 cows officially tested, up to December, 1920, showed an average production of 9,068 pounds, containing 454 pounds of fat. Great individual records have been made, the leading one in milk production being that of Murne Cowan of 24,008 pounds for a year, ending in 1915, while Countess Prue secured the lead in butter-fat production, by producing 1,103.28 pounds during a year ending in 1921. A wonderful two-year record was made by Kath-

erine's Trixie, in a yield of 18,945.7 pounds of milk, containing 791.48 pounds of fat. Among the great butter-fat producing Guernseys are Murne Cowan with a yearly record of 1,098 pounds, May Rilma, 1,073 pounds, Nella Jay 4th, 1,019 pounds and Langwater Nancy, 1,012 pounds.

The American Guernsey Cattle Club was the first breed association to establish what are known as official tests for milk and butter production, conducted by disinterested experiment station or agricultural college employees. Since the Club began this work, the Guernsey has made a remarkable showing. Some of the largest butter-fat records made by cows of any breed have come from the Guernsey.

The prices paid for Guernsey cattle average fairly high, compared with those of other breeds. In 1918 the average price of 1,318 head sold at public auction was \$330, while the average of 2,464 head sold in 1920 was \$508. On May 13, 1921, at the Eastern Guernsey Breeders' Association sale 56 head brought an average of \$1,087. Some very high prices have been paid for individuals, one two-months-old bull calf, Florham Leader, selling for \$25,000.

The distribution of the Guernsey is not so extensive as either Jersey or Holstein-Friesian. Wisconsin is the leading state in promoting Guernseys, while the Middle Atlantic states, New England, and the North Central states largely furnish the American support of the breed. The American Guernsey Cattle Club, with headquarters in New Hampshire, is the official promoter of the breed, and there are also state and local Guernsey clubs.

The Ayrshire is a Scotch breed that originated in the region Robert Burns has made famous, the county of Ayr in southwest Scotland. It has rather a cold, damp climate in winter, but there is good grazing in summer. Except near the sea, the country is more or less hilly. The Ayrshire is a dairy breed, and one of the youngest of the prominent breeds. Cattle were taken to the Ayrshire country from

various places, for Shorthorn, Highland, Dutch, Guernsey, Devon, and Hereford cattle are said to have been owned by the farmers of that region. From the mingling of color of these breeds we get the red, brown, and white markings that are features of the Ayrshire. At the beginning of the nineteenth century there were cows in southwest Scotland that were famous milkers, and by offering prizes for competition, the Scotch people have still more encouraged large milk production. Ayrshires were first imported to America early in the nineteenth century.

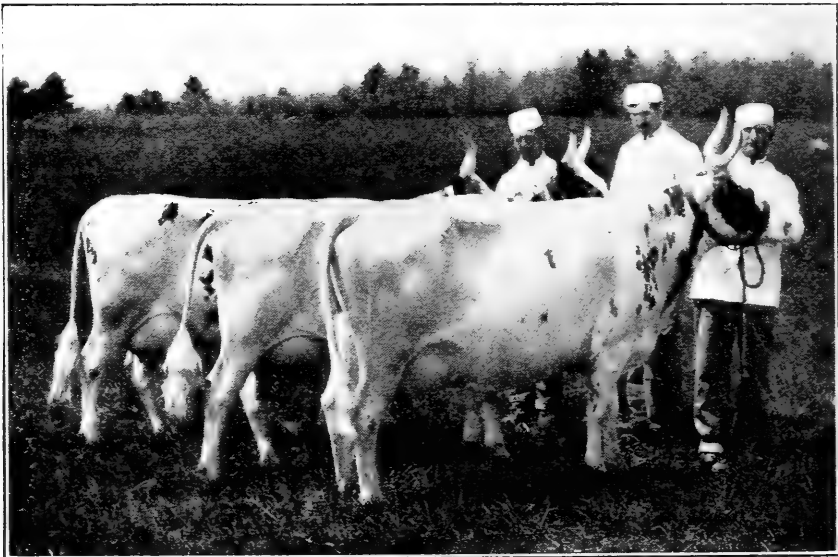

Figure 114.—Three beautiful Ayrshire cows owned by Arthur H. Sagendorph of Massachusetts. Photograph from *American Agriculturist*.

Characteristics of the Ayrshire. The mature bull should weigh about 1,500 pounds, and the cow about 1,100. The color is red and white or brown and white, with white most abundant in recent years. The head is one of the striking features of the breed, with its rather long, large and erect horns. While a true dairy breed, the Ayrshire inclines to be a trifle fleshy, with more thickness over the withers, along the back, and about the thighs than in case of the Jersey or

Guernsey. Some of the bulls are too beefy for the best dairy form, but there are many cows that show beautiful dairy type. No other breed has such a uniformly well-developed udder as the Ayrshire, the fore part being much extended, and the rear udder carried well up behind. A big show of Ayrshire cows, without exception, makes a most uniform and attractive exhibit.

The milk of the Ayrshire is of standard quality, testing from $3\frac{1}{2}$ to 4 per cent fat. It makes excellent cheese, and

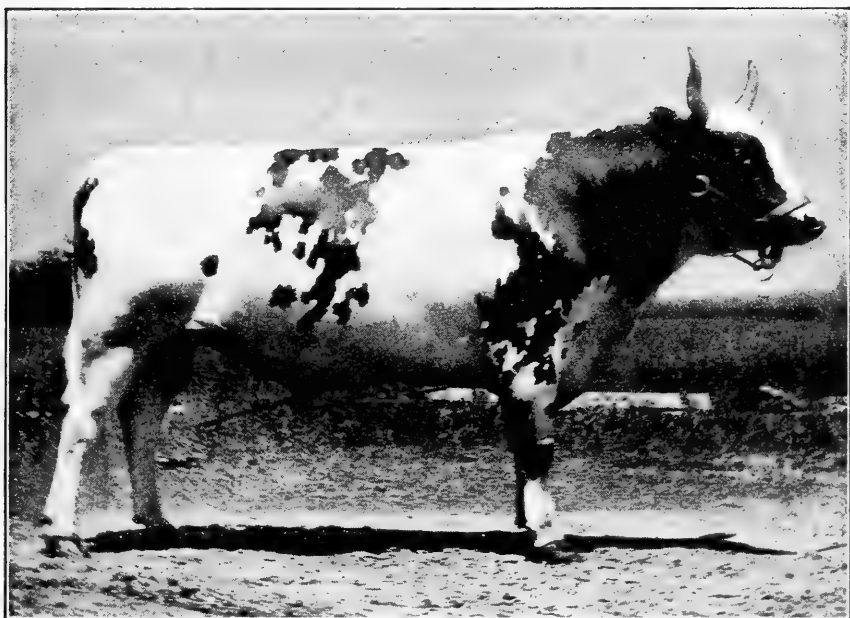

Figure 115.—Ayrshire bull Bargenoch Bonnie Scotland owned by John Sherwin of Ohio. Photograph by the author.

most of the famous cheddar cheese of Scotland is made from Ayrshire milk. Very fine records in milk production have been made, a number of cows producing over 25,000 pounds of milk in a year. The great record of 25,329 pounds of milk in a year was made by Garclaugh May Mischief, while Lily of Willowmoor, one of the great cows of the breed, in five years produced a total of 84,991 pounds of milk, an average of nearly 17,000 pounds a year. A considerable

number of excellent records in milk fat production have been made, with Lily of Willowmoor holding high rank with 955½ pounds to her credit in a year.

The distribution of Ayrshire cattle in America is largely in the northeastern states and in Canada, where many excellent herds are found. A few herds are found here and there in the western states, as far as the Pacific slope, but the Ayrshire is not popular in the West. These cattle are hardy and do well in the more northern climates.

Brown Swiss cattle originated in Switzerland. In color they are usually a dark brown, with lighter or cream-colored



Figure 116.—Brown Swiss cow McAlpine, a noted prize winner owned by E. M. Barton of Illinois. Photograph by the author.

hair about the muzzle and along the top of the back. They incline to be heavy of head and neck, and coarse-boned; are likely to be somewhat fleshy, and often have rather meaty thighs. The cows produce a very good grade of milk, and some very excellent records have been made by Brown Swiss cows, College Bravura 2nd having produced 19,460 pounds in a year, containing 798 pounds of fat. While they often impress one as dual-purpose cattle, the association promot-

ing them has officially declared the Brown Swiss to be a dairy breed. These cattle are not popular in America, and but few herds are found in any part of the country, these being mostly confined to New York and the Middle West.

The Dutch Belted breed of cattle was developed in Holland. It is of the dairy type, and is noted for its black color, marked off by a white stripe or blanket of varying width which extends entirely around the body between the hips and shoulders. It has not made much of a reputation for milk or butter-fat production, and, so far as public evidence goes, it is one of the poorest dairy breeds. There are very few herds in America, and they attract more attention from their peculiar markings than for actual merit.

The French Canadian is a breed that has had special development for 200 years or so in Quebec, Canada. These cattle are black or very dark fawn in color, and probably had their origin in France, from the same sources as the Channel Island cattle. This is one of the small breeds, the mature cow weighing about 700 pounds. French Canadian milk tests slightly above 4 per cent in fat. Some large milk records are reported from Canada, but the specimens of the breed to be found in the United States do not seem to be important producers. It is regarded as a very hardy breed. There are few herds in the United States, these being located in the northeastern portion, though especially in New York.

The Kerry is an Irish breed that has long been bred in Ireland. It is black in color, though white sometimes occurs about the udder of the cow. It is of small size, and will exist where most breeds would starve, hence it is the poor man's cow of Ireland. It is strictly a dairy type, and produces an excellent milk, testing about 4 per cent fat. Some of the cows give a large yield of milk, considering their size. Milk records in Ireland supervised by the Department of Agriculture, show yields in a year up to 8,124 pounds. There are but few Kerries in America.

The Dexter is another Irish breed, of uncertain ancestry but closely related to the Kerry. These cattle may be black or red in color, and are the smallest breed found in America. Many of the mature bulls and cows stand only 36 to 40 inches high. The cows often produce excellent yields of milk, testing above 4 per cent fat. Cases are on record where cows of this breed weighed around 500 pounds and produced in a year over 8,000 pounds of milk. These diminutive cattle may never be popular for general dairying in America, but they will grow in favor for family use.

The Devon is red in color, and originated in Devon, southwest England. It is a breed that is found to be either beefy or dual-purpose in form. It is a very old breed, and was brought to America by the early settlers of this country. Devons are not popular, and but few herds exist. It has lost ground in this country while other breeds have gained.

Recently, however, the few members of the American Devon Cattle Club have attempted to establish official testing of Devons, and to demonstrate that they have cows of real merit in milk and butter-fat production in this dual-purpose breed. This awakening interest is largely among eastern breeders, in a section where dairy production is of much greater interest to cattlemen than is the growing of beef.

The Red Polled, as its name shows, is red, and without horns. The breed originated in Suffolk and Norfolk counties in eastern England. Red mulley cattle have been known in America since the early settlement of the country, but the first importation of the breed recorded was in 1873. These cattle are regarded good for both beef and milk production. The cows make a very good grade of milk, but, as a rule, are not heavy producers, although some excellent milk records have been made. The cow Jean DuLuth Beauty produced 20,280 pounds of milk in a year, containing 891½ pounds of fat. Red Polled cattle are most common in the Middle Western states, especially Iowa, Illinois, and Wisconsin.

SOME COMMON QUESTIONS RELATING TO DAIRY CATTLE

1. What did the people of Jersey do to protect the purity of their cattle?
2. What is the difference between Island and American type Jerseys?
3. How productive is the Jersey in milk and butter-fat?
4. How large are Holstein-Friesian cattle?
5. What would be average Holstein-Friesian milk yields, and how do these compare with heavy records made?
6. How adaptable is the Holstein-Friesian breed to American conditions? Where is it most abundant?
7. In what respects do Guernseys and Jerseys resemble each other?
8. How do Guernseys rank in official milk tests?
9. In what section of the United States are Guernseys most popular?
10. What is the color of the Ayrshire?
11. Why is Lily of Willowmoor a noted cow?
12. Are Brown Swiss dairy or dual-purpose type?
13. What is the difference between the Kerry and the Dexter?

SOME INSTRUCTIVE LABORATORY WORK

14. A comparative study of two or more dairy herds of different breeds.
15. Making a township or county map of pure-bred herds.
16. Getting records of production from different herds.
17. Studying lines of breeding in one or more herds.
18. Investigating the use of pure-bred sires in grade herds.
19. Locating the best bred sire in the community.

CHAPTER XXV

JUDGING DAIRY CATTLE

The following discussion of judging dairy cattle is based on the scale of points in the score card in this chapter. This is general in its character, and is suited to the dairy cow irrespective of breed. Each of the national breed associations promoting dairy cattle has its official standard for

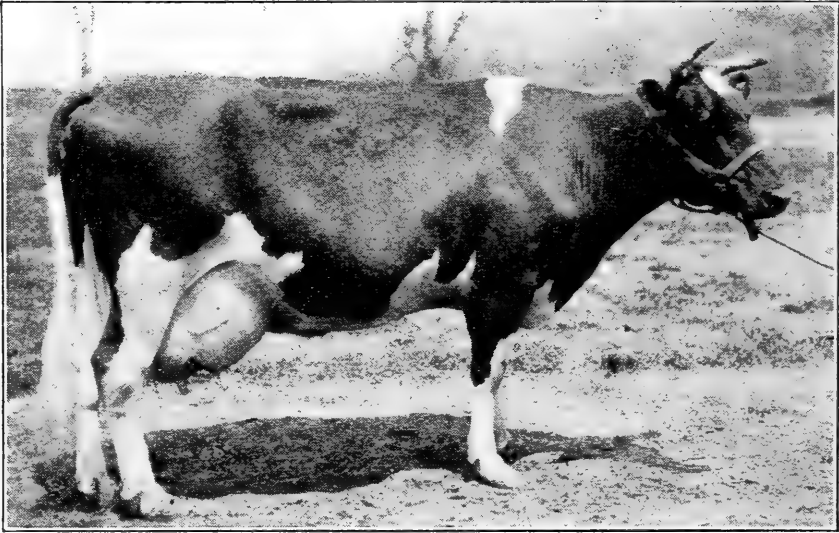

Figure 117.—Holstein-Friesian cow Maplecrest Pontiac Application, a fine example of dairy type. She has a record of 1,075 pounds of butter-fat in 365 days. Photograph from *American Agriculturist*.

each sex, and this may be used to advantage in breed study. The contents of this chapter are in harmony with the principles and practices involved in judging, and so should be a fitting introduction to score card work with the breeds.

The size of the dairy animal is not material, unless in the case of a breed that has certain size requirements. Among

grade animals may be found valuable producers at wide ranges of size. There are large producers in each breed, from the little Dexter, weighing 500 pounds, up to the Holstein, weighing 1,800. For this reason, size is of minor importance, if producing capacity and proper conformation exist.

The general form of the dairy cow should be somewhat wedge-shaped, often referred to as the "triple wedge." This shape really means a narrowness in front and heaviness be-

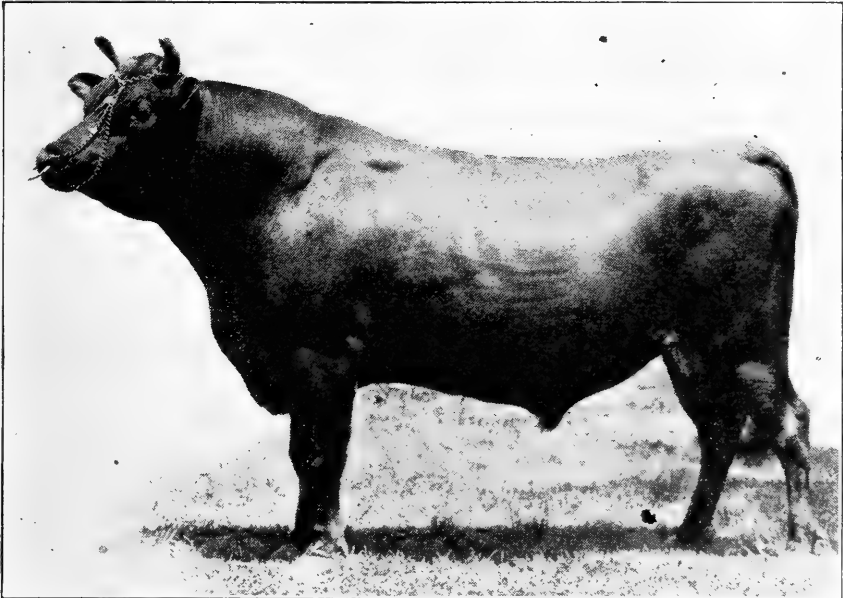

Figure 118.—Jersey bull, Fontaines Raleigh. Photograph from the owner, C. I. Hudson of New York.

hind. As one looks at a typical dairy cow from one side, the front part seems less deep than that behind. If a stick of ample length were laid along the back, and another were placed in a similar position against the under side of the body, they would meet at a common point in front, if sufficiently extended. Thus we see one of the wedge features. If one stands in front and looks towards the rear of the animal, it will be noticed that the thickness through the front quarter at the shoulder is less than that of the hind quarter

at the hips or just below. This view shows a second wedge conformation. The third wedge is seen by standing at the shoulder and looking down over the withers and ribs. From the withers the ribs gradually widen out to form a noticeable wedge in the upper half of the body. Thus we may see the three wedges in the conformation of the dairy cow.

The general form of the dairy bull shows much less of the wedge shape than the cow. The best bulls, however, have a certain amount of thinness at the withers, and the body is long and muscular. The depth at the hind quarter is much the same as at the fore quarter, although the males are frequently somewhat high at the rear flanks. While the thighs, from a side view, appear muscular, as is the case with the cow, from the rear they should be thin and widely and highly separated. A beefy appearance of the thigh in this type is most undesirable.

Quality in dairy cattle has certain features in common with the beef type, such as fineness of hair and bone and mellowness of skin. The chief difference is in the thickness and length of the coat of hair, which is usually much shorter and thinner on dairy than on beef cattle. The dairy animal, as a rule, has the thinner and more elastic hide of the two. Those cattle that are of Jersey or Guernsey blood have very mellow, most elastic hides, that sometimes resemble a mole skin in their soft, pliable nature. Yellow color in the ears, skin, and horns is regarded as evidence of quality, and indicates the production of milk rich in color. The Guernsey Cattle Club places such a high value on the color of the secretions, that 15 points are allowed this feature in their scale of points.

The temperament of the dairy animal should show plenty of nervous force. This does not mean an excitable disposition, but lively rather than phlegmatic. Dairy bulls usually show plenty of nervous force, as compared with beef stock. The cow is constituted to produce milk, a task which requires

a large amount of vitality and nervous energy. Indications of the temperament are easily seen in the prominence and character of expression of the eye. Some claims have been made that prominence of the spine indicates a large spinal cord and active brain, being a further indication of nervous force. There is very little information on this subject, however, that will justify drawing conclusions.

In judging dairy cattle, further than stated, there are certain things of importance to be considered that especially apply to this type, as set forth in the following score card for a cow with the mammary parts well developed:

A SCORE CARD FOR DAIRY COWS

Scale of points	Perfect score	Student's score	Corrected score
GENERAL APPEARANCE: 19 Points.			
SIZE, large, medium, or small			
FORM, wedge shape from front, side, and top; muscular	8		
QUALITY, hair fine, silky; skin mellow, loose; bone fine	8		
TEMPERAMENT, active, showing nervous force	3		
HEAD AND NECK: 7 Points.			
MUZZLE, broad; face lean, shapely	2		
EYES, prominent, bright; forehead broad	2		
EARS, medium size, not coarse	1		
NECK, somewhat long, not thick, well placed; clean at throat; light dewlap	2		
FORE QUARTERS: 9 Points.			
WITHERS, thin and lean	3		
SHOULDERS, light, oblique	4		
LEGS, straight, short; shank fine	2		
BODY: 20 Points.			
CHEST, deep, girth large; crops not much depressed	6		
BACK, lean, strong, well defined	4		
LOIN, broad, long level	4		
RIBS, long, well sprung below, giving large capacity, with low flanks	6		
HIND QUARTERS: 13 Points.			
HIPS, wide apart, not fleshy	1		
RUMP, broad, long, not droopy; pin bones wide apart	5		
TAIL, long, fine; good switch	1		
THIGHS, thin, long, wide apart	4		
LEGS, straight, short, wide apart; shanks fine	2		
MAMMARY DEVELOPMENT: 32 Points.			
UDDER, large, carried well in front along the belly, and high up behind; thick, mellow; quarters even not much grooved between	20		
TEATS, 3 to 4 inches long, well placed; an easy milker	4		
MILK VEINS, large, long, tortuous or winding, entering large wells	8		
Total points	100		

The head should be lean and shapely. In general, the wide muzzle, short face, strong jaw, prominent eye, and broad forehead are desired. In most cases, a "dished" face is popular. This feature is a slight depression of the head at the lower part of the forehead and between the eyes. Yet all breeds do not have it. The dish-face is very characteristic of the Jersey, but is not so pronounced in the Holstein-Friesian. A broad muzzle, short face, and strong, wide jaw,

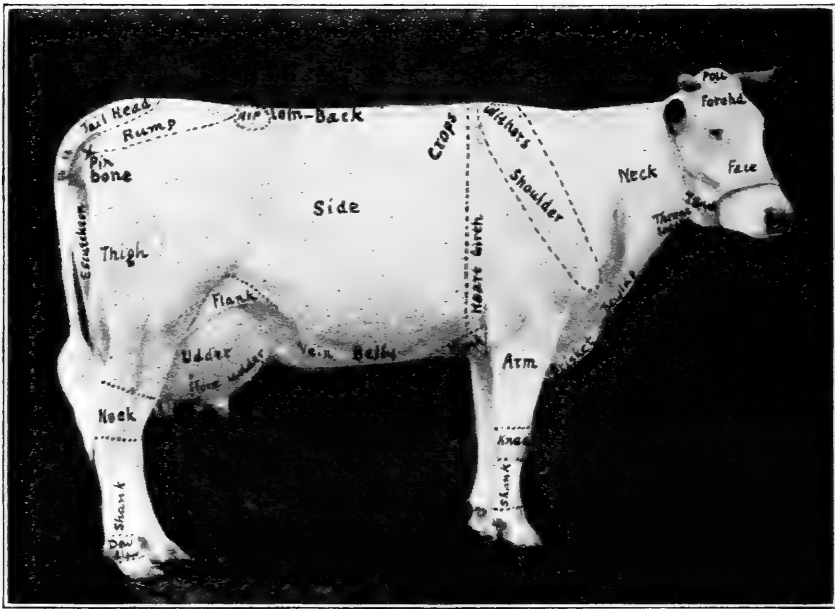

Figure 119.—The points of the dairy cow, as reproduced upon Ormsby Jane Segis Aaggie 150,943, champion Holstein-Friesian cow. As a senior four-year-old she has a seven-day record of 44.4 lbs. of butter, (Reproduced from "Judging Farm Animals", by the author.)

indicate a vigorous feeder. The eye should be prominent yet show a mild disposition, as indicated by clearness of the whites and quietness of expression. Dairy bulls often have eyes that indicate very clearly their character. The ears should be medium of size and thin of texture, and be neatly attached to the head. A yellow or orange color within the ear is desirable. The horns, when present, should show refinement, and not be large and heavy at the union with the

head. A small horn is preferred on the females, and some of the best known dairy sires have had rather small horns. A thin, muscular, somewhat long neck on the cow, and a strong, heavily-muscled, rather crested neck on the males, are desirable. When the neck blends well with the head, there is no unnatural fullness at the throat. The union of the neck with the shoulders should also be smooth. Dairy animals sometimes have a heavy dewlap, which, being an evidence of coarseness, is rather objectionable.

The fore quarters of the dairy animal incline to be somewhat prominent and are often rough. This appearance is in most cases due to the lack of covering of flesh. The smoothness of the shoulder found in the beef animal is not to be expected with the dairy type, but the blades should extend well into the back and not be coarse. The withers above the shoulders should be lean and somewhat sharp. In fact, dairy cattle judges place a premium on thin, sharp withers. Many great-producing cows, however, have some thickness or fleshiness at this point. Occasionally, one will find dairy cows with the shoulder points noticeably separated from the body. This characteristic is what is called a spread shoulder, and shows a weakness of the muscular attachment. Such a cow has an undesirable appearance, but otherwise is not seriously affected.

The body of the dairy cow should be deep at the chest, yet not thick. As one views the animal from one side, the depth from the top of withers to bottom of the chest should be much greater than the length of leg. From a front view, the chest appears somewhat narrow. Not much depression back of the shoulders below the withers, at the point known as the "crops," is desired, for this indicates weakness in heart girth. The same criticism will apply at the fore flank. The back should be well and strongly carried, with the spine easily seen above and beyond the shoulders. A strongly arched rib will give a wide back and a muscular loin, which

are most desirable, while plenty of additional length of rib will mean ample digestive capacity. In examining the body with the hands, one should be able to place two fingers held side by side easily between the last ribs of mature dairy cattle. The opinion prevails, that with dairy animals there should be length of body with the ribs less closely placed together than is the case with beef cattle. Consequently, a body of considerable length meets with favor. Some judges prefer the hind flank to be somewhat high, but this



Figure 120.—Judging dairy cattle. Viewing top lines from the rear. Photograph by the author.

quality is associated with lack of depth of body, signifying a deficient digestive capacity.

The hind quarters of the dairy animal have been the cause of much discussion. The hips of the cows should be somewhat prominent and lean. With the males, less prominence of hip is desired. In the case of each sex, much length and breadth, with level carriage of rump, is wanted. Below this part, the thighs, as viewed from one side, should appear muscular and long. From the rear view, the thighs should seem thin and placed wide apart, giving ample room between for a large udder. We sometimes say that the thighs are

incurving, meaning that from the point of the rump, or pin bone, each thigh curves slightly for a distance towards the body before curving outward to form the top of the hock. The tail should have a neat placing on the body, and its fleshy part should hang in a perpendicular position to the hocks, showing considerable space between it and the thigh as viewed from one side. A beefy character of any part of the hind quarter is very undesirable. The tendency is to show fleshiness at the top of the rump over the hips and pin bones and on the thighs. A straight, wide carriage of

the legs is most essential, as has already been explained and as will be brought out further on in relationship to the udder.

The mammary development of the cow includes the udder, teats, and milk veins and wells. It is necessary to examine this part carefully with both eye and hand.

The udder consists of two large glands suspended between the legs. One gland is the right half of the udder, and the



Figure 121.—Judging dairy cattle. Estimating the length of rump. Photograph from *The Farmer*.

other the left. Each gland is also divided into two halves, known as quarters. As we view the udder at one side, we see the front and hind quarters of the gland. The form of udder that is most approved follows the line of a circle in part, although we look for the rear portion to be carried up high beyond the line of the circle, and the fore part to extend well along under the belly, on a uniform level. These udder lines above and below extend beyond the circle. Viewed from the rear, the udder should appear thick, and should occupy completely the space between the thighs, and extend up high along the thigh. Examination with the hand should

show no deep separation or division between the glands or quarters, but only slight grooves. As a rule, the hind udder

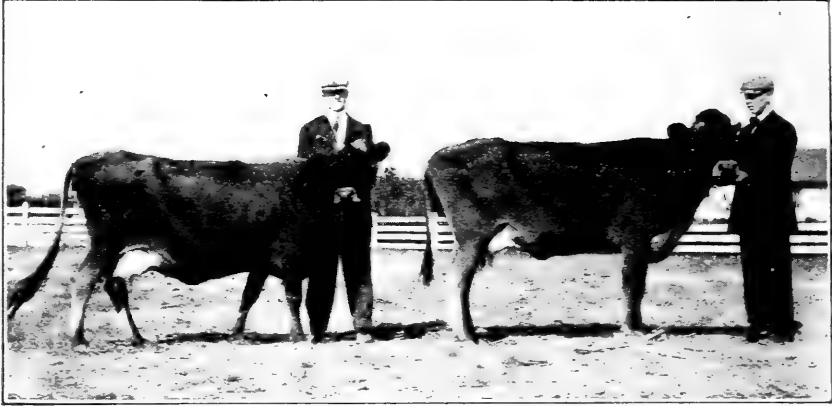

Figure 122.—Judging dairy cattle. Two Jersey cows, the one on the left showing depth of body and constitution, the one on the right showing a short rib and poor feeding capacity. Photograph by the author.

is somewhat narrower than the fore udder, due to the limited space between the thighs. Thus one may see the importance



Figure 123.—Four hind end presentations of dairy cows, showing good and bad placings of the legs. Photograph by the author.

of having the thighs widely separated to provide room for the udder.

The teats should be of convenient size for grasping by the

average-sized hand, and a length of three to four inches is satisfactory. They should be placed at a fair distance apart, to permit of easy milking, without having the hands in the way of each other. The judge should examine each teat carefully, and see that it milks without difficulty, and is all right. The form of the udder is rather variable. The most common weakness is an inferior front develop-

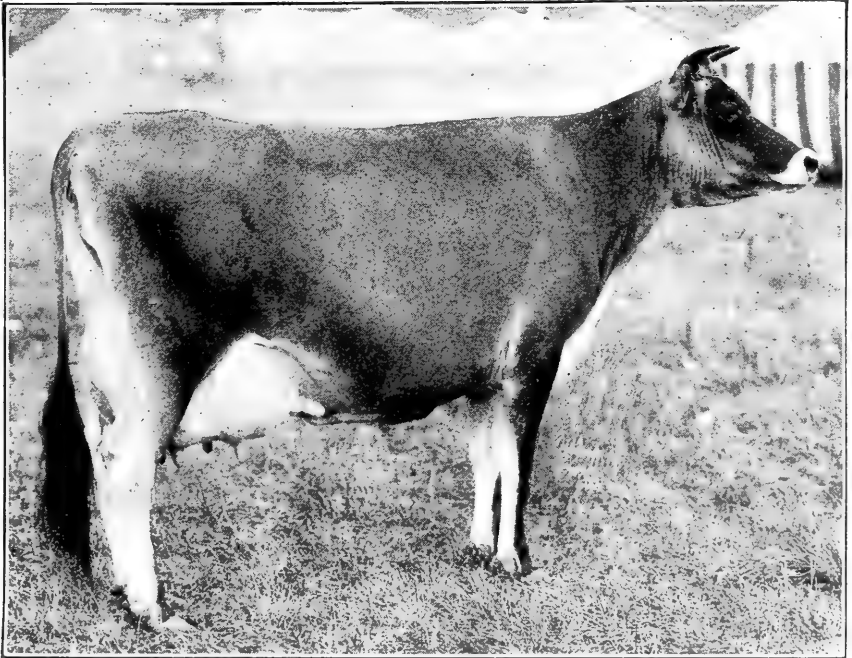

Figure 124.—A beautiful udder on a great show cow of dairy type—Bosnian's Anna, owned by C. I. Hudson of New York. Photograph from F. R. Marshall.

ment, with the teats of this part placed much higher than those behind. The smaller the fore udder in comparison with the hind part, the less its producing capacity.

With age, the udder often becomes pendant; that is, hangs low down. This feature is especially characteristic of those cows that become heavy milk-producers. In acting as a judge in the show ring, one may find it desirable to request that certain cows be milked. Some cows have meaty

udders of quite limited capacity, and to make a fair study of this gland, one should see it both full and empty. When empty, the glands should be considerably shrunken, and, when pressed by the hands, should feel uniformly mellow and smooth to the touch. The judge should take the udder in his hands and press it between the palms, and examine it generally as to its condition, noting whether smooth of tissue, or if lumps or knots occur. Again, examination may show imperfect quarters or defective teats.

The milk veins are located along on the belly from the udder forward. Usually there is one vein on each side, and sometimes a shorter one between. Through these veins the blood passes from the udder to the heart. A side view of the cow shows something of the vein on that side. On young cows it is smaller and less prominent than on old ones. It varies in size, length, and form. To examine it carefully, it is necessary to bend over enough to look up beneath the body and



Figure 125.—Judging dairy cattle. A common type of poor udder, especially defective in front. Photograph by the author.

see the whole milk-vein system. Usually the vein is about five eighths of an inch wide, and, after extending along the belly half way or so from udder to fore legs, disappears through a hole in the belly wall, known as the “milk well.” Sometimes the veins are very large and long, and have a more or less tortuous, or serpentine, course. The larger and longer the veins, the greater the cow as a milker. Sometimes we find the belly immediately in front of the udder covered with small veins, and occasionally they also occur on the udder. All these small veins are indications that the cow is more than an average milk-producer.



Figure 126.—Judging dairy cattle. Locating the milk well. Photograph by the author.

The milk wells vary in size, from those so small that they are not at once discovered to those so large that the end of the finger can be placed therein. Small wells are associated with similarly small veins, and together they limit the supply of blood passing through the udder and thus affect milk production.

IN JUDGING DAIRY CATTLE

1. How much emphasis should be placed on size?
2. What is meant by the triple wedge form?
3. What are some of the evidences of quality?
4. How is dairy temperament indicated?
5. What three features of mammary development are emphasized, and how many points do they total in the scale of points?
6. Should a "dished" face be sought in the Holstein-Friesian?
7. Are the withers important factors in conformation? If so, how?
8. Would you place a premium on length of body? If so, why?
9. Why are thick thighs objectionable?
10. What type of udder should be sought?

DESIRABLE OBSERVATIONS IN SOME HERD

11. The relationship of size to production.
12. The relationship of color of skin and horn to quality of milk.
13. The relationship of form to production.
14. A comparative study of types of udders.
15. A score card study of "the best cow."

CHAPTER XXVI

FACTORS INFLUENCING MILK PRODUCTION

The dairy cow as a producer of food occupies a very high place in animal economy. As a producer of meat she is of secondary importance, but her milk furnishes the most easily digested food and, under fair conditions, she returns in it a pound of nutriment at less cost than comes from an equal

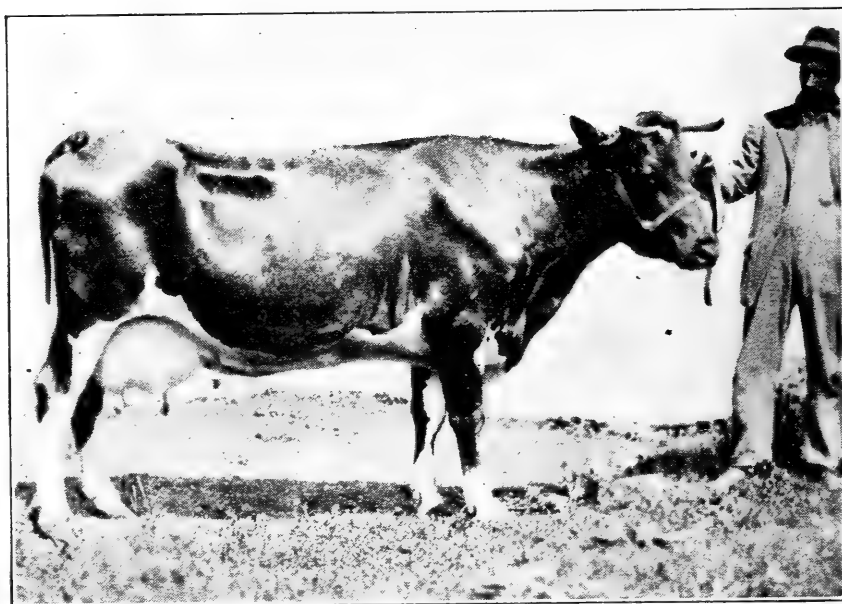

Figure 127.—The dairy cow as a producer of food. This cow made nearly 20,000 pounds of milk in a year. Photograph by the author.

amount of food from beef cattle, sheep, or swine. This fact has been brought out in an interesting way by Dr. C. H. Eckles, in his feeding experiments at the Missouri Experiment Station.* A comparison was made of the milk produced by a Holstein-Friesian cow in a year and the carcass of a fat steer weighing 1,250 pounds. The cow gave

*Dairy Cattle and Milk Production, 1911.

a yield of 18,405 pounds of milk, which contained 2,218 pounds of dry matter, all of which was digestible. Deducting 56 per cent of the weight of the steer's carcass, which was water, there was left 548 pounds of dry matter, which included a considerable part that was not edible, such as hair, hide, bones, and tendons. "The cow," writes Dr. Eckles, "produced proteids sufficient for more than three steers; nearly fat enough for two, ash enough to build the skeleton for three, and in addition produced 920 pounds of milk sugar, worth as much per pound for food as ordinary sugar."

A comparison of dairy with beef-type cows in milk production under fair conditions will show the dairy-type animal to be much the more economical producer of the two. Prof. Haecker of the Minnesota station has brought this point out in a striking experiment. He selected four types of cows; (a) beef, (b) not so beefy, (c) spare, but lacking depth of rib, and (d) dairy type. As might have been expected, he found that the amount of dry matter consumed in the feed and the cost of the feed for each pound of fat produced steadily decreased from the beef to the dairy type. Here we have a striking argument in behalf of dairy-type cattle where milk production is sought.

The productive cow compared with the unproductive. Every herd of cows shows more or less variation in production of different animals. This difference is due to various causes. Each owner of a milking herd should, therefore, keep a careful record of the production of each cow from day to day, and determine for himself which ones are returning a profit, and which are not. During recent years many cow-testing associations have been organized, and herd owners have given careful study to this subject. Of two cows of the same type, one may be a very profitable producer, and the other what is termed a "boarder," not returning enough milk to pay for her food. This cow may be

unproductive for one or more reasons, as, for example, inferior ancestry in milk production, being a poor feeder, ill health, age, etc.

The influence of the breeds in milk production is very marked. What may be termed standard milk consists in about 87.2% water, 3.8 fat, 3.5 proteids, 4.8 fat and 0.7 ash.* As a rule, the larger the yield of a cow, the smaller the per cent of butter-fat and of total solids. This rule will apply within a breed. If we compare the breeds, on the basis of many thousands of records, we find that the Jersey and the



Figure 128.—Czarina 2nd, a thick fleshed type of Shorthorn cow. Photograph by F. H. Haskett.

Guernsey produce the milk richest in total solids and butter-fat, while the Brown Swiss, Ayrshire, and Holstein-Friesian, in the order given, produce milk with a smaller amount of total solids and fat. According to Prof. Larsen,† Holstein-Friesian milk consists of about 12.25 per cent of total solids and 3.48 per cent of fat, while Jersey milk tests 14.87 per cent of solids and 5.19 per cent of fat. The fat globules in the Holstein-Friesian milk are smaller than those of the Jersey

*Larsen's Farm Dairying, 1919.

†Farm Dairying, 1919.

or the Guernsey and lack the deep yellow color of the latter. Whether one breed is more profitable than another largely depends upon the individual animals, the amount of milk produced, and its cost of production.

The influence of age on milk production has been carefully studied by various investigators. On this subject Eckles states* that "a dairy cow, on the average, as a two-year-old may be expected to produce about 70 per cent; as a three-year-old around 80 per cent; and as a four-year-old about 90 per cent of the milk and butter-fat she will produce under the same treatment when mature." As a rule, we expect a cow to be at her best from six to eight years of age, but there are remarkable records that have been made by cows well along in years. The Jersey cow Pogis Irene 2nd, at 18 years of age produced 9,930 pounds of milk, which would be an excellent record for a Jersey in her prime.

The influence of the period of lactation on milk production is of interest. Under normal conditions a cow should be milked about ten months, go dry two, and produce a vigorous, healthy calf. The natural tendency is for the cow of dairy type to keep up her milk flow fairly well for the first seven months, after which it gradually declines. Prof. F. W. Woll made a study of the production of some 300 cows in the Wisconsin Dairy Cow Competition, 1909-1911, and he reports† that "the normal decrease in the flow of milk in well managed dairy herds is about 5 per cent a month during the second to seventh month of the lactation period, about 10 to 12 per cent during the eighth and ninth months, and 20 per cent for the tenth and subsequent months."

The relationship of condition of the cow to the quality of her milk is very marked. If the cow is in good flesh, she will yield more and richer milk than if in thin flesh. It is a well recognized fact to-day, that dairy cows fattened and in high condition when they come fresh, produce a milk

*Dairy Cattle and Milk Production, 1911.

†Productive Feeding of Farm Animals, 1915.

abnormally rich in fat. For this reason, most persons who are engaged in officially testing their cows, start them on test in as good condition as possible; for the body fat is more or less milked off into the pail, especially during the first two or three weeks. It has been estimated that the milk during this time will contain from 1 to 2 per cent more fat than is usual in ordinary flesh. Eckles, in expressing his objection to seven-day official tests, referring to those of the Holstein-Friesian says: "The average per cent of fat for the breed is 3.45, but many seven-day tests are now reported with a per cent of fat over 4.50, and several above 5 per cent."

A comparison of first and last drawn milk shows that the first milk contains a larger per cent of water, and less total solids and fat than the last drawn. This fact suggests that, if one is to feed part of the milk from a single cow to a calf, it will be wiser to feed the first drawn and reserve the last for family use.

The influence of the weather on milk production is quite marked. If the weather turns cool and the cattle are exposed to rain in an unusual degree, the probabilities are that the milk yield will fall off to some extent, but will show some increase in butter-fat content. Warm weather under ordinary food conditions would, therefore, promote milk flow rather than do otherwise. If there is a drouth, and the cows are kept on pastures that are badly dried up, then the milk yield may rapidly diminish, unless there is resort to extra feeding. It has been assumed that in hot weather the biting of many flies reduces the milk yield, but the evidence on this point is lacking. In fact, such information as we have indicates that flies have little or no effect on milk yield.

The effect of different foods on the flavor and quality of milk is very marked. Cows that eat wild onions or garlic transmit the characteristic flavors of these to the milk. Rye and turnips, unless fed soon after milking, give an

objectionable flavor. These flavors are due to the volatile oils in these feeds, whereby they impregnate the milk while in the body of the cow. The effect of some feeds is to produce hard butter-fat, while others make it soft. Butter made from milk from cows fed cottonseed meal has a high melting point, while corn meal has the opposite effect on the butter-fat, although not in any serious degree. The fat in the milk takes on a more yellow hue when the cows are turned on pasture or when they are fed carrots, bright green alfalfa hay, or new silage. This yellow color is due to what is known as carotin, which is more abundant in carrots and green feeds than elsewhere.

The effect of the different kinds of food on the milk yield may be quite marked, cows responding more with some foods than others. The yield will fall off with the use of coarse, dry, unpalatable foods, and increase with those of finer quality that are succulent and palatable. The kind and character of the feed, however, can not materially change the quality of the milk. A cow fed rye straw, a very low grade food, may fall off in her milk flow, but there will be no essential change in the character of her milk. If it were possible to change the composition of milk by feeding, then the individuality of the milk of the Jersey or the Ayrshire might be changed, thereby seriously affecting its character and value.

Frequency of milking no doubt has a bearing on the yield. Under most conditions cows are milked twice daily. As the official testing of dairy cows has progressed, however, the custom has developed of milking three or four times daily, as conditions justify. Heavy milkers, such as Holstein-Friesians, are milked at least three times and in many cases four times. In Holland in common practice the cows are usually milked three times daily. If there is the same period of time between each milking, the milk will show quite uniform tests of total solids and butter-fat. If, however, there is a considerable difference in the number of hours

periods, the milk will show the greater percentage amounts of solids and fat in the shorter interval.

Regularity in milking is important. The dairy cow, to do her best, should not only be fed regularly, but milked with equal regularity. Thus, as a matter of habit, she will respond to the care of the milker, and will give down without restraint. Experiments at the Ontario station showed that when the cows were milked irregularly the practice somewhat reduced the yield and the per cent of fat in the milk.

The influence of the milking machine on production, when properly manipulated and cared for, may be very

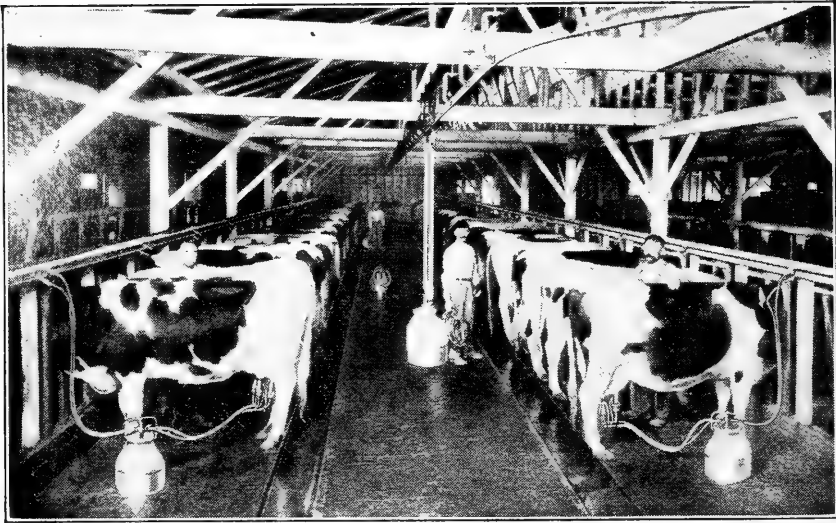

Figure 129.—Milking with the De Laval milker. Photograph from De Laval Separator Company.

satisfactory. Cows milked by the machine seem undisturbed by its action, and give down their milk as in ordinary good hand milking. It is necessary, however, to watch the machine with reasonable care, and, as a rule, the cows must be stripped by hand after the machine has done its work. The most important factor in the successful use of the milker is a competent man, who has an intelligent knowledge of machinery and who will take proper care of it and see

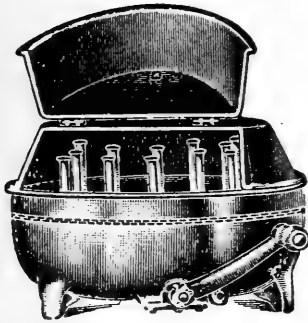

Figure 130.—Hand milk testing machine. Reproduced from Burrell & Co. catalog.

that it is always kept in good repair and in a sanitary condition.

The testing of milk for its fat content is in practical application daily in thousands of creameries and on dairy farms. The Babcock test, the invention of Dr. S. M. Babcock, of Wisconsin University, is the one in almost universal use, and is made as follows. A fair sample of milk is taken, in which the fat is

well distributed. For example, if it is desired to test the milk of a cow, after it is drawn it is poured from one pail into another and then back again, to see that it is well mixed. Then with a glass pipette, 17.6 cubic centimeters of milk are measured, and this sample is placed in a small test bottle with a slender neck which is graduated up to ten per cent. Next 17.5 cubic centimeters of commercial sulphuric acid, having a specific gravity of 1.82, are measured off in a glass graduate, and this is poured into the bottle and mixed with the sample of milk. It is best to hold the neck of the bottle in a slanting position when pouring in the acid, turning the bottle during the operation, so that any milk which may have adhered to the neck will be washed down. This combination is attended with some heat, the contents of the bottle turn a blackish

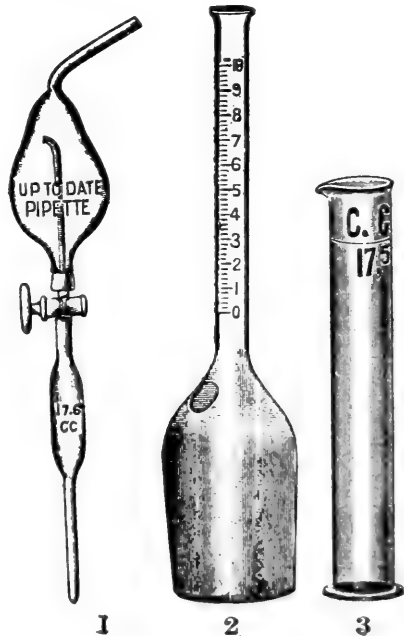

Figure 131.—Milk testing equipment. 1—pipette; 2—milk bottle; 3—acid measure. Reproduced from Burrell & Co. catalog.

brown, and all the solids in the milk excepting the butter-fat are destroyed. If this small bottle containing the milk sample is then placed in a well balanced centrifugal machine made for the purpose, and is turned for five minutes, the fat is thrown to the surface of the fluid. Hot soft water is then placed in the sample bottle, until it reaches the neck, after which it is rotated in the centrifugal two minutes longer. Then more hot water is added, to fill the neck high enough to permit reading the per cent of fat, which accumulates as a solid column when the bottle is whirled a minute more in the centrifugal. One usually measures the fat by use of common dividers, setting the points at the lower and upper line of fat, after which one point is placed at the 0 mark, while the other point indicates the per cent of fat in the milk. The fat should always be measured while hot, before it has contracted by cooling. Every dairy farmer should have a Babcock test outfit, and carefully test the milk of his herd.

Cow-testing associations have assumed much importance in the United States in recent years. The first association of the kind is said to have been established in Denmark in 1895,* while the first one in America was organized in 1905 at Fremont, Michigan. In 1921 there were 452 of these associations in the United States, with Wisconsin in the lead with 103, Pennsylvania second with 45, and Ohio third with 35. The purpose of the cow-testing associations is to secure disinterested records of the individual cows in the herds of a community. A group of farmers form a co-operative association, adopt rules for conducting the tests of herds and employ an expert or official tester to supervise the work. This person visits each herd at least once a month, when he weighs each milking of the day, and takes samples of the milk, which he properly tests. He may also make a record of the kind and amount of food fed on the day in question. Unless two small herds are close by, in

*Farm Dairying, By C. Larsen, 1919.

which event they may each be tested the same day, as a rule but one herd a day is visited. The number of tests in a month, however, will depend on the size of the association, which should not consist of over 26 herds. On July 1 1921, the 452 associations in the United States had 11,209 members, and the herds averaged 17.3 cows each.

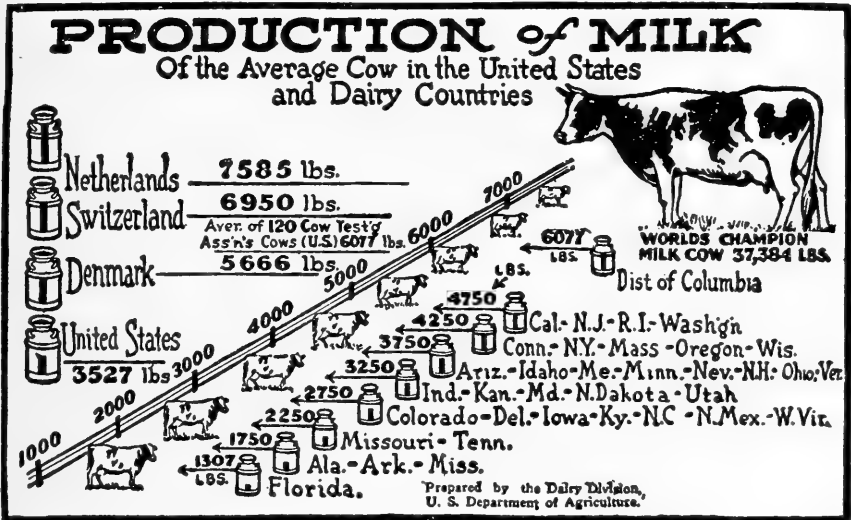

Figure 132.—Showing the milk production of the average cow in the United States and dairy countries.

WHAT DO YOU KNOW ABOUT

1. The dairy cow as a producer of digestible food?
2. The relative merits of beef and dairy cows in milk production?
3. The composition of Jersey and Holstein-Friesian milk?
4. The effect of the cow's age on milk production?
5. Decreased milk flow and stage of lactation?
6. Securing high butter-fat records in official testing?
7. The effect of different foods on the flavor of milk?
8. The effect of the milking machine on production?
9. How the fat content of milk is determined?
10. Cow-testing associations?

VISIT SOME DAIRY HERDS AND

11. Note the type of cows being milked.
12. Determine what breeds are in most favor.
13. Learn what per cent of the cows are over eight years old.
14. Study the milk sheets in the stable.
15. Note the rations being fed.
16. If milking machines are used, ascertain with what success.
17. Compare, if possible, some tested with untested herds.

CHAPTER XXVII

FEEDING DAIRY CATTLE

The most careful study has been given to the feeding of dairy cattle. The experiment stations have done extensive work in feeding, and many practical dairymen have used feeding standards and made up carefully balanced rations in efforts to work out their home problems.

The feeding standards for dairy cattle cover young and growing animals and those producing milk. There is not much difference in the growth requirements of dairy and beef cattle. Slightly more protein is recommended for the latter, with about equal amounts of carbohydrates. The amount of food given to milk-producing cows depends largely on the yield of milk. The Wolf-Lehmann tables here quoted are from Feeds and Feeding, by Henry and Morrison.

I. Wolf-Lehmann feeding standard for growing dairy cattle.

Age months	Average live weight	Per day for 1,000 lbs. live weight					Nutritive ratio
		Dry matter	Digestible protein	Nutrient carbohydrates	Fat		
2- 3	150 lbs.	23 lbs.	4.0 lbs.	13.0 lbs.	2.0 lbs.	1:4.5	
3- 6	300 "	24 "	3.0 "	12.8 "	1.0 "	1:5.1	
6-12	500 "	27 "	2.0 "	12.5 "	0.5 "	1:6.8	
12-18	700 "	26 "	1.8 "	12.5 "	0.4 "	1:7.5	
18-24	900 "	26 "	1.5 "	12.0 "	0.3 "	1:8.5	

II. Modified Wolf-Lehmann standard for dairy cows.

For maintenance 1,000 lb. cow . . .0.700 lb. digestible crude protein
 .7925 total digestible nutrient.

To allowance for maintenance add: Digestible crude protein Total digestible nutrients

For each lb. of	% milk	Digestible crude protein	Total digestible nutrients
3.0	"	0.047-0.057	0.286
" 3.5	"	0.049-0.061	0.316
" 4.0	"	0.054-0.065	0.346
" 4.5	"	0.057-0.069	0.376
" 5.0	"	0.060-0.073	0.402
" 5.5	"	0.064-0.077	0.428
" 6.0	"	0.067-0.081	0.454

Feeding milk to the dairy calf, as practiced in the United States, does not vary greatly in method among intelligent breeders. The calf is usually allowed to stay with the mother in a box stall for 3 or 4 days after it is born, nursing at will. Some persons, however, take the calf away within 24 hours or at once. It is a good plan to allow the calf to nurse the cow until the milk is fit to use, being careful not to overfeed, for the massage and frequent nursing of the calf will help to reduce udder inflammation. The milk for the first 3 or 4 days contains a substance called *colostrum*, which makes fresh milk more or less sticky, and this material acts as a desirable physic with the new-born calf.

After being taken from the mother, the calf must be fed whole milk, preferably from the dam. Calves are fed this new milk for from 1 to 3 weeks, starting with 8 to 10 pounds a day, divided in 3 feeds. Then skim milk is gradually substituted for the whole, adding each day a pound until only skimmed milk is fed. The milk for the young calf should be sweet and always be fed in perfectly clean pails under sanitary conditions, at a temperature of about 100 degrees, or as it may come from the separator. Care should be exercised not to overfeed. A good rule to go by is to feed 1 pound of milk for each 8 or 10 pounds of live weight. For example, a Holstein-Friesian calf weighing 100 pounds might be fed 10 or 12 pounds. Skim milk may be profitably fed, when cheap or abundant, up to 8 or 10 months of age, when the calf should be weaned. Whole milk is too expensive for calf feeding unless for some special purpose, while the skimmed milk under proper conditions produces a strong-framed, vigorous animal.

Feeding roughage to the dairy calf is a very simple matter. If a handful of fine leafy hay or clover be placed in the stall when the calf is 2 or 3 weeks old, it will begin to nibble on it, and its consumption of this roughage will gradually increase. This dry coarse feed will distend the stom-

ach and increase its feeding capacity. The most popular hay fed dairy calves is either clover or alfalfa. A 200-pound calf will consume 2 or 3 pounds of hay a day.

Feeding concentrates to the dairy calf begins, as a rule, at 2 to 3 weeks of age. The best plan is to have a small feed box in the manger or stall, in which a handful of some palatable meal may be placed. A mixture of equal parts of corn meal, bran, and oats will be relished. Messrs. Hulce and Nevens, of the Illinois station, recommend* a mixture of ground corn 10 parts, by weight, oats 50 parts, wheat bran 30 parts, and oil meal 10 parts. One may feed shelled or cracked corn in the milk, if desired. When skim milk is fed, the calf should not be fed oil meal or foods rich in protein, because the nutritive ratio of skim milk is extremely narrow (1:1), so that some food rich in carbohydrates should be used instead, and corn serves this purpose very well. The calf should be fed enough grain and roughage along with the milk to keep it gaining from a pound to a pound and a half a day.



Figure 133.—Feeding the young dairy calf. . Photograph by the author.

Raising calves with a milk substitute has not met with general success, unless begun after 2 or 3 months of age. Substitutes for milk have been made and sold on the market, and teas have been made from hay and mixed with concentrates, but these are not entirely satisfactory. Milk in some quantity for a time is really essential, if the calf is to do well. Hulce and Nevens say: †

*Circular 202, Univ. of Ill. Ag. Exp. Station, Feed and Care of the Dairy Calf.
†Ibid. p. 6.

"It is necessary in using a milk supplement other than skim milk to feed a considerable amount of whole milk. The amount of milk required is about a pound daily for every eight pounds of live weight until the animal is four or five weeks old. At that age a milk supplement may be substituted gradually for the milk. Such a supplement may be prepared as a gruel mixture made up of equal parts of oil meal, blood meal, hominy and flour. The gruel is made by pouring hot water over the meal while it is stirred vigorously, after which it is allowed to stand before being used. The gruel may be fed at such a rate that the animal receives the equivalent of one fourth pound of dry meal daily at the beginning, the amount being increased about one fourth of a pound daily each week for four weeks. As a rule the use of milk should be continued until the calf is at least 60 days of age. At two months of age the calf will have received about 400 pounds of whole milk in addition to the milk supplement."

Feeding the dairy heifer after weaning calls for securing a consistent, strong growth by the use of as much good roughage as possible and a relatively small amount of grain. There is nothing better for this purpose than legume hay, corn silage, and 2 or 3 pounds of grain a day. In an extended report* on experiments on "winter rations for dairy heifers," Prof. C. H. Eckles offers some practical suggestions from which the following is abstracted.

(1) When silage and legume hay is available, a ration of corn silage, alfalfa, clover, cowpea or soy bean hay at will, and 2 pounds daily of grain also, if the calf is under 10 months old, is recommended. Corn may be fed, or a mixture of other grains if the cost is less. From 2 to 5 pounds of grain a day should be fed heifers within 3 months of calving.

(2) When legume hay is not available but corn silage is, use silage at will with some other dry hay or fodder. Two or 3 pounds of some concentrates should be fed daily, half of which should be rich in protein, such as gluten feed, linseed meal or cottonseed meal, the other half being corn, bran, or any other mixture if cheaper than corn.

(3) When legume hay is abundant, but no silage, a ration of alfalfa, clover, cowpea or soy bean hay at will, and 2 pounds of corn daily will make a satisfactory ration. On a ration of legume hay dairy heifers will do fairly well but will not make a normal growth. It is economical as a rule to feed a limited amount of grain in addition.

(4) When corn fodder, or Kafir corn or timothy hay is available, but no silage or legume hay, it will be wise to buy legume hay. The suggested ration is half and half legume and timothy hay, with corn fodder at will. For concentrates with this roughage feed a mixture of one part gluten feed, or cottonseed meal, or linseed meal, and two parts corn. If legume hay is not at all available, then more grain must be fed.

Feeding the milk-producing cow offers an opportunity to make up many combinations of rations. It must be

*Bulletin 158 Missouri Station, October, 1918.

agreed, however, on the basis of extensive experimental as well as practical feeding, that legume hay and corn silage, with standard grains such as corn and oats and mill products like bran, gluten feed, linseed meal and cottonseed meal, furnish the most palatable and satisfactory list of feeds for common use in milk production. It is not necessary to have a great variety in order to secure satisfactory results from the feeding. If one studies the composition of rations of cows that have made high records in official testing, one will be impressed with the fact that comparatively simple rations have given very fine returns. Where one buys feed, the market price has an important bearing on the selection, but it must be kept in mind that the cow yielding a generous milk supply should have a ration in which proteid foods play an important part.

A common standard for the amount of concentrates to be fed is 1 pound for each 3 or 4 pounds of milk produced. Cows producing rich milk require slightly heavier feeding than those producing poor milk. From 30 to 50 pounds of silage are usually fed daily, according to size of cow and milk yield, with a free use of dry roughage. When on good pasture, no silage or roughage is fed, and oftentimes but little grain will then be eaten. Care should be taken to see that each cow is fed as an individual, and that she has enough to meet all requirements. Many cows are underfed. It is very important to know that of the food eaten 40 per cent is used to support the demands of the body, and 60 per cent goes to milk production. Any reduction in the amount of nutrients necessary will be shown in a falling off in weight of the cow and in a lessened milk supply. Thus it can be easily seen that it is of vital importance to feed enough to the cow.

RECOMMENDED RATIONS FOR DAIRY COWS

Various factors play an important part in making up rations, two of these being especially so in common practice,



Figure 134.—*Heifers wintered on silage, timothy hay and cottonseed meal at Missouri University.* This group received silage at will, 2 pounds of timothy hay and 1 pound each of corn and cottonseed meal daily. The average gain was 0.76 pound.

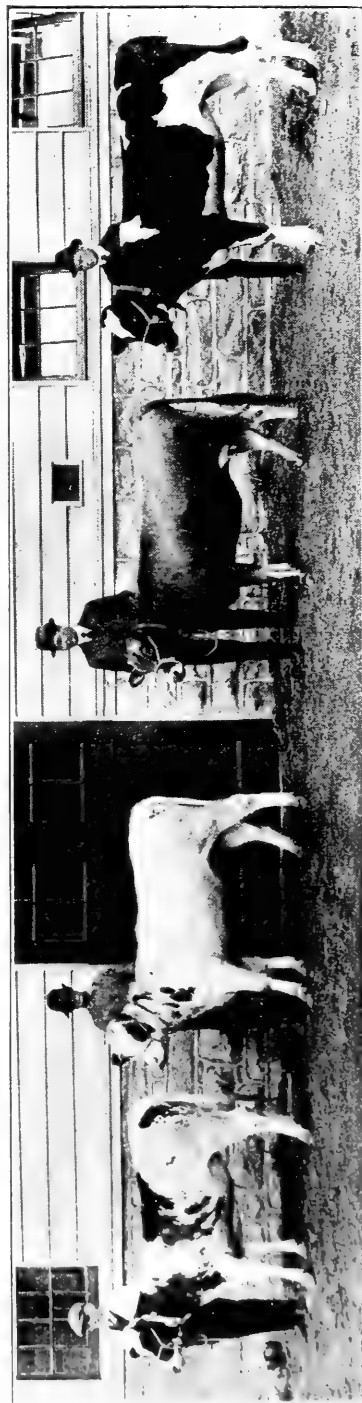

Figure 135.—*Heifers wintered on silage and corn.* This group was wintered on 2 pounds of corn daily with as much silage and alfalfa, fed in proportion of 3 to 1 as they would eat. The average ration was 17 pounds of silage, 6 pounds of alfalfa and 2 pounds of corn. The average daily gain was 1.12 pound. Photographs from Missouri University.

namely, availability and cost. The following recommended rations are by well-known American authorities on feeding dairy cattle, and for that reason are here given.

Prof. E. S. Savage of Cornell University writes.* “The

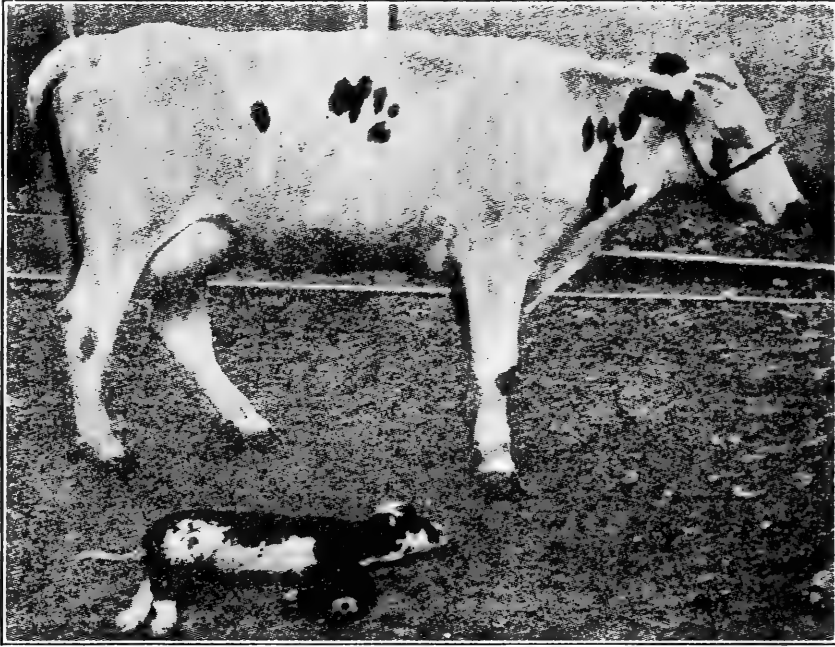

Figure 136. — The result of feeding too much wheat bran and poor roughage. This cow was fed a mixture of 6 parts wheat bran, 4 parts corn stover. Millers' bran disease resulted the cow aborting six weeks before her time. Reproduced from Bulletin 302, Wisconsin Experiment Station.

mixture I am suggesting for dairy cows this summer is as follows:

300 pounds	wheat bran.....	Cost	\$3.43
330	“ hominy.....	“	4.52
300	“ gluten feed.....	“	5.17
100	“ oil meal.....	“	1.71
<hr/>			
1000	“ will cost.....	Cost	14.83
100	“ “ “.....	“	1.49

The above is for cows on pasture.”

Prof. A. C. McCandlish, of the Iowa State College, recommends the following concentrate rations in a pamphlet on feeding dairy cattle,† it being assumed that corn silage

*Holstein-Friesian World, July 9, 1921.

†Circular No. 64, Iowa Exp. Station, March, 1920.

and some one or another of the legume hays will also be fed.

- Ration A.* 400 lbs. cracked corn, corn-and-cob meal, or hominy feed.
 200 " ground oats.
 100 " cottonseed meal.
 100 " linseed meal
- Ration B.* 400 lbs. cracked corn, corn-and-cob meal, or hominy feed.
 100 " ground oats.
 100 " wheat bran.
 100 " cottonseed meal.
 100 " linseed meal.
- Ration C.* 400 lbs. cracked corn, corn-and-cob meal, or hominy feed.
 200 " ground oats.
 100 " gluten feed.
 100 " wheat bran.

Among 13 rations recommended by Prof. F. W. Woll* the following are selected:

- (1) Hay 20 lbs., oats 3 lbs., corn-and-cob meal 3 lbs., linseed meal 2 lbs.
- (2) Hay 10 lbs., corn stalks free, wheat bran 3 lbs., corn meal 2 lbs., cottonseed meal 2 lbs.
- (3) Hay free, corn silage 30 lbs., oats 4 lbs., linseed meal 2 lbs., cottonseed meal 1 lb.
- (4) Alfalfa hay 20 lbs., oats 4 lbs., corn meal 2 lbs.
- (5) Corn silage 30 lbs., cottonseed hulls 12 lbs., cottonseed meal 3 lbs., bran 6 lbs.

Prof. C. H. Eckles, of Minnesota University, gives the following among "some good dairy rations:"†

- (1) Corn silage 25 lbs., clover hay 10 lbs., corn 4 lbs., wheat bran 4 lbs.
- (2) Corn silage 30 lbs., alfalfa or cow pea hay 10 lbs., corn 6 lbs., wheat bran 2 lbs.
- (3) Clover hay 20 lbs., corn 4-5 lbs., wheat bran or oats 2-4 lbs.
- (4) Clover hay 20 lbs., corn-and-cob meal 6 lbs., gluten or cottonseed meal 2 lbs.

Prof. C. Larsen, of South Dakota State College, recommends the following two rations:‡

- (1) When corn silage and alfalfa hay or clover hay are fed, then use a mixture of 25 per cent ground corn, 55 per cent ground oats, 20 per cent wheat bran. For large producing cows add two to four pounds linseed meal daily.

- (2) When cows are fed corn silage and prairie hay, or brome grass hay, or timothy hay for roughage, then the following basic grain ration is recommended.

Ground oats.....45 per cent	Wheat bran.....20 per cent
Ground barley or spelt 20 " "	Linseed meal.....15 " "

*Productive Feeding of Farm Animals, 1915.

†Dairy Cattle and Milk Production, 1911.

‡Farm Dairying, 1919.

Among the 15 rations given above, it will be noted are those suited to the far North, the Central West, the Western states, the South, and New England.

The feed for dry cows, as a rule, largely consists of silage or roughage. It is important, however, that they be in good condition at calving, in order to meet the drain of milk production. Farmers who sell milk or butter usually plan to have their cows freshen late in the fall, so that they may be milked during the period of higher prices, and also at a time when they can give more individual attention to live stock. Pasture, therefore, may be about the only feed the cow will receive on many farms. As the pastures get short, silage or legume hay should be fed, if possible, and enough grain given to put the cow in condition for freshening. In cases where official testing is conducted, dry cows are often fattened to fit them for record-making milk production.

Feeding cows on pasture requires careful oversight. When the green stuff is abundant, other feed may be unnecessary. As the grass gets short in July or August, it should be supplemented, if possible, with silage or with some soiling crop, such as corn, sorghum, clover, alfalfa, etc. Further, some grain is desirable when the pastures get short. The cows should be kept up in production as much as possible at this time, and a light grain feed will help. Experiments on feeding grain to cows on pasture were conducted at Cornell University for some years, when it appeared that the extra milk yield did not pay for the feed; but there was a secondary result from the feeding of the grain on pasture.* "It was found in the Cornell experiments that in the second year the cows that had received grain while on pasture the year before did better than those that received no grain.

"Prof. Roberts holds that the benefit of grain on pasture was an especially marked one in the development of the young stock. This combination of feed showed up in their

*Prof. E. S. Savage in *Holstein-Friesian World*, July 9, 1921.

greater production, greater size and stretch than those receiving no grain on pasture.”

Feeding the dairy bull. Many persons neglect the bull, and feed him very meager rations, so that he often looks thin and poorly fed. The bull should never be fat and in high condition, but he should look in good muscular form, full of vigor and ambition. He should have plenty of suitable hay and feed of concentrates in which protein is abundant. If he is at the head of a large herd and in service, then he should be fed about the same amount of nutrients as a dairy cow, otherwise less food is needed. From 5 to 10 pounds of grain a day may be fed, depending upon the size and work of the animal. Some persons object to silage for



Figure 137.—Dairy cows on pasture. Photograph by the author.

the bull, thinking that this food makes him sterile, and do not feed it, but in the author's experience it may be fed satisfactorily if in not too great an amount, as 10 or 12 pounds, for example. Prof. Larsen, however, states* that he has discontinued feeding silage to dairy bulls in service. Some succulent food, however, is desirable, and in summer green food may be fed, and in winter sliced roots in small quantity are recommended.

Exercise for health and vigor is a most desirable thing for the dairy bull. At the Ohio State University for

*Farm Dairying, 1919.

some years we have had a strong cable stretched between two high iron posts about 100 feet apart. A strong rope about 10 feet long is fastened at one end in the ring in the nose of the bull, while the other end is tied to an iron ring which slides on the cable. The bull thus fastened is given a fine opportunity for exercise and is yet under control. The University has also exercised a Jersey bull by harnessing him and hitching to a small wagon, driving him about with reins, and using him for hauling loads of moderate weight. Under most conditions, as a matter of safety to attendants, the bull should be dehorned.

Salt for dairy cattle is very necessary, and should be supplied with regularity. Some persons at regular intervals throw a quantity of salt in each manger. Many feeders, who study their feeding carefully, sprinkle the necessary amount of salt in the feed at regular times. Others have salt boxes in yards, where the cattle may lick it at will, or throw heaps on the ground where it will be eaten. According to our best authorities, a cow weighing 1,000 pounds should be fed from 1 to 3 ounces of salt a day, depending upon the amount of milk produced.

Water for the dairy cow. It can be readily seen that a cow producing a great amount of milk, say 100 pounds in a day, must require a large amount of water to supply her body needs. The amount of water necessary, however, depends largely on the kind of food eaten and the milk yield. If rich pasturage, a soiling feed, silage or roots are eaten, the demand for water will be comparatively light, while, if dry pasture or hay, especially a legume, is the main source of roughage, large amounts of water may be drunk. A warm temperature also adds to the demand for drink. Under fair conditions of production, probably 75 to 100 pounds of water daily will suffice. The Holstein-Friesian cow Missouri Chief Josephine at Missouri University, according to Prof. C. H. Eckles, on a seven-day test, averaged in excess

of 100 pounds of milk each day. She ate about 18 pounds of alfalfa hay, 10 pounds of silage and 14 to 20 pounds of grain, and drank from 216 to 307 pounds of water daily, or approximately from 27 to 38 gallons a day.

QUESTIONS LIKE THESE ARE OFTEN ASKED BY DAIRYMEN

1. What is meant by a feeding standard?
2. How long after birth should a calf be allowed to nurse its dam?
3. What is a good ration for a calf weighing about 200 pounds?
4. Is there a satisfactory substitute for milk for raising calves?
5. What is a good winter ration for a dairy heifer?
6. How much grain should be fed to the producing cow?
7. What per cent of the food goes into milk production?
8. Will you give a good ration for my dairy cow? I have plenty of silage and legume hay, cracked corn, oats, bran, gluten feed.
9. Under what conditions should dry cows be fed grain?
10. Does it pay to feed grain to cows on pasture?
11. How should a dairy bull be handled and fed?
12. How much salt should be fed?
13. What is the relationship of water consumption to milk production?

AMONG PEOPLE YOU KNOW KEEPING DAIRY CATTLE

14. Are balanced rations commonly used?
15. In what way and how long are the calves fed milk?
16. What form of roughage is fed the calves?
17. Can you secure two or three sample rations and exhibit them to your class?
18. Who feeds grain to cows on pasture?
19. How are the aged bulls exercised?
20. When and how are the cows salted?

CHAPTER XXVIII

SOMETHING ABOUT WOOL

Before taking up the study of sheep, it is desirable to first give some consideration to the subject of wool, in order that one may understand its relationship to sheep husbandry.

The commercial production of wool is a world-wide industry, with some countries giving it much more attention than others. According to estimates of the United States Department of Agriculture, the wool crop of the world for 1921 amounted to 2,608,445,000 pounds. Australasia, including Australia, New Zealand, and Tasmania, is the leading wool-producing part of the world, being credited with 798 million pounds. South America, more especially Argentina and Uruguay, produced in 1921 approximately 460 million pounds, while North America ranked third, producing about 250 million pounds. The only states in this country which in 1920 had over 2,000,000 sheep each of all ages were Texas, California, Idaho, Ohio, Montana, and Oregon in the order given. In past years the United States has under average conditions used in her mills about 550 million pounds of wool, of which about 250 million pounds have been produced in this country. Boston is the great wool market of America, and London of the United Kingdom of Great Britain.

A study of the structure of wool is very interesting. This fiber grows from the skin, and is similar in its origin and composition to other skin tissues, such as nails, horns and feathers. Wool grows from a gland known as the hair-follicle located in the dermis, or middle layer of skin. This follicle secretes a small amount of oil, and minute sebaceous

glands in the skin also give off wool fat. The wool fiber is made up of three distinct parts, an outer layer, or *epidermis*, consisting of flattened cells or scales which lap over each other much like the shingles on a roof; the *cortex*, which consists of cells more or less long from which the fiber gets its form and strength; and the *medulla*, or pith, at the center.

The *epidermis* of wool differs from that of common hair, because the scales project outward, giving a serrated appearance, while on hair the scales more nearly butt together and give a much smoother surface to the fiber. In the case of wool, the projecting edges of a mass of fibers, when brought together under certain conditions, lock or felt. It is this quality of felting which gives wool its special value for cloth making, a property not possessed by ordinary hair. These scales differ in size on different breeds of sheep; but, while very small, may be seen under a common microscope, especially if the fiber is first exposed a moment to boiling water, or to acid or alkali, which will cause the overlapping edges to open up still more. These scales

have a very hard, smooth surface, and are more or less translucent, so that the cortex below may be seen through them. The finer wools, such as Merino, have scales that are often smooth and straight along their edges, while the scales on the larger, coarser wools have serrated, more irregular edges. From the scales of the epidermal layer comes a quality known as *lustre* in the wool trade, which is highly valued. This is due to the unbroken reflection of light from the scales. When the scales are regular and uniform in their arrange-

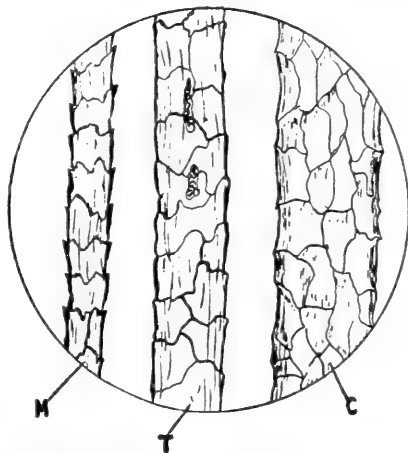

Figure 138.—Comparison of varieties of wool fibres. M—Merino, T—territory, C—coarse. Reproduced from "Textile Fibers," by Dr. J. M. Matthews.

ment are regular and uniform in their arrange-

ment, with their edges fitting closely together, the fiber will be smooth and lustrous, a quality especially noticeable in the long, coarse wools, like those of the Cotswold and Lincoln. The qualities of rigidity or pliability of wool are due to the scales. If they fit over each other loosely, with prominent projecting points, they felt most easily, and will be soft and pliable, while, if they fit close, with little overlapping, as in hair, they will have little or no felting quality and will be stiff and resistant.

The cortex of wool consists of a quantity of more or less long, straight cells, united to give the fiber its round form. From the cortex the fiber derives its tensile strength and elasticity. If the fiber is very fine, the cells of the cortex are more or less uneven in length and grouping, so that it takes on a wavy appearance or what is commonly termed *crimp*. This property is most marked with Merino wool, where we may find 25 crimps to the inch, while it is least seen in the long wools, where only 2 or 3 crimps usually occur. The degree of crimp adds much to the elasticity and spinning quality of the wool.

The medulla, or pith, of wool consists of round cells in the center of the cortex. Sometimes the medulla occupies from one fourth to one third of the diameter of the fiber, and again it may be barely present, or even not at all. Pigment, or coloring matter, is frequently found in this part, and is especially present in the medulla and cortex of colored wools. The medulla acts as a tube for transferring nutrition the length of the fiber, and also as a medium for introducing dyes and so artificially coloring the wool.

Some features of wool that are important in the trade should receive brief consideration here.

The fleece refers to the entire covering of wool on the sheep or the same removed and tied in a bundle in the wool warehouse. The fleece differs in its length and quality according to the part of the animal from which it comes. The

best and longest wool on the body is found over the shoulders and ribs. The back and neck wool also rank high. That on the belly is very fair, but short, while that on the thighs is the poorest.

The length of fiber varies from one and a half to eight or nine inches for a year's growth, the former for the fine or short wools, the latter for the coarse or long wools.

The fineness of fiber varies greatly, microscopical measure-

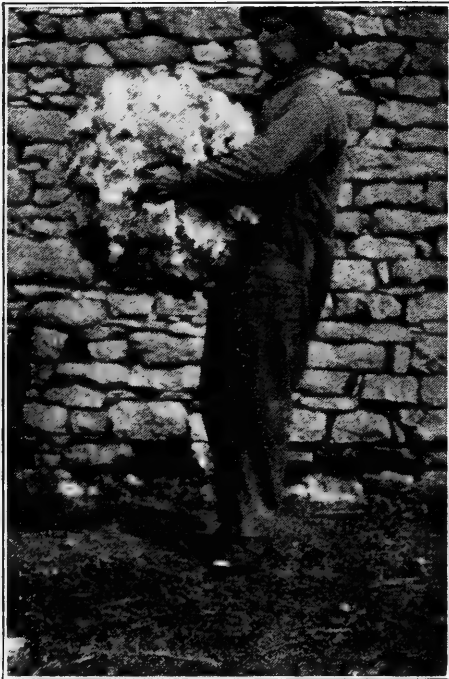

Figure 139.—A fleece of wool. Photograph by the author.

ments showing it to range from about $\frac{1}{1500}$ of an inch with the finest Merino, to $\frac{1}{600}$ of an inch with Cotswold or Lincoln. In the British and some other markets the fineness of wool is indicated by the number of times 560 yards, or "counts," can be spun from one pound of combed wool. A 70's count, which represents Merino wool, means that every pound of combed wool may be spun 70 times 560 or 39,200 yards.

The density of fleece alludes to the thickness of the wool fibers in a given space on the body, as, for example, a square inch. Naturally the finer the fiber the denser the fleece. In some Merino fleeces as many as 60,000 fibers grow on a square inch of the body. Fineness of fiber and density and weight of fleece are naturally associated.

Trueness of fiber refers to its uniform condition from its attachment to the skin to its tip. It must be uniform in diameter, without any swellings or contractions.

Soundness of fiber means that it will stand a very good tension without showing a weakness at any one place. Such a fiber must come from a healthy animal.

Unsoundness of fiber is manifested in two ways. In some cases of sickness or unfavorable conditions of feed or water, the fiber becomes "tender," and easily breaks when subjected to tension. Another form of unsoundness may occur from sickness, starvation, or change of feed, in the fiber's contracting, forming what has been termed a "break." This is easily seen by the eye, and it is not uncommon to find cases where a break shows clearly at one point through the fleece. Such a fiber is very defective, and easily breaks on tension.

A cotted fleece results when the wool on the sheep gets entangled in its own scales, and thus goes through a natural felting. This condition especially occurs when sheep are not in good health, and are packed close together in pens, so that the wool is placed under pressure. Cotting occurs more commonly with long-wool sheep than other breeds.

Kemp is a hard hair, found mostly on the head and thighs, that will not take a dye. It is commonly white, although there is dark colored kemp. A fleece that has much kemp is very inferior.

The yolk, or grease, of wool is the oil from the sebaceous glands which naturally works up the fiber toward the tip, where it takes on dust, so that the exterior of the entire fleece appears more or less dark and greasy, according to the kind of sheep. This yolk washes out to some extent in clear water, but in the woolen mills it is removed by a process of "scouring," that is, being washed in water containing alkali, which removes all the external grease. "The difference in loss of yolk," says Professor Hawkesworth,* "is great when you deal with an average clip of Merino, and one of an extra fatty nature. The former will lose about 20 to 25 per cent, and the latter 45 to 60 per cent (exclusive of dirt) when both are thoroughly cleaned." American Merino wool

*Australian Sheep and Wool, Alfred Hawkworth, 1906.

of the heavy sort frequently scours out 65 per cent. Wool buyers do not like to purchase fleeces heavily saturated with yolk on account of this loss. The yolk should be evenly distributed through the fleece, and preferably be of a light creamy or white color.

The grading of wool refers to the process of examining each fleece and assigning it a place with other wool of the same kind. After being removed from the sheep on the farm, the fleece in America is usually placed in large burlap sacks, holding from 200 to 400 pounds, according to the kind of fleece, Merino being the heaviest. These sacks are shipped to the wool warehouse, where they are opened by ripping the seam on one side, and the fleeces graded. A man usually stands at a small table, with a number of large baskets on wheels ranged before him. A helper takes the fleeces from the wool sack and places them on the table before the grader, who looks them over rapidly, and then throws each into a basket along with others of the same grade. The contents of each basket is placed in a separate pile with other wool of its kind, where it is left for examination by the buyer.

The market classification of wool. Commercial wool is graded into three great classes, namely:

- (1) *Clothing wool*, of short, fine staple;
- (2) *Combing wool*, somewhat coarser than clothing, and ranging from two to eight inches long, and
- (3) *Carpet and knitting wools*, which are coarse and long.

Clothing wools are short, being two inches or less in length, and are put through a carding process owing to their shortness. When thus handled the fibers lie interlaced in various directions. These wools are of fine grade, with considerable crimp, matting, and felting together. Combing wools usually are two and one half inches long, or more. In these the fibers are combed out parallel with one another preparatory to being spun into yarn. Carpet and knitting wools are of combing length, and are used in making the

coarser sorts of cloth. To make this subject somewhat clearer, the following is quoted from a well-known authority:*

“According to their length of staple, wool fibers are graded into two classes: tops and noils. The former includes the longer stapled fibers, which are combed and spun into worsted yarns, to be manufactured into trouserings, dress-goods, and such fabrics as are not fulled to any extent in the finishing. The latter class consists of the short-stapled fibers, which are carded and spun into woolen yarns to be used for weft and all classes of goods which are fulled more or less in the finishing operations, where a felting together of the fiber is desired. On comparing worsted and woolen yarns, it will be noticed that the former are fairly even in diameter, and the individual fibers lie more or less parallel to each other, whereas in woolen yarns the diameter is very uneven, and the fibers lie in all manner of directions.”

Wools are classified somewhat differently, according to the locality in which they are produced. Domestic wools refer to those of the eastern United States, especially Ohio, Pennsylvania, Michigan, New York, Wisconsin, Missouri, Kentucky, and other states producing similar wools. These are often termed the “fleece wool states.” Territory wools originally referred to all wools produced west of the Missouri river, but at present the territory wool states are Montana, Wyoming, Idaho, Washington, Nevada, Utah, and Colorado. The wools of Oregon, California, Arizona, New Mexico, and Texas are now classified separately from the territory grades. Domestic wools are commonly classified as follows:

Combing wools.

Delaine

Half-blood combing.

Three-eighths combing.

Quarter-blood combing.

Low quarter-blood combing.

Braid.

Clothing wools.

XX and X fine.

Half-blood clothing

Three-eighths clothing.

Quarter-blood clothing.

The grade XX comes from superior Merino blood of the wrinkly sort, while the X grade is slightly coarser. Delaine wools should usually be from two and one half to four inches long, are of superior quality, and naturally the product of smooth-bodied Merino sheep. The terms half-blood, three-eighths, and quarter-blood, originally were used to indicate that these grades were from sheep showing such percentages of Merino blood, but this distinction no longer applies, for

*The Textile Fibers. J. Merritt Matthews, 1908.

now much of our wool will grade within this classification and show no Merino blood. The use of the word "low" indicates a somewhat inferior quality of the grade next above it. Braid is the coarsest grade we have, and is the product of long-wool sheep, such as the Cotswold or Lincoln.

A scale of points for judging wool has recently been pro-

WOOL SCORE CARD

	Perfect Standard	Student's Grade
BREED..... Date.....		
GRADE..... Student's Name.....		
QUALITY OR FINENESS: Fine fiber, breed or grade considered. Not a mixture of fine and coarse fibers. Not a wide difference between shoulder and breech. Finer areas large; coarser ones small.....	20	
LENGTH: Should be clearly of combing length for the grade; that is fine, 2½ inches; ½ blood, 3 inches; ¾ blood, 3½ inches; ¼ blood, 4 inches. Lengths more than ½ inch greater of no additional value except in wool coarser than ¼ blood. Fibers that lie together, all the same length. Little variation over main parts of the fleece. A minimum of short wool.....	15	
SOUNDNESS: Strong throughout; no weak spots; fibers of uniform thickness from base to tip except for tapering of yearling fleeces.....	15	
PURITY: No hair, kemp, or black or dark brown fibers. Score heavily for beard hairs on wrinkles of fine woolled sheep, dark fibers mixed through the fleece of Downs, and coarse hair on the breech of cross-breeds.....	12	
CHARACTER: (a) Fiber, evenly crimped throughout, crimp close and distinct, fibers parallel except for sufficient binders to hold the fleece together. Tips free from wastiness. No frowzy wool.....	6	
(b) Soft and springy to touch; elastic under pressure	2	
COLOR: White, bright. Main fleece free from stains. Minimum of stained areas around breech and on belly.....	4	
CONDITION: (a) Yolk, moderate in quantity, light color, evenly distributed.....	3	
(b) Free as possible from naturally adhering sand and dust, and from heavy tags and sweat locks....	3	
(c) Free from burrs, chaff, seeds or other foreign matter, not mouldy or mothly; free from excessive paint, not tied with sisal or rough jute twine, or with excessive amounts of twine. Not cotted....	20	
Total points.....	100	

WEIGHT OF FLEECE. (Actual or estimated.....)
 SHRINKAGE. (Per cent estimated weight clean wool.....)
 FINAL SCORE. (Total score, times estimated weight of clean wool.....)
 ESTIMATED PRICE PER CLEAN POUND.....
 TOTAL VALUE OF FLEECE.....
 VALUE PER GREASE POUND.....

The above scale of points was prepared more especially for scoring commercial wool, of combing class, rather than wool of a breed, or of clothing or braid class.

posed by Professor C. I. Bray, of the Colorado Agricultural College.* In view of its excellence, and because it very appropriately follows the preceding discussion of wool, it is herewith reproduced.

The shearing of sheep is an important operation that requires skill and a good system of handling. Briefly described, the sheep is placed on its rump, the back resting more or less against the knees of the shearer. There are several methods used by skilled shearers to remove the fleece, of which the following is one. The shears are started in at the right front flank and the fleece is cut close to the body in a direct line to the hind flank. Then, by successive strokes, the wool is shorn over the belly, beginning at the brisket, and running the shears from the right side to the left, so that the wool here may be laid over like a blanket to the left side. Next the wool is removed from the hind legs, working from the right to left side, cutting it away about the thighs and just over the tail head, so that the sheep may rest on a shorn rump. In doing this part, the sheep should be placed in a reclining position, so that the end of the rump may be covered with the shears.

The sheep is then placed more erect, the shearer holding it by the jaw with the left hand, while cutting the fleece upward from the brisket along the lower right side of the neck to the end of the jaw. After the fleece is removed from the lower side of the neck and over the left front leg and shoulder, the shearer removes the fleece about the head, and then in successive strokes, beginning at the top of the neck, removes the fleece to the back of the neck, and then down, from the line between the two left flanks, he runs his shears around to the middle of the back, turning the sheep meanwhile as needs be. Having removed the fleece on the left half of the neck and body, the shearer starts at the top of the neck again, and continues down as before, but on

*Breeders' Gazette, October 13, 1921.

the right side, removing the fleece from the neck and body in proper order. If the job is well done, the shearer will take off his fleece, like a blanket, and spread it out as a connected whole, the inner part down, the locks together. The sides of the fleece are then turned in toward the center, and commencing with the head wool, the entire fleece is rolled up to make a neat bundle, which is tied together with standard wool twine, no more than is necessary, just two to four times around.



Figure 140.—Shearing with hand machines at the Ohio State University. Photograph by the author.

Some important rules in shearing must be followed, if the work is to be done right and superior wool placed on the market. The author will assume that the fleece is clean and free of dirt, chaff, and burrs.

(1) Shear on a level, smooth floor that may be kept clean.

(2) Cut the wool as close to the body as possible, using the shears but once in the same place. A second cut produces short fiber, which injures the selling value of the fleece.

(3) Never pull the wool or push it back with the left hand while shearing, as the skin is thus elevated and is quite likely to be cut.

(4) Use as little force as possible in handling the sheep. Some are nervous and struggle, and should be handled gently. If shearing is done in warm weather, see that a struggling sheep be not exhausted and overheated. It might better be freed, as it may die if the struggle is continued.

(5) Do not shear when the fleece is wet. In this condition it will mould and the fiber be weakened. Wet wool may also get stained if dung locks are present in the fleece.

(6) Use only standard wool twine, such as paper or hemp. Binding twine is a positive damage. Its vegetable fibers catch in the wool and can not be removed except by hand labor after they are woven in the cloth.

(7) Leave out all dung locks and coarse belly and britch wool from the fleece, selling this separately. Thus you establish a better reputation for your wool as a dependable product. In Australia the common practice is to skirt the wool, removing the inferior, coarser parts at the neck, legs, and sides, and selling these separately. This custom has given Australian wool its fine reputation.

SOME WOOLLY QUESTIONS

1. What are the leading wool-producing countries?
2. What is the felting property, and what is natural felting?
3. How does wool differ from common hair?
4. Can you explain the significance of the word "count"?
5. What is the relationship of soundness of fiber to its usefulness?
6. Why do wool buyers object to fleeces containing a large per cent of yolk?
7. What is meant by grading wool? How is it done?
8. How do combing and clothing wools differ?
9. What grades of combing wools are there? Can you give them?
10. What are some good rules to follow when shearing?

THINGS OF INTEREST TO DO WITH WOOL AND SHEEP

11. Examine some fiber of wool and hair under a microscope.
12. Note the difference in the character of the wool on one sheep.
13. Collect ounce samples of fleeces for comparison.
14. Make up a collection of market grades, and obtain their market prices per pound?
15. Report on the kind of shearing practiced in your neighborhood.
16. Try your hand at shearing and note the result.
17. Bring in samples of worsted and woolen cloth for class inspection.

CHAPTER XXIX

THE BREEDS OF SHEEP AND GOATS

The origin of the domestic sheep is generally believed to be from several kinds of wild sheep found in different parts of the world. One of these is found in the hilly or mountainous parts of Asia, and is known as the Argali. It is much larger than our domestic sheep, has big horns, and a coat of black or dark-red hair, below which is a covering of white wool. Another form, called the Musmon, is found at the present time on the islands of Sardinia and Corsica in the Mediterranean sea, where they have become more or less domesticated. Rocky Mountain Sheep are another sort living on the higher mountains of North America. Wild sheep have always been found in the elevated parts of Africa and eastern Asia. All these sheep have certain features in common.

Just how long sheep may have been subject to the control of man we do not know. Neither have we any definite information as to the wild family from which the domestic form originally came. It is probable, however, that sheep have been domesticated longer than any other farm animal. Bones of sheep have been found among the remains of the lake dwellers of Switzerland, a people who lived before the dawn of history. The very earliest writings, including the Bible, show man to have had large flocks of domestic sheep.

Three distinct classes or groups of sheep are recognized, depending largely upon the character of the fleece. These are fine or short, medium, and long or coarse wools. These classes are somewhat due to the sorting over of the fleeces by the wool merchant, who finds that each class serves a special purpose in his business. Another grouping is also

sometimes made, consisting of the fine-wool, or Merino, class and the mutton breeds. This last arrangement, however, is more commonly referred to by shepherds than by wool dealers. There are many different breeds of sheep, some of which are but little known in America, and the following are the only ones of importance in this country.

The Merino is a very old breed that had its important early development in Spain. Here for centuries the monks and wealthy people owned large flocks that were noted for their very fine wool. As long ago as the first century, the

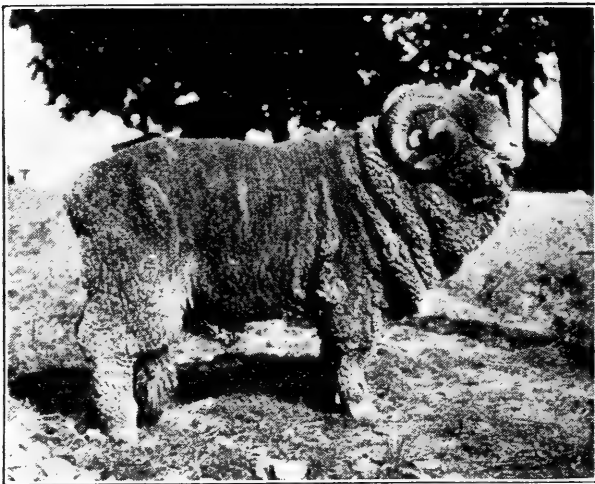

Figure 141.—Merino ram, "Shorty." Of B type. Photograph by the author.

sheep of Spain were famous, and the manufacture of wool into beautiful cloth was a great industry in that country in the thirteenth century. When the people of the other European countries learned of the fine wool that was

produced there, they sent to Spain and obtained some of the Spanish sheep. Specially selected flocks were taken to Germany and France in the latter part of the eighteenth century where they later met with much favor.

The first Merinos were brought to the United States in 1793. Three head were smuggled out of Spain by William Foster, of Boston. He gave them to a friend, who killed them for meat, not knowing how valuable they were, until he later paid \$1,000 for a ram of the same breed. Seth Adams of Massachusetts, later of Ohio, imported a pair in

1801, and in 1802 Colonel Humphreys, of Connecticut, brought to America nearly 100 head. These Humphrey sheep proved very valuable, and from them some of the best flocks in America started. Much interest followed these two importations. Soon other people began to import Merinos into the United States, and very high prices were paid for them. During 18 months ending in 1811, nearly 20,000 of these sheep were brought to this country. The people went wild over Merinos, as high as \$1,500 being paid for individual animals. As our country developed, the Merino became widely distributed and but few of any other kind were kept for many years. During this time our people cared but little for mutton, but high prices were paid for wool, for which the Merino was especially valued. These sheep grew greatly in popularity in all wool-producing countries, so that even to-day there are more sheep of this breed than any other, for immense flocks of pure-breds and grades are found in Australia, South America, and over much of the United States. The production of wool, however, is less profitable than formerly, so that shepherds are gradually changing to the mutton breeds or are giving up their flocks altogether.

Several different Merino families have been developed in America. They all had their origin in the sheep of Spanish breeding, but in the hands of certain men each gradually developed special features. In this way families of Merinos were established. For a great many years all sheep that had heavy folds over the body were known as Spanish Merinos. Later the people came to refer to sheep of this class that had been produced in America, as American or A-type Merinos. In time, a larger sheep, with few folds or none, developed, that produced a longer and somewhat coarser grade of wool especially suited for certain cloth manufacture. These became known as Delaine, or C-type Merinos. These sheep also produced a good grade of mutton. What are known as B-type Merinos show a moderate amount

of folds, especially at neck, breast, and hind quarters. Among the Delaines are some family branches of interest, though not widely bred, as, for example, the Dickinson and the Blacktop. Most of the Delaine improvement of importance has taken place in Ohio and western Pennsylvania.

Some of the most important features of the Merino may be considered here. These sheep produce the finest wool known, grading as XX, or X fine, or Delaine. It is so fine that over 1,500 fibers may be laid side by side within an inch space. The fleece covers the entire body, often coming down over the face to the nostrils, and covering the legs even to the toes. From sheep having folds or wrinkles over the body we should get the finest and shortest wool. The fewer folds over the body, as a rule, the larger the sheep and the longer and coarser the fleece. Average Merino wool is about $2\frac{1}{2}$ inches long.

On the outside of the fleece we usually find more or less grease or oil, or yolk, as it is called, mixed with dirt. This mixture easily washes out, even in cold water. The cloth manufacturer removes this by scouring. Some fleeces in this operation lose 75 per cent of their weight. Wool buyers do not like a very heavy amount of yolk, on account of this shrinkage when the wool is scoured. A common weight for a fleece is 8 or 10 pounds, but some fleeces have weighed over 40 pounds when taken from the sheep. Rams weigh at maturity 130 pounds or more, and ewes around 100 pounds. Those with folds weigh the least, while the smooth-bodied ones are larger. Merino sheep are very hardy and thrive on ordinary pasture. They run together in flocks much better than any other breed, and so are easily managed by shepherds and dogs when on great ranges or pastures. Large numbers of sheep that have Merino blood in them come into the markets, but really are of mutton parentage. They make excellent mutton, and are liked by butchers because they are neither too large nor too fat. More pure-

bred flocks are found to-day in Ohio than in any other state, although Pennsylvania, Michigan, West Virginia, Oregon, California, and Texas have many flocks. West of the Mississippi there are large numbers of grade Merinos on the range, and without doubt they will continue popular there as long as sheep husbandry is an important industry.

The Rambouillet sheep is a breed of Merinos that has been especially developed by the French Government. In 1786 King Louis XVI of France sent a Mr. Gilbert to Spain to bring back a selection of Merinos. These were brought to one of the royal farms about 40 miles west of Paris, at a

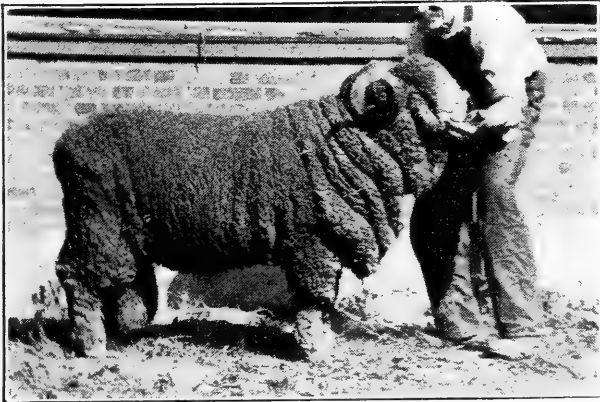

Figure 142.—Champion Rambouillet ram, 1920 Ohio State Fair. Photograph by the author.

town named Rambouillet. Here on this estate the government ever since has bred the descendants of these sheep. They were introduced into America in 1840, and for many years were

known as French Merinos. About 1890 the name Rambouillet came into use, and now the term French Merino is rarely used. These sheep have all the common features of the smooth-bodied Merino. It is the very largest family of this breed, however, and has been at times called the "Elephant Merino." The rams weigh about 185 pounds at maturity, though some have weighed over 250 pounds, and the ewes weigh around 150 pounds. This family is known as a mutton Merino, and the mutton *form* is an important feature. Thus one may expect a broad back and a thick leg of mutton in a good specimen of the Rambouillet.

There are two types of Rambouillet sheep, the B and C. The B type is marked with folds on neck, breast, front and rear flanks, and hind quarters, while the C type has a smooth body, with possibly one or two folds at the neck and breast. The C type represents what the more progressive Rambouillet breeders have had in mind in producing a dual-purpose sheep. The fleece of 12 months' growth should be about 3 inches long, and compact over the body, with but little yolk or dirt on the outside and grade as fine, fine-medium, or Delaine. Well-bred Rambouillet flocks shear about 10 or 12 pounds of wool per head. These sheep have grown in popularity in recent years, for they mature early, are hardy, and seem well suited to most parts of the United States where sheep husbandry thrives. On the western range and on the Pacific slope are found most of the very best and largest flocks in America. There are also numerous choice flocks in Ohio and other central western states. Rambouillet sheep have been bred to a considerable extent in northern Germany, and large numbers are now kept in South America, especially in Argentina.

The Southdown is one of the oldest breeds of sheep. Its native home is on the Southdown hills in Sussex county in southeast England. These hills are of white chalk, and are covered with soil on which grass and the small grains do very well. About 1780 a man named John Ellman, who lived in Sussex, began to improve the native sheep and kept at this work for over 50 years. Through his efforts the Southdown developed into the best mutton sheep known, having splendid vigor, fattening easily, maturing rapidly, and producing a carcass with but little waste at slaughter. While the fleece was not heavy, its quality was fine. Following Mr. Ellman came Jonas Webb, who lived about 60 miles north of London, on the estate of Babraham, near the city of Cambridge. He was also one of the great English breeders. His Southdowns had more size and were a still better

mutton sheep than were Ellman's. As a mutton sheep, the Southdown has occupied a most important place for a century or more, being still regarded the model sheep for that purpose. It has been used to help improve more breeds than any other. Southdowns were first imported into America about 1800, and since then many very excellent specimens of this breed have been imported to this country.

The Southdown has been noted for its short, neat head, which is more or less covered with wool down over the red-

dish-brown face. It has a short, thick neck, broad chest, wide back, thick meaty leg of mutton, and short red-brown legs. No other breed matures earlier, and it is not lacking in hardiness. Southdowns are well suited to grazing on the better class of pastures, but are not so good for the range and poor pastures as are some others. The flesh is very fine of

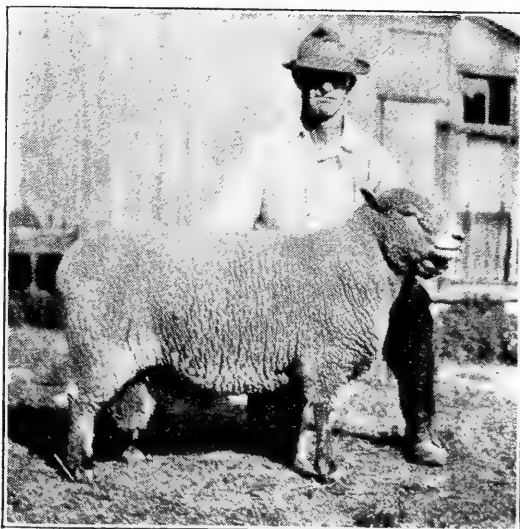

Figure 143.—Southdown ram bred by King George V of England. Owner Ohio State University. Photograph by the author.

grain and is not inclined to be overfat. Butchers especially admire this sheep because it kills out so well, with small amount of loss. The Southdowns, or sheep with more or less of Southdown blood, have won more prizes in fat-stock shows where the carcasses were considered than has any other breed. At our great International Live Stock Expositions, the Southdown has usually won the grand-championship in the dressed carcass exhibit. Mature rams weigh about 180 pounds, and the ewes 135 pounds. These sheep

have been criticised as being too small for the American farmer. The average fleece is short and light of weight, though of fine quality, often grading as three-eighths clothing, and this has also made the breed generally unpopular in America, although it is looked upon with much favor in Kentucky, Tennessee, and West Virginia. In spite of these criticisms, the breed commands universal respect, and many choice flocks of Southdowns are found all over the civilized world, especially among English-speaking people.

The Shropshire sheep originated from a number of different types native in and about the county of that name in

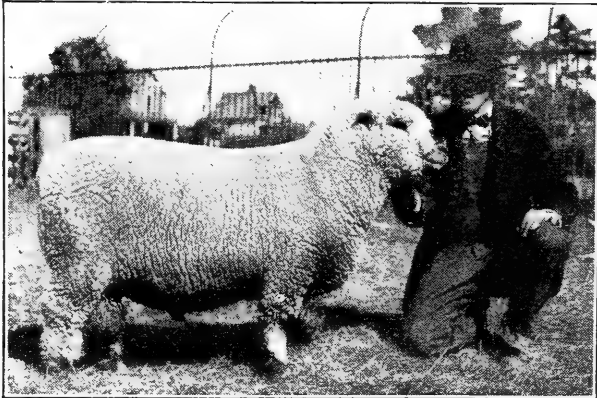

Figure 144.—Shropshire ram, 2nd prize, 1920 Ohio State Fair. Photograph by the author.

western England. This is a rather hilly region, with many fine pastures, and is well suited to these animals. A number of different men were interested in the improvement of the Shropshire,

prominent among whom were Messrs. Meire and Adney. Some of the early sheep were very coarse and had horns, and Mr. Meire worked to improve the quality, to get rid of the horns, and to develop a better mutton sheep. In this respect he succeeded. Shropshires became somewhat prominent in England about 1853, when they were first exhibited at the Royal Agricultural Society Show. About 1880 much attention was given the breed, and large exhibitions were made at English shows. These sheep were first imported into America in 1860, by Samuel Sutton, of Maryland. Twenty years later they were imported in larger

numbers, and since then, more especially in recent years, thousands have been brought to the United States, where this is the most popular of all the mutton breeds.

In size the Shropshire sheep is medium, the mature rams weighing about 225 pounds and the ewes about 160 pounds. The head often has a covering of wool, or "cap," down to the nose, which is covered with dark brown or nearly black hair. The back is broad, the leg of mutton very good, and the body is usually deep, showing good feeding capacity. The legs are dark brown in color like the face, and are covered with wool to the knees in front and to the ankles behind. The quality of mutton is most excellent, being second to the Southdown only. The fleece is usually about $3\frac{1}{2}$ inches long, in typical specimens grading as three-eighths, and is of very good quality. A twelve months' growth from fair specimens of the breed weighs about 9 or 10 pounds, and entire flocks have averaged even more.

The good combination of size of body and weight of fleece has done much to make this breed popular with American farmers, as a great general-purpose sheep. Furthermore, the Shropshire is our most prolific breed, many ewes having twin lambs. Flocks are very common all over the so-called corn belt of the United States, especially east of the Mississippi and in Canada. The American Shropshire Sheep Association is the largest organization of its kind in the world, and has done much to promote the breed.

The Oxford Down sheep comes from the county of Oxford, in south-central England. It is a beautiful rolling country, with good pastures, and where wheat and small grains thrive. This is one of our youngest breeds of sheep, and comes from a combination of Cotswold and Hampshire blood. About 1833 Samuel Druce began to breed these sheep, and finally produced one of the largest English mutton breeds. For a long time the wool, though abundant, was rather inferior, but the size and the mutton quality of the sheep made it

popular. A few of these sheep were brought to Delaware in 1846, and since then the Oxford Down has been much improved and has been gaining in popularity in America.

As stated, it is a large breed, the rams at maturity often weighing 275 pounds or more, and the ewes about 200 pounds. The color of the hair on the face, ears, and legs is a very dark brown, quite like the Shropshire. Oxfords are not so heavily woolled over the head, and often the face is rather free of wool, and the ears incline to be rather smooth and large. Typical specimens have quite wide backs, fairly good legs of mutton, and deep bodies. During recent years

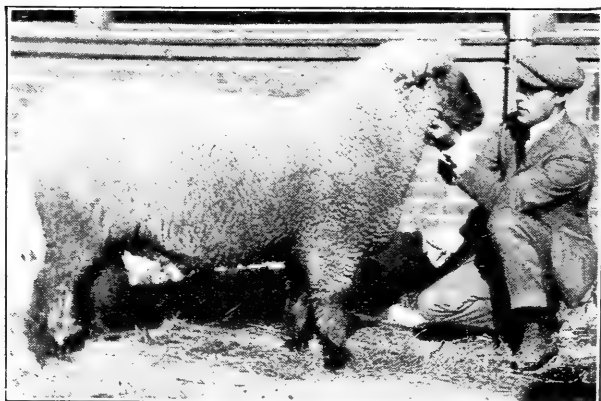

Figure 145.—Oxford Down ram, 2nd prize Ohio State Fair, 1920. Photograph by the author.

the breed has been much improved, the flesh growing finer in quality, and the fat being laid on more smoothly. The fleece, which frequently weighs 12 pounds, is longer, more open, and coarser than

that of the Shropshire and grades usually in most of the flocks of the country as quarter-blood combing.

This breed has made a favorable impression on farmers in the Middle West, where fairly early maturity, size, and heavy fleece are wanted. The ewes are quite prolific, and, though not equaling the Shropshires, make a very good showing. The Oxford may be regarded as one of the most promising breeds for future development. Recently flocks have been extensively distributed to many sheep-growing countries. There are more of these sheep on the fertile farms of Michigan, Wisconsin, Illinois, New York, and Ohio, than

elsewhere in America, for they are heavy feeders and require rich pastures or forage crops in order to do their best.

The Hampshire Down sheep, like the Southdown and Oxford Down breeds, originated in southern England and under much the same conditions of climate and soil. Their ancestors were of two kinds, one with white faces and horns, and the other with dark faces and horns. Southdown blood was mingled with these two, from which came the more improved Hampshire, without horns and with an almost black face, ears, and legs. William Humphrey was the most important early improver of these sheep, and, later, James



Figure 146.—Hampshire ewes on farm W. J. Cherry, Ohio. Photograph by the author.

Rawlence did much for them. The Hampshire is one of the largest breeds, mature rams often weighing over 250 pounds, and ewes nearly 200 pounds. The head is one of the striking features of the breed. The nostrils, lips, and face are quite black; the nose is very strong, or Roman in character; and the ears are dark, very large, and incline forward in a heavy style. Wool rarely extends much beyond the forehead. The body is large, and the form is of the usual mutton type. Hampshire sheep often seem somewhat coarse of bone and large of limb. The fleece, which grades as three-eighths or quarter-blood, is about 4 inches

long, inclines to be coarse and open, and usually does not shear much above 7 pounds with 12 months' growth.

Hampshires have long been popular for early or spring lambs, which are regarded as excellent quality. This breed of sheep has grown greatly in favor during the past few years, and large importations have been brought to the United States. On the western range lambs sired by Hampshire rams and out of ewes with some Merino blood are quite popular. Early lambs of this cross are also valued in the eastern market. This breed requires fertile pastures and plenty of feed in order to do well. Hampshires are widely distributed in North and South America, in Europe and Australia. In the United States, important flocks are kept in the northern states east of the Mississippi, especially in Pennsylvania, Kentucky, New York, and Michigan, and in the Rocky Mountain and Pacific coast states. Idaho leads.

The Dorset Horn sheep receives its name from the county of Dorset, in southern England, where it has long been bred. It is an improved form of two native, horned, white-faced breeds found in Dorset and Somerset counties. The modern Dorset Horn belongs to the middle-wool class, and is of medium to large size, rams weighing about 225 pounds and ewes 165. Both sexes have horns, those of the ram at maturity being large and having spiral turns, while those of the ewes are small, and bend in a simple curve around toward the face. The head, ears, and legs have a covering of white hair, and the nostrils are of flesh color. The neck is often short, the back wide, and the body of large capacity, with a fair leg of mutton. Dorsets are popular as lambs, and for mutton, although the quality of the mutton is not of the best. The lambs feed well and lay on flesh rapidly. As wool producers, this is a breed that should do better. The fleece, which grades as three-eighths or quarter-blood, tends to be short and the weight light, ranging around 6 pounds for average animals. These sheep were first

brought to America in 1885, and, while there are numerous flocks in the eastern states, more especially in Pennsylvania and New York, the breed as yet can hardly be called popular.

The Cheviot sheep comes from the Cheviot Hills in the border country between England and Scotland. Here the land rises into grass-topped mountains, reaching nearly 4,000



Figure 147.—A pen of Horned Dorset ewes, champions at a show of the Royal Agricultural Society of England. Photograph from *The National Stockman and Farmer*.

feet above the sea. Grass is the universal crop, and here this breed of sheep has been raised for long beyond a century, and gradually improved during the passing years. To-day the Cheviot is a medium-wool, fair-sized sheep, the rams weighing around 200 pounds at maturity, and the

ewes 150 pounds. This is one of our most beautiful breeds. The head is entirely free of wool, and the face and ears are covered with white hair, on which black specks occasionally occur. The nostrils are black, the nose tends to be a bit Roman, the eye is large and prominent, and the erect ear is usually pricked up as though listening. The Cheviot inclines to be somewhat narrow of back, with a moderate depth of body and fair leg of mutton, though in recent years it has been much improved. The fleece covers the body to the back of the ears and down to the knees and hocks, the

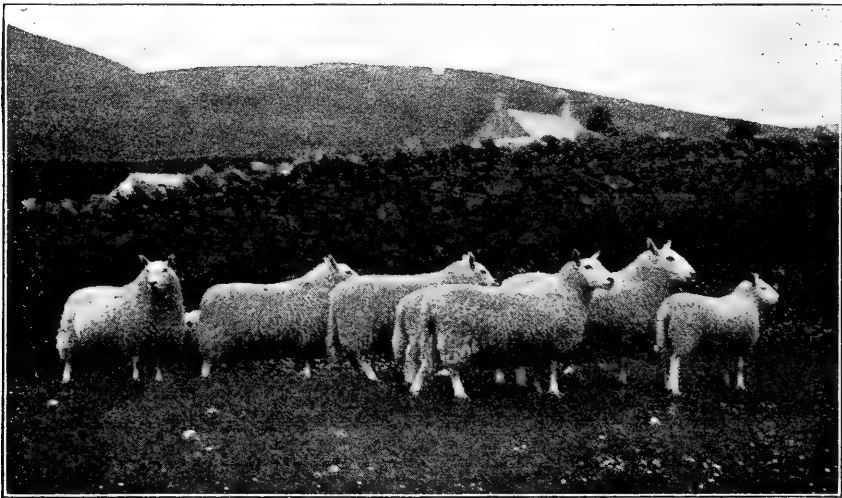

Figure 148.—Cheviot sheep on their native Scotch hills. Photograph by the author.

rest of the leg being covered with white hair. The fleece, which grades as three-eighths or quarter-blood combing, tends to be somewhat open and is usually about $3\frac{1}{2}$ inches long and a year's growth weighs 6 or 7 pounds. The fiber inclines to be coarser than that of the Shropshire, American breeders using the latter for a standard.

Cheviots are very hardy, and in their native home on the mountains rely altogether on grass the entire year. They are active and independent, and do not flock as do other

breeds. For this reason the Cheviot has never been suited to the range country. The quality of Cheviot mutton is very superior, having very fine grain, and lacking surplus fat. In mutton carcass contests in the English and Scotch shows, this breed and its cross-breeds have always held a high place. It is not widely distributed outside of its native home, though found in the United States in New York, Ohio, Illinois, Wisconsin, and in other states of the Middle West.

The Suffolk sheep comes from the county after which it is named, in southeastern England. It belongs to the medium-wool class, and is a mutton breed of distinct merit. In the carcass contests of the Smithfield Club Show in England, it has been a leading prize winner. The head, ears, and legs of the Suffolk are distinctly black in color, giving a group of these sheep a very striking appearance. Mature rams weigh about 250 pounds and the ewes 175 pounds. The fleece is not heavy. Suffolks are not extensively bred in England, although growing in popularity and but few of them are to be found in America. In fact, they are very rare here, and are not often seen at our sheep shows, neither have they been much advertised in America.

The Tunis sheep takes its name from Tunis, in northern Africa, where it is supposed to have originated. In 1799, General Eaton, United States Consul at Tunis, received a gift of a number of these sheep, two of which survived a voyage to America. Other importations followed this one of General Eaton. These early importations were kept in the eastern and southern states, and little was done to improve them. They are peculiar in having a large, fat tail, and have often been called "Fat Tailed Sheep." In recent years, especially since about 1893, they have been bred in small flocks, in different parts of the country, but especially in Indiana, Kentucky, and New York. They are of medium size, with brown, or mottled brown and white faces, and brown legs. The tail is cut off soon after birth, as with

other lambs, but the hind parts of the Tunis are somewhat heavier than corresponding parts of other breeds. The Tunis makes an excellent feeder, and lambs of this breed have met with much favor from stock buyers and the fattened lambs have sold for high prices on the market. The fleece is of excellent quality, of three-eighths grade, averaging about 3 inches long, and frequently containing red or brown fibers. But few of these sheep are to be seen, and fairs rarely make classes for them in the premium lists.

The Leicester sheep (pronounced Lester) originated in central England in the county of that name. Here Robert Bakewell, one of the most famous live-stock breeders in English history, developed and improved the native stock into the New Leicester. This was really the first improved breed of sheep known in England, and for a great many years it was extremely popular. Some of these sheep were brought to America, it is said, before the War of the

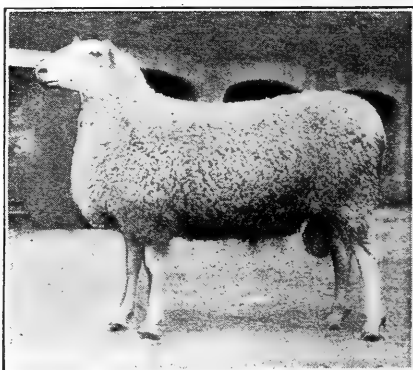

Figure 149.—Border Leicester ram.
Photograph by the author.

Revolution. In 1800, New Leicester sheep were known about Philadelphia. In the early part of the nineteenth century, many were imported and sold for high prices. This is a large breed, and belongs to the long, or coarse, wool class. The entire head and ears are covered with white hair, the wool not growing beyond the back of the head. The ears are large but thin, and are usually carried in an erect position. The nostrils are black, the nose is somewhat prominent, and the eye bold and attractive. The Leicester has a full, wide breast; broad, flat back; wide rump; and fair leg of mutton. The body form is broad rather than deep, and sometimes these sheep

appear long of leg. They fatten rapidly, and the rams at maturity weigh around 250 pounds, and the ewes 175 pounds or more. As mutton producers, they are not popular, because they lay on too much fat. They require good pastures, and are not the hardiest sheep in the world.

The Leicester is the smallest of the long-wool breeds, and has a curly fleece of low quarter-blood or braid grade that does not shear very heavily, 7 to 9 pounds being about a year's growth. These unfavorable criticisms account for there being so few of them to-day either in America or

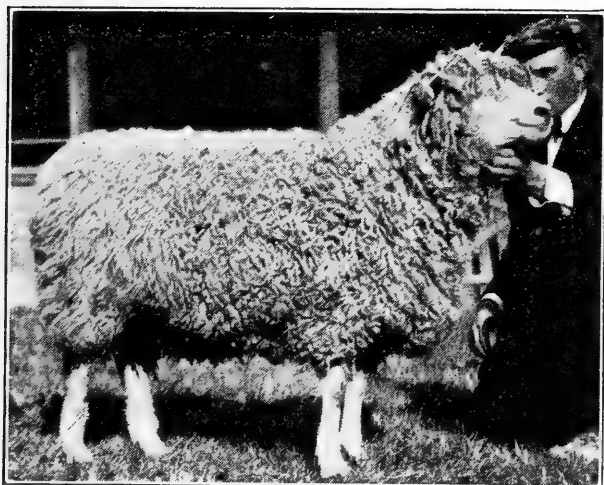

Figure 150.—Cotswold ewe, champion, 1916, Ohio State Fair. Photograph by the author.

elsewhere. Once a popular breed, this is now the least known in America of all the so-called common breeds of sheep. In northern England, in the border country, is an improved form or family known as the Border Leicester,

which is the more common type to-day. This differs from the English Leicester in having a more vigorous constitution, an especially lively carriage of head, and a clear white face, while the old breed has a bluish tinge to the skin of the face.

The Cotswold sheep gets its name from the fact that in early times in England these sheep were sheltered in what were called "Cots," and were pastured on the treeless hills known as "Wolds." That was in southwest England, where this breed has been kept for centuries. It is written that in 1464 King Edward IV gave permission to transport some

Cotswold sheep to Spain. About 100 years or more ago, Cotswold and Leicester flocks were mixed a great deal in blood, by which crossing it is said the former was improved. These sheep were brought to America as early as 1832, and once were very popular, especially in the states east of Illinois and north of Tennessee. This is a large, long-wooled breed, larger than the Leicester, mature rams weighing from 250 to 275 pounds, and ewes 200 to 225 pounds. The head is somewhat large, and is usually white, though it may be gray or brown in tint. The nose is rather prominent, and the ears incline to be large and are carried somewhat heavily. If the forehead of the Cotswold is protected, long curly locks of wool hang down in front, often hiding the eyes. Sheep of this breed have a broad breast, wide, flat back and broad rump, and show a greater width than depth of body in the best specimens. While the Cotswold feeds very well, if on good pasture and under favorable conditions, it is not a breed suited to scant pastures. The well-fattened carcass is too large, coarse, and fat for the present demand. The fleece, which grades as low quarter-blood or braid, is coarser and the curly locks larger than with the Leicester. Good Cotswold wool is noted for its lustre, a quality much valued by the English breeders. A twelve-months' fleece is usually from 8 to 10 inches long, and weighs about 10 pounds. There are not many Cotswold flocks in the United States, and the breed is more popular in Canada than here. The demand for a smaller sheep and a different grade of wool make it difficult for this breed to become popular in America.

The Lincoln sheep comes from the county of that name on the east coast of England. This is a very old breed, and its improvement began while Bakewell was developing the New Leicester. Some Lincoln sheep were brought to America before 1800, and they have been imported in a small way ever since. This is a large breed, being somewhat larger than the Cotswold, and having much in common with the

latter. The head is large, and is gray or white in color, or gray mixed with white. The wool does not cover the entire head, but a small tuft of short locks commonly extends over the forehead. The ears are large and usually have no wool on them. The body form is much like that of the Cotswold, though perhaps deeper of rib. These sheep fatten easily; but the carcasses get too heavy and have too much external fat for the present-day trade, and so the mutton is not popular. The Lincoln requires good grazing to do its best,

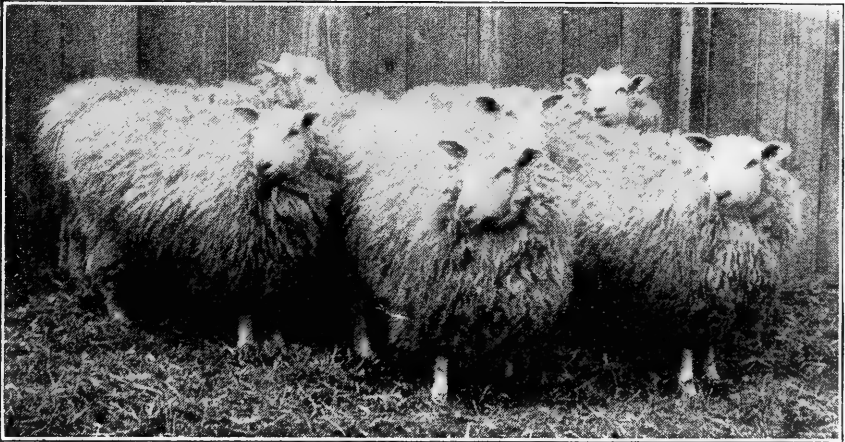

Figure 151. A group of Lincoln ewes owned by William Shier, of Michigan.
Photograph from the *American Sheep Breeder*.

as it is too heavy for the hill country. The Lincoln produces a fleece in long, wavy locks, which grades as low quarter-blood or braid, and which is not so curly but has the same lustre as the Cotswold. A year-old fleece is usually 8 inches long, and may weigh 10 pounds or more. Lincoln sheep have grown in popularity in their native home on account of the demand for them in Argentina, where large numbers are kept. Very high prices have been paid for them in England, and in 1906 a ram sold for \$7,400, the highest sum on record for the breed. In the United States, Lincolns have not gained in favor and there are very few of these sheep in this country, these being mostly in Idaho and Oregon.

The Romney Marsh sheep, also known as the Kent breed in its native home, originated in southeast England, in the county of Kent, on the marshes after which the breed is named. The land here is low, rich, and moist. These sheep seem especially suited to the local conditions, as they do not suffer from foot rot as do other breeds. The head and legs are white, the back is broad, and the body is of compact form. These sheep fatten very well on rather limited areas, and

make a fair grade of mutton. The fleece, which usually grades as a quarter-blood combing, weighs about 8 pounds, after a year's growth, and is in good demand. Large numbers of Romney Marsh sheep are now found in Argentina, and importations to



Figure 152.—Champion Romney Marsh ram. Owner Mr. A. Matthews, New Zealand. Photograph from *American Sheep Breeder*.

America have been made on a small scale. An association for promoting this breed was organized at Chicago in December, 1911. Since it is essentially an untried breed in America, its merits for our conditions remain to be shown. The Romney Marsh belongs to the middle-wool class, producing a fleece of low quarter-blood grade.

The Black-faced Highland sheep has long been known in the highlands of Scotland, where it grazes on the grass and heather on the highest mountains. In this breed, as in the Dorset, both sexes have horns, those of the ram being spiral and very large and showy at maturity. Highland

CAN YOU ANSWER THESE QUESTIONS?

1. When and where was the first boys' live-stock club started?
2. How many members of live-stock clubs were there in 1920 in the northern and western states?
3. What was Mr. Ward's ninth object in forming pig clubs?
4. How are boys' and girls' clubs organized and supervised?
5. What is the object of a club?
6. What is meant by standardizing club work?
7. Of whom should the membership of a county club committee consist?
8. What is the most popular form of club activities?
9. What form of prizes is most desirable?
10. How did club members help furnish food during the war?

SUGGESTIONS TO CLUB MEMBERS

11. Make a community or similar map, giving locations of club members.
12. If more than one club is in your township or county, ascertain which seems strongest in membership and the reason?
13. Ascertain what projects are being carried out in clubs in your vicinity.
14. Learn if standard clubs are more efficient than any others.
15. Compare rations fed by different boys and girls feeding the same kind of live stock.
16. Write a report for publication of what you saw on a club trip.

CHAPTER XXXVIII

CO-OPERATIVE LIVE-STOCK SHIPPERS' ASSOCIATIONS

The origin of co-operative live-stock shippers' associations has been generally credited to a community about Litchfield, in Meeker County, in south-central Minnesota, where it was organized in 1908. It has also been reported that this kind of an association was organized in Winnesheik County, Iowa, in 1892.* Wide-spread attention to the subject of co-operative shipping of live stock dates from about 1912, and was based upon the Minnesota work. Prof. W. H. Tomhave, then in Minnesota, who later removed to Pennsylvania State College, gave much publicity to this subject. In 1916 the United States Department of Agriculture published Farmer's Bulletin 718 on "Co-operative Live-Stock Shipping Associations," and this undoubtedly greatly promoted such organizations.

The plan of organizing co-operative shipping associations is comparatively simple. A group of men agree to co-operate in the marketing and selling of their live stock. A constitution and by-laws are framed to provide for officials to represent the management and to look after certain necessary details of organization. The constitution may briefly specify the name of the association, its business headquarters, purpose, and management. It also provides for membership, officers, elections, amendments, and quorum. The by-laws set forth the vital details of business management. The officers usually consist of a president, vice-president, secretary, treasurer, and a board of directors. The latter, as a rule, appoint a manager whose business it is to look after the marketing of the live stock. The following

*Harry R. O'Brien, *The Country Gentleman*, Nov. 15, 1919.

by-laws, with slight change, are the ones suggested in Farmer's Bulletin 718, and without doubt these have been widely adopted by most associations.

PROPOSED BY-LAWS FOR CO-OPERATIVE SHIPPING ASSOCIATIONS

Article I. Delivery for shipping. The shipment of stock in this association shall be made regardless of membership, and the delivery of stock to the manager and the acceptance thereof by him binds the shipper to the rules and by-laws of the association. All who desire to ship stock with the association shall report to the manager the kind of stock, the number of each kind, and the approximate weight of each, when it is ready to be marketed. When a sufficient amount of live stock has been reported to be ready for shipment to make a full car-load, the manager shall order a car for making the shipment, and shall notify each party having stock listed, and state at what time the stock is to be delivered for loading. In case of non-delivery of stock listed for shipment, the consignor should be assessed for the loss to the association, and in event of his not paying the same, should be debarred from all future privileges.

Article II. Section 1. Duties of the manager. The manager shall be at the yard on the day the shipment is to be made, unless he shall have secured a competent substitute, and shall receive all the stock, and weigh, mark and load the same on the car. He shall have charge of and direct the sale of all shipments, and receive all money therefor, and pay the same to the shippers, less his commission and all other expenses incurred in making the shipments, or when so directed send the money by mail to the shippers. He shall furnish a statement to every shipper, showing net weights, prices received, and expenses of shipment. He shall keep on file a complete statement of settlement, together with returns from the commission firm selling the live stock for the association or from the purchaser of the stock. In a book kept for that purpose, he shall keep a record showing the number of cars shipped, and the amount of stock in such cars, during the year. He shall also keep an account of all disbursements and receipts for the association. At the annual meeting he shall furnish a detailed statement of all business done during the year.

Section 2. Compensation of manager. The manager shall receive as compensation for his services the amount of cents per hundred pounds of stock sold by him, and no other compensation from the association, except that he shall have the right to charge for any outlay for materials needed in making partitions to separate the stock in the car and for bedding, said amount to be charged to the expense of the shipment for which it was incurred. In by-laws suggested by the Wisconsin University* we have the following on this subject: "The manager shall receive as compensation for his services (a) the sum of five cents a 100 pounds for cattle; seven cents a 100 pounds for hogs and ten cents a 100 pounds for sheep. Should there be two or more cars in said shipment, the rate on additional cars shall be three cents a 100 pounds for cattle, three and one-half cents a 100 pounds for hogs, five cents a 100 pounds for sheep, or (B) a flat rate of six or seven cents a 100 pounds on all classes of live stock; or (C) a certain amount on each car

*Bulletin 314. Wisconsin Live-Stock Shippers' Association, August, 1920.

(\$10.00 for the first car and \$5.00 for each additional car is conceded to be fair), or (D) an amount for each day, as \$6.00 for the time spent in taking in, loading or accompanying to market a shipment of livestock, and an amount, as \$4.00, for time spent in doing office work."

Section 3. Bond of manager. The manager shall furnish a satisfactory bond, which shall be approved by the board of directors. Said bond shall be for the faithful discharge of his duties.

Article III. Section I. Sinking fund. There shall be deducted on every 100 pounds of weight of sheep and hogs three cents, and for every 100 pounds of live weight of cattle two cents, and the same shall be placed in the sinking fund, to be used for the paying of losses that may occur to any stock from the time it comes into the hands of the manager until final disposition of same is made.

Section 2. Payment for losses. Any shipper whose stock has been damaged by injury while in the hands of the manager shall receive the full amount for the same as though the stock had not been injured, but shall be subject to the same ratio of expense on the shipment. The payment of the damage shall be based on a statement made by the commission firm having charge of the shipment, or by the purchaser of the stock, which statement shall show the amount received for the injured animal and the amount in their opinion, it would have brought had it not been injured. This statement shall be the final basis for settlement. No damage shall be paid for an animal which was not in healthy condition when received at the local yards by the manager.

Article IV. Section 1. Unhealthy stock. All stock which must be sold subject to inspection, except such as has been injured while in a healthy condition and in charge of the manager or any diseased animal, shall be received at the owner's risk, and he shall receive such payment therefor as is received by the commission firm less all expenses figured pro rata on the shipment.

Ohio Farm Bureau live-stock shipping associations are organized as incorporated companies, although transacting their business much in general as is done by independent local associations. In this method a member of a county farm bureau is allowed one share of stock free of expense, but persons not members of the local bureau, to become stockholders, must pay \$30.00. Persons not members of the farm bureau or of the shipping association pay a special sum, as, for example, 10 cents per 100 pounds, on all species of live stock marketed, which money is credited to the operating fund. The sinking fund, which is used to pay operating expenses, and for losses on live stock, is derived from such charges per 100 pounds live weight of cattle, hogs or sheep marketed, as the directors may determine. The managers do all the prorating, while in the independent associa-

tions it is done by commission firms or other salesmen. One great advantage in the Ohio method is that all the companies shipping under the farm bureau federation are assisted in time of trouble with transportation agencies, in securing important legislation, etc., by the state federation officials. Late in 1921 there were about fifty county associations in Ohio working under the farm bureau federation.

The manager of a co-operative live-stock shipping association is largely responsible for the success of the organization. He should be strictly honest, have good judgment in business matters, possess a rather intimate knowledge of the live-stock market, and should be a seasoned judge of animals and their market values. Further, in view of the jealousy and friction so likely to occur among a group of people mutually engaged in business, he should be tactful and gracious in his dealings with others, thus harmonizing interests and making friends for the association. It is also an asset to have a manager of attractive personality, something that is too often overlooked. The manager should visit the farms of members of the association, and, whenever desirable, offer suggestions that will result in improving the stock to be sold through the association. It will also be desirable for the manager to make occasional visits to the markets, that he may keep in touch with conditions there.

The marking of stock of shipping associations is necessary, for in many cases car loads are made up of shipments from more than one person. Each shipper should have a number or some character by which his stock may be marked and so easily identified. There are several methods of marking. An old European custom is to clip Roman numerals 4 inches or so long in the hair on the rumps of cattle. This marking is easily done with either straight or curved blade scissors. Metal ear tags, on which numbers are stenciled, may be used for cattle, hogs, and sheep; but these are not entirely satisfactory, for the reason that the numbers, being small, can

not always be easily read. Hogs are commonly marked with paint that is in striking contrast to the color of the animal. Stripes about an inch wide are made across the back with a common paint brush. A combination of different colors, with variations in arrangement and position on the animals, will allow for giving numerous lots of hogs marks by which they may be easily identified. "In many associations," ac-



Figure 212.—A method of marketing hogs. Note the marks on the back. Reproduced from Bulletin 314 of the Wisconsin Experiment Station.

ording to Farmer's Bulletin 718, "hogs are not marked, but those of each shipper are graded by the manager at the shipping point, and a record of sows, boars, and stags, subject to dockage is kept. In this case the hogs are pooled at the market and shrinkage is prorated on the basis of weight. As a matter of protection to the owners, however, the marking of hogs is strongly advocated; because, in case hogs of a certain mark show that they have been 'stuffed' before

delivery or that they have shrunk excessively or there is a discrepancy in dockage, proper adjustments can be made." Sheep are commonly marked with washable paint, rather than ordinary oil paint, which injures the wool, and can not be scoured out. Combinations of colors and marks on top of head or back may be used, such as will allow for identifying ownership of many animals.

Uniform grading of shipments of live stock is very desirable, if possible. It is quite customary for hogs of the same grade, even though shipped by several parties, to be sold together as one lot, and the settlement afterwards prorated. This method reduces extra labor of weighing different lots.

The sinking fund of the co-operative shipping association as set forth in the by-laws is for the purpose of paying for losses incurred while live stock is in the hands of the association. It is in the nature of an insurance fund. A common custom in creating this fund is to deduct two cents per 100 weight on cattle and 3 cents on hogs, sheep, and calves. There are exceptions to this plan, however, as, for example, a certain per cent of the proceeds of shipment may be charged, 2 per cent being a fair amount.

The expense of co-operative shipping varies with the local conditions, the distance from the market, and the section of country where transportation takes place. Figures compiled in Wisconsin* relating to seventy associations show home expenses, including manager's salary, labor, incidentals, and sinking fund contribution, to amount to \$25 per car; the freight expense averaged \$38 per car, while the terminal market charges show that for selling, commission, yardage, feed, and bedding, the average expense was \$30 per car, or a total of \$93. The Wisconsin authorities estimate the expense of marketing a car load of live stock of that state to range from \$50 to \$150 or from 2½ to 7½ per cent of the value of the live stock. The 1917 experience of 203 Minnesota associations showed the cost of central market expenses

*Bulletin 314, Wisconsin Agricultural Experiment Station.

and freight to be \$34.15 per car load, and home expenses \$16.50, a total per car of \$50.65.*

Original

**Live-Stock Shipping Association
Member's Statement**

_____ No. _____, 192_____

Account of _____ P. O. _____ R. F. D. _____

No.	Kind	Shrink Gain	Dock	Market weight	Price	Amount	Total
				Expenses	Rate	Amount	
				Hogs			
				Calves			
				Cattle			
				Sheep			
				Membership			
						Total	

Inclosed find check No. _____ for balance \$ _____

Please ask about anything not understood. Complete statement of each shipment is on file.

Manager _____

Figure 213.—Sample of Member's Statement in a live-stock shipper's association.

The advantages from selling live stock co-operatively are considerable. There is no expense for soliciting business, and the method does away with unnecessary stock buyers in a community, reducing the number to one paid employe. One of the main arguments in favor of co-operative marketing is the reduced cost of selling due to the fact that one person in a community represents the producers in this respect. Estimates from managers of 150 Wisconsin associations have

*Farmers' Co-operation in Minnesota 1913-17. Bulletin 184 Univ. of Minnesota.

placed the savings in shipping from 20 cents to \$2.50 per hundred weight, and from \$15 to \$250 a car. The great majority of estimates lie between \$50 and \$150 a car, and, on the basis of the lower figure, this estimate would indicate a saving of \$1,500,000 a year to the members of the 150 associations.* Mr. G. W. Hurlbert, of Iowa, in reporting on shipping associations in that state,† says it is estimated that in 1918 300 associations in Iowa shipped \$75,000,000 worth of live stock. "If," says Mr. Hurlbert, "the farmers saved only \$0.25 to \$0.85 per 100 pounds, the total saving would be around \$2,500,000. The total business of all the live-stock shipping associations for 1918 is estimated at \$500,000,000. That sum means that a total saving of about \$10,000,000 was made by the farmers of the country in that year by the co-operative shipping of live stock."

Another great advantage in co-operative shipping is the protective side of the sinking fund and reimbursement for animals that die or are injured enroute. Where under old conditions an animal might be nearly an entire loss to the shipper, by the co-operative method he is saved a large amount through the sinking fund.

Members of co-operative associations are usually in closer touch with the market, and thus more familiar with comparative values than non-members. They check up on the manager and show an interest in results from the sales of others as well as themselves.

A difficulty associated with co-operative marketing is holding the members together and supporting the organization. Prof. H. E. Erdman writes:§

"Not only do co-operators gain by collective sale, but non-co-operators as well usually obtain higher prices, since competitors are spurred on even to the extent, at times, of over-bidding. Here, in fact, is one of the biggest weaknesses of collective selling as well as of collective buying. It is very difficult to hold an association together for collective dealing when members see that non-members get as good rates as they, with no dues to pay. The real ques-

*Bulletin 314 Wisconsin Agr. Exp. Station.

†Hoard's Dairyman, December 5, 1919.

§Bulletin 342 Ohio Agr. Exp. Station. Organizations among Ohio Farmers.

tion, however, is not whether farm prices are higher than before the introduction of collective selling, but rather whether collective selling provides selling service at lower rates than similar services would be performed under competition. The answer is usually yes, provided such selling is efficiently done."

SUBJECTS FOR REVIEW

1. When the first live-stock shipping association was organized.
2. Conditions of delivery for shipping.
3. The duties of the manager.
4. The compensation of the manager.
5. Conditions under which losses are paid.
6. How the Ohio federation system differs from the independent one.
7. Methods of marking live stock for shipping.
8. The expense of co-operative shipping.
9. Financial savings from co-operation.
10. A weakness in the co-operative method.

SUGGESTIONS FOR INVESTIGATION

11. Compare the constitution and by-laws of different associations.
12. Visit one or more local associations and study their work.
13. Which is more satisfactory, settlements for losses through regular dealers or through association management?
14. What forms of marking are most popular locally?
15. Interview ten patrons and ascertain their experiences.
16. Is co-operative shipping growing in favor locally or not? Why?

CHAPTER XXXIX

TYPES AND BREEDS OF POULTRY

A classification of domestic poultry includes a number of different kinds, each consisting of a group with its types and breeds. The following is a classification commonly used.

- | | |
|-----------------------|---------------|
| 1. Fowls and chickens | 5. Pheasants. |
| 2. Turkeys. | 6. Ducks. |
| 3. Guineas. | 7. Geese. |
| 4. Peafowls. | 8. Swans. |

FOWLS

The types of domestic fowls may be classified into four groups, namely:

- | | |
|----------------|---------------------|
| 1. Egg-laying. | 3. General-purpose. |
| 2. Meat. | 4. Ornamental. |

For some time poultry students have discussed these types, but more especially three, which from a practical point of view are the only ones of interest to the farmer. These three are the laying, the meat, and the general-purpose fowls. Good examples of each of these types are common all over the country. The other three types are rarely raised on the farm, being the product of the fancier, who oftentimes has his poultry outfit on a town lot. The breeds are also sometimes divided into two classes, sitters and non-sitters, according to whether or not the hens have the desire to sit on and hatch a nest of eggs.

The egg-laying type of fowl, according to Prof. H. R. Lewis,* should show a well balanced, deep, nearly rectangular body, well developed in breast and abdomen. Great

*Judging Fowls for egg production. Hints to Poultrymen, vol. 8, No. 2. New Jersey Agricultural Experiment Station. 1919.

depth of body is especially desirable, but apparent depth must not be due to loose feathering, which is generally shown by an evidence of loose thigh feathers. Large capacity is essential, if a hen is to lay long and heavily. Such capacity is designated by a body that is deeper at the rear end of the keel than at the front end. The underline should be fairly straight and the back should be comparatively horizontal. Prominent breast development and evidence of a long keel are desirable qualities in a high-producing hen. The general body conformation of a heavy producer con-

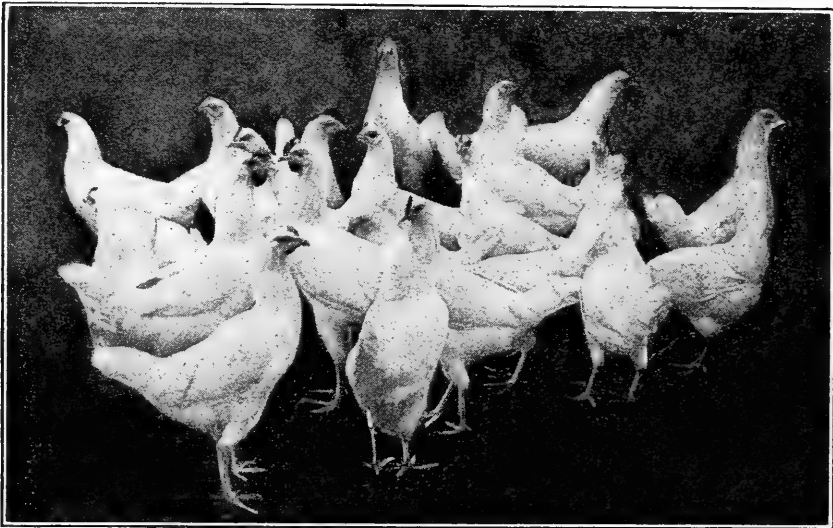

Figure 214.—The egg-laying type of fowl. Photograph from *Poultry Herald*.

forms very closely to a rectangle with pronounced angles rather than smooth curves. A male shows the same general characteristics as a female except that the abdomen is not so deep. Fowls of this type vary somewhat in size and weight as well as in flesh-producing capacity. The Leghorns are small, the hens weighing around 3 pounds, and do not produce much meat on the body, while the Minorcas are larger, the hens weighing about $6\frac{1}{2}$ pounds, and may carry a good amount of flesh when in best condition. The fowls

of this type are of European ancestry and are usually known among poultry specialists as the Mediterranean breeds.

The meat type of fowl is said to be comparable to the draft horse, beef cattle, mutton sheep, and the fat hog. It is squarely built, compact, thickly fleshed, wide of back and breast, and heavy of limb. Fowls of this type, when fat, have a carcass thickly covered with meat, and are especially valued for roasting. The hens, as a rule, are of sluggish disposition and are inferior egg-producers. The meat-type fowls sometimes weigh 10 to 12 pounds.

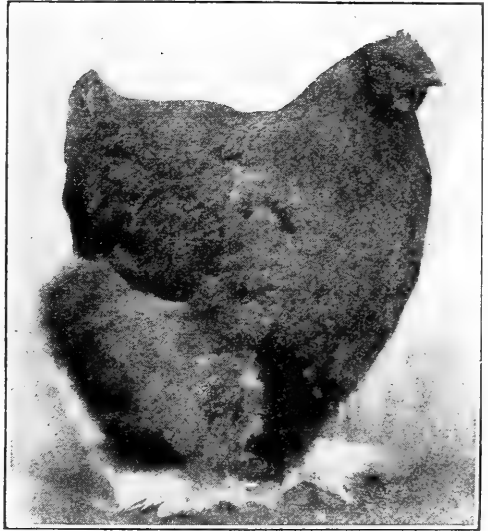

Figure 215.—Meat-type of fowl. Photograph from *Poultry Herald*.

They are of Asiatic origin, and are represented by the Brahma, Cochin, and Langshan breeds.

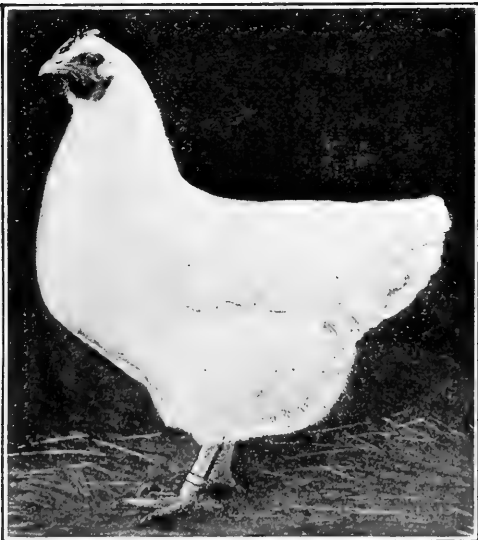

Figure 216.—General-purpose type. A White Plymouth Rock. Photograph from *Poultry Herald*.

The general-purpose type of fowl, as might be supposed, is valued for both egg and meat production. This type is medium in size, has considerable fullness of breast and width of back, and fattens to advantage. In egg production some general-purpose breeds have excellent records.

Standard weights vary, but 7 pounds for the hens and 9 for the cocks are satisfactory. Fowls of the general-purpose type, as a rule, belong to the American breeds, of which the Plymouth Rock, Wyandotte, and Rhode Island Red are the most common examples.

The breeds and varieties of fowls include a large number of wide difference, ranging from the tiny Bantam to the large and heavy Brahma. The breed characters of form, as applied to head, body, and legs, are rather distinct in each

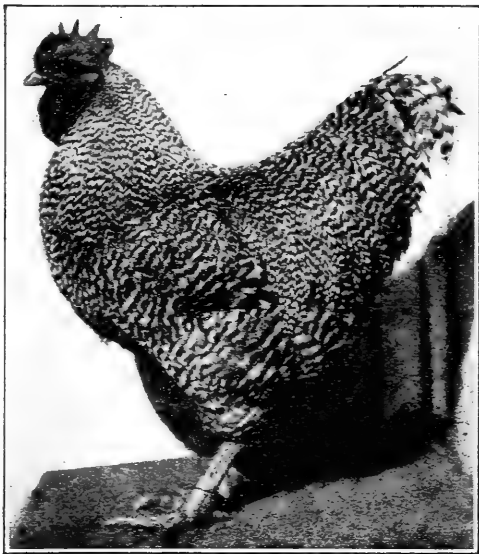

Figure 217.—Barred Plymouth Rock cockerel, 1st prize at Indianapolis. Photograph from *Poultry Herald*.

case. The variety characteristics are usually shown in color of feathers, though there may be other special features, such as single or rose comb. The Plymouth Rock, for example, includes six varieties; namely, (1) barred, (2) white, (3) buff, (4) silver penciled, (5) partridge, and (6) Columbian. The following very brief descriptions of some of the leading breeds in America, include the more important representatives of each.

The Plymouth Rock originated in America, and is of medium size. The head is surmounted by a single, upright red comb, and the ear lobes and wattles are also red. The neck is broad, breast full and wide, back broad, and body compact. Beak, legs, toes, and skin should be yellow in color. This breed is hardy and matures early, furnishing excellent broilers when eight to twelve weeks old. The hens are moderate layers, the eggs being of a brown color. This is a sitting breed, and the hens make excellent mothers.

The mature males weigh $9\frac{1}{2}$, and the females $7\frac{1}{2}$ pounds. Varieties of this breed differ only in color of feathers.

The Wyandotte originated in America, and is of medium size, with a form very similar to the Plymouth Rock. These two breeds look very much alike when fowls of the same color are compared. The Wyandotte, however, should have an outline of form somewhat shorter and deeper in its lines than the Plymouth Rock. This breed has a rose comb instead of a single form, and red ear lobes and wattles. The legs are yellow. Wyandottes are excellent layers, but their eggs are of small size, brown in color. These fowls are valued for broiling and roasting, for their flesh is of fine grain and quality. The mature males have a standard weight of $8\frac{1}{2}$ pounds and the females $6\frac{1}{2}$ pounds. Wyandottes are extremely popular.

The Rhode Island Red derives its name from the fact that it originated in the state of Rhode Island.

The American Standard of Perfection, in referring to these fowls, states that "their chief characteristics are: red color, oblong shape, compact form, and smooth surface plumage." This is a medium-sized breed, mature males weighing $8\frac{1}{2}$, and the females $6\frac{1}{2}$ pounds. The comb is either single or rose in form, and of medium size. The shank and feet should be yellow or reddish horn in color. This breed has become quite popular on account



Figure 218. White Wyandotte cockerel. First prize at Utica, N. Y. Photograph from *Poultry Success*.

of its merit as a table fowl and for egg production. The Rhode Island Red, however, is more or less criticized for lack of uniformity in plumage color and excessive broodiness during the spring season.

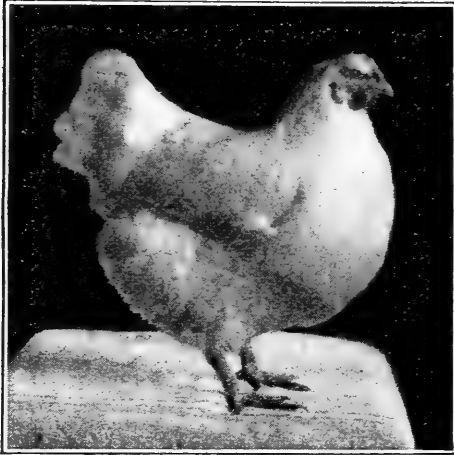

Figure 219.—White Orpington hen.
Photograph from *Poultry Herald*.

The Orpington was first developed in the town of Orpington, England, from which it receives its name. There is no great difference between this breed and the general-purpose American breeds, except that the Orpington is somewhat heavier, and has skin that

is white with a tendency to pink tint, and black or flesh-colored legs. The comb may be of the single or rose form. The ear lobes are red. There are three varieties, white, black, and buff. The mature males weigh 10 and the females 8 pounds. The Orpington in recent years has become very popular, ranking high for table use and for egg production. Hens of this variety tend to be unreasonably broody.

The Leghorn is a breed of European origin, getting its name



Figure 220.—A vigorous White Leghorn cock at Cornell University. Eleven of his daughters averaged 197 eggs each in a year. Photograph from Dr. O. B. Kent.

name from Leghorn, Italy. This is distinctly an egg-laying breed. The features of importance are large, single, or rose comb, the single comb on the hens drooping to one side. The head is small, the eye of good size, ear lobes white, comb and wattles red, and beak, legs, and skin yellow. The breast is prominent, though not very wide; the back of medium width and length, the feathers snugly laid to the body, and the tail carried at an angle of about 45 degrees. The Leghorn is very hardy and one of the most active breeds of fowl, rather small of size, and famous for egg production. The females are non-sitters. There are several varieties of Leghorns, of which the white, brown, and buff are most common. Mature males weigh about 4 pounds and females 3. This is one of the most common breeds kept on American farms; in fact, it is almost universally the one that is used especially for egg production on a large scale.



Figure 221.—Minorca cockerel. Photograph from *Poultry Herald*.

The Minorca is an egg-laying, non-sitting breed, originating on the island of Minorca in the Mediterranean sea. The following is quoted from the American Standard of Perfection: "They are distinguished by long bodies, very large combs, long full wattles, large white ear lobes, dark colored legs, and pinkish-white or flesh-colored skin. The Minorca head is carried rather high; the back is long and sloping; the tail is spread somewhat and only moderately elevated, being carried at an angle of 40 degrees from the horizontal. Their legs are firm, muscular, and set squarely under the long, powerful-looking bodies." There are both single and rose comb strains of this breed. Notable egg producers, the Minorcas rank as a close second to the

Leghorns and, furthermore, they are known as the breed producing the largest egg, which is white in color.

The Light Brahma is of Asiatic origin, and has been known in America for many years. It is strictly of the meat type, and is the largest breed of fowls, the mature males weighing 12 pounds and the females 9½ pounds. The head is of medium size, with a small pea comb, medium-sized red wattles, and large red ear lobes. The breast is very broad and full, the back wide, the legs, toes, and skin yellow, and the shanks feathered. The neck, tail, and large wing feathers are black, and white striped with black, the other feathers being white. This breed is valued for roasting, but does not rate high in egg production. There is another variety called the Dark Brahma, but neither of these varieties is longer popular, and but few flocks are now kept, although they once were common.

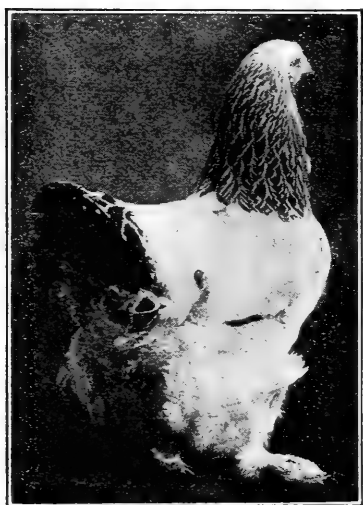

Figure 222.—Light Brahma hen, Lady V, first at Chicago. Photograph from *Poultry Herald*.

The Cochin is also an Asiatic breed, large in size, like the Brahma, a standard weight for males being 11 pounds and for females 9½ pounds. This is a deep-bodied, massive fowl, having a loose plumage with much downy fiber underneath, which gives the entire body a fluffy appearance. The legs are heavily feathered. These fowls are valued for roasters rather than for egg production. There are four varieties of Cochins, buff, black, white, and partridge.

The Langshan is a single-combed Asiatic breed, somewhat smaller and more active than the Brahma or Cochin, and much more popular, both for meat and for egg production. There are two varieties, the black and the white.

The males weigh $9\frac{1}{2}$ pounds and the females $7\frac{1}{2}$ pounds, at maturity. There is much fullness of breast, and the form is compact. The legs of the black variety are bluish colored, and slightly feathered. The comb, face, wattles, and ear lobes are bright red in color.

There are many other breeds and varieties of fowls, but these are usually kept only in a small way by poultry fanciers and do not need attention here.

The bantam may be a dwarf of some of the larger breeds or a distinct breed. Bantams are kept for ornamental purposes, and have no practical value. The weights naturally vary somewhat, but 26 ounces for mature males, and 22 ounces for the females are standards. The Cochin and Brahma bantams weigh slightly more, 30 ounces for the male and 26 for the female. The bantams make very interesting pets for children.

THE TURKEY

The turkey is a native of America and was unknown in Europe previous to 1624. The present domesticated turkey originated from the wild stock which once was found in large numbers in this country, and is yet found to a small extent in certain parts of Pennsylvania and the southern states. According to the Standard of Perfection of the American Poultry Association, the frame of the turkey should be large, the body deep, "with a broad, round, full breast that varies in prominence according to the variety." The head should be of good size, and the eyes bright and alert. The leg and shank bones should be large, straight, and well set. The carriage should be proud and erect. There are but few breeds of turkeys, and but one that may be regarded as common.

The Bronze turkey is very large, and the feathers are bronze or brown black, with shadings of color. The standard weight for an adult male is 36 pounds, and for the hen,

20 pounds. This is the most common variety raised.

The Narragansett turkey is of a metallic black color, with shadings to steel gray or approaching white. Mature cocks weigh about 30 pounds and hens 18 pounds.

The White Holland turkey, as its name indicates, has a white plumage. The beard of the male, however, is a deep black in color. Mature cocks weigh about 28 pounds and hens 18 pounds. This is not as hardy a variety as the

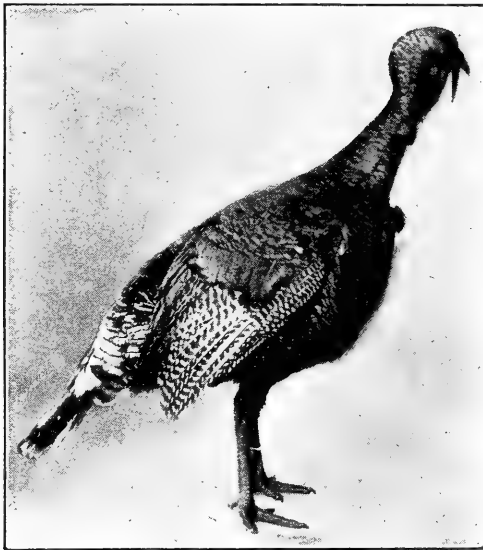

Figure 223.—A Bronze turkey. Photograph from *Poultry Herald*.

Bronze or Narragansett, but its flesh is highly regarded, and it is the most domestic and easily controlled of all the breeds.

The Bourbon Red turkey is a native of Bourbon county, Kentucky, and is supposed to have originated from what in early days in Kentucky was known as the wild yellow turkey. The neck, breast, back, body, and fluff of this breed are of a deep,

brownish red. It has about the same weight as the Narragansett, the males weighing about 30 pounds and the hens 18.

THE DUCK

The Mallard, or common wild duck, is regarded as the parent stock, or ancestor, of all domestic ducks. This duck has a broad flat bill, small eye, good-sized head, long neck, full breast, long body, short tail, and short web-footed legs. The body has a dense covering of downy feathers, over which lies the feathery plumage. The thick plumage, which is

characteristic of water fowl, is oiled by a natural secretion, which prevents water from penetrating among the feathers.

Three types of ducks are recognized, meat, egg-laying, and ornamental. Those which best supply the needs of the table for meat are most in demand.

The Pekin duck was brought to England from Pekin, China, in 1874. It is white in color and of large size, weighing 7 to 9 pounds, and is the most popular duck for table use. The bill is orange-yellow in color, while the shanks and toes are reddish orange. The Pekin duck may be re-

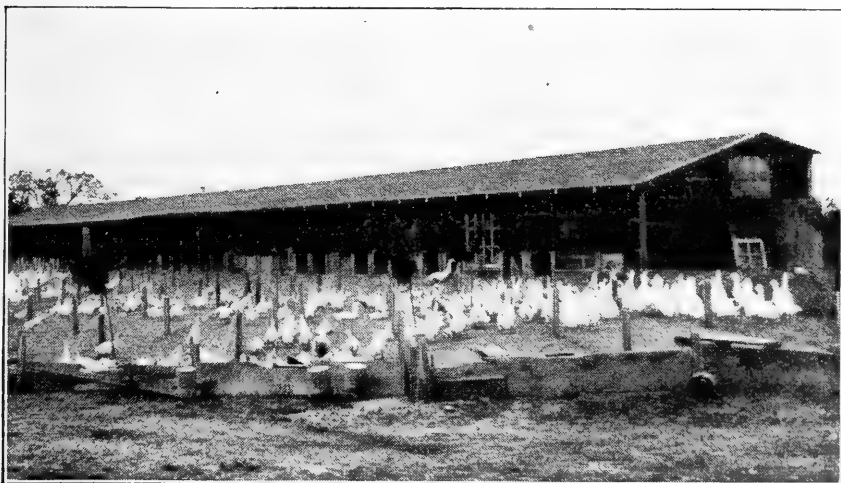

Figure 224.—Pekin ducks on a Rhode Island farm. Photograph by Chas. X. Arnold.

garded as the universal favorite where duck culture is conducted on a large scale in the United States.

The Aylesbury duck is white and much resembles the Pekin. The bill is flesh-colored, and the legs and feet are pale orange. The standard weight is the same as the Pekin. These ducks are more popular in England, where they have been bred many years, than they are in America.

The Rouen duck is a breed that takes its name from a city in northern France, where it has long been bred. It is grayish in color, with dark shadings or black on head, neck,

wings, and back. The bill is of greenish-yellow color, and the legs and feet orange with a green or brown shade.

The Cayuga duck originated in Cayuga County, New York. It is greenish-black in color, except some of the large wing feathers, which are brown. The bill is black, and the legs preferably black, though slate color occurs.

The Muscovy duck is a native of South America. In size it is very large, adult drakes weighing 10 pounds and females

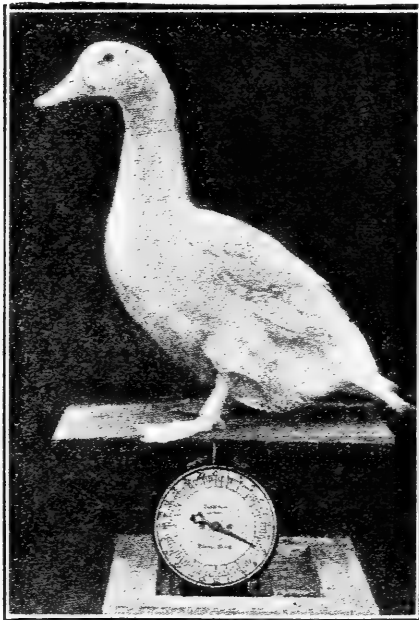

Figure 225. — A "rapid growth" Pekin Duck eight weeks old. Reproduced by courtesy Cyphers Incubator Company.

7 pounds. The body is long and broad, and is carried nearly horizontally. The head is rather long, and large with the male, and has large crest-like feathers, which the duck often raises when excited. The head is partly bare of feathers, and the sides and top above the bill have rough wart-like coverings known as caruncles, which are red of color and rather conspicuous. The bill is pink or flesh-colored. Colored Muscovies have yellow to dark lead-colored legs, while those of the white variety are yellow. The plumage

varies in color, but white or black-and-white are the favorite varieties. Ducks of this breed fly much more than others, and sometimes perch on elevated places.

The Indian Runner duck is supposed to have originated in India. It is rather small, a standard weight being about 4 pounds at maturity. The body, which is long and narrow, is carried somewhat erect, after the style of the wild penguin. The popular color is fawn or gray and white.

The claim is made that the young ducks at 6 weeks of age dress into broilers weighing $2\frac{1}{2}$ to 3 pounds. This duck, however, is valued chiefly for egg production, a female occasionally laying as many as 200 eggs in a year.

THE GOOSE

The domesticated breeds of geese have been developed from the wild breeds, but more especially the common Canadian wild goose, which is often domesticated and kept in confinement. So common is this wild goose in confinement that it is standardized in the American Poultry Association Standard of Perfection. It has a black head with white stripe, a gray body, and adults weigh from 10 to 12 pounds. There are several breeds of importance.

The Embden goose is of European origin. It is of medium size, adult ganders weighing about 20 pounds. The bill and legs are orange in color, and the plumage is white. This is a very popular breed.

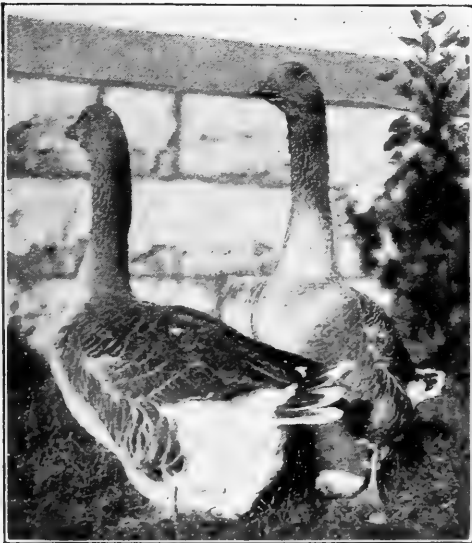

Figure 226.—Toulouse geese. Photograph from *Poultry Herald*.

The Toulouse goose gets its name from a city of that name in France. It is of large size, adults weighing about 25 pounds. The bill is pale orange and the legs a deep shade of that color. The plumage is gray, with dark shadings about the neck, back, wings, and breast.

Most of our domestic flocks of commercial importance consist of these two breeds.

SUGGESTIONS FOR REFLECTION

1. What makes the six types of domestic fowls?
2. Describe the egg-laying type of hen.
3. What is the difference between a breed and a variety?
4. Compare the Plymouth Rock and the Wyandotte.
5. Compare the Light Brahma and the Leghorn.
6. Name the place of origin of each of five breeds of fowls.
7. Discuss the origin of the turkey.
8. What are common features of different breeds of ducks?
9. Compare the Pekin and Rouen ducks.
10. What are some of the most striking characteristics of the Muscovy duck?

DO YOU THINK YOU COULD

11. Give the names of five men keeping pure-bred poultry in your neighborhood, and the breeds they keep?
12. Bring a small collection of eggs of different breeds to school?
13. Interest local poultrymen to arrange a small poultry show for the benefit of the school?
14. Weigh some specimens of live poultry of different breeds and report on the age and weight of each?
15. Bring to school specimens of feathers showing breed colors?

CHAPTER XL

JUDGING POULTRY AND POULTRY PRODUCTS

The poultry judge who understands his work must be familiar with many details. There is in this country an

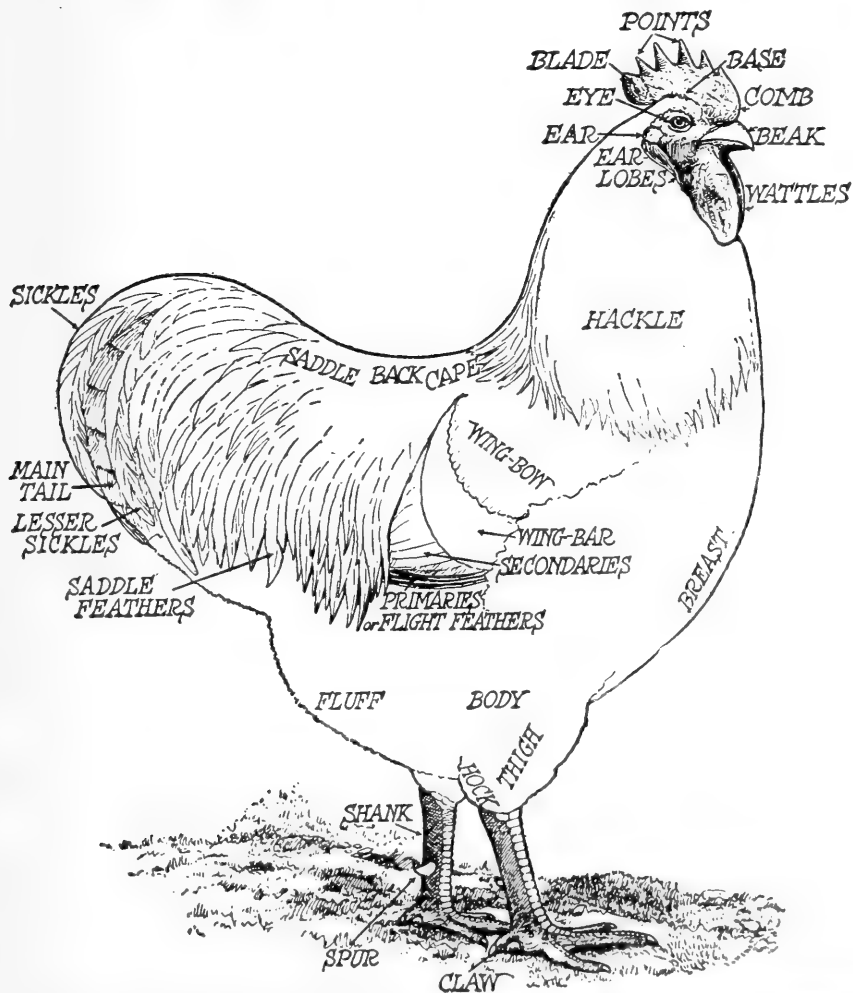

Figure 227.—Diagram of the exterior of the fowl. Reproduced from Farmer's Bulletin 806, United States Department of Agriculture.

organization known as the American Poultry Association. This devotes much attention to the establishment of stand-

ards of perfection for the various breeds and varieties of fowls, and provides rules and methods for judging fowls. A book published by the association, known as the "Standard of Perfection," is the American authority for judges and students to follow. No poultry show in which the breeds and varieties are exhibited could be properly conducted without the judge's being guided by this standard. No breed of fowls can be regarded as established until officially recognized and described by the American Poultry Association.



Figure 228.—White Leghorn cockerel showing single comb points. Photograph from Prof. F. S. Jacoby.

The parts of the fowl passed on by the judge have certain outlines, colors, and other markings as applied to each breed. The feathers differ in size and form in a striking way, according to their location on the body. The illustration of a male bird on page 473 shows, through a numbering system, the location of the parts and feathers.

The head of the fowl is one of the striking breed features. It is topped with a comb, which is larger on the cocks than on the hens. A very common form is single, upright or lopped, the top being serrated, or separated into points suggesting the teeth of a saw. Leghorn and Plymouth Rock varieties have this form. The rose comb is wide and low, consisting of many knobs crowded together, the rear part

tapering more or less to a smooth point. This comb occurs on Wyandottes, Minorcas, and other varieties. The pea comb is very small, and resembles three single combs dwarfed in size and crowded side by side, with the central one somewhat larger than the others. There are also V-shaped and strawberry combs, but these are not common. The ear lobes are usually small, and vary in color from red to white or bluish, according to breed. The wattles are usually red, and on the cock often hang below the bill in a conspicuous manner. The bill does not show the striking differences seen in the comb and wattles. Some breeds, like the Houdan and Polish, have crests, or clusters of feathers, which sometimes largely hide the head proper from view and also often affect the sight of the birds.



Figure 229.—A rose comb.



Figure 230.—Outstretched wing showing barred feathers of the Plymouth Rock. Photograph from Prof. F. S. Jacoby.

The feathers of the fowl differ in a remarkable way in size, form, and color. Even with varieties of one color, as, for example, white, the shades of this hue are made a subject of discussion by poultry experts. This difference also applies to other solid colors. In case of fowls having more than one color-marking to the feather, there are barred feathers, as with the Plymouth Rock; penciled feathers, as

with the Silver Penciled Wyandotte; laced feathers, as with the Golden Wyandotte; and still other markings, as striped, spangled, edged, etc. The color-markings of some birds are very beautiful. The correct color and form of the feather are of most interest to the fancier; yet the practical poultryman little interested in this feature has been able to secure his favorite breed through patient breeding, development, and improvement by the so-called fancier.

Methods of judging. The breeds and varieties of fowls are ordinarily judged by one of two methods, the score card or by comparison. In recent years utility classes have been exhibited at poultry shows, and this fact has introduced another phase of judging where egg production is an important factor. The score-card method of judging has been generally used at poultry shows for many years. Its use, however, is not so common now as formerly. Poultry judges using the score card put down the number of points or fraction of a point cut, and adding these, deduct from 100, which gives the total score. In cutting for defects from $\frac{1}{2}$ to 3 points are recommended for certain deficiencies, and these are specified in the standard for the benefit of official judges. Judging by comparison is becoming common, and is more satisfactory than by score card, for the reasons already given in Chapter XIII.

Instructions for judges of poultry include various points. Among these, weight receives considerable attention, and two points are usually deducted for each pound that the fowl falls short of the standard weight. Other things being equal, the one nearest standard weight is awarded the prize. To receive a first prize, a specimen must score 90 or more points, except cocks in parti-colored varieties, which are allowed 88 points as a minimum. When young and old birds are in competition, other things being equal, the older ones are to be awarded the prizes. Ties often result in judging. When a tie occurs, if it can not be broken by other rules, then the

specimen receiving the smallest total sum of cuts for *shape* shall be awarded the prize.

The official score card of the American Poultry Association is here given:

.....
(Name of association here)

.....
(Date, month, days and year show is held)

OFFICIAL SCORE CARD OF THE AMERICAN POULTRY ASSOCIATION

EXHIBITOR.....

VARIETY.....Sex.....

ENTRY No.....BAND No.....WEIGHT.....

	Shape	Color	Remarks.
Symmetry.....			
Weight or size.....			
Condition.....			
Comb.....			
Head.....			
Beak.....			
Eyes.....			
Wattles and ear lobes.....			
Neck.....			
Wings.....			
Back.....			
Tail.....			
Breast.....			
Body and fluff.....			
Legs and toes.....			
†Crest and beard.....			
*Shortness of feather.....			

Total cuts.....Score.....

.....JUDGE

.....SECRETARY

†Applies to crested breeds. *Applies to games and game bantams.

This score card is intended for use in connection with the Standard of Perfection, which contains a detailed description of each variety of fowl.

Disqualification in judging poultry is allowed for various reasons. The occurrence of feathers on the legs of what should be a smooth-legged breed; or of smooth legs when feathers should occur; irregular color of ear lobes and legs or of the plumage; web feet and excessive number of toes or too few toes; incorrect position of the comb, as, for example, lopping when it should be erect; absence of crest in crested varieties are examples of conditions which justify disqualification.

Judging fowls for utility has received special attention at poultry shows since about 1915. In the utility classes the birds are to be brought forward for show when at the height of egg production. This practice is not the case with ordinary exhibition birds, for they are shown just prior to beginning production, when in their finest plumage. Only standard-bred fowls are shown in each class, but in the utility group less consideration is given to plumage and more emphasis is paid to body form and evidence of egg production. A score card for utility judging was drawn up in November, 1919, at a conference of poultry specialists at Vineland, New Jersey, based on a careful study of 1,000 yearling hens in the International Egg-Laying Contest.

"In working out a production score card," writes Professor Harry R. Lewis*, the idea has not been to develop a score card which should be used in placing premiums at utility shows, but rather to develop numerical values for the various sections of the bird, in order that utility judges and exhibitors may have a common working basis, that is, in order that the exhibitor in picking his birds may have a more or less accurate idea of what the judge is going to look for in determining the relative values which he will give the various sections and qualities. In working out the numerical values for the score card the perfect bird was recognized as 100 per cent, which was allowed to be equivalent to a production of 300 eggs. Numerical values for all sections were then so arranged that each per cent of value is equivalent to three eggs or, put differently, a cut of one point in any one section is equivalent to a cut of three eggs."

The following score card for utility judging is based in principle on much of the work developed at the Cornell University judging school during 1918 and 1919.

*Judging fowls for egg production, Hints to Poultrymen—Vol. 8, No. 2, New Jersey Agricultural Experiment Station, 1919.

SCORE CARD FOR JUDGING UTILITY HENS AND PULLETS

Parts scored	Perfection	Egg production value
Body type (as seen in coop or on floor)	25 points	75
Head and adjuncts	15 "	45
Body conformation (as determined by handling)	30 "	90
Handling quality	10 "	30
Legs and toes	5 "	15
Condition	15 "	45
Total for perfection	100 "	300

The following discussion is given as explanatory of the application of the score card in utility judging.

BODY TYPE

Perfect Score—25 Points, 75 Eggs

A bird of good body is usually well-balanced in that the body itself must be deep, showing a nearly rectangular form, well developed in breast and abdomen. Great depth of body is especially desirable, but apparent depth must not be due to loose feathering, which is generally shown by an evidence of loose thigh feathers. Cochin and exhibition game type and feathering are usually associated with poor production. Large capacity is essential if a hen is to lay long and heavily. Such capacity is designated by a body that is deeper at the rear end of the keel than at the front end. The underline should be fairly straight and the back should be comparatively horizontal. Prominent breast development, with evidence of a long keel are desirable qualities in a high-producing hen. The general body conformation of a heavy producer conforms very closely to a rectangle with pronounced angles rather than smooth curves. A male shows the same general characteristics as a female except that the abdomen is not so deep.

A small-capacity hen generally stands erect. The body is either very shallow and cut away at the breast and abdomen or, in the case of beefy individuals, the abdomen shows a pronounced sagging at the rear of the keel due to large accumulations of fat. Extremely poor producers frequently show a hump on the back.

HEAD AND ADJUNCTS

Perfect Score—15 Points, 45 Eggs

One of the best indications in picking high layers is the fineness of the head. The head of the heavy producer is fine, showing a lean face, free from wrinkles and overhanging eyebrows. The wattles and ear lobes fit close to the head and are not loose and flabby. The face is clean cut, the eye is full, round and prominent, especially when seen from the front. An eye which gives a clean-cut wide-open appearance is desirable. The eyeball of the heavy producer is generally set in the rear of a large oval socket, showing considerable of the white eye membrane in front of the eyeball. The head of a heavy producer should be well balanced, being moderately deep and broad. The extremely fat, full head of the beefy bird and the long, thin pointed head of the low-vitality birds are both undesirable and should call for heavy cuts in this section. The low-producing bird generally shows a depressed eye with over-hanging

eyebrows and wrinkled skin at the back of the eye. The extremely long sharp beak is usually possessed by the low producer, while the medium stout, well-curved beak is characteristic of the high producer.

BODY CONFORMATION

Perfect Score—30 Points, 90 Eggs

When taken in the hands, a heavy producer will show, by the sense of touch, great depth of body, especially at the front and rear of the keel bone. The keel must be moderately straight, relatively long and carried well back. The space between the pelvic bones and the keel must be free from excessive accumulations of fat. Birds which are laying heavily can be readily detected by the development of the abdomen. Such birds will show pelvic arches which are widespread and a keel which is forced down away from the pelvic arches so as to give large capacity.

The poor producer generally shows a shallow body especially at the front of the keel, a small shrunken abdomen, together with all evidences of small capacity.

HANDLING QUALITY

Perfect Score—10 Points, 30 Eggs

The skin of the heavy-producing hen is thin, soft and pliable, especially the skin on the abdomen must be thin and loose. The skin of the poor producer is generally thick, hard and rather coarse to the touch. The thin velvety skin is almost always associated with heavy ovarian activity.

LEGS AND TOES

Perfect Score—5 Points, 15 Eggs

The shanks of a heavy producer are flat, pliable and smooth scaled. In hens at the end of their laying year, or pullets which have been laying heavily for some time, the shanks will be bleached out. The toes should be straight and the toenails show indication of proper activity. The shanks of the poor producer are usually round, hard and rather coarse scaled.

CONDITION

Perfect Score—15 Points, 45 Eggs

A bird to be capable of highest sustained production must be first of all healthy. She must show vigor and activity and be well fleshed. Late molting in hens is desirable. Early molting and slow maturing, as shown by the primary feathers, should be cut severely. Late developing and late maturing usually indicate low production. In applying this section to hens, health and molting conditions should be given primary consideration. In applying this section to pullets health and maturity should be given primary consideration.

Judging poultry products, such as dressed poultry and eggs, is becoming more and more necessary. The score card is not specially recommended for this purpose, the comparative method being very generally regarded as the most satisfactory. Referring to this point, one authority says:

Trimming the feet of sheep is frequently necessary, especially where the soil is soft and moist and free from gravel. Sheep that run on level, rich pasture, or that are kept more or less stabled, are troubled much in that the toes grow long or otherwise out of shape. The foot of the sheep is cloven, and the hoof consists of a comparatively thin upper shell and a soft under pad. With the small blade of a big, strong pocket knife one may easily trim the hoofs to a proper shape. If careful attention is given, it will require comparatively little labor to keep the feet in good



Figure 171.—Students trimming hoofs of sheep at Ohio State University.
Photograph by the author.

shape; but, if neglected, the hoofs may grow so out of shape as to give the feet a very bad posture, quite difficult to correct. Some breeds, as the Merino, are bad in this respect.

The docking of sheep, that is cutting off the tail of the young lamb, is a very important practice. It should be removed ten days or so after birth. A very satisfactory way is to cut the tail off with the large blade of a sharp pocket knife. The lamb may be held between the legs of the operator. With the left hand the tail is raised slightly above horizontal, while at the same time with the right hand the knife blade is laid against the bare underside about

an inch and a half from the body. Holding firmly to the lower part of the tail, which is then depressed, a quick upward stroke is given with the knife, which easily separates the tail, leaving it in the operator's hand. Occasionally a lamb may bleed quite a bit, but bleeding usually stops soon, and fatalities are not common. Bleeding may be stopped by tying a string tightly about the stump for an hour or so, or the wound may be seared with a red-hot iron. Lambs are also docked by other methods, as chopping off with a chisel, using a red-hot pincers, etc. The method described,

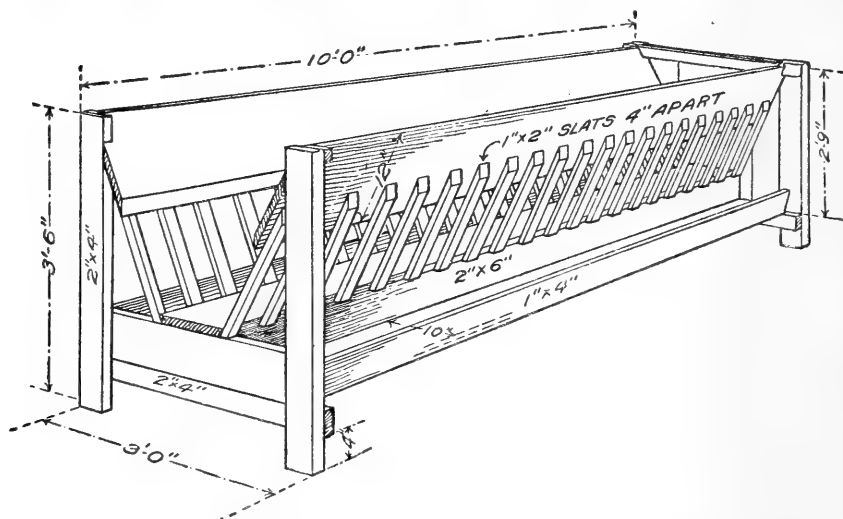

Figure 172.—A good feed rack for sheep. Reproduced from Farmers' Bulletin 810, United States Department of Agriculture.

however, is commonly used and is very satisfactory. The wound, after it stops bleeding, should have an antiseptic applied to it, and it should be watched to see that it heals rapidly. Tails are useless, they accumulate filth, and on the ewes interfere with breeding operations. Docked sheep are also more attractive than those with tails.

A hurdle for handling sheep is an adjustable or temporary fencing. Hurdles are universally used in Europe where sheep are grazed on forage crops or valuable pastures. Types of

hurdles differ according to the section of the country. In England one can see them made in woven sections, with strong sharpened stakes at intervals, so that an area of ground may be quickly enclosed for pasturing a flock. In the sheep pens hinged, two-section paneled hurdles are a great convenience for separating out individual sheep for special purposes. Also, when of sufficient length, hurdles may be used to divide yards or pens into smaller temporary quarters. Hurdles for use in the pens need not be over

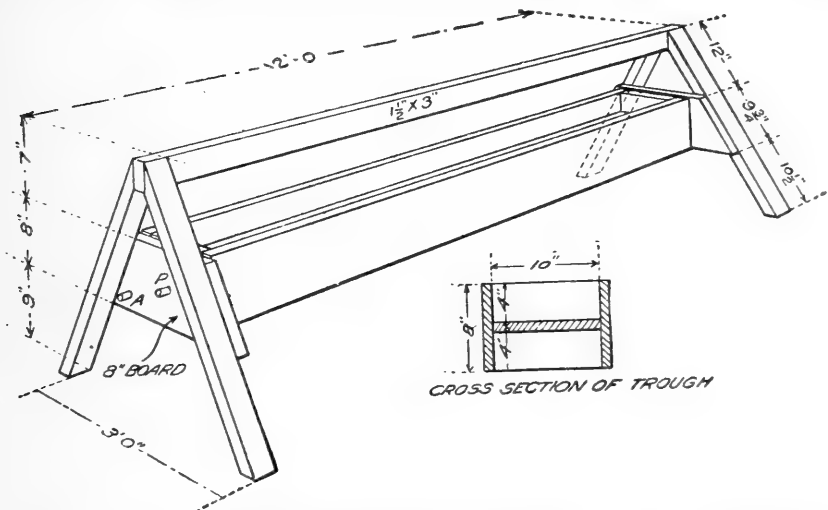

Figure 173.—A reversible movable grain trough for sheep. Reproduced from Farmers' Bulletin 810, United States Department of Agriculture.

thirty-six inches high, and should be constructed of light strips of lumber, preferably about four inches wide, and dressed down to seven eighths of an inch in thickness.

Feed racks for sheep should be so constructed that the seeds and chaff from hay or clover will not readily get into the fleece. They may have either a solid front, except a narrow space of 4 inches through which the sheep may gradually pull hay, or a slat face in its lower half, with solid board front in the upper part. A popular combination hay and grain rack may be like that on page 386, which is a V-form, fitting into the center of a wide feed trough, with 4-inch strips

along the front to keep the grain from being spilled. Movable grain troughs are used, these being 8 or 10 inches wide, with 4-inch sidepieces, and either fastened along the sides of the pens, or with strong legs by which the trough is elevated 12 or 14 inches above the floor. Feed troughs should be cleaned out daily, and frequently washed or scalded, that they may be sweet and clean.

THINGS WORTH REMEMBERING ABOUT SHEEP MANAGEMENT

1. How to separate sexes and ages for special attention.
2. When to ear tag a lamb.
3. What to record in the private flock book.
4. The amount of space to be allowed each sheep in shelter.
5. What dip should be used, and with what per cent of solution.
6. How stomach worms develop.
7. A good system of overcoming stomach worms.
8. How to keep the feet in good order.
9. When and how to dock the lamb.
10. A method of keeping the wool free of chaff.

THINGS WORTH NOTING IN THE NEIGHBORS' FLOCKS

11. How are the flocks adjusted to the size of the farms?
12. Are pure-bred or scrub sires used?
13. What methods of marking are used?
14. Whether private flock books are used?
15. What arrangements are provided for dipping?
16. Do flocks suffer from stomach worms? If so, what is done to prevent their occurrence?
17. Is docking general, and how is it performed?
18. What forms of feed racks and troughs are used?

CHAPTER XXXIII

THE BREEDS OF SWINE

The wild hog, or wild boar, as it is usually called, of which there are different forms, is found in widely separated parts of the world. The common wild boar from which the improved breeds of to-day are descended has been known in Europe since early historical times. This boar was common in England until the time of Henry II, about 1250. Boar hunting was a favorite pastime not only with the Romans,

but even in the present day, in sections of Germany and eastern Europe, wild boars furnish royal sport. In India these animals are hunted extensively by men on horseback, in a sport called "pig sticking." The wild hog is larger than the domestic one,

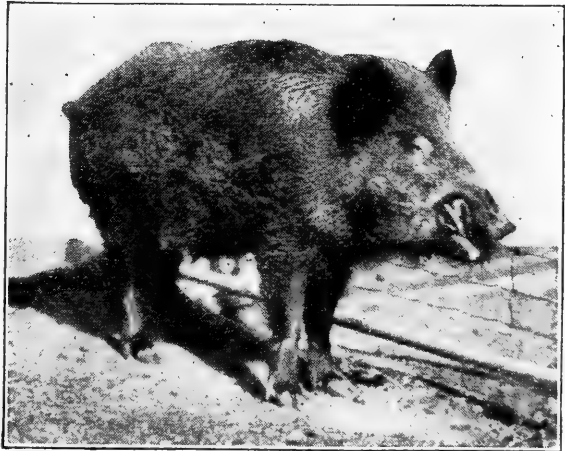

Figure 174.—The Wild Boar. From photograph of boar at Iowa Experiment Station.

and is very swift and strong. It is grayish-black in color. The rough skin is covered with short, woolly hair, over which are laid stiff, coarse bristles, especially along the spine. When the boar is angry or excited, these bristles usually stand erect. The head is rather large, long, and rough, and the older animals have short, heavy tusks that curve backward and away from the snout, and which are used in fighting. The wild hog is native to marshy forests.

The early forms of the domestic hog were found in several countries, but more especially in Great Britain, southern Europe, and China. Large herds of swine, according to Youatt, were in existence in England prior to the Christian era. It is said that in Greece large droves were cared for by swineherds perhaps 3,000 years ago. In Italy these animals have long been valued, and the blue-skinned, thin-haired, long-legged Neapolitan hog of that country was imported into England perhaps two centuries ago to improve the Berkshire and the coarse white hogs of Great Britain. The Chinese produced a class of white pigs that American and British sailors bought on their travels and brought home, which were used to improve the native stock. Red hogs bred on the west coast of Africa were also brought to America over a century ago, and their blood mingled with our common stock. From this ancestry, after long years of careful breeding, in Great Britain and the United States, have come our present highly improved domestic breeds of swine, of which the following are of interest.

The Berkshire hog is a native of England, and receives its name because of its early development in the shire of Berks. This is a region of mild temperature in south-central England, well suited to live stock. The Berkshire was known as a breed late in the eighteenth century. Then it was black, or reddish-brown in color with black or light spots, and had large ears hanging down in front. It was small-boned and fattened easily for those times, and frequently weighed over a thousand pounds. It was improved by the use of Neapolitan and Chinese blood in particular. In the middle of the nineteenth century, when it was regarded the best breed in England, the Berkshire was still reddish or sandy-colored, with more or less black spots, but was not so large and coarse as those of the previous century. In the early days, Richard Astley and Lord Barrington did much to improve the Berkshire. This hog was first brought

to America in 1823 by an English farmer who lived in New Jersey. Soon after others were imported, and during the latter half of the nineteenth century many Berkshires were brought to America. In recent years, however, but few of these pigs have been imported to this country.

The following are some of the most important features of the Berkshire to-day. The color is black, with more or less white on the face, feet, and tail. When all four legs, the face, and tail are marked thus, they are termed the "six points." The head is fairly short, the nose slightly

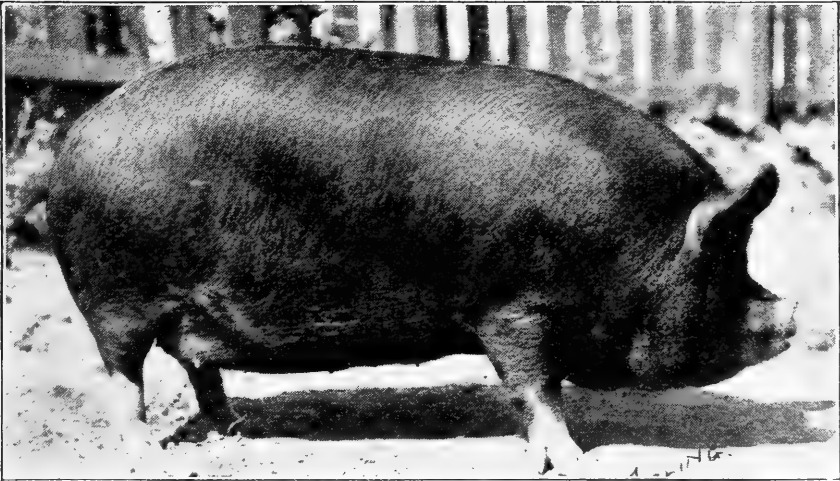

Figure 175.—A fine type of Berkshire sow, champion at Ohio State Fair.
Photograph by J. C. Allen.

curved up or the head "dish-faced," as it is termed, and the ears are erect, pointing slightly forward. The head of the Berkshire is one of its most distinctive breed features. In size this may be classed as medium, although there are individuals of superior breeding that attain a large size. Boars often weigh 500 pounds and sows about 400. There has, nevertheless, been a feeling among corn-belt pork producers that the Berkshire lacks in size, and this has affected its popularity in face of the present-day demand for big-type hogs. The Berkshire should have a strong and fairly

wide back, but it lacks the spring of rib of the Poland-China or Chester White, and neither does it have the high arch as often seen with representatives of some other breeds. The average Berkshire ham is not so round and thick as with the more distinct lard-type hog, being narrow rather than thick in the hind quarter. Good examples of the breed are neat of bone and stand well on their feet. The sows farrow medium-sized litters, averaging about eight pigs.

Berkshires are fair feeders, and mature just moderately well under ordinary conditions. If not fed too much corn, they make a grade of pork that is unsurpassed. In the corn belt of America, with the feed and care given by western farmers, the Berkshire may be regarded as a lard hog; while, if fed a variety of grain, with corn only a moderate part of the ration, it makes a superior bacon. It has always been a popular breed in England, and for many years held a premier position in America, but recently it has lost much of its popularity in the great pork-producing sections of the country, due to lack of size and a tendency to slow maturity. Berkshires have their greatest hold to-day in the eastern United States and the South. In spite of its loss in prestige, the breed is noted for its very superior pork, and in carcass contests at the International Live Stock Exposition, and at the Smithfield Show in England, it has an unsurpassed record for winning championships.

The Poland-China is an American breed of swine that originated in southwestern Ohio in Butler and Warren counties. This is a rolling country, and produces extensive fields of corn, wheat, and grass. There is no better region in America in which to raise hogs. In that section the early settlers kept large numbers of hogs, fed off their corn, and drove the hogs overland to the Cincinnati market. Different so-called breeds came into Ohio, including the Russian, Byfield, Big China, Irish Grazier, and Berkshire, the latter being taken to the state in 1835. From this mixture, in

time came the Poland-China. At first this was a big, coarse, spotted hog, which was rated as a good feeder. The coarseness was gradually reduced, no doubt the Berkshire blood bringing a very great improvement.

The prominent early breeders of the Poland-China were the Shakers and other farmers in Warren county. John Harkrader did much to improve them, and following him D. M. Magie, of Butler county, no doubt did much for the breed. Pigs of his breeding were widely known at one time

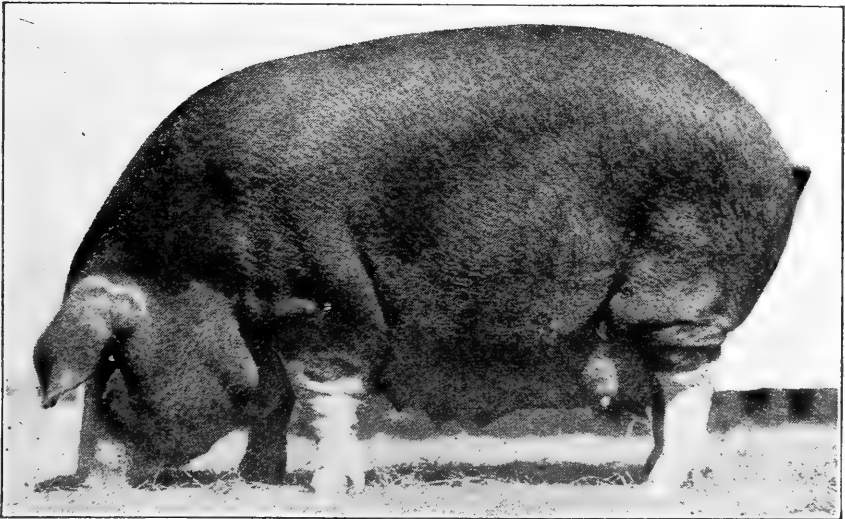

Figure 176.—Poland-China sow, Champion at 1920 Ohio State Fair.
Photograph by J. C. Allen.

as "Magie hogs." During the last half of the nineteenth century there were many noted herds in Ohio, Indiana, and Illinois. Although the Poland-China was long a black and white spotted breed, a change took place in this respect, and black, with a small amount of white, especially on face and feet, became popular, and is so to-day.

In present color markings the Poland-China much resembles the Berkshire. The head is of medium length, and rather straight in the face; the ears, which should be somewhat thin, point forward and then break over to form

what is called a lop ear. A good head lacks coarseness, and inclines to be wide between the eyes, and is somewhat short, but is never dished. The body form of this breed is quite distinctly its own, the neck being short, the back wide and frequently strongly arched, and the hams highly developed. These features of head, arch of back, and thickness of hams are Poland-China characteristics. In comparatively recent years, dating perhaps with the opening of the present century, there has been a marked change of type in this breed. The tendency had been to produce a hog deficient in bone, that finished off in feeding into too small or tidy a type, while the sows were seriously criticized for under size and small litters. This criticism resulted in a movement for improvement, out of which has come what is known as the "big-type" Poland-China, a pig of pronounced length of body, great arch of back, immense bone and great weight. In this connection, brood sows of marked increase of size and prolificacy have been developed. In the opinion of competent critics, Poland-China breeders are now going to the extreme on weight and bone, for many boars have attained weights of 600 to 700 pounds, while a few have even surpassed 1,000 pounds. Unquestionably the present-day movement has revived interest in the breed, which following the World War has undergone great popularity. This is one of the more important breeds in the American corn belt. Poland-Chinas put on fat easily, and are noted as feeders. When properly fattened, the carcass dresses out well and is popular with butchers.

The Spotted Poland-China is a type of this breed that first began to attract attention about 1912, and has since grown much in favor in the corn belt, especially Ohio, Indiana, Illinois, and Iowa. The body of the Spotted Poland-China is of large size at maturity, is covered with large black and white spots, is strong of bone and hair, and impresses one as being somewhat coarse. This type is promoted by

the National Spotted Poland-China Breeders' Association. The advantages claimed for it are its size and vigor, its adaptability to the feed lot, and the superiority of the sows in producing and raising large and uniform litters.

The Duroc-Jersey is a red or sandy-colored breed of swine that no doubt obtained its special color markings from the coarse red hog brought from Africa, and from sandy or reddish English hogs, such as the Tamworth and sandy Berkshire. Daniel Webster, of Massachusetts, the famous statesman, imported some red hogs from Portugal in 1852, which reached America about the time of his death. In New



Figure 177.—A herd of Spotted Poland-Chinas. Photograph by the author.

Jersey large red hogs had been grown for many years, where they became known as Jersey Reds. In New York state another variety of red pigs developed that were called Durocs. They were smaller and finer in bone than the Jersey Reds. The blood of these two families was mingled together, from which was developed what we now call the Duroc-Jersey. The present-day Duroc-Jersey is red in color, of which there are various shades, ranging from sandy or light red to a cherry color or dark red. A medium red shade is the most popular. The head has a straight face, and the ears lop over forward. The back is usually slightly arched

and the ribs are well sprung. The hams do not show quite the thickness of the Poland-China, but are not to be regarded as specially deficient in this respect.

In recent years there has been developed a great movement among Duroc-Jersey breeders to produce hogs of considerable scale and bone, of the true big type, with marked length of body, strong arch of back, and superior bone. The average individual of the breed will perhaps be somewhat larger than either Poland-China or Chester White,

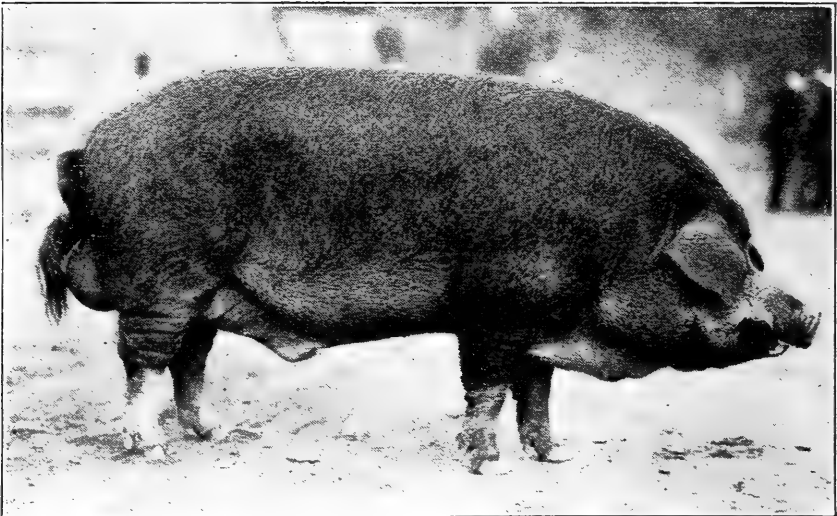

Figure 178.—Duroc-Jersey boar, Great Orion Sensation, grand champion National Swine Show, 1919, 1921. Owned by Ed. Kern, of Nebraska.

and weights of mature boars are often given at 600 to 800 pounds, and sows at 500 to 600 pounds. In size, however, the Duroc-Jersey and Poland-China are in the same class, with more extremes to be found in the latter than the former. Duroc-Jerseys mature fairly early, and finish off in fattening at 200 to 250 pounds, at six months of age. The breed has not thus far made much of a showing in carcass test competition. The sows usually have large litters, this being the most prolific of the lard-type breeds. Duroc-Jerseys are extremely popular in the middle-western states where

corn is abundant. In fact this breed since 1900 has had a wonderful growth in public favor, and many herds of Poland-Chinas and Berkshires have given way to the Duroc-Jersey. The breed is widely distributed over America, but is more especially prominent in Ohio, Iowa, Illinois, Nebraska, Missouri, Minnesota, Indiana, and South Dakota.

The Chester White breed of hogs gets its name from Chester county, Pennsylvania, where it has been bred for a great many years. Claims have been made that the early colonists brought over coarse white pigs to Pennsylvania. In 1820 a Captain Jeffries, of West Chester, Pennsylvania, brought some white hogs from England. Others of the same color also found their way into that section. White hogs were brought to Ohio at an early date, and the Todd family in that state became noted for developing what is known as Todd's Improved Chester White. During the latter part of the nineteenth century, Mr. L. B. Silver, of Ohio, developed a strain of this breed, which is now known as the Ohio Improved Chester White. This is frequently called the O. I. C. hog. All these different families or blood lines represent the same breed, however, and differ only in minor details. The Chester White, as its name indicates, is white. Occasionally, small, black spots occur on the skin, but they are occasionally found in all the white breeds. The head rather resembles that of the Poland-China, in that the face is straight and the ears lopped over. The Chester White is a true lard type of hog. It is a splendid feeder, and, when well fattened, carries a very broad, arched back and has an excellent ham. The quality of bone in the legs is frequently too fine, and mature animals often stand badly on their feet. In recent years, in keeping with the development of the Poland-China and Duroc-Jersey, breeders of Chester Whites have emphasized scale, and the tendency has been to breed a larger, heavier-boned hog. The Chester White type, however, has not gone through so great a change

as have the others, and the extremely high back and up-standing form has not been so noticeable with this breed. The usual run of mature boars will weigh around 600 pounds, and the sows 500 pounds. The sows farrow good-sized litters, the breed ranking close to the Duroc-Jersey in this respect. Sows commonly have nine pigs to the litter. The quality of pork is excellent, although inclined to have a large per cent of fat. In the carcass contests at the International Live Stock Exposition, grade and cross-bred Chester Whites



Figure 179.—Chester White sow, Buehler's Wonder, grand champion National Swine Show, 1921. Bred and shown by William Buehler, of Nebraska. Photograph from Mr. Buehler.

have made excellent records. Chester Whites are widely distributed as a breed in the North, and especially east of the Mississippi. In the South any white breed is unpopular on account of color, white hogs blistering under the sun more than red or black ones. There are many herds of Chester White hogs in Pennsylvania, Ohio, Indiana, Illinois, Missouri, Iowa, Nebraska, South Dakota, and Minnesota, and the breed is well adapted to the northern corn belt.

The Hampshire breed of swine for many years was known in America as the "Thin Rind." It is black in color, with a white belt at the shoulders which encircles the body. No one knows the fountain head of these hogs in America. In 1904 breeders of these hogs assumed that they came from Hampshire, England, and adopted that name. In view of the fact that there was an English black breed of this name in Hampshire, the author has thought the selection of this name for the American breed was unfortunate. Belted hogs

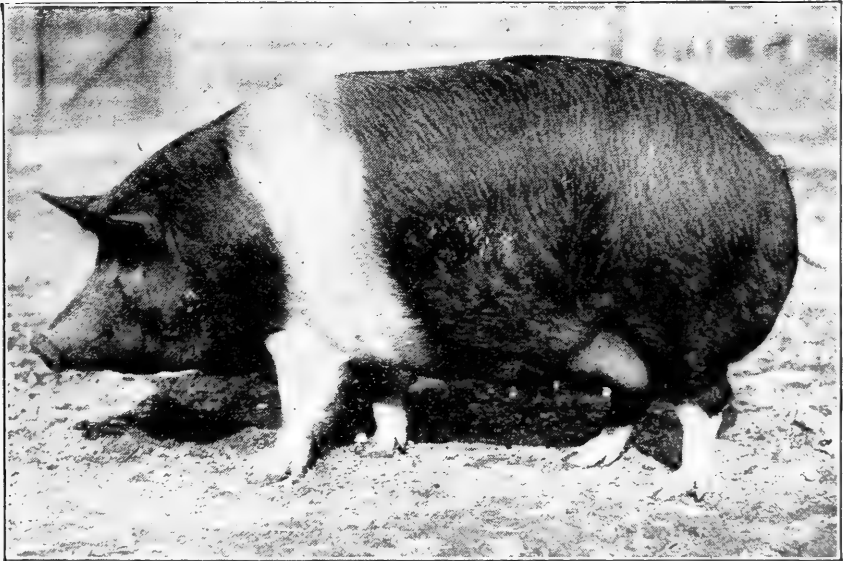

Figure 180.—A Hampshire brood sow. Bred and owned by J. Crouch & Son, Indiana. Photograph from the owners.

have been found in different parts of Europe, and in very recent years, especially since the World War, a breed of this sort, known as the Wessex Saddle-back hog, has received much attention in England, and especially in south Hampshire. The claim is made by promoters of the Wessex that it is an old British forest breed.

For many years "Thin Rind" hogs were bred in a limited way in Kentucky, southern Indiana, and southern Illinois, and these were of the bacon type. Finally the breed was

taken up by men in the corn section of Illinois, and it has gradually changed in form to a broader-backed, thicker kind, more nearly of the lard type. This transformation shows how a corn diet will change the form of an animal. Hampshire swine have straight and medium-long faces, especially with the males, and the ears vary from erect to leaning forward. The back is of medium width and the body is usually very smooth along the sides. The hams lack fullness, being more of the Berkshire type than of the Poland-China. The Hampshire is a good feeder, maturing fairly early, and producing a carcass with an excellent proportion of lean meat to fat. In carcass contests, hogs of this breed or its crosses have usually made an excellent showing, and Hampshire pigs or their grades, find great popularity with the butchers. This is not a large breed, mature boars weighing around 500 to 600 pounds, and sows 300 to 350 pounds. The sows are fairly prolific, which fact is a much-desired characteristic. Hampshires have undergone a great wave of popularity, and the breed may be classed as common, especially in Ohio, Indiana, Illinois, Iowa, Missouri, Nebraska, South Dakota, Alabama, and Georgia.

The Large Yorkshire, called in England the "Large White," is one of the oldest breeds of swine. Large, coarse, white hogs were bred in eastern and northeastern England before distinctions of types and breeds were known. English writers of over a century ago refer to these large, slow-maturing, narrow-backed, coarse white hogs. They were improved by selection and breeding, and this work was done in part by factory hands and laborers in the middle of the last century. Joseph Tuley was prominent in this work.

The Large Yorkshire belongs to the bacon class. As grown to-day, it is one of the largest breeds. Boars at maturity often weigh 700 pounds or more, and sows 500 pounds. The head inclines to be a trifle long, from an American point of view, and is sometimes slightly dished. The ears should

be carried erect, but with age they usually incline forward. The body of the Large Yorkshire should show considerable length and have smooth deep sides, from which bacon may be cut to the best advantage. The back lacks the width and the ham the thickness of the lard type. The legs often appear long for the depth of body. Large Yorkshires do not mature early nor fatten and finish off so readily as do hogs of the lard type. They rather tend to continue their growth until they have attained considerable size before lay-

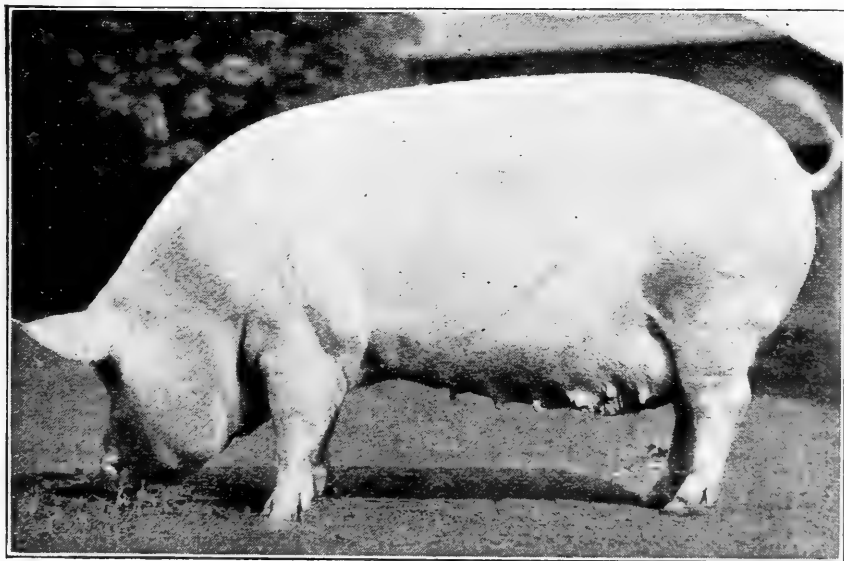

Figure 181.—Large Yorkshire sow, Ohio State Lady 463, grand champion, Ohio State Fair, 1920. Photograph by J. C. Allen.

ing on much fat. Even then they will never fatten like our lard hogs, although they will gain as much or more in weight per day. This hog is well adapted for grazing on clover and other green feeds. The quality of the meat is of the very best. More prime bacon is made in Great Britain and Denmark from the Large Yorkshire than from any other breed, the Danes making bacon production a great industry. Large Yorkshire sows are noted for farrowing many pigs in a litter, this being one of the most prolific breeds. On

account of its bacon, this is the leading breed in Great Britain and Denmark. In America, these hogs, though bred for many years, have never been so popular as hogs of the lard type. They are bred in sections of the North, especially in Canada, and in the northwestern states.

The Small Yorkshire, known in England as the "Small White," is of English origin. It was developed early in the nineteenth century, when certain men wished a small, very fat type of pig. This is distinctly a small breed, weighing at maturity about 200 pounds. The head is often short and

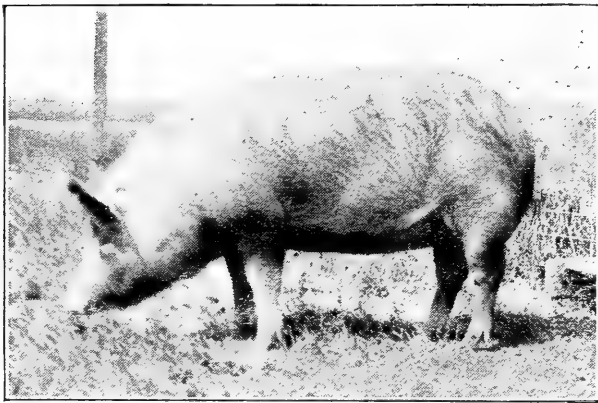

Figure 182.—A Tamworth gilt at the Ohio Agricultural Experiment Station. Photograph by the author.

extremely dished, so much so that easy feeding is impossible. In fancy specimens the head is almost distorted, the ears are erect, the neck short, back very wide, hams short and thick, and legs short.

The Small Yorkshire matures early and fattens easily for its size, making a very fat type of pork. The sows are not prolific. The breed has been getting less and less common so that but few are found in America or Europe. There is no demand of commercial importance for it here or abroad, and the Royal Agricultural Society of England has recently denied it a place on its premium list.

The Tamworth is an old English breed of extreme bacon type. Its native home is central England, where it was known early in the last century. It is red or chestnut in color and of varying shades from very light to dark. In size it is large, the boars often weighing 600 pounds or more

and the sows 450. The head is often undesirably long and straight. The ears at maturity are large and coarse, and lean heavily forward. The body is narrow, the depth of rib is short, the hams lack thickness, and the neck and legs are long. It does not fatten easily, and is slow to mature, but produces excellent bacon. The sows are prolific. There are few of this breed in England or America. There are a few herds in the Mississippi Valley, and the breed seems to be gaining in favor. At the National Swine Show in 1921, there was a large and fine display of Tamworths.

The Cheshire is a medium-sized, white breed of the lard type, mostly bred in New York state, the place of its origin. The breed originated about 1855, with the Large Yorkshire as an important blood line in the parentage. It resembles what the Englishman calls the Middle White, which is really a more compact, broader-backed, heavier-hammed, lardier type than the Large Yorkshire. It has a fair size, weighs well, matures early, and feeds and fattens to advantage. The sows farrow comparatively good-sized litters. This is one of the least known of American hogs.

DO YOU REMEMBER ABOUT

1. The appearance of the wild boar?
2. How long ago herds of swine were kept in England?
3. When the Berkshire was first brought to America?
4. Criticisms made of the Berkshire?
5. Where the Poland-China originated?
6. The Poland-China as feeders and breeders?
7. How much mature Duroc-Jerseys weigh?
8. Who originated the O. I. C. strain of Chester Whites?
9. How packers value the Hampshire carcass?
10. The large Yorkshire as a bacon producer?

SOME DESIRABLE OBSERVATIONS IN YOUR NEIGHBORHOOD

11. What breeds of swine are most common in your vicinity or township?
12. A comparison of size of litters of sows of different breeds.
13. Are big type pigs popular and profitable feeders?
14. Make a map of the distribution of some one breed in your county.
15. If white hogs are grazed in your vicinity, do they blister?
16. Secure a breed scale of points, and score one or more pigs of some breed.

CHAPTER XXXIV

THE JUDGING OF SWINE

Two distinct market types of hogs exist in America, the lard and the bacon. The lard type prevails in all those sections of North America where corn is an important farm crop. In fact, the bacon type is produced in but a small way in this country, and comparatively few are found in the market. The study of the lard type should, therefore, receive most attention.

A score card for the fat hog may be used in general prac-

tice for either pure-bred or grade animals. The following scale of points is given discussion in the order of its arrangement.

The weight and size of the hog depend naturally on the age and breeding. In the general market, animals that

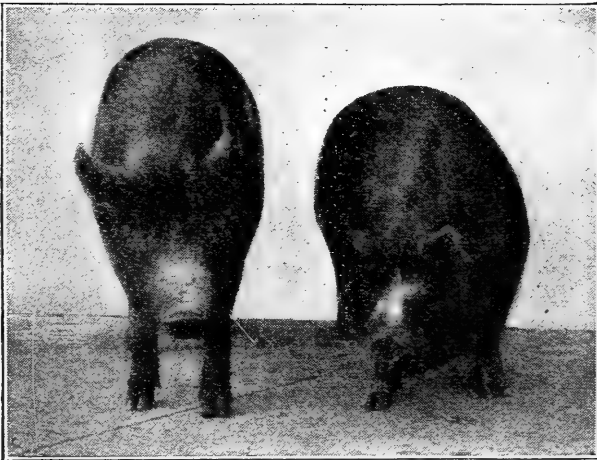

Figure 183.—Two types of pigs, bacon on left and lard on right. Note difference in thickness. Photograph by the author.

weigh about 250 pounds are most satisfactory for slaughter. The average weight of the millions of hogs sold in Chicago stock yards is about 225 pounds. The market demands different hogs for different uses, however, so that all market hogs are sorted somewhat on the basis of weight, condition, and purpose. For this reason, a criticism regarding weight

SCORE CARD FOR FAT HOGS—LARD TYPE

Scale of Points	Perfect score	Score of hog judged
GENERAL APPEARANCE: 34 Points.		
WEIGHT, score according to age, 175 lbs. for 6 mos.; 300 lbs. at one year.....	4	
FORM, broad, deep, low, symmetrical, compact, standing well on feet.....	10	
QUALITY, hair fine; skin smooth; no coarseness of bone....	10	
CONDITION, deep, firm, even covering flesh, giving smooth finish.....	10	
HEAD AND NECK: 7 Points.		
SNOUT, neither coarse nor long.....	1	
FACE, wide between eyes; cheeks full, without wrinkles...	1	
EYES, mild, good size, to be easily seen.....	1	
EARS, not coarse, of medium size, neatly attached.....	1	
NOSE, smooth, broad, full to shoulder.....	1	
NECK, thick, short, broad on top.....	2	
FORE QUARTERS: 12 Points.		
SHOULDERS, broad, deep, full, smooth, compact on top....	6	
BREAST, wide, roomy.....	4	
LEGS, straight, short, strong, wide apart, well set, pasterns upright, standing well upon toes.....	2	
BODY: 32 Points.		
CHEST, deep, wide, large girth; flanks, well filled.....	3	
BACK, slightly arched, very broad, thickly and evenly fleshed.....	9	
LOIN, wide as back, full and strong.....	8	
SIDES, fairly deep, not too long, smooth, and full from ham to shoulder.....	6	
BELLY, straight, wide, trim, not paunchy.....	4	
FLANKS, full and low.....	2	
HINDQUARTERS: 15 Points.		
RUMP, same width as back, long, level, wide.....	3	
HAMS, deep, wide, thick, not wrinkled, fleshed well to hock	10	
LEGS, straight, short, strong, wide apart, well set; pasterns upright, strong, standing well on toes.....	2	
Total points.....	100	

should take into consideration the special purpose involved. At 6 months of age 175 pounds would be a satisfactory weight, while at 12 months of age, when fairly well fed, a fat hog should weigh from 300 to 350 pounds.

The general form of the hog may be studied from different points of view. A short cane or stick is useful to change the position of an animal in order to observe it to the best advantage. Hogs tend to keep the head close to the ground, and rarely stand with the four legs in good position beneath the body. For these reasons it is well to keep animals of this class more or less in motion while judging. Width of back and depth of rib should be noted from overhead or from one side, while a fullness of both front and hind parts

should be easily seen from front and rear. In this inspection compactness of form, and quality, should be manifest. One may easily determine the quality by eye examination, but a feel of the hair will reveal marked differences in quality, that along the neck and front part of the spine being always the coarsest. While condition may be easily seen and estimated by the eye, if one will press with the ends of the fingers along on the back and sides, a better idea will be had of the depth and evenness of covering and condition of skin. In the case of aged boars, there will be noted a very thick, coarse development of skin over the shoulders, known

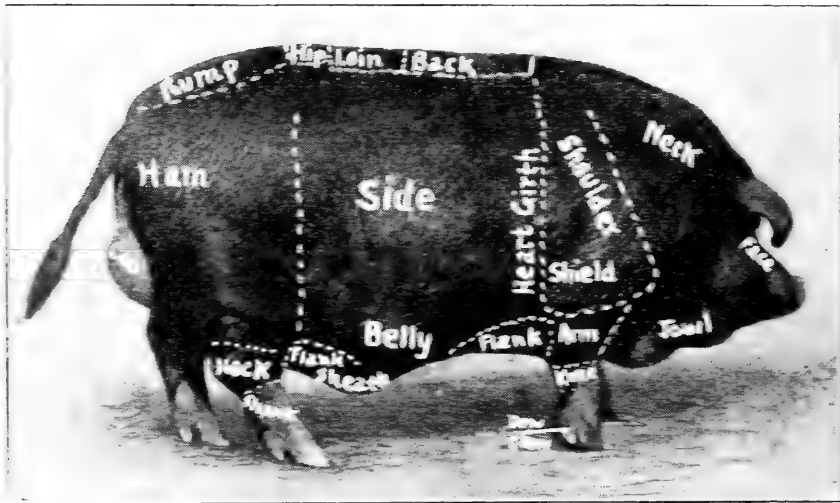

Figure 184.—The points of the hog. Reproduced from "Judging Farm Animals," by the author.

as the "shields." This is an inheritance from the wild ancestors, and really served as a shield; for, when fighting, pigs strike with their heads against the shoulders of the opponents. The tusks of the boar can not easily tear through this shield. Yet this thick, heavy covering of hide is very objectionable, and the best show animals do not have it. Symmetry of form is important: if the front part of the body is thick and heavy, and the hind part narrow, the form certainly will not appear symmetrical or well balanced.

Quality in hogs, as in all other animals, is of great importance. This is shown in the condition of the hair, the size of bone, and the development of the head. There should be a plentiful coat of hair that is neither very fine nor very coarse. If too fine, lack of constitutional vigor is indicated; but heavy bristles along the back, tell us surely that a coarse-grained, low grade of killing hog may be expected. The quality of the hair is an index to the quality of bone. Coarse hair naturally goes with coarse bone. Among experienced swine breeders, a bone of fair size, yet not coarse, is especially desired. The well-fattened hog requires strong bones to support the heavy body weight. A common criticism is that pigs are too small of bone and lack support of the body. For this reason, many breeders and feeders are looking for a hog that has plenty of size and bone, without coarseness. In passing judgment on animals of this class, one must be mindful to secure as much size as possible, consistent with quality. A large head for the body, with coarse thick ears, also indicates inferior quality. Many young hogs are too small and refined for their age, and never mature into animals of enough feeding or breeding capacity. Excess of refinement is, therefore, to be avoided.

The condition of the hog relates to its depth and evenness of covering of flesh and fat. This should be uniform and smooth, no matter what the purpose of the animal. One common defect, more especially of the lard type, is the prevalence of seams, or creases, on the body. These are particularly noticeable about the neck and the fleshy part

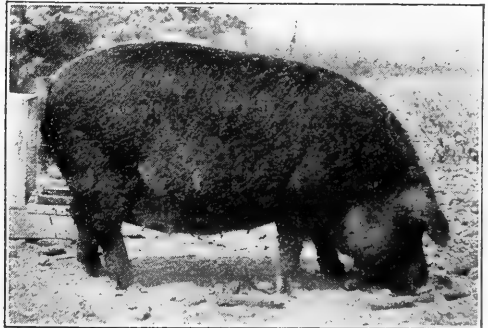

Figure 185.—“The quality of the hair is an index to the quality of the bone.” Photograph by the author.

under the jaws, known as the jowl, and along the shoulders and sides. These creases contain more or less hair that is hard to remove after scalding. In the larger hog-killing houses, the hair is removed by automatic scrapers. It can easily be seen that the more creases there are on the body, the more difficult it will be to remove the hair from them. In such cases hand work is necessary to finish the job. These seams are also an indication of uneven fleshing.

The head of the hog varies so in size and form, according to breed, that it seems best to emphasize only certain features that should be common to all breeds and grades. The large, coarse head is an evidence of waste, hence buyers prefer a short type of head, indicating smaller loss in this portion in killing. Even with the long-headed breeds, the degree of refinement is measured by length and coarseness of snout. A narrow face, often seen on a long head, indicates a poor feeder and mean disposition. The eyes should always be easily seen, with the whites clearly showing. The eyes of the hog of the lard type tend to become surrounded by excessive fat, so that the sight is very poor. The ears are good indicators of quality. They should be easily carried, and not be heavy and coarse where attached to the head. None of the lard-type breeds naturally have coarse ears.

The jowl of the hog is the thick, fleshy part of the lower jaw and throat. Sometimes it is very large and round, and is a great mass of fat. Often deep, hairy creases occur here. The jowl can not be studied to advantage unless it is both seen and felt. If the animal keeps its head close to the ground, the jowl can not be thoroughly examined. The jowl in its best form is short, smooth, free of creases, and firm to the touch.

The neck of the hog should be reasonably short and broad on top, and blend smoothly into the shoulders. A common fault is a thin neck, fitting roughly in the shoulders which stand out in a prominent manner at the shoulder vein.

The shoulders of the hog vary considerably. The tendency is for them to be heavy or coarse, and open on top, the blades not lying back in close. The shoulders are valuable for meat, and the more they are covered with flesh the better they are. While the breast of the hog does not appear as prominent as with other animals, on account of the low carriage of the head, if the shoulders

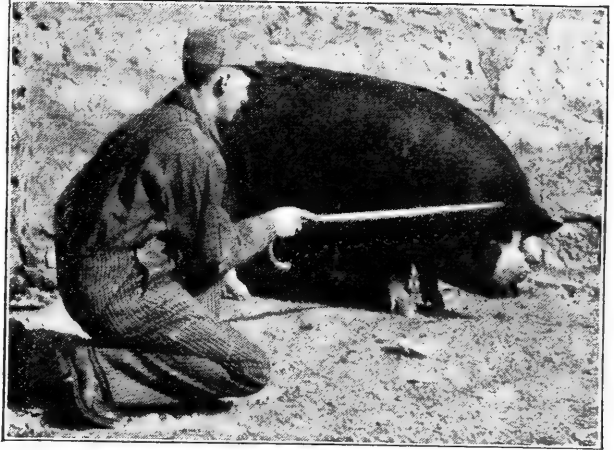

Figure 186.—“The neck of the hog should be reasonably short.” Photograph by the author.

are placed right, the breast will be wide and full and the front legs will come down in good form. By means of the hand



Figure 187.—“The shoulders of the hog vary considerably.” Photograph by the author.

one can feel the end of the breast bone, which should extend at least beyond the legs. Such a breast development shows good constitution.

The legs should be strong and stand straight and well

apart, a position associated with a wide chest and vigorous constitution. The pasterns of the hog are often found to be very weak and too sloping. At the back of the leg,

just above the pasterns, are two small toes that are known as dew claws. When the pasterns are too sloping, the dew claws often touch the ground, showing a weakness of leg. In the days when hogs were driven overland to market, it was very important that the legs should be strong, capable of endurance, and weak pasterns were then very objectionable. While we do not drive hogs much to-day, it is still necessary in many localities to do so; and, whether driven or not, the hog should stand up strong on its toes on short pasterns, as an evidence of ability to carry its weight well. If it can not do so, then the pasterns are weak.

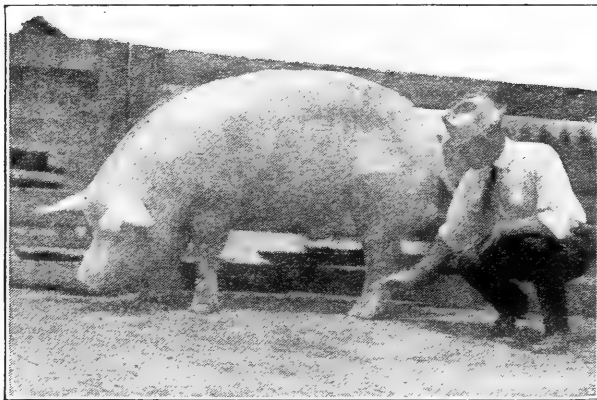

Figure 188. "The legs should be strong, capable of endurance." Photograph by the author.

The toes of the hog should be close together, and point directly forward. Sometimes, when weak, they will spread apart and do not have a strong position. Such feet are an indication of improper feeding and show a lack

of bone and too much forced growth of the young pig.

The body of the hog should show depth, width, and compactness. The chest should especially show plenty of girth. If the shoulders are wide on top, the chest below may appear narrow, unless the fore flanks are very full. A front view displays the width of chest, while from the side we may note its depth and fullness of flank.

The back is one of the most valuable parts; for here the butcher secures the choice chops and roasts. The wider and better the condition of back and loin, the more high-class cuts the butcher will be able to obtain from the car-

cass. In the older and larger fat hogs, the layer of fat over the back is very thick, ranging from two to three inches. Such animals are frequently referred to in the market as "fat backs," and long strips of the fat are cut from this part and rendered into lard. A wide back is an indication not only of the condition of flesh, but also of the capacity below for the vital organs and the digestive system. Generally, a long rib and large chest capacity go with width on top. In inspecting the back, as viewed from one side, emphasize a strong carriage, with a slight arching. Young pigs frequently have a depression behind the shoulders, which fills up on fattening. A full, strong development at this place is very desirable.

The sides of the hog should be fairly deep and smooth, and uniformly so from front to hind flank. This part furnishes the bacon cuts; hence a smooth, uniform condition of flesh is important. Creases very commonly occur along the upper part of the sides and give a bad appearance to the body. Often one may easily insert the fingers in these creases. The lard type does not have a long side, as a rule; neither is it quite flat, as viewed from one side. The form tends to be somewhat oval, especially in hogs with Poland-China, Duroc-Jersey, or Chester White blood, consequently the upper part of the side projects some beyond the lower portion. Emphasis also should be placed on smoothness of fleshing, and quality of skin.

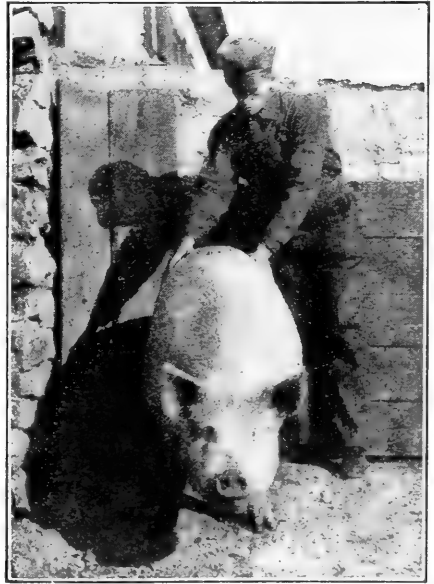

Figure 189.—"The layer of fat over the back is very thick." Photograph by the author.

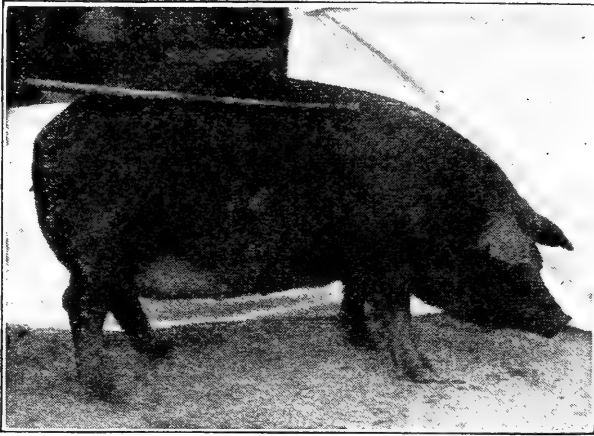

Figure 190.—The back should have a strong carriage, with a slight arching. Photograph by the author.

The belly of the hog should suggest as little waste as possible. A paunchy condition, that is, a round, sleek form, indicates excess offal. A clean, straight line, as viewed from one side, with full flanks,

is what is wanted. Where an excess of belly occurs, as in the case of old sows, buyers throw off a certain amount of weight, or, as they say in the market, “dock” the animals.

The hind quarters of the hog include the rump and hams, the most valuable part of the carcass. The hams represent a high-priced and heavy-weighing part, so that a thick, full development is here sought. Standing behind the hog, one should note that the width is carried full, from the hips back to the end of the body. The thighs should be wide-spread on the outside, and very thickly muscled between, with the twist extending low down toward the hocks. The tail attachment should not be set low. Great depth

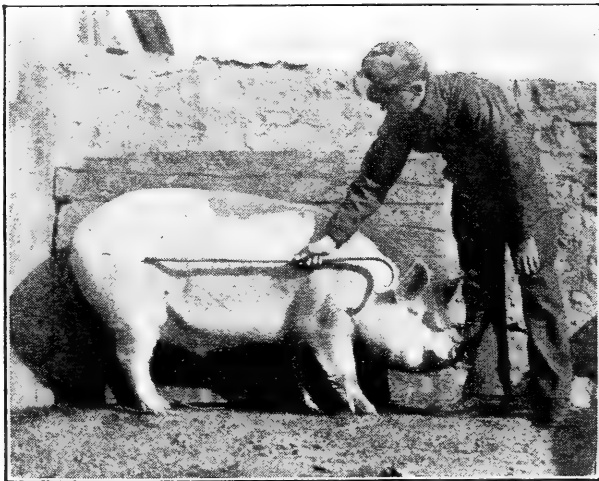

Figure 191.—“The sides of the hog should be fairly deep and smooth.” Photograph by the author.

of hams is of prime importance; for, if lacking here, they will be deficient in the amount of flesh carried.

From one side, the rump should be long on top, level rather than steep, and long also from hip to hock. A very steep rump is often seen, with the legs carried under the body, thus furnishing a weak support. The steep rump does not allow a good position of legs. Side or rear view should show a very meaty ham, somewhat bulging in its lower part. Smoothness of covering of ham is important, as wrinkles and uneven condition injure the value in the meat trade.

The legs of the hog, as viewed in front, at one side, and from behind, should be short and straight, and not coarse of bone. The

front legs sometimes nearly touch at the knees, giving what is termed a buck-kneed effect. This usually accompanies the narrow chest. The hind legs frequently are close together at

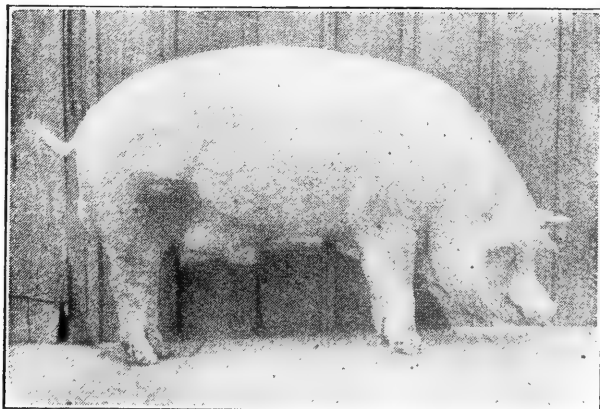

Figure 192.—A good leg attitude of the hog. Photograph by the author.

the hocks with the feet widely spread below the body. Such a position usually goes with a narrow thigh, or ham. Pasterns and feet have already been discussed in this chapter, and need not be referred to again, except to emphasize the correct position of these parts as most important in supporting a heavy-weight body.

In judging breeding stock of the lard type, the same general features are to be considered, making exceptions for sex character and a leaner condition. The mature male requires a head showing great vigor and masculinity, with

a strong jaw, prominent tusks, breadth of forehead, a strong neck, and some thickness of shoulder. Most breeders also prefer breeding stock which have very good length, and are not too short and compact. More bone is looked for in the boar than in the sow or fat hog. In fact, breeders rarely criticise a boar for having too heavy bone. As has already been brought out in the discussion of breeds, big-type hogs have a strong arch of back and great length. A big-type boar at 12 months of age, for example, often stands high, is long, strongly arched of back, and appears short of rib for his length. With maturity he fills out, however, so that he really does not seem especially leggy after all. The same

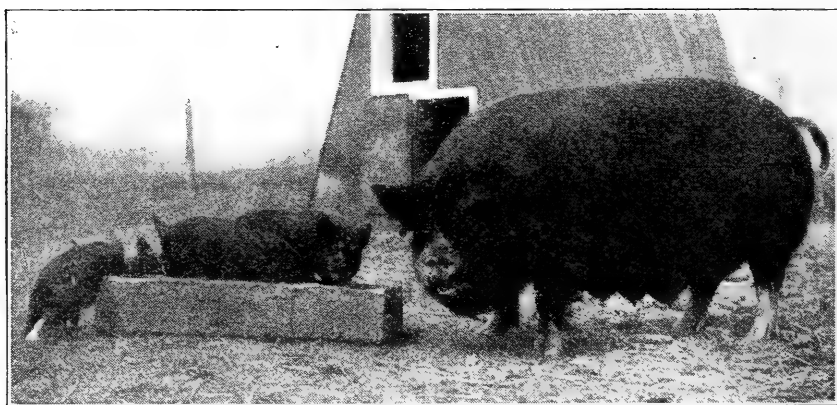

Figure 193.—“The brood sow should show good size and length, and have a strong, well-supported back.” Photograph by the author.

may be said for the big type sow at 12 to 18 months of age. Irrespective of type, however, the brood sow should show good size and length, and have a strong, well-supported back. Depth and length are most valued qualities in her case, as these indicate large reproductive capacity. Sows frequently are too light in bone for their weight, and this defect should be noted. The sow should be quiet, yet active, but not nervous and excitable. An irritable sow is almost sure to make a bad mother and one does the wise thing to dispose of that kind, when such disposition is proven.

THE BACON TYPE OF HOG

The bacon type of hog is produced in comparatively small numbers in the United States; but, on account of the steadily increasing demand for bacon, no doubt more hogs of this sort will be bred in the future in this country.

A score card for the bacon hog gives a very good idea of the special features emphasized in this type.

SCORE CARD FOR BACON HOGS.

Scale of points	Perfect Score	Score of hog judged
GENERAL APPEARANCE: 34 Points.		
WEIGHT, market hogs should weigh 160-220 lbs.....	5	
FORM, long, smooth; level back; belly neat.....	10	
QUALITY, hair fine; skin smooth and free of wrinkles; bone strong but not coarse; flesh firm.....	10	
CONDITION, well covered with firm flesh, especially on back and loin.....	6	
STYLE, active and sprightly, walking true, standing up well on toes.....	3	
HEAD AND NECK: 8 Points.		
SNOUT, medium long; face, broad at eyes.....	2	
EYES, good size, bright; ears, medium size, not coarse.....	2	
JOWL, not very wide, muscular, smooth; neck medium long, muscular.....	4	
FORE QUARTERS: 12 Points.		
SHOULDERS, smooth, well laid in; breast, full.....	9	
LEGS, medium long, straight, well placed, not coarse; pasterns erect and straight.....	3	
BODY: 33 Points.		
BACK, medium width, slight arch neck to tail; loin same width, strong, full.....	11	
RIBS, well sprung, long; side, long, smooth, medium deep..	12	
CHEST, full, even with shoulder; flanks full and low.....	7	
BELLY, firm, trim, thick, not flabby or shrunken.....	3	
HIND QUARTERS: 13 Points.		
RUMP, same width as back, long, level.....	4	
HAMS, full, not flabby; thigh tapering toward hock, without folds or wrinkles.....	6	
LEGS, medium long, hocks well set apart, straight, bone good, pasterns erect.....	3	
Total score.....	100	

Judging the bacon hog requires keeping in mind certain important features wherein this type differs from the lard hog. Bacon is the first consideration. This comes from the sides; the side that is longest and smoothest, with fair depth, therefore, is the most valuable. But bacon must not be heavy in fat; hence the condition of the body must show only a moderate amount of flesh. For these reasons, the

bacon hog shows a comparatively narrow back, but considerable length of body. Over the back of the bacon hog, a uniform depth of about one inch of fat is ample, rather than the ordinary thickness of the lard type, for a muscular carcass with a moderate amount of fat is what is desired.

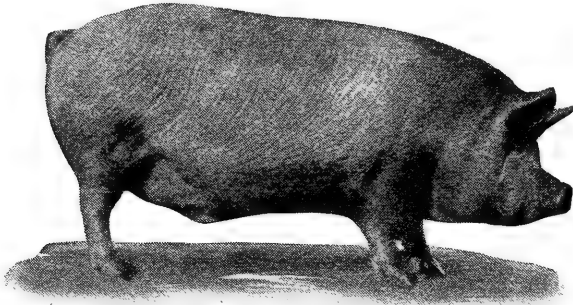

Figure 194.—“The shoulder of the bacon hog should be smooth and not heavy like the lard type.” Photograph by the author.

The shoulder of the bacon hog should be smooth, and not heavy like the lard type, but should nicely blend into the body. The thickness between the shoulders is not great, and a front

view shows a relatively narrower neck and chest and longer leg, compared with the lard type.

The ham of the bacon hog lacks in thickness, yet should be long on top, and taper off into a lean type, with no great amount of fat. From a side view, the ham cuts away more on its under part; while from behind, the thighs are thin and are usually well split up between, producing rather a shallow twist.

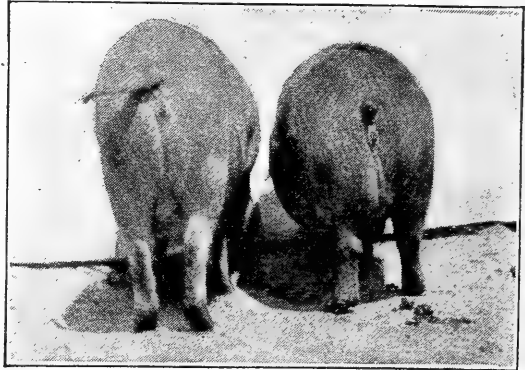

Figure 195.—A comparison of hams of bacon and lard type pigs. Photograph by the author.

The belly of the bacon hog should show just as little fullness as possible, consistent with being a good feeder. Any evidence of paunchiness or thickness here is objectionable. The lower part of the body line should be smooth and

trim, and give evidence of the least amount of offal. A straight, trim line from front to hind flank is desirable.

The general appearance of the bacon type is that of a narrow, long-bodied, smooth-sided, long-legged hog, not too fat in any portion. The excessive length of leg, which often prevails, is to be criticised; otherwise these features of conformation are very desirable and should be maintained.

AMONG OTHER THINGS, THINK ABOUT

1. Quality as an important feature of the hog.
2. The occurrence of seams, or creases, and why objectionable.
3. The pasterns, past and present.
4. The five features most highly rated in the scale of points.
5. The "shield" and its significance.
6. The relation of breast to shoulder and constitution.
7. Where the most important "cuts" are found in the carcass.
8. Differences between breeding stock and that for the butcher.
9. The meaning of bacon type.
10. Relation of bacon form to offal.

SOME NEIGHBORHOOD INVESTIGATIONS

11. Place on a township map the locations of market feeders of hogs.
12. Do feeders breed or purchase the stock fed?
13. What attention is given to quality by men buying hogs?
14. Does the lard or the bacon type prevail in your locality?
15. Bring to class a score-card record of some animal in the home herd.
16. Organize a local swine-judging contest.

CHAPTER XXXV

FEEDING SWINE

The production of pork is a great industry in America, the United States being the acknowledged leader of the world in this field of live-stock husbandry. This leadership is largely due to the fact that pork is produced more cheaply than any other meat, and the average man can feed and care for pigs with more satisfaction, and better prospects of gain, than in the case of any other farm animal. In the corn belt hogs and corn seem a natural combination, so that in the great Mississippi Valley swine husbandry is highly developed. By the 1920 United States Census there were almost sixty million pigs of different ages in this country. The states having three million or more swine are the following, in relative order: Iowa 7,864,000; Illinois 4,640,000; Missouri 3,888,000; Indiana 3,757,000; Nebraska 3,422,000, and Ohio 3,084,000. Three states were in the two million class, namely Minnesota, Georgia, and Texas.

The food requirements for swine have been studied more extensively perhaps, than of any other farm animal. This fact is due in part to the ease with which swine may be handled and fed, and records made of growth and fattening. Exact feeding standards, however, are not generally applied in pork production. The following standards, the modified Wolff-Lehmann, as given by Henry and Morrison,* show the actual needs for fattening pigs, and brood sows with pigs.

A study of these standards makes clear that, as a pig increases in weight while fattening, there is a steady decline in the body requirements for dry matter, digestible crude protein, and total digestible nutrients, while the nutritive

*Feeds and Feeding, 1917.

ratio steadily grows wider. Digestion experiments with breeding swine during growth show also the same decline in the need for dry matter, protein, and total nutrients. In other words, the body requirements of the pig in either growth or fattening call for a gradual lessening of the protein in the ration with an increase of carbohydrates.

A DAILY FEEDING STANDARD FOR SWINE PER 1,000 LBS. LIVE WEIGHT.

Age and condition	Dry matter	Digestible crude protein	Total digestible nutrients	Nutritive ratio
Fattening pigs	Pounds	Pounds	Pounds	
Weight 30-50 lbs.	46.2-51.0	7.8-8.5	41.0-45.4	1:4.0-4.5
“ 50-100 “	37.0-40.8	5.5-6.0	32.9-36.4	1:5.0-5.6
“ 100-150 “	32.4-35.8	4.4-4.9	28.8-31.9	1:5.5-6.2
“ 150-200 “	29.0-32.0	3.5-3.9	25.8-28.5	1:6.2-7.0
“ 200-250 “	25.5-28.1	3.0-3.4	22.7-25.0	1:6.5-7.3
“ 250-300 “	22.4-24.8	2.6-2.9	20.0-22.0	1:6.7-7.5
Brood sows with pigs	20.0-24.0	2.4-2.7	18.0-21.0	1:6.0-7.0

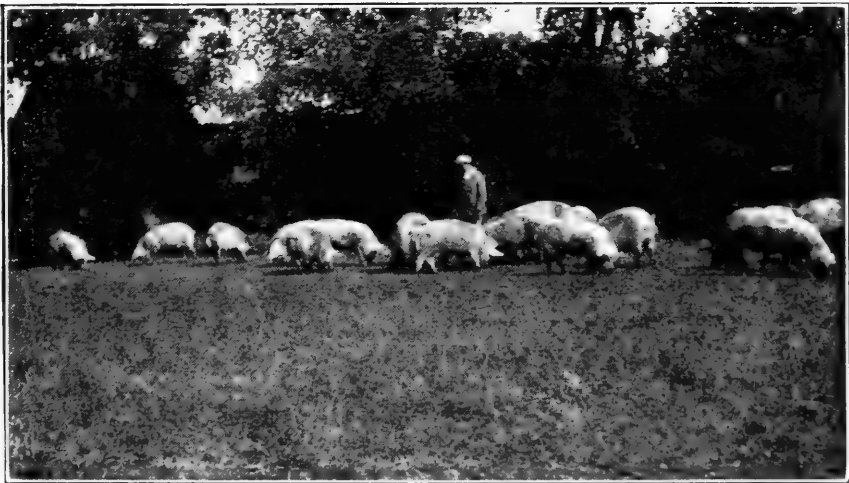

Figure 196.—Yorkshire brood sows on an English pasture, owned by Sanders Spencer, Holycraft, St. Ives, England. Photograph by the author.

The type of food best suited to the pig is of a concentrated form. The pig has a single stomach, rather limited in capacity, and, therefore, it can not consume roughage like the cow or sheep with their compound stomachs and much greater

relative capacities. It is true that hogs will do well on succulent forage crops and pastures, but even then the total amount eaten is comparatively small. The older class of hogs in winter will eat the leafy roughage of alfalfa or clover to some extent, but too much of this should not be fed. The standard grains, and mill products are best suited to the digestive tract of the hog.

The preparation of the food for swine has received considerable attention. Various experimenters have amply demonstrated that cooking the food for swine injures the digestibility of the proteins, and that better results are obtained by feeding raw rather than cooked food. Soaking grain may be advantageous, especially in the case of old corn that is hard and dry. In comparative experiments in feeding soaked whole wheat and dry whole wheat, conducted by the author at the Indiana station, and by Snyder and Burnett at the Nebraska station, a slight advantage came from soaking the grain. The grinding of grain for hogs has been somewhat advantageous. Prof. W. A. Henry, of Wisconsin, fed ground and shelled corn in comparison for ten winters,* and found that on the average it required 501 pounds of whole corn and wheat middlings for 100 pounds of gain, and only 471 pounds of corn meal and middlings for an equal gain. Evvard, of Iowa, and King, of Indiana station, have found that no special advantage is secured by grinding corn for young pigs, but as they pass beyond 3 or 4 months of age somewhat better gains are made from ground or soaked grain. Corn-and-cob meal is not to be recommended for the pig, but, if fed, the cob should be ground fine.

The relationship of age of pigs to digestibility of food and gains in weight has been shown in digestion experiments conducted by Prof. Evvard, of Iowa. He found that a pig weighing 60 pounds digests corn fed in different ways with somewhat more efficiency than one weighing 200 pounds.

*Feeds and Feeding, 1917.

It has long been known that, as pigs grow older, other things being equal, it requires more grain for 100 pounds of gain in live weight. If we apply the relationship of age to weight, then of a large number of animals fed at different weights, as shown by Henry and Morrison,* the amount of food required for 100 pounds gain in live weight steadily increased from 293 for a pig weighing from 15 to 50 pounds, up to 535 pounds for one weighing from 300 to 350 pounds. It is important, however, to note that, as the pig gained in weight, there was a decrease in the amount of food eaten daily for each 100 pounds of live weight. The average daily gain in live weight increased up to 300 pounds, after which it fell off slightly.

The influence of breed in pork production, so far as the relationship of food consumed to gains in weight is concerned, is problematical. In experiments reported upon by Prof. G. E. Day, of Canada,† in which five tests were conducted upon six breeds at the Ontario Agricultural College, and in three tests at the Iowa station, no very satisfactory results were secured. "Why, for instance," writes Prof. Day, "do Berkshires, Yorkshires, Duroc-Jerseys and Poland-Chinas range all the way from the top to the bottom of the list in the different tests; and why would an average of the Ontario tests give a rating of the breeds which is entirely different from an average of the Iowa tests?" In the opinion of many practical swine breeders, some breeds produce pork more economically than others, but we have very insufficient evidence to prove that one breed is better than another.

Mineral food for swine is of first importance. When we realize that an animal can not live without iron in its blood, and that over 90 per cent of the bony system consists of calcium and phosphorus, we must appreciate the importance of these substances in the food. For many years swine growers in the corn belt have been accustomed to placing ashes or soft coal in the pig lots. This was eaten

*Feeds and Feeding, 1917.

†Productive Swine Husbandry, 1915.

by the pigs, but why, the farmer did not know. Prof. Henry, of Wisconsin, early in experimental swine feeding demonstrated that the bones of hogs that had been fed corn alone were deficient in ash, and broke much more easily than those of hogs fed corn and mineral matter. Since then other experiments have clearly demonstrated that minerals are an actual necessity in the diet of swine as well as of other farm animals. If hogs are fed on clover or alfalfa, with corn, they will obtain in the legumes considerable mineral matter, but where concentrates are largely relied upon for feeding,



Figure 197.—Hogs on alfalfa pasture, Oregon Agricultural Experiment Station. Photograph by the author.

especially corn, minerals in some form are a necessity. A mixture of equal parts by weight of ground limestone, fine bone meal, and salt will make a satisfactory mineral for swine. Various kinds of mixtures are used by different feeders, many of whom also use flowers of sulphur, copperas and salt, for medicinal purposes, in addition to the other minerals used. For brood sows Prof. W. W. Smith recommends* a combination of 12 parts charcoal, 3 parts air-slacked lime, ground bone or ground rock phosphate, and 1 part common salt. Wood ashes in the same quantity as

*Pork Production, 1920.

the lime he thinks would improve the combination. But very little salt seems to be needed by swine.

Water for swine seems to have an unusual place in the animal economy; for, besides its customary use as a drink, it is used extensively to prepare slop foods, and is also highly esteemed by the hog for bathing purposes. In cold weather hogs do not drink so heavily, excepting through slop feed, but in warm weather they need more water. Commenting on the fact that a new born pig's body consists of 80 per cent water, while that of a fat hog weighing 400 pounds contains 35 per cent, Prof. Evvard says.*

"The main point is that all pigs require a lot of water regardless of their own water content and we should aim to give it to them liberally. We should allow more water in summer than in winter, because of the higher temperature. Some of our sows in January drank around four pounds of water per head daily, whereas in April they daily drank 24 pounds. The water consumption per pound of dry matter ranged from 1.3 pound in cold winter up to 7.6 pounds in warm springtime."

Pigs greatly relish a bath in warm weather, and will throw themselves down in any wet place, and wallow. They do not cool off as freely as other animals by the radiation of moisture from the pores of the skin, and so obtain relief in a wallow. Some of the more progressive swine growers supply drinking water to the stock through fountains attached to barrels holding water, and also provide shallow concrete-lined bathing pools.

The feeding of the brood sow prior to farrowing calls for a ration fairly rich in protein. For fall farrowing, a legume pasture, or rape forage, and corn make an excellent diet. If for spring farrowing, then during the winter it is advisable to feed a little leafy alfalfa or clover hay and a mixture of 10 parts corn, 5 parts middlings and 1 part tankage or meat meal. Prof. Smith states† that a mature sow in breeding condition can be maintained, as a rule, by a little less than one and one fourth pounds of average grain daily for each 100 pounds of live weight. The brood sow should be brought to

*Pamphlet published in 1921 by Hampshire Swine Association.

†Pork Production, 1920.

farrowing in good condition, but not fat. About three weeks before farrowing the sow should have her ration changed to a combination of 5 parts each by weight of bran and middlings, and 1 part each of linseed meal and tankage or meat meal. She should also receive some skimmed milk in her ration, if available. After farrowing, this ration may be continued for a few days, until the pigs and the mother get strong on their feet, when the ration may be changed again to allow the use of part corn. If one is not able to make up this ration, one should endeavor to give as nearly

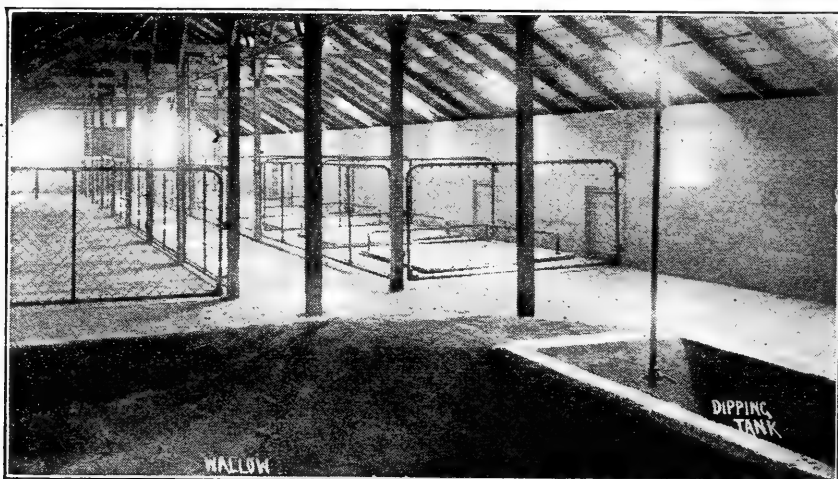

Figure 198.—Interior of model Iowa piggery, containing sanitary pens, wallow and dipping tank. Photograph by E. J. Hall.

a balanced ration as possible, not relying too much on corn, but using in part some form of protein food.

The feeding of suckling pigs is at first largely of the mother's milk. When about 2 weeks old the young ones, if given a chance, will begin to drink some slop along with the mother. Then a creep should be provided for them, and a small trough arranged, in which is placed a thin slop of milk, wheat middlings, and oatmeal or sieved ground oats. As the pigs get older they may be fed lightly of shelled corn scattered around, preferably soaked for very young pigs.

It is important that these pigs be kept growing, and have plenty of exercise. They may be weaned at 10 to 12 weeks of age, under ordinary conditions.

The feeding of young breeding pigs after nursing is over is largely a proposition of making a good growth and strong muscular body. For stock of this kind it is desirable to feed in summer on pasture of legumes or rape, with 1 to 2 pounds of grain for each 100 pounds of live weight. In winter, feed a small amount of legume hay and a mixture similar to that given the brood sow some weeks prior to farrowing. Nothing is more valuable for young growing pigs than skim milk, which should be supplied. Where corn is the main concentrate available for feeding, meat meal or tankage should by all means be purchased, as it does much to balance the ration and also adds to the palatability.

In feeding the boar one should keep in mind that he must never be fat, but be muscular, vigorous and healthy. Some green food is desirable in summer, but not too much. If legume or rape forage is available, then a light feed of corn may be given, although a mixture of equal parts of corn and middlings would be better, with 5 per cent tankage added. The boar should have plenty of exercise in a well-fenced lot in which shade and housing is provided, and he should eat his food with keen appetite.

The fattening of pigs in the corn belt is usually based on a generous use of corn, along with pasture of some kind in summer and fall. Pigs on legumes, with corn for concentrates, have essentially a balanced ration, and thrive thereon. Pigs fattened in the dry lot may be fed such concentrates as are available, according to the section of country. A large per cent of the hogs reaching the Chicago market are fed on corn and tankage, a combination of 10 parts of the former and 1 of the latter being very satisfactory. Skim milk is invaluable in fattening, and supplies much needed protein and ash with such a mineral-deficient carbo-

hydrate as corn. Wheat middlings is a popular concentrate used in fattening hogs, but Prof. Evvard states* that in the

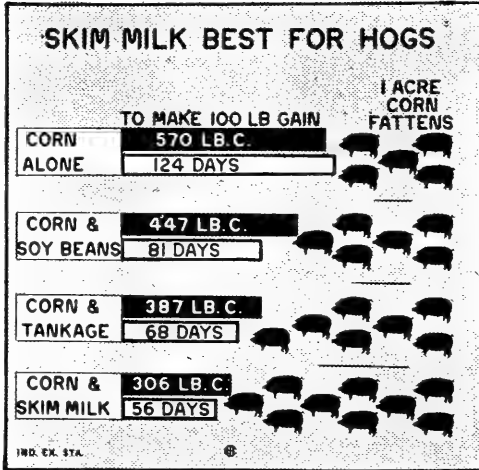

Figure 199.—Chart showing result of hog feeding trials at the Purdue University Experiment Station, showing advantage from feeding skimmilk to fattening hogs. Reproduced from "The Cow the Mother of Prosperity," International Harvester Co.

tests at the Iowa station they have found that it takes about 150 pounds of wheat middlings and tankage, when fed on good pasture, to produce the same amount of gain as 100 pounds of shelled corn and tankage. One of the difficulties with the wheat middlings, especially if of a low grade, is that it does not contain enough net energy units for each one hundred pounds. The

adaptability of the hog to consuming a wide range of

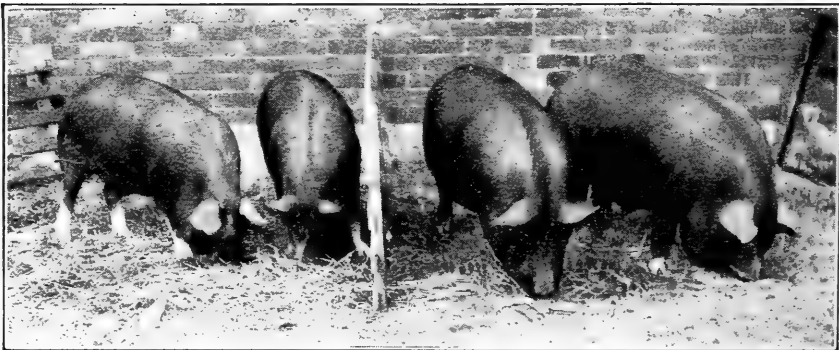

Figure 200.—Two lots of hogs fed at the Ohio Experiment Station. The two at the left were fed corn alone in dry lot, those at the right corn and tankage. Photograph from Ohio Experiment Station.

food stuffs makes the subject of fattening a relatively simple matter. Over much of the United States corn is

*Hampshire Swine Association pamphlet, 1921.

the chief concentrate used, but in the Northwest, on the Pacific slope, in Canada, and Europe barley is commonly used, and is regarded as making the best grade of pork. In the West and Southwest Kafir corn is a satisfactory substitute for corn, while in much of the South peanuts are becoming an important factor in fattening hogs. Peanuts, however, produce a soft pork, and so must be fed with care. Cottonseed meal has been fed to some extent; but, as it contains an ingredient poisonous to hogs, it is unsafe as a hog feed, excepting in very small amounts for periods not

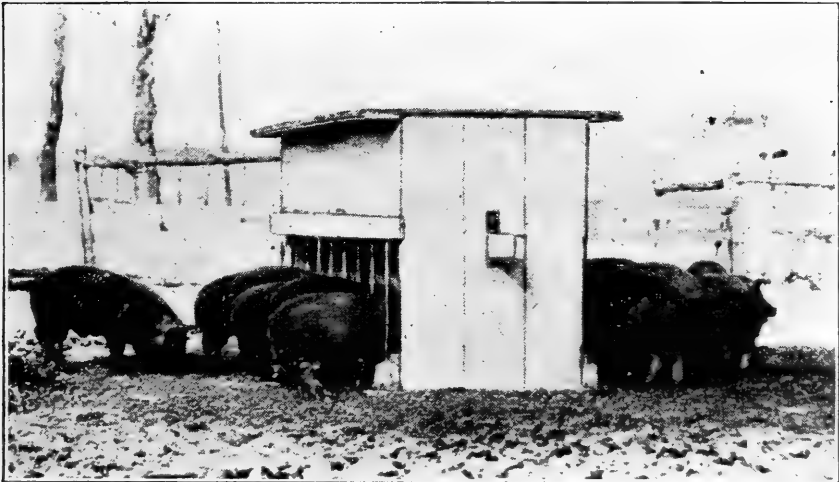

Figure 201.—The self-feeder for hogs. Photograph from *The Farmer*.

exceeding 40 days. Meat meal, or tankage, on account of its high per cent of protein and its freedom from carbohydrates, makes an invaluable material for using with corn, barley, rice, and millstuffs of similar composition.

The self-feeder for swine has come into great popularity in recent years. This is a box-like arrangement, with the back vertical, and the front at a slant after the style of a letter V. The food is placed in the wide top, and gradually sifts out at the bottom point into a feed trough. Self-feeders contain two or more compartments, a different

kind of food being placed in each one. The pig goes to the self-feeder and eats to suit himself. This has been called the "cafeteria" or "free choice" system of feeding. Experiments at a number of our stations have shown that pigs fattened by this method gained more rapidly than those hand-fed, and essentially balanced their rations themselves. The labor bill with pigs thus fed is greatly reduced, and there is less waste of feed than there is where corn is scattered over the ground. In experiments conducted by Prof. Evvard at the Iowa station, in comparison with hand-fed under different conditions, the free-choice-fed pigs had the advantage in gains in weight and cost of production. In experiments conducted by Prof. L. A. Weaver at the Missouri station,* pigs fattened with the self-feeder gained more rapidly than those which had been hand-fed, but with no difference in economy of gain.

"It is apparent," writes Prof. Weaver, "that the advantage which the self-feeder method will have in any specific instance over hand-feeding, in regard to rate of gain, will depend to a large degree upon the ability of the person doing the hand-feeding to feed so that the hogs will consume a maximum amount of feed. In practically all cases, when the self-fed hogs gained more rapidly than those which are hand-fed, they also consumed more feed."

The self-feeder is not generally suited to breeding stock, where it is necessary to assume control over the amount of food eaten in order to prevent fattening. Prof. W. W. Smith, however, regards the use of the self-feeder during the winter, for pregnant sows and gilts, as a safe method.† He recommends to feed in it a good quality of alfalfa or clover hay cut fine or ground and mixed with corn, and the proportion of hay so regulated that the consumption of corn will not exceed the amount necessary to maintain the proper condition and weight. "However," he says, "great care must be exercised that the consumption of corn is not excessive. In the hands of a careless feeder, the indiscriminate use of the self-feeder would prove disastrous."

*Self-Feeders for Fattening Swine. Bulletin 144 Mo. Ag. Exp. Station, 1917.

†Pork Production, 1920.

IN PRODUCTIVE PORK PRODUCTION TAKE NOTE

1. Where the industry centers.
2. Of the relative needs of protein and digestible nutrients in gains in weight with fattening pigs.
3. As to how food should be prepared.
4. Of the amount of food required for 100 pounds gain at different ages.
5. If the Duroc-Jersey will feed more profitably than the Poland China.
6. What part mineral matter plays in growth and development.
7. How the nursing sow should be fed.
8. When a pig creep should be used.
9. Of the part corn plays in fattening market swine.
10. Of results from using the self-feeder.

STUDIES FOR MEMBERS OF PIG CLUBS

11. How do each of ten farmers prepare their concentrates for their sows and pigs?
12. To what weight do your neighbors feed their pigs for market?
13. Make up a statement of mineral foods fed by different farmers.
14. Note the provisions for watering swine on several farms.
15. At what age are pigs weaned in your community?
16. Give five rations in use for fattening swine for market.
17. Make a self-feeder and report on its construction and cost.
18. Ascertain if self-feeders are in use about home, and with what success.

CHAPTER XXXVI

THE CARE OF SWINE

The care of the sow and pigs at farrowing requires watchful attention. The sides of the pen in which the sow farrows should be provided with guards to prevent the mother from lying on her pigs. This guard may consist of a plank or a 2 x 4 piece fastened about 6 inches above the floor, and 8 or 10 inches out from the side of the pen. But very little bedding should be placed in the farrowing pen; for, if it is too thick, the small, more or less weak newly born pigs may get tangled in it, and have difficulty in getting about their mother. The dam should not be disturbed while farrowing, and the pen should be as quiet and comfortable as possible, and protected from cold drafts and dampness. Some careful herdsmen remove the pigs from the dam as fast as farrowed, and place them in barrels or baskets partly filled with straw. In cold weather a jug of warm water buried in the straw will keep the little pigs at a comfortable temperature. The young pigs should be allowed to nurse the mother every 2 or 3 hours the first day, and then after 24 hours be left with her for good. If, however, she is nervous and irritable, it may be well to keep the pigs from her 2 or 3 days, allowing them to nurse at intervals.

The separation of pigs into different groups, according to sex, age, and condition, is important, if one is to care for them properly. When the pigs are weaned, the gilts should be separated from the boar pigs, and each group fed and cared for separately. The older gilts should receive attention preparatory for sale or placing in the breeding herd, while the mature sows naturally must be fed and cared for by themselves. The service boar requires a strong pen or paddock,

where he may be kept under restraint and properly fed. Hogs being fattened for the market naturally receive different feed from the breeding stock, and so must be kept by themselves. On many farms the careful separation of the animals into groups as indicated may not be possible in all details, but the more carefully this separation is observed, the more success will attend the herd development.

The sanitation of the swine quarters is of first importance. The pens should be kept free from filth and an unnecessary amount of manure, and the floors should be kept reasonably dry. One may keep swine in almost any kind of building, but a dry floor and clean conditions are equally important whatever the kind of house occupied. The drainage about the swine quarters should be away from the buildings and yards, to promote sanitation. Unfortunately there are too many farms where the hogs are obliged to live and wallow in mud and manure, where disease germs abound. Sanitary conditions in the swine building may be improved by the free use of slacked lime sprinkled on the floors of the pens, and by freely whitewashing the walls.

The bedding of swine is customary in the northern sections of the country, especially in winter. The house or shelter should itself be comfortable, so that too much bedding will not be used. Wheat straw makes the best bedding; but, if so much is used that the pigs bury themselves in it in cold weather, when they come out to be fed, they are liable to catch cold due to sudden change of temperature. Only a moderate amount of straw, therefore, should be used. In the South very little bedding is needed in winter, while in the warm season no bedding is required in the North.

Exercise for swine is regarded as a necessity. The tendency in cold weather is for the pigs to huddle close together under the straw and move about in the air as little as possible. In the latter stages of fattening, exercise is not so important, but with the breeding herd it is quite different. If the sows

are to have strong, vigorous pigs, they must have enough exercise to keep them healthy and strong. Many boars are useless, because from lack of exercise they take on too much flesh and become inactive. On this subject Prof. W. W. Smith well says,*

“Exercise promotes a loose, open condition of the bowels and does much to maintain a healthful functioning of the other organs of elimination, exercise contributes strength and vitality, reduces the chances of disease, costs nothing, and is an indispensable factor in the maintenance of health and breeding thrift.”

In winter it is a good plan to drive the pigs about in the lots or near-by yards, scattering some corn and causing them to move about in search of it. When snow is on the ground, it is not so easy to do so; but, if the pigs live in colony houses and come to central feeding troughs, they will be compelled to move about more than they would otherwise and so will secure some exercise.

The care of pigs in hot weather has much to do with their successful development. They should be provided with shade, if possible. A woods-pasture is invaluable as a shelter from the hot sun. Portable pens or cots, that have a free circulation of air across the floor through openings on opposite sides, will furnish shade and may be fairly comfortable. A flat-roofed, low, open-sided shed in the pig lot, that costs but little for labor and material, will also furnish shade.

A wallow in warm weather gives the hog supreme satisfaction. The unsanitary character of mud wallows is to be strictly condemned, but the use of the modern concrete wallow, in which water may be kept reasonably free of filth, is to be highly commended.

Parasites affecting swine are both internal and external. Hogs are very often infested with round worms which may be as large as a common lead pencil, and are a serious drain on their vitality. The eggs and embryo forms of the parasites are found in muddy, filthy yards and lots. If one is to have healthy quarters, it will be very important to keep

*Pork Production, 1921.

the yards really sanitary, and rotate the use of feed lots and pastures, so that they may not become infested. If hogs feed on land that has been continuously used for this purpose, parasites are sure to prevail. One may treat hogs infested with worms as follows, with very satisfactory results. From 3 to 5 grains of santonin and from 5 to 8 grains of calomel, are used for each 100 pounds live weight of pig. The hogs should receive no feed for 10 or 12 hours, after which they are turned to the feed trough in which there is

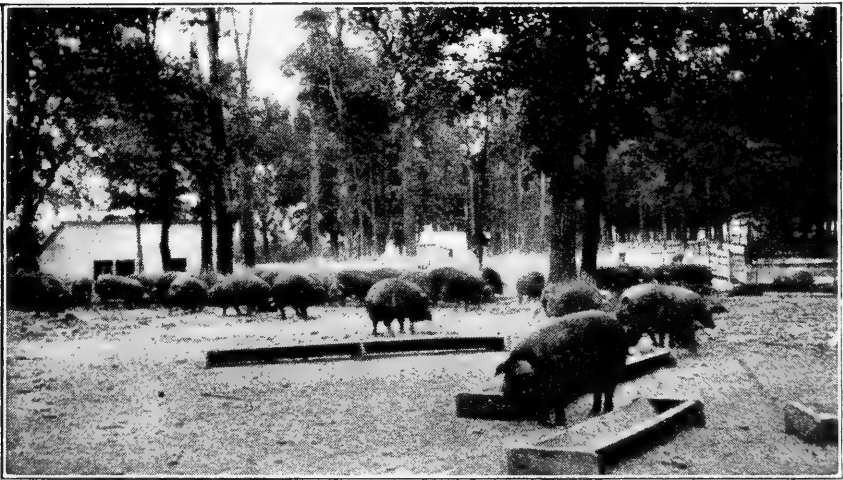

Figure 202.— A woods-pasture and feed yard for pigs. Photograph by the author.

slightly moistened ground feed, over which the necessary amount of powder has been sprinkled. The hogs should then be kept from other feed for 10 hours or so, in order to give the medicine time to do efficient work.

External parasites, such as body lice, often become very abundant. These are easily destroyed by giving the skin a brushing of crude petroleum. If many hogs need treatment, they should be driven through a dipping vat, in which water has been filled nearly to the desired height, on the surface of which should be placed about an inch of the crude oil. It is a good plan to spray the interior of the hog plant occa-

sionally with crude oil and especially the sleeping quarters.

Hog cholera is one of the most common diseases of swine. It is caused by a very minute germ. The symptoms of the disease are general sickness, inflammation and ulceration of stomach and intestines, enlargements of the glands, weakness of the legs, causing staggering, stiffness, etc. Pigs may be sick for several weeks or months before they die. A large amount of research work has been given this disease, and swine plague, which is much the same, but without satisfactory results. In recent years it has been satisfactorily demonstrated that pigs may be made immune from cholera by injecting into healthy animals

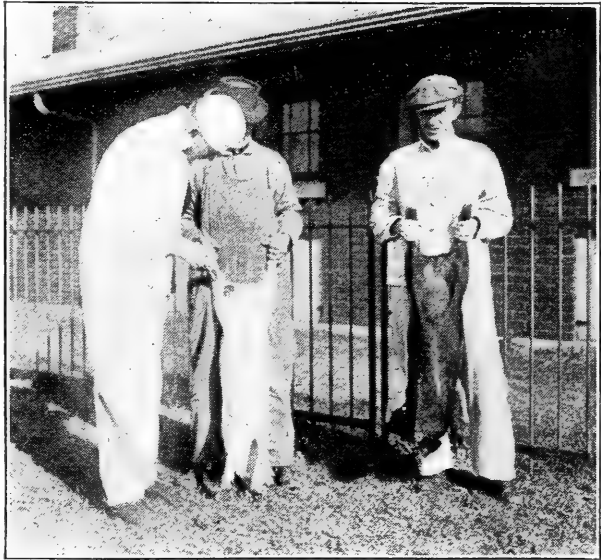

Figure 203.—Injecting serum into thigh of pig to prevent cholera. Photograph from Dr. Edgerton, Ohio State Veterinarian.

a serum prepared from the blood of swine. There are two methods of vaccinating, one, the "single method," in which serum alone is injected into young pigs, which makes them immune for 3 months or so. In the other, the "simultaneous method," the serum is introduced and, at the same time in another place, a small amount of blood that has been taken from a hog sick with cholera. This serum is injected under the skin of the inner thigh of a pig, or behind the ear of a large hog. A large percentage of the herds of swine given treatment to prevent cholera

are made immune. As cholera is highly contagious, great care should be used to prevent any exposure of healthy pigs. It is even unsafe for a person working with healthy pigs to visit a diseased herd, on account of the danger of conveying the disease by means of his shoes. Every farm on which cholera prevails should have a sign at the entrance to the farm, stating that cholera is in the herd.

Tuberculosis among swine is common, especially in herds fed skim milk or buttermilk that has not been pasteurized. This disease is most common, therefore, among pigs fed in dairy districts. When fed in connection with healthy cattle, pastured on forage crops, and given concentrates, tuberculosis is not a common disease among swine. The best method of preventing it is to feed no milk excepting with the certainty that it comes from a healthy source and to keep a herd of cattle known to be free from this disease. Pigs valued at millions of dollars are condemned at packing houses each year on account of having tuberculosis. The affected pig can not be cured.

Removing the tusks of the boar often becomes a necessity. A mature boar, with long sharp tusks, is a source of danger, as a person may be seriously injured by them. They are, therefore, usually removed in well managed herds. The following method is recommended by Prof. G. E. Day:*

"The boar is first made fast to a post by means of a rope noosed about his upper jaw back of the upper tusks. Then one man takes a crowbar and another a sharp chisel and a hammer. The sharp edge of the crowbar is placed against the tusk near its base, and held firmly in position, and the edge of the cold chisel is placed on the opposite side of the tusk directly across from, and even with, the edge of the crowbar. A sharp blow with the hammer on the cold chisel does the job."

Marking the litters of pigs is very necessary in pure-bred herds. The young pigs may be given ear tags, when 3 or 4 weeks old, as indicated on page 54, but these tags often get torn from the ears of pigs, and the tag is then lost. Numbers may be easily tattooed in the ears of pigs of the white breeds, as is commonly done in England. In the United States

*Productive Swine Husbandry, 1915.

various methods of notching the ear of the pig at 2 or 3 weeks of age are used. With a common punch, such as is used for cutting holes in leather, a shallow notch is cut in the edge of the ear of the pig. The following method is in use at the Ontario Agricultural College, and its application is thus clearly described by Prof. Day.*

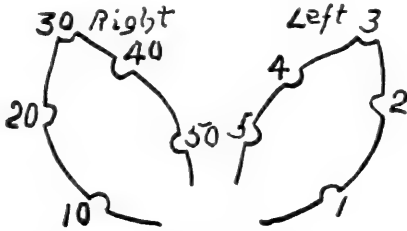

Figure 204.—A method of numbering pigs by ear marks.

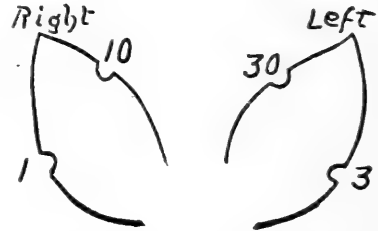

Figure 205.—Another method of numbering pigs by ear marks.

"The accompanying diagram shows the plan of numbering with explanation of its use. For example (Figure 204) all the pigs in the first litter would have a nip taken out of the lower edge of the left ear next to the head, which represents No. 1, No. 2 is indicated by taking a nip out of the lower edge of the left ear half way between the base and the tip; and the pigs in the third litter have a nip taken out of the tip of the left ear, and so forth. Between 5 and 10 two nicks are necessary. Thus, $6 = 5 + 1$, $7 = 5 + 2$, $8 = 5 + 3$, $9 = 5 + 4$. For No. 10 we go to the lower side of the right ear next to the head. Larger numbers call for various combinations, for example, $11 = 10 + 1$, $12 = 10 + 2$, $17 = 10 + 5 + 2$, etc. The nick should not be made deep, or it will disfigure the ear; just a little deeper than the thickness of the skin is sufficient. If the piece is cut out cleanly, the mark will stay as long as the ear lasts."

A private swine herd book should be kept by every breeder of swine. In this he should enter the name and number of each animal, the date of farrowing, name and number of sire and dam, from whom purchased and price, with space for recording name and address of persons to whom sold. In addition to these facts, a diagram of head and ear should be shown against each animal recorded, with the ear notches shown thereon. A card system is especially favored by swine breeders, the main facts as above given being on one side of the card, while the pedigree is given on the reverse side. Space is also available for listing the litters of sows.

A feeding platform for swine is often used among feeders

*Productive Swine Husbandry, 1915

in the corn belt, on which the hogs may feed without wallowing in mud. Cement platforms, on which feed troughs are placed, are best, for they furnish a substantial floor, when well made. They are easily made rat-proof, and are free of the holes or cracks so likely to occur with board floors, and are kept clean with little trouble.

Shelters and houses for swine vary greatly. There are two types in common use, a centralized building, with a series of pens, a room for feed, etc., and a colony or individual house of a single room. The centralized building should



Figure 206.—An Iowa piggyery, showing concrete foundation and outside feeding platform. Note the large amount of sunlight provided through the roof. Photograph by E. J. Hall.

be located where drainage is good, and with feed lots and pastures conveniently connected. This house should be well lighted, so that sunshine will penetrate easily to every part. In an interesting report from 332 farmers in Kansas,* 130 different dimensions of hog houses were reported. The majority of the houses reported on were from 8 to 20 feet wide and from 24 to 60 feet long, the average house being 16 by 40 feet, suitable for 10 farrowing sows. Such a house would have a central four-foot alley, with five 6 x 8 pens on each side. The windows should be placed so as to secure the greatest amount of sunshine possible within the house. The floor may be earthen, wood, or cement. In 316 Kansas

*Hogs in Kansas. Report Kansas State Board of Agriculture, 1919.

reports on the kinds of floors used, 150 reported earth, 5 earth packed over woven wire, 2 gravel, 59 wood or plank, 70 cement or concrete, 2 boards over cement, 8 part earth and part cement, 8 part board and part cement, 6 part wood and 6 stone. Concrete is easily kept sanitary and rat-proof; but, unless well bedded, is inclined to cause rheumatism and pneumonia. Earth floors are cheap and are liked by hogs, but are easily rooted up, and may be very dusty or unsanitary. A movable wood floor over concrete is expensive but ideal from a health point of view. A single colony

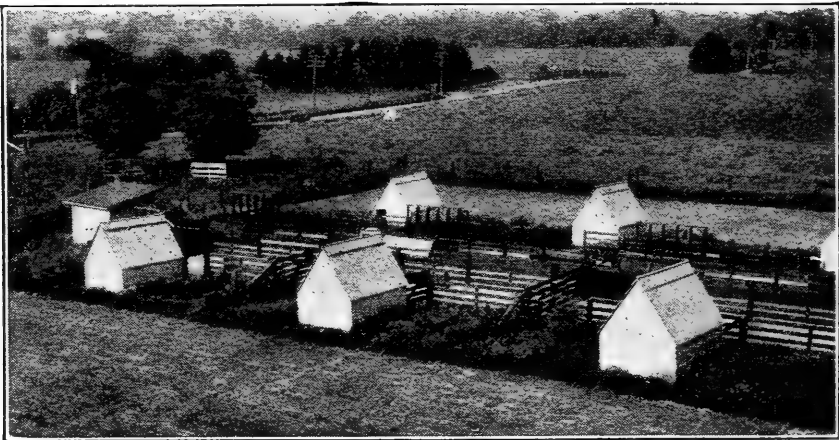

Figure 207.—Hog cots and lots at Ohio Agricultural Experiment Station.
Photograph by the author.

house should have a strong frame work, a roof that does not leak, and sides that are not drafty in cold weather. It should be placed on runners so that it may be easily hauled to a new location whenever desired. A house 5 feet wide and 7 feet long is of convenient dimensions. A house with a gable roof, or a two-thirds-span roof, or one with roof and sides like the letter A, is the more common. The economy "A" house advocated by Iowa Experiment Station, is very popular. It combines low cost, simple construction, and is easily adjusted for changes of temperature. Its 5'x7' floor is sufficient for a good-sized sow and litter.

IN THE CARE OF SWINE

1. How would you protect the young pigs from being lain on by the sow?
2. What would you do to provide sanitary quarters?
3. Why limit the amount of straw bedding in the pens in cold weather?
4. What kind of a wallow should be provided?
5. How destroy external parasites?
6. At what age would you give serum treatment to prevent cholera?
7. What may be done to prevent tuberculosis?
8. When may the tattoo system of marking be used?
9. What is the advantage of a concrete feeding platform?
10. Of what should one be mindful in erecting a centralized house?

**MAKE AN INTERESTING REPORT ON THE FOLLOWING POINTS
IN THE CARE OF NEIGHBORS' PIGS**

11. Are guard rails used in farrowing pens?
12. Are the pigs kept separate according to sex and age?
13. Is the drainage good about the pens?
14. What winter protection is given?
15. Is treatment for parasites given, if so how?
16. What methods are in use to prevent hog cholera?
17. Do boar owners remove tusks from old animals, and if so how?
18. How are the pigs marked for future identification?
19. Are private herd books in use?
20. What kind of houses are most in use?

CHAPTER XXXVII

BOYS' AND GIRLS' LIVE-STOCK CLUBS

For many years an important subject of discussion in the agricultural papers, and in farmers' institutes was, "How can we keep our boys and girls on the farm?" Various answers were given to the question, but naturally the most logical one was to give them an interest in the business. The real movement in this direction began about 1905 in the South, in the organization of boys' and girls' clubs for growing corn under conditions of competition. Dr. S. A. Knapp at this time was engaged in promoting co-operative work among southern farmers, especially in the gulf states, and he did much to interest the boys and girls in production. This work was championed by the United States Department of Agriculture, and, in his annual report for 1913, Secretary of Agriculture Houston wrote as follows.

"The present enrollment in this work amounts to 60,000 boys and girls, who are systematically organized into boys' corn clubs, girls' canning clubs, potato clubs, sugar beet clubs, vegetable garden clubs, etc. The average yield per acre of all the corn-club members reporting this year was 74.5 bushels, with a net profit of \$25.55 per acre; 426 made 100 bushels or more, and 1,078 made over 60 bushels per acre."

The origin of boys' and girls' live-stock clubs may be said to date with the year 1910, when 59 boys in Caddo Parish, Louisiana, organized a pig club,* with the help of Mr. E. W. Jones, the superintendent of the rural schools of the county. This club was organized to do its work after the manner of the corn club, of which it was an outgrowth. The college of agriculture of the Louisiana State University took an active interest in the work, and promoted the organization of other clubs in the state. From this initial effort

*The boys' pig club work. W. F. Ward, U. S. Dept. of Agr. Report, 1915.

has developed a remarkable interest all over the United States in organizing clubs to promote work with pigs, calves, sheep, rabbits, and poultry. In 1917 there were 10,000 young people in poultry clubs in eight states, and 45,000 pig-club members, while in 1920 there were 33,000 members of live-stock clubs in the northern and western states.

The object of the live-stock club is to promote an interest in farm animals on the part of the boys and girls on the

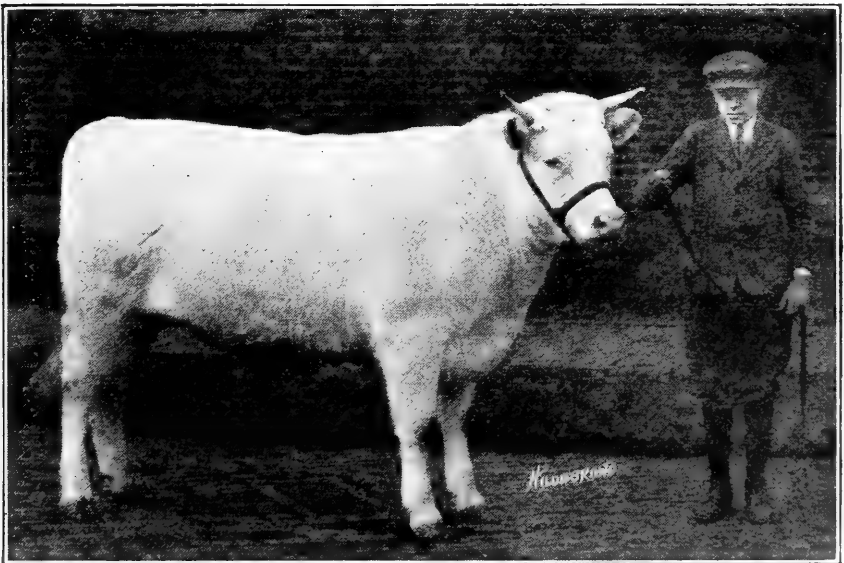

Figure 208.—Shorthorn steer calf, Sunbeam and Ralph Peak of Illinois, who fed and showed him at the International. Photograph by Hildebrand.

farm. Mr. W. F. Ward gives nine objects in forming pig clubs.* The ninth one, although given last, may be regarded as the most important.

“To instill in the boys while young a love of animals which will result in their taking more interest in farm life, and to furnish them at the same time some work which will in a practical way give an insight into the business side of farm life and incite in them a desire to struggle for and attain success.”

There are various other good reasons why boys in particular should interest themselves in these live-stock clubs.

*Boys' Pig Clubs, Farmers' Bulletin 566, December 31, 1913.

The competitive side of the work demonstrates the value of good blood in farm animals and its relationship to profitable production. Thus better breeding will be stimulated. The cost of production will teach the boy how to use the forage crops and concentrates of the farm to best advantage rather than purchase expensive feeds on the market. Boys through live-stock clubs study the breeds and compare them with grades and scrubs, thus becoming judges capable of measuring up values. In this same connection boys become interested in promoting certain breeds, thereby contributing to live-stock improvement. Live-stock clubs of necessity place a premium on proper management, involving breeding, feeding and sanitation, each of which is of vital importance in profitable production. During the late World War, when an appeal was made to the American stockmen to produce more meat, it was estimated that the 45,000 pig-club members produced about ten million pounds of dressed pork.

The organization of live-stock clubs is comparatively simple. In 1915, Mr. W. H. Balis, in charge of Boys' Pig Clubs in Louisiana, wrote.*

"The organization of a pig club consists simply in enrolling each boy and girl of the school who is willing to raise a pig and keep a record of how much the pig is fed, etc. Any teacher may do this and send the names to the parish demonstration agent, or if there is no parish agent, to the Junior Extension Department of the Louisiana State University. Before sending the names to the club agent it is very important that the parents give their consent, as very few will be able to carry on the work unless the parents are willing to co-operate."

Boys' and girls' live-stock clubs are now generally under the supervision of the extension service of our state agricultural colleges, in co-operation with the United States Department of Agriculture. As a rule, county agricultural agents where such persons hold office, organize the clubs, and see that the work is properly started and supervised. Where there are no county agents, the work may be conducted by local clubs, supervised by volunteer leaders. Teachers in the rural schools, especially those teaching agricultural sub-

*Organization of Boys' Pig Clubs, Circular No. 2, Louisiana State University.

jects, usually take an active interest in promoting the clubs. It is recommended that a simple form of organization be adopted by all clubs. It is customary to adopt a consti-



Figure 209.—Newman Rosenberry, a county pig club champion watching his pets. Photograph from Prof. W. H. Palmer.

tution and by-laws, and the following is offered as a suggestion in organizing clubs devoted to live-stock work.

A SUGGESTED CONSTITUTION AND BY-LAWS FOR A BOYS' AND GIRLS' LIVE-STOCK CLUB.

CONSTITUTION

Article I. Name. The name of this organization shall be the Boys' and Girls' Club.

Article II. Object. The object of this club shall be to promote interest in improved live stock, and more especially in, to instruct its members in selecting, feeding, and caring for these animals, and to cultivate a love for farm animals and greater interest in country life.

Article III. Membership. Any boy or girl between the age of 10 and 18 years who will agree to secure at least one and care for it under the instructions of the club leader, may at any time become a member.

Article IV. Officers. The officers shall be a president, vice president, secretary and treasurer.

Article V. Meetings. An annual meeting shall be held on and special meetings may be called by the president at such time and place as he deems necessary.

Article VI. Elections. The election of officers shall be held at the regular annual meeting, and such election shall be by ballot.

Article VII. Amendments. The constitution may be amended by a two-thirds vote of the members present at the annual meeting, or at any special meeting where two weeks' notice has been given club members of proposed change in the constitution.

BY-LAWS

Section 1. Duties and privileges. It shall be the duty of each member to co-operate as far as possible with fellow members in promot-

ing the special work of the club, and to solicit desirable new members. Each member shall be entitled to one vote in the business meetings of the association.

Section 2. Officers. The officers shall be elected to serve one year, or until their successors are elected, and shall perform such services as are ordinarily required by their positions.

Section 3. President. The president shall preside at all meetings when present, and serve as the directing head of its activities.

Section 4. Vice-President. The vice-president shall perform the duties of the president in his absence.

Section 5. Secretary. The secretary shall keep a record of the proceedings of each meeting, and report on the same at the following meeting. The secretary shall act as correspondent in matters relating to the business of the club, and shall keep a roll of the membership.

Section 6. Treasurer. The treasurer, to whom dues shall be paid, shall be the custodian of all funds and shall make an annual financial report, or otherwise at the request of the president.

Section 7. Order of business. (a) Secretary's report of previous meeting. (b) Roll call. (c) Reports of committees. (d) Unfinished business. (e) New business. (f) Adjournment of business session. (g) Social session.

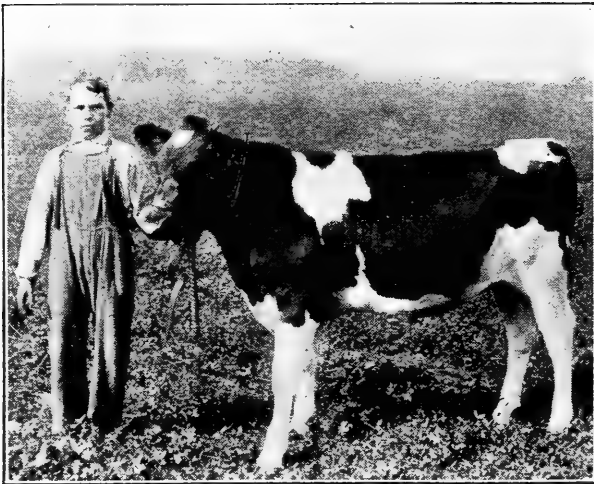

Figure 210.—Edward Bell, of Ohio, and his first prize calf in the calf club class, later grand champion in open class at Ohio State Fair, 1920. Photograph from Ohio State University.

The standardization of club work was undertaken by the United States Department of Agriculture in 1915. It was thought desirable to organize club members in groups, to be supervised by local leaders. In 1918 an agree-

ment was made between the United States Department of Agriculture and the several state club leaders, to provide for standard clubs, and as a result of this conference the following organization requirements were adopted.

1. Each club shall have a membership of at least five working on the same project.
2. There shall be a local club leader in charge during the club year.
3. There shall be a local club organization with necessary officers and duties prescribed in a club constitution.
4. There shall be a definite club program of work for the year.
5. There shall be held at least six regular club meetings during the year. The secretary shall be required to keep definite records of these meetings and also of the progress of each member.
6. A local exhibit shall be held annually by the club.
7. There shall be a club demonstration team which must give at least one public demonstration in the home community.
8. At least 60 per cent of the members must complete the farm or home demonstration and file a final report with the county or state club leader.
9. A judging team shall be chosen by competition between the members.
10. An achievement day program shall be held at the completion of the work.
11. The club shall hold a membership in the farm bureau or other county extension organization.

When the first four requirements have been met, a standard club charter is issued. When all the requirements have been met for any one year, a seal of achievement is awarded.

A county club committee organized to promote the organization and welfare of the clubs is desirable. Such a committee should consist of one person from each community or township of a county, and should be made up where possible of men and women representing organizations interested in the boys and girls of the county. This general committee will, in co-operation with the county leader, select persons to serve as local community committees. This latter body need not have over five members, preferably representing various community clubs. It will be well also to have on this committee one each of the older boys and girls, especially if they have previously been club members. The community committee will decide upon the projects for the community, and should meet in conference with the county leader or other person in charge, to plan the work.

The activities of boys' and girls' clubs are developed in several directions. What probably appeals to young people

most is the demonstration work, as seen in feeding and caring for animals, the exhibits of live stock, and the judging contests. Social events are also of importance, and an annual picnic is popular. Demonstrations of feeding live stock and competitive exhibits of animals are now commonly made by club members all over the United States. These exhibits, especially of cattle, pigs, and chickens, have become large and important parts of the live-stock shows at some of our local and state fairs. At the 1921 Iowa State Fair 416 pigs were shown by members of such clubs. Judging contests are very attractive to the boys and girls. In local community clubs contests are held to determine who the best three or four live-stock judges are, and these are appointed to participate in county club contests. The best team of three represents the county in a state-wide county contest at the college of agriculture. Demonstrations by club members at fairs are becoming popular, and are both interesting and instructive. Such a demonstration may show the effects of certain feeds in producing meat or growth. One club at the 1921 fair at Sioux City gave a fine demonstration of the composition of a fleece of wool in scoured fiber, grease, and dirt, and showed how the fleece should be tied for market.

Prizes for competition of club members or teams have greatly stimulated interest among the boys and girls. These prizes are widely different in character and value. As a general policy it is not desirable to offer cash prizes, unless the money is to be used for some specific educational purpose. Educational trips, such as visiting stock farms under proper supervision, and scholarships in agricultural schools or colleges, are most commendable. A local tour in the community in which a club is centered, inspecting the stock on farms or the animals in charge of club members, is usually very attractive to all concerned. In 1921, a team of Texas club boys who had won the highest honors in the South judging live stock made a trip to Europe to visit stock farms,

the prize in this case being their expenses on that trip. A prize greatly valued by large numbers of club members has been the payment of all necessary expenses of a trip to the state fair or to the college of agriculture. Each year at the Ohio State University the club boys and girls have contests in judging covering several days, at the end of which period the five scoring the highest number of points have been awarded special medals. Silver cups and banners are also desirable prizes, especially for competition between clubs.

The benefits derived from the work of club members is far greater than might be thought possible. Certainly

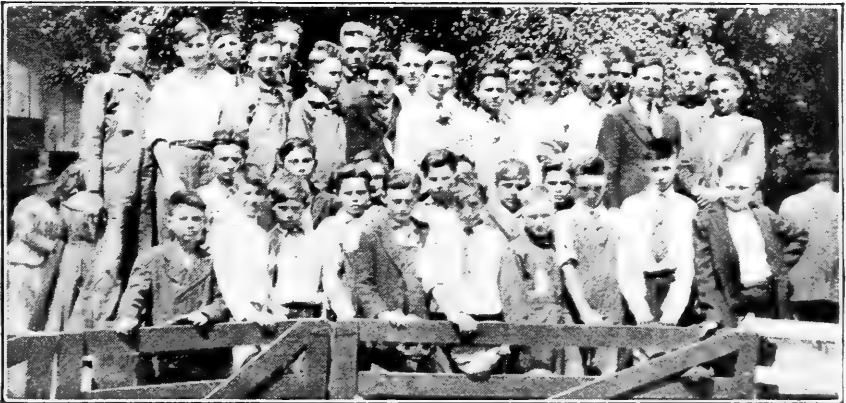

Figure 211.—The Henry County, Ohio, Pig Club. Photograph from Extension Service, Ohio State University.

through these organizations has come a greatly increased interest in farm life, and this has resulted in the keeping of better live stock on many farms. As never before in the history of America, young boys and girls have become partners with their parents. During 1920, according to Messrs. C. B. Smith and G. E. Farrell,* 5,000 farmers were led to replace scrub pigs with pure-breds as a result of the pig-club work. Further, this same year 3,000 poultry-club members in the northern and western states introduced 38,000 pure-bred fowls on their home farms, culled 1,200 flocks, and raised 155,000 chickens. Thousands of pure-bred animals,

*Yearbook U. S. Dept. of Agriculture, 1920, p. 489.

write Messrs. Smith and Farrell, have been introduced as a result of the club work with baby beeves, dairy animals, sheep, and swine. Some 33,000 club members are now engaged in such work in the northern and western states. Of 174 entries by club members at the Iowa State Fair in the baby beef class, 121 were sold at auction and 2 by private sale. The 123 calves weighed 124,220 pounds and sold at an average price of \$18.30 per hundred weight. Iowa State College purchased two of the calves for \$650. During the year 1918 an appeal was made to increase our meat stocks. A special appeal was made to urban boys and girls to assist in this work,* because of the ease with which such clubs could be carried on under city conditions. As a result of this work, 26,322 rabbits and 331,072 chicks were raised, and club members reported gathering 133,564 dozens of eggs. The total estimated value of the food produced by the 37,723 members of 2,171 clubs raising rabbits and chickens was \$402,238, a really remarkable showing.

One fine feature of the club work is the development of community spirit and leadership among the boys and girls. Without question they are contributing much to the uplift of rural life which is now taking place. Club work also promotes co-operation in the best sense. Where young people thus co-operate, older ones are also influenced in the same direction. This result all comes through well directed, generous leadership. In 1918 there were about 14,000 volunteer leaders who devoted themselves to promoting community welfare through these boys' and girls' clubs. Another important result of club membership is that, in assuming personal responsibility for things worth while, the boy or the girl obtains the reward that comes for things well done. To feed and care for an animal, and watch its growth and development, is a most beneficial sort of education. But if one is able to win a prize at the live-stock show, as a result of this feed and care, the reward is even greater

*Boys' and Girls' Club Work, 1918. Circular 66, U. S. Dept. of Agr

CAN YOU ANSWER THESE QUESTIONS?

1. When and where was the first boys' live-stock club started?
2. How many members of live-stock clubs were there in 1920 in the northern and western states?
3. What was Mr. Ward's ninth object in forming pig clubs?
4. How are boys' and girls' clubs organized and supervised?
5. What is the object of a club?
6. What is meant by standardizing club work?
7. Of whom should the membership of a county club committee consist?
8. What is the most popular form of club activities?
9. What form of prizes is most desirable?
10. How did club members help furnish food during the war?

SUGGESTIONS TO CLUB MEMBERS

11. Make a community or similar map, giving locations of club members.
12. If more than one club is in your township or county, ascertain which seems strongest in membership and the reason?
13. Ascertain what projects are being carried out in clubs in your vicinity.
14. Learn if standard clubs are more efficient than any others.
15. Compare rations fed by different boys and girls feeding the same kind of live stock.
16. Write a report for publication of what you saw on a club trip.

CHAPTER XXXVIII

CO-OPERATIVE LIVE-STOCK SHIPPERS' ASSOCIATIONS

The origin of co-operative live-stock shippers' associations has been generally credited to a community about Litchfield, in Meeker County, in south-central Minnesota, where it was organized in 1908. It has also been reported that this kind of an association was organized in Winnesheik County, Iowa, in 1892.* Wide-spread attention to the subject of co-operative shipping of live stock dates from about 1912, and was based upon the Minnesota work. Prof. W. H. Tomhave, then in Minnesota, who later removed to Pennsylvania State College, gave much publicity to this subject. In 1916 the United States Department of Agriculture published Farmer's Bulletin 718 on "Co-operative Live-Stock Shipping Associations," and this undoubtedly greatly promoted such organizations.

The plan of organizing co-operative shipping associations is comparatively simple. A group of men agree to co-operate in the marketing and selling of their live stock. A constitution and by-laws are framed to provide for officials to represent the management and to look after certain necessary details of organization. The constitution may briefly specify the name of the association, its business headquarters, purpose, and management. It also provides for membership, officers, elections, amendments, and quorum. The by-laws set forth the vital details of business management. The officers usually consist of a president, vice-president, secretary, treasurer, and a board of directors. The latter, as a rule, appoint a manager whose business it is to look after the marketing of the live stock. The following

*Harry R. O'Brien, *The Country Gentleman*, Nov, 15, 1919.

by-laws, with slight change, are the ones suggested in Farmer's Bulletin 718, and without doubt these have been widely adopted by most associations.

PROPOSED BY-LAWS FOR CO-OPERATIVE SHIPPING ASSOCIATIONS

Article I. Delivery for shipping. The shipment of stock in this association shall be made regardless of membership, and the delivery of stock to the manager and the acceptance thereof by him binds the shipper to the rules and by-laws of the association. All who desire to ship stock with the association shall report to the manager the kind of stock, the number of each kind, and the approximate weight of each, when it is ready to be marketed. When a sufficient amount of live stock has been reported to be ready for shipment to make a full car-load, the manager shall order a car for making the shipment, and shall notify each party having stock listed, and state at what time the stock is to be delivered for loading. In case of non-delivery of stock listed for shipment, the consignor should be assessed for the loss to the association, and in event of his not paying the same, should be debarred from all future privileges.

Article II. Section 1. Duties of the manager. The manager shall be at the yard on the day the shipment is to be made, unless he shall have secured a competent substitute, and shall receive all the stock, and weigh, mark and load the same on the car. He shall have charge of and direct the sale of all shipments, and receive all money therefor, and pay the same to the shippers, less his commission and all other expenses incurred in making the shipments, or when so directed send the money by mail to the shippers. He shall furnish a statement to every shipper, showing net weights, prices received, and expenses of shipment. He shall keep on file a complete statement of settlement, together with returns from the commission firm selling the live stock for the association or from the purchaser of the stock. In a book kept for that purpose, he shall keep a record showing the number of cars shipped, and the amount of stock in such cars, during the year. He shall also keep an account of all disbursements and receipts for the association. At the annual meeting he shall furnish a detailed statement of all business done during the year.

Section 2. Compensation of manager. The manager shall receive as compensation for his services the amount of cents per hundred pounds of stock sold by him, and no other compensation from the association, except that he shall have the right to charge for any outlay for materials needed in making partitions to separate the stock in the car and for bedding, said amount to be charged to the expense of the shipment for which it was incurred. In by-laws suggested by the Wisconsin University* we have the following on this subject: "The manager shall receive as compensation for his services (a) the sum of five cents a 100 pounds for cattle; seven cents a 100 pounds for hogs and ten cents a 100 pounds for sheep. Should there be two or more cars in said shipment, the rate on additional cars shall be three cents a 100 pounds for cattle, three and one-half cents a 100 pounds for hogs, five cents a 100 pounds for sheep, or (B) a flat rate of six or seven cents a 100 pounds on all classes of live stock; or (C) a certain amount on each car

*Bulletin 314. Wisconsin Live-Stock Shippers' Association, August, 1920.

(\$10.00 for the first car and \$5.00 for each additional car is conceded to be fair), or (D) an amount for each day, as \$6.00 for the time spent in taking in, loading or accompanying to market a shipment of livestock, and an amount, as \$4.00, for time spent in doing office work."

Section 3. Bond of manager. The manager shall furnish a satisfactory bond, which shall be approved by the board of directors. Said bond shall be for the faithful discharge of his duties.

Article III. Section I. Sinking fund. There shall be deducted on every 100 pounds of weight of sheep and hogs three cents, and for every 100 pounds of live weight of cattle two cents, and the same shall be placed in the sinking fund, to be used for the paying of losses that may occur to any stock from the time it comes into the hands of the manager until final disposition of same is made.

Section 2. Payment for losses. Any shipper whose stock has been damaged by injury while in the hands of the manager shall receive the full amount for the same as though the stock had not been injured, but shall be subject to the same ratio of expense on the shipment. The payment of the damage shall be based on a statement made by the commission firm having charge of the shipment, or by the purchaser of the stock, which statement shall show the amount received for the injured animal and the amount in their opinion, it would have brought had it not been injured. This statement shall be the final basis for settlement. No damage shall be paid for an animal which was not in healthy condition when received at the local yards by the manager.

Article IV. Section 1. Unhealthy stock. All stock which must be sold subject to inspection, except such as has been injured while in a healthy condition and in charge of the manager or any diseased animal, shall be received at the owner's risk, and he shall receive such payment therefor as is received by the commission firm less all expenses figured pro rata on the shipment.

Ohio Farm Bureau live-stock shipping associations are organized as incorporated companies, although transacting their business much in general as is done by independent local associations. In this method a member of a county farm bureau is allowed one share of stock free of expense, but persons not members of the local bureau, to become stockholders, must pay \$30.00. Persons not members of the farm bureau or of the shipping association pay a special sum, as, for example, 10 cents per 100 pounds, on all species of live stock marketed, which money is credited to the operating fund. The sinking fund, which is used to pay operating expenses, and for losses on live stock, is derived from such charges per 100 pounds live weight of cattle, hogs or sheep marketed, as the directors may determine. The managers do all the prorating, while in the independent associa-

tions it is done by commission firms or other salesmen. One great advantage in the Ohio method is that all the companies shipping under the farm bureau federation are assisted in time of trouble with transportation agencies, in securing important legislation, etc., by the state federation officials. Late in 1921 there were about fifty county associations in Ohio working under the farm bureau federation.

The manager of a co-operative live-stock shipping association is largely responsible for the success of the organization. He should be strictly honest, have good judgment in business matters, possess a rather intimate knowledge of the live-stock market, and should be a seasoned judge of animals and their market values. Further, in view of the jealousy and friction so likely to occur among a group of people mutually engaged in business, he should be tactful and gracious in his dealings with others, thus harmonizing interests and making friends for the association. It is also an asset to have a manager of attractive personality, something that is too often overlooked. The manager should visit the farms of members of the association, and, whenever desirable, offer suggestions that will result in improving the stock to be sold through the association. It will also be desirable for the manager to make occasional visits to the markets, that he may keep in touch with conditions there.

The marking of stock of shipping associations is necessary, for in many cases car loads are made up of shipments from more than one person. Each shipper should have a number or some character by which his stock may be marked and so easily identified. There are several methods of marking. An old European custom is to clip Roman numerals 4 inches or so long in the hair on the rumps of cattle. This marking is easily done with either straight or curved blade scissors. Metal ear tags, on which numbers are stenciled, may be used for cattle, hogs, and sheep; but these are not entirely satisfactory, for the reason that the numbers, being small, can

not always be easily read. Hogs are commonly marked with paint that is in striking contrast to the color of the animal. Stripes about an inch wide are made across the back with a common paint brush. A combination of different colors, with variations in arrangement and position on the animals, will allow for giving numerous lots of hogs marks by which they may be easily identified. "In many associations," ac-



Figure 212.—A method of marketing hogs. Note the marks on the back. Reproduced from Bulletin 314 of the Wisconsin Experiment Station.

ording to Farmer's Bulletin 718, "hogs are not marked, but those of each shipper are graded by the manager at the shipping point, and a record of sows, boars, and stags, subject to dockage is kept. In this case the hogs are pooled at the market and shrinkage is prorated on the basis of weight. As a matter of protection to the owners, however, the marking of hogs is strongly advocated; because, in case hogs of a certain mark show that they have been 'stuffed' before

delivery or that they have shrunk excessively or there is a discrepancy in dockage, proper adjustments can be made." Sheep are commonly marked with washable paint, rather than ordinary oil paint, which injures the wool, and can not be scoured out. Combinations of colors and marks on top of head or back may be used, such as will allow for identifying ownership of many animals.

Uniform grading of shipments of live stock is very desirable, if possible. It is quite customary for hogs of the same grade, even though shipped by several parties, to be sold together as one lot, and the settlement afterwards prorated. This method reduces extra labor of weighing different lots.

The sinking fund of the co-operative shipping association as set forth in the by-laws is for the purpose of paying for losses incurred while live stock is in the hands of the association. It is in the nature of an insurance fund. A common custom in creating this fund is to deduct two cents per 100 weight on cattle and 3 cents on hogs, sheep, and calves. There are exceptions to this plan, however, as, for example, a certain per cent of the proceeds of shipment may be charged, 2 per cent being a fair amount.

The expense of co-operative shipping varies with the local conditions, the distance from the market, and the section of country where transportation takes place. Figures compiled in Wisconsin* relating to seventy associations show home expenses, including manager's salary, labor, incidentals, and sinking fund contribution, to amount to \$25 per car; the freight expense averaged \$38 per car, while the terminal market charges show that for selling, commission, yardage, feed, and bedding, the average expense was \$30 per car, or a total of \$93. The Wisconsin authorities estimate the expense of marketing a car load of live stock of that state to range from \$50 to \$150 or from 2½ to 7½ per cent of the value of the live stock. The 1917 experience of 203 Minnesota associations showed the cost of central market expenses

*Bulletin 314, Wisconsin Agricultural Experiment Station.

and freight to be \$34.15 per car load, and home expenses \$16.50, a total per car of \$50.65.*

Original

**Live-Stock Shipping Association
Member's Statement**

_____, No. _____, 192_____

Account of _____ P. O. _____ R. F. D. _____

No.	Kind	Shrink Gain	Dock	Market weight	Price	Amount	Total
				Expenses	Rate	Amount	
				Hogs			
				Calves			
				Cattle			
				Sheep			
				Membership			
						Total	

Inclosed find check No. _____ for balance \$ _____

Please ask about anything not understood. Complete statement of each shipment is on file.

Manager _____

Figure 213.—Sample of Member's Statement in a live-stock shipper's association.

The advantages from selling live stock co-operatively are considerable. There is no expense for soliciting business, and the method does away with unnecessary stock buyers in a community, reducing the number to one paid employe. One of the main arguments in favor of co-operative marketing is the reduced cost of selling due to the fact that one person in a community represents the producers in this respect. Estimates from managers of 150 Wisconsin associations have

*Farmers' Co-operation in Minnesota 1913-17. Bulletin 184 Univ. of Minnesota.

placed the savings in shipping from 20 cents to \$2.50 per hundred weight, and from \$15 to \$250 a car. The great majority of estimates lie between \$50 and \$150 a car, and, on the basis of the lower figure, this estimate would indicate a saving of \$1,500,000 a year to the members of the 150 associations.* Mr. G. W. Hurlbert, of Iowa, in reporting on shipping associations in that state,† says it is estimated that in 1918 300 associations in Iowa shipped \$75,000,000 worth of live stock. "If," says Mr. Hurlbert, "the farmers saved only \$0.25 to \$0.85 per 100 pounds, the total saving would be around \$2,500,000. The total business of all the live-stock shipping associations for 1918 is estimated at \$500,000,000. That sum means that a total saving of about \$10,000,000 was made by the farmers of the country in that year by the co-operative shipping of live stock."

Another great advantage in co-operative shipping is the protective side of the sinking fund and reimbursement for animals that die or are injured enroute. Where under old conditions an animal might be nearly an entire loss to the shipper, by the co-operative method he is saved a large amount through the sinking fund.

Members of co-operative associations are usually in closer touch with the market, and thus more familiar with comparative values than non-members. They check up on the manager and show an interest in results from the sales of others as well as themselves.

A difficulty associated with co-operative marketing is holding the members together and supporting the organization. Prof. H. E. Erdman writes:§

"Not only do co-operators gain by collective sale, but non-co-operators as well usually obtain higher prices, since competitors are spurred on even to the extent, at times, of over-bidding. Here, in fact, is one of the biggest weaknesses of collective selling as well as of collective buying. It is very difficult to hold an association together for collective dealing when members see that non-members get as good rates as they, with no dues to pay. The real ques-

*Bulletin 314 Wisconsin Agr. Exp. Station.

†Hoard's Dairyman, December 5, 1919.

§Bulletin 342 Ohio Agr. Exp. Station. Organizations among Ohio Farmers.

tion, however, is not whether farm prices are higher than before the introduction of collective selling, but rather whether collective selling provides selling service at lower rates than similar services would be performed under competition. The answer is usually yes, provided such selling is efficiently done."

SUBJECTS FOR REVIEW

1. When the first live-stock shipping association was organized.
2. Conditions of delivery for shipping.
3. The duties of the manager.
4. The compensation of the manager.
5. Conditions under which losses are paid.
6. How the Ohio federation system differs from the independent one.
7. Methods of marking live stock for shipping.
8. The expense of co-operative shipping.
9. Financial savings from co-operation.
10. A weakness in the co-operative method.

SUGGESTIONS FOR INVESTIGATION

11. Compare the constitution and by-laws of different associations.
12. Visit one or more local associations and study their work.
13. Which is more satisfactory, settlements for losses through regular dealers or through association management?
14. What forms of marking are most popular locally?
15. Interview ten patrons and ascertain their experiences.
16. Is co-operative shipping growing in favor locally or not? Why?

CHAPTER XXXIX

TYPES AND BREEDS OF POULTRY

A classification of domestic poultry includes a number of different kinds, each consisting of a group with its types and breeds. The following is a classification commonly used.

- | | |
|-----------------------|---------------|
| 1. Fowls and chickens | 5. Pheasants. |
| 2. Turkeys. | 6. Ducks. |
| 3. Guineas. | 7. Geese. |
| 4. Peafowls. | 8. Swans. |

FOWLS

The types of domestic fowls may be classified into four groups, namely:

- | | |
|----------------|---------------------|
| 1. Egg-laying. | 3. General-purpose. |
| 2. Meat. | 4. Ornamental. |

For some time poultry students have discussed these types, but more especially three, which from a practical point of view are the only ones of interest to the farmer. These three are the laying, the meat, and the general-purpose fowls. Good examples of each of these types are common all over the country. The other three types are rarely raised on the farm, being the product of the fancier, who oftentimes has his poultry outfit on a town lot. The breeds are also sometimes divided into two classes, sitters and non-sitters, according to whether or not the hens have the desire to sit on and hatch a nest of eggs.

The egg-laying type of fowl, according to Prof. H. R. Lewis,* should show a well balanced, deep, nearly rectangular body, well developed in breast and abdomen. Great

*Judging Fowls for egg production. Hints to Poultrymen, vol. 8, No. 2. New Jersey Agricultural Experiment Station. 1919.

depth of body is especially desirable, but apparent depth must not be due to loose feathering, which is generally shown by an evidence of loose thigh feathers. Large capacity is essential, if a hen is to lay long and heavily. Such capacity is designated by a body that is deeper at the rear end of the keel than at the front end. The underline should be fairly straight and the back should be comparatively horizontal. Prominent breast development and evidence of a long keel are desirable qualities in a high-producing hen. The general body conformation of a heavy producer con-

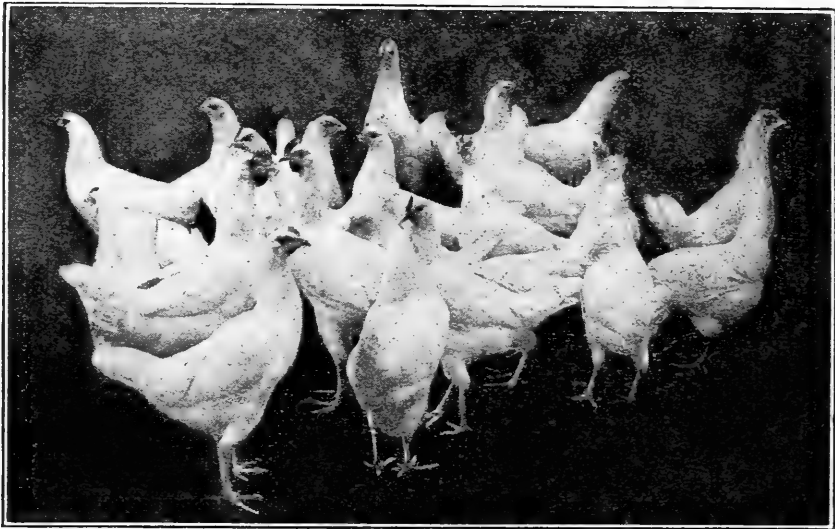

Figure 214.—The egg-laying type of fowl. Photograph from *Poultry Herald*.

forms very closely to a rectangle with pronounced angles rather than smooth curves. A male shows the same general characteristics as a female except that the abdomen is not so deep. Fowls of this type vary somewhat in size and weight as well as in flesh-producing capacity. The Leghorns are small, the hens weighing around 3 pounds, and do not produce much meat on the body, while the Minorcas are larger, the hens weighing about $6\frac{1}{2}$ pounds, and may carry a good amount of flesh when in best condition. The fowls

of this type are of European ancestry and are usually known among poultry specialists as the Mediterranean breeds.

The meat type of fowl is said to be comparable to the draft horse, beef cattle, mutton sheep, and the fat hog. It is squarely built, compact, thickly fleshed, wide of back and breast, and heavy of limb. Fowls of this type, when fat, have a carcass thickly covered with meat, and are especially valued for roasting. The hens, as a rule, are of sluggish disposition and are inferior egg-producers. The meat-type fowls sometimes weigh 10 to 12 pounds. They are of Asiatic origin, and are represented by the Brahma, Cochin, and Langshan breeds.

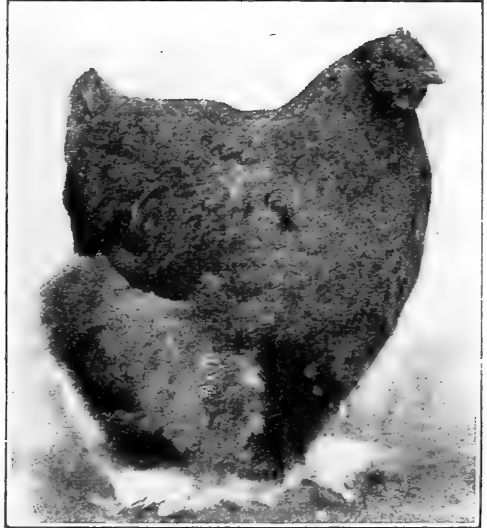

Figure 215.—Meat-type of fowl. Photograph from *Poultry Herald*.



Figure 216.—General-purpose type. A White Plymouth Rock. Photograph from *Poultry Herald*.

Asiatic origin, and are represented by the Brahma, Cochin, and Langshan breeds.

The general-purpose type of fowl, as might be supposed, is valued for both egg and meat production. This type is medium in size, has considerable fullness of breast and width of back, and fattens to advantage. In egg production some general-purpose breeds have excellent records.

Standard weights vary, but 7 pounds for the hens and 9 for the cocks are satisfactory. Fowls of the general-purpose type, as a rule, belong to the American breeds, of which the Plymouth Rock, Wyandotte, and Rhode Island Red are the most common examples.

The breeds and varieties of fowls include a large number of wide difference, ranging from the tiny Bantam to the large and heavy Brahma. The breed characters of form, as applied to head, body, and legs, are rather distinct in each

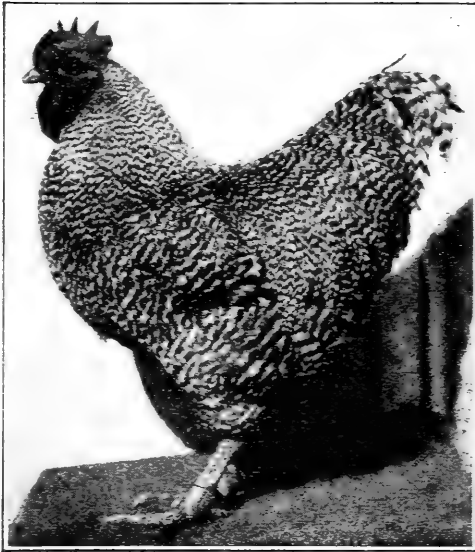

Figure 217.—Barred Plymouth Rock cockerel, 1st prize at Indianapolis. Photograph from *Poultry Herald*.

case. The variety characteristics are usually shown in color of feathers, though there may be other special features, such as single or rose comb. The Plymouth Rock, for example, includes six varieties; namely, (1) barred, (2) white, (3) buff, (4) silver penciled, (5) partridge, and (6) Columbian. The following very brief descriptions of some of the leading breeds in America, include the more important representatives of each.

The Plymouth Rock originated in America, and is of medium size. The head is surmounted by a single, upright red comb, and the ear lobes and wattles are also red. The neck is broad, breast full and wide, back broad, and body compact. Beak, legs, toes, and skin should be yellow in color. This breed is hardy and matures early, furnishing excellent broilers when eight to twelve weeks old. The hens are moderate layers, the eggs being of a brown color. This is a sitting breed, and the hens make excellent mothers.

The mature males weigh $9\frac{1}{2}$, and the females $7\frac{1}{2}$ pounds. Varieties of this breed differ only in color of feathers.

The Wyandotte originated in America, and is of medium size, with a form very similar to the Plymouth Rock. These two breeds look very much alike when fowls of the same color are compared. The Wyandotte, however, should have an outline of form somewhat shorter and deeper in its lines than the Plymouth Rock. This breed has a rose comb instead of a single form, and red ear lobes and wattles. The legs are yellow. Wyandottes are excellent layers, but their eggs are of small size, brown in color. These fowls are valued for broiling and roasting, for their flesh is of fine grain and quality. The mature males have a standard weight of $8\frac{1}{2}$ pounds and the females $6\frac{1}{2}$ pounds. Wyandottes are extremely popular.

The Rhode Island Red derives its name from the fact that it originated in the state of Rhode Island.

The American Standard of Perfection, in referring to these fowls, states that "their chief characteristics are: red color, oblong shape, compact form, and smooth surface plumage." This is a medium-sized breed, mature males weighing $8\frac{1}{2}$, and the females $6\frac{1}{2}$ pounds. The comb is either single or rose in form, and of medium size. The shank and feet should be yellow or reddish horn in color. This breed has become quite popular on account



Figure 218. White Wyandotte cockerel. First prize at Utica, N. Y. Photograph from *Poultry Success*.

of its merit as a table fowl and for egg production. The Rhode Island Red, however, is more or less criticized for lack of uniformity in plumage color and excessive broodiness during the spring season.

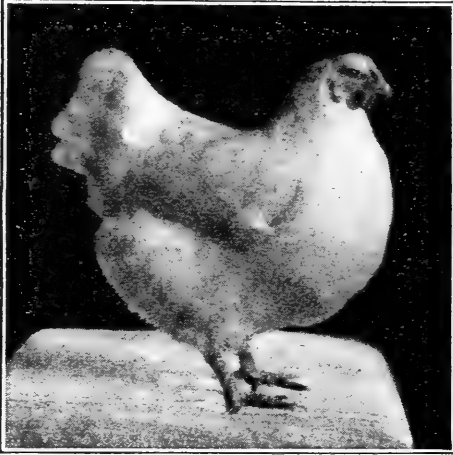

Figure 219.—White Orpington hen.
Photograph from *Poultry Herald*.

is white with a tendency to pink tint, and black or flesh-colored legs. The comb may be of the single or rose form. The ear lobes are red. There are three varieties, white, black, and buff. The mature males weigh 10 and the females 8 pounds. The Orpington in recent years has become very popular, ranking high for table use and for egg production. Hens of this variety tend to be unreasonably broody.

The Leghorn is a breed of European origin, getting its name

The Orpington was first developed in the town of Orpington, England, from which it receives its name. There is no great difference between this breed and the general-purpose American breeds, except that the Orpington is somewhat heavier, and has skin that

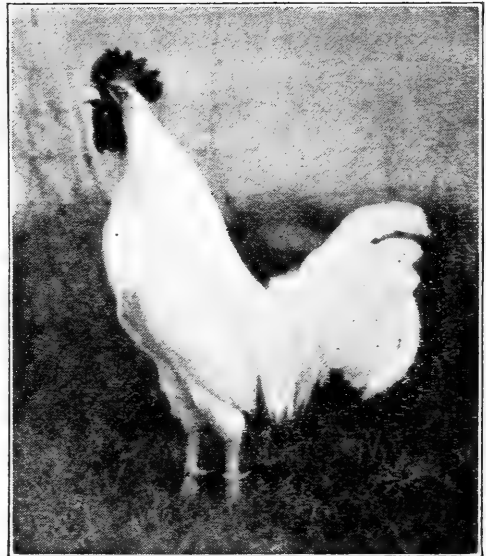

Figure 220.—A vigorous White Leghorn cock at Cornell University. Eleven of his daughters averaged 197 eggs each in a year. Photograph from Dr. O. B. Kent.

name from Leghorn, Italy. This is distinctly an egg-laying breed. The features of importance are large, single, or rose comb, the single comb on the hens drooping to one side. The head is small, the eye of good size, ear lobes white, comb and wattles red, and beak, legs, and skin yellow. The breast is prominent, though not very wide; the back of medium width and length, the feathers snugly laid to the body, and the tail carried at an angle of about 45 degrees. The Leghorn is very hardy and one of the most active breeds of fowl, rather small of size, and famous for egg production. The females are non-sitters. There are several varieties of Leghorns, of which the white, brown, and buff are most common. Mature males weigh about 4 pounds and females 3. This is one of the most common breeds kept on American farms; in fact, it is almost universally the one that is used especially for egg production on a large scale.



Figure 221.—Minorca cockerel.
Photograph from *Poultry Herald*.

The Minorca is an egg-laying, non-sitting breed, originating on the island of Minorca in the Mediterranean sea. The following is quoted from the American Standard of Perfection: "They are distinguished by long bodies, very large combs, long full wattles, large white ear lobes, dark colored legs, and pinkish-white or flesh-colored skin. The Minorca head is carried rather high; the back is long and sloping; the tail is spread somewhat and only moderately elevated, being carried at an angle of 40 degrees from the horizontal. Their legs are firm, muscular, and set squarely under the long, powerful-looking bodies." There are both single and rose comb strains of this breed. Notable egg producers, the Minorcas rank as a close second to the

Leghorns and, furthermore, they are known as the breed producing the largest egg, which is white in color.

The Light Brahma is of Asiatic origin, and has been known in America for many years. It is strictly of the meat type, and is the largest breed of fowls, the mature males weighing 12 pounds and the females 9½ pounds. The head is of medium size, with a small pea comb, medium-sized red wattles, and large red ear lobes. The breast is very broad and full, the back wide, the legs, toes, and skin yellow, and the shanks feathered. The neck, tail, and large wing feathers are black, and white striped with black, the other feathers being white. This breed is valued for roasting, but does not rate high in egg production. There is another variety called the Dark Brahma, but neither of these varieties is longer popular, and but few flocks are now kept, although they once were common.



Figure 222.—Light Brahma hen, Lady V; first at Chicago. Photograph from *Poultry Herald*.

The Cochin is also an Asiatic breed, large in size, like the Brahma, a standard weight for males being 11 pounds and for females 9½ pounds. This is a deep-bodied, massive fowl, having a loose plumage with much downy fiber underneath, which gives the entire body a fluffy appearance. The legs are heavily feathered. These fowls are valued for roasters rather than for egg production. There are four varieties of Cochins, buff, black, white, and partridge.

The Langshan is a single-combed Asiatic breed, somewhat smaller and more active than the Brahma or Cochin, and much more popular, both for meat and for egg production. There are two varieties, the black and the white.

The males weigh $9\frac{1}{2}$ pounds and the females $7\frac{1}{2}$ pounds, at maturity. There is much fullness of breast, and the form is compact. The legs of the black variety are bluish colored, and slightly feathered. The comb, face, wattles, and ear lobes are bright red in color.

There are many other breeds and varieties of fowls, but these are usually kept only in a small way by poultry fanciers and do not need attention here.

The bantam may be a dwarf of some of the larger breeds or a distinct breed. Bantams are kept for ornamental purposes, and have no practical value. The weights naturally vary somewhat, but 26 ounces for mature males, and 22 ounces for the females are standards. The Cochin and Brahma bantams weigh slightly more, 30 ounces for the male and 26 for the female. The bantams make very interesting pets for children.

THE TURKEY

The turkey is a native of America and was unknown in Europe previous to 1624. The present domesticated turkey originated from the wild stock which once was found in large numbers in this country, and is yet found to a small extent in certain parts of Pennsylvania and the southern states. According to the Standard of Perfection of the American Poultry Association, the frame of the turkey should be large, the body deep, "with a broad, round, full breast that varies in prominence according to the variety." The head should be of good size, and the eyes bright and alert. The leg and shank bones should be large, straight, and well set. The carriage should be proud and erect. There are but few breeds of turkeys, and but one that may be regarded as common.

The Bronze turkey is very large, and the feathers are bronze or brown black, with shadings of color. The standard weight for an adult male is 36 pounds, and for the hen,

20 pounds. This is the most common variety raised.

The Narragansett turkey is of a metallic black color, with shadings to steel gray or approaching white. Mature cocks weigh about 30 pounds and hens 18 pounds.

The White Holland turkey, as its name indicates, has a white plumage. The beard of the male, however, is a deep black in color. Mature cocks weigh about 28 pounds and hens 18 pounds. This is not as hardy a variety as the Bronze or Narragansett, but its flesh is highly regarded, and it is the most domestic and easily controlled of all the breeds.

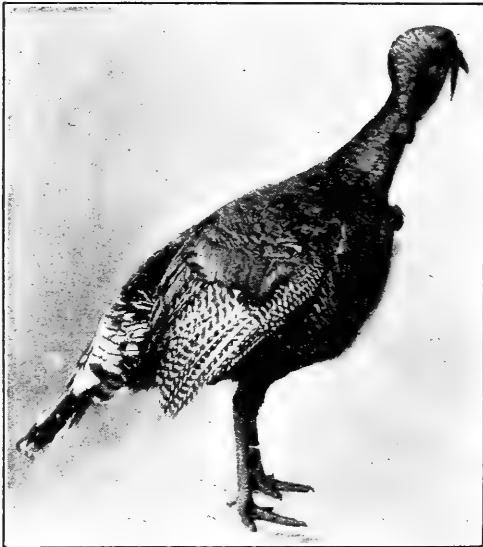

Figure 223.—A Bronze turkey. Photograph from *Poultry Herald*.

The Bourbon Red turkey is a native of Bourbon county, Kentucky, and is supposed to have originated from what in early days in Kentucky was known as the wild yellow turkey. The neck, breast, back, body, and fluff of this breed are of a deep,

brownish red. It has about the same weight as the Narragansett, the males weighing about 30 pounds and the hens 18.

THE DUCK

The Mallard, or common wild duck, is regarded as the parent stock, or ancestor, of all domestic ducks. This duck has a broad flat bill, small eye, good-sized head, long neck, full breast, long body, short tail, and short web-footed legs. The body has a dense covering of downy feathers, over which lies the feathery plumage. The thick plumage, which is

characteristic of water fowl, is oiled by a natural secretion, which prevents water from penetrating among the feathers.

Three types of ducks are recognized, meat, egg-laying, and ornamental. Those which best supply the needs of the table for meat are most in demand.

The Pekin duck was brought to England from Pekin, China, in 1874. It is white in color and of large size, weighing 7 to 9 pounds, and is the most popular duck for table use. The bill is orange-yellow in color, while the shanks and toes are reddish orange. The Pekin duck may be re-



Figure 224.—Pekin ducks on a Rhode Island farm. Photograph by Chas. X. Arnold.

garded as the universal favorite where duck culture is conducted on a large scale in the United States.

The Aylesbury duck is white and much resembles the Pekin. The bill is flesh-colored, and the legs and feet are pale orange. The standard weight is the same as the Pekin. These ducks are more popular in England, where they have been bred many years, than they are in America.

The Rouen duck is a breed that takes its name from a city in northern France, where it has long been bred. It is grayish in color, with dark shadings or black on head, neck,

wings, and back. The bill is of greenish-yellow color, and the legs and feet orange with a green or brown shade.

The Cayuga duck originated in Cayuga County, New York. It is greenish-black in color, except some of the large wing feathers, which are brown. The bill is black, and the legs preferably black, though slate color occurs.

The Muscovy duck is a native of South America. In size it is very large, adult drakes weighing 10 pounds and females

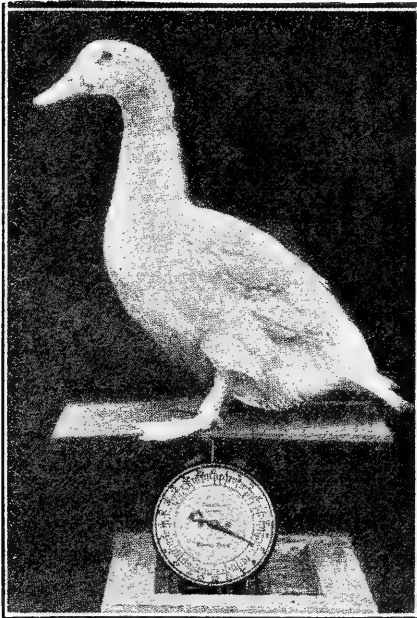

Figure 225.— A "rapid growth" Pekin Duck eight weeks old. Reproduced by courtesy Cyphers Incubator Company.

7 pounds. The body is long and broad, and is carried nearly horizontally. The head is rather long, and large with the male, and has large crest-like feathers, which the duck often raises when excited. The head is partly bare of feathers, and the sides and top above the bill have rough wart-like coverings known as caruncles, which are red of color and rather conspicuous. The bill is pink or flesh-colored. Colored Muscovies have yellow to dark lead-colored legs, while those of the white variety are yellow. The plumage

varies in color, but white or black-and-white are the favorite varieties. Ducks of this breed fly much more than others, and sometimes perch on elevated places.

The Indian Runner duck is supposed to have originated in India. It is rather small, a standard weight being about 4 pounds at maturity. The body, which is long and narrow, is carried somewhat erect, after the style of the wild penguin. The popular color is fawn or gray and white.

The claim is made that the young ducks at 6 weeks of age dress into broilers weighing $2\frac{1}{2}$ to 3 pounds. This duck, however, is valued chiefly for egg production, a female occasionally laying as many as 200 eggs in a year.

THE GOOSE

The domesticated breeds of geese have been developed from the wild breeds, but more especially the common Canadian wild goose, which is often domesticated and kept in confinement. So common is this wild goose in confinement that it is standardized in the American Poultry Association Standard of Perfection. It has a black head with white stripe, a gray body, and adults weigh from 10 to 12 pounds. There are several breeds of importance.

The Embden goose is of European origin. It is of medium size, adult ganders weighing about 20 pounds. The bill and legs are orange in color, and the plumage is white. This is a very popular breed.

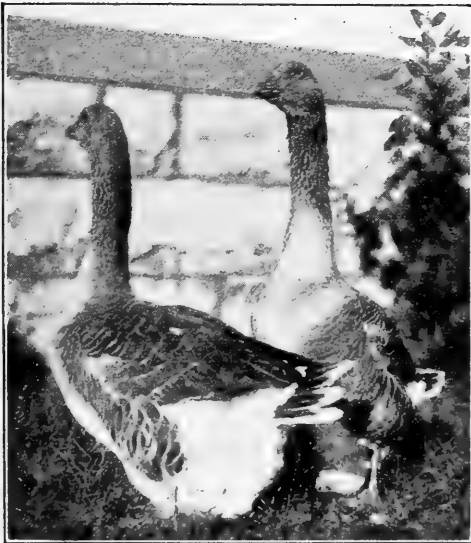

Figure 226.—Toulouse geese. Photograph from *Poultry Herald*.

The Toulouse goose gets its name from a city of that name in France. It is of large size, adults weighing about 25 pounds. The bill is pale orange and the legs a deep shade of that color. The plumage is gray, with dark shadings about the neck, back, wings, and breast.

Most of our domestic flocks of commercial importance consist of these two breeds.

SUGGESTIONS FOR REFLECTION

1. What makes the six types of domestic fowls?
2. Describe the egg-laying type of hen.
3. What is the difference between a breed and a variety?
4. Compare the Plymouth Rock and the Wyandotte.
5. Compare the Light Brahma and the Leghorn.
6. Name the place of origin of each of five breeds of fowls.
7. Discuss the origin of the turkey.
8. What are common features of different breeds of ducks?
9. Compare the Pekin and Rouen ducks.
10. What are some of the most striking characteristics of the Muscovy duck?

DO YOU THINK YOU COULD

11. Give the names of five men keeping pure-bred poultry in your neighborhood, and the breeds they keep?
12. Bring a small collection of eggs of different breeds to school?
13. Interest local poultrymen to arrange a small poultry show for the benefit of the school?
14. Weigh some specimens of live poultry of different breeds and report on the age and weight of each?
15. Bring to school specimens of feathers showing breed colors?

CHAPTER XL

JUDGING POULTRY AND POULTRY PRODUCTS

The poultry judge who understands his work must be familiar with many details. There is in this country an

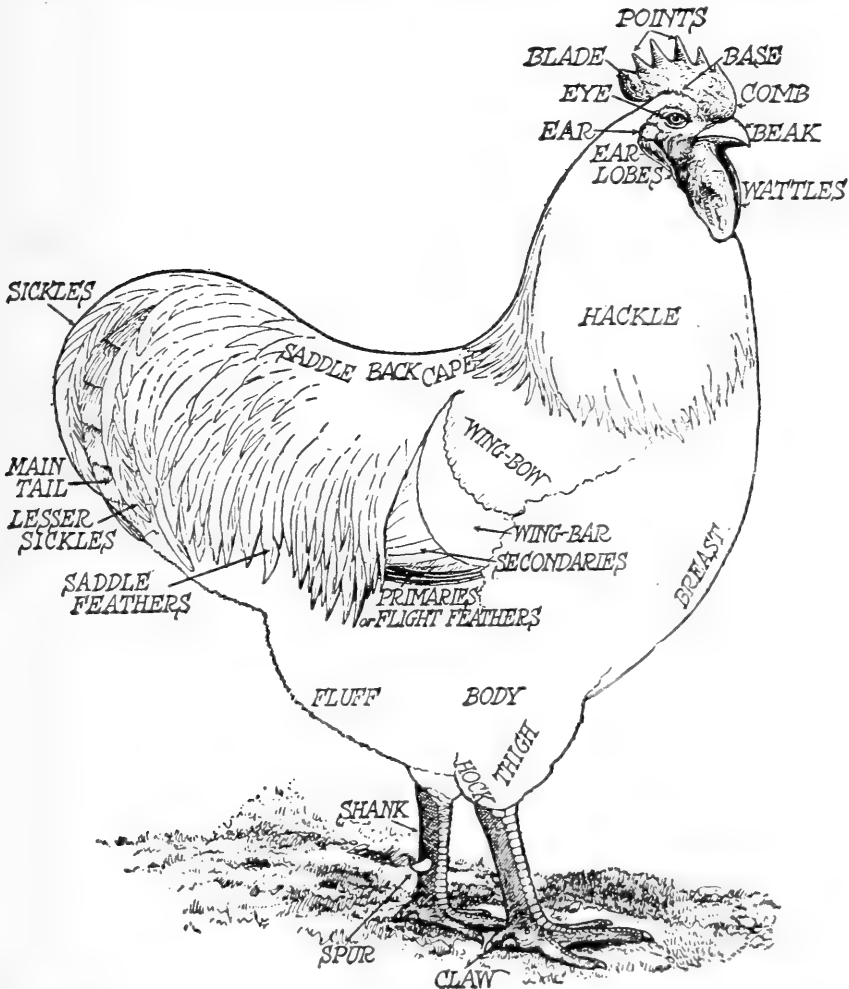

Figure 227.—Diagram of the exterior of the fowl. Reproduced from Farmer's Bulletin 806, United States Department of Agriculture.

organization known as the American Poultry Association. This devotes much attention to the establishment of stand-

ards of perfection for the various breeds and varieties of fowls, and provides rules and methods for judging fowls. A book published by the association, known as the "Standard of Perfection," is the American authority for judges and students to follow. No poultry show in which the breeds and varieties are exhibited could be properly conducted without the judge's being guided by this standard. No breed of fowls can be regarded as established until officially recognized and described by the American Poultry Association.



Figure 228.—White Leghorn cockerel showing single comb points. Photograph from Prof. F. S. Jacoby.

The parts of the fowl passed on by the judge have certain outlines, colors, and other markings as applied to each breed. The feathers differ in size and form in a striking way, according to their location on the body. The illustration of a male bird on page 473 shows, through a numbering system, the location of the parts and feathers.

The head of the fowl is one of the striking breed features. It is topped with a comb, which is larger on the cocks than on the hens. A very common form is single, upright or lopped, the top being serrated, or separated into points suggesting the teeth of a saw. Leghorn and Plymouth Rock varieties have this form. The rose comb is wide and low, consisting of many knobs crowded together, the rear part

tapering more or less to a smooth point. This comb occurs on Wyandottes, Minorcas, and other varieties. The pea comb is very small, and resembles three single combs dwarfed in size and crowded side by side, with the central one somewhat larger than the others. There are also V-shaped and strawberry combs, but these are not common. The ear lobes are usually small, and vary in color from red to white or bluish, according to breed. The wattles are usually red, and on the cock often hang below the bill in a conspicuous manner. The bill does not show the striking differences



Figure 229.—A rose comb.

seen in the comb and wattles. Some breeds, like the Houdan and Polish, have crests, or clusters of feathers, which sometimes largely hide the head proper from view and also often affect the sight of the birds.

The feathers of the fowl differ in a remarkable way in size, form, and color. Even with varieties of one color, as, for example, white, the shades of this hue are made a subject of discussion by poultry experts. This difference also applies to other solid colors.



Figure 230.—Outstretched wing showing barred feathers of the Plymouth Rock. Photograph from Prof. F. S. Jacoby.

In case of fowls having more than one color-marking to the feather, there are barred feathers, as with the Plymouth Rock; penciled feathers, as

more than one color-marking to the feather, there are barred feathers, as with the Plymouth Rock; penciled feathers, as

with the Silver Penciled Wyandotte; laced feathers, as with the Golden Wyandotte; and still other markings, as striped, spangled, edged, etc. The color-markings of some birds are very beautiful. The correct color and form of the feather are of most interest to the fancier; yet the practical poultryman little interested in this feature has been able to secure his favorite breed through patient breeding, development, and improvement by the so-called fancier.

Methods of judging. The breeds and varieties of fowls are ordinarily judged by one of two methods, the score card or by comparison. In recent years utility classes have been exhibited at poultry shows, and this fact has introduced another phase of judging where egg production is an important factor. The score-card method of judging has been generally used at poultry shows for many years. Its use, however, is not so common now as formerly. Poultry judges using the score card put down the number of points or fraction of a point cut, and adding these, deduct from 100, which gives the total score. In cutting for defects from $\frac{1}{2}$ to 3 points are recommended for certain deficiencies, and these are specified in the standard for the benefit of official judges. Judging by comparison is becoming common, and is more satisfactory than by score card, for the reasons already given in Chapter XIII.

Instructions for judges of poultry include various points. Among these, weight receives considerable attention, and two points are usually deducted for each pound that the fowl falls short of the standard weight. Other things being equal, the one nearest standard weight is awarded the prize. To receive a first prize, a specimen must score 90 or more points, except cocks in parti-colored varieties, which are allowed 88 points as a minimum. When young and old birds are in competition, other things being equal, the older ones are to be awarded the prizes. Ties often result in judging. When a tie occurs, if it can not be broken by other rules, then the

specimen receiving the smallest total sum of cuts for *shape* shall be awarded the prize.

The official score card of the American Poultry Association is here given:

.....
(Name of association here)

.....
(Date, month, days and year show is held)

OFFICIAL SCORE CARD OF THE AMERICAN POULTRY ASSOCIATION

EXHIBITOR.....

VARIETY.....Sex.....

ENTRY No.....BAND No.....WEIGHT.....

	Shape	Color	Remarks.
Symmetry.....			
Weight or size.....			
Condition.....			
Comb.....			
Head.....			
Beak.....			
Eyes.....			
Wattles and ear lobes.....			
Neck.....			
Wings.....			
Back.....			
Tail.....			
Breast.....			
Body and fluff.....			
Legs and toes.....			
†Crest and beard.....			
*Shortness of feather.....			

Total cuts.....Score.....

..... JUDGE

..... SECRETARY

†Applies to crested breeds. *Applies to games and game bantams.

This score card is intended for use in connection with the Standard of Perfection, which contains a detailed description of each variety of fowl.

Disqualification in judging poultry is allowed for various reasons. The occurrence of feathers on the legs of what should be a smooth-legged breed; or of smooth legs when feathers should occur; irregular color of ear lobes and legs or of the plumage; web feet and excessive number of toes or too few toes; incorrect position of the comb, as, for example, lopping when it should be erect; absence of crest in crested varieties are examples of conditions which justify disqualification.

Judging fowls for utility has received special attention at poultry shows since about 1915. In the utility classes the birds are to be brought forward for show when at the height of egg production. This practice is not the case with ordinary exhibition birds, for they are shown just prior to beginning production, when in their finest plumage. Only standard-bred fowls are shown in each class, but in the utility group less consideration is given to plumage and more emphasis is paid to body form and evidence of egg production. A score card for utility judging was drawn up in November, 1919, at a conference of poultry specialists at Vineland, New Jersey, based on a careful study of 1,000 yearling hens in the International Egg-Laying Contest.

"In working out a production score card," writes Professor Harry R. Lewis*, the idea has not been to develop a score card which should be used in placing premiums at utility shows, but rather to develop numerical values for the various sections of the bird, in order that utility judges and exhibitors may have a common working basis, that is, in order that the exhibitor in picking his birds may have a more or less accurate idea of what the judge is going to look for in determining the relative values which he will give the various sections and qualities. In working out the numerical values for the score card the perfect bird was recognized as 100 per cent, which was allowed to be equivalent to a production of 300 eggs. Numerical values for all sections were then so arranged that each per cent of value is equivalent to three eggs or, put differently, a cut of one point in any one section is equivalent to a cut of three eggs."

The following score card for utility judging is based in principle on much of the work developed at the Cornell University judging school during 1918 and 1919.

*Judging fowls for egg production, Hints to Poultrymen—Vol. 8, No. 2, New Jersey Agricultural Experiment Station, 1919.

SCORE CARD FOR JUDGING UTILITY HENS AND PULLETS

Parts scored	Perfection	Egg production value
Body type(as seen in coop or on floor)	25 points	75
Head and adjuncts	15 "	45
Body conformation (as determined by handling)	30 "	90
Handling quality	10 "	30
Legs and toes	5 "	15
Condition	15 "	45
	100	300
Total for perfection	100 "	300

The following discussion is given as explanatory of the application of the score card in utility judging.

BODY TYPE

Perfect Score—25 Points, 75 Eggs

A bird of good body is usually well-balanced in that the body itself must be deep, showing a nearly rectangular form, well developed in breast and abdomen. Great depth of body is especially desirable, but apparent depth must not be due to loose feathering, which is generally shown by an evidence of loose thigh feathers. Cochins and exhibition game type and feathering are usually associated with poor production. Large capacity is essential if a hen is to lay long and heavily. Such capacity is designated by a body that is deeper at the rear end of the keel than at the front end. The underline should be fairly straight and the back should be comparatively horizontal. Prominent breast development, with evidence of a long keel are desirable qualities in a high-producing hen. The general body conformation of a heavy producer conforms very closely to a rectangle with pronounced angles rather than smooth curves. A male shows the same general characteristics as a female except that the abdomen is not so deep.

A small-capacity hen generally stands erect. The body is either very shallow and cut away at the breast and abdomen or, in the case of beefy individuals, the abdomen shows a pronounced sagging at the rear of the keel due to large accumulations of fat. Extremely poor producers frequently show a hump on the back.

HEAD AND ADJUNCTS

Perfect Score—15 Points, 45 Eggs

One of the best indications in picking high layers is the fineness of the head. The head of the heavy producer is fine, showing a lean face, free from wrinkles and overhanging eyebrows. The wattles and ear lobes fit close to the head and are not loose and flabby. The face is clean cut, the eye is full, round and prominent, especially when seen from the front. An eye which gives a clean-cut wide-open appearance is desirable. The eyeball of the heavy producer is generally set in the rear of a large oval socket, showing considerable of the white eye membrane in front of the eyeball. The head of a heavy producer should be well balanced, being moderately deep and broad. The extremely fat, full head of the beefy bird and the long, thin pointed head of the low-vitality birds are both undesirable and should call for heavy cuts in this section. The low-producing bird generally shows a depressed eye with over-hanging

eyebrows and wrinkled skin at the back of the eye. The extremely long sharp beak is usually possessed by the low producer, while the medium stout, well-curved beak is characteristic of the high producer.

BODY CONFORMATION

Perfect Score—30 Points, 90 Eggs

When taken in the hands, a heavy producer will show, by the sense of touch, great depth of body, especially at the front and rear of the keel bone. The keel must be moderately straight, relatively long and carried well back. The space between the pelvic bones and the keel must be free from excessive accumulations of fat. Birds which are laying heavily can be readily detected by the development of the abdomen. Such birds will show pelvic arches which are widespread and a keel which is forced down away from the pelvic arches so as to give large capacity.

The poor producer generally shows a shallow body especially at the front of the keel, a small shrunken abdomen, together with all evidences of small capacity.

HANDLING QUALITY

Perfect Score—10 Points, 30 Eggs

The skin of the heavy-producing hen is thin, soft and pliable, especially the skin on the abdomen must be thin and loose. The skin of the poor producer is generally thick, hard and rather coarse to the touch. The thin velvety skin is almost always associated with heavy ovarian activity.

LEGS AND TOES

Perfect Score—5 Points, 15 Eggs

The shanks of a heavy producer are flat, pliable and smooth scaled. In hens at the end of their laying year, or pullets which have been laying heavily for some time, the shanks will be bleached out. The toes should be straight and the toenails show indication of proper activity. The shanks of the poor producer are usually round, hard and rather coarse scaled.

CONDITION

Perfect Score—15 Points, 45 Eggs

A bird to be capable of highest sustained production must be first of all healthy. She must show vigor and activity and be well fleshed. Late molting in hens is desirable. Early molting and slow maturing, as shown by the primary feathers, should be cut severely. Late developing and late maturing usually indicate low production. In applying this section to hens, health and molting conditions should be given primary consideration. In applying this section to pullets health and maturity should be given primary consideration.

Judging poultry products, such as dressed poultry and eggs, is becoming more and more necessary. The score card is not specially recommended for this purpose, the comparative method being very generally regarded as the most satisfactory. Referring to this point, one authority says:

“In judging dressed poultry and eggs, the number of qualities or points to be considered is small; slight differences in quality do not make great differences in value, as in high-class birds, and degrees of quality are more readily appreciated. While score cards are sometimes used for judging dressed poultry and eggs, the number of sections into which a card may appropriately be divided is so small that there is little if any advantage in scoring, and if, to develop a system of scoring, many sections are made, the process of judging is complicated when it should remain simple. The points to be considered are so few, and the values so apparent, that judgment of all is practically instantaneous. * * * The rational method of judging dressed poultry and eggs is to grade them according to market quality and value.”

The judging of eggs by score card has been attempted to some extent. An egg show, in which eggs were scored by the students, has been held annually at Purdue University. Two classes of eggs were provided, “fancy” and “commercial.” The following score card and explanation of its use are well worth consideration:

COMMERCIAL EGG SCORE CARD.

EXHIBITOR.....DATE.....192...
 ADDRESS.....COLOR.....
 ENTRY No.....CLASS.....WEIGHT.....Ozs.

Features considered	Perfection	Cuts	Remarks
Size.....	25
Shape.....	4
Uniformity of color.....	8
Uniformity of size and shape.....	5
Shell texture.....	4
Condition of shells.....	4
Quality (by testing)			
(a) Size air cell.....	25
(b) Opaqueness.....	25
Total points.....	100

.....JUDGE
SECRETARY.

Explanation of Commercial Egg Score Card

Size: Extras, 26 to 28 ounces. Firsts, 24 to 26 ounces. One point cut for each ounce over or under required weight in either class.

Shape: $\frac{1}{3}$ point allowed for each egg.

Uniformity of color: If white, eggs should be all pure white and of the same shade. If brown, the color may be any shade, but the dozen should be uniformly the same color; $\frac{2}{3}$ point allowed for each egg.

Uniformity of size and shape: All eggs must be of same size and shape. $\frac{1}{3}$ point allowed for each egg.

Shell texture: Free from wrinkles, spots, cracks, and rough places; $\frac{1}{3}$ point for each egg.

Condition of shell: Free from dirt or stain, unwashed.

Quality: Test with candles. (a) Air cell very small, about size of a dime, indicating freshness. (b) Egg must appear opaque, the yolk free from dark color, white thick, yolk barely visible. Large air cell, floating yolks or air cells are defects. Eggs must be fresh and sweet.

Disqualifications: Cracked, broken, spots, musty rots, and germs or blood rings in any one egg will disqualify the dozen.

COULD YOU TELL

1. The purpose and value of the Standard of Perfection?
2. How the combs of fowls differ in form?
3. In what way feathers differ in coloring?
4. The method of making cuts in scoring poultry?
5. How weight and size are graded by the judge?
6. Two conditions that might cause disqualifications?
7. The difference between utility and ordinary exhibition classes?
8. On what basis the utility score card is constructed?
9. Some of the features of a perfect head in the utility score?
10. Why the commercial score card is not more used in judging poultry products?

EASY THINGS TO DO

11. Holding Saturday afternoon poultry judging contests.
12. Collecting an exhibit of one breed for comparison at school.
13. Scoring a number of hens in the utility class.
14. Getting up a prize egg show, and judging by score card.
15. Sorting over and studying a case of eggs loaned by the egg dealer or grocer.

CHAPTER XLI

CULLING THE POULTRY FLOCK

The relationship of form to function with fowls has received a great deal of attention in recent years. Careful study of egg production by individual fowls, as explained in chapter XL, demonstrates that the most productive layers possess certain characteristics which are associated with the



Figure 231.—A culling demonstration by Prof. E. L. Dakan on an Ohio farm.
Photograph from Ohio State University.

laying habit. If one seeks egg production in a flock, it is very important to make practical application of this knowledge and cull out all birds that do not measure up to the desired standard or that are lacking in vitality. So important has this subject of culling out the undesirables become, that demonstrations on this subject have been held in many communities in the United States east of the Mississippi river, and hundreds of thousands of persons have

profited thereby. In 1921 nearly all the 88 counties of Ohio had special culling demonstrations, 50,000 persons being in attendance. During the month of July 599 demonstrations were held in 32 counties, and 64,651 hens were handled, 23 per cent of which were culls. It was estimated by the Poultry Department of the Ohio State University that these culls that were removed from the flock, resulted in a saving of \$11,766 to the flock owners. This Ohio experience is simply given as an example of the importance of this work. The following instructions for culling the flock, are based upon an excellent bulletin* prepared by Professor E. L. Dakan, a poultry specialist who has devoted much attention to this subject.

Indications of egg-producing capacity may be sought in several directions. In general these indications are shown in three ways:

1. In color changes due to egg production.
2. In body changes in fat and pelvic bones.
3. The period of molting.

A discussion of the above indications involves a number of special features which must be considered by themselves.

COLOR CHANGES IN HENS DUE TO EGG PRODUCTION

A yellow pigment is more or less present in the hen, according to conditions. When not producing eggs, the hen lays up body fat. In the case of yellow-skinned fowls, this fat contains a yellow pigment which colors not only the body fat and skin, but also the legs, beak, eye ring, and to some extent the ear lobe. As soon as a hen begins to produce eggs, this yellow pigment fades from the body and intensifies in the yolk of the egg. So long as a hen produces eggs the pigment is diverted to the yolk, none being deposited in the body, which is now bluish-white or pink in color. When laying is discontinued, the body once more takes on the yellow color. This process of fading follows a certain

*Culling the poultry flock. By E. L. Dakan, Bulletin 13. vol. XV, 1919-20, Agricultural Extension Service, Ohio State University

well defined course, always in the following order: first, the vent; second, the eye rings; third, the beak; and last, the shanks. The kind of feed used affects the length of the fading period in the hen, because the yellow pigment is derived from the grain and green feed that the hen eats. The fowl that has had yellow corn and plenty of green feed has a larger supply of yellow pigment stored in her body than the one fed on white corn with no green feed. Further, the greater the amount of yellow pigment stored up in the body, the longer the time required for the fowl to undergo the bleaching process. With these facts in mind it is possible to select the hen that has been the continuous, consistent layer, as well as to determine those which have just begun to lay or have been poor layers.

COLOR MARKS

The vent is the first part to lose the yellow color after egg production starts. This change is due to the fact that those parts of the body where the blood circulation is greatest fade first. A white or pink vent of a yellow-skinned bird indicates that she is laying.

The eye rings, which are in the inner edge of the eyelids, bleach out a little more slowly than the vent and, therefore, bleached or white eye rings indicate a longer production than a bleached vent.

The ear lobes on the white-lobed varieties bleach next and indicate a still longer period of production than a white vent and white eye rings.

The color of the beak is lost before that of the shanks and thus a white beak indicates that the hen has been producing eggs for a month or six weeks. The color leaves the beak, beginning at its base, and gradually disappears, leaving the front part of the upper beak last. The lower beak bleaches faster than the upper. The lower beak should be used for observation when the upper is covered with black or horn, as with Plymouth Rocks and Rhode Island Reds.

The shank color is the last to be affected, the yellow remaining in this part after it has disappeared elsewhere. For this reason we have here the surest indication of long continued production. It requires from four to five months for the shanks to bleach out after the hen begins to produce eggs. The color leaves the front of the shanks first and gradually fades from the scales on the back side as the length of the laying period increases.

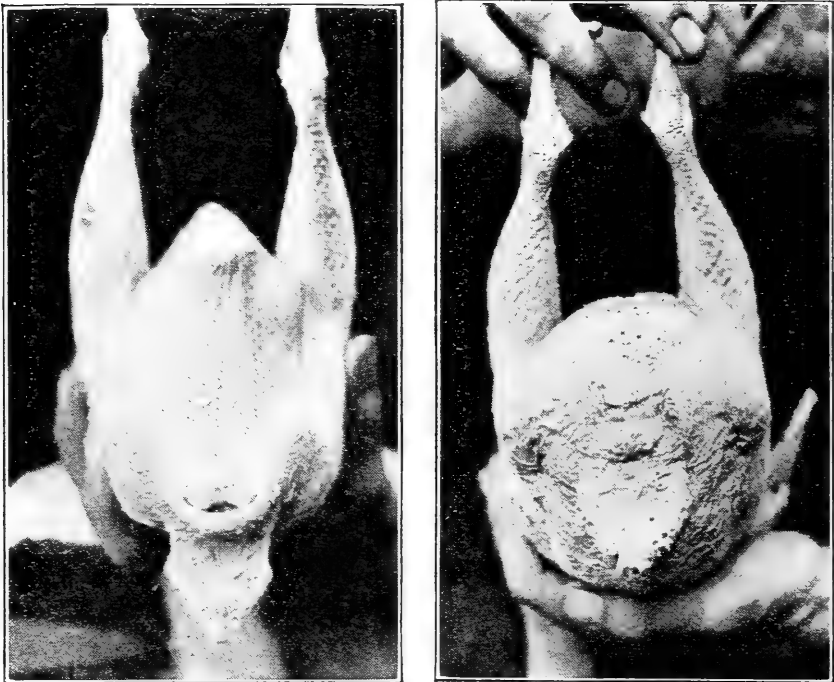

Figure 232.—Rear view showing large vent and egg laying form on left, and small vent and meat form on right. Photograph from Dr. O. B. Kent.

BODY CHANGES DUE TO EGG PRODUCTION

The following discussion of body changes is in the order that is usually followed in culling demonstrations.

The vent of a laying hen is large, as is shown in figure 232, and it is also open, moist, and soft, while that of a non-laying fowl is small, close, dry, and puckered.

The comb of a laying hen is large, full, and bright in color, while the comb of a non-laying one is dry and comparatively hard, often covered with scale, and is pale in color.

The abdomen of a laying fowl has a fat covering that is soft and pliable, and feels much like an udder that has been partly milked. The skin is also soft and velvety. The abdomen of a non-laying hen is dry and hard.

The pelvic, or pin, bones of a laying hen are straight and flexible, with very little or no fat around them. They are spread far enough to permit the passage of the egg. The spread varies with the individual and the breed, and no definite measurement applies in this regard. In general, however, a laying hen will show a spread between the pin bones of at least three

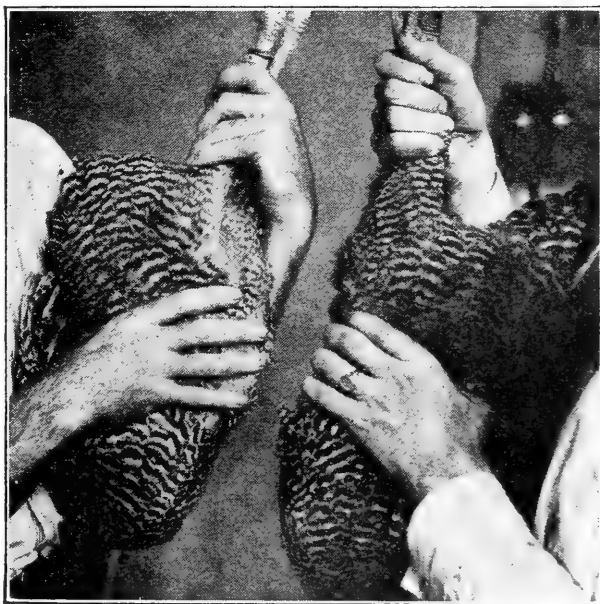

Figure 233.—A culling demonstration. Body depth is a measure of a hen's capacity to consume a large quantity of food and consequently produce a large number of eggs. The one on the left is a deep-bodied, high producer, the one on the right a shallow, round-bodied scrub. Photograph from Prof. E. L. Dakan.

fingers. Practice is necessary to determine just what spread indicates that the hen is laying, keeping in mind the fact that a hen that is laying will show a greater spread of pin bones than one not laying, and that the bones of a non-laying hen are thick, stiff, and blunt, with the ends bent in.

The distance from the pelvic to keel bones of a laying hen is an important indication. A laying hen consumes

more food than one that is not laying. A high egg-producer consumes more feed than a poor egg-producer. In order to consume and digest this feed the intestines of a laying hen are larger than of one not laying. When laying, the ovary and oviduct are greatly enlarged and require more room. To provide this extra space, the body increases in capacity or depth. This is noticeable by the increase in the distance from the pin bones to the end of the keel bone. The increase in size of the body cavity is secured by the dropping down of the keel bone. By measuring the distance from the pin bones to the keel bone an idea can be formed as to whether the hen is in laying condition or not. No definite measurement can be given that will fit all individual hens. As a general rule, a hen that measures less than three fingers wide of body depth, is not laying or is a poor layer, because such a hen lacks the capacity for handling a large amount of feed. The hen that shows the greater body depth may, as a rule, be selected as a good layer if in addition to this she exhibits the other marks of egg production.

THE MOLT INFLUENCE ON EGG PRODUCTION

Most hens stop laying when they begin to molt. Since the molting period covers several weeks, it is advisable to sell the hens that molt early. It is a fact no longer disputed, that a hen, in order to make a high yearly record, must be a consistent layer. The early molting hen is not a consistent layer. She takes all the fall months as a vacation for changing her plumage. The consistent layer molts late and grows her new plumage rapidly. The time of the molt is the best indication of the last year's performance. The molting period may be a guide in culling all breeds and varieties, but is of special importance with such breeds as the Orpingtons and Minorcas that do not have the yellow skin. The hen that molts early, under normal conditions, will not lay as many winter eggs as the one that molts late. Neither will the early-molting fowl begin egg production

earlier in the spring than the late-molting one. No definite date can be set as to early molting. As a general rule, however, the first hens in the flock to molt should be sold, and the last to molt should be retained for breeding purposes. Hens may be caused to molt early if placed on starvation diet while laying heavily; by irregular feeding; by roosting in a house that is poorly ventilated, or in any way that tends to check egg production suddenly. Care should be taken not to let these undesirable conditions occur, otherwise a lower total egg production is quite likely to follow. If the pullets are hatched early, they will be laying early in the autumn, and thus egg production will be kept up. In an article on culling,* Professor H. C. Knandel of Pennsylvania State College touches still another side to the plumage question. He says that during the fall months the condition of the plumage is the most noticeable indication of production that applies to all breeds. The hen whose plumage ap-

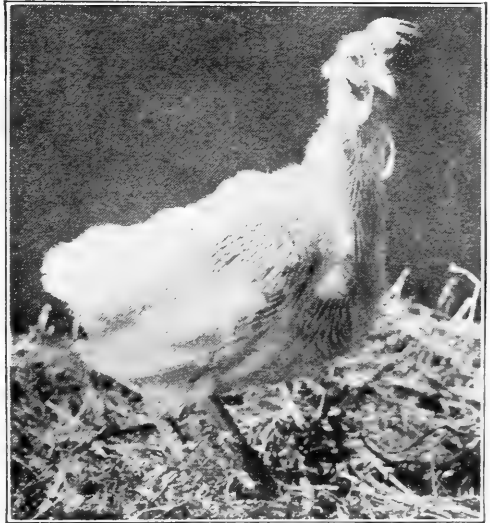

Figure 234.—A hen in heavy molting condition. Photograph from Prof. F. S. Jacoby.

pears most soiled, whose tail and wing feathers are badly worn, is the hen that has been laying heavily. The early-molting hen during the late fall months appears very much dressed up in her new suit, but has not produced a quantity of eggs sufficient to pay her board bill. Hence the hen that is the good producer is too busy laying eggs to stop to molt, with the result that she does not shed her feathers and get ready to engage in egg production until late in the year.

*The Truth about Culling. *National Stockman and Farmer*, Sept. 3, 1921.

IN CULLING THE FLOCK FOR EGG PRODUCTION

1. Why be influenced in your judgment by skin pigment?
2. What is the effect of green food on the egg?
3. Should the vent be yellow or white? large or small?
4. How would you value the color of the beak?
5. What kind of a comb would you seek?
6. How should the fat covering on the abdomen feel?
7. Should the pin bones be spread or close?
8. What should be the distance from the pin bones to the keel?
9. Would you select an early or late molting hen? Why?
10. What hens should be sold first?

DO A LITTLE CULLING YOURSELF

11. Compare the general forms of birds you know to be good layers with those that are not.
12. Feed two hens of the same breed, one corn, the other wheat, and notice the effect in pigment coloring.
13. Compare the eye rings, ear lobes and beak color of ten hens, of the same breed.
14. Examine the combs of laying and non-laying hens and note the difference.
15. Select two groups of fowls, one molting, one in full plumage, and measure the distance between pin bones and keel in each group.

CHAPTER XLII

EGGS AND INCUBATION

The egg is an object of much interest, for it is not only the source of the chicken itself, but also a most important source of income to the poultryman. If one is to handle the egg intelligently, one must know something of its composition, of how the chick is developed within the shell, and of commercial differences and values.

The parts of the egg of special interest are five:

The *shell*, composed mostly of lime, and hard enough to enclose and protect the softer interior.

Two tough membranes lying next within the shell. These separate at the large end, forming a small air sac, which is easily seen in hard-boiled eggs.

The *albumen*, or, as it is commonly called, the white of the egg. This forms about 57 per cent of the egg and consists of much nitrogenous matter of a liquid, sticky, transparent character. Boiling hardens, or coagulates, the white into a firm, white structure.

The *yolk*, comprising about 33 per cent of the egg, is a round yellow sac, surrounded by the white. This is used for nourishing the young chick just before and after leaving the shell. The yolk is suspended midway in the white and kept in proper position by two albuminous cords.

The *blastoderm* in the fresh-laid egg is seen as a white speck about one eighth of an inch in diameter on the upper side of the yolk. The blastoderm is the true egg and source of the chick in incubation.

The fertile egg is one that will produce a chick under proper conditions of what is called incubation. The infertile or sterile egg can not be hatched, and so has no value in

reproduction, although for food it has equal value with the fertile one. The fertility of the egg can not be determined except by incubation. After the egg has been under the hen for five to seven days, ordinarily one may easily tell whether it is fertile or infertile. If infertile, it will appear clear and show none of the changes subsequently described.

The testing or candling of eggs is a simple process of looking through the egg with the aid of special light. One

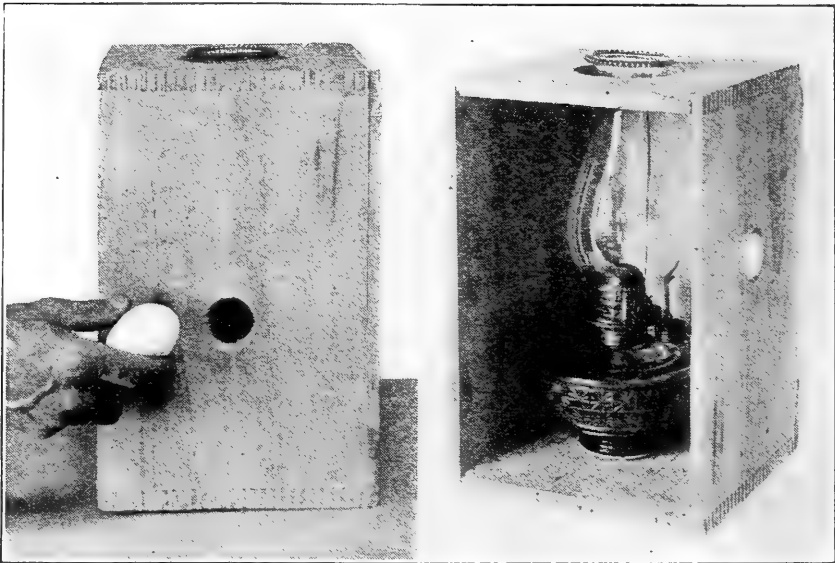

Figure 235.—A home made egg candler. Reproduced from Farmers' Bulletin No. 1040, United States Department of Agriculture.

may take a piece of common cardboard, one side of which is black, in which is cut an oval hole not quite as large as an egg. If the cardboard is held before a lighted lamp in a dark room, blackened side towards one, and an egg is held in the hole, the one that contains a chick will appear dark and opaque except at the larger end, while a sterile egg will be clear and show light. In the trade, where all eggs are examined before a light, this process is known as candling. Black lamp chimneys with holes in them are made for use

in a small way; but, in the larger commercial trade, eggs are candled over sets of electric lights arranged for this purpose.

The incubation of the egg of the hen occupies a period of 21 days. The following are some of the more important changes that take place during incubation. During the first twenty-four hours the blastoderm enlarges to about a half inch in size, within which the first stages of head and some other parts appear. During the second day the heart begins to beat and the blood to flow. By the end of the third day the veins and arteries are considerably developed, and the young chick turns on its left side. On the fourth day the wing folds, and the folds forming the legs appear. The beak

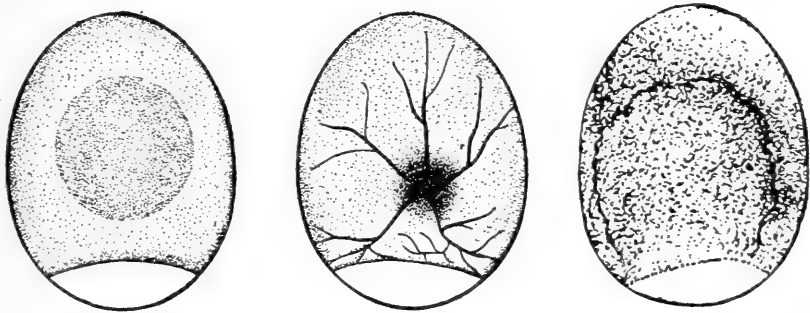

Figure 236.—The egg. Left egg dead germ; center, fertile egg on 7th day; right egg, infertile. Reproduced from Circular 99 of the California Agricultural Experiment Station.

begins to form on the eighth day, and shows its horny shape on the twelfth. The entire shell except the air cell is occupied by the chick by the twelfth day. The feathers appear first on the eighth day, and by the thirteenth cover the body to the length of one fourth inch. At this time the nails of the feet appear. On the fourteenth day the chick changes its position and extends lengthwise, the beak reaching the inner shell membrane. The air cell has been gradually increasing in size, and by this time is much larger. From now on, the chick increases in development to the twenty-first day. The following interesting description of the hatching process is given by Professor Lewis:*

* Poultry Laboratory Guide, 1910.

"When ready to come out, the chick raises its head and pierces the inner shell membrane, and immediately starts breathing the air in the chamber, which causes the pulmonary circulation to become active and the embryonic circulation to cease. The head is next raised into the air chamber, and the chick deals blows upon the shell, which, when often repeated in the same place, result in fracturing it. This process is repeated until the shell is broken around about one third of the way from the large end. The chick then presses its head against the large end and its feet against the small end, and then by pushing is able to throw off the shell lid and make its exit."

The incubator is a box-like device containing a space in which eggs may be incubated by means of artificial heat. The hatching of eggs by artificial incubation has been in operation for thousands of years, especially in Egypt and

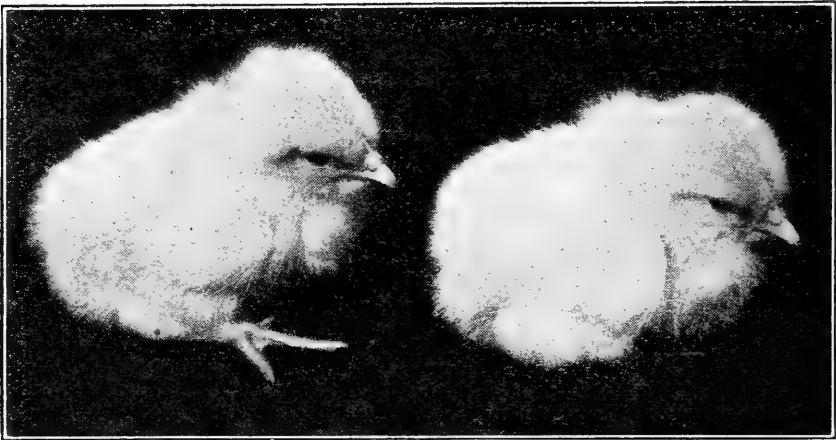

Figure 237.—A pair of vigorous day-old chicks. Photograph from Prof. F. S. Jacoby.

China. There are various designs of incubators made, ranging in size from those which contain but a few eggs up to those with a capacity for thousands. Incubators in use at the present time are heated by hot air from a kerosene lamp or by a hot-water system. The hot-air type is the one in more common use. The eggs, one layer deep, are placed in movable, wire-bottomed trays. The temperature of the incubator is regulated by the automatic action of an instrument called a thermostat, which is sensitive to heat changes. This instrument is set so as to reduce or increase automatic-

ally the amount of incoming pure air. A thermometer within may be read through the glass front. Incubators should stand level, and a popular location in which to operate them is a dry cellar that will maintain a uniform temperature.

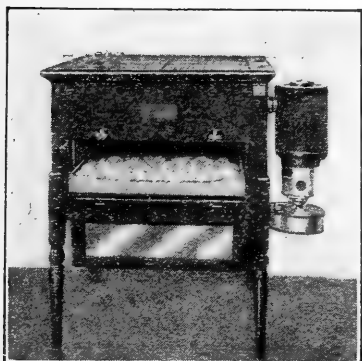

Figure 238.—A standard incubator and lamp. Photograph from Ohio State University.

The artificial process of incubation in the incubator requires one to look carefully after the following features of importance. These are location, temperature, ventilation, and moisture, and turning and airing the eggs. The following discussion of these factors

is abstracted from writings by Professor F.S. Jacoby, head of the Poultry Department at the Ohio State University.*

The location of the incubator may have a decided influence upon the number of chicks hatched. Heretofore the usual recommendation has been to locate the incubator in a cellar that maintains a more or less uniform temperature. With the improvement of the mechanical parts of the incubator, this reason for location is not so important as it used to be. The important point is pure air. The room, whether a cellar or not, should be so arranged that both the heavy gases near the floor and the light odors near the ceiling have a means of being dispelled. If the air in the room is impure, the air in the incubator will be even more so. The uniformity of temperature in a cellar is a decided help in the operation of the incubator, but it is better to have a room with a variable temperature, if the air is purer thereby. The most satisfactory results are obtained in a room having a cement or dirt floor, with a temperature of 60° to 70° F.

Temperature. The normal incubation temperature of hen eggs is 103° F. The position of the thermometer will

*Artificial Incubation of Chickens, Bulletin 16, Vol. XV, Agricultural Extension Service, Ohio State University.

determine the temperature at which the incubator should be operated. The thermometer may be arranged so that the bulb is in contact with the eggs or it may be hung above the eggs so that the bulb does not touch the top of the eggs. These two methods would each require a different reading to produce the correct temperature of the contents of the egg. When the bulb of the thermometer is in contact with one or two eggs and is on a level with the upper one fourth of the egg, the temperature should be 102° the first week, 103° the second week, and 104° the third week. If the thermometer is hung so that the bottom of the bulb rests on the top of the egg, the readings should be 103° the first week, 104° the second week, and 104½° the third week. With the thermometer suspended just above the eggs so that the tray can be removed without striking the thermometer, the temperature should be 103° the first week, 104° the second week and 105° the third week.

The incubator thermometer should be tested at the beginning of each season by comparing the readings with those of a certified standard thermometer in warm water at 102°, 103°, 104° and 105° F, and careful note made of all variations.

Moisture and ventilation in the incubator are so closely associated that they can not be considered separately. Nearly all incubators have some provision for supplying moisture during incubation. The use of moisture permits greater ventilation during incubation without excessive evaporation of the egg contents. The amount of ventilation will have a decided influence upon the quality and number of chicks hatched. The greatest amount of oxygen is needed from the 7th to the 20th day of incubation. The air in the incubator should always smell sweet. If it has any perceptible odor, there is not sufficient ventilation, and the eggs will not hatch as they should. The safest method of supplying moisture is by means of moisture pans located under the egg trays. The question of ventilation is automatically

cared for in most incubators. Openings in the bottom, sides, or top permit fresh air to enter and impure air to pass out. If there are openings in the top of the machine, much more moisture must be supplied in the egg chamber, for there will be considerable moisture carried out of the machine with the warm air. If there are no openings in the top of the incubator, the moisture in the eggs will be conserved; but, in order to supply sufficient oxygen to the developing embryos, there must be a system of ventilation that will circulate the air inside the incubator so that the light odors as well as the heavy gases will be dispelled and replaced with a certain amount of fresh air. As a rule, the amount of ventilation should be increased as the hatch progresses. Late hatches require more ventilation than the earlier hatches. The best guide as to the moisture requirement is the egg itself. About two thirds of the egg content should be occupied by the embryo on the nineteenth day. If too much moisture is supplied and too little ventilation allowed, the chicks will hatch with considerable irregularity and will not dry off with a soft, smooth down. If proper ventilation and moisture conditions have prevailed, the chicks will hatch out with uniformity, with a clean, soft down.

Turning and airing the eggs. Turning and airing the eggs is necessary for the production of strong, vigorous chicks. The hen on the nest turns the eggs with her feet several times a day. Turning insures an even development of the embryo and prevents any parts from adhering to the inside of the shell. The necessity for turning is apparent from the third to the eighteenth day of incubation; but, in those incubators that have automatic turning devices which permit the eggs to be turned without opening the machine, it may be desirable to turn the eggs from the second to the nineteenth day. There is no advantage in extending the time, if the machine must be opened and the egg tray removed in order to turn the eggs. Airing the eggs is a better

expression than cooling, because it expresses more concisely the real value that accompanies cooling. It is the fresh oxygen that the eggs draw in as they cool that has a strengthening effect upon the embryo. The usual period for airing is from the fifth to the eighteenth day. The eggs should be turned three times a day—morning, noon, and afternoon. They should be aired once a day, preferably at noon. The length of the airing period will depend upon the development of the embryo and the temperature of the room in which the eggs are aired. It will vary from two to three minutes for eggs five days incubated early in the season, to forty-five minutes for eighteen-day eggs in the late spring or early summer. Turning by hand is undoubtedly more nearly perfect than any automatic egg turning device, and if done once a day in addition to the other turnings there will be a marked decrease in the number of crippled chicks.

Care of incubator after the hatch. Remove all shells and unhatched eggs at the end of the twenty-second day. Chicks hatched after the twenty-second day will be too weak to prove worth raising.

The incubator should be thoroughly cleaned and disinfected after each hatch. Certain communicable diseases may be transmitted to the chicks through the medium of bits of egg shell and droppings, unless the trays are kept in a sanitary condition. Remove the trays and all portable parts from the interior of the machine. Scrub these as well as the inside of the machine with hot soapy water. Then drain and disinfect everything with a two per cent solution of creolin or zenoleum. Replace the trays, close the door of the incubator, light the lamp, and let the machine dry out. The fumes from the disinfectant will penetrate to all parts of the machine. If burlap is used on the nursery tray, use a clean burlap for each hatch.

Eggs for incubation should be from vigorous, well-mated fowls, and not from what might be called mongrel stock.

These eggs should be kept in a dry, cool atmosphere until placed under the hen or in the incubator. A place having a temperature of from 50 to 60 degrees Fahrenheit is regarded as best. The eggs should be carefully handled, not being severely shaken nor cracked. It is a good plan to mark on each egg the date laid, and no eggs over 10 days old should be set. In making up settings, it is desirable to use those of uniform size, color, and condition. Hatchings will be likely to be more uniform if the eggs are of much the same age and condition of keep previous to setting.

The size and weight of eggs vary more than many suppose. Professor Lewis gives* some interesting figures about the size and weight of eggs of different breeds of fowls. The eggs of seven different breeds showed an average large circumference of 6.19 inches, a small circumference of 5.27 inches, and an average weight of 1 pound, 8.05 ounces per dozen. The eggs from the hens were slightly larger and weighed a trifle more than those from the pullets. A dozen Plymouth Rock eggs weighed 1 pound, 11.2 ounces; the Leghorns ranking second at 1 pound, 10.3 ounces. In a bulletin published by the Ohio State University, † it was shown that, in sorting over a case of eggs, a dozen of the largest ones weighed 30½ ounces, the medium-sized 26½ ounces, and the small ones 21¾ ounces. On this basis it was figured

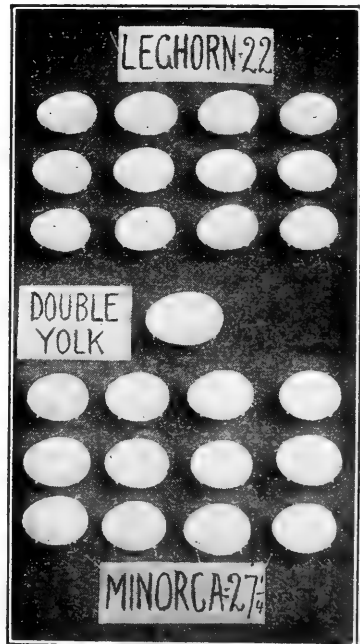

Figure 239.—Leghorn and Minorca eggs. Note the difference in size and weight per dozen. Photograph from Ohio State University.

*Poultry Laboratory Guide, 1910, p. 16.

†The Marketing of Eggs, April, 1911, p. 16.

that a case of 30 dozens of large eggs would weigh 57 pounds, 3 ounces, while the small ones would weigh but 40 pounds, 12 ounces, an astonishing difference. The Leghorn naturally produces small eggs, and the Minorca large ones, and figures in the bulletin referred to give a weight of 22 ounces for a dozen of the former, and $27\frac{1}{4}$ ounces for the latter. The fact is, that, for the same price, a dozen large eggs furnish more actual nutriment than a dozen small ones.

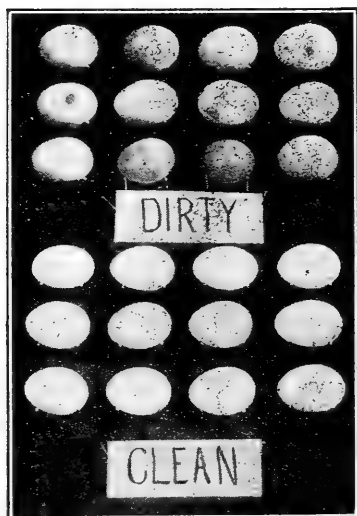

Figure 240.—A comparison of clean with dirty eggs. Photograph from Ohio State University.

The color of the egg is due to a pigment, or coloring substance developed in the shell during the process of formation in the body of the hen. The color is either white or brown. Leghorn and Minorcas produce white eggs, and Brahas and Plymouth Rocks, brown ones. Some buyers prefer the white color, and others the brown. Eggs of a chalk-white color, with a light yellow yolk, bring the best prices in New York City. This preference is merely a matter of fancy, because there is no difference in the food value. When fresh laid,

the egg has a clear shell of a beautiful dull glaze, but with age and handling it becomes somewhat glossy or polished and often is soiled.

The degree of freshness of the egg has much to do with its value on the common market. Prime fresh eggs, such as producers supply to private consumers, bring the highest price. In a commercial way, eggs are gathered from farmers by hucksters or are sold to country grocers by the producers. They are placed in wooden cases holding 30 dozens and are shipped to the city dealers, by whom they are graded and

then placed on the market. Often the eggs are very poor, especially during the summer season. Eggs from stolen nests, dirty nests, from held-over stock, etc., find their way into the same case, and form a motley collection. The careful dealer sorts these, candles them, and tries to grade them before placing them on the market.

The grades of eggs on the market differ to a considerable extent, and in some places more than in others. Large markets like New York or Boston handle the most grades. Professor Philips gives the following classification as an ideal way to grade eggs:*

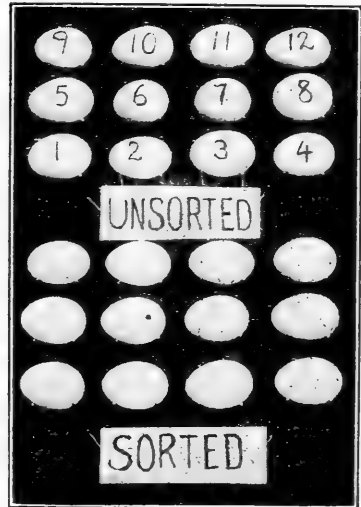

Figure 241.—Sorted vs. unsorted eggs. Photograph from Ohio State University.

Extras. Weigh 28-26 ozs. naturally and absolutely clean; fresh and sound.

No. 1. Weigh 26-24 ozs., sound, fresh, and reasonably clean.

No. 2. Shrunken or stale, washed, small, stained and dirty.

No. 3. Checks—cracked, but not leaking.

No. 4. Rots. Incubator and decomposed eggs.

New York quotation on eggs in November, 1921, showed the following grades and prices.

California whites-Extra firsts	70c
Extra firsts	58½-60c.
First grade firsts	50-54c.
Refrigerator firsts	34½-35½c.
Refrigerator seconds	30c.

The preservation of eggs during low prices, to sell when they are high, is a common practice. The egg easily spoils under a hot sun or in warm moist weather. Germs of rot develop rapidly in the egg at 55 degrees or higher, consequently it is desirable to keep them below this temperature until they can be used. In cold storage, it is preferred that a temperature of 34 degrees be maintained.

*Bulletin No. 162, Kansas Experiment Station, p. 251.

The use of common water glass (sodium silicate) for preserving eggs is now very generally recommended. This is a liquid that sells at a comparatively low price. The preserving fluid is made by thoroughly mixing one quart of the water glass in nine quarts of water that has been boiled and cooled. Stone crocks or barrels make good receptacles for preservation. These should be well scalded before using, and then kept in a

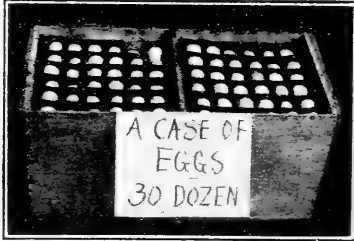

Figure 242.—A case of eggs. Photograph from Ohio State University.

place where the temperature does not rise above 60 degrees. The best eggs for preservation are those laid in April, May, and early June.

SPECIAL TOPICS FOR STUDY

1. Describe the different parts of the egg.
2. Explain the method of testing eggs.
3. Describe the stage of incubation on the second, eighth, and twelfth days.
4. Describe the methods by which the chick gets out of the egg.
5. Why is moisture necessary during incubation?
6. Describe the incubator.
7. How should the egg for incubation be selected and cared for?
8. Compare eggs for size and weight.
9. Describe Professor Philips' ideal of market grades.
10. Give method for preservation.

SOME THINGS YOU MIGHT DO

11. Boil an egg hard for three minutes, and when cold separate into four parts—shell, membrane, white and yolk.
12. Test some eggs by candling, either from an egg case or from those being incubated.
13. Fill a small incubator and keep a daily record of its temperature for 21 days.
14. Go to a grocery and inspect a quantity of eggs, and report on what you saw as to size, shape, color, and condition.
15. Find market grades and quotations on eggs in at least three markets. Make comparisons.
16. Bring a sample dozen of your home eggs to school for inspection.

CHAPTER XLIII

THE FEEDING OF POULTRY

The organs of digestion of the fowl perform their work and have the same influence on the food as do the stomach and intestines of animals. The form of these organs, however, is peculiar to birds. They may be briefly described as follows:

The beak, a hard, horny part for breaking, tearing, pulling or picking up food.

The mouth and tongue, within and back of the beak.

The gullet, a tube which extends to

The crop, which lies in front and at the base of the neck. Here the food accumulates and is somewhat softened by digestive fluids.

The stomach, where food from the crop is mixed with the gastric juice.

The gizzard, a tough muscular organ containing small particles of stone. Here the food is ground to a pulp, mixed with digestive fluid, and then moves on to

The intestines, where the last stage of digestion takes place.

The foods suitable for fowls vary widely in kind and character. In fact, farm poultry will eat almost anything that has any nutritive value. So adaptable are fowls to local conditions, that, as a rule, they are fed the cheapest and most common foods grown in the region in which they are kept. Very naturally, in America corn is most commonly fed, with wheat or its by-products next in favor. In Japan, rice is the food generally used. The kind of food, however, should vary according to the age and condition of the birds, and the purpose for which they are kept. If for

fattening, then a carbonaceous food is best; but, if for eggs, then that of a protein nature should be used. Protein foods recommended for fowls are meat scraps, fish meal, and milk of various forms. The common grains and cereal by-

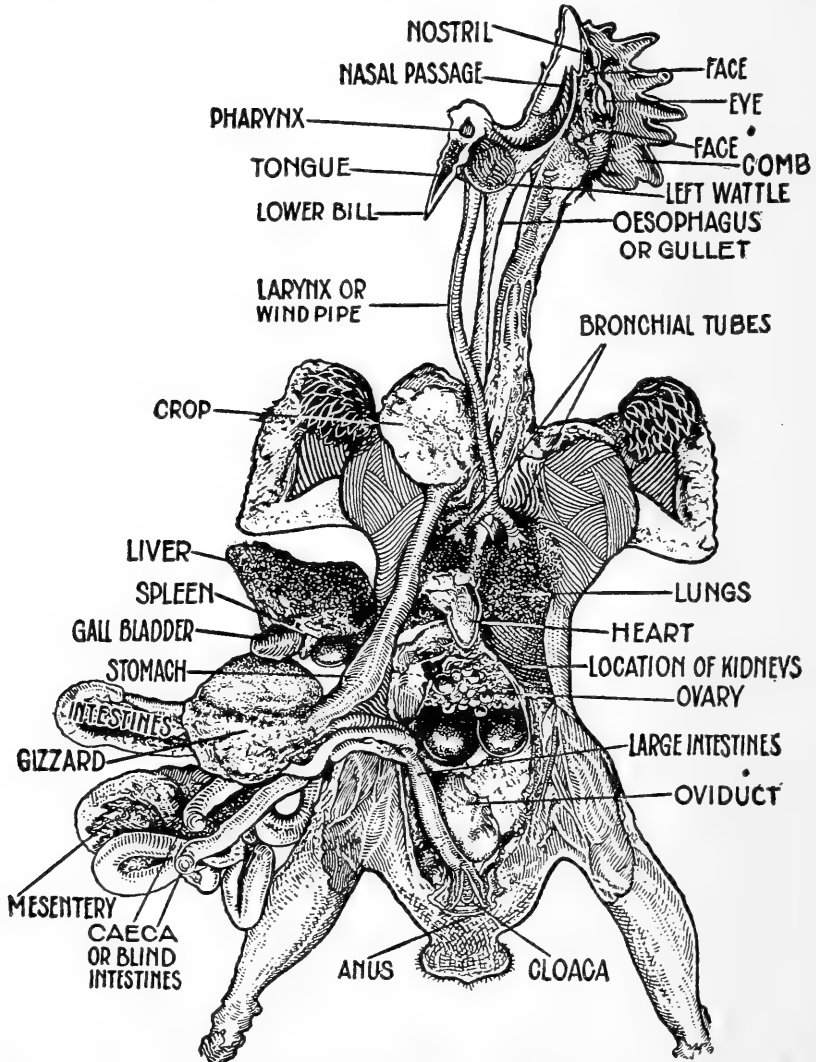

Figure 243.—Anatomical chart of a fowl. Reproduced from Poultry Manual of the G. E. Conkey Co., Cleveland.

products, such as corn, wheat, oats, bran, middlings, etc., supply the necessary carbohydrates.

The appetite of fowls for different kinds of food is well worth observing. They eat grain or concentrated feed with great relish, and when in confinement this is the kind most used at regular feeding times. They are extremely fond of meat, table scraps, tender herbs and grass, and of insects, worms, etc. In fact, no one class of food seems most relished, and poultrymen generally agree that variety in the diet usually gives the best results, from both the health and the producing point of view.

The special preparation of feed for fowls naturally depends upon conditions. Small particles are usually preferable to large ones. Wheat and other small grains are very satisfactory. Large grains like corn are best cracked or broken. Ground or pulverized feeds, singly or in mixture, are known as mashes. Where no water is used, this food is called dry mash; with water, a wet mash. Dry mash is a favorite in some places and not in others. Clover or alfalfa hay is often thrown into the yard, the fowls readily eating the leaves and delicate parts. Young chicks require fine, easily digested food, like oatmeal, cracked wheat, finely-granulated corn, chopped vegetables, etc. Skim milk also is a valuable food for growing chickens.

Green food for fowls causes them to respond very rapidly in increased growth or egg production. When on a range of good grass no other green food need be provided, but during the winter season succulent food is most desirable. Coarse vegetables are often sliced or chopped into small pieces before feeding, although entire cabbages or roots may be hung in the house or fastened to nails on the walls, from which points they will be picked to pieces. In recent years sprouted oats have been used in a small way for feed, especially for young chicks. The common plan is to make a wooden rack-like arrangement, to contain series of shallow pans. The desired amount of oats is put into a vessel and covered with warm water and let stand over night.

The surplus water is then drained off and the oats are spread over the pans to a depth of one half to three fourths of an inch. The oats should then be placed in a room, preferably a basement or cellar, having a temperature of 60 to 65 degrees. The oats should be sprinkled daily with tepid water,

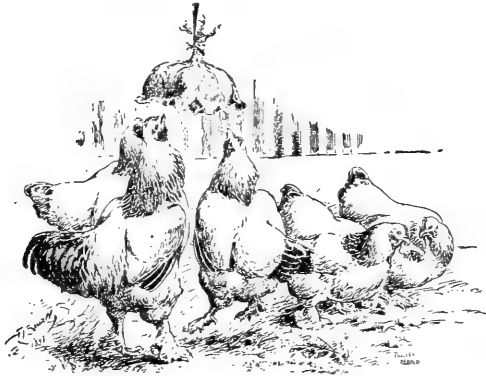

Figure 244.—Fowls eating cabbage suspended just above the head. Reproduced from the "Poultry Manual."

and, to provide drainage, the bottom of the pans should be perforated with small holes. In about ten days the sprouts will be ready to feed to the chickens, but they should be used sparingly in the first of the feeding.

The amount of food necessary for fowls depends entirely upon their

size, egg production, and kind of food fed. The best plan is to prepare standard mixtures, and feed as much as will be eaten with appetite.

Regularity in feeding fowls is essential. On many farms the poultry must forage for themselves, but under proper conditions there should be special grain feeding morning and evening. A dry mash is commonly kept in the house at all times. Other special feeds are also given early in the morning, about noon, and just before the birds go to roost. Regularity of feeding also brings the fowls into intimate touch with the poultryman, and enables him to handle them and watch their condition to the best advantage.

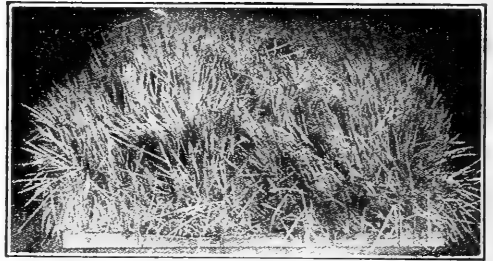

Figure 245.—Oats sprouted in a pan. By courtesy Cypher's Incubator Company.

Frequency of feeding fowls depends upon the age, condition, and purpose for which they are kept. Young chicks should be fed four or five times daily. The feeding of mature fowls varies among poultrymen, some feeding twice and others three times a day. If one has time to look after the stock in detail, three feeds a day for fowls in limited yards will give better results than will two. Most good poultrymen use what are called "hoppers" or "self-feeders." The hopper is a box-like arrangement containing more or less feed, from which the fowls can eat freely at any time.



Figure 246 —Forced feeding of fowls in England. Photograph by courtesy of *Poultry Herald*.

Scattering grain in cut straw or floor litter is a good plan, for it keeps the fowls busy and ensures slow eating, both of which habits are desirable. Some persons feed a wet mash in the middle of the day, grain being used morning and night. Some prefer one method and some another.

The effect of food on the quality of the egg is very noticeable in some cases. Foods of strong odor, such as onions, impart objectionable flavor to eggs. Corn gives an undesir-

able yellow yolk, while most other grains produce less color. Green food and clover or alfalfa hay also furnish the high color to the egg so commonly seen when these foods are fed.

Forced feeding of fowls may be done in two ways, one when the feeder simply gives the birds more feed than they need or would eat under natural conditions; the other being a special artificial feeding process known as cramming, whereby the crop is filled with food by the use of a machine, and the fowl fattened as rapidly as possible. Of course what would be a forced feeding of one fowl might not be of another, because of difference in capacity.

On this subject of forced feeding Robinson says:*

"Forced feeding is almost universal among poultrymen. All regular, good feeding is in a sense forced feeding. Even under natural conditions with opportunity to balance their own rations, full-fed poultry develop faster and better individually, but at the cost of shorter life and reduction of vitality in the offspring. The poultryman's object is to get as much as possible out of the birds in the shortest possible time; that is, to market as soon as possible those destined primarily for the table, and to keep laying and breeding poultry only as long as they are highly productive. He forces by feeding, but not (intentionally) to the danger point, just as a careful horseman often drives his horse much faster and farther than the horse would go of its own accord, yet avoids over driving."

The use of mineral foods by fowls is even more important than with farm animals. Growth in proportion is really much greater with the fed fowl than the four-footed animal, while the production of eggs requires a considerable amount of mineral matter. The common supply of food does not always furnish enough of the mineral substances, and especially lime, to meet the needs of the fowl. This lack is particularly true of the laying hen. Consequently some other material must be added, and green ground or broken burned bone, granulated dry bone, and finely broken stone are commonly used to meet this need. Ground or finely broken oyster shells have always been popular for laying hens. As to the exact needs of the body for mineral food, we do not know, but it may be assumed, as based on practice and the result secured with farm animals, that the mineral

*Principles and Practice of Poultry Culture. 1911, page 213.

substances play a part in nutrition. Robinson, however, believes that in "good feeding of mixed rations," under range conditions young birds get all the mineral elements they require, and adult birds all they need, except for producing egg shells. He does not think grit is necessary, and since 1902 has fed none to poultry, except in the first feeds of young ducks and geese. Granulated charcoal is frequently used, being regarded as valuable for correcting sour stomach and other forms of indigestion. Some poultrymen think charcoal is a blood purifier.

Water for fowls should be clean and pure. Drinking fountains in which clean water may always be found are

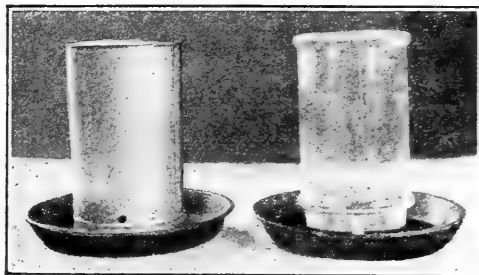

Figure 247.—Cheaply made drinking fountains. These are jars filled with water and turned with mouths down in pans of water. Photograph from Ohio State University.

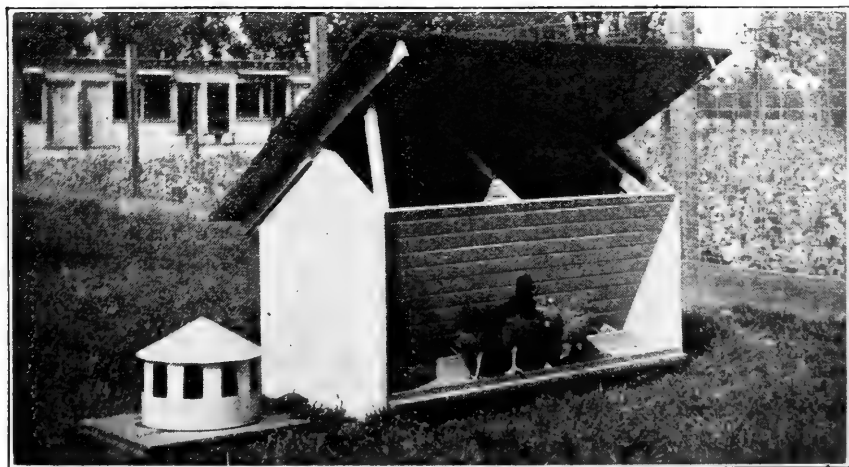

Figure 248.—A feed hopper and covered water pan at left. Photograph from Prof. F. S. Jacoby.

commendable. Fowls are rather frequent drinkers, and should always have plenty of clean water available. In win-

ter, care should be taken to see that water and not ice or snow is supplied. A flock of fifty hens will use from four to six quarts of water a day in ordinary weather conditions.

Feeding rations for fowls naturally vary, some persons preferring one ration and some another. Most of these here given are easily secured or may be readily prepared, as the foods used in the combinations are grown over a wide extent of country. The rations given are quoted from reports, and so differ in total amounts and in statement of weights or parts. The common method, however, is to mix up a quantity of feed, and then use as much as the flock requires.

The feeding of young chicks requires very careful attention. The following is the general course of feeding recommended by the poultry department of the Ohio State University. Milk should be the first food given. Either fine commercial chick feed or finely cracked corn and wheat should be given in the litter about five times daily, making sure the chicks have to scratch in the litter to get the grain. Plenty of exercise for the chicks is desirable. For the first week bran should be kept available in shallow pans all the time, as this is rich in mineral matter, is bulky, and serves as a mild laxative. As the chicks get older the grain feeding can gradually be reduced until only morning and evening scratch feeds are given. The following course of feeding is especially recommended for the various stages of development, using as much of the several mixtures as may be desirable.

First week	Second to eighth week
SCRATCH FEED	SCRATCH FEED
50 lbs. corn finely cracked	60 lbs. corn finely cracked
40 " wheat " "	40 lbs. wheat " "
10 " rolled oats	MASH
MASH	20 lbs. bran
Wheat bran	10 " middlings
Milk all time	10 " corn meal
	10 " ground oats
	5 " meat scraps or tankage*
	1 " bone meal

*Use milk in place of scrap or tankage, if available.

Eighth week to maturity

SCRATCH FEED	MASH
200 lbs. cracked corn	200 lbs. bran
100 " oats or wheat	100 " middlings
	100 " corn meal
	100 " ground oats
	75 " meat scrap
	5 " bone meal

In addition to the above, it is desirable to feed young chicks sprouted oats, cabbage, mangels, beets or green grass, each of these to be fed in finely prepared form, as may be available. When on the range such food need not be prepared. Infertile eggs from the incubator, hard boiled and chopped up, make excellent feed for young chicks and they should always be fed rather than cast aside.

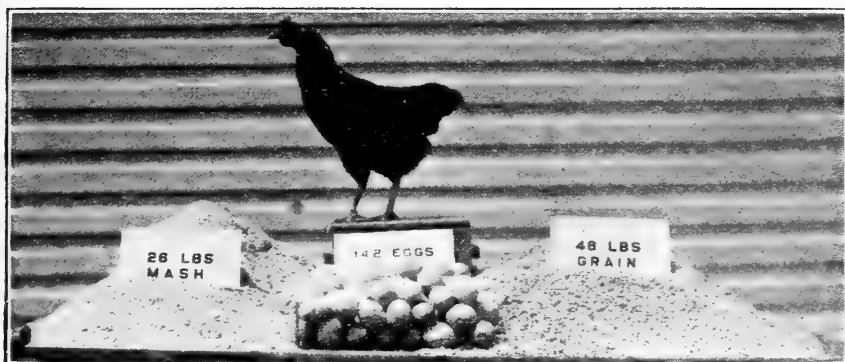

Figure 249.—The average amount of grain consumed by a laying hen in a year, producing 142 eggs. Photograph from U. S. Dept. of Agriculture, Farmers' Bulletin No. 1040.

Rations for egg production used in different sections of the United States, vary more or less, according to material available. The following rations are recommended by various authorities engaged in research work in feeding fowls. (By United States Department of Agriculture—Farmers' Bulletin 1067)

Ration No. 1

MASH	SCRATCH MIXTURE
16 lbs. corn meal	1 lb. cracked corn
6½ " meat scrap	1 " wheat
1 " bran	1 " oats
1 " middlings	

Ration No. 2

2 lbs. corn or barley meal	2 lbs. cracked corn
1 " bran	1 " oats
1 " middlings	1 " wheat or barley
1 " meat or fish scrap	

Ration No. 3

3 lbs. corn meal	2 lbs. cracked corn
1 " meat scrap	1 " oats

Ration No. 4

9 lbs. corn meal	2 lbs. cracked corn
5 " middlings	1 " wheat
4 " bran	1 " oats
2 " cottonseed or gluten meal	1 " barley
2 " meat scrap	
2 per cent bone meal	

(In Ohio at Ohio State University)

DRY MASH

100 lbs. corn meal
100 " wheat middlings
100 " bran
100 " oats
100 " meat scraps or tankage

SCRATCH

100 lbs. cracked or shelled corn
100 " wheat or oats
Green food, grits and oyster shells

Feed the grain mixture morning and afternoon in a deep litter of straw. Feed sparingly in the morning, but give the hens all they will eat in the afternoon. Feed the dry mash in a hopper which is open at all times. Keep grit and shell in open hoppers. Feed green food once a day.

(In Minnesota, *Bulletin 119*, Minnesota station, page 153)

A mash consisting of equal parts of finely ground corn, oats, or shorts, mixed with about 10 per cent of cooked meat, green cut bone, or beef scraps are mixed together dry. Then thoroughly mix with about one third this bulk of steeped clover leaves or finely cut clover, which has previously been scalded. Another mixture, to be only slightly moistened with water, is the following:

2 parts bran	1 part wheat shorts
1 part ground corn	1 part ground oats
1 part beef scraps	1-10 part charcoal

(In North Carolina, *Bulletin 211*, North Carolina station, page 54.)

In an experiment extending from December to May, different rations were fed to pens of 10 hens each. The largest

production of eggs and the least cost occurred in pens 14 and 15, fed the following:

4 parts corn meal	4 parts wheat bran
2 parts meat meal	2 parts bone meal

Cottonseed meal was used in three cases. Pens 20 and 22, fed four parts each of corn meal, wheat bran, and cottonseed meal, did very unequal work, one pen laying 225 eggs and the other 378.

(*In Kansas, Bulletin 164, Kansas station, page 290.*)

The following laying ration has been a success in feeding White Leghorns and White Plymouth Rocks. Between February 1 and November 1, 1909, one White Plymouth Rock produced 201 eggs and another 196, at a cost for feed of 90 cents each. The Leghorns averaged 166.1 eggs for the same nine months, at a slightly less cost. Following are the rations:

GRAIN	MASH
10 parts wheat	6 parts wheat shorts
10 parts corn	3 parts bran
5 parts oats	6 parts corn meal
	5 parts beef scrap
	1 part alfalfa meal

Fattening ration for fowls. Fowls to be fattened should be kept in a limited enclosure and given but little exercise, and fed a fattening ration. Specialists place chickens in crates and fatten them rapidly for three or four weeks. Professor Jackson, formerly of the Pennsylvania station, reporting on fattening in Bulletin No. 107, says:

"The common ration of corn meal is rarely as satisfactory as a combination of grains. An excellent mixture is equal parts of finely ground corn meal, buckwheat, and oats with the hulls removed. A ration of one to two parts corn meal, one part middlings and five per cent meat scrap may be used if it is not possible to secure the other grains. It is important, whatever grains are used, that they be finely ground. If this ration is mixed with sour milk, no animal food will be needed."

It will be noticed that in all the above rations, corn, wheat, oats, and wheat bran or middlings are the standard foods used. Meat meal or beef scrap, skimmed milk, and clover or alfalfa, are always desirable. In the far West,

Kafir corn or millet seed may be used to advantage. Where barley is commonly grown, this is to be recommended as a feed, and may be used in place of corn, if desired.

A REVIEW OF THE POULTRY FEEDING SITUATION

1. Compare the crop and the gizzard.
2. What kind of diet should be given a fowl?
3. How often should poultry be fed?
4. Explain the meaning of forced feeding, and when it is practiced.
5. Why is mineral matter fed, and under what conditions?
6. Under what conditions should water be supplied?
7. Give the best method of feeding young chicks from the second to eighth week.
8. Give two rations for laying hens used in different states, and the method of feeding.
9. Name the five most common feeding stuffs used.

INTERESTING EXPERIMENTS FOR YOUNG PEOPLE

10. Carefully examine the crop and digestive organs of a chicken.
 - (a) When taken from a freshly-killed fowl.
 - (b) Freeze a fowl solid in winter, and with a saw cut it in two lengthwise and somewhat on one side, to show the digestive organs in place.
11. Make up two pens of hens, equal in number. Feed one lot a carbonaceous food, like corn; the other a protein food, such as wheat. Give some green food, oyster shells, and grits. Keep a record of egg production, and after some weeks report to the school.
12. Make up two pens of hens. Feed alike, except to give one pen oyster shells, and allow none to the other. Keep a record of the number and condition of the eggs, and report.
13. Prepare what you believe to be a good ration of home-grown feeds for growing chickens, and bring a sample to school for inspection and criticism.
14. Report on the rations fed by any two or more poultrymen in the community in which you live.

CHAPTER XLIV

THE POULTRY HOUSE AND EQUIPMENT

The need of housing or shelter for fowls varies with the section of the country and the local conditions under which they are kept. While close housing is no longer needed to the extent formerly thought necessary, naturally more protection is required in the colder sections than in the warmer. In winter, in New England, where the ground is usually covered with snow, shelter is a necessity; while in Texas, where snow rarely falls, less protection is required.

The forms and styles of poultry houses differ widely, and no one kind is regarded as the best. A collection of photographs or views of one thousand houses will show a very interesting variety of style and construction. Years ago buildings were often made of brick or stone, at great expense, and were very warm and almost air tight in winter. In recent years the construction is less expensive, and fresh air properly supplied is an important feature.

Several types of poultry houses, each for a special purpose, are more or less in use in this country. These may be placed in the following classes: (a) Laying pen house, (b) fattening house, (c) brooder house, (d) colony house, (e) shelter coop. While plans and details of construction can not be given in the limited space of this volume, some suggestions of interest and value will be found in the following pages that may be well worth careful study.

The laying pen house is designed for the purpose of keeping fowls in confinement, in groups suitable for the best results. Yards or runs limit the range of the hens. These houses are permanent of location and, as a rule, are of substantial construction. Formerly they were made with tight

walls, had glass windows, and in winter the air within was kept at as comfortable a temperature as possible. Sometimes these houses were lathed and plastered. Not much attention was given to ventilation. Houses of this sort are not built as much as formerly; and, if they are, cloth screens on the front or south side replace most of the glass, pure air being regarded as a necessity. In many cases, these houses have open front windows, except in the coldest winter weather, when the cloth screens are dropped. Laying pen houses are of different styles, a common one having a simple single-pitch shed roof, with a height of 6 or 7 feet at the

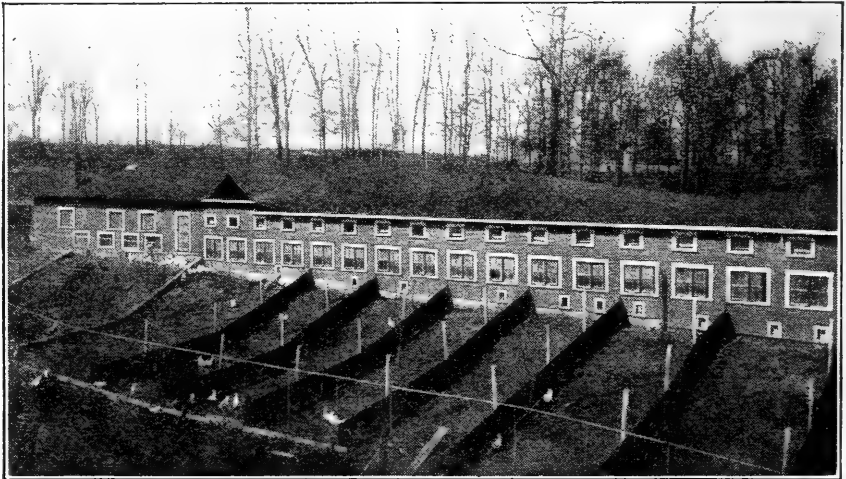

Figure 250.—A large laying house and yards. Photograph from Prof. F. S. Jacoby.

south, and 4 or 5 feet at the rear. It is best to have the house of a depth that will allow sunshine to reach as near the back wall as possible. A depth of 14 feet and a width of 12 to 14 feet for each pen is a satisfactory size. One should allow 5 square feet for each bird in such a house. In a house of this sort the floor should be made of concrete in order to make it rat-proof and to keep it dry. This floor may be covered with cut straw or chaff, and be used in cold weather as a scratching shed. The walls should be tight

enough to prevent drafts. The roosts may be placed just above a low platform at the rear or on one side, below which are the nests. In front, plenty of window space should be provided, which should be covered with poultry wire netting, and also have cotton cloth screens, to be dropped during very cold weather. Doors of standard size are usually placed at one or both ends of the house, with wire doors in the partitions, to allow passage through the various pens. In houses containing many pens, doors are sometimes provided to give entrance from the pens into the yards.

The fattening house is a small structure containing crates in which fowls are fattened, arranged along each side of a passage way. The house is of simple construction, and has superior ventilation with inferior light, as fowls are best fattened under conditions of subdued light. Fattening crates are in tiers, with feeding trays in front of each, which with other conditions provide for the least amount of labor in caring for the birds. Houses of this kind are not common on American farms, but are used especially by men who make a business of fattening fowls for market.

A brooder is a device used in connection with the incubator, and is in a sense an artificial mother. The general plan of the brooder is that of a warm box or room, heated either by a small oil stove or a coal stove. The former provides uniform warmth for from 100 to 200 chicks, and the latter for from 200 to 500. Within the brooder is what is called a "hover." A circular plate or cover of more or less diameter, according to the size of the hover, is placed about ten inches above the floor. From the rim of this plate a cloth curtain extends to the floor. Pieces of cloth are also suspended from different parts of the underside of the cover to the floor. Here and there the cloth is slit so the chicks may freely pass through and find a warm protection among the strips of cloth, comparable to being under the mother's wing. The small brooder house has but one hover,

but the large houses, which are heated by coal stoves, may have several. The temperature under the brooder should be kept as nearly 100° F. as possible. A brooder house may be a simple box-like affair of one room 6 by 8 feet in size, with the hover in the back and a door and window in front. On large farms it may be of considerable size, containing a series of pens, in the end of each of which is a hover, warm air being supplied by a hot-water heating plant. The floor of the brooder should be covered with fine sand, if at all available. The brooder should have plenty of sunlight; it should be rat-proof; it should be roomy with

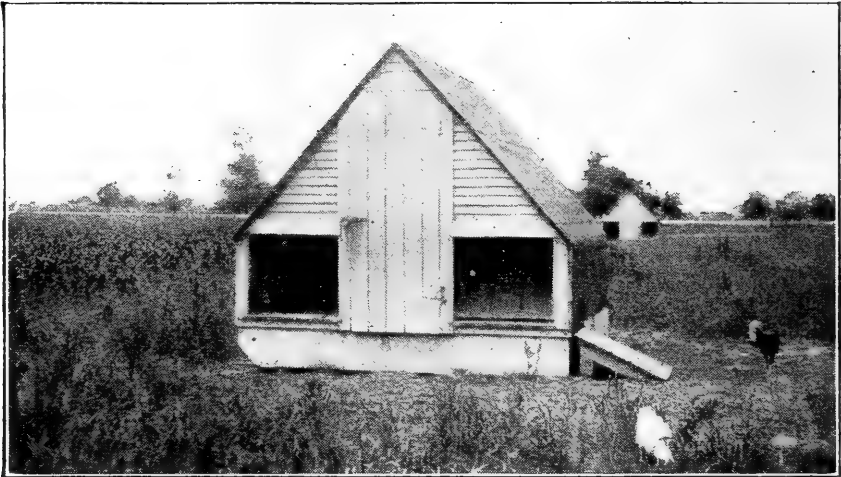

Figure 251.—A colony house at Ohio State University. Photograph from Prof. F. S. Jacoby.

plenty of scratching space; good ventilation should prevail; and the temperature should be easily controlled.

The colony house is a small, single-room building containing roosts and nests, and located in a yard or field. It is simple and cheap of construction, and is usually portable, so as to be easily moved from place to place. There is no one style of house; and structures are made of all kinds of material, ranging from piano boxes, at a total cost of \$3 or \$4 up to those made with care by a carpenter, costing \$35

or \$40. A fairly good type of colony house has both a door and window in front, the latter being covered with wire screening, and with a curtain to be used for cold weather protection. A small window in one end, for both ventilation and light, and a wooden floor are also desirable features. Poultrymen having houses differing widely in style of construction and lighting seem to get equally good results from their fowls. Two strong arguments for the colony house are, that a flock of about the right size may be kept in a yard of suitable area; also the house may be shifted from time to time to new and clean soil conditions, thus providing good, permanent sanitation. Colony houses may be hauled into grain fields after the harvest, where the fowls secure uncommonly good forage of grain and insects.

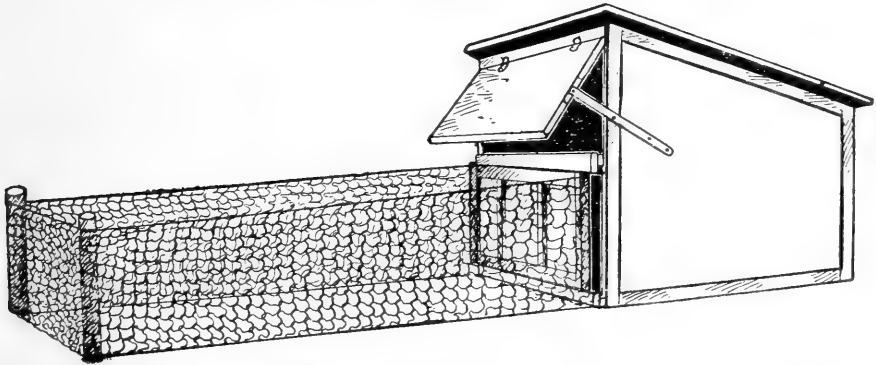

Figure 246.—A handy shelter coop and run. Reproduced from "Poultry Houses."

The shelter coop is usually built for a hen and a brood of chickens. It varies much in construction. Common boxes 2 or 3 feet square, with slat or wire front; empty barrels, with a slat attachment at one end; and shelters of tent or A-shape are frequently seen. These coops should be made so as to enable the chicks to pass freely in and out, to give the hens dry and comfortable shelter, and to protect the chicks at night from rats and other vermin.

The location and construction of the poultry house require careful thought, if the most satisfactory results are to be

secured. A few suggestions, therefore, which are rather general in their application, are here given.

The site of the poultry building should be where drainage is good and the soil naturally dry. Further, the elevation should be sufficient for a good circulation of air. Under damp conditions throat or lung trouble is very likely to occur. In damp soil of a clayey or loamy nature, intestinal and other parasites that affect poultry breed more freely than elsewhere. A dry location promotes clean bodies and feet, which mean the production of clean eggs.

The size of the poultry house should depend upon the number of fowls one wishes to keep. On most farms large flocks do not give as satisfactory returns as small ones. With a flock of 50, each bird should be allowed 5 square feet of room. With larger flocks not quite so much space per fowl will be required. One can obtain satisfactory returns with 100 fowls of the smaller breeds in a house with 20 by 20 feet of floor space. If fowls are crowded, good results in egg production can not be expected.

The width of the poultry house depends upon size of the flock. Under most conditions, a house 14 or 16 feet wide is ample for each pen. One should plan to use standard lengths of timber, so that as little waste as possible will occur in sawing. Poultry houses 20 feet wide are being constructed to-day quite generally by farmers with large flocks, this size being economical in cost of material, and providing a maximum of space for the same.

The foundation of the poultry house should be of concrete or stone, if intended for a permanent laying house. This foundation should be deep enough in the ground not to be affected by the action of frost, and should rise 6 to 12 inches above the surface. The thickness of wall will depend on local conditions, ranging from 6 to 8 inches. Portable colony houses may be built on 4 x 4 runners. Halpin and Ocock, of Wisconsin University, recommend the use of

“two small trees of some durable wood which may be flattened off on top and tapered off at both ends so as to make a satisfactory runner.”

The walls of the poultry houses are built of wood, brick, concrete, or stone. The most common method is to use 2 x 4 studs nailed to 2 x 6 sills, over which matched siding is nailed horizontally. When well put together, this makes a wall free from drafts and very satisfactory. If rough boards are used, battens or strips should be tacked over any cracks. It is not desirable to place siding over the

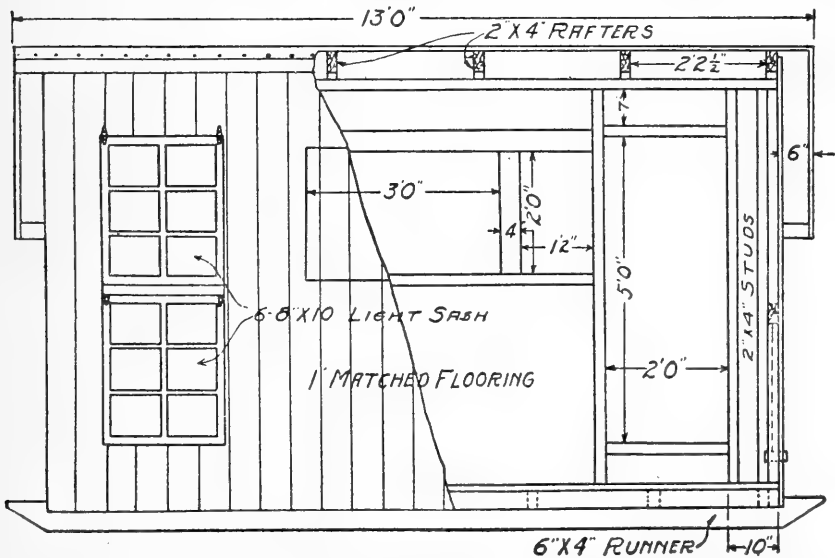

Figure 252.—Front elevation building plans of the Purdue Brooder Colony House. Reproduced from Extension Bulletin 52, Purdue University.

studs on the inside, for in that case rats and mice will find a place for hiding. A wooden wall in winter is most satisfactory, as solid concrete or stone may be moist or frosty under some conditions. Concrete or brick walls that are partly hollow are preferable to the solid wall.

The roof of the poultry house should be strong, simple, and comparatively inexpensive. A single-span or shed roof is most common and can be built with least cost. If the house is over 14 feet wide, the usual 2 x 4 rafters should be

supported. A combination roof has a double pitch, having a short pitch in front and a long one behind. This type of roof is well suited to buildings wider than 14 feet, and gives a strong construction. A two-pitch, or gable-roof, house usually has rafters of the same length, coming to a ridge in the center. This gives a high center to the pen, hence a loss of heat, so that in winter the house is likely to be cold. A ceiling is sometimes built in such a house, and attic storage room thus provided. What is called the half-monitor roof has one long sweep of rafter for perhaps two thirds the

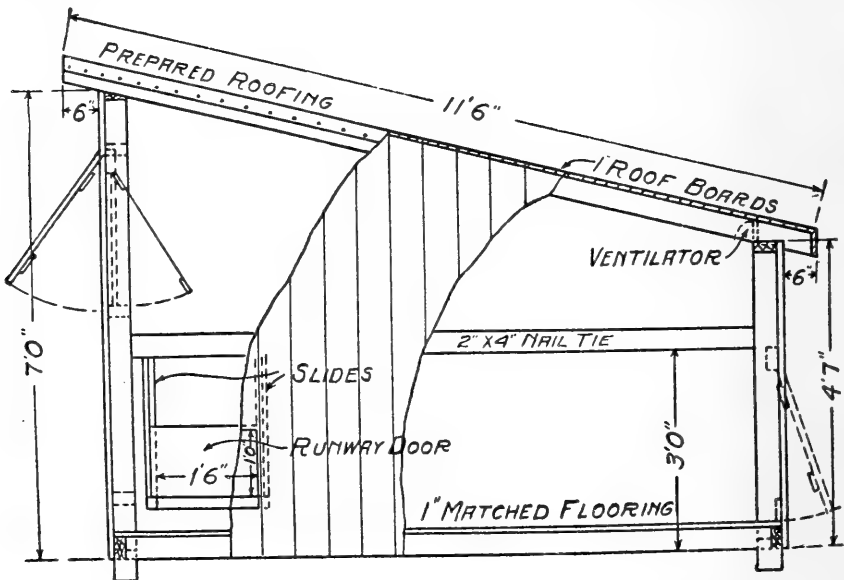

Figure 253.—End view Purdue Brooder Colony House. Reproduced from Extension Bulletin 52, Purdue University.

width of the house. Below the high point of rafter a vertical wall is dropped sufficiently to allow a line of windows. From the bottom of the window sill, a shorter length of rafter gives the necessary front pitch to the roof. There are also houses with the fronts slanting to the ground, and others of wood that have roofs of the tent form, with no side walls in front or behind. A roof covering of rough boards and asphalt or tarred composition paper of some sort gives good

satisfaction. Wooden shingles in most localities are too expensive, and in the colder sections shingle roofs are too drafty and cold in winter.

The floor of the poultry house should be of concrete in the permanent house; but, in the colony house, one of matched flooring is best. Effort should be made to keep the floor dry, and to prevent the harboring of rats or other vermin.

Partition material in the poultry house should usually be of wire netting. If the house is long, a close wooden or

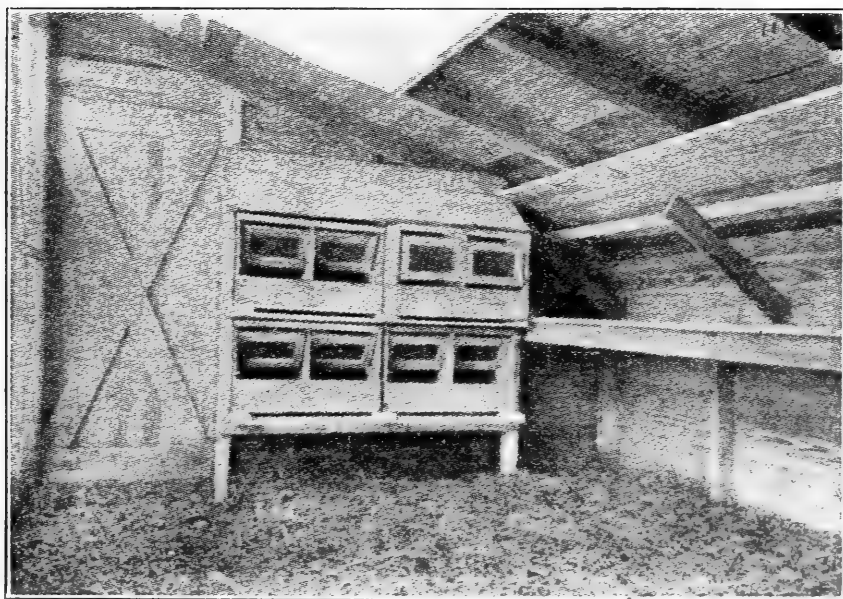

Figure 254.—Interior of poultry house, showing trap nests. Reproduced from Circular 37, Purdue University.

cloth partition at intervals is desirable, in order to strengthen the building, and also to prevent drafts. A house of six pens might have one solid central partition, and others of wire.

The windows of the poultry house should be adjusted to local conditions. In the southern states, glass should be unnecessary. In the colder North, an arrangement by which one sliding glass window can be arranged in connection with cloth-screened openings will give the best satisfaction. The

windows should have a covering of wire screening, with curtains that are to be used only in severe weather. Some men, in fact, keep permanent open fronts in their houses, never using glass or cloth screen, and do not believe that their birds suffer from cold at any time.

Perches should be in the warmer part of the pen, free from drafts, and not high above the floor. The perches should be 12 inches apart, and not nearer the wall than 15

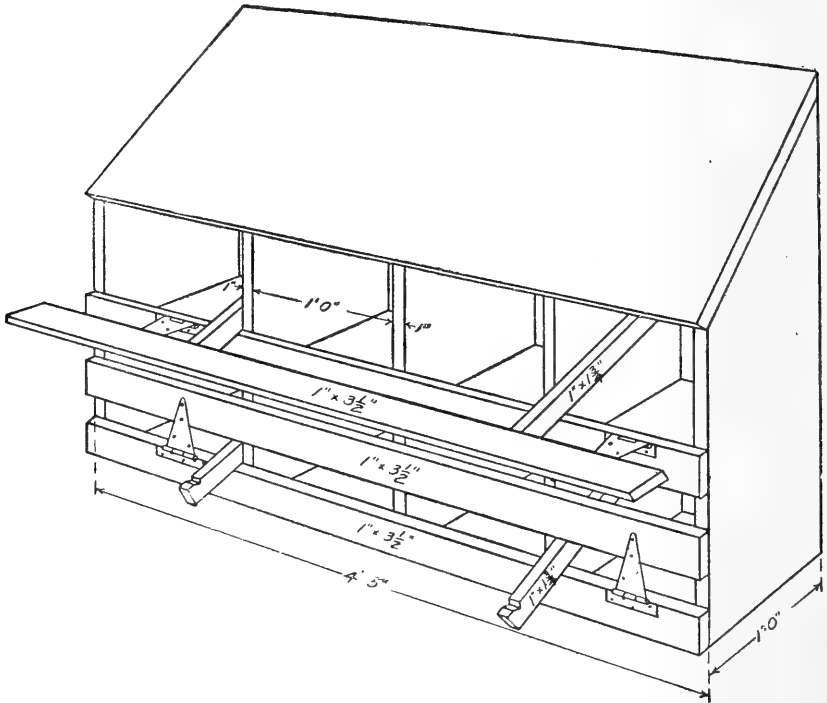

Figure 255.—Details of wall nests. From Extension Bulletin 57 of Purdue University.

inches. They should be fastened together in a frame and hinged to the wall, being supported level with standards, or legs. It is a good plan to have a board platform a few inches below the perch, on which the droppings may be caught. The perches may be raised as desired, and the droppings removed. Perches of 2 x 4 pieces, on edge, with rounded corners are recommended.

The nests should be against the wall, and be 12 or 14 inches square, according to the size of fowl. Nests are sometimes placed below the dropping board, the hens entering from the back and the eggs being removed from the front by means of a hinged door. These nests have the advantage of being rather dark, as hens under such conditions rarely eat their eggs. Open nests may be fastened to the side of the pen, if desired, a common method. Trap nests are used in many houses to-day. The principle of this nest is that, when the hen enters, she springs a trapdoor, and so

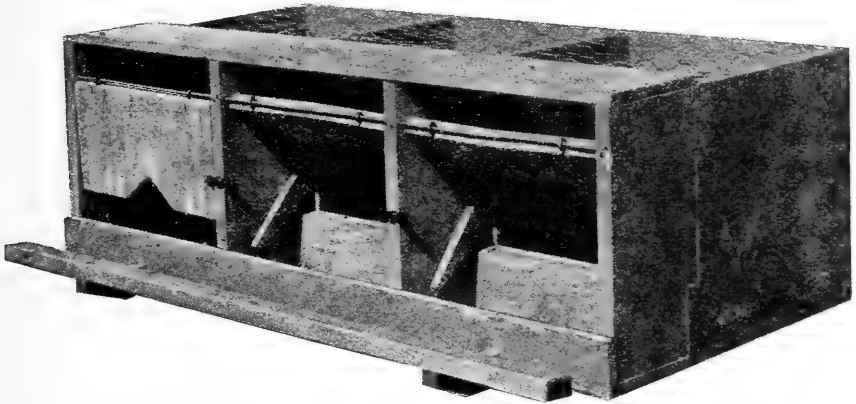

Figure 256.—A three-section trap nest, showing one section shut. Photograph from United States Dept. of Agriculture.

is confined until released by the poultryman. Thus he knows just what hens lay each day, and makes a record of the same. Hens laying in trap nests usually are numbered with metal leg-bands.

A dust bath in the poultry house is most important. The process of dusting is the method by which the bird keeps herself free from lice and similar pests. Many poultrymen have a corner of the pen arranged so that road dust, sifted coal ashes, or dry sand may be put there for dusting. A depth of 3 or 4 inches of dust enclosed by pieces of common six-inch fencing boards will do. No poultry house should be without a dust bath, especially during the winter.

IF YOU HAD "CHICKEN FEVER," COULD YOU

1. Describe the important features of the laying house?
2. Explain the purpose of the fattening house?
3. Describe a hover and its use?
4. Tell of the construction and value of the colony house?
5. Compare a good and a bad site for poultry buildings?
6. Figure out the size of house you might need, and tell why?
7. Compare the single and the double-pitch roof?
8. Discuss the subject of window covering?
9. Instruct in the essentials of perch construction?
10. Tell where to place the nests and the size they should be made?

SOME INTERESTING THINGS TO BRING TO SCHOOL

11. A picture of the poultry yard at home, showing buildings.
12. A picture of the best poultry building you know of in the vicinity.
13. A drawing showing cross-section construction of some poultry house of which you know.
14. A report on the roost arrangement in different poultry buildings.
15. A report on the locations of a few poultry yards on different farms.
16. A statement of the number of farmers in the vicinity who keep chickens but have no special poultry houses for them.

CHAPTER XLV

DISEASES AND AILMENTS OF POULTRY

Poultry is not only universal on the farm, but frequently raised on the home lot in smaller villages and towns. Thus a large percentage of our population comes in intimate contact with poultry, but more especially with chickens. Unfortunately many of these birds are given inferior care. They are kept in unsanitary pens, and, as a result, disease or various ailments affect them. Under such conditions comes a call for information as to the nature of the trouble and means of remedying it. This chapter, therefore, will discuss briefly the more common afflictions of poultry, with suggestions of preventive measures or curative treatment.

Roup. This is a germ disease that affects the nose, mouth, or eye of chickens. In the nasal form there is a thin, watery, offensive discharge from the nostrils, which finally becomes thick and stops the nasal passage. In the mouth form, yellow or yellow-white patches and ulcers, similar to diphtheria, occur. In the eye form the membrane covering the front of the eye becomes inflamed, a watery, whitish fluid accumulates, and the eyelids stick together. The birds sneeze and throw off mucus, the appetite fails, diarrhea occurs, and there is marked weakness. In connection with each form, in order, comes catarrh and discharge of mucus; the formation of a membrane in the mouth and throat, similar to diphtheria; and inflammation of the eyes, and often destruction of the eyeball.

It is of the greatest importance to provide sanitary quarters for fowls, to ward off this disease. Good ventilation should be provided in the poultry house, but no drafts should be permitted. It is important that the house be

kept dry, and cleaned and disinfected daily. A 5 per cent solution of crude carbolic acid, mixed with whitewash is an excellent disinfectant, using 2 pounds of the acid to 5 gallons of the whitewash. A preventive measure used with success in recent years is the bacterin treatment, inoculating the fowls with a product made from the disease germs. This treatment makes the birds immune.

For medical treatment of roup, stick silver nitrate is used for burning ulcers in the mouth, and, after the white matter of the eye is wiped off with absorbent cotton, the silver nitrate may be used here. The nasal passage may be washed



Figure 257.—A hen sick with roup. Photograph from Ohio State University.

out with a 20 per cent solution of common baking soda (sodium bicarbonate), using either a medicine dropper or small syringe, forcing the fluid through the passage into the mouth. This treatment may be fol-

lowed with peroxide of hydrogen. The affected parts should then be cleaned with essential oils, of which the following is recommended by Dr. B. F. Kaupp:* Oil of thyme 1 dram, oil of eucalyptus 20 drops, oil of petrol 2 ounces. This treatment should be given three times daily.

Fowl cholera is a germ disease, distributed by many agencies, as sick birds, water, wind, manure, insects, wild birds, etc. Cholera affects chickens, ducks, turkeys, geese, pigeons and wild birds, especially the buzzard. The germs exist under quite a wide range of conditions, and may live a long time. In protracted cases, writes Dr. Kaupp, "there is a noted loss of appetite, great prostration, staring feathers;

*Poultry Diseases and Their Treatment, 1914.

the bird mopes or sits around with tail and head down, giving a so-called 'ball' appearance, the comb is dark, the gait swaying, and there is trembling, convulsions, thirst, and severe diarrhea, with passages of a greenish-yellow color. There is high fever and the bird rapidly becomes emaciated." Post mortem shows enlargements of liver, spleen and kidneys, and unnatural dark color of these organs. The intestines are also inflamed, and may show hemorrhage.

Preventive measures against cholera require absolute cleanliness, and the liberal use of disinfectants. Dr. Kaupp reports that inoculating with vaccine made from germs producing the disease has given excellent results.*

Treatment of birds sick with cholera is not generally satisfactory, especially if the cases are bad, the best plan being to kill and burn the carcass. Sick birds should be isolated from the flock. It is a good plan to give the fowls antiseptic water, consisting of one teaspoonful of hydrochloric acid in a quart of water, to which is also added 1 per cent of copper sulphate and potassium permanganate.

Chicken pox is very closely related to roup, excepting that the face and comb are affected with scabby excrescences from the size of a pinhead to a pea. The same treatment should be given as for roup, and the affected parts should be bathed with antiseptics.

White diarrhea is a bacterial disease of an infectious nature that affects chicks at from one to four days of age. The disease may come from an infected egg, or from other flocks. The symptoms of the disease usually appear before the chicks are ten days old. The chicks appear "droopy," do not eat well, the wings hang low, there is general weakness, the birds peep constantly, and a loose, somewhat sticky discharge comes from the bowels, which more or less pastes up the vent. A dead chick will appear very bloodless and thin, with crop and intestines empty or containing slimy material. There is no cure for this disease. It is of the first importance

*Poultry Diseases and Their Treatment, 1914.

that eggs for hatching come from a flock free from this malady. The disease may be detected by a blood test of egg-laying hens, and such tests are made by some of the state experiment stations. Proper sanitation of the incubator and chicken quarters is vitally necessary. The incubator should be kept in the dark until the chicks are removed to the brooder, thus in a measure preventing the chicks from picking bits from the eggs. It is also wise to keep the chicks in small lots, thus restricting spread of the disease. Sour milk is highly recommended as a preventive of the disease.

Tuberculosis of fowls, or what is known as avian tuber-

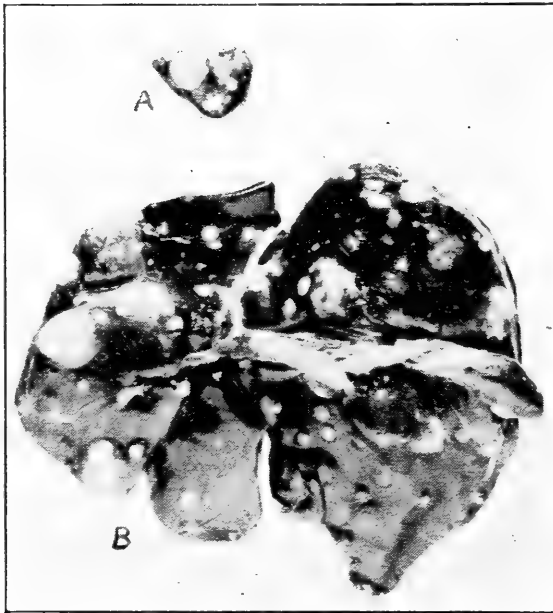

Figure 258.—The spleen (A) and liver (B) of a tubercular fowl. The white spots are nodules, or tubercles. Photograph from Ohio State University.

culosis, has been known in the United States since 1899, it being first reported in investigations at the Oregon Experiment Station. Since then it has been located in different parts of the country, and the disease seems to be becoming quite common. Tuberculosis of fowls is much the same as that of humans, cattle, or swine, and affects the birds in

like manner. There is emaciation, paleness of comb, wattles, and skin, oftentimes a persistent greenish diarrhea, lameness, and in the later stages the feathers become dry and ruffled, and the bird is weak and stands about, moving but little. A post mortem examination shows the liver more or less thickly

covered with yellowish spots varying from very small size to as much as a half inch in diameter. The intestines are also often extensively covered with tubercles. In fact the disease in advanced stage affects all the internal organs, and even the skeleton itself.

There is no remedy for this disease. All known affected birds should be killed and burned, and the poultry houses and yards be thoroughly disinfected. Whitewash should be freely used in the houses. As the disease is known to be transmitted through the eggs, care should be taken to see that eggs for setting, as well as purchased fowls, come from healthy flocks. If fowls roam among droppings from tubercular cattle or swine, the disease may be contracted.

Gapes is a parasitic disease due to small worms attached to the inside of the windpipe. These worms increase and finally choke the chicken, which gapes for breath, hence the name. Unless the worms are removed, death may ensue. The female worm while in the windpipe produces many eggs, which are either sneezed out by the fowl or are swallowed and passed off in the droppings. In a few days, under favorable conditions, these eggs hatch, and the young worms remain alive in the soil a long time or may be picked up by the chickens and the trouble thus be continued. A common treatment recommended is to take a long horse hair and twist the ends together to make a loop. By holding the chick's head in one hand, the neck extended, the bill wide open, one may insert the hair loop down the windpipe about an inch, give it two or three turns, and then withdraw, in which event several worms will come out. It is recommended to dip the hair loop in a solution of creolin, one teaspoonful to a quart of water, before placing in the windpipe. Turpentine is also used in the same manner. This will destroy worms by contact. It is also suggested that the creolin solution may be sprayed in the throat with a common atomizer, which will kill the worms so that the chick may cough them up.

Disinfectants should be liberally used about the poultry plant in order to ward off this parasite.

Scaly leg, or scabies, is due to a parasite that develops on the legs of chickens and turkeys. The parasite gets under the scales on the legs and bites the tissue, causing an irritation and blistering. From these blisters when ruptured come the scales which appear in many instances as a thick coat or mass on the feet and legs. This condition is associated with extreme itching of the parts, and birds may stop laying and die from the influence of the parasites.

Scabies is easily destroyed. The scabby patches should be thoroughly soaked with suds made from tarred soap or other antiseptic soap. After removing the scales, the legs should be scrubbed with kerosene.

If the roosts and droppingboards of the poultry house are from time to time thoroughly sprayed with kerosene, scaly legs will not be likely to cause trouble.

Lice and mites among fowls cause much irritation and loss of condition. There are many forms of these external parasites, of which seven are common on chickens. These are known as body lice, head lice and feather lice.

Body lice are most abundant under the wings and about the vent. These lice lay eggs in clusters on the web part of the feather close to the quill, mostly on the small, short feathers below the vent. The eggs hatch in about a week, and the lice reach full size in about 20 days.

Feather lice, which are usually found on the feathers of the back or breast of mature fowls, even though common, are not so troublesome, as they feed on the feathers and scales along the quills. Both body and feather lice are easily gotten rid of, either by the use of sodium fluoride, a powder poisonous to poultry lice, applied among the feathers next to the skin, or by blue ointment about the vent, using a piece about the size of a pea. When sodium fluoride is used, "not more than 12 small pinches should be put on one fowl

at a time, as too much is injurious.”* One pound of powdered sodium fluorid will treat 100 fowls.

Head lice are found on the heads of chickens of all ages, but especially young chicks. These lice may be killed by applying a drop of vaseline or melted lard to the top of the head, under the wings, and around the vent. Clean management and proper sanitation are safeguards against lice.

Chicken mites are very small external parasites that differ from lice, in being blood suckers, living on the blood of the fowl. The mites hide in the cracks about the roosts and droppingboards much of the time, especially during the day, coming out at night and crawling on the birds. These pests are easily gotten rid of by the use of kerosene or whitewash about the interior of the poultry house.

Stick-tight fleas are common on fowls in the southern and southwestern states. They locate in clusters on the comb and wattles and around the eyes. They breed in cracks in the poultry house, and among refuse material. Their attacks, if not prevented, may result in the death of young chickens, and will cause hens to stop laying. Treatment requires greasing the comb and wattles with a mixture of 1 part kerosene and 3 parts lard. Poultry buildings should be thoroughly sprayed with disinfectants or whitewashed.

Crop-bound, or impaction of the crop, is due to swallowing substances too large or coarse to pass on into the stomach and gizzard. Small feathers, straw, roots, parings, etc. generally cause the trouble. In a well developed case of crop-bound, it is recommended† to mix a teaspoonful each of castor oil and hot milk, and pour through the throat into the crop, followed with a gentle kneading of the crop with the fingers, and softening the mass, if possible, so that it will pass on through the digestive tract. Probably it will be wiser in most cases to destroy the affected bird.

Bumble foot is a swelling on the bottom of the foot of fowls, which is comparable with a “stone bruise.” It is

*Lice, Mites and Cleanliness. Farmers' Bulletin 1110, U. S. Dep't. of Agr.
†Poultry Manual. By F. L. Sewell, Ida E. Tilson and others. 1912.

usually caused by jumping from roosts to hard floors. When the swelling reaches a certain stage, pus forms therein. At this stage the bottom of the foot should be opened, and the swelling drained, washed with sterilized water, and cleaned thoroughly with a weak solution of carbolic acid or tincture of iodine. The bird must then be kept on clean straw until, after further treatment, the foot has healed. Heavy fowls should not be compelled to fly from high roosts.

Freezing of comb and wattles of fowls is not unusual in the colder latitudes. In severe cases death may follow the freezing. If the affected parts have not been thawed, they should be brought back to as near normal condition as possible by rubbing with snow or cold water, and gradually thawing. After thawing, apply to the affected parts either vaseline, glycerine, or tincture of myrrh.

Egg-eating by hens is a bad habit which is usually taken up by accident, due to a broken or frozen egg. In some instances a number of hens in a pen will become egg-eaters, and the habit will become serious. Eggs are not so readily eaten in a dark nest, so if the boxes are arranged so that the hens must enter from the back side, away from the light, the eggs will not be so visible and probably will not be eaten. Another preventive method is to cut off the sharp point of the beak, without cutting into the sensitive part.

Cannibalism among chicks may become quite common, especially when they are confined in the brooder in large numbers. This is due to improper nutrition and overcrowding. If the chicks do not get green stuff, such as sprouted oats, bugs, etc., they tend to pick at various objects, including their own kind. If blood starts, this satisfies the craving for animal food, and they pick on the injured chick until it is killed and partly eaten. Sour milk, sprouted oats, chunks of green sod, and bits of meat, prevent this habit. Out door exercise each pleasant day is also highly desirable. Regarding overcrowding, it is recommended* to brood not

*Baby Chick Troubles and Their Control. E. L. Dakan, Bulletin No. 5.

more than 300 under one stove, with 200 a safer number.

Leg weakness is quite common in early hatched flocks that are kept closely confined. While this trouble is not well understood, it is believed to be due to a lack in nutrition, possibly mineral matter. Under ideal management, with plenty of exercise and a liberal feed of bone meal, milk, and green food, leg weakness should not exist.

HOW IS THIS FOR A POULTRY QUESTION BOX?

1. What forms of roup are there, and how identified?
2. How would you treat a case of roup?
3. Describe an advanced stage of chicken cholera.
4. Is treatment for cholera satisfactory?
5. When and where was fowl tuberculosis first discovered in America?
Is there a remedy for this disease?
6. How would you treat a case of gapes?
7. Describe the development of scaly leg.
8. Where do body lice live on chickens, and how do they reproduce?
9. How do mites get their nourishment?
10. What leads a hen to the egg-eating habit?

MAKE A FEW OBSERVATIONS

11. Try to trace the origin of a case of roup.
12. Get a sick fowl and determine the trouble.
13. If chickens with gapes are available, try spraying the throat with creolin solution in an atomizer and note result.
14. Bring a case of scaly leg to the class.
15. See how many forms of lice you can find among your own poultry.
16. Survey the neighborhood and ascertain where poultry diseases occur, and how cases are treated.



APPENDIX*

TABLE A

Dry matter and digestible nutrients in some common feeding stuffs.

(Total pounds in 100 of feed.)

Kind of feed.	Dry matter.	Protein	Carbo- hydrates	Fat.	Total nutrients	Nutri- tive ratio.
Corn, dent.....	89.5	7.5	67.8	4.6	85.7	1: 10.4
Corn, flint.....	87.8	7.7	66.1	4.6	84.2	1: 9.9
Corn meal or chop....	88.7	6.9	69.0	3.5	83.8	1: 11.1
Corn and cob meal....	89.6	6.1	63.7	3.7	78.1	1: 11.8
Gluten feed, high grade.	91.3	21.6	51.9	3.2	80.7	1: 2.7
Oats.....	90.8	9.7	52.1	3.8	70.4	1: 6.3
Ground oats.....	89.2	9.4	51.4	4.1	70.0	1: 6.4
Wheat bran.....	89.9	12.5	41.6	3.0	60.9	1: 3.9
Wheat middlings—flour	89.3	15.7	52.8	4.3	78.2	1: 4.0
Wheat middlings, stand- ard.....	89.5	13.4	46.2	4.3	69.3	1: 4.2
Cotton seed.....	90.6	13.3	29.6	16.5	80.0	1: 5.0
Cotton-seed meal, choice	92.5	37.0	21.8	8.6	78.2	1: 1.1
Cotton-seed meal-good..	92.1	31.6	25.6	7.8	74.8	1: 1.4
Cotton-seed hulls.....	90.3	0.3	33.3	1.5	37.0	1:122.3
Linseed-meal old process	90.9	30.2	32.6	6.7	77.9	1: 1.6
Soy bean.....	90.1	30.7	22.8	14.4	85.9	1: 1.8
Tankage—Over 60% P.	92.6	58.7	12.6	87.0	1: 0.5
Corn fodder—green....	21.9	1.0	12.8	0.4	14.7	1: 13.7
Corn stover, medium in water.....	81.0	2.1	42.4	0.7	46.1	1: 21.0
Corn silage, mature....	26.3	1.1	15.0	0.7	17.7	1: 15.1
Alfalfa, green.....	25.3	3.3	10.4	0.4	14.6	1: 3.4
Alfalfa, hay.....	91.4	10.6	39.0	0.9	51.6	1: 3.9
Red clover hay.....	87.1	7.6	39.3	1.8	50.9	1: 5.7
Timothy hay.....	88.4	3.0	42.8	1.2	48.5	1: 15.2
Cow pea hay.....	90.3	13.1	33.7	1.0	49.0	1: 2.7
Mangel wurzel.....	9.4	0.8	6.4	0.1	7.4	1: 8.2
Skim milk (separator) .	9.9	3.6	5.1	0.2	9.1	1: 1.5

* Note: The tables in the appendix are compiled from "Feeds and Feeding" by W. A. Henry and F. B. Morrison, 1917 edition, which volume contains standard analyses of feeding stuffs and feeding standards.

A TABLE OF FEEDING STANDARDS

The following table is made up from the modified Wolff-Lehman feeding standards, as arranged by Henry and Morrison. The purpose of this table is to enable one to work out a few easy problems in feeding. For example, if we assume one has a horse at light work, and is using feeds given in table A, then with the aid of table B, he should be able to figure out if the ration fed is supplying the animals' needs. The application of these tables is explained in Chapter IX.

TABLE B
Per day 1,000 pounds live weight.

Animal	Dry matter Pounds	Digestible Protein Pounds	Total digestible nutrients Pounds.	Nutritive ratio.
<i>Dairy cows</i>				
For maintenance.....		0.700	7.925	
<i>To maintenance allowance add:</i>				
For each lb. 2.5 per ct. milk....		0.045-0.053	0.256	
For each lb. 3.0 per ct. milk....		0.047-0.057	0.286	
For each lb. 4.0 per ct. milk....		0.054-0.065	0.346	
For each lb. 5.0 per ct. milk....		0.060-0.073	0.402	
<i>Growing fattening steers</i>				
250 pounds.....	25.6	3.0	17.7	1:4.9
500 pounds.....	23.9	2.1	15.8	1:6.5
800 pounds.....	21.4	2.0	14.3	1:6.2
<i>Fattening 2-yr. old steers on full feed</i>				
First 50-60 days.....	22.0-25.0	2.0-2.3	18.0-20.0	1:7.0-7.8
Third 50-60 days.....	18.0-22.0	1.8-2.1	16.0-18.5	1:7.0-7.8
<i>Horses at medium work.....</i>	16.0-24.0	1.4-1.7	12.8-15.6	1:7.8-8.3
<i>Fattening lambs</i>				
Weight 50-70 lbs.....	27.0-30.0	3.1-3.3	19.0-22.0	1:5.0-6.0
Weight 90-110 lbs.....	27.0-31.0	2.3-2.5	19.0-23.0	1:7.0-8.0
<i>Growing fattening pigs</i>				
Weight 50-100 lbs.....	37.0-40.8	5.5-6.0	32.9-36.4	1:5.0-5.6
Weight 100-150 lbs.....	32.4-35.8	4.4-4.9	28.8-31.9	1:5.5-6.2
Weight 150-200 lbs.....	29.0-32.0	3.5-3.9	25.8-28.5	1:6.2-7.0
Brood sow with pigs.....	20.0-24.0	2.4-2.7	18.0-21.0	1:6.0-7.0

BIBLIOGRAPHY

- Types and Market Classes of Live Stock. H. W. Vaughan.
Types and Breeds of Farm Animals. C. S. Plumb.
Shorthorn Cattle. Alvin H. Sanders.
History of Shorthorn Cattle. James Sinclair.
The Story of the Herefords. Alvin H. Sanders.
History of Aberdeen-Angus Cattle. MacDonald and Sinclair.
The Guernsey Breed. Charles L. Hill.
Cyclopedia of Farm Animals. Edited by L. H. Bailey.
Dairy Cattle and Milk Production. C. H. Eckles.
Dairy Cattle—Feeding and Management. C. W. Larson.
Productive Dairying. R. M. Washburn.
Management of Dairy Plants. M. Mortenson.
The Horse and its Relatives. R. Lydekker.
A History of the Percheron Horse. Sanders and Dinsmore.
Productive Horse Husbandry. Carl W. Gay.
The Horse in Health and Disease. F. B. Hadley.
Training and Breaking of Horses. M. W. Harper.
The Horse Book. J. H. S. Johnstone.
Swine in America. F. D. Coburn.
Pork Production. William W. Smith.
The Hog Book. H. C. Dawson.
Productive Swine Husbandry. George E. Day.
Productive Sheep Husbandry. W. C. Coffey.
Sheep Farming in North America. John A. Craig.
Sheep Farming in America. J. E. Wing.
Sheep Management. Frank Kleinheinz.
Modern Milk Goats. I. Richards.
The Breeding of Animals. F. B. Mumford.
Breeding of Farm Animals. M. W. Harper.
Principles of Breeding. E. Davenport.
Breeding of Farm Animals. F. R. Marshall.
Principles and Practices of Judging Live Stock. C. W. Gay.
Live Stock Judging and Selection. R. S. Curtis.
Judging Farm Animals. C. S. Plumb.
Feeds and Feeding. W. A. Henry and F. B. Morrison.
Productive Feeding of Farm Animals. F. W. Woll.
The Nutrition of Farm Animals. H. P. Armsby.
Profitable Stock Feeding. H. R. Smith.
Principles of Feeding Farm Animals. Sleeter Bull.
The Feeding of Animals. W. H. Jordon.
Feeding of Dairy Cattle. A. C. McCandlish.
Common Diseases of Farm Animals. R. A. Craig.
Practical Poultry Production. Lamon and Kinghorne.
Poultry Production. W. A. Lippincott.
Mating and Breeding Poultry. Lamon and Slocum.
Principles and Practice of Poultry Culture. J. H. Robinson.
Productive Poultry Husbandry. H. R. Lewis.



INDEX

- Aberdeen-Angus cattle, 227.
Accredited herds, 264.
Acquaintance of breeders, 52.
Action of horse, 171, 188, 194.
Advertising, 61.
Age—
 of horse, 173.
 of pigs in relation to feeding, 420.
 of sheep, 358.
 influence of age in beef production, 257.
 on growth of sheep, 368.
 on milk production, 303.
Airing of eggs, 497.
Albumen of egg, 491.
Alfalfa, 108.
American saddle horse, 148.
 trotter or pacer, 150.
Amino acid, 77.
Analyses, feeding table, 537.
Analyzing feeding stuff, 84.
Ancestral line of dam, 42.
Ancestry in pedigree, 43.
Angora goats, 353.
Angus cattle, Aberdeen, 227.
Animal—
 as a machine, 17.
 character, variation in, 28.
 form, study of, 138.
 relation to function, 125.
 type and its importance, 138.
 knowledge of, 142.
Animals—
 and soil fertility, 16.
 buying immature, 127.
 community breeding of farm, 57.
 composition of, 65.
 defects of, 127.
 first use of by man, 12.
 for clothing, 13.
 for food, 14.
 for labor, 14.
 in early days, 138.
 judging farm, 125.
 most prepotent, 22.
 natural interest in, 129.
Ankle, cocked, 181.
Anthrax, 226.
Antiscorbutic vitamins, 71.
Artificial selection, 30.
Ash, mineral matter, 66.
Ass, 161.
Association—
 community breeders, 63.
 cow-testing, 308.
 registry, 53.
Aylesbury duck, 469.
Ayrshire cattle, 281.
Babcock text, 307.
Bacon hog—
 belly, 416.
 ham, 416.
 judging, 415.
 shoulder, 416.
 type, appearance, 417.
 hog, 415.
 score card, 415.
Balanced ration, 90.
Bantam, 467.
Barley, 106, 120.
Bates, Thomas, 219.
Beak, fowl's, 485, 503.
Bean, soy, 109.
Bedding for swine, 431.
Beef—
 baby, 249.
 bull, 247.
 calves, 247.
 cattle, breeds, 217.
 cows, feeding, breeding, 246.
 feeding, 245.
 form, 235.
 judging, 233, 243.
 production, 255.
 quality in, 238.
 score card for, 234.
 self-feeder for, 255.
 selling, 261.
 separate care, 262.
 type, 301.
Belgian horse, 158.
Belly, hogs, 412, 416.
Belted, cattle, Dutch, 285.
Benefits, club, 447.
Berkshire swine, 390.
Bermuda grass, 104.
Big China swine, 392.
Bile, 78.
Black-faced Highland, 352.
Black-leg, 264.
Blanketing horses, 210.
Blastoderm, 491.

- Boar—
 feeding, 425.
 removing tusks, 435.
 wild, 389.
- Body of carriage horse, 185.
 of dairy cow, 293.
 of hog, 410.
- Body lice, 532.
- Bog spavin, 178.
- Book, private flock, 381.
 swine herd, 436.
- Booth family, 219.
- Border Leicester sheep, 349.
- Bourbon Red turkey, 468.
- Boys' and girls' clubs, 440, 445.
- Brahma, light, 466.
- Bran, 119.
- Breaking colts, 212.
- Breast harness, 215.
- Breed cattle—
 Hereford, 223.
 Holstein-Friesian, 274.
 Jersey, 269.
- Breed character, 36.
- Breed influence in beef production, 256.
 in feeding sheep, 369.
- Breed, special-purpose, 48.
- Breeders', acquaintance of, 52.
- Breeders' associations, 63.
- Breeders', suggestions to, 48.
- Breeding—
 community, 57, 60, 62.
 growing cattle, 248.
 heredity in stock, 22.
 ideal in, 23.
 identification of stock, 54.
 method in, 59.
- Breeds—
 beef cattle, 217.
 dairy cattle, 269.
 geese, 471.
 horses, 144.
 influence of in milk production, 302.
 in pork production, 421.
 literature of, 55.
 poultry, 459.
 sheep and goats, 333.
 stories of, 52.
 swine, 389.
- Bridle, 214.
- Brome grass, 103.
- Bronze turkey, 467.
- Brood mare, feeding, 201.
- Brood sow, feeding, 423.
- Brooder, 517.
- Brown Swiss cattle, 284.
- Bull, beef, 247.
 feeding dairy, 319.
 form, dairy, 290.
- Bumble foot, 533.
- Buying immature animals, 127.
- Byfield swine, 392.
- By-laws, association, 451.
 club, 443.
- By-products of cereals, 116.
- Cake, cold-pressed cottonseed, 122.
- Calculating rations, 93, 94, 95.
- Calf, feeding, 247, 311, 312.
- Calorie, 79.
- Calorimeter, 80.
- Canada field peas, 109.
- Candling eggs, 492.
- Cannibalism among chicks, 534.
- Cannon bone, 166, 193.
- Carbohydrates, 67, 70, 77.
- Care of cattle, 262.
 of horses, 208.
 of sheep, 379.
 of swine and pigs, 430.
- Carrots, 113.
- Cattle—
 Aberdeen-Angus, 227.
 characteristics, 228.
- Ayrshire, 281.
 characteristics, 282.
 distribution, 284.
 milk, 283.
- beef breeds, 217.
 feeding, 245.
 quality, 238.
 score-card for, 234.
 self-feeder for, 259.
 selling margin in, 261.
- Brown Swiss, 284.
- dairy breeds, 269.
 breeding, 310.
 quality, 290.
 temperament, 290.
- Devon, 286.
- Dexter, 286.
- Dutch Belted, 285.
- feeding standards, 96, 245, 310.
- French Canadian, 285.
- Galloway, 231.
 growing breeding, 248.
- Guernsey, 278.
 characteristics, 279.
 distribution, 281.
 prices, 281.
- Hereford, 223.
 characteristics, 225.
 Polled, 226.

- Holstein-Friesian, 274.
 characteristics, 275.
 distribution, 278.
 milk, 276.
 prices, 278.
- Jersey, 269.
 characteristics, 270.
 milk, 272.
 prices, 273.
- judging beef, 233.
 breeding beef, 243.
 dairy, 288, 291.
- Kerry, 285.
- Red Polled, 286.
 short-fed, 252.
- Shorthorn, 218.
 characteristics, 221.
- Wilk White, 217.
- Cereals, 104, 116.
- Character, knowledge of breed,
 36.
 variation in animal, 28.
- Characters, latent hereditary,
 26.
 peculiar, 26.
 selection of, 32.
- Charbon, 266.
- Cheshire swine, 402.
- Chester White, 397.
- Cheviot, 345.
- Chicken mites, 533.
- Chicken pox, 529.
- Cholera in fowls, 528.
 in hogs, 434.
- Chop feed, 200.
- Chyle, 78.
- Classification of live stock, 139,
 141, 333.
 of market wool, 327.
- Clipping horse, 209.
- Clothing, use of animals for, 13.
- Clover, red, 107.
- Clubs—
 benefits, 447.
 boys' and girls', 440, 445.
 constitution, 443.
 county committee, 445.
 object of, 441.
 organization, 442.
 prizes for members, 446.
 standardization of work, 444.
- Clydesdale horse, 155.
- Cob meal, 118.
- Cochin, 466.
- Collar, 215.
- Colling, Charles and Robert, 218.
- Colony house, 518.
- Color markings, 24.
- Colt, breaking and training, 212.
- Colt's teeth, 173.
- Comb of fowl, 487.
- Combing wool, 327, 328.
- Composition of plants and ani-
 mals, 65, 69.
- Concentrates, 68, 115, 312.
- Constitution and by-laws, 443.
- Coop, shelter, 519.
- Co-operative marketing, 457.
- Co-operative shipping associa-
 tions, 450.
- Corn and cob meal, 118.
- Corn, Indian, 104, 116.
- Corn meal, 117.
- Cortex, wool, 323, 324.
- Cotswold, 349.
- Cotted fleece, 326.
- Cottonseed meal, 121.
 feed, 122.
 cake, 122.
- Coupling, horse, 168.
- Cow—
 body, dairy, 293.
 compared, 301.
 dairy form, 289.
 feeding, 313.
 food producer, 300.
 mammary development, 295.
- Cowpea, 109.
- Cows, feeding, 91, 246, 314, 318.
 score card for dairy, 291.
- Cow-testing associations, 308.
- Crack, quarter, 180.
 toe, 180.
- Crimp of wool, 324.
- Crop-bound, 533.
- Crop, fowls', 503.
- Cross-bred animals, 39.
- Croup, horse's, 169.
- Cruickshank, Amos, 220.
- Culling of herd, 32.
 of poultry, 483.
- Curb, 177.
- Dairy animal, size, 288.
- Dairy bull, feeding, 319.
 form, 290.
- Dairy calf, feeding milk, 311.
 feeding roughage, 311.
- Dairy Cattle—
 body, 293.
 breeds, 269.
 feeding, 91, 96, 310, 312, 314.
 food producer, 300.
 judging, 288, 291.
 parts, 292, 299.
 score card, 291.
- Dam, line of, 42.
- Decision of the judge, 137.

- Defects in animals, 127.
 Delaine Merino, 335.
 score card, 363, 364.
 Delaine wools, 328.
 Density of fleece, 325.
 Devon cattle, 286.
 Dexter cattle, 286.
 Dextrose, 70.
 Diarrhoea, white, 529.
 Difficulty of co-operative marketing, 457.
 Digestible nutrients, 84.
 Digestion, process of, 74.
 Diseases and ailments of poultry, 527.
 Distribution of—
 Ayrshires, 284.
 Guernseys, 281.
 Holstein-Friesians, 278.
 Jerseys, 273.
 Shorthorns, 220.
 Docking sheep, 385.
 Domestic animals, a study of, 9.
 Domestic wools, 328.
 Dorset Horn sheep, 130, 344.
 Draft horse—
 action, 194.
 appearance, 190.
 judging, 190.
 parts, 192, 194.
 score card, 192.
 Dropping sheep, 382.
 Dry cows, feed for, 318.
 Ducks—
 Aylesbury, 469.
 Cayuga, 470.
 Indian Runner, 470
 Mallard, 468.
 Muscovy, 470.
 Pekin, 469.
 Rouen, 469.
 types, 469.
 Wild, 468.
 Duroc-Jersey swine, 395.
 Dust bath for poultry, 525.
 Dutch Belted cattle, 285.
 Ear lobes, fowls', 485.
 Egg—
 color, 500.
 fertile, 491.
 freshness, 500.
 incubation, 492.
 parts, 491.
 score card, 481.
 Egg-eating hens, 534.
 Egg-laying type, 459.
 Egg-producing capacity, 484.
 Egg production, ration, 511.
 body changes due to, 486.
 color changes due to, 484.
 influence of molt on, 488.
 Eggs—
 incubation for, 498.
 market grades, 501.
 preservative for, 501.
 score card, 481.
 size and weight, 499.
 testing, 492.
 turning, airing, 497.
 Emden goose, 471.
 Energy value of food, 80.
 of feeding standards, 90
 Environment, 33.
 Epidermis wool, 323.
 Erepsin, 77.
 Ewe, feeding and caring for, 370.
 Exercise for bull, 247.
 for sheep, 381.
 for swine, 431.
 Expense of advertising, 61.
 of co-operative shipping, 455.
 Eye rings, fowls', 485.
 Fads, 51.
 Farrowing, 430.
 Fat content, 307.
 Fattening fowls, 513.
 cattle, 249.
 lambs, 374.
 pigs, 425.
 sheep, 374.
 yearlings, 375.
 Fatty acids, 78.
 Feather lice, 532.
 Feathers, 475.
 Fecundity, 24.
 Feed lot, 260.
 Feed racks for sheep, 387.
 Feeding—
 beef calves, 247, 313.
 beef cattle, 245, 246, 249.
 boar, 425.
 breeding stock, 370.
 brood sow, 424.
 dairy bull, 319.
 dairy calf, 311, 312.
 dairy cows, 91, 96, 310, 313.
 foal, 202.
 fowls, 503, 506, 508, 510.
 horse, 197, 198, 201, 203, 204.
 lambs, 371, 375.
 sheep, 367, 368, 369, 370, 373.
 steers, 250, 253.
 suckling pigs, 424, 425.

- swine, 418, 419, 420.
yearlings, 251.
- Feeding analysis, 537.
- Feeding standards—
analyzing, 84.
beef cattle, 245.
calculating, 93.
dairy cattle, 96.
energy value, 90.
selection of, 93.
table of, 538.
Wolff, 87.
Wolff-Lehmann, 89, 368.
- Feeds—
chop, 200.
concentrated, 115.
cottonseed, 122.
gluten, 118.
hominy, 118.
roughage, 100.
- Fiber of wool, 325.
- Fleas, stick-tight, 533.
- Fleece, 324.
- Flock book, 381.
- Foal, feeding, 202.
- Food—
animals as, 13.
carbohydrates, 77.
digestible nutrients in, 84.
effect of on milk yield, 305.
on egg quality, 507.
energy value, 80.
fat, 78.
green for fowls, 505.
heat value, 79.
mineral, 78, 421, 508.
palatability of, 81.
plant as source of, 65.
protein, 77.
required, 86.
- Foot and mouth diseases, 265.
- Forage, 107.
- Form—
beef animal, 235.
dairy bull, 290.
dairy cow, 289.
hog, 405.
relation of to function, 125.
study of, 138.
- Founder, 180.
- Fowls—
culling, 483.
diseases, 527.
feeding, 503.
housing, 515.
judging, 473.
parts, 474.
types and breeds, 459.
- Freezing comb and wattles, 534.
- French Canadian cattle, 285.
- Galloway cattle, 231.
- Gapes, 531.
- Geese, 471.
- Girls' and boys' clubs, 440, 445.
- Gizzard, 503.
- Glucose, 78.
- Gluten feed, 118.
- Glycerine, 78.
- Glycogen, 70.
- Goats, 353, 355.
- Grade animals, 39.
- Grades of stock, 140, 141.
- Grading live-stock shipments,
455.
wool, 327.
- Grain and roughage, 369.
- Grasses, 100, 104.
- Grease, yolk or, 326.
- Green animals, 127.
- Green food for fowls, 505.
- Grooming horses, 208.
- Grouping market live stock, 139.
flock sheep, 379.
- Growing breeding cattle, 248.
- Guernseys—
characteristics, 279.
distribution, 281.
milk, 280.
prices, 281.
- Gullet, 503.
- Haecker standards, 91.
- Ham, 416.
- Hampshire Down, 343.
- Harness, breast, 215.
- Hay, legumes, 107.
- Hays, pastures, etc., 100.
- Head lice, 532.
- Heat value, 79, 80.
- Heaves, 176.
- Hemorrhagic septicemia, 266.
- Hens, egg-eating, 534.
score card, 479.
- Herd book, swine, 436.
- Herd record, private, 53.
- Herds, accredited, 264.
advertising, 61.
- Hereditary characters, 26.
- Heredity, 21, 22.
- Herefords, 223.
characteristics, 225.
Polled, 226.
- Hog—
bacon type, 415.
cholera, 434.
condition, 407.

- early forms, 390.
 form of, 405.
 lard type, 405.
 market types, 404.
 points, 408, 416.
 quality, 407.
 score card, 404, 405.
 size, 404.
 weight, 404.
 Wild, 389.
- Holding sheep, 356.
 Holland turkey, White, 468.
 Holstein-Friesians, 274.
 characteristics, 275.
 distribution, 278.
 milk, 276.
 prices, 278.
- Hominy feed, 118.
- Horse—
 action, 171, 188, 194.
 age, 173.
 American saddle, 148.
 appearance, carriage, 184.
 draft, 190.
 Arab, 146.
 Belgian, 158.
 blanketing, 210.
 breeds, 144.
 care, 208.
 clipping, 209.
 Clydesdale, 155.
 development of breeds, 146.
 disposition, 172.
 fattening, 204.
 feeding, 197, 204.
 growing, 208.
 harness, 214.
 judging, 183, 195.
 Percheron, 153.
 points, 164, 181.
 prehistoric, 144.
 quality, 172.
 salting, 206.
 score card, 185, 192.
 shire, 156.
 soundness, 175.
 Suffolk, 159.
 teeth, 174, 175.
 Thoroughbred, 147.
 use, 197.
 watering, 205.
 work, 197.
- Hothouse lambs, 375.
- Houses—
 colony, 518.
 fattening, 517.
 floor, 523.
 foundation, 520.
 location, 519.
- partition material, 523.
 poultry, 515.
 roof, 521.
 size, 420.
 styles, 515.
 swine, 437.
 walls, 521.
 windows, 523.
- Hulls, oat, 120.
 Hurdle, sheep, 386.
 Hydrochloric acid, 77.
- Ideal in breeding, 23.
- Identification of breeding stock, 54.
- Immature animals, 127.
- Incubator, 494, 498.
 Incubation, 491, 498.
- Indian corn, 104, 116.
- Indian Runner, 470.
- Inheritance, 24.
- Intestines, 76, 503.
- Irish Grazer swine, 392.
- Jaw, horse's lower, 164.
- Jersey Red swine, 395.
- Jerseys—
 characteristics, 270.
 distribution, 273.
 prices, 273.
- Jowl of hog, 408.
- Judge, decision of, 137.
 capable, 128.
- Judging—
 bacon hog, 415.
 beef cattle, 233.
 breeding beef cattle, 243.
 comparative, 473.
 dairy cattle, 272, 288, 291.
 eggs, 481.
 farm animals, 125, 126.
 fowls, 473, 476, 478, 479.
 horses, 183, 190.
 lard-type hog, 413.
 sheep, 356, 361, 365.
 swine, 395, 404.
- Judgment of stockman, 126.
- Kemp, 326.
- Kentucky blue grass, 101.
- Kerry cattle, 285.
- Knitting wools, 327.
- Knowledge of breed characters, 36.
- Labor, use of animals for, 14.
- Lactation, 303.
- Lactials, 78.
- Lactose, 70.
- Lambs, feeding, 371.
 rations for, 374.

- Laminitis, 180.
 Langshan, 466.
 Latent hereditary characters, 26.
 Laying pen, 515.
 Leg weakness, fowls', 535.
 Leghorn, 464.
 Legumes, 107.
 Leicester, 348.
 Lice, 532.
 Light Brahma, 466.
 Lincoln Sheep, 350.
 Linseed meal, 121.
 Literature on breeds, 55.
 Litters, marking, 435.
 Live stock—
 associations, 452, 453.
 clubs, 440.
 commercial importance, 10.
 co-operative selling, 456.
 farming, 18.
 grading shipments, 455.
 judges, 126, 128.
 market classes, 139.
 Lump jaw, 264.
 Luster, 323.
 Machine, milking, 306.
 Maintenance ration, 87.
 Mallard duck, 468.
 Mammary development, 295.
 Manager, shipping, 453.
 Mangel-wurzel, 113.
 Margins, 261.
 Market grades of eggs, 501.
 of live stock, 139, 140.
 Market types, hogs, 404.
 Marketing sheep, 380.
 little pigs, 435.
 shipping stock, 453.
 Markings, color, 24.
 Meal, corn, 117.
 corn and cob, 118.
 cottonseed, 121.
 linseed, 121.
 meat, tankage, 122.
 Medulla wool, 323.
 Merino, 334.
 features, 336.
 score card, 363, 364.
 types, 335.
 Merit, 44, 50.
 Method in breeding, 59.
 in business, 53.
 in selection, 31.
 Middlings, wheat, 119.
 Milk, 123, 303, 304, 305.
 Milk fat, test, 307.
 Milk fever, 267.
 Milk goat, 354.
 Milk production, 24.
 factors influencing, 300, 304.
 Milk substitute, 312.
 Milk veins, 298.
 Milk wells, 299.
 Millet, 102.
 Mineral food for swine, 421.
 Mineral matter, 66, 78.
 Minorca, 465.
 Mites, 532, 533.
 Moisture in incubator, 496.
 Molt influence, 488.
 Mule, 161.
 Muscovy duck, 470.
 Mutton sheep, 359.
 Narragansett turkey, 468.
 Natural selection, 29.
 Navicular disease, 181.
 Nests, 524.
 Nodular disease, 384.
 Notes on animals, 136.
 Nutrients, 76, 81.
 Nutritive ratio, 81.
 Cats, 106, 120.
 Ohio farm bureau live-stock
 associations, 452.
 Orchard grass, 103.
 Organizing associations, 63, 450.
 Organs of digestion, fowls, 503.
 Origin domestic sheep, 333.
 live stock clubs, 440.
 Orpington, 464.
 Oxford Down, 341.
 Pace, movement, 171.
 Pacer, American, 150.
 Palatability, food, 81.
 Parasites, sheep, 383.
 swine, 431.
 Pastern, 167, 193.
 Pasture, 100, 318.
 Paved feed lot, 260.
 Peas, Canada field, 109.
 Pedigree—
 accuracy, 46.
 ancestry in, 43.
 bracket form of, 41.
 merit value, 38, 44.
 score card, 45.
 selection of, 36.
 Sophie's Bertha, 45.
 study of, 46.
 Villager, 42.
 Pekin duck, 469.
 Pelvic bones, 487.
 Pepsin, 77.
 Peptones, 77.
 Percheron horse, 153.

- Perches, 524.
 Persistence of heredity, 21.
 Pigs—
 care at farrowing in hot weather, 431.
 fattening, 425.
 feeding young breeding, 425.
 sucklings, 424.
 food, 419.
 grouping, 430.
 marketing litters, 435.
 Pin bones, 487.
 Pith, wool, 324.
 Plants—
 compared with animals, 72.
 composition of, 65.
 fat in, 68.
 mineral matter in, 66.
 protein in, 67.
 source of food, 65.
 Platform, swine feeding, 436.
 Plymouth Rock, 462.
 Points cut, 133.
 of the horse, 164.
 scale of, 129, 130.
 Poland-China swine, 392, 394.
 Poll, horse, 164.
 Polled cattle, Red, 286.
 Hereford, 226.
 Shorthorn, 223.
 Pork production, 418, 421.
 Poultry—
 culling, 483.
 diseases, 527.
 disqualification in judging, 478.
 feeding, 503.
 houses, 515.
 judge, 473, 476, 480.
 score card, 477.
 types and breeds, 459.
 Pox, chicken, 529.
 Prehistoric horse, 144.
 Premiums, 50.
 Prepotency, 22.
 Preservation of eggs, 501.
 Prices, 60.
 Guernseys, 281.
 Holstein-Friesian, 278.
 Jerseys, 273.
 Prizes, 446.
 Production, beef, 255, 258.
 milk, 24, 302, 303, 306.
 pork, 418.
 Protein, body, 70.
 in food, 77.
 in plant, 67.
 Proteoses, 77.
 Quality in cattle, 238, 258, 290.
 in hogs, 407.
 in horses, 172.
 in milk, 304.
 Quarter-crack, 180.
 Racks, sheep, 387.
 Rambouillet, 337, 338.
 Rams, feeding, care, 373.
 Rape, 112.
 Ratio, nutritive, 81.
 Ration, balanced, 90.
 calculating, 93-95.
 maintenance, 87.
 Rations—
 adjustment to standard, 98.
 dairy cows, 314.
 egg production, 511.
 fattening lambs, 371.
 fowls, 513.
 feeding fowls, 510.
 Record, private herd, 53.
 Red clover, 107.
 Red Polled cattle, 286.
 Redtop, 103.
 Registry associations, 53.
 Respiration calorimeter, 80.
 Rhode Island Red, 463.
 Ringbone, 179.
 Roaring, 176.
 Romney Marsh, 352.
 Root crops, 113.
 Rot, foot, 265.
 Rouen duck, 469.
 Roughage, 68, 100, 253, 311, 369.
 Roup, 527.
 Russian swine, 392.
 Rutabagas, 113.
 Rye, 106, 121.
 Saanen goat, 355.
 Saddle, 216.
 Saddle horse, American, 148.
 Salt for dairy cattle, 320.
 Scabies, 532.
 Scale of points, use, 129.
 Dorset Horn, 130.
 Score card, 129.
 American Poultry Association, 477.
 bacon-type hog, 415.
 beef cattle, 234.
 carriage horse, 185.
 commercial, 481.
 dairy cows, 291.
 Delaine Merino, 363.
 draft horse, 192.
 fat hog, 404, 405.
 fowls, 479.

- mutton type, 362.
 - pedigree, 45.
 - value of, 131, 133.
- Scoring, figures in, 132.
- Screenings, wheat, 120.
- Selection, 29-35.
- Self-feeder, sheep, 377.
- Selling co-operatively, 456.
- Selling margin, 261.
- Shank color, 486.
- Shearing, rules, 331.
- Sheep—
 - age, 358.
 - Black-faced Highland, 332.
 - care, 379.
 - Cheviot, 345.
 - classes, 333.
 - Cotswold, 349.
 - dipping, 382.
 - docking, 385.
 - Dorset Horn, 344.
 - exercise, 381.
 - fattening, 374.
 - feed racks, 387.
 - feeding, 367, 368, 369.
 - grouping, 379.
 - Hampshire Down, 343.
 - how to study, 357.
 - hurdle, 386.
 - intestinal parasites, 383.
 - judging, 356, 361, 365.
 - Leicester, 348.
 - Lincoln, 350.
 - marking, 380.
 - origin, 333.
 - Oxford Down,
 - Rambouillet, 337.
 - Romney Marsh, 352.
 - salting, 376.
 - scale of points, 130.
 - score card, 362.
 - shearing, 330.
 - shelter, 381.
 - Shropshire, 340.
 - Southdown, 338.
 - Suffolk, 347.
 - Tunis, 347.
 - water for, 377.
- Shelter for fowls, 515, 519.
 - for sheep, 381.
 - for swine, 437.
- Shetland pony, 160.
- Shipping associations, 450-455.
- Shire horse, 156.
- Short-fed cattle, 252.
- Shropshire, 340.
- Sidebone, 179.
- Silage, 110.
- Sinking fund, 455.
- Sire, pure-bred, 40.
- Site, poultry house, 520.
- Size, dairy animal, 288.
 - eggs, 499.
 - hog, 404.
 - poultry house, 520.
- Small Yorkshire swine, 402.
- Soil fertility, 16.
- Sophie's Bertha pedigree, 45.
- Sores and wounds, 211.
- Sorghums, 106.
- Soundness of horse, 175.
 - of wool fiber, 326.
- Southdown, 338.
- Sow, feeding brood, 423.
 - care at farrowing, 430.
- Soy beans, 109.
- Spavin, 176.
 - bog, 178.
- Speed, 25.
- Splint, 180.
- Spotted Poland-China, 394.
- Standards, feeding, 84, 86.
 - adjustment of rations, 98.
 - beef cattle, 245.
 - dairy cattle, 91, 96, 310.
 - modified Wolff-Lehmann, 88.
 - selection of, 93.
 - sheep, 367.
 - Wolff tables, 87, 538.
- Steers, feeding roughage, 253.
- Stockman, judgment of, 126.
- Stomach, fowl, 503.
 - capacity, 76.
- Stomach worms, 383.
- Structure wool, 322.
- Study of animal form, 138.
 - domestic animals, 9.
 - energy value, 90.
 - local conditions, 51.
 - pedigree, 46.
- Suckling pigs, 424.
- Sudan grass, 104.
- Suffolk horse, 159.
- Suffolk sheep, 347.
- Suggestions to breeders, 48.
- Summer feeding, steer, 250.
- Swede turnips, 113.
- Swine—
 - bedding, 431.
 - Berkshire, 390.
 - breeds, 389.
 - care, 430.
 - Cheshire, 402.
 - Chester White, 397.
 - Duroc Jersey, 395.
 - exercise, 431.

- feeding, 418, 420.
 platform, 436.
 requirements, 418.
 standards, 418.
 Hampshire, 399.
 herd book, 436.
 judging, 404.
 parasites, 431.
 Poland China, 392.
 quarters, 431, 437.
 Small White, 402.
 Tamworth, 402.
 tuberculosis, 435.
 water for, 423.
 Yorkshire, 400.
 Swiss Cattle, Brown, 284.
 Tamworth swine, 402.
 Tankage, 122.
 Tapeworm, 384.
 Teeswater cattle, 218.
 Teeth, horses', 173, 175.
 sheep, 358.
 Temperament, 25, 290.
 Temperature, incubator, 495.
 Testing association, cow, 303.
 Testing for milk fat, 307.
 Therm, 80.
 Thin-rind swine, 399.
 Thoroughbred horse, 147.
 Thoroughpin, 178.
 Thrush, 210.
 Timothy, 102.
 Toe-crack, 180.
 Toggenburg goat, 334.
 Tompkins family, 224.
 Toulouse goose, 471.
 Training the colt, 212.
 Trimming feet, sheep, 335.
 Trot, movement, 171.
 Trotter, American, 150.
 Trypsin, 77.
 Tuberculosis, 262, 435, 530.
 Tunis sheep, 347.
 Turkeys, 467, 468.
 Turning eggs, 497.
 Turnips, 113.
 Tusks, removing, 435.
 Type, animal, 138, 142.
 of foundation stock, 35.
 in beef production, 255.
 Types of poultry, 459.
 Udder, 295.
 Unproductive cow, 301.
 Use of—
 animals for food, 13.
 figures in scoring, 132.
 horse, 197.
 scale of points, 129.
 water by animals, 81.
 for clothing, 13.
 for fertility, 16.
 for labor, 14.
 Value of grasses, 100.
 of pedigree, 44.
 of pure-bred sire, 40.
 of relative parts, 132.
 of score, 133.
 Variation in character, 28.
 Varieties of fowls, 462.
 Veins, milk, 298.
 Ventilation, incubator, 496.
 Villi, 25.
 Vitamines, 71.
 Warbles, 267.
 Water, 66.
 for dairy cow, 320.
 for fowls, 509.
 for horse, 205.
 for sheep, 377.
 for swine, 423.
 in animal body, 69.
 use of by animals, 81.
 Watson, Hugh, 227.
 Weathers, 375.
 Weight of hog, 404.
 of eggs, 499.
 of horse, 172.
 related to feeding, 420.
 Wells, milk, 299.
 Wheat, 106, 118.
 bran, 119.
 middlings, 119.
 screenings, 120.
 White cattle, Wild, 217.
 White diarrhoea, 529.
 White Holland turkey, 468.
 Wild boar, 389.
 Wild duck, 468.
 Winter lamb, 375.
 Wolff feeding standards, 87.
 Wolff-Lehmann standards, 88,
 93, 368.
 Wool—
 carpet, 327.
 clothing, 327, 328.
 combing, 327, 328.
 commercial production, 322.
 cortex, 323, 324.
 crimp, 324.
 Delaine, 323.
 domestic, 328.
 epidermis, 323.
 features of, 324.

fiber length, 325.
fineness of, 325.
grading of, 327.
market classification, 327.
medulla, 323.
pith, 324.
soundness of fiber, 326.
territory, 328.
trueness of fiber, 325.
Work of horse, 197.

Worms, stomach, 383.
Wounds, horse, 211.
Wyandotte, 463.
Yearlings, feeding, 251.
Yellow pigment, 484.
Yolk, 491.
Yolk, or grease, 326.
Yorkshire swine, 400.
Young breeders, 48.

STANDARD AGRICULTURAL BOOKS

Published by
WEBB PUBLISHING CO., ST. PAUL, MINN.

FIELD CROPS

By A. D. WILSON, Sup't of Farmers' Institutes and Extension,
Minnesota College of Agriculture, and C. W. WAR-
BURTON, Agronomist, U. S. D. A.

544 pages, 162 illustrations, cloth, \$1.80 net.

This book discusses the peculiarities of each of the various classes and varieties of farm crops, the handling of the soil, selections of seed, and general crop management. It covers the cereals, including corn, wheat, oats, rye, barley, etc.; forage crops, including hay grasses, clover, alfalfa, cowpeas and other legumes; how to make good meadows and pastures, and the art of hay making, etc.; root crops; sugar crops; fibre crops, including cotton, flax, hemp; tobacco, potatoes, in fact every farm crop of any importance is discussed. The introductory chapters give the general classification of farm crops and their uses and relative importance, and review the subject of how plants grow. The concluding chapters discuss the theory and practice of crop rotation and weeds and their eradication. A list of supplementary references is given at the close of each chapter. The style is easy, subject matter well arranged and vital, and the book is of excellent mechanical makeup.

AGRICULTURAL ENGINEERING

By J. B. DAVIDSON, Professor of Agricultural Engineering,
Iowa State College

554 pages, 342 illustrations, cloth, \$1.80 net.

The subjects discussed are so applicable to the every-day work of the farm that the book will prove of great interest and value to those engaged in practical agriculture. The following subjects are given space according to their importance: Agricultural Surveying, Drainage, Irrigation, Road Construction, Farm Machinery, Farm Motors, Farm Structures, Farm Sanitation, and Rope Work. Each chapter is followed by a set of questions for review and for thought promotion. Lists of references to best books and bulletins are included. Complete index. A splendid guide to the mechanics of the farm.



LIBRARY OF CONGRESS



00008992435

