

Historic, archived document

Do not assume content reflects current scientific knowledge, policies, or practices.

Index*

62.37

LIBRARY
RECEIVED
★ FEB 27 1953 ★
U. S. Department of Agriculture



Superior Seeds

**FARM
AND
GARDEN
SUPPLIES**

Manns
BALTIMORE 2, MD.

ENSOR AND FORREST STS. AT BELAIR MARKET



Specially Formulated For Maryland Soils and Climate

Manns' Lawn Mixtures have been known for their Superior Quality for more than half a century

Manns' Superior Lawn Grass

A correctly proportioned mixture of the most desirable perennial varieties blended according to a formula resulting from years of study and experience. It produces beautiful and permanent lawns under average conditions of soil and sunlight.

1 lb.\$1.25	25 lbs. ..\$28.50
5 lbs. 5.90	100 lbs. ..110.00

Manns' Evergreen Lawn Grass

(Without clover)

A good, clean mixture of high germinating seeds, of low weed content. An excellent value where clover is not desired.

1 lb.\$.80	25 lbs. ..\$18.25
5 lbs. 3.80	100 lbs. .. 70.00

White Dutch Clover

1/4 lb.\$.30	1 lb.\$1.00
--------------------	------------------

Kentucky Blue Grass

(Recleaned Heavy Seed)

1 lb.\$.85	5 lbs.\$4.00
------------------	-------------------

Merion Blue Grass (B-27)

An improved Kentucky Blue, darker green, more heat and drought tolerant; spreads densely from its vigorous rhizomes.

1 lb.\$6.00	5 lbs. ..\$27.50
------------------	------------------

Manns' Shady Place Lawn Grass

Contains varieties especially adapted for growing under trees and in shaded areas.

1 lb.\$1.00	25 lbs. ..\$23.25
5 lbs. 4.80	100 lbs. .. 90.00

Manns' Shoreland Lawn Grass

A mixture of turf varieties particularly adaptable for growing in sandy soils.

1 lb.\$1.00	25 lbs. ..\$23.25
5 lbs. 4.80	100 lbs. .. 90.00

Manns' Quicklawn Grass

For immediate effect where permanence is not an important factor.

1 lb.\$.45	25 lbs. ..\$ 9.50
5 lbs. 2.00	100 lbs. .. 35.00

Astoria Colonial Bent

Fine textured grass, blends and grows nicely in lawn mixtures, responds to close mowing. Thrives best on non-acid soils.

1 lb.\$1.75	5 lbs.\$7.50
------------------	-------------------

Chewings Fescue

Deep rooting and adapted to shaded or dry areas, slopes and terraces. Spreads slowly; blades are fine but tough.

1 lb.\$1.25	5 lbs.\$5.90
------------------	-------------------

Lawn Making and Maintenance, See 3rd Cover Page

MANNS' SUPERIOR SEEDS

Our 66th Year

1887

1953

**of Continuous Service to
Critical Market Gardeners and Florists**

Seeds, Bulbs, Plants, Farm and Garden Supplies Are Not Side-Lines With Us But the Very Items Which Determine Our Success. They Must Be Good. They Must Be Dependable. Sow the Best for Best Results.

Phone Plaza 1460 • Prompt, Courteous, and Intelligent Attention Always • Suburban Delivery

You will enjoy Garden Shopping at Manns'

Store Hours—8 to 5.30

MAIL ORDERS: We pay Parcel Post or Express Charges on all vegetable and flower seeds, except Beans, Corn, Peas, and Seed Potatoes. This enables distant customers to use Manns' Superior Seeds at no additional expense.

Shipments of baby fowl, live plants, nursery stock and agricultural products may weigh up to 70 lbs. and measure up to 100 inches combined length and girth. Other merchandise is limited to 40 lbs. in local, first and second zones; to 20 lbs. in zones 3 to 8 and may not exceed 72 inches combined length and girth.

POSTAGE RATES						POSTAGE RATES					
Weight in pounds	Local	Zone 1-2 Up to 150 mi.	Zone 3 150 to 300 mi.	Zone 4 300 to 600 mi.	Zone 5 600 to 1000 mi.	Weight in pounds	Local	Zone 1-2 Up to 150 mi.	Zone 3 150 to 300 mi.	Zone 4 300 to 600 mi.	Zone 5 600 to 1000 mi.
1	0.15	0.17	0.17	0.19	0.21	26	0.47	0.77	1.05	1.38	1.90
2	.17	.20	.21	.24	.28	27	.48	.80	1.08	1.43	1.97
3	.18	.22	.24	.29	.35	28	.49	.82	1.12	1.48	2.04
4	.19	.25	.28	.34	.42	29	.50	.85	1.15	1.52	2.10
5	.20	.27	.31	.38	.48	30	.52	.87	1.19	1.57	2.17
6	.22	.29	.35	.43	.55	31	.53	.89	1.22	1.62	2.24
7	.23	.32	.38	.48	.62	32	.54	.92	1.26	1.67	2.31
8	.24	.34	.42	.53	.69	33	.55	.94	1.29	1.71	2.37
9	.25	.37	.45	.57	.75	34	.57	.97	1.33	1.76	2.44
10	.27	.39	.49	.62	.82	35	.58	.99	1.36	1.81	2.51
11	.28	.41	.52	.67	.89	36	.59	1.01	1.40	1.86	2.58
12	.29	.44	.56	.72	.96	37	.60	1.04	1.43	1.90	2.64
13	.30	.46	.59	.76	1.02	38	.62	1.06	1.47	1.95	2.71
14	.32	.49	.63	.81	1.09	39	.63	1.09	1.50	2.00	2.78
15	.33	.51	.66	.86	1.16	40	.64	1.11	1.54	2.05	2.85
16	.34	.53	.70	.91	1.23	41	.65	1.13	1.57	2.09	2.91
17	.35	.56	.73	.95	1.29	42	.67	1.16	1.61	2.14	2.98
18	.37	.58	.77	1.00	1.36	43	.68	1.18	1.64	2.19	3.05
19	.38	.61	.80	1.05	1.43	44	.69	1.21	1.68	2.24	3.12
20	.39	.63	.84	1.10	1.50	45	.70	1.23	1.71	2.28	3.18
21	.40	.65	.87	1.14	1.56	46	.72	1.25	1.75	2.33	3.25
22	.42	.68	.91	1.19	1.63	47	.73	1.28	1.78	2.38	3.32
23	.43	.70	.94	1.24	1.70	48	.74	1.30	1.82	2.43	3.39
24	.44	.73	.98	1.29	1.77	49	.75	1.33	1.85	2.47	3.45
25	.45	.75	1.01	1.33	1.83	50	.77	1.35	1.89	2.52	3.52

PLEASE READ—Non-Warranty It is very evident to anyone who gives the matter the slightest thought and prove true to name and description. There are, however, so many contingencies to be encountered, entirely beyond our control, such as the weather, soil and other conditions that:

J. Manns & Company give no warranty, express or implied, as to description, quality, productiveness, or any other matter of any Seeds, Plants or Bulbs we sell, and we will not be responsible for the crop. Our liability, in all instances, is limited to the purchase price of the Seeds, Plants or Bulbs.

How and When to Plant Vegetables

VEGETABLES	SEEDS OR PLANTS TO PROVIDE FOR FAMILY OF FIVE	DATE TO SOW OR PLANT OUTDOORS		DEPTH TO COVER INCHES	SPACE BETWEEN ROWS	SET PLANTS OR THIN OUT TO INCHES	TIME REQUIRED TO PRODUCE CROP	NUMBER OF RUNNING FEET OF ROW FOR FAMILY OF 5	SPECIAL NOTES
		FIRST	LAST						
Asparagus	1 oz. or 50	Mar. 20	Aug. 1	Seeds 1 in.	3 to 4 ft.	12 in.	Seeds 4 years	50 ft.	A well-cared for bed improves with age and lasts for many years.
Beans (Bush)	2 qts.	April 20	Aug. 15	Plants 4 in.	2 ft.	3 to 4 in.	Plants 2 years	200 ft.	Select early, midseason and late in both green and wax podded kinds.
Beans (Pole)	½ pt.	May 5	Aug. 1	2 in.	3 to 4 ft.	3 ft. (hills)	90 to 120 days	80 to 100 hills	Select early and late, green and wax pod.
Beet	2 oz.	Mar. 20	Aug. 15	½ to 1 in.	18 in.	2 to 3 in.	60 to 80 days	80 ft.	Select early, midseason and late kinds for winter storage.
Borecole or Kale	1 pkt.	April 10	Sept. 1	1½ ft.	2½ ft.	12 in.	80 to 100 days	20 ft.	Sow during July for fall use.
Broccoli	1 pkt.	April 5	Aug. 10	1½ to 1 in.	2½ ft.	24 in.	120 days	20 ft.	Handle exactly like Cauliflower.
Brussels Sprouts	1 pkt. or 15	May 5	Aug. 10	Seed ½ in.	2½ ft.	24 in.	120 days	20 ft.	The most delicate of all the cabbage tribe.
Cabbage	36	April 20	Sept. 15	Seed ½ in.	2 to 3 ft.	18 to 24 in.	100 to 150 days	60 ft.	Set out 2 doz. early, 1 doz. midseason and 2 doz. late kinds.
Chinese Cabbage	1 pkt.	July 20	Aug. 1	¼ in.	2½ ft.	12 in.	80 to 100 days	20 ft.	Sow only on August 1st for fall use only.
Carrot	½ oz.	Mar. 20	Aug. 1	½ in.	1½ to 2 ft.	2 to 3 in.	45 to 60 days	40 ft.	Sow short rows often. Sow on August 1st for winter storage.
Cauliflower	24	April 5	July 10	Seed ¼ in.	2 to 3 ft.	6 ft.	120 to 150 days	20 ft.	Treat very much like Cabbage.
Celery	½ oz. or 60	Mar. 20	July 15	2 in.	3 ft.	6 in.	100 to 120 days	60 ft.	Select an early and a late variety.
Corn (Sweet)	1 pt.	April 20	July 15	¼ in.	3 ft.	12 in.	65 to 95 days	200 ft.	Sow in blocks of short rows, for perfect pollenization.
Cucumber	1 pkt.	April 20	Aug. 5	¾ in.	4 to 5 ft.	(3 to hill)	60 to 80 days	10 hills	When picking, cut stems; do not pull vines.
Eggplant	12	May 20	July 25	2½ ft.	2½ ft.	36 in.	100 to 120 days	20 ft.	Needs lots of heat and frequent hoeing.
Endive	1 pkt.	April 5	Aug. 10	1½ in.	1½ to 2 ft.	24 in.	60 to 80 days	40 ft.	To bleach, tie plants into cone shape.
Kohl-Rabi	1 pkt.	April 5	Aug. 10	¾ to ½	1½ to 2 ft.	12 in.	60 to 80 days	60 ft.	Should be used when roots reach a diameter of 2½ in.
Leek	1 pkt.	Mar. 30	July 15	½ in.	2 ft.	4 in.	100 days	20 ft.	Grow like Onions and hill to bleach stalks.
Lettuce	2 oz. (4 kinds)	Mar. 20	July 15	¾ in.	1½ to 2 ft.	10 to 12 in.	45 to 60 days	150 ft.	Should be thinned out to stand a foot apart.
Lima Beans (Bush)	1 pt.	June 1	July 10	1 in.	2½ to 3 ft.	2 ft. (hills)	100 days	100 ft.	
Lima Beans (Pole)	1 pt.	May 1	July 10	1 in.	3 ft.	3 ft. (hills)	120 days	100 ft.	
Melons	1 oz.	May 10	July 10	½ to 1 in.	4 ft.	4 ft. (hills)	100 to 120 days	10 hills	Select an early and a late variety in both classes.
Onions	1 oz.	Mar. 20	Aug. 10	¾ to ½ in.	18 in.	3 or 4 in.	80 to 110 days	80 ft.	See note on Cucumbers.
Onion Sets	1 qt.	Mar. 20	Aug. 10	¼ to ½	12 in.	2 in.	30 to 60 days	40 ft.	Weeding and hoeing are their chief requirements.
Parsley	1 pkt.	Mar. 20	June 1	¼ to ½	15 to 18 in.	4 in.	100 to 120 days	50 ft.	Seed requires 3 to 6 weeks to germinate.
Parsnips	1 pkt.	April 5	Aug. 10	½ to 1 in.	15 to 18 in.	2 to 4 in.	150 days	50 ft.	Cultivate well during the growing season.
Peas	3 lbs.	Mar. 20	Aug. 10	2 in.	2½ ft.	1 in.	60 to 100 days	200 ft.	The early smooth seeded sorts may be sown a month before the later, wrinkled varieties.
Pepper	12	May 5	Aug. 20	4 in.	3 ft.	2 ft.	100 days	20 ft.	See note on Eggplants.
Potatoes	15 lbs.	Mar. 20	July 1	½ in.	3 ft.	6 in.	100 days	200 ft.	Really a farm crop.
Pumpkin	1 pkt.	May 20	Sept. 1	½ in.	4 to 6 ft.	4 ft. (hills)	100 to 120 days	12 hills	When storing, prevent bruising.
Radish	3 lbs.	Mar. 20	July 15	½ in.	18 in.	1 to 4 in.	30 to 60 days	50 ft.	Spring sorts can be grown quite close. Summer and fall varieties require more space.
Rhubarb	6	Mar. 20	Oct. 1	¼ in.	3 ft.	3 ft.	60 days	20 ft.	Requires a lot of space and plenty of manure.
Rutabaga	1 pkt.	Mar. 20	July 20	1 to 1½ in.	2 ft.	6 in.	90 to 100 days	40 ft.	Sow around August 1st for winter use.
Salsify	½ oz.	April 5	June 1	1 to 1½ in.	15 to 19 in.	2 to 4 in.	100 to 150 days	25 ft.	Can be stored for winter use or left in ground until spring.
Spinach	1 oz.	Mar. 20	Aug. 10	½ in.	12 in.	2 to 4 in.	60 days	75 ft.	Plant short rows often.
Squash	1 pkt.	April 20	July 1	½ to 1 in.	4 to 6 ft.	4 ft. (hills)	100 to 120 days	12 hills	See note on Pumpkins.
Swiss Chard	½ oz.	Mar. 20	Aug. 10	½ to 1 in.	1½ to 2 ft.	6 in.	90 to 100 days	40 ft.	Treat like Beets.
Tomato	1 pkt. or 48	Seeds Feb. 18 indoors Plants May 5	July 1	Seed ½ in.	3 to 4 ft.	3 ft.	100 to 120 days	150 ft.	For best results train to stakes or trellis.
Turnips	1 pkt.	Mar. 20	Aug. 31	½ in.	15 to 20 in.	2 to 4 in.	60 to 80 days	60 ft.	Sow again in August for winter use.

NUMBER OF WEEKS BETWEEN SOWINGS FOR CONTINUOUS HARVEST

Beans	4 weeks
Beets	6 weeks
Carrots	8 weeks

Cucumbers	4 weeks
Endive	6 weeks
Lettuce	4 weeks

Kohlrabi	3 weeks
Turnips	4 weeks
Spinach	2 weeks

Sweet Corn	2 weeks
Onion Sets	4 weeks
Peas	2 weeks

Radishes—Early	2 weeks
Radishes—Midseason	2 weeks
Radishes—Winter	6 weeks

In the vicinity of Baltimore many varieties are sown in hot-beds during February, March and April to be planted out about May 10th, or earlier in the case of some varieties where the plants may be hardened off.

Some vegetables, such as Cabbage, Lettuce and Spinach, are sown at varying dates, according to variety.

SOW MANN'S' SUPERIOR SEEDS

ARTICHOKE

GREEN GLOBE—Tender perennial producing edible flower buds the second year.

ASPARAGUS

1oz. to 60 ft.; 1 lb. per acre; 3,000 plants per acre

Sow in drills about 18 in. apart and two in. deep in light, rich soil. Thin to about one inch apart and give frequent and thorough cultivation during the summer.

Next season transplant roots to 4 in. deep and 18 in. apart in rows four feet apart. The following season the bed may be cut over two or three times. After the final cutting, give a good dressing of manure, or fertilizer.

Home gardeners are advised to snap off the shoots rather than cut them. A top dressing of nitrate of soda about March 1st promotes growth and increases yield.

MARY WASHINGTON—Resistant to disease, large, early and produces remarkably tender dark green stalks.

ASPARAGUS ROOTS

From one to two years may be saved by planting roots.

MARY WASHINGTON—Choice, 2-year-old roots. 25 for 85c; \$2.75 per 100; \$20.00 per 1000.

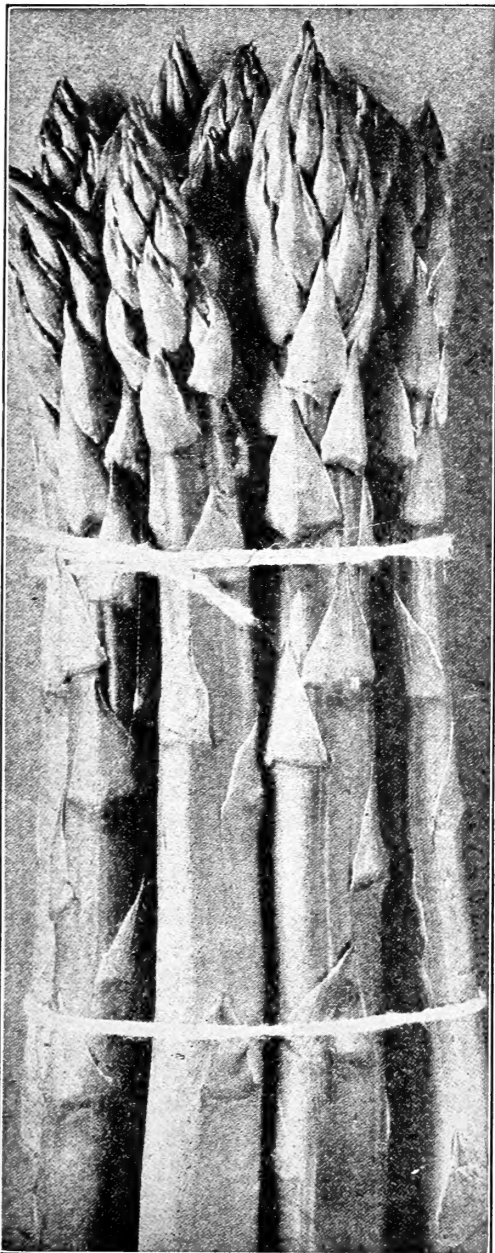

Broccoli Calabrese Heading

Broccoli

1 oz. to 2,000 plants

De Cicco (60 days) An extra early strain capable of producing large heads followed by quantities of side shoots excellent for bunching or freezing. Highly recommended as the earliest maturing Broccoli obtainable.

Calabrese Heading (80 days) Popular market gardeners variety making a good large central head and a fairly good crop of side shoots. Can be grown in the east as perfectly as any shipped into this section. There is now greater public demand for this delicious vegetable making it more than ever a profitable local crop.

40 Day Extra early foliage type used for spring crop "greens." Extensively grown in New Jersey for New York markets.

Italian Green Sprouting (Turnip Broccoli.) Known in the South as Salad Broccoli, grows more "greens" than seven top turnip and is fairly hardy in Maryland, making a profitable cover crop. Sow in August broadcasting two to three pounds per acre and the sprouts will be ready for market during February or early March.

Brussels Sprouts

1 oz. will sow 500 ft. of drills or 3,000 plants

Sow in April for early crop or in early June for a late fall crop. Transplant to rows which are 3 to 4 feet apart, 18 to 24 inches apart in the rows. Will stand considerable frost without protection.

Early Morn (90 days) Found to be the best variety both in quality and productiveness. The sprouts develop very evenly over the entire stem, the lower sprouts being as tightly folded and as solid as those higher up.

PRICES

	Pkt.	Oz.	¼ Lb.	Lb.
ARTICHOKE				
Green Globe	\$.10	\$.85
ASPARAGUS				
Mary Washington10	.15	\$.50	\$1.50
BROCCOLI				
Calabrese Heading10	.30	.85	2.50
De Cicco (ex. early)10	.35	1.00	3.00
Green Sprouting (Turnip Salad)10	.15	.40	1.25
40 Day10	.20	.60	1.75
BRUSSELS SPROUTS				
Early Morn10	.55	1.60	5.00

Bush Beans

GREEN PODDED

1 pt. to 100 ft. of drill; 1 to 1½ bu. per acre

Beans are tender and should not be planted until the soil is well warmed. Sowing too early will often result in a poor stand and uneven ripening. Sow the seed 1½ to 2 inches deep in rows not less than 18 inches apart and firm the soil to assist germination. Allow the plants to stand 4 to 10 inches apart in the row according to variety.

Shallow cultivating and hoeing should be done frequently until the vines begin to blossom. Disturbing the roots after the blossoms are formed will cause them to drop resulting in a greatly reduced crop. To prevent blight do not cultivate deeply and avoid working them while the vines are wet. Beans grow best in warm, well-drained, sandy loam. For succession plant every two weeks until about August 15th.

Asgrow Stringless Black Valentine

(Oval Pod) (50 days) Fully as hardy and early as the original Black Valentine but producing exceptionally long, oval or nearly round pods. Extremely prolific, entirely stringless, and of highest quality.

Streamliner (50 days) An oval-flat green podded stringless bean, not as flat as Bountiful and growing about 1 to 1½ inches longer. Outyields Bountiful in all tests. Seed white.

Burpee's Stringless Green Pod (Improved)

(54 days) Very popular and can be profitably grown by either trucker or home gardener. It combines vigor, earliness and productiveness. The pods are produced in abundance and are handsome in appearance, being rich dark green in color, smooth, absolutely round, meaty, stringless, free from fiber, and of exceptionally delicate quality.

Contender (55 days) An improved, more productive stringless Black Valentine type. Resistant to bean mosaic and powdery mildew diseases. Pods slim 6½ in. long nearly round, dark green and stringless. Seed buff.



Full Measure

New Stringless Green Pod (55 days) This new highly productive strain has many Full Measure characteristics bred into it. Its prolific nature, season of growth, length, roundness of pods and appearance, are definitely inherited and yet to these very desirable features has been added a wonderful degree of hardiness which helps New Stringless withstand adverse weather conditions better than its parent stock.

Tendergreen —See New Stringless Green Pod.

Dwarf Horticultural or Dwarf Cherry

(56 days) One of the best quality dwarf sorts for both snap and green shell beans for the home garden and market. As a green shelled bean it is equal to the lima in quality while any surplus crop can be kept for winter use. The pods are 5 inches long, stout, flat and stringless.

Longreen (56 days) Pods larger than New Stringless-Tendergreen, round, straight, dark green, stringless and of excellent quality. An outstanding canners variety.

Full Measure Stringless (60 days) A very prolific second early round-podded, stringless bean. The pods are straight, meaty, and dark green in color, entirely stringless and measure 6 to 8 inches in length.

Top Crop (50 days) Awarded All-America Selections Gold Medal for 1950. Very prolific and vigorous. Resistant to mosaic disease. Pods round, very straight, medium green.

Wade (64 days) Resistant to common bean Mosaic and powdery mildew. Pods 5½ to 6 inches long, round, slender; plants tall, holding pods well off the ground. The extremely dark green color and its slow wilting characteristics make it very desirable for market and home use.

Bountiful (50 days) Extra early, good cropper, hardy, prolific; pods long, straight, thick-flat, entirely stringless, good quality.

Increased yields result from Nitragin Inoculation

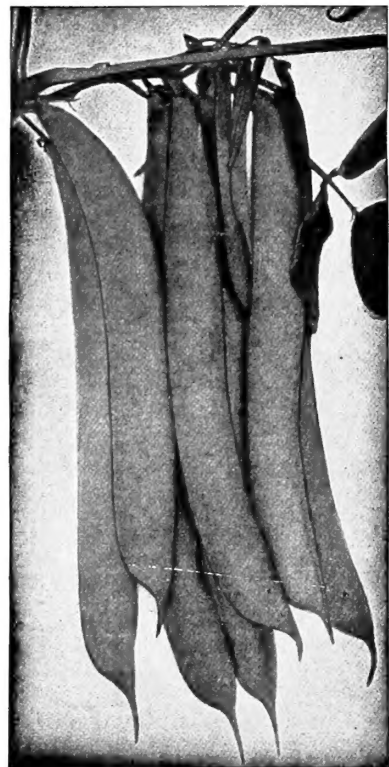

Burpee's Stringless Improved



Block of Selected Pedigreed Stock Seed on Idaho Breeding Farm

Bush Beans

USED AS SHELL BEANS

White Kidney (100 days) Excellent late variety, green, shelled or dry. Seeds are large, white, kidney shaped, and of fine quality.

White Marrowfat (100 days) This is a very prolific variety and has become a choice family sort suitable both for green shells and dry beans. Pods are broad, about 5½ inches long, medium green changing to yellow, having large, clear, white seeds which cook very dry and mealy.

Pole Beans

EDIBLE PODDED

For Cultural Directions See Pole Limas

Kentucky Wonder (65 days) This old standard variety is extremely productive and of finest quality. It is early and produces round, green pods about 9 inches long. Splendid for use as snaps for the home gardener as it continues to bear for a long period. Seed light brown.

White Kentucky Wonder (65 days) Bears large, brittle, stringless pods of excellent flavor, dark green in color. It resembles the Kentucky Wonder in form of pod but is more productive and bears longer. Seeds white, fine for baking.

Yard Long, Celestial (70 days) Somewhat of a curiosity and yet possessing excellent qualities. It is very prolific, absolutely rust proof and a rank grower. It will produce pods 18 to 24 and sometimes 30 inches long. An excellent table vegetable, the pods being tender, stringless and of a rich asparagus flavor.

Horticultural Cranberry (72 days) Also known as Pole Cherry, Corn Field or Wren's Egg. An old favorite, excellent both as a snap and shell bean. Medium early, producing large quantities of 5 and 6-inch pods which are broad, thick, and of fine flavor.

Lazy Wife (75 days) One of the best general purpose pole beans; of superior quality as a snap, green shelled or dried bean. Pods, which are borne abundantly throughout the summer, are very easily gathered and entirely stringless, brittle, light green in color and of mild, sweet flavor. Seed pure white, 6 to 8 in each pod.

Wax Beans

Cherokee Wax (58 days) Deep golden yellow 6½ in. x 7/16 in. oval pods. Stringless, of excellent quality for home, market and shipping. Seed Black.

Pencil Pod Wax (55 days) A leading variety for home and market gardens. Vigorous grower and strongly productive. The golden yellow pods are round, fleshy, tender, entirely stringless and of finest quality.

Round Pod Kidney Wax (62 days) (Brittle Wax.) An excellent early round-podded variety of handsome appearance. Pods are long, straight, brittle, meaty; entirely stringless and of exceptionally desirable quality. The best round-podded wax bean for the home garden, canning or freezing.

Sure Crop Wax (62 days) The most popular flat podded wax. Pods are of a rich yellow color, stringless at all stages of growth. Plant vigorous, hardy, and very productive.

PRICES

Let us quote large quantities

GREEN PODDED	½ Pt.	Pt.	Qt.	Pk.	Bu.
Black Valentine	\$.20	\$.40	\$.75	\$ 4.00	\$12.50
Bountiful	.20	.40	.75	4.50	12.50
Burpees Stringless	.20	.40	.75	4.50	12.00
Contender	.25	.40	.75	4.50	13.50
Dwarf Horticultural or Dwarf Cherry	.25	.50	.90	6.00	22.50
Full Measure	.20	.40	.75	4.50	12.00
Giant Stringless	.20	.40	.75	4.50	12.00
Landreth's Stringless	.20	.40	.75	4.50	12.00
Plentiful	.25	.45	.80	5.00	15.00
Streamliner	.25	.45	.80	5.00	15.00
Supergreen	.30	.55	1.00	5.00	14.50
Tendergreen or New Stringless	.25	.45	.80	4.50	14.00
Top Crop	.25	.40	.75	4.50	15.00
Wads	.25	.45	.80	5.50	17.00
Tenderlong 15	.25	.45	.80	5.00	15.00

WAX VARIETIES

Cherokee Wax	.20	.40	.75	4.50	14.00
Pencil Pod Wax	.25	.45	.80	5.00	14.00
Round Pod					
Kidney Wax	.25	.50	.90	6.00	17.50
Sure Crop Wax	.20	.40	.75	4.50	14.00
Unrivalled Wax	.25	.45	.85	4.50	14.00

POLE BEANS

Horticultural Cranberry	.25	.45	.85	5.00	...
Kentucky Wonder	.25	.45	.85	5.00	...
Lazy Wife	.25	.45	.85	5.00	...
White Kentucky Wonder	.25	.45	.85	5.00	...
Yard Long, Celestial	...	Pkt., 10c;	oz., 15c;	lb.,	\$1.00

BUSH BEANS

Red Kidney	.20	.35	.65	4.00	...
White Kidney	.20	.35	.65	4.00	...
White Marrowfat	.20	.35	.65	4.00	...
White Navy	.20	.35	.65	4.00	...

Bush Lima Beans

1 pt. to 100 ft.; 1 bu. per acre

After June first, when the ground has become warm, plant in 3 foot rows dropping 3 seeds to a hill and the hills 15 inches apart or sow in a row and thin to 8 in. apart.

Peerless (70 days) Small plump green variety developed for canners and freezers; prolific and of excellent quality.

Baby Fordhook (70 days) Pods 2½ in. by ¾ in. plump, having 3 to 4 tightly packed beans, plant about 15 in., bushy, very prolific.

Fordhook 242 (75 days) Heaviest yielding high quality bush lima. Recent U. S. Dept. of Agr. tests at 15 locations throughout the country proved Fordhook 242 more prolific than any of the other four popular commercial varieties. The average yield was 8505 lbs. per acre, nearly 25% better than the second best and far ahead of all the other varieties.

Burpee's Improved Bush

(76 days) A very prolific mid-season variety of very hardy, vigorous and true bush growth, bearing clusters of 5 to 8 pods measuring about 5 inches long. The pods are borne abundantly and well filled.

Pole Lima Beans

1 pt. to 100 ft.; 8 to 10 qts. per acre

Pole beans do not bear as early as the bush varieties but they are more productive, their bearing season is longer and they are more easily gathered. They succeed best in a warm sandy loam which has been enriched with well rotted manure. If poles are used they should be set about 2 feet apart, in rows 4 ft. apart. After the ground has become warm and dry, plant 4 to 6 beans to a pole and when well started thin out to 2 or 3 plants to a pole. By placing the seed eyes down they will germinate more quickly and for this reason are less liable to rot. Cultivate frequently but shallow.

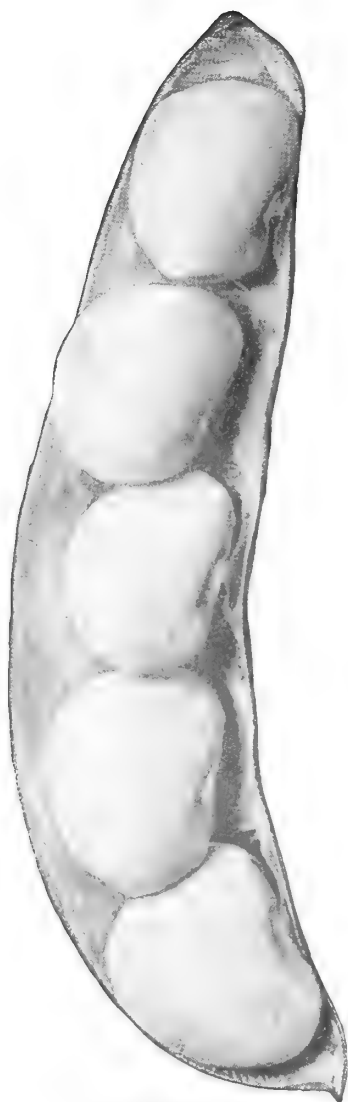

King of the Garden Pole



Burpee's Improved Bush

Improved Challenger (95 days) Vigorous and very productive. Pods and beans resemble Fordhook Bush Limas. Therefore also known as Fordhook Pole. We quote Mr. Bruce H. Gallup who is a very successful gardener. "The best of all the pole varieties, giving one a plump, green bean, very succulent or moist, but with still enough meatiness to afford plenty of substance and carry their green color after they are cooked, with a delicious nutty flavor. As to their productiveness we are fully satisfied as we have picked as many as 87 large plump green pods off one pole at one time and this after the pole has been picked several times during the season."

King of the Garden (90 days) Popular main crop variety. Vines strong and vigorous; setting pods early and continuing to bear until frost. Is used extensively by market gardeners because of its very prolific nature and the immense size of the pods, which are very straight and handsome; of medium dark green color, broad, flat and filled with four or five large white beans of finest quality.

Giant Podded (95 days) The largest podded lima in cultivation; extremely vigorous in growth, mid-season. Pods are borne in clusters of 6 to 8 and measure 6½ inches long and 1¼ inches broad. The beans are extra large and of excellent quality.

PRICES

	½ pt.	Pt.	Qt.	Pk.
BUSH LIMAS				
Baby Fordhook	\$.25	\$.50	\$.90	\$5.00
Burpees Improved Bush..	.25	.50	.90	5.00
Fordhook, 242 (\$16.00 Bu.)	.25	.50	.90	5.00
Henderson's Bush20	.40	.75	4.50
Peerless, U.S. 24325	.50	.90	5.00
Wood's Prolific20	.40	.75	4.50
FAVA BEANS				
Giant Seville25	.45	.80	4.50
POLE LIMAS				
Burpee's Best25	.45	.85	4.50
Improved Challenger25	.45	.85	4.50
Giant Podded Pole25	.45	.85	4.50
King of the Garden.....	.25	.45	.85	4.50
Steva (small white).....	.25	.45	.85	4.50

Table Beets

1 oz. to 50 ft. of drill; 5 lbs. per acre

The soil for beets should be non-acid light, rich, fine and deeply cultivated. Smooth beets cannot be grown if fresh manure is used. If wanted very early, sow in hot beds and transplant, cutting off the outer leaves. For early outdoor crop plant the seeds about 1 inch apart and 1 inch deep in rows 1 to 2 feet apart, firming the soil about the seeds. This should be done as soon as the ground can be worked and for table use, plantings should be made every three weeks. Thin the plants to 3 inches apart. For main crop sow in the early part of May while for winter use they may be planted up to August 1st.

MANN'S BEET SEED

is grown from transplanted roots which have been carefully selected as to both interior and exterior color, tops, shape and uniformity of size. It could be grown much cheaper if we were supplying our trade just ordinary commercial beet seed. Superior seeds can only be grown from specially selected parent stocks.

Detroit Dark Red—Long Top (68 days) Our stock is unsurpassed in quality and appearance. The tops are tall and strong and upright in growth and the roots are globular, of medium size, very smooth and of a wonderful dark red color throughout. Very desirable for canning.

Early Wonder (58 days) Popular bunching variety in some sections where a light-colored beet is desired, and white zones are not objectionable.

Green Top Bunching Tall (58 days) Roots round, smooth, glossy, slightly flattened when full grown, of fine texture, bright blood-red. Large tall green top.

Crosby's Egyptian (60 days) Smooth, flattened, globe shaped roots with small tap root. Color, deep purplish-red in the dark strain and bright crimson in the lighter strain. Tops large and tall.

Perfected Detroit (70 days) An All American Winner, of genuine quality and real beauty. Extremely dark red and not a purple or brown root in the lot. The most critical produce buyer will be pleased with its intense color, perfect shape and freedom from zones. It has plenty of top for bunching and is also an excellent canners variety.

Half Long Lentz (78 days) Bright red outside, flesh pale pinkish white, sweet, about 2½ by about 4 inches top shaped.

Beets—Mangel (or Stock)

1 oz. to 100 feet of drill, 6 lbs. per acre in drills or 15 to 20 lbs. per acre if sown broadcast.

Mammoth Long Red (110 days) Attains enormous size, producing thirty to fifty tons per acre. The roots are straight, well formed and much thicker than other sorts. Grows well above the ground and is therefore easily gathered. The flesh is white tinged with rose. High feeding quality.

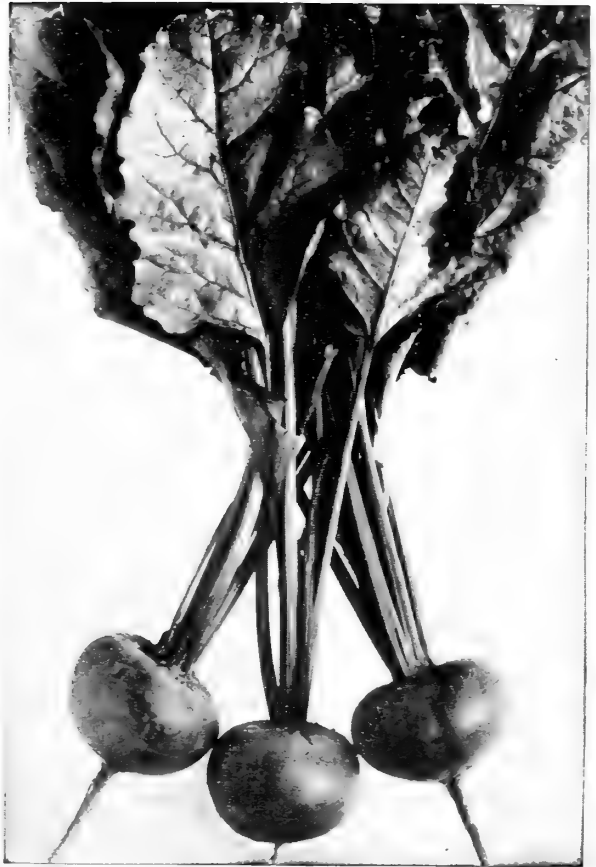

Beet—New Model

New Model (56 days) Perfect in shape with strong abundant tops for bunching and roots of a beautiful solid red color, very uniform in size, the entire crop maturing during the same week. This variety fills a definite need among market gardeners and has met with continuing success. Practical growers realizing the superior quality of this strain are ordering in 25, 50 and 100-pound lots, using this one variety throughout the entire season.

PRICES

	Pkt.	Oz.	¼ Lb.	Lb.	10 Lbs.
Crosby's Egyptian—					
Dark	\$.10	\$.20	\$.50	\$1.50	\$14.00
Crosby's Egyptian—					
Light10	.20	.50	1.50	14.00
Detroit Dark Red					
(Long Top)10	.20	.50	1.50	14.00
Early Wonder Tall Top	.10	.20	.50	1.50	14.00
Early Wonder					
(Regular)10	.20	.50	1.50	14.00
Extra Early Flat					
Egyptian10	.20	.50	1.50	14.00
Green Top Bunching					
Tall10	.20	.50	1.50	14.00
Lentz (Ex. Early					
Light Red)10	.20	.50	1.50	14.00
Mammoth Long Red ..	.10	.15	.40	1.10	9.00
New Model10	.20	.60	2.00	18.50
25 lbs. and 50 lbs.,	\$1.75 lb.; 100 lbs., \$165.00				
Perfected Detroit10	.20	.50	1.50	14.00

Cabbage

1 oz. for 2,000 plants; ¼ lb. per acre

Yellows Resistant Varieties marked*

Number of days indicates time from setting plants to heading.

CULTURE—The best results are obtained from a well-drained, deep rich loam. The very early varieties should be sown about September 15 and in 4 or 5 weeks transplanted to open ground. However, the seed may be sown in hotbeds in February; making plantings later of course according to variety and time crop is wanted. The earliest sorts should be set out in rows 2 feet apart and 18 inches apart in the rows.

If it is not especially desired to have early cabbage the seed may be sown in open ground and transplanted after 4 weeks. For second early crops sow in April and transplant in May; these will mature in July and August. The later varieties should be planted in May and transplanted in July to rows 3 feet apart and 2 feet apart in the rows; these will mature from September to November.

FIRST EARLY

(POINTED HEADS)

Selected Jersey Wakefield (63 days. 5 in. dia. 2½ lbs.) An improved strain of Early Jersey Wakefield, grown and selected with the greatest care; there is none better. Plant compact and erect or very slightly spreading, with few outer leaves. Stem short. Heads of medium size, very solid, uniformly pointed and of excellent quality.

***Jersey Queen** (66 days. 5 in. dia. 2½ lbs.) The yellows resistant Jersey Wakefield.

Charleston Wakefield (74 days. 6½ in. dia. 4 lbs.) Produces larger and heavier heads than Jersey. A week or two later in maturity.

(ROUND HEADS)

Bonanza (70 days. 4 lbs.) Type similar to Copenhagen, stands for weeks after heading without bursting, thus offering longer marketing period.

Racine Market—Yellows Resistant

(72 days. 4 lbs.) Heads firm and compact, deep blue-green color. Cutting may be spread over long period without the heads discoloring or bursting. Plants small, permitting close planting.

Golden Acre (63 days. 6 in. dia. 3 lbs.) Matures as early as Jersey Wakefield, forming a large round, solid head. Very uniform and compact, having a few outer leaves which permits close planting. Golden Acre usually commands high prices because it is the first round head variety on the market.

Copenhagen Market (69 days. 6½ in. dia. 3½ lbs.) This very fine, large round headed variety is of Danish origin and has proven to be very valuable to the American grower. It is nearly as early as Jersey Wakefield. The heads average about 3½ pounds, and the stems are very short.

Detroit—Yellows Resistant Golden Acre

(68 days. 3½ lbs.) About a week later than Golden Acre. Plant slightly larger. Heads have creamy white interior.

Early Round Dutch (71 days. 7½ in. dia. 4½ lbs.) Nearly globe shaped, solid, of good quality, short stemmed. Relatively non-boiling. Splendid for home and market gardens.



Golden Acre



Selected Jersey Wakefield



Copenhagen Market

Cabbage

SECOND EARLY

Glory of Enkhuizen (77 days. 8 in. dia. 5 lbs.) Large sure heading, dark green variety, globular, very hard and solid, few outer leaves, excellent quality. A desirable all-purpose mid-season variety for shipping, local markets and sauerkraut.

All Head Early (78 days. 9 in. dia. 6 lbs.) Remarkably solid and uniform in color as well as in shape and size, its sure heading qualities and tenderness make it a favorite. By reason of its compact growth, it is possible to produce 1,000 more heads per acre than many other good sized varieties. For winter use sow in July. Splendid sort for kraut making and shipping.

Early Flat Dutch (78 days. 9 in. dia. 6 lbs.) Excellent large early flat sort, producing good solid heads. The stem is short and it has comparatively few outer leaves.

***Marion Market** (79 days. 6½ in. dia. 4½ lbs.) Yellows Resistant Copenhagen.

***Wisconsin All Season** (90 days. 10 in. dia. 9 lbs.) Yellows Resistant. A reliable variety equally as good for fall and winter as for summer use. Shows considerable resistance to drought.

FALL AND WINTER

Pointed Head Winter (84 days. 6 in. dia. 3¾ lbs.) Sow the seed in time to set out plants about July 15th. Dependable header, very solid, of fine quality, excellent keeper and shipper. Stands temperatures down to 24 degrees. Ready for market earlier than the Southern crop.

Chieftain Savoy (88 days. 8 in. dia. 6 lbs.) The finest and earliest of the Savoy class and very distinct from all other sorts. Best for either early or late crops. The leaves are heavily crimped or savoyed and grow closely about the medium size, solid, dark green heads. The flavor is far superior to that of other cabbages, and for this reason is very much in demand. It is an excellent keeper and very hardy.

Premium Late Flat Dutch (100 days. 12 in. dia. 12 lbs.) The earliest, most profitable late variety, possessing all the qualities a winter keeper should have. It is hardy, vigorous, and high in quality. The heads are flat, very large, heavy and keep well for winter use. A favorite with the private gardener as well as the trucker.

Danish Ball Head (103 days. 7½ in. dia. 6½ lbs.) A very hardy sure heading, heavy variety, which has proven to be the best keeper and the most desirable for distant markets. Exceedingly hardy, standing dry weather very well and may be stored successfully until late spring. Heads almost globe shaped, very hard, interior very compact, tender texture, of good flavor. Ideal for high quality kraut.

***Wisconsin Hollander Yellows Resistant** (105 days. 7½ in. dia. 8 lbs.) A disease resistant strain of the Danish ball head type, very large, hard, sure heading.

Penn State Ball Head (105 days. 7½ in. dia. 5½ lbs.) Hard flattened globe heads. Desirable for kraut and winter storage.

Cantaloupe

See Muskmelon Page 22



Chinese Cabbage

1 oz. to 150 ft. of row; 2 lbs. per acre

Chinese or Celery Cabbage belongs to the cabbage family but more closely resembles lettuce. For best results plant the seed in July or very early in August as spring plantings in this section are liable to bolt to seed. Plant the seed in the permanent bed and thin out to stand 12 to 15 inches apart.

Chihli (or Improved Pekin) (75 days) A long slender type 3 to 4 in. thick, 16 to 18 in. long. Now the most popular strain in Baltimore, New York and Washington markets. Solid, crisp, well blanched, tender heads of excellent quality.

*YELLOWS RESISTANT VARIETIES

The State of Wisconsin and several other State Departments of Agriculture have for a number of years been working on the best commercial cabbage varieties, adapting them to resist yellows or wilt. It is now possible with these resistant stocks to grow cabbage successfully even on diseased land, by sowing seed which is grown under special conditions to make it resistant. While the cost of this seed is somewhat higher than non-resistant seed, there is the added advantage of securing stock which has been reselected for conformity to true type and heading quality. Therefore these improved varieties are most desirable for both diseased and clean ground.

PRICES

	Pkt.	Oz.	¼ Lb.	Lb.
All Head Early.....	\$.10	\$.30	\$.85	\$2.50
American Drumhead Savoy	.10	.30	1.00	3.00
Bonanza25	1.15	3.50	10.00
Charleston Wakefield10	.30	1.00	3.00
Chieftain Savoy10	.30	1.00	3.00
Copenhagen Market10	.60	1.00	3.00
Danish Ball Head.....	.10	.40	1.15	3.50
Early Flat Dutch.....	.10	.30	.85	2.50
Early Round Dutch.....	.10	.35	1.00	3.00
Glory of Enkhuizen.....	.10	.30	.85	2.50
Golden Acre (Original)...	.10	.40	1.15	3.50
Jersey Wakefield (Selec'd)	.10	.30	.85	2.50
Mammoth Rock Red.....	.10	.55	1.65	4.85
Penn State Ball Head....	.10	.40	1.15	3.50
Pointed Head Winter....	.10	.35	1.00	3.00
Premium Late Flat Dutch	.10	.30	1.00	3.00

*YELLOWS RESISTANT VARIETIES

All Head Select.....	.10	.45	1.35	4.00
Detroit (Res. Golden Acre)	.10	.50	1.50	4.50
Globe (Resistant Glory)...	.10	.45	1.35	4.00
Green Globe, Improved...	.15	.45	1.35	4.00
Jersey Queen.....	.10	.45	1.35	4.00
Marion Market10	.40	1.15	3.50
Racine Market10	.50	1.50	4.50
Wisconsin All Seasons...	.10	.45	1.35	4.00
Wisconsin Hollander No. 8	.10	.50	1.50	4.50

CHINESE CABBAGE

Improved Pekin—Chihli	.10	.20	.60	2.00
Michihli10	.30	1.00	3.00

Carrots

1 oz. to 150 feet of drill; 4 pounds per acre

Our stock is grown from choice selected and transplanted roots only, and are of the truest type and richest color money can procure.

CULTURE.—Any good soil will grow this vegetable, but the most perfect roots, however, are developed in rich, friable, slightly alkaline soil, preferably sandy loam. The flavor and tenderness of the table varieties is secured by having a quick growth, which usually means good growing weather and proper cultivation. Sow as early as the ground can be worked or for late crop until the latter part of July, in drills 12 to 18 inches apart, finally thinning the plants to 2 to 3 inches in the drills. The seed is slow to germinate and if sown early or on moist soil, half an inch is deep enough. When sown during the hot summer months it is well to protect the seed bed with a thin layer of chips or straw as excessive heat will kill the vitality of the seeds before they germinate. After the seed has sprouted remove the covering, selecting the late afternoon for this work. Carrots are usually quite free from pests and diseases.

Coreless or Scarlet Nantes (68 days, 6 in. x 1 1/4 in.) The earliest of its type; size and shape uniform; bright orange in color; smooth skin; small top. Fine quality home garden variety.

Chantenay (Long) (70 days, 7 in. x 2 in.) A most excellent, medium early, half-long variety. Very uniform, stump-rooted but tapering slightly. Smooth, deep orange-red in color and the flesh very crisp and tender. Although a medium early sort the roots are suitable for use nearly as early as any, and will also prove very satisfactory if grown for winter use. Very easily harvested and bunched.

Danvers Half Long (75 days, 7 in. x 1 1/4 in.) This is an exceptionally fine carrot for private and market garden use. It is slightly longer than Chantenay and our strain produces uniformly smooth and evenly sized roots of handsome appearance. They are orange-red in color and the flesh is sweet, crisp and tender.



Chantenay

Sunrise (75 days, 7 in. x 2 in.) This variety has become a favorite with our market garden trade because of its fine quality, perfect shape and attractive color. Sunrise has been found to be specially valuable for medium and late use, an excellent keeper and thoroughly dependable. It is of most perfect form, pointed-rooted, with a broad, high shoulder. For main planting this sort has no superior, and when sown during June may be depended upon to produce the very best crop of roots to store for winter.

California Bunching (78 days, 7 in. x 1 1/4 in.) Developed especially as a bunching carrot for long distance shipping. Roots about 1 1/2 in. by 7 in. long, cylindrical stump rooted, deep orange color throughout, can be pulled before maturity or allowed to stand weeks later without becoming overgrown.

Improved Long Orange (85 days, 10 in. x 2 in.) A standard late variety, beautiful and uniform in shape, deep orange in color. The roots grow to a length of 12 inches and are of good quality for table use as well as for stock. They require a deep soil and if full size roots are wanted they should stand at least 8 inches apart in 18-inch rows.



California Bunching

PRICES

	Pkt.	Oz.	1/4 Lb.	Lb.
California Bunching	\$.10	\$.20	\$.60	\$1.75
Chantenay (Long)	.10	.20	.60	1.75
Danvers Half Long	.10	.20	.60	1.75
Imperator	.10	.20	.60	1.85
Improved Long Orange	.10	.20	.60	1.75
Louisiana Danvers	.10	.25	.75	2.25
Model #122	.10	.25	.75	2.25
Nantes Coreless (Special)	.10	.25	.75	2.25
No. 92—Large Busheling	.10	.25	.75	2.25
Oxheart	.10	.25	.75	2.25
Red Cored Danvers	.10	.20	.60	2.00
Sunrise	.10	.25	.75	2.25
Supreme Danvers	.10	.25	.75	2.25

10 lbs. or more deduct 25c lb.



Cauliflower

1 oz. to 2,000 plants

For a successful early spring crop sow the seed during the last week in September. The young plants are shaded from excessive heat, protected from high winds and given just a moderate amount of moisture. Any plants showing signs of black stems or mildew are destroyed. When about 5 in. tall the plants are transplanted into 3" to 4" pots and protected from freezing until March. They are then removed to the field into rows 3 ft. apart and 2 ft. apart in rows, setting the plants so that the first leaf or eye is at ground level. As soon as the heads have attained a size of 2 to 2½ in. the surrounding leaves are gathered over the small heads and tied with a wooden peg or nail to keep them blanched a clean pure white. The crop is ready for home use or market about June 1st.

Some growers prefer to make their first sowing in hot-beds during January or February and transplanting them 2 to 3 in. apart, assuring vigorous growth before being set out in March.

A second sowing the first week in May transplanted to the field the last week in June will make a very satisfactory crop before heavy frost.

Sow SNOWBALL for Spring Crop and WHITE MOUNTAIN for Fall.

Early Snowball (55 days) Smaller than White Mountain, grown mainly for a late spring crop from seed sown in Fall or Winter. Sure heading if planted out very early in March.

White Mountain (60 days) The most dependable uniform heading variety for the vicinity of Baltimore. Produces 1½ to 2 lb. heads, 6½" to 7" in diameter about 60 days after setting plants.

Cauliflower Plants See Page 33.

PRICES					
CAULIFLOWER	Pkt.	Oz.	¼ Lb.	Lb.	
Early Snowball	\$.25	\$3.50	\$10.00	\$35.00
White Mountain25	3.50	10.00	35.00
CHARD (SWISS)					
Common Green (Spinach Beet)10	.15	.40	\$1.25
Fordhook Giant10	.15	.40	1.25

Chard (Swiss)

1 oz. to 150 ft. of row; 8 lbs. per acre

Sow seeds the same as ordinary beet seed but thin out at first to 6 inches apart, later to 1 foot apart.

Common Green (Spinach Beet) (55 days) Also known as Perpetual Spinach. Light green smooth leaves with small midrib. A particularly good garden item in hot weather when true spinach is out of season.

Fordhook Giant (55 days) The best Swiss Chard in cultivation, producing extremely large, heavily savoyed leaves of a beautiful glossy, very dark green color. Ribs broad, thick, white.



Swiss Chard—Fordhook Giant

Celery

1 oz. to 5,000 plants; 20,000 plants per acre

Celery seed is very slow to germinate and therefore should be started indoors in boxes from February to April or sown out of doors in a finely prepared seed bed during April. See that the seed is covered only about 1/16 inch and that the bed is kept moist, almost wet until the seeds germinate. When the plants are about two inches high thin out and transplant to a distance of two or three inches apart each way. These must be kept entirely free from weeds and when they are four inches high the tops may be cut off so that the plants will grow more stocky. The plants are usually set out in the permanent bed when five inches high and it is usually best to do this during July or the first of August. In some sections best results are obtained by transplanting in June.

The permanent beds should be thoroughly prepared and well enriched with rotted manure, which should be spaded in deeply, the rows being spaced 2 1/4 to 3 feet apart. Cut off some of the root and set the plants 6 to 8 inches apart in the rows, firming the soil tightly, and cultivate them frequently for a period of six weeks. Celery needs plenty of moisture.

When the plants are nearly full grown they should be blanched. This is done by drawing the soil closely about the plants to about two-thirds of their height, being careful not to allow any of the earth to fall between the leaves. Repeat this process every few days until only the top of the leaves are visible. Do not disturb the plants while they are wet or the soil is damp as this is liable to result in injury from rust.

Number of days indicates time from setting plants. Add 60 days for days required from sowing of seed.



Golden No. 14

PRICES

CELERY

	Pkt.	Oz.	1/4 Lb.	Lb.
Cornell No. 19.....	\$.10	\$1.00	\$3.25	\$10.00
Full-heart Easy Blanching	.25	1.65	5.00	15.00
Giant Pascal	.10	1.00	3.25	10.00
Golden No. 14	.10	1.00	3.25	10.00
Tall Non-bolting				
Golden Plume	.25	1.50	4.50	14.00
Utah Pascal No. 15	.10	1.00	3.25	10.00

CELERY—LETTUCE

Burpee's Celtuce, pkt., 15c; 1/4 oz., 35c; oz., \$1.25

Full-heart Easy Blanching (100 days) The most profitable variety for growers who trench celery for early market. A green variety easily blanched, producing maximum size hearts of a yellowish cream color. The stalks are well rounded, crisp and of excellent quality.

Utah Pascal No. 15 (125 days) Green midseason celery. Easier to blanch than Utah. Height 26 to 28 inches, stems 9 to 10 inches long; very heavy, rounded with narrow channel, slightly tapered from base to first joint. Stems numerous, forming compact head and hastening blanching of inner stems and hearts. Tops very dark green.

Giant Pascal (140 days) A superior quality and excellent keeping sort. The stalks are very large, thick, solid, crisp and of rich nutty flavor; it blanches very easily and quickly, and retains its freshness a long time. Fine home garden variety.

Cornell No. 19 (100 days) Developed and introduced by the New York State College of Agriculture and described as a cross between Golden Self Blanching and Utah. An early, easy blanching strain of outstanding quality. Is prevaillingly 10 1/2 to 11 inches to joint with an overall height of 24 to 25 inches. Hearts long and comparatively full. Stems thick, rounded and of smooth texture. Combines the good qualities of the Pascal type with the early, easy blanching character and color of the Golden Self Blanching strains. Highly resistant to fusarium yellows.

Golden No. 14 (85 days) This new strain of Golden Self-Blanching, pronounced by authorities to be one of the best of all the early varieties. It matures two or three weeks earlier than other sorts, blanches more quickly, producing large compact plants with very good hearts.

Tall Non-bolting Golden Plume (90 days) Grows taller and faster than the original Golden Plume. Withstands low temperatures when planted out without bolting. It is the most satisfactory Golden Plume strain for an early crop.



Full-heart Easy Blanching

CELERY PLANTS (See page 58)

Celeriac

1 oz. to 200 ft. of row; ¼ lb. per acre

Sow seed and cultivate same as celery, with the exception that it is not necessary to blanch the plants. When the roots attain a diameter of two inches they are fit for use. To keep these through the winter, pack in damp earth or sand and store them in a cellar or leave them out of doors, covering with earth and straw for protection.

Large Smooth Prague (120 days) One of the largest, very smooth and almost round with very few side roots. Plants are vigorous, with large dark green foliage.

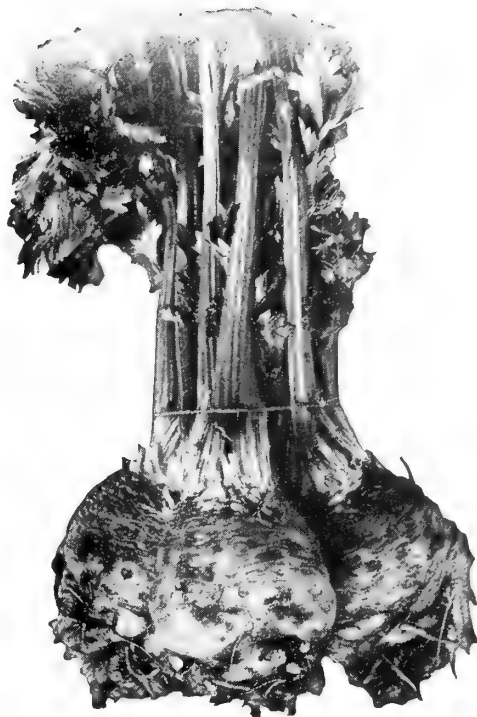

Large Smooth Prague Celeriac

Chicory

1 oz. to 80 ft. of row; 4 lbs. per acre

Witloof (French Endive) (95 days) A very choice winter salad forced in hotbeds from roots previously grown outdoors; producing solid oblong heads blanched ivory white.

Chives

1 oz. to 150 ft.

Small hardy perennial ready for use in 85 days, resembling the onion in appearance and growing in clusters. Grown for the young leaves which give a mild onion flavor to sausage, salads and various dishes.

Collards

Broadcast 1 lb. to 2 lbs. per acre—1 oz. to 300 ft. row

Cabbage or Heading (60 to 80 days) Produces compact plants 1½ to 2 ft. high. Large clusters of leaves often show a tendency to form a head.



Cabbage Collards

Corn Salad

1 oz. to 20 sq. ft.; 6 lbs. per acre

Large Seeded Dutch (50 days) Used as a salad. Sown in the early spring in rows 1 foot apart, it is fit to use in 6 or 8 weeks. If wanted in early spring, sow in September and cover with straw as soon as cold weather sets in. Can also be grown in protected cold frames and used any time during the winter.

Cress

1 oz. to 150 ft. of row; 3 lbs. per acre

Dwarf annual and perennial plants of mild to pungent flavor used for salads and garnishing. They require moist soils, thrive during the cool seasons in well shaded places where an ample supply of moisture is constantly available.

Garden (Curled or Pepper) (45 days) Dwarf 8 inch compact fast growing annual having finely curled deep green foliage. Used for garnishing and salads.

American Upland (45 days) Dwarf plant with notched oval leaves resembling true water cress. Of a mild flavor, grown in this area as a fall and winter crop. Sown in July or August; requires a fertile moist soil.

True Water (100 days) Hardy perennial with long stems and small thick divided leaves having a sharp pungent flavor. Thrives along moist banks or in soil covered with shallow fresh water.

PRICES

	Pkt.	Oz.	¼ Lb.	Lb.
CELERIAC				
Large Smooth Prague....	\$.10	\$.50	\$1.75	\$6.00
CHICORY				
Witloof (French Endive).	.10	.30	.85	2.50
CHIVES10	1.50
CORN SALAD				
Large Dutch10	.35	1.00	3.00
COLLARDS				
Cabbage Collards10	.20	.50	1.50
Georgia or Southern10	.15	.45	1.35
Morris Improved Heading	.10	.30	.85	2.50
New Hardy Short Stem....	.10	.20	.60	2.00
Winter Hardy10	.30	.60	2.00
CRESS				
American Upland10	.20	.60	1.75
Garden (Curled or Pepper)	.10	.20	.60	2.00
True Water15	.60	2.00	7.00



Corn

Iochief

TABLE VARIETIES

1 quart to 200 hills; 1 peck per acre

Sugar Corn should not be planted until May, or when the ground is warm. For succession, plant about every two weeks until the last of July as hybrids mature very uniformly they should be planted at intervals of a week or ten days to assure a continuous supply. All varieties may be either sown one inch deep in rows three to four feet apart, the seeds being placed about 8 inches apart in the rows, or they may be planted in hills at distances of three or four feet apart each way, allowing not more than 3 plants to a hill. The size of the variety and the richness of the soil should determine the distance of planting. Hybrid corn because of its deeper rooting character may be planted closer than open pollinated varieties. Cultivate frequently but shallow until the tassels appear.

Gold Rush (66 days) A fine quality, first early yellow low hybrid; stalks 6 ft., sturdy, vigorous. Ears 8½ in. long, 12 to 14 rowed, well filled; tight dark green husk. Planted early and late to avoid main brood of corn borers and Jap beetles.

Big Mo. (82 days) Withstands adverse growing conditions. Dependable for market and home garden. Stalks vigorous, dark green, very few suckers; ears 8½ in. x 2½ in.; 16 to 20 rows of bright yellow, deep medium width kernels of good quality.

Iochief (83 days) All American Gold Medal Winner. Vigorous, practically suckerless, drought resistant, 6½ ft. tall, frequently 2 ears per stalk. Ears 8½ in. long, slightly tapered, 14 to 18 rows of narrow, deep, tender, golden yellow kernels; fine flavor and holds well.

Golden Cross Bantam (Hybrid) (85 days) Produces beautiful 8-inch ears having 10 to 14 rows of golden yellow kernels. It is resistant to wilt or Stewart's disease and is now the standard strain grown for the largest canners. As the crop matures very uniformly it should be planted at intervals of a week or ten days to assure a continuous supply.

Aristogold Bantam Evergreen

(86 days) Home and market gardeners main crop variety of excellent quality and appearance. Ears 9 to 10 in. long, with heavy worm resistant husk of a deep green color; kernels deep yellow, 16 to 18 rows.

Stowell's Evergreen Hybrid (95 days) There are many Hybrids of the Stowell's Evergreen Variety but we have selected for you the most desirable and profitable hybrid based on Maryland Experiment Station tests, our own trials and reports of large growers. If you grow White Sugar Corn, be sure to plant Hybrid Stowell's. The ears are large, well filled, of beautiful appearance and excellent quality.

Manns' No. 56 (65 days) The best most salable early market corn we have ever known. It can be planted extremely early without danger of rotting, which makes it possible to produce marketable ears at least five weeks ahead of Stowell's Evergreen. Resembles sugar corn, an excellent shipper, and a money maker.

Stowell's Evergreen Extra Selected

(90-95 days) Grown more extensively than any other; a favorite with canners and market gardeners for late use. Ears of large size, 7½ to 9½ in., kernels very deep, tender and sugary, very productive and remains for a long time in fit condition for table use.

Country Gentleman (95 days) Very deep grains, small cob and exceedingly rich flavor. Often produces 3 to 4 6½ to 8 in. ears to the stalk. The grains are "staggered" on the cob, leaving no signs of rows.

	Pt.	Qt.	Pk.	50 lbs.
Black Mexican	\$.40	\$.75	\$4.00	\$12.50
Country Gentleman				
(Shoe Peg)40	.75	4.00	12.50
Early Evergreen40	.75	4.00	12.00
Early Superior40	.75	4.00	12.50
Golden Bantam40	.75	4.00	12.00
Golden Evergreen40	.75	4.00	12.00
Improved Early Adams ..	.25	.45	3.00	9.00
Manns' No. 56.....	.50	.95	4.50	...
Stowell's Evergreen Ex.				
Selected40	.75	4.00	12.00
White Evergreen40	.75	4.00	12.00
Pop Corn—South American Giant—25c lb.				

HYBRIDS

Aristogold65	1.25	6.25	22.50
Big Mo65	1.25	6.25	22.50
Country Gentleman Ill. 15	1.00	2.00	10.00	37.50
Golden Cross Bantam60	1.15	6.00	22.50
Gold Rush75	1.50	7.50	27.50
Ioana60	1.15	6.00	22.50
Iochief75	1.25	8.00	30.00
Narrow Grain Evergreen				
(14 x 11)75	1.50	8.50	30.00
Stowell's Evergreen Hybrid	.60	1.15	6.00	22.50

Field Corn

We carefully follow Maryland Agricultural Experiment Station's reports in selecting for you the Hybrids best suited for Maryland



HYBRID CORN increases yield 15% to 25%, is resistant to smut, rust and wilt; has deeper and more vigorous root systems, therefore less affected by drought or severe wind.

GROW HYBRIDIZED VARIETIES OF KNOWN ADAPTABILITY

Plant Hybrid Corn because of the certainty of a better yield and much better quality. It is important to plant only seed proven to be adaptable to this section and grown by experts. Hybrid corn is not necessarily all desirable. The process is expensive, highly technical and requires the skill of a plant breeder. Manns' hybridized corns have been grown by experts and have proven profitable for this section.

Please Note—It is useless to try to save seed from hybrid varieties of corn. They must be newly developed each year.

OPEN POLLINATED VARIETIES

Iowa Silver Mine (90 days—Roasting ears 75 days) Deep grained, pure white, rough-topped, with a small white cob. Ears 9 to 12 in. long with 16 to 20 rows of pure white kernels. Stalks medium height, very leafy, with broad blades.

Lancaster County Sure Crop

A favorite with dairymen as a silage variety and also extremely valuable as a husking sort. Matures for silage in 90 days and for grain in 100 days producing long ears of deep large grains.

Pride of the North Maturing perfectly in 90 days, very hardy and prolific. A favorite among growers and planters needing a 90-day yellow variety. The ears are of medium size with very small cob. Kernels closely set, long and compact.

Ried's Yellow Dent (118 days) Probably the most popular open pollinated yellow variety.

No. 309—Acme Rotary Automatic Corn Planter

Full rotary Drop; having adjustable cast disk or seed plates, and depth gauge. Extremely accurate; also plants beans and peas. \$4.35.



No. 309

HYBRID YELLOW VARIETIES

Iowa 939 (90-100 days) Plants are of medium height. The ears are rough, medium long, and have about 16 rows of medium deep reddish yellow grain. Yields well in average soils. Very popular with cattle feeders because of its non-flinty kernels.

U. S. 13 (100-110 days) Well adapted to this area and still used as the standard variety for comparing other hybrids. The deep green plants are tall, with medium high ears. Ears are large, carrying 20 to 22 rows of deep rich yellow medium soft grains. One of the highest yielding of all hybrids for both grain and silage.

Gold Line 378 (115-120 days) Dependable main crop. Variety somewhat resembling Ried's Yellow Dent. Ears 10 to 12 in. having 20 rows of rich golden yellow kernels. The strong, sturdy fodder stays green while the ears mature making it an excellent silage variety. Exceptional strong, sturdy root growth.

U. S. 262A (125-140 days) Heaviest yielding long season variety. Far above all competition in carefully checked Va. State Trials.

PRICES

	Qt.	Pk.	Bu.
Iowa Silver Mine	.35	\$1.85	\$6.00
Lancaster County Sure Crop	.35	1.85	6.50
Pride of the North	.35	1.85	6.00
Ried's Yellow Dent	.35	1.85	6.50

HYBRIDS

Gold Line 378	.40	2.50	9.00
Iowa 939 (Certified)	.40	2.50	9.00
U. S. 13 (Certified)	.40	2.50	9.00
U. S. 262A	.65	3.75	11.00
Kentucky 203 (Certified) White	.60	3.35	10.00

Cucumbers

1 oz. to 100 hills or 100 ft. of row; 2 lbs. per acre

Plant as soon as the weather becomes settled in hills 4 feet apart each way, with 8 or 10 seeds in each hill, cover half an inch deep, smoothing the hill off with the hoe. Keep the soil well stirred, and when the plants are out of danger of insects thin to 4 plants to the hill. Another very successful method is to sow the seed in rows, thinning to stand 12 in. apart in the row. For pickles, plant from the first of June to the first of August. Whether growing slicers or picklers the fruit should be gathered when large enough, for if left to ripen on the vines, it destroys their productive uses.

Gherkins or Burr (60 days) Very small, quite distinct from all others, grown exclusively for pickling, and should be picked when young and tender.

Klondike (64 days) An old favorite with market gardeners and shippers. The handsome dark green cucumbers average 7 inches long and 2 to 3 inches in diameter.

Marketer (65 days) Vines very vigorous and prolific; fruits very dark green, slightly tapered at ends. Notably uniform and attractive.

Straight 8 (66 days) Symmetrical fruits, well rounded at both ends. Regularly eight inches in length and from 1 3/4 to 2 inches in diameter. deep green and free from pale striping and tipping. Vines are vigorous and remarkably productive.

Long Green (Improved) (67 days) Under favorable conditions, produces fruit averaging from 10 to 12 inches in length. Skin is a deep rich green, flesh solid, crisp and of excellent quality.

A & C (68 days) A leading market and shipping variety. 9 to 11 inches long by 2 1/4 inch diameter, blunt at both ends, very dark.

Cubit (68 days) An All American Winner in 1935, crop variety of uniform dark green color. Long, blunt at both ends, crisp, and holds its fresh quality well for shipping or market.

Hybrid Early Surecrop (58 days) Very dark green, disease resistant, shaped similar to A & C or Cubit. Yield and ability to produce over a long period makes it especially desirable.

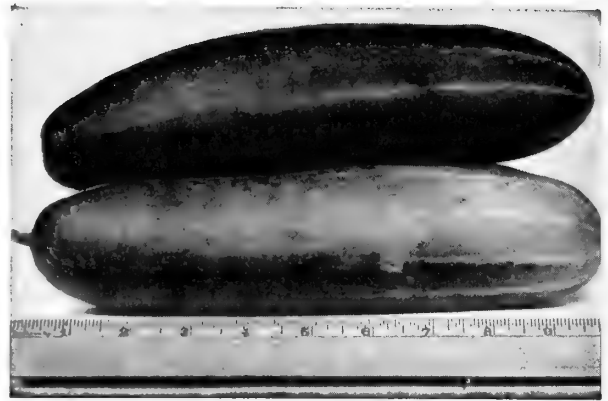

A & C

Japanese Climbing (70 days) Vines are extra strong, vigorous; being a climbing sort, can be grown on trellises, etc.; valuable in small gardens. Very prolific. Fruit 2 in. by 7 in. of fair quality.

Longfellow Straight Pack (70 days) This variety was developed primarily for greenhouse culture; its quality, size and attractive appearance, however, have definitely established it as one of the best for outdoor production. The beautiful dark green cucumbers average 12 inches in length and are adaptable for packing in flats for the very highest class trade.

	PRICES			
	Pkt.	Oz.	1/4 Lb.	Lb.
A. & C.	\$.10	\$.25	\$.75	\$2.25
Black Diamond (or Stays Green)10	.25	.75	2.25
Boston Pickling or Green Prolific10	.20	.60	1.75
Cubit10	.25	.75	2.50
Gherkins or Burr.....	.10	.20	.60	2.00
Highmoor10	.30	1.00	2.75
Japanese Climbing10	.20	.60	2.00
Klondike10	.20	.60	1.75
Longfellow or Straight Pack10	.25	.75	2.50
Long Green (Improved)..	.10	.20	.60	2.00
Marketer10	.25	.75	2.25
National Pickling10	.20	.50	1.50
Niagara15	.40	1.25	3.75
Straight 810	.25	.75	2.25
Sure Crop, Hybrid25	4.00	12.50	...
York State Pickling.....	.10	.35	1.00	3.00



Cucumber—Marketer



Straight Eight

Dandelion

1 oz. to 200 ft.; 2 lbs. per acre

Arlington (95 days) The best market garden strain, forming large, glossy, stocky, thick-leaved plants, white-ribbed.

Dill

Long Island Mammoth (90 to 100 days) Sow in rows and thin out to stand 8 or 10 in. apart. We offer an excellent market garden strain.

Egg Plant

1 oz. will produce 1,000 plants

Sow in March in hotbeds, and transplant when 2 inches high to 4 inches apart. When the weather becomes settled, transplant into the open ground 3 feet apart each way. Work the ground deep, make it rich with well-rotted manure and hoe often.

Black Beauty (80 days) Large globe to oval shaped fruits, smooth, glossy, very dark purple. Holds color well after picking.

Florida High Bush (85 days) Very vigorous and productive; resistant to drought and root rot. Of upright growth holding the fruit well off the ground; elongated, tapering toward stem, good shipper.

Endive

1 oz. to 100 ft. of drill; 3 lbs. per acre

Full Heart Batavian (Escarolle) (90 days) The most widely used variety of Endive; an improved Broad Leaved Batavian with thicker and broader heads; matures slightly earlier, requiring only 90 days from sowing of seed to heading.

Green Curled (95 days) This is the hardest variety, and very desirable for the home and market garden. The deep green leaves are beautifully cut and curled, easily blanched, and become very crisp, tender and fine-flavored.

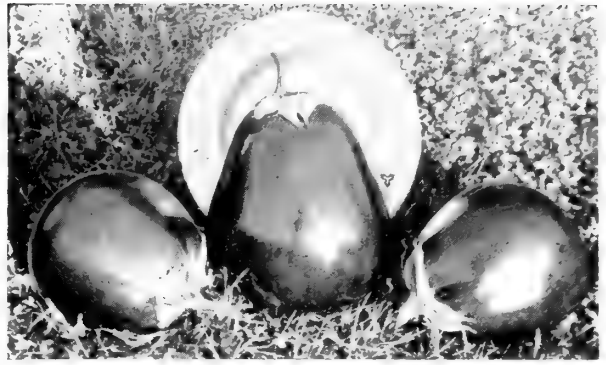

Florida High Bush

Herbs

PRICES

	Pkt.	Oz.	¼ Lb.	Lb.
Caraway	\$.10	\$.15	\$.40	\$1.20
Chives10	.75	2.50	...
Marjoram, sweet10	.60	2.00	...
Sage10	.50	1.50	4.50
Summer Savory10	.60	2.00	...
Sweet Basil10	.50	1.50	4.50
Thyme10	.85	2.50	7.50



Fennel

Florence (Finocchio)

(110 days) In great demand with Italian trade. The leaf stalks are clustered in a bulb-like formation, and when these are about 1½ inches wide, the plants should be hilled up to about half their height.

Florence Fennel



Endive—Full Heart

PRICES

	Pkt.	Oz.	¼ Lb.	Lb.
DANDELION				
Arlington	\$.10	\$.95	\$2.85	\$8.50
Italian (Ciccoria Catalogna)10	.50	1.50	4.50
DILL				
Long Island Mammoth10	.15	.30	1.00
EGG PLANT				
Black Beauty10	.60	2.00	7.00
Florida High Bush10	.60	2.00	7.00
ENDIVE				
All Head Cabbaging10	.25	.75	2.25
Full Heart Batavian10	.20	.50	1.50
Green Curled10	.20	.50	1.50
FENNEL				
Florence10	.30	1.00	3.00

Kale

Borecole Scotch Kale

1 oz. for 2,500 plants

Extensively grown in this section for marketing during the winter and early spring months, when other vegetables are scarce. Borecole should be grown like cabbage, the seed being sown from early spring to the middle of August. It is customary to pull off the lower leaves and let the plant grow on to furnish a continuous supply.



Borecole—Dwarf Green Scotch

Blue Curled Scotch (55 days) Hardy as Hardy Winter and having very curly dark blue-green leaves.

Curled Perfection (55 days) An improved type, specially rogued and developed from a privately held American stock. Well curled and of a wonderful dark green color; winters well and commands top prices.

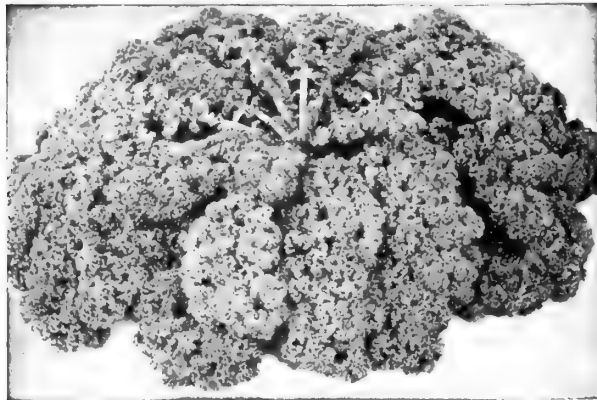

Borecole—Curled Perfection

Dwarf Green Scotch (55 days) This excellent sort is low spreading and compact in its nature of growth, forming a mass of leaves which are beautifully curled. The color is an attractive bright green and the quality is excellent.

Hardy Winter (60 days) This variety is one of the most salable and profitable sorts for either the home or market gardener. The plant attains a height of 18 inches and produces an abundance of beautiful light green leaves, which are densely curled and crimped. It is extremely hardy and has the additional advantage of putting forth a second crop of leaves after the first have been gathered or have fallen off.

Superior Extra Curled Green Scotch

(60 days) The leaves of this variety are very much more curled than the Dwarf Green Scotch, and many more bushels per acre can be cut due to the extremely vigorous growth, which is characteristic of this variety. Nearly as hardy as Hardy Winter, and very popular with many of our customers.

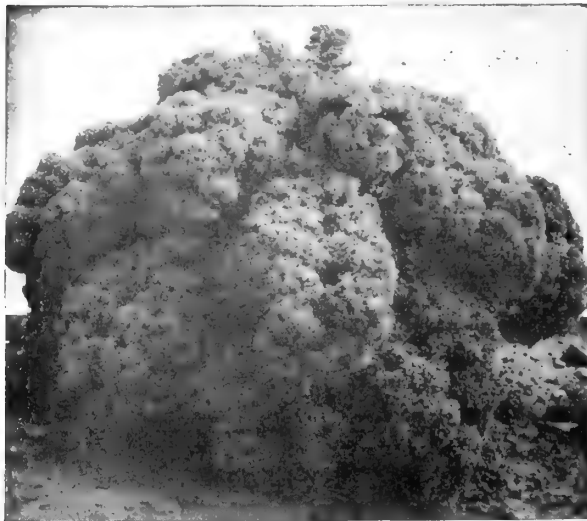

Borecole—Superior Extra Curled

PRICES

BORECOLE	Pkt.	Oz.	¼ Lb.	Lb.
Blue Curled Scotch.....	\$.10	\$.20	\$.60	\$2.00
Curled Perfection.....	.10	.25	.75	2.25
Dwarf Green Scotch.....	.10	.20	.60	1.75
Hardy Winter.....		Not Available		
Superior Extra Curled...	.10	.30	1.00	3.00

KALE

Extra Curled Long				
Standing.....	.10	.15	.40	1.25
Manns' No. 640.....	.10	.30	.85	2.50
Siberian Kale				
(Extra Early).....	.10	.15	.30	1.00
Spring Smooth Leaf				
(Hanover).....	..	.10	.20	.50
Hanover Late Seeding....	.10	.15	.30	1.00

Number of days indicates time from setting plants to first cutting

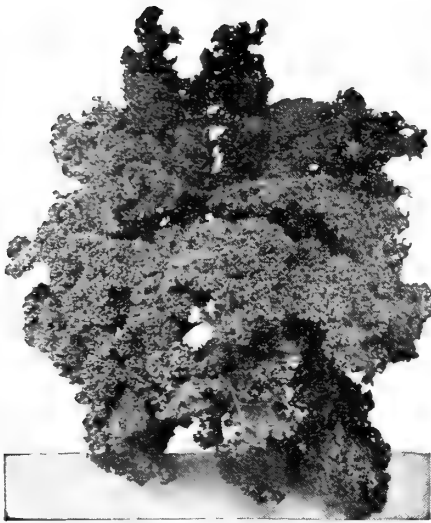

Kale, Extra Curled—Long Standing



Monstrous Carentan Leek

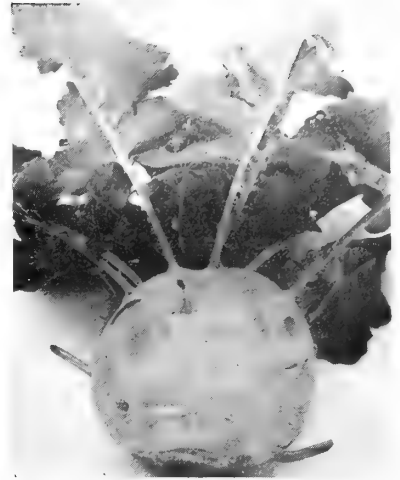

Early White Vienna

Kale (Siberian)

Broadcast, 2 to 3 lbs. per acre; 1 oz. to 200 ft. of drill

The Kales are more hardy than Cabbage, and make excellent greens for winter and spring use. For early spring use, sow broadcast in September. For later use sow in April or May.

Extra Curled Long Standing (65 days) An improvement on the well-known German Extra Curled Kale; beautifully curled, of strong, vigorous habit, perfectly hardy and slow-shooting to seed.

Extra Early Siberian (60 days) Ready for cutting earlier in spring than Long Standing.

Mann's No. 640 (65 days) The longest standing of any Kale we know, beautifully curled and having a distinct bright green color.

Spring Smooth Leaf or Hanover Salad (30 days) Quick-growing, very hardy smooth leaf sort, tender when young.



Kale—Early Siberian

Kohlrabi

1 oz. will produce 1,500 plants

This forms a bulb above the ground, and has a distinct fresh green delicious flavor. Sow in April in rows 18 inches apart, thinning out to 8 inches between the plants. Also grown as a fall crop by sowing August 1st.

Early White Vienna (55 days) Excellent for forcing and of fine quality. The bulbs grow to the size of an apple when ready for use, and are a pale whitish-green.

Triumph-Prague (50 days) Extremely early forcing variety, winner in "All-American" trials.

Leek

1 oz. to 150 yds. of drill; 4 lbs. per acre

Sow early in the spring in drills 1 inch deep and 12 inches apart, when about 6 inches high transplant into deep, rich soil, 5 inches apart; use a dibble and plant deeply, close to their leaves.

Monstrous Carentan OR SCOTCH CHAMPION. (150 days) Of extra large size; leaves fan-shaped, dark green; the edible stem is 6 to 8 inches long and 3 inches in diameter.

Special Big No. 7 (150 days) Improved large variety with unusually long thick white stalk.

PRICES

	Pkt.	Oz.	¼ Lb.	Lb.
KOHLRABI				
Early White Vienna.....	\$.10	\$.35	\$1.00	\$3.00
Triumph-Prague.....	.10	.50	1.35	4.00
LEEK				
Large American Flag....	.10	.55	1.65	5.00
Monstrous Carentan.....	.10	.55	1.65	5.00
Special Big No. 7.....	.10	.60	2.00	6.00

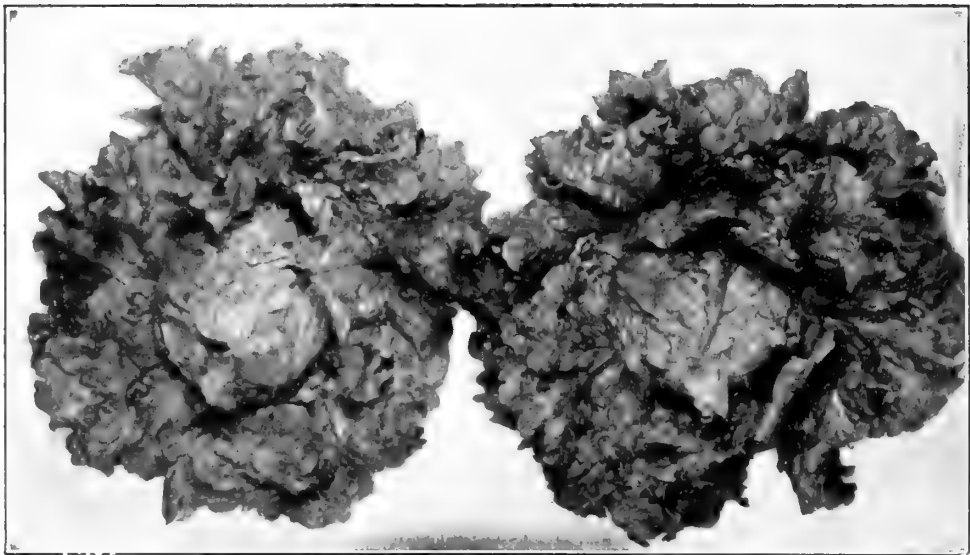

Imperial Iceberg No. 847

Lettuce

1 oz. to 2,500 plants; 3 lbs. per acre

Days given represent time for growing marketable heads from date of sowing seed.

Lettuce to be at its best should be grown rapidly, hence the soil should be made as rich and friable as possible by liberal manuring and thorough preparation. For early crop sow in a seed-bed in September or October and protect through the winter with cold frames, which should be removed as soon as danger of severe freezing is past. Lettuce in the open ground will stand some freezing but is killed by prolonged frost or frequent freezing and thawing. The seed may also be sown in hotbeds in March, and the plants, if well hardened, may usually be set in the open ground in April, maturing a crop much earlier than complete open ground cultivation would produce. If, however, it is not convenient to get the plants started either in the fall or early spring in hotbeds, the seed may be sown in open ground from the middle of April until July, selecting varieties suitable for the season.

The plants should stand 8 to 16 inches apart in the rows according to variety and the rows should be about 18 inches apart. Heading varieties particularly should be well spaced to afford plenty of air circulation which helps materially in preventing bolting to seed.

Grand Rapids (43 days) U. S. No. 1. Tip Burn Resistant. Popular loose-leaf strain, very satisfactory for both market and home gardens.

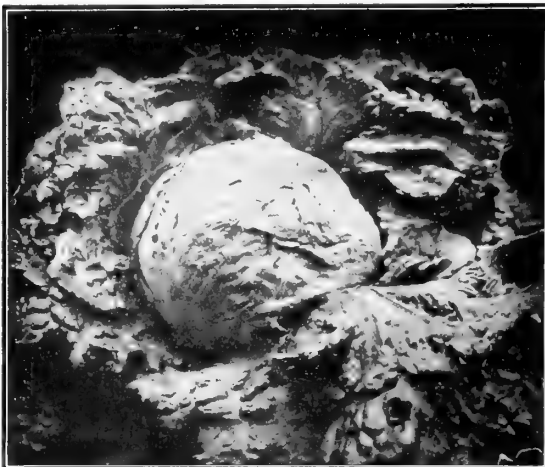

Imperial Iceberg No. 44

Slobolt (45 days) An excellent high quality, crisp loose leaf variety developed by the U. S. Dept. of Agr. A Grand Rapids type, remaining in perfect edible condition for a long period.

Bibb (57 days) Finest quality home gardeners extra early head lettuce; forms small very dark green head. Must be grown to head very early in summer or very late as it readily bolts to seed in hot weather.

May King (65 days) Extremely early, compact, forming very firm heads of medium size and excellent quality. Color light yellowish-green, tinged with reddish-brown when mature. Inner leaves blanch rich golden-yellow, very tender and buttery.

Salad Bowl Loose leaf variety, seems to stand sun very well, is fast and large grower, slow to bolt and of extreme high quality. Leaves are short and closely set hold their quality, tenderness and fine texture over a long period. Developed by Dr. Ross C. Thompson of the U. S. Dept. of Agriculture.

PRICES

	Pkt.	Oz.	¼ Lb.	Lb.
All Seasons	.10	.20	.60	2.00
Bibb	.10	.35	1.00	3.00
Big Boston	.10	.20	.60	2.00
Cabbage Head	.10	.20	.60	1.75
Cos, or Romaine (White)	.10	.20	.60	1.75
Cos, Extra Dark Green	.10	.20	.60	2.00
Grand Rapids	.10	.20	.60	1.75
Great Lakes	.10	.50	1.65	5.00
Great Lakes Special (M.R.)	.10	.85	2.50	7.50
Iceberg	.10	.40	1.00	3.40
Imperial No. 44	.10	.40	1.00	3.40
Cornell No. 456	.10	.60	1.85	5.50
Imperial Iceberg No. 847	.10	.35	1.00	3.00
May King	.10	.20	.60	2.00
Oakleaf	.10	.40	1.15	3.50
Pennlake	.10	.85	2.50	7.50
Premier Great Lakes	.10	.85	2.50	7.50
Progress (2428)	.25	1.00	3.00	10.00
Salad Bowl	.10	.45	1.35	4.00
Slobolt	.10	.35	1.00	3.00
Unrivalled	.10	.20	.60	1.75
White Boston	.10	.20	.60	1.75



Manns' Lettuce Seed is used by the largest commercial growers

Lettuce

Unrivalled (75 days) Medium sized, nearly globular heads; outer leaves pale green, interior nearly white, tender and sweet. A dependable header.

White Boston (75 days) We offer the Cornell No. 43 large, heavy, light green type. Entirely free from red edge and popular among market gardeners.

Cornell No. 456 (80 days) A very sure heading Imperial type, resistant to early bolting and to tip burn. Frame and head slightly smaller than Great Lakes and of lighter color. Particularly adapted for muck soils.

Pennlake (77 days) Developed at Penn State College for an early, large, firm-heading type. Tipburn resistant and sure heading on both muck and upland soils.

Premier Great Lakes (80 days) An All American winner for 1949. Upland variety with sure heading tendency and stands summer heat even better than original Great Lakes. Has broad fringed leaves forming well rounded, crisp, solid heads of excellent quality.

Progress (82 days) Developed by the U. S. Dept. of Agr. and the N. J. Exp. Sta. An ideal Iceberg type for eastern weather conditions. Resembles Imperial 44 but with a distinct bright green color and greater tip burn resistance. Has been thoroughly tested before being released.

Great Lakes (82 days) One of the most satisfactory of the Imperials. Large and vigorous, attractive color, resistant to tip burn and stands up well in hot weather.

Imperial Iceberg No. 44 (82 days) Developed in California by Dr. Jagger of the U. S. D. A. primarily as a sure heading, disease resistant variety for shipping to the eastern markets. Its adaptability to many various growing centers and a wide range of climatic conditions make it one of the most dependable and sure heading types of Iceberg for this section.

Imperial Iceberg No. 847 (84 days) Black seeded strain grown successfully in the east and south for several years. Produces large size, solid, well rounded heads under conditions where other Iceberg types do not succeed.



White Boston

COS (ROMAINE) LETTUCE

White Cos (68 days)

Grows to very large size, producing long-pointed, compact bunches. The outer leaves are closely folded about the center and interior is well blanched.



Cos Lettuce

Cos, Extra Dark Green (68 days) Similar to White but darker in color.

LETTUCE PLANTS

FRESH DAILY IN SEASON—See Page 58

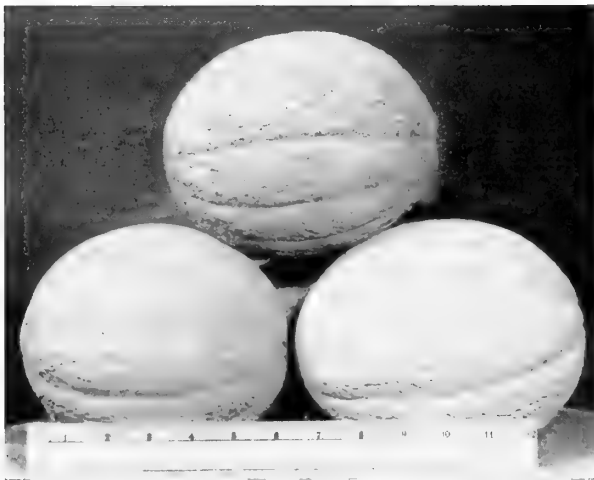

Pride of Wisconsin

Long John (100 days) Very large, oblong, green fleshed, sweet.

Honey Ball (105 days) Possesses characteristics that make it one of the finest melons that has ever been offered to the grower, the shipper and the consumer. Exceedingly prolific, individual plants producing as many as fifteen to twenty 5 in. dia. cantaloupes to the plant.

Honey Dew (112 days) A melon of the Cassaba type. The fruit is large, oval in form, about 10 inches long and 8 inches in diameter; thick flesh is light green in color, ripening to the rind, very tender, with an extreme sweetness. The vines are vigorous and set 6 to 10 melons to the hill. An excellent shipper, will keep for several weeks even when fully ripe.

SALMON FLESHED VARIETIES

Golden Delight (80 days) Fruits are 4 to 5 inches diameter by 5 to 7 inches long, have thick flesh. Skin is slate gray maturing to deep yellow. Distinctly ribbed and rather heavily netted, home garden and market melon.

Hale's Best Jumbo (83 to 88 days) A leading variety for market gardeners and shippers. Fruits oval, about 7½ x 6 inches, weighing 5 to 6 lbs., heavily netted and with ribbing somewhat prominent. Flesh is thick, sweet and of excellent quality.

Hale's Best No. 45 (85 to 90 days) An important shipping and home garden variety, resistant to powdery mildew, having thick, firm, sweet flesh with very small seed cavity. Fruits oval about 6½ x 5 inches and weighing 3 to 4 lbs., indistinct ribs, can be picked for shipment when nearly full ripe.

Sugar Rock (85 days) A valuable distinct type. Sweet as sugar and solid. Has marvelous flavor and can be thoroughly ripened before picking. A remarkably heavy yielder.

Texas No. 1 A cross between Porto Rican Rocky Dew and Hale's Best, developed by the Texas Exp. Sta.; extremely prolific, resistant to downy mildew and aphids, fruits about 7 in. long by 6 in. in dia. with very thick flesh.

Muskmelon

CANTALOUPE

1 oz. for 50 hills; 3 lbs. per acre

The most suitable soil for melons is a warm, sandy loam, well worked and enriched with rotted manure. After danger from frost is over, sow ten to twelve seeds to a hill, about 2 inches deep; the hills being six feet apart each way. When the plants have the second pair of leaves and danger from insects is past, thin out to four plants to a hill. Many large growers produce potted plants in hotbeds, thereby assuring an earlier crop to set out in May or earlier under Hotkaps. Cultivate frequently, deeply away from the plants and shallow close to them. When hoeing, remove the crust from around the plants and replace with fine, loose soil.

GREEN FLESHED VARIETIES

Knight's Early Maryland (82 days) An extremely early medium sized melon. Fruit oblong, skin deep green, turning to golden at maturity, well covered with a close gray netting and distinctly ribbed; flesh fairly thick and very sweet; color medium green blending to light pink near the center. The earliest high quality green flesh melon and a good shipper.

Jasper (90 days) Our stock of this Anne Arundel County variety is a definitely established fixed type which is well netted, uniform in size and shape and of excellent quality. It is prolific, medium early and in general a profitable variety to grow.

Improved Rocky Ford, Jr. (90 days) A large wilt resistant type of Rocky Ford. Fruit oval, slightly ribbed, densely covered with coarse netting. Flesh light green, very thick and highly flavored.

	PRICES			
	Pkt.	Oz.	¼ Lb.	Lb.
Clark	\$.10	\$.30	\$1.00	\$3.25
Craig10	.30	.90	2.75
Golden Delight10	.50	1.50	4.50
Hale's Best Jumbo10	.20	.65	2.00
Hale's Best No. 4510	.20	.65	2.00
Hearts of Gold10	.25	.65	2.00
Honey Ball10	.20	.60	1.75
Honey Dew10	.20	.60	2.00
Jasper10	.30	.85	2.50
Knight's Early Maryland10	.20	.60	2.00
Long John10	.30	.90	2.75
Pride of Wisconsin10	.20	.60	1.75
Rocky Ford Improved, Jr.10	.30	.85	2.50
Sugar Rock10	.25	.75	2.25
Texas No. 110	.20	.60	2.00

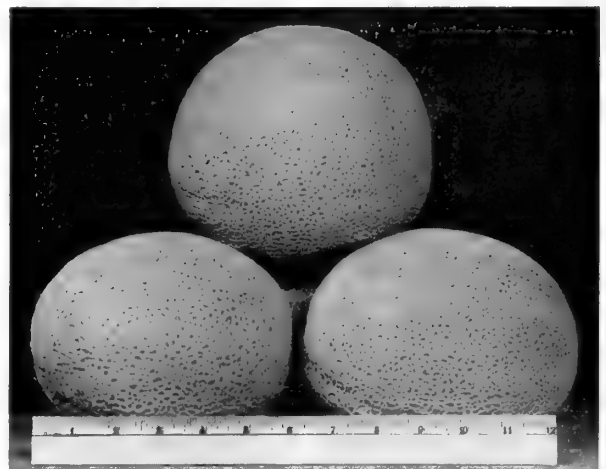

Hale's Best Jumbo

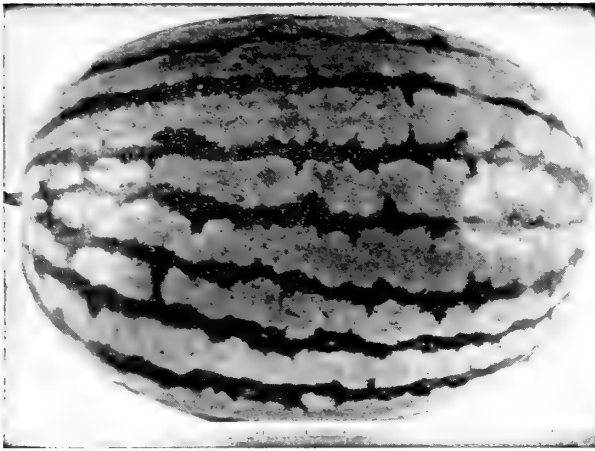

Dixie Queen



Stone Mountain

Watermelon

1 oz. for 30 hills; 3 or 4 lbs. per acre

Cultivate exactly as for Cantaloupe, except that the hills should be 8 to 10 feet apart.

Early Canada (75 days) Perhaps the earliest good quality melon, usually about 9 inches in diameter, nearly round.

Blacklee (85 days) Developed at Florida Exp. Sta. Vigorous, very resistant to Fusarium Wilt. Fruits long dark green, flesh bright red of sweet flavor. Weight 35 lbs.

Dixie Queen (85 days) A fine-flavored, early round melon; skin striped dark green and greenish ivory, flesh bright red, solid and sweet. Shipped as White Seeded Cuban Queen. Weight 30 lbs.

Kleckley's Sweet (85 days) This very popular melon is one of the best for nearby markets. Fruits are medium size, oblong, of a dark green color and have very thin rind. Flesh bright scarlet with solid heart, crisp, sugary and melting, and entirely free from stringiness. Weight 30 lbs.

Stone Mountain (90 days) The outstanding introduction in the last few years. Can be shipped long distances and its edible qualities are distinctly superior to any other shipping variety. Weight 35 to 40 lbs.

Florida Giant (95 days)—Vigorous and prolific; fruits very large, nearly round, flesh bright red, crisp and sweet. Weight 40 to 50 lbs.

Tom Watson (95 days) A large long melon with dark green rind and light crimson flesh of excellent quality, and a splendid shipper. Weight 35 to 40 lbs.

Mushrooms

Anyone with a fair understanding of the cultural requirements can grow Mushrooms successfully in any climate and in any season where the following conditions obtain:

1. Good spawn, procured from a reliable source.
2. A properly prepared bed with reasonable protection against weather extremes.
3. A temperature not greatly exceeding 60° F. nor much lower than 50° F.
4. A fairly moist temperature, avoiding the too frequent and direct application of water to the beds.
5. A gradual renewal of the air, avoiding draughts.

One brick will seed an area of 8 to 10 square feet. One quart bottle will seed an area of 35 to 40 square feet, depending on the size of piece planted. Full cultural directions free with purchase of spawn.

Bricks 30c ea.; 10 bricks \$2.75; bottle spawn \$1.25 ea.

MUSTARD	Pkt.	Oz.	¼ Lb.	Lb.
Fordhook Fancy	\$.10	\$.20	\$.50	\$1.50
Giant Southern Curled...	.10	.15	.40	1.25
Tendergreen (Mustard Spinach)10	.15	.30	1.00
WATERMELON	Pkt.	Oz.	¼ Lb.	Lb.
Blacklee (Wilt Resistant)	.10	.20	.60	2.00
Congo10	.30	.90	2.75
Dixie Queen10	.20	.60	2.00
Early Canada10	.25	.75	2.25
Florida Giant10	.20	.60	1.75
Garrison (90 days).....	.10	.25	.75	2.25
Kleckley's Sweet10	.20	.50	1.50
New Hampshire Midget..	.25	.60	1.75	5.25
Stone Mountain10	.20	.50	1.50
Tom Watson10	.20	.50	1.50

Mustard



1 oz. to 200 ft. of drill; 4 lbs. per acre
 Sow the seed early in the spring thinly in rows about a foot apart. For fall use sow in August.

Fordhook Fancy (65 days) Darker green and leaves more curled at the edges than any other sort.

Giant Southern Curled (65 days) The largest variety, forming a mass of finely curled leaves of good flavor; hardy and vigorous.

Onions

To grow large bulbs 1 oz. to 100 ft. of drill; 4 to 5 lbs. per acre. To grow sets 10 oz. to 100 ft. of drill; 50 lbs. per acre.

The Onion must have a clean and very rich soil. Use well rotted manure freely, and get the seed in as early as possible in the spring, no matter if it is cold and unpleasant. If onions do not get a good growth before hot, dry weather, the crop is sure to be a failure. Keep the soil mellow and clear of weeds. Sow in shallow drills, not less than a foot apart nor more than half an inch deep. As onions grow on top of the ground, they may be allowed to remain pretty thick, no matter if they crowd each other. In hoeing, destroy weeds and keep the ground mellow; do not cover the young bulbs with earth. Harvest while tops are partially green and just after they fall over. This is indication of proper maturity for best storage results.

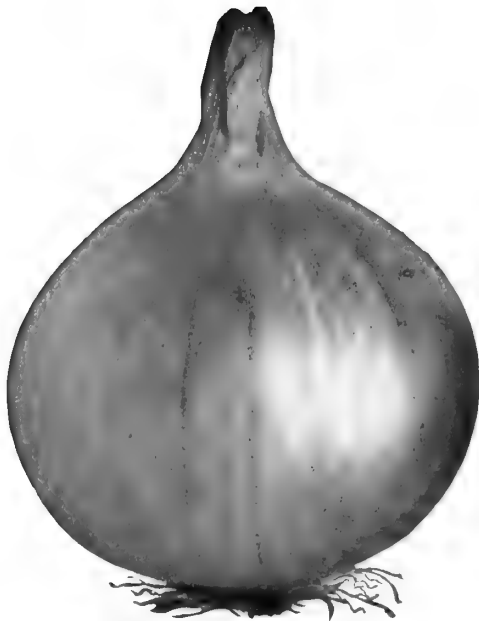

White Silver Skin Onion

White Queen (90 days) Used extensively for a bunch onion, solid flesh of a mild flavor.

Early Yellow Globe (100 days) Matures medium large uniform globe-shaped bulbs which keep exceptionally well.

White Silver Skin, or Portugal (100 days) Used for growing sets and picklers. It is a good keeper. The bulbs grow to good size, ripening early and quite evenly. The flesh is mild and sweet, the thin skin a clear silvery white, of handsome appearance if the bulbs are gathered as soon as ripened and carefully dried under shelter away from the strong sunlight. When seed is sown at the rate of 20 to 25 pounds per acre, it makes bulbs of suitable size and most desirable for pickling.

Southport White Globe (110 days) Pure white, true globe form with very crisp flesh, exceedingly mild and fine grained.

Yellow Globe Danvers (110 days) Grows to a good size, slightly flattened globe shape, with thin yellow skin, white flesh, fine grained and excellent quality. Ripens early, keeps well and is very productive.

Prizetaker (115 days) Produces extra large, well-ripened bulbs the first season from seed; flesh white; crisp and mild in flavor. The skin is thin, of a bright straw-yellow; form nearly a perfect globe. Under ordinary cultivation this variety will yield bulbs nearly three times as large as the Globe Danvers, while under special cultivation specimen bulbs have been raised to weigh from 4 to 5 pounds each.

Golden Globe (Bottle Neck) (118 days) Very good storage or market type, medium light, deep globe bottle neck shape, skin dark golden, flesh creamy yellow, crisp, firm and mild.

Use a

FELINS TYING MACHINE

FOR BUNCHING SPRING ONIONS

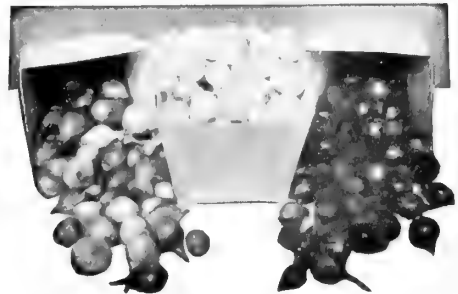

ONION SETS

FINE QUALITY MARKET GARDENERS STOCK

25c qt.—Pk. (8 lbs.) \$1.50

Subject to change. Postage Extra

Let Us Quote Larger Quantities



Early Yellow Globe

PRICES

	Pkt.	Oz.	¼ Lb.	Lb.
Danvers—Yellow Globe ..	.10	\$.40	\$1.15	\$3.50
Early Yellow Globe.....	.10	.50	1.50	4.50
Golden Globe10	.55	1.65	5.00
Prizetaker10	.30	1.00	3.00
Southport White Globe...	.10	.45	1.35	4.00
White Bunching15	.45	1.35	4.00
White Ebenezer10	.50	1.50	4.50
White Lisbon15	.50	1.50	4.50
White Queen10	.55	1.65	5.00
White Silver Skin, or Portugal10	.45	1.35	4.00
Yellow Sweet Spanish....	.10	.30	1.00	3.00



Okra

Okra or Gumbo

1 oz. to 30 ft.; 10 lbs. per acre

Sow in drills during April and May. Thin plants to 12 inches apart and draw earth to the stems for support.

Emerald (55 days) Plants 4½ feet tall, vigorous pods, thick walled, 6 to 8 inches long and ¾ inches in diameter at center; slightly curved, dark green.

Dwarf Green Longpod (50-55 days) A distinct variety, growing about 14 inches high; very prolific.

Parsley

1 oz. to 150 ft. of drill

Sow in rows 1 foot apart and 1 inch apart in the row. The seed is slow to germinate, and should be given the most favorable conditions. A deep, rich loamy soil is required. For winter use a few plants placed in a box in the cellar will give a supply.

Champion Extra Dark Moss Curled

(70 days) The large leaves are very heavily crimped and curled. Very productive and most attractive, dark green color and fine mossy appearance.

Green Castle (85 days) An extremely hardy, late or main crop variety which grows rather slowly early, but is tall and densely curled.

Hamburg or Turnip-Rooted (90 days) The large fleshy root, which resembles the root of a Parsnip, and is highly esteemed for flavoring soups, stews, etc.

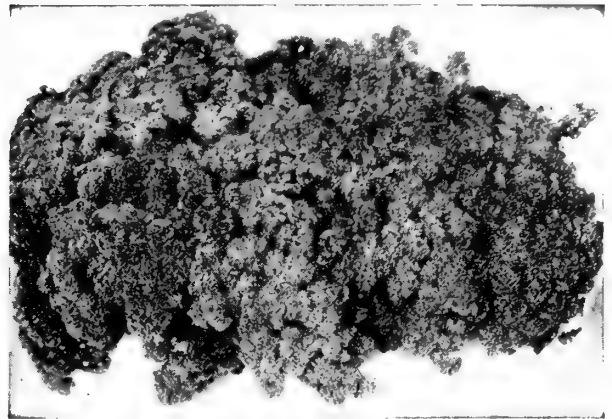

Champion Extra Dark Moss Curled



Parsley grown in N. J., under Irrigation



Hamburg Parsley

PRICES

OKRA OR GUMBO	Pkt.	Oz.	¼ Lb.	Lb.
Clemson Spineless	\$.10	\$.20	\$.50 \$1.50
Dwarf Green Longpod10	.15	.40 1.25
Emerald10	.20	.60 2.00
White Velvet (60 days)10	.15	.40 1.25

PARSLEY	Pkt.	Oz.	¼ Lb.	Lb.	10 Lb.
Champion Extra Dark Moss Curled	\$.10	\$.15	\$.50 \$1.50 \$12.50	
Green Castle10	.15	.50 1.50 12.50	
Paramount10	.15	.50 1.50 12.50	
Plain or Single (72 days)10	.15	.50 1.50 12.50	
Hamburg10	.15	.50 1.50 12.50	

Peas

1 quart to 100 ft. of drill; 1½ bushels per acre

Peas grow best on a light, rich, mellow soil under cool and moist weather conditions. Fresh manure and very rich or wet mucky soil should be avoided.

The extra early varieties are very hardy and should be planted as soon as the ground can be made ready, while the larger wrinkled varieties, which are not as hardy but of superior quality, may be planted when the soil has become slightly warmed, as the seed will rot if planted too early.

For private use, sow the seed in double rows, 18 inches apart and 3 inches apart in the row; for market, in single rows 2 to 3 feet apart and 1 inch apart in the rows. The peas will give quicker returns if covered only one inch deep, and where earliness is most important they may be treated this way. Larger pods and greater quantity will be produced if the seed is planted in trenches three to six inches deep and covered with only one to two inches of soil. When the plants are five or six inches high, fill the trench level with the surface. This will result in deep rooting, prevent mildew and prolong the bearing season. If the peas are covered to the full depth at first, or if water is allowed to stand in the trenches the seed will not germinate or grow well. The crop should be gathered as fast as it becomes fit for use, as even a few ripe pods left on the vines tend to retard the development of the young pods and prevent the formation of new ones.



Early Bird

FIRST EARLY SMOOTH VARIETIES

Extra Early Alaska (57 days) Vine strong and vigorous, 2 to 2½ feet high, of a peculiar light green color, pods 3 to 3½ inches long, straight and blunt at the end. Seed round, blue, slightly pitted. Matures crop very evenly.

Early Bird (60 days) The most used and best extra early, large podded Dwarf now on the market. Very desirable for market gardeners and truckers. Seed is practically smooth, dark green in color, can be planted as early as the Alaska. Produces a strong, vigorous vine, dwarfed in length. Pods produced in profusion and are long, large, pointed and well filled with good sized peas. Is an excellent cropper and has replaced practically all other extra early varieties.

Long-Podded Alaska (60 days) A favorite with truckers and shippers to Northern markets, producing a very early crop of large, broad- well-filled, dark green pods. Equally as hardy as Extra Early Alaska and much larger. The vines usually grow three feet high and the crop will remain fresh a long time after picking.

Mammoth Podded Extra Early (60 days) An exceptionally early, large podded variety. Matures practically with Alaska and much more productive. Height 3 feet, pods 4 inches long, very dark, broad and round.



California Mammoth

Variety	PRICES		
	Pt.	Qt.	Fl.
Alaska—Wilt-resistant30	\$.55	\$3.00
Early Bird40	.75	4.00
Extra Early Alaska30	.55	3.00
Long Podded Alaska35	.65	3.50
Mammoth Podded Extra Early ..	.40	.75	4.00

Peas

WRINKLED VARIETIES

Gradus (Prosperity) (62 days) Produces long pointed pods, well filled and of fine table quality. Vines from 2½ to 3 feet in length. Considered one of the most desirable for the market garden or home use.

Laxtonian (62 days) This is one of the finest dwarf early peas. The vines grow 18 to 20 inches high and produce an enormous crop of 4 in. dark green pointed pods.

Little Marvel (62 days) An ideal home garden and early market variety, popular for years for its outstanding quality and yield. Vine: stocky, medium height. Pods: blunt, plump, dark green, 3 in. long, well filled.

Thomas Laxton (62 days) One of the highest quality freezing and garden varieties. Pods blunt, dark green, 3¼ in. long. Vine 2 ft., slim.

Blue Bantam (63 days) An improved strain of the Laxtonian type. Very early and produces pods a little darker than the Laxtonian. Vines are 16 to 18 inches high.

Freezonian (63 days) All American Winner. Improved Thomas Laxton type, 3¼ in. dark green blunt pods, wilt resistant.

Early Wonder (65 days) An extra early variety of excellent quality, producing an abundance of dark green pods 4 to 5 inches long, very broad and well filled. The earliness, quality and the wonderfully prolific characteristics of this variety make it a very profitable sort for market gardeners.

California Mammoth (70 days) Medium early profuse bearer of large handsome dark green pointed pods. Can be very profitably grown by commercial growers and home gardeners as a succession to Early Bird and the Laxtonian types.

Alderman (75 days) One of the best long vined, main crop varieties. Hardy, prolific producing vines 3½ to 4 feet in length. Pods large, pointed dark green in color.

Dwarf Telephone (75 days) A second early, of robust but remarkably even growth. From 16 to 18 inches high. The stout plants are fairly loaded with large, bright green pods. Each pod contains from 7 to 9 large peas of a light bright green color, tender and well flavored.

Dark Green Telephone (75 days) A tall-growing, late sort, 3½ to 4 feet in height, having beautiful dark green pods of very large size, containing 6 to 7 large peas of delicious flavor. Continues in bearing for quite a long time.

EDIBLE PODDED PEAS

Dwarf Grey Sugar (62 days) Vines 24 in. bearing 2¼ in. light green-pointed pods with small gray peas.

PEANUTS

Virginia Bunch (145 days) Earliest, most prolific and easiest cultivated variety. **Lb., 35c; 10 lbs., \$3.00.**

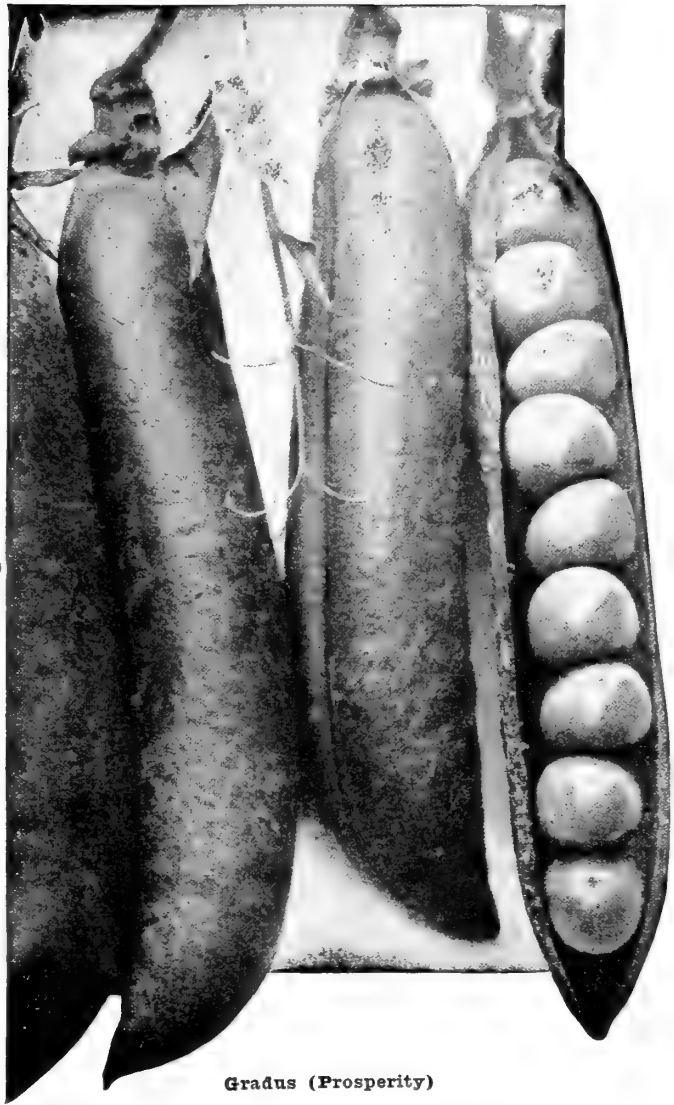

Gradus (Prosperity)

	PRICES	Pt.	Qt.	Pk.
Alderman—Wilt resistant	\$.40	\$.75	€4.00
Black Eyed Peas (100 days)30	.55	3.00
Blue Bantam40	.75	4.00
California Mammoth40	.75	4.00
Dark Green Telephone—W.R.40	.75	4.00
Dwarf Grey Sugar45	.85	4.50
Dwarf Market40	.75	4.00
Dwarf Telephone—W.R.40	.75	4.00
Early Giant (66 days)40	.75	4.00
Early Wonder40	.75	4.00
Freezonian45	.85	4.50
Gradus (Prosperity)40	.75	4.00
Laxtonian (Hundredfold)40	.75	4.00
Little Marvel40	.75	4.00
Thomas Laxton40	.75	4.00
World's Record (58 days)40	.75	4.00

Peppers

1 oz. to 1,500 plants

6 to 8 weeks to produce plants

Peppers should be sown either indoors or in hotbeds early in April and transplanted to the permanent beds when about 3 inches high in two foot drills and two feet apart in the drills. The seed can also be sown in open ground when danger from frost is past but the crop will naturally be much later. A top dressing of fertilizer or poultry manure well mixed with the soil when the plants are about 6 inches high will materially aid in the production of a big crop.



World Beater

Long Red Cayenne (70 days) The pods are long and slender; bright red color and very pungent. This is an old-time favorite and is used extensively for bunching with pot-herbs.

World Beater (70 days) This splendid pepper is a cross between Chinese Giant and Ruby King, and combines the size of one and the earliness of the other. It is exceedingly mild, very large, four lobed and the color good. The flesh is very thick, making distant shipment possible.

California Wonder (75 days) Its large, smooth, extremely heavy, very mild, thick flesh, make this variety truly a wonder. Combining the excellent quality of the Pimento and the size of Crimson Giant, California Wonder is being grown for all purposes. Plants are sturdy, productive and slightly spreading, bearing five to nine large glossy fruits to a setting, averaging one-half pound each. Deserves the attention of every pepper grower.

Pimento or Perfection (75 days) A medium early, prolific, perfectly mild variety with extremely thick flesh. On account of its thick flesh it will hold up for a long time, and is an excellent sort for canning whole.

Chili, Small (80 days) Red conical pod, about 2 inches long, very hot. Fine for pepper sauce and seasoning.

Cherry Red (82 days) Fruit small, round, color rich scarlet, very hot.

Chinese Giant (85 days) This desirable variety is one of the largest sweet peppers ever offered. The flesh is quite thick, very mild and remarkably sweet.

Pepper Plants See Page 58.



Chinese Giant



California Wonder

PRICES

	Pkt.	Oz.	¼ Lb.	Lb.
California Wonder	\$.10	\$.30	\$2.50	\$7.50
Calwonder (67 days)	.10	.30	2.50	7.50
Chinese Giant	.10	.30	2.50	7.50
Cherry Red (Hot)	.10	.60	2.00	6.00
Chili, Small (Hot)	.10	.60	2.00	6.00
Floral Gem	.10	.30	2.50	7.50
Florida Giant	.10	.30	2.50	7.50
Half Long Cayenne	.10	.55	1.65	5.00
Long Red Cayenne (Hot)	.10	.60	2.00	6.00
Pimento or Perfection	.10	.30	2.50	7.50
Sunnybrook or Cheese	.10	.60	2.00	6.00
Sweet Banana	.10	.30	2.50	7.50
World Beater	.10	.60	2.00	6.00

Parsnips

1 oz. to 150 ft.
4 lbs. per acre



All American Hollow Crown

Sow in early spring in deeply prepared well drained soil. Thin to stand 3 to 4 in. apart. It is sometimes sown late in the summer for early spring use.

Parsnips are well known as a delicious table vegetable but their value for the purpose of feeding cattle and stock is but little appreciated. The parsnip is rich in saccharine food which adds greatly to the richness of the milk when fed to cows. The roots can be left in the ground all winter and improve in quality by the continued freezing.

Special Market Garden Strain (110 days) A smooth perfectly shaped selection privately held for many years. It produces roots nearly 100% true hollow crown, an extremely important characteristic always indicating highest edible quality.

All American Hollow Crown (110 days) A specially selected stock, developed for uniform well-shaped smooth roots of excellent quality.

Pumpkins

1 oz. to 15 hills; 4 lbs. per acre

Sow in good soil in May, when the ground has become warm, in hills 8 to 10 feet apart each way, or in fields of corn about every fourth hill; always avoid planting near other vines, as they will hybridize.

Cushaw, or Crookneck (110 days) Grown for pies and stock feeding. Fruits 2 feet in length, with long, solid neck. Flesh rich, creamy yellow, tender and of exceptionally fine flavor. Weight 15 to 25 lbs.

Sweet Potato (110 days) Excellent for pies, pear-shaped, creamy white, sweet and delicious; first-class keeper. Weight about 15 lbs.

Sugar Pie Pumpkins (115 days) Best of all Pumpkins for pies. Small to medium size, solid and fine grained, and a splendid keeper.

King of Mammoths (115 days) Enormous, deep yellow. Often weighs 75 to 100 lbs.

Squash Pumpkin—Boston Marrow

See Squash, Page 33.

PARSNIPS		PRICES			
	Pkt.	Oz.	¼ Lb.	Lb.	
All American					
Hollow Crown	\$.10	\$.15	\$.50	\$1.50	
Special New Market					
Garden Strain10	.30	.85	2.50	
PUMPKINS					
Connecticut Field10	.15	.40	1.25	
Cushaw, or Crookneck					
Golden10	.20	.50	1.50	
Cushaw, Green Striped...	.10	.20	.50	1.50	
King of Mammoths10	.20	.50	1.50	
Sugar Pie Pumpkins.....	.10	.15	.45	1.25	



Sugar Pie Pumpkin

Radishes

1 oz. for 100 ft. of drill; 10 lbs. per acre.



Extra Early Scarlet Globe Outdoor Forcing

Greenhouse Scarlet Globe (22 days) This strain has been especially bred to meet the very exacting requirements of greenhouse cultivation, producing quickly a highly marketable crop of uniformly shaped radishes of fine quality.

Extra Early Scarlet Globe (23 days Outdoor Forcing) The popular commercial variety often called "Button Radish." Roots olive shaped, bright scarlet, flesh white and crisp. By selecting the most desirable type of this variety based on market demands we offer a strain having correct uniform shape and color plus exceptionally good tops for bunching.

PRICES

	Pkt.	¼ Lb.	Lb.	10 Lb.
Cherry Belle	\$.10	\$.30	\$1.00	\$9.00
Comet10	.30	.90	8.00
Crimson Giant10	.30	1.00	9.00
Greenhouse Scarlet Globe10	.30	.90	8.00
Long Black Spanish10	.40	1.25	11.50
Long Scarlet10	.30	.90	8.00
Round Black Spanish10	.40	1.25	11.50
Scarlet Globe10	.30	.90	8.00
Scarlet Globe Round10	.30	.90	8.00
Scarlet Globe No. 810	.30	1.00	9.00
Scarlet Turnip10	.30	.90	8.00
Sparkler10	.30	.90	8.00
Tidewater Globe10	.30	.90	8.50
White Chinese or Celestial10	.40	1.25	11.50
White Icicle10	.30	1.00	9.00
White Strasburg10	.30	1.00	9.00

(100 lbs., 20c per lb. under 10 lb. rate)

Light, sandy soil, rich in organic matter is essential to produce crisp and tender radishes. For an early crop sow the seed as soon as the ground can be worked, in drills 6 to 10 inches apart, covering the seed half an inch deep. When the plants are well started, thin out to one inch apart in the drills. Frequent watering in dry weather is very beneficial as high quality is largely dependent upon rapid growth. For a continuous supply, successive plantings should be made at intervals of 10 days to two weeks, selecting varieties best suited for the season.

Extra Early Scarlet Globe No. 8

(23 days)

From Specially Selected Transplanted Roots

A reselected strain so uniform in its maturity that each sowing can be entirely gathered and bunched at one pulling, with practically no waste. This means more bunches per row, more time saved in bunching, and the ground ready for the next crop a week earlier. This equalized maturity also permits sowing this crop between rows of beans, corn, etc., as a "catch crop." This is the market gardener's favorite as a forcing Radish, very early; mild and crisp, juicy and tender; ample top, will stand heat without becoming pithy. One of the best selling and most attractive Radishes on account of its bright scarlet color and handsome shape. Our stock of this is the very best, selected with special care as to size, shape, color and earliness. Market gardeners find it a money maker, as it is just right in every respect.

Comet (24 days) Distinctly a round or ball shaped sort of longkeeping quality. Has outstanding brilliant crimson color, with extra good tops for bunching. An All-American winner.

Sparkler (Round White Tipped)

(25 days) One of the most attractive for early planting outdoors. Color very deep scarlet with 1/3 white at the tip; flesh white and of the best quality.

White Icicle Radish (27 days) Planted in spring the young Radishes are ready for use in 25 to 27 days from sowing and their long, slender form and pure paper-white skin are most attractive when bunched for market. Flesh: clear white, brittle and of a mild flavor.



White Strasburg

Radishes

Crimson Giant (28 days) A variety combining earliness and extra size. It does not become pithy even when fully twice as large in diameter and a week older. Crimson-carmine; turnip-shaped; flesh firm, crisp and tender.

Long Scarlet (28 days) This is the standard extra early long scarlet market variety, short top, long scarlet roots; crisp, fine flavor.

White Strasburg (40 days) A very desirable summer variety. Skin and flesh both white. Of excellent quality and a quick grower.

WINTER VARIETIES

Long Black Spanish (55 days) Roots tapered cylindrical 7 to 10 in. long and about 2 1/4 in. in diameter. Skin black, flesh white, exceptionally good keeper, strong pungent flavor.

Round Black Spanish (55 days) Characteristics similar to Long Black Spanish, except that it grows top-shaped, 3 to 4 in. in diameter.

White Chinese or Celestial (55 days) Large, stump-rooted radish with white skin and flesh. Can be sown from July 1 to August 15, and will keep in prime condition, mild in flavor, brittle, and never woody.



Long Scarlet

Rhubarb

Sow in April or May, in drills 1 foot apart; when 3 or 4 inches high, thin out in rows 6 to 10 inches apart. Transplant the ensuing fall or spring in rich soil. Set out the roots 3 to 4 feet apart each way; the following spring it will be fit to use.

Crimson Winter Crimson stems of the finest color and quality, very early and continuing bearing over a long period.

RHUBARB ROOTS—See Page 58.

Sorrel

BROAD LEAVED (60 days)

A hardy plant grown for its leaves, which are used as boiling "greens" or salad. Seed should be sown thinly in drills early in spring. When well started thin out to stand 4 to 6 inches apart in the row. The leaves can be gathered for use at any time after the plants are well started in growth, and the roots will continue to produce a further supply. The plant is entirely hardy, and, starting into growth early the following spring, will afford a large supply of fine "greens" quite early.



White Icicle

Salsify

OR OYSTER PLANT

1 oz. for 50 feet of drill

Slow growing, hardy; requires 150 to 180 days; better if frosted.

Requires a well enriched, mellow soil, which, previous to sowing the seeds, should be stirred to a depth of 18 inches. Sow early in the spring in drills 15 inches apart; cover the seed with fine soil 1 1/4 inches in depth, and when the plants are strong enough, thin out to 6 inches apart. As the leaves resemble grass, be careful they are not mistaken for it when weeding.

Mammoth Sandwich Island A new and improved type, producing roots of nearly double the size and weight of the old varieties; mild and delicately flavored.

PRICES				
RHUBARB	Pkt.	Oz.	1/4 Lb.	Lb.
Crimson Winter	\$.10	\$.50	\$1.50	\$5.00
SALSIFY				
Mammoth Sandwich Island	.10	.30	1.00	3.00
SORREL				
Broad Leaf10	.35	1.15	3.50
Narrow Leaf10	.50	1.50	5.00

Seed Potatoes

LET US QUOTE PRICES ON HIGHEST QUALITY SEED ON BASIS OF LOWEST MARKET VALUE

Potatoes will adapt themselves to various soil conditions as easily as most vegetables. A better crop will be produced however, on a sandy loam which contains a quantity of well rotted vegetable matter. A clover sod, vetches turned under in the fall, or land which was heavily manured for a previous crop supply ideal conditions.

In preparing the seed the eyes should be cut so that the largest part of the surrounding flesh is situated toward the stem end, because the eyes of a potato always have a root system running toward that end and for that reason the sprouts cannot draw moisture from the opposite direction. If the ground you intend to use has produced a scabby crop previously or the seed shows any trace of disease, the pieces should be disinfected as a preventative.

For a very early crop, run off furrows about three feet apart and about four inches deep. Drop the pieces about 15 inches apart in the furrows and cover to a depth of about 1½ inches, gradually filling in the furrows to level as the vines grow larger. For main crop it is just as well to cover the eyes with four inches of soil at once. If fertilizer is used, apply it either in the row or broadcast before planting and be sure that it is thoroughly mixed with the soil so that the seed is not burned. Fresh stable manure will cause the potatoes to become scabby.

Just before the sprouts have appeared above the ground run a light harrow over them to kill the weeds and break up the crust. Continue weeding and harrowing until there is danger of breaking off too many sprouts. Cultivate thoroughly and frequently, being careful not to cut any of the roots, continuing until the vines have attained full growth and begin to spread.

Spraying for insects and blight is very necessary. Red River Potato Mix will give very satisfactory results in controlling insects and diseases.

The size and quality of the crop and the ability to resist disease is directly dependent upon the seed planted and no amount of cultivation or attention will offset the uncontrollable results of poor seed. Be sure of your crop and plant only the best.

Chippewa Introduced by the U.S.D.A. Seven to ten days later than Irish Cobblers. Disease resistant and a heavy yielder of medium size tubers, very uniform, oblong in shape, shallow eyes, skin smooth and clean white, excellent cooking quality.

Red Bliss, or Bliss Triumph The tubers are round and uniform in shape, eyes slightly depressed and of a beautiful bright red color, very hardy and vigorous, maturing with extra earlies.

Cobblers Popular early white, disease resistant, excellent quality. Medium to large in size, smooth, nearly round in shape, blunt ends, eyes very strong. A good keeper and a heavy cropper.

Green Mountain A dependable medium late main crop variety. Yields big crops of large, smooth white skin tubers of flatish oval form. Ripens slowly and is a good keeper. Cooks white, dry and mealy.

Kathadin Developed by the U.S.D.A. Matures a little earlier than Green Mountain, of oval shape, white skin and white flesh, shallow eyes. Very productive and a good keeper.

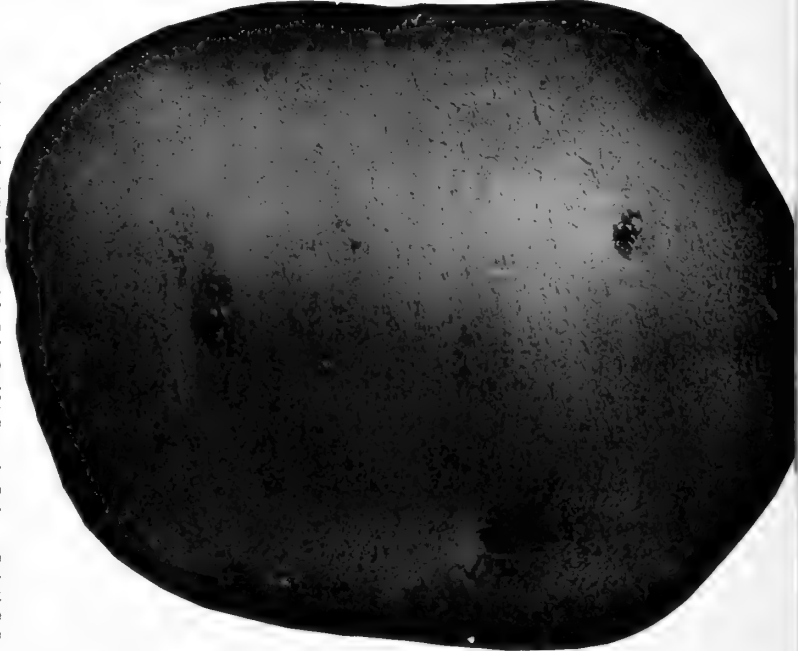

Sebago A cross of Chippewas and Kathadins developed by the U.S.D.A. Disease resistant, tubers are large, oval to oblong in shape. Ivory white, thin-skinned with shallow eyes. Excellent early shipper.

Seed Sweet Potatoes

Prices subject to market fluctuation—Let us Quote
Elzey's Improved Grows well in light sandy soil. This variety is a good yielder and keeper. It is a dry potato with light-yellow skin and flesh.

Maryland Golden The most popular of all yellow varieties on the market. Has golden yellow skin and flesh which is a deep yellow at the stem end. It has a moist flesh and is moderately sweet.

Sweet Potato Plants See Page 58.

NEW IMPROVED SEMESAN BEL

1 oz. treats 5 bushels



This instantaneous dip treatment for both white and sweet potatoes is fast replacing all formerly practised methods of seed potato disinfection. Semesan Bel exerts an invigorating effect upon plant growth by removing disease handi-

caps and repelling the attacks of soil-borne organisms so that yields are greatly increased. 2 ozs., 50c; 1 lb., \$2.30; 4 lbs., \$7.50.



Increase Your Profits
 Dust or Spray with
RED RIVER POTATO MIX
 With D.D.T.
 (1 to 1½ lbs. make 12½ gallons
 or as dust)
 Lb., 80c; 4-lb. bag, \$2.60.



Green Warty Hubbard



Golden Summer Crookneck

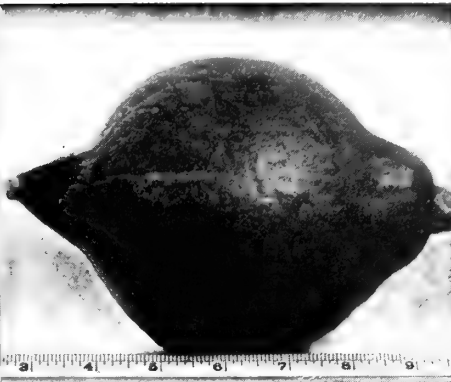

Boston Marrow

Squash

1 oz. of bush sorts to 40 hills; large seeded 15 hills.

2 lbs. of bush sorts to acre; large seeded 3 to 4 to acre.

Squashes, like other vines, are partial to a light, dry, rich soil. Plant bush varieties 4 ft. apart and the running varieties in hills 7 to 10 feet apart each way; thin out to three plants in a hill. Cultivate frequently until the vines commence running, after which do not work the soil deeply.

Early Prolific Straightneck (50 days) Produces an abundance of ten inch fruits in a week after blossoming. Very prolific, exceeding all other varieties in early production. Color, lemon-yellow. Vine about half the size of other varieties which permits close planting. An ALL AMERICAN Selection.

Green Tinted Bush Scallop (50 days) Preferred by many market gardeners by reason of true decided light green color, even when fully matured.

Early Golden Summer Crookneck

(52 days) A superior strain of summer crookneck, heavily warted, of a very deep orange color, 9 inches long, of excellent quality and highly productive.

Cocozelle Extra Long Italian (65 days) Produces fruit alternately striped dark and light green in the edible stage becoming dark green at maturity, about 20 inches long and 3 to 4 inches in diameter; very straight.

Table Queen or Acorn (New Mammoth Type) (80 days) Dark green, thin shelled, smooth, ribbed fruits with yellow flesh; favorite variety for baking.

Boston Marrow (or Squash Pumpkin)

(95 to 100 days) The fall and winter variety most widely used for canning and for pies. Fruits oval, pointed, deep orange color, weight 6 to 8 lbs. Very productive.

Green Warty Hubbard (110 days) Densely warted, much larger than Golden Hubbard; flesh exceptionally thick, deep orange, dry and of excellent quality.

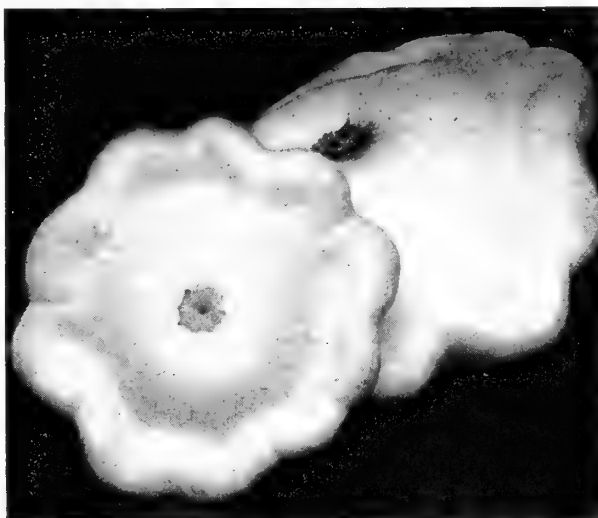

Green Tinted Bush Squash

PRICES

	Pkt.	¼ Lb.	Lb.
Acorn or Table Queen (Mammoth)	\$.10	\$.50	\$1.50
Blue Hubbard10	.60	2.00
Boston Marrow10	.40	1.25
Boston Marrow A & C10	.50	1.50
Butternut10	1.15	3.50
Casserta10	.60	1.75
Cocozelle, Extra Long Italian10	.50	1.50
Cocozelle, Vining10	.50	1.50
Early Golden Summer Crookneck10	.50	1.50
Early Prolific Straightneck10	.60	1.75
Golden Hubbard10	.60	2.00
Green Tinted Bush Scallop10	.50	1.50
Green Warty Hubbard10	.60	2.00
Jersey White Bush Scallop10	.50	1.50
Zucchini (Extra Dark)10	.50	1.50



Table Queen

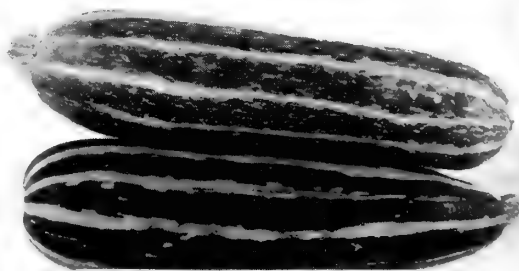

Cocozelle



Early Prolific Straightneck

Spinach

1 oz. to 100 ft. of drill; 12 to 15 lbs. per acre.



Extra Dark Green Savoy

Select a rich piece of ground, the richer the better; and for late spring and early summer use, sow the seed during February, March and April in drills one foot to 20 inches apart, one-half to one inch deep. When the plants are well started, thin out to 4 to 6 inches apart, or sow the seed thinly and allow all the plants to stand.

For winter and early spring use, sow either in drills or broadcast during August, September and October. A top dressing of Nitrate of Soda will make a vast improvement in the earliness, size and quality of the crop.

Number of days indicated shows time required from sowing to earliest cutting date. Long Standing varieties remain in marketable condition 10 days to 2 weeks longer.

Extra Dark Green Savoy (42 days) About two days later than Reselected, but the plants are larger, less liable to bolt to seed, more heavily crumpled and of more upright growth. The very dark green color, however, is its chief advantage and in making the selections for this deep color the plant breeder has also improved the strain in its savoyed characteristics and absolute freedom from smooth leaved plants.

Presto Savoy (42 days) A prickly seeded variety possessing outstanding merits over the round seeded Bloomsdale, which it resembles identically. Presto is the earliest and quickest growing sort of spinach. It is much hardier than any other variety and will stand cold and unfavorable weather conditions better than round seeded sorts.

Virginia Blight Resistant (39 days) A strain of Bloomsdale Savoy especially developed by the Virginia Experimental Station for the purpose of resisting the disease commonly called yellows. Used extensively in the vicinity of Norfolk and in other sections where blight is encountered. It matures very quickly and is therefore preferred for early fall sowing.

Reselected Bloomsdale Savoy (40 days) For either fall or late winter sowing, a truly reselected strain developed by a Holland Plant Breeder for uniformly curled large heavy plants.

Old Dominion (41 days) Developed at the Virginia Experimental Station as a later seeding yellows resistant variety by crossing King of Denmark and Virginia Savoy. The plants are large, dark green, heavily crumpled and fast growing. It is one of the most hardy varieties for wintering over and therefore is well suited for either an early fall crop or for fall sowing to be cut in early spring.

1000 lb. rate deduct 10%							
	Oz.	¼ Lb.	Lb.	10 Lbs.	25 Lbs.	100 Lbs.	
America10	\$.25	\$.75	\$6.50	\$15.00	\$40.00	
Extra Dark Green10	.25	.60	4.50	10.00	30.00	
Heavy Pack10	.25	.60	4.50	10.00	30.00	
Long Standing10	.25	.60	4.50	10.00	32.00	
Old Dominion10	.25	.60	4.50	10.00	30.00	
Presto10	.25	.60	4.50	10.00	30.00	
Reselected10	.25	.60	4.50	10.00	30.00	
Special Summer Savoy10	.25	.60	4.50	10.00	32.00	
Virginia B. R.10	.25	.60	4.50	10.00	30.00	
New Crop Seed Available about September 1						LET US QUOTE	
				Pkt.	Oz.	¼ Lb.	Lb.
New Zealand	\$.10	\$.15	\$.30				\$1.00
Tampala (Dark Green)25					(oz. 85c)	



Special Summer Savoy



Field of Early Long Standing Savoy for Seed

Early Long Standing Savoy (42 days) Nearly as early as Reselected Savoy but has the very valuable advantage of standing in perfect condition, without bolting to seed, 10 to 14 days longer. This feature is worth thousands of dollars to spinach growers, for with this variety it is possible to market the crop when it is convenient and advantageous for the grower to do so. Many severe losses have been incurred because cutters were not available, weather conditions unfavorable, or prices were too low, but Early Long Standing will wait for cutters, for weather, and for prices.

Heavy Pack (44-46 days) A leading canning variety. Very vigorous, large spreading plants with broad thick heavy leaves. Very productive and extremely slow in bolting to seed.

Special Summer Savoy (50 days) Stands warm weather without bolting to seed better than any other Savoy leaved type. A great improvement even on Bloomsdale Long Standing. Very dark green and heavily crumpled leaves. Very slow grower and should be sown so as to mature during warm weather.

America (50 days) A long standing heavy yielding, slow growing, warm weather variety with heavy thick, glossy dark green leaves, densely crumpled and savoyed. Plant averages 7 in. tall by 12 in. across at maturity. Won Silver Medal in All America trials.

New Zealand (70 days) (TETRAGONIA EXPANSA) Not related to regular spinaches but forming larger spreading plants producing fleshy brittle tips and leaves which are used as spinach. Of delightful flavor and practically ever-bearing.

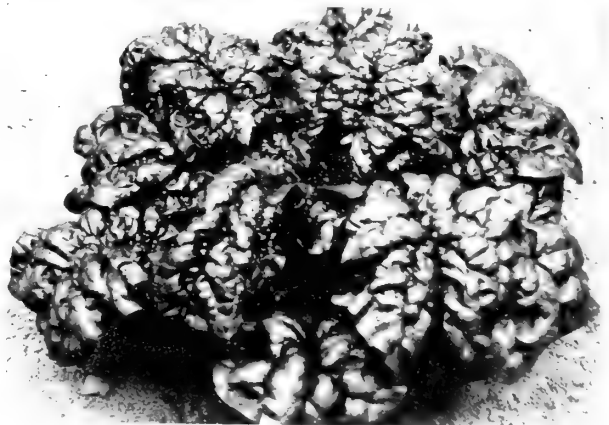

America



Tomatoes

Improved Advance

1 oz. to 2,000 plants; ¼ lb. per acre.

All our tomato seeds are grown from stocks, exclusively for seed purposes, by the originators, experienced growers and experts. We are fully convinced of the merit of all varieties before offering them in our catalog, and can strongly recommend our strains as being absolutely reliable.

For early, the seed should be sown in hotbeds during February or the first week in March, in drills 5 inches apart and half an inch deep. Later sowing may be made until the last of April. When the plants are 3 or 4 inches high they should be set out 4 or 5 inches apart in another hotbed or cold frame, or removed into small pots allowing a single plant to the pot. Expose to the air as much as possible to harden. Water freely at time of transplanting, and shelter from the sun a few days until the plants are established. Set out May 5th to 10th according to weather (or 3 weeks earlier if protected with Hotkaps) spacing 3 to 5 ft. apart. Cultivate thoroughly as long as the vines will permit, but the last two or three workings should be very shallow or the crop may be badly injured, especially if the cultivator is run too near the plants.

Days indicated represent approximate time from setting of plants to first picking. It takes 4 or 5 weeks to grow plants.

Improved Advance (64 days) An extra early, large tomato of high quality, round or slightly flattened shape, and exceptionally smooth for such an early variety. As early and hardy as Earliana and yielding more fruit both in the first and subsequent pickings. It is more shapely, more free from cracks and shows less green about the stem than other extra early sorts. With Improved Advance the grower can produce a crop which will stand superior in appearance and quality, in competition with the other extra earlies and command the fancy prices of an early market.

Scarlet Dawn (70 days) Winner of a Gold Medal in the 1934 All American Trials. This cross of Clark's Early with Marglobe has the shape and structure of Marglobe, but a brighter scarlet color and very prolific. Excellent shipping variety and also desirable for home growing.

Sioux (70 days) Developed at Nebraska Exp. Sta. from cross of All Red and Stokesdale. It is extra early, globe shaped, medium size, thick walled and juicy. Plant relatively open with finely divided leaves; ripens uniformly. Does well in hot dry seasons.

	Pkt.	Oz.	¼ Lb.	Lb.
Beef Steak10	\$1.00	\$3.00	...
Burpee's Hybrid Big Boy... ¼ oz.	\$.60	Oz.	\$35.00	...
Earliana10	.85	2.50	7.50
Early Giant Hybrid..... ¼ oz.	\$.60	Oz.	\$35.00	...
Garden State10	.85	2.50	7.50
Greater Baltimore (Ind.)..	.10	.40	1.25	4.00
Hybrid C 18x21..... ¼ oz.	\$.385	Oz.	\$12.50	...
Improved Advance10	1.00	3.50	10.00
Jubilee Golden10	1.50
Marglobe (Certified)10	.65	2.00	6.00
Oxheart10	1.50	4.50	...
Ponderosa10	1.00	3.50	10.00
Fritchard's Scarlet Topper	.10	.40	1.25	4.00
Queen's (Certified)15	.85	2.50	7.50
Rutgers (Certified)10	.65	2.00	6.00
Scarlet Dawn10	.50	1.50	5.00
Sioux10	1.00	2.85	8.50
Southland25	1.35	4.00	12.00
Stokesdale (Certified)10	.65	2.00	6.00
Stone (Improved)10	.50	1.50	4.50
Urbana25	2.00	6.00	20.00
Valiant10	.75	2.25	6.50
SMALL FRUITED				
Pear Shaped Yellow10	.60	1.75	...
Red Cherry10	.60	1.75	...
Red Plum10	.60	1.75	...
San Marzano (Paste) Red	.15	1.00	3.00	...
Yellow Plum10	.60	1.75	...



Marglobe Certified

Tomatoes

Stokesdale Certified (70 days) Similar to Rutgers in shape and color, with fruits averaging slightly larger. Plant is open in habit with medium heavy foliage. Recommended for home gardeners, canners and shippers. Produces large crops when fertilized liberally.

Valiant (70 days) One of the best early round, large, smooth varieties. Very profitable where it can be matured without too much danger of sunburn.

Marglobe Certified (75 days) Our stock of this popular variety is far superior to the average and we have received many unsolicited testimonials complimenting us on its excellent quality.

It produces heavy yields of large smooth, globular, meaty, red fruits. They have a delightful flavor, and are covered with a thick skin which hinders cracking. Moreover, the plants shade the fruits well and thus protect them from sun-scald.

Pritchard's Scarlet Topper (75 days) Introduced by the U. S. Dept. of Agr. All American Gold Medal award 1934. Extremely productive, especially on heavy soils; wilt resistant. Fruits large, firm, globe shaped and of fine quality.

Indiana Baltimore (80 days) Large, smooth, solid, bright scarlet; second

early Tomato; a very prolific bearer and fine canning variety.

Southland (80 days) Developed by the U. S. Regional Vegetable Breeding Laboratory as a main crop shipping, canning, home and market garden variety. Nearly globe shaped with thick solid flesh and good scarlet color. Outstandingly resistant to many diseases including some forms of late blight.

Garden State (80-85 days) A main crop canner's variety, developed by Campbell Soup Co., partially resistant to fusarium wilt and late blight. Somewhat similar to Rutgers in size and season with fruits slightly flatter and the vines more compact and upright. It ripens uniformly, scarlet red throughout, firm, thick walled, mild and of a very desirable quality.

Rutgers Certified (80 days) Developed under the direction of Prof. L. G. Schermernhorn of the New Jersey Agr. Experiment Station. The fruits begin ripening at the center, are highly colored throughout and have a thick wall structure with very small seed cavity. In comparison with Marglobe they are slightly more flattened at the stem end and will average much larger. Very prolific and desirable for canning, market or the home garden.

Improved Stone (85 days) One of the most productive of the large flat varieties; fruits bright scarlet, smooth and solid. Fine market or canners variety.



Pritchard's Scarlet Topper

Rutabagas

1 oz. to 150 feet of row; 1 lb. per acre.

Rutabagas require about four weeks longer to mature than ordinary varieties of turnips, but are more solid, of firmer flesh and therefore keep later into the spring. They are for this reason more desirable for storage, while turnips are better adapted for the early market. Sow during July either in drills or broadcast.

New Canadian (90-100 days, 5 in. dia.) Our strain of this excellent variety has become a favorite because of its hardy and productive nature. The flesh is sweet and solid, excellent for table use or stock feeding.

Special Market Gardeners (90-100 days, 5 in. dia.) Grown for a number of years in the North and held very closely by private individuals, the seed of this variety has always been extremely difficult to procure in a true and reliable type and most profitable. After years of searching and checking in our trial grounds, we have found the correct strain and offer it with every assurance that it is the best Rutabaga to grow in this section.

Turnips

1 oz. to 150 feet of row; 1 lb. per acre.

Being primarily a cool weather vegetable, turnips thrive best when planted in early spring or in the fall. For spring crop sow the seed early in April, while for fall and winter use, plantings should be made from July to August. Sow in rows not less than 18 inches apart and one-half to three-quarters of an inch deep. A very popular method, however, is to broadcast the seed between rows of corn or in the cultivated orchard.

Autumn King (75 days, 4½ in. to 6 in. dia.) A high quality stock feed variety, also very popular with Market Gardeners because of its excellent table quality when young. Roots smooth, globular, clear yellow with bronzy green tinged top, flesh pale yellowish white, fine grained, sweet and tender.



Turnip—Autumn King

Double Duty (30-40 days) Roots approximately 3 x 2 in. tops 18 in. tall, strap-leaved fast growing heavily set, practically aphid resistant and of excellent quality. Grown chiefly for its abundance of tops, surpassing Seven Top in production and quality. Also forms a pure white semi-globe root, which is sweet and tender.

Purple Top White Globe (55-60 days, 3 in. to 6 in. dia.) This excellent turnip is decidedly the most popular variety and more extensively grown than any other. The roots are globular, very handsome and of superior quality; either for table use or stock feeding purposes. It is a heavy producer, early, or rapid growth, and one of the best for winter storage.

Golden Ball (60-65 days, 3½ in. dia.) One of the best yellow varieties for general crop; flesh firm and sweet; splendid for table or stock.

Seven Top This variety planted exclusively for the green tops which are produced very abundantly. They are excellent for table use and for stock grazing.

Turnip Greens—See Broccoli—Page 11.



Purple Top White Globe Turnip

Let us quote larger quantities

	RUTABAGA	Prt.	Oz.	¼ Lb.	Lb.
Neckless Purple Top	.10	\$.15	\$.30	\$1.00	
New Canadian	.10	.30	1.00	2.85	
Special Market Gardeners	.10	.55	1.65	5.00	
Waltham (Yellow Globe)	.10	.30	1.00	3.50	
TURNIP					
Autumn King	.10	.15	.30	1.00	
Double Duty	.10	.15	.30	1.00	
Early Snowball	.10	.15	.30	1.00	
Golden Ball (Orange Jelly)	.10	.15	.30	1.00	
Mammoth Shogoin	.10	.15	.30	1.00	
Purple Top White Globe	.10	.15	.30	1.00	
Seven Top	.10	.15	.25	.75	
Yellow Aberdeen Purple					
Top	.10	.15	.30	1.00	

Manns Vegetable Plants, Roots, Trees and Berries

PLEASE NOTE: All plants are quoted f.o.b. Baltimore. On parcel post orders, add 25c per 100.

CABBAGE PLANTS, FROST-PROOF.

(Ready in February to May.)
75c per 100.

CAULIFLOWER PLANTS. (Ready in May.)
25c per doz.; \$1.50 per 100.

BORECOLE PLANTS. (Ready in July.)
\$1.25 per 100.

CELERY PLANTS. (Ready in July.)
\$1.50 per 100.

EGG PLANTS. (Ready in May.)
25c per dozen; \$1.25 per 100.

LETTUCE PLANTS. (Ready in March, April, September and October.) \$1.00 per 100.

PEPPER PLANTS. (Ready in May and June.)
25c per doz.; \$1.25 per 100.

SWEET POTATO PLANTS. (Ready in May and June.)
\$1.25 per 100.

TOMATO PLANTS. *Hotbed Grown.* (Ready in April.)
\$1.00 per 100.

Southern field-grown. \$1.00 per 100.

ASPARAGUS ROOTS

Mary Washington. From one to two years may be saved by planting Roots instead of seed. Choice, 2-year-old roots. 25 for 85c; \$2.75 per 100.

HORSERADISH ROOTS

Maliner Kren. (Bohemian.) Doz., 40c; 100 \$2.50.

RHUBARB ROOTS

Victoria. 20c each; \$2.00 per doz.



PLANT SETTER

No. 15—Automatic, positive and accurate operation, rigid construction, cadmium plated, no rust, removable water spout. \$8.50.

Lynchburg Setter \$5.65.



FRUIT TREES

APPLES. 5-6 ft. \$1.75 each; \$15.00 per 10. Delicious, Yellow Delicious, Double Red Delicious, Winesap, York, Red Rome, Grimes Golden, Jonathan, Yellow Transparent, Hyslop Crab, etc.

PEARS. 5-6 ft. \$2.15 each. - Bartlett, Kieffer, Seckel.

PEACHES. 5-6 ft. \$1.75 each. Belle of Georgia, Carman, Crawford's Early, Crawford's Late, Elberta, Heath Cling, J. H. Hale, Shippers Late.

CHERRIES. 9/16 to 11/16 cal. \$2.25 each.

SOUR—Early Richmond, English Morello, Montmorency. SWEET—Bing, Black Tartarian, Napoleon, Yellow Spanish.

PLUMS. 5 to 7 ft. \$2.50 each. Abundance, Burbank, Red June.

GRAPE VINES (2 yr. No. 1)

CONCORD. Blue. DELAWARE. Red. NIAGARA. White. 60c each, 10 for \$5.00.

SMALL FRUITS AND BERRIES

BLACKBERRIES. Alfred, Eldorado. 10, \$2.00; 100, \$10.00.

RASPBERRIES. Cumberland - black; Latham - red; St. Regis - red, everbearing; Indian Summer - red, everbearing. 10, \$3.00; 100, \$14.50.

BLUEBERRIES. 2 yr. 12-18 in. Burlington, Concord, Jersey, Rancocas, Rubel, \$1.25 ea.; 10, \$10.75.

BOYSENBERRIES. Thornless. 10, \$2.50; 100, \$10.00.

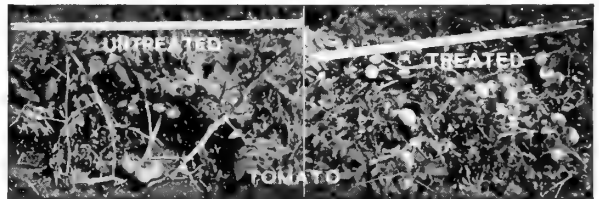

TRANSPLANTONE

For all plants and trees. No set-back from transplanting, insurance against replanting and an aid to earlier production. See page 77.

FRUITONE

The hormone spray for stopping premature drop of fruit, flowers and leaves. See page 77.

STRAWBERRY PLANTS

MARCH 1st to MAY 10th

We can supply fresh, strong, healthy plants of all the leading varieties in any quantity. Following is a partial list of the most popular sorts for planting in the vicinity of Baltimore.

Dorsett-Fairfax-Premier. Early.

Big Joe-Catskill. Midseason

Chesapeake. Late.

25 for \$1.25; 100 for \$3.00.

Everbearing-Streamliner. 25, \$2.00; 100, \$5.50.

BERRY BOXES

	100	
Pints	\$2.00	Let us
Quarts	1.75	quote
2 qt. Tills	5.00	quantity
3 qt. Tills	5.50	price.

(Not Mailable)



Manns' Superior Farm Seeds

Variety	Lbs. per Bu.	Sow—Lbs. per Acre	Date of Sowing	Fertilizer Requirements per Acre	Uses	NOTE: This chart compiled from Handbook of Agronomy—Va. P. I. and U. S. D. A. Cooperating.
Alfalfa	60	15-20	August or April	400 lbs. or more 4-12-4 at seeding. For sandy soils increase potash. Top dress with 0-14-6 every other year. Heavy user of lime.	Hay, soil improvement, pasture.	Inoculation important, sow broadcast on firm seed bed. Harvest when basal shoots are 2 in. high. Do not cut late in fall.
Barley	48	72-96	About Oct. 1st.	Lime moderately helpful. 300 to 400 lbs. 4-12-4 at seeding. Top dress in spring.	Stock feed, malt, breakfast foods, flour, early spring grazing.	Does best on well drained loam or clay soils. Seed should be treated against smut and the harvested crop protected from weevil.
Bent Grass	10 (3 lbs. per 1000 sq. ft.)	March or Sept.	Requires acid forming plant food. Injured by lime.	Lawns and putting greens or pasture on acid soils.	Does not yield as much hay as Red Top. Needs plenty of moisture. Thrives only on acid soils.
Blue Grass Kentucky	14 to 25	30-40	Late summer early spring	On pastures—300 lbs. superphosphate every spring for three years. Adding nitrogen for quick results. For new seedings, 400 lbs. 4-12-4. Lime helpful applied 50 lbs. per 1000 sq. ft. about every 5 years.	Permanent pastures, lawns and fairways.	Best results when seeded in mixtures as it requires about 3 years to establish a sod. Gives good early grazing, languishes in late summer but flourishes again in fall. Thrives best on well drained heavy soil, rich in organic matter and all fertilizing elements.
Blue Grass Canada	14 to 20	15 in mixtures	Late summer early spring	Same as Kentucky Blue but adapted to thinner soils.	Pasture with other perennial varieties.	Darker blue than Kentucky Blue, produces running rootstocks and forms dense sod. Leaves short. Best variety for stiff clay soils or poor fertility.
Buckwheat	48	36-60	May 15 to July 15	150 to 300 lbs. 2-12-6 heavy phosphorus and potash feeder. Best on moderately acid soil.	Flour, stock and poultry feed, bees, summer cover and green manure crop.	Likes cool, moist climate, a poor land crop. Harvest between time first seed fully formed and the time they mature.
Corn Field	56	14	May July	200 to 500 lbs. 3-12-6 in row at planting. Side dress when 40 days old with 200 lbs. nitrate of soda.	Grain, ensilage and hogging down.	Harvest when kernels well glazed and dented, shuck and bottom leaves dry and upper leaves $\frac{1}{4}$ to $\frac{1}{2}$ green. For ensilage harvest in early glaze stage, shucks yellow.
Clover Alsike	60	5-8	Aug.-Sept. Feb.-Apr.	200 to 400 lbs. 4-12-4 except if seeded on well fertilized grain, when no additional fertilizer is required. Responds readily to lime.	Hay, pasture, soil improvement.	Better on wet, poor or acid soils than any other clover. Inoculation helpful.
Clover Crimson	60	15	August	200 to 300 lbs. superphosphate. Responds to lime but not very sensitive to acid.	Green manure, and to some extent for hay and pasture winter annual.	Best suited to coastal plain soils but not to wet soils. Commonly sown at last working of corn or on small grain stubble. If not making sufficient growth, supply nitrogen fertilizer. Graze same if growth is too rank.
Clover Ladino	60	2	March April or August	200 to 400 lbs. 0-14-7.	Pasture and hay.	For pasture sow with orchard or alta fescue. Thrives 4 to 8 years.
Clover Red	60	10-15	March April or August	200 to 400 lbs. 4-12-4 $\frac{1}{2}$ to 1 ton hydrated lime is beneficial.	Primarily a forage crop. Largely used in hay mixtures but frequently sown by itself for hay.	For hay, cut when just past full bloom stage and handle to save as many leaves as possible. May be expected to yield 1 to 3 tons per acre.
Clover Sweet (Biennial)	60	10-15	March April	300 lbs. 0-12-5 or superphosphate. High lime requirement, not less than 1600 lbs. hydrated.	Pasture hay, soil improvement, honey plant, and in pasture mixtures.	Grows well on poor soil (except sands) provided lime and inoculation are supplied. Sow on grain in March or April and harrow in or sow on frozen ground.
Clover White Dutch	60	5-8	Spring or late summer	500 lbs. superphosphate once in 4 or 5 years as a top dressing. Some potash on sandy soil.	Pasture, furnishes early grazing.	Use about 2 lbs. per acre in pasture mixture. Tolerant to acid soils but responds to lime.
Cowpeas	60	1½ to 2 bu.	May 15th July 15	300 lbs. superphosphate and add potash for sandy soils. Lime not necessary but beneficial.	Black-eye, for human food; other varieties for hay, soil improvement and pasture.	Must be protected from weevil. Will grow on poor soils but does best on sandy loam. Harvest for hay when most of the pods are full grown and a few are ripe. Racks are a help in curing as it cures very slowly.
Fescue Chewings	14	30 (3 lbs. per 1000sq. ft.)	March April August Sept.	Complete plant food—abundant nitrogen. Lime not necessary.	Lawns principally; also as pasture.	Withstands more shade than most grasses, especially suited to sandy soils. Leaves bright green, creeps by underground stems
Fescue Meadow (English Blue-Grass)	24	20-30	March May August Sept.	300 lbs. 4-12-4.	Hay and pasture mixtures, gives early spring and late fall grazing.	Adapted to practically all but sandy soils. Does as well as any grass on wet soils. Harvest (Hay) as it comes into bloom. Yields of two tons per acre are not exceptional.
Lespedeza Korean Annual	25	25-30	February May	200 to 300 lbs. superphosphate; for sandy soils use 0-14-6. Lime not necessary but responds readily.	Hay, pasture and soil improvement.	For hay sow on fertile moist land. If second growth is allowed to go to seed, Korean will reseed itself.

Variety	Lbs. per Bu.	Sow—Lbs. per Acre	Date of Sowing	Fertilizer Requirements per Acre	Uses	
Millet Golden	50	25-30	May to July	Fertilizer not usually profitable. Responds to 200 lbs. superphosphate or 0-14-6. Lime unnecessary.	Mainly as a "catch" hay crop.	Requires at least 60 days from seeding to maturity. Sow broadcast and cover lightly. Cut hay just after blooming. Has about same feeding value as timothy but not as becoming injurious if used as a continuous ration for horses.
Oats Winter Spring	32	2 to 2½ bu.	Winter Sept. 15 Spring Feb.-Mar.	200 to 400 lbs. 4-12-4 at seeding. Top-dress as growth begins in spring where straw is likely to be too short.	Chiefly as grain for horses and other live stock; cut for hay and also used for human food.	Well drained moderately rich soil is best. Harvest grain in hard dough stage; for hay cut in early milk stage. Fall sown oats mature 2 to 3 weeks earlier than spring oats.
Orchard Grass	14	14 to 25	March to May August to October	200 to 400 lbs. 4-12-4 for fall application or 6-8-6 for spring application.	Hay and pasture.	Long-lived deep rooted perennial bunch grass. Does best on heavy soils such as clays and clay loams. Cut in bloom stage, as it quickly becomes woody after blooming. Serves best when sown in mixtures with red clover, alsike, tall meadow oat grass.
Rape Dwarf Essex	56	6-10	Mar.-Apr. Aug.-Sept.	Heavy feeder and responds to manure and fertilizer. Requires lime for best results.	Pasture for hogs and sheep.	Thrives on rich, moist loamy soil.
Red Top Grass	32	5-10	August-Sept.	Seems to do better on "Sour" soils.	Hay and pasture.	A perennial grass with a creeping habit of growth making a coarse loose turf. For hay harvest a little before or during full bloom. Suited to wet soils.
Rye	56	1 to 1½ bu.	August-November	At seeding 200 to 400 lbs. 4-12-4. Top dress in spring when growth begins. Not necessary but helps some.	Grain, winter and spring pasture, soiling and as cover crop. (Usually with winter vetch.)	Does better than wheat, on poor soils. Suitable to any well drained soil.
Rye Grass Domestic Italian	24	30-40	Early Fall	Usual Grass requirements.	Annual hay crop, temporary pasture or in lawns for a quick covering.	Not an annual but little of it lives more than one year. Grows rapidly and in bunches. Fall seeding usually makes a good crop of hay by June. More drought resistant than Perennial Rye Grass.
Rye Grass Perennial	20	30	Feb.-May Aug.-Oct.	Complete plant food.	Very similar to above.	More persistent than Domestic Rye Grass.
Sorghum	50	Drill 8-10 Broadcast 60-75	May-July	150 to 400 lbs. 4-12-4 at planting, top dress (or side dress if in rows) with 100 to 200 lbs. nitrogen fertilizer when 40 days old.	Syrup, fodder, hay, soiling and silage.	Any well drained corn or wheat land is suitable. Is heavy feeder and hard on land. For syrup or silage cut when seeds are in hard dough stage. When pastured or fed green there is danger of poisoning to live stock.
Soy Beans	60	Drilled 45-60 Broadcast 60-90	May 15th to July 15th	200-300 lbs. superphosphate or 0-14-6 fertilizer. Lime not necessary, but helps especially on heavy soils.	Hay, green manure, hogging off silage and seed.	Responds well to inoculation. Plant very shallow (about 1 in.) and if crust forms on land before they come up, break it with a harrow. For hay, cut when lower leaves begin to turn yellow and pods about half filled.
Sudan Grass	35	15-30	May July	200 to 300 lbs. superphosphate.	Catch hay crop, soiling, silage and grazing.	Does well on any soil except those that are cold and wet, good with cowpeas or soybeans. Cut hay just after it is beginning to head. Drought resistant and produces well in dry seasons.
Fall Meadow Oat Grass	11	30-40	Mar.-Apr. Aug.-Sept.	Responds to soil improvement and fertilizer.	Hay and pasture, of most value in a mixture of Red Clover, Alsike and Orchard Grass.	One of the best poor land grasses and especially adapted to well drained sandy soil. Does not like shade. Very drought resistant, perennial bunch type variety. Cut for hay about the time of blooming.
Timothy	45	Mar.-Apr. Aug.-Oct.	200-400 lbs. 4-12-4 except where it follows a well fertilized grain crop. Lime helps and should always be applied when clover is sown with timothy. If land is poor top dress with 100 lbs. each nitrogen fertilizer and superphosphate when spring growth begins.	Primarily for hay. Does not stand grazing well.	Semi-bunch growth. Adapted to heavy soils such as clays and loams. Usually seeded in mixture with spring clover, or with wheat in the fall and the clover on the wheat in spring. Cut hay when in full bloom or slightly after.
Vetch Winter	60	20-40 with 1 bu. Rye	Aug.-Oct.	200-400 lbs. superphosphate, add potash on sandy soils. Responds to lime but will grow on fairly acid soil.	Hay, pasture and soil improvement.	Best annual winter legume cover crop. Adapted to most any well drained soil. Inoculation necessary.
Wheat	60	1 to 1½ bu.	Oct.	200-400 lbs. 4-12-4 at seeding, additional superphosphate on better soils. Top dress in spring where straw is likely to be too short. Responds to use of lime in rotation.	Human food, hay or cover crop.	Does best on heavy loams of good fertility. Seed should be treated. Harvest when stalk is brown and grain in dough stage.

FIELD SEED PRICES

These quotations are based on market at time catalog goes to press and will be maintained as far into the season as possible. Buyers of large quantities are requested to write for firm prices stating quantities, as market fluctuations may permit lower prices. Mail orders will be filled at prices prevailing date order is received and any overpayment will be refunded. We are offering only strong germinating, new crop seed, with as low weed content as economically possible. Prices quoted cash, f.o.b. Baltimore, bags included on full bag lots; bags charged extra on smaller quantities.

Prices F.O.B. Baltimore	(1-9 lbs.)	(10-20 lbs.)	(21-99 lbs.)	Bag Lots
	Per lb.	Per lb.	Per lb.	Per lb.
Alfalfa: Kansas Verified	\$.55	\$.50	\$.46	\$.42
Cert. Atlantic95	.85	.75	.68
Blue Grass: Kentucky	1.00	.85	.77	.70
Merion	6.00	5.00	—	—
Clovers: Alsike55	.50	.47	.43
Crimson35	.30	.26	.24
Ladino	1.35	1.20	1.10	.98
Red (Midwest ver.)58	.53	.48	.44
White Dutch	1.00	.85	.75	.65
Wild White	1.25	1.10	.98	.89
Fescues: Alta45	.40	.36	.33
Chewings	1.00	.90	.80	.70
Creeping Red90	.80	.70	.60
Meadow (English Blue Grass)30	.26	.23	.20
Lespedeza: Korean36	.33	.30	.27
Oats: Spring (Clinton Cert.)	1-9 bu. @ \$2.25	10 bu. @ \$2.15		
Orchard Grass35	.32	.29	.26
Red Top Grass75	.68	.62	.57
Rye Grass: Italian - Domestic20	.18	.15	.12
Perennial35	.29	.23	.17
Sorghum: Amber28	.25	.22	.20
Milo15	.13	.11	.09
Tall Meadow Oat Grass40	.36	.33	.30
Timothy28	.26	.24	.21

MANNS' PERMANENT PASTURE MIXTURE

\$15.75 Per Acre

10 VARIETY SPECIAL (UPLAND)

Contains re-cleaned seed of high vitality in ten nutritious varieties properly proportioned to give continuous pasture from early spring until late fall, quickly becoming permanently established. Sow 30 lbs. per acre. (Low Lands—sow 25 lbs. plus 5 lbs. Red Top per acre.) **Lb., 57c; 100 lbs., \$52.50.**



Cyclone illustrated \$4.10

MANNS' SUPERIOR FLOWER SEEDS



Flower Seeds for Particular Purposes

BORDER AND EDGING

- Ageratum
- x Alyssum, Saxatile
- x Arabis, Alpina
- x Bellis Perennis
- Calendula
- x Campanula, Carpatica
- Candytuft
- Centaurea
- x Cerastium
- x Dianthus, Barbatus
- x Iberis, Sempervirens
- Lobelia
- Nasturtiums
- Marigold
- x Nierembergia
- Pansy
- x Papaver, Nudicaule
- Petunia
- x Phlox, Subulata
- Portulaca
- x Sedum

FRAGRANCE

- Ageratum
- Alyssum, Sweet
- Antirrhinum
- Candytuft
- Centaurea
- x Dianthus
- Heliotrope
- x Iris
- Mignonette
- Nasturtium
- Nicotiana
- Pansy
- Petunia
- Scabiosa
- Stock
- Stock, Virginian
- Sweet Peas
- Verbena

x Perennial Varieties.

EVERLASTINGS

- Globe Amaranth
- Helichrysum
- Linaria
- Statice

PARTIAL SHADE

- Alyssum, Sweet
- x Anchusa Italica
- x Anemone
- Antirrhinum
- x Aster, Hardy
- x Candytuft, Iberis
- Centaurea
- China-Aster
- Clarkia
- x Foxglove or Digitalis
- x Hibiscus, Moschata
- x Lathyrus
- Lupinus
- Myosotis, Forget-me-not
- Nicotiana
- Pansy
- Petunia
- x Primula, English Cowslip
- x Rudbeckia
- Schizanthus
- x Violas

MOIST PLACES

- x Heliotrope
- Mimulus
- x Viola
- x Wallflower

ROCK GARDENS

See Annuals and Perennials
Marked *

DRY PLACES

- x Aster
- California Poppy
- x Coreopsis
- x Dianthus
- Dimorphothea
- x Gypsophila, Paniculata
- x Helianthus
- x Iris
- Mesembryanthemum
- Mimosa
- x Papaver, Nudicaule
- Phlox, Annual
- x Phlox, Hardy
- x Statice, Latifolium

CUT FLOWERS

- Ageratum
- Arctotis
- Asters
- Babysbreath
- Calendula
- Cornflower
- Cosmos
- Dianthus
- Gaillardia
- Larkspur
- Marigold, African
- Mignonette
- Nasturtium
- Nigella
- Phlox, Drummondii
- Salpiglossis
- Scabiosa
- Snapdragon
- Stocks
- Strawflower
- Xeranthemum
- Zinnia

TALL VARIETIES

- Amaranthus, Caudatus
- x Campanula, Pyramidalis
- x Coreopsis
- Cosmos
- x Dahlia
- x Digitalis
- x Hollyhock
- Marigold, African
- Nicotiana
- Ricinus

WINDOW BOXES

- Ageratum
- Alyssum
- Begonia
- Centaurea
- Lobelia
- Nasturtium
- Pansy
- Petunia
- Phlox
- Portulaca
- Salvia Splendens
- Thunbergia
- Vinca
- Zinnia, Lilliput

POOR SOIL

- Alyssum, Sweet
- Amaranthus
- Balsam
- California Poppy
- Calliopsis
- Cornflower
- Four-O'Clock
- Marigold
- Nasturtium
- Poppy
- Portulaca

Annual Flower Seeds

The ease of cultivation and the quickly effective results obtained from Annuals make them indispensable, as they are adaptable to an almost endless variety of arrangement.

Even in perennial borders, beds and rock gardens, annuals are very essential to bridge the span between periods of bloom of the perennials and to give desired color effects which are possible only with annuals. Many varieties can be started indoors early and transplanted giving continuous bloom from early summer until frost. Some sorts are very easily grown in late summer to produce plants for the sun-parlor or conservatory where they will blossom during the winter.

For very vigorous young plants in early spring the following may be sown outdoors in November: *Ageratum*, *Alyssum*, *Baby's Breath*, *Calendula*, *Calliopsis*, *Candytuft*, *Clarkia*, *Cornflower*, *Cosmos*, *Cynoglossum*, *Dianthus*, *Larkspur*, *Nigelia*, *Shirley Poppies*, *Snapdragons* and *Sweet Peas*.

Annuals bloom more profusely than biennials or perennials, but it is advisable to cut the flowers before going to seed so that the plants continue to bloom freely.

For Variety, Color, Fragrance, Economy Sow Annuals

AGERATUM

Splendid for bedding or pot culture, covered from June until frost with a mass of very attractive flowers of a tufted appearance. Very effective when contrasted with geraniums. **Large-flowered Mixed.** Height 1½ feet. **Pkt., 10c; ½ oz., \$1.00.** **Dwarf Mixed.** Height 6-8 inches. **Pkt., 10c; ¼ oz., \$2.00.**

DWARF COMPACTUM MIDGET BLUE. Rich blue. **Pkt., 15c; ½ oz., \$1.25.**

DWARF COMPACTUM PURPLE PERFECTION. Deepest blue. **Pkt., 15c; ¼ oz., \$1.00.**

SEMI-DWARF BLUE PERFECTION. Medium blue. **Pkt., 15c; ¼ oz., \$1.00.**

ALYSSUM

LITTLE GEM. Very popular border flower, coming into bloom six weeks after sowing seed and requiring the least attention of all flowers. Very erect and dwarf, its white flowers greatly enhancing the beauty of any bed or border. Height 4 inches. **Pkt., 10c; oz., \$1.50.**

ROYAL CARPET. Purple, 2 to 3 in. tall but spreading to 10 in. wide. **Pkt., 25c; ½ oz., \$1.75.**



Crego Aster

Varieties marked * suitable for Rock Gardens.

POTTED PLANTS

The following varieties are usually available at our store after May 10th. Regret we cannot mail, deliver or ship potted plants.

<i>Ageratum</i>	<i>Pansy</i>
<i>Alyssum</i>	<i>Petunia</i>
<i>Aster</i>	<i>Phlox</i>
<i>Calendula</i>	<i>Scarlet Sage</i>
<i>Cannas</i>	<i>Snapdragon</i>
<i>Coleus</i>	<i>Stock</i>
<i>Coreopsis</i>	<i>Summer Poinsettia</i>
<i>Dianthus</i>	<i>Verbena</i>
<i>Geranium</i>	<i>Vinca</i>
<i>Heliotrope</i>	<i>Wallflower</i>
<i>Lantana</i>	<i>Zinnia</i>
<i>Lobelia</i>	

Chrysanthemums—See page 52

ANNUAL FLOWER GARDEN MIXTURE (2 to 3 ft. tall). **Pkt. 15c, Oz. 65c, Lb. \$6.50.**

PROCUMBENS SNOW-CLOTH. Compact mass of pure white flowers. 3-4 inches high by 8 inches wide. **Pkt., 15c; oz., 75c.**

VIOLET QUEEN. Dwarf compact free flowering rich violet; does not fade in hot weather. Height 4 inches. **Pkt., 15c; ¼ oz., 60c.**

ANTIRRHINUM OR SNAPDRAGON

(Rustproof)

This border and bedding plant of long blooming season is one of the best perennials suitable for flowering as an annual. Very desirable for cutting as the blooms are borne well above the dark glossy leaves and keep fresh for a long time.

MAXIMUM. (Tall florist varieties.) Crimson, White, Yellow, Pink. **Pkt., 25c; ¼ oz., \$1.15.**

TALL MIXED. 2½ to 4 ft. **Pkt., 10c; ¼ oz., \$1.00.**

TETRAPLOID MIXED. 2½ to 4 ft. Commercial florist strain. Vigorous grower. Florets huge, mostly ruffled, twelve inch flower spikes are usual. Full range of colors, majority of flowers richly veined. **Pkt., 10c; ¼ oz., \$1.70.**

SEMI-DWARFED MIXED. 1 to 1½ ft. **Pkt., 10c; ¼ oz., \$1.00.**

ASTERS (Wilt Resistant)

Very popular because of their beauty and ease of culture. The varieties listed represent the finest Asters of the early, midseason and late types and will give a profusion of bloom from July to late October. Asters require good rich soil and during the growing period should be well supplied with water.

PRINCESS. Flowers 3 in. in dia. Deeply quilled cushion centers; branching habit, ideal for bedding and cut flowers.

Mixed, Pkt., 15c; ¼ oz., \$1.30.

AMERICAN BRANCHING. A handsome and very distinct variety resembling Japanese *Chrysanthemums*. The plants grow 2 feet in height and width and the large full petaled blossoms are borne on long stems or branches. Comes into flower in July or early August.

Mixed, pkt., 10c; ¼ oz., 50c.

CREGO. Flowers of immense size, 4 to 5 inches in diameter with very long stems during late summer and fall. Plants are of strong branching growth, 2 to 2½ feet high. Separate colors, **Pkt., 10c; ¼ oz., 60c.**

Mixed, Pkt., 10c; ¼ oz., 50c.

CALIFORNIA SUNSHINE. Flowers measure 4 to 5 inches in diameter, are half double and exhibit all the grace and beauty of the single Aster. The golden yellow ground tone of the quilled petals contrasts wonderfully with the outer petals. Fine for cutting midseason, height 3 ft. **Mixed, Pkt., 10c; ¼ oz., 60c.**



Centaurea

AMARANTHUS

Very useful in borders among shrubs, or in centers of large beds. Thrives best in a warm, sunny location and a soil that is not too rich but contains an ample supply of lime. Blooms June to frost.

CAUDATUS. (Love Lies Bleeding.) Plants of erect growth 2½ feet high producing numerous feathery sprays of rich crimson color. Pkt., 10c; ¼ oz., 25c.

MOLTEN FIRE. Very ornamental and beautiful; 3 feet tall; easily grown, leaves dark bronze, top of plant brilliant Poinsettia red. Pkt., 15c; ¼ oz., 80c.

ARCTOTIS (Blue-Eyed African Daisy)

GRANDIS. White petals tinged lilac with centers steel blue. A splendid and easily grown flower, 2 feet tall. Good for cutting, June to October. Pkt., 10c; ¼ oz., 50c.

ANCHUSA (Summer Forget-Me-Not)

BLUE BIRD. Vivid indigo blue, plants compact and of even growth. 18 in. Blooms throughout the summer. Pkt., 15c; ½ oz., 80c.

BALSAM OR LADY SLIPPER

Quick growing annual, producing numerous flowers resembling tiny roses. Blooms throughout the summer and early fall. An old favorite for beds and borders. 2 feet. Splendid double mixed, pkt., 10c; ¼ oz., 40c.

BARTONIA (Golden Yellow)

AUREA. Large, showy flowers, 3 inches in diameter; deep golden yellow. Blooms early, 18 inches. Pkt., 15c; oz., \$1.00.

CANDYTUFT

Hardy annual clusters of small flowers, beautiful and useful for beds, borders, rock gardens and cutting. Height 12 inches. Blooms May to July.

FINEST HYBRID MIXTURE OF ALL COLORS. Pkt., 10c; oz., 60c.

CALENDULA—POT MARIGOLD

Effective in beds or potted; showy, free-flowering, hardy annuals. Blooms continuously from June until frost. 15 to 24 inches.

EXTRA DOUBLE ORANGE KING. Rich orange red. Pkt., 10c; ½ oz., 50c.

FINEST MIXED. Pkt., 10c; oz., 60c.

BALL'S, IMPROVED GOLDEN ORANGE. Long stemmed extra double, excellent for forcing. Pkt., 15c; ¼ oz., 30c.

LEMON QUEEN. Light golden-yellow flowers, light center, showy for bedding and borders. Pkt., 10c; ¼ oz., 50c.

ORANGE SEAGGY. Very distinct type having long narrow fringed petals. Flowers 3 in. across. Somewhat resembling rich deep orange Chrysanthemums, long stems, grows 18 in. high. Pkt., 10c; ½ oz., 50c.

RADIO. Medium sized, clear orange, closely set petals, attractively quilled. Pkt., 10c; ½ oz., 50c.

CAMPANULA—CANTERBURY BELLS

An old-fashioned favorite, stately, showy, and easily grown. Bell-shaped flowers on long upright stems. Plants form perfect pyramids about 2 ft. high and bloom in early summer. Mixed, Pkt., 10c; ¼ oz., 80c.

CARNATION (Marguerite)

Easily grown as an Annual producing large double blooms 4 or 5 months after sowing seed. Very fragrant. (See Perennials.)

CELOSIA OR COCKSCOMB

Excellent for cutting. Blooms June to frost.

PLUMOSA. Feathered varieties, fiery red, scarlet-carmine, yellow or mixed, height 2 to 3 ft. Pkt., 15c; ¼ oz., 60c.

DWARF EMPRESS COCKSCOMB. Dark-leaved, bright crimson. Height 10 in. Pkt., 15c; ¼ oz., 75c.

TALL EMPRESS COCKSCOMB MIXED. Height 1½ ft. Pkt., 15c; ¼ oz., 50c.

CHILDSIL. (Chinese Woolflower.) Crimson. Height 2½-3 ft. Pkt., 15c; ¼ oz., 50c.

CENTAUREA

CENTAUREA CYANUS; BACHELOR'S BUTTON OR CORN FLOWER. Charming old-fashioned flowers. Free flowering habit, reseeding itself year after year. Useful as a cut flower, as well as a garden decoration. Double mixed. Height 2-2½ ft. Blooms from mid-summer until frost. Pkt., 10c; oz., 60c.

CENTAUREA MOSCHATA OR SWEET SULTAN. Beautiful, sweet scented flowers borne on long stems, when cut will last for several days. Height 2½-3 ft. Mixed, Pkt., 10c; ¼ oz., 40c.

CORNFLOWER, JUBILEE GEM—Dwarf plants, 1 foot, freely blooming, vivid blue. Pkt., 10c; ¼ oz., 50c.



Calendula

Varieties marked * suitable for Rock Gardens.



Arctotis



Didiscus



Dianthus

CHRYSANTHEMUM

The annual Chrysanthemums are free-blooming, easily grown plants, having large flowers in a variety of brilliant colors, fine for cutting. Height 2 ft. Blooms from summer until frost.

Single, Mixed. Pkt., 10c; ¼ oz., 25c.

CLARKIA

Very pretty, profuse flowering annuals. Useful for hanging baskets. Height 2 ft. Blooms June until frost.

Double mixed. Pkt., 10c; ¼ oz., 35c.

CALLIOPSIS

Showy plants with numerous flowers, excellent for bouquets. Thrive well in any soil. Height 2-3 ft. Blooms all summer. Pkt., 10c; ¼ oz., 30c.

COSMOS

One of the most satisfactory hard annuals, flowering in late summer. Fine for cutting and easily grown. Can be sown anywhere and transplanted.

EARLY KLONDIKE ORANGE FLARE. Bright vivid orange, very free flowering. 2-3 ft. Pkt., 10c; ¼ oz., 25c.

FIESTA. Semi double flowers, ruffled, 2½ ft. plants, blooms all summer. Red, orange, yellow, suffusion of color. Pkt., 25c; ¼ oz., \$2.00.

RADIANCE. All American Winner 1948. A striking new color combination never before seen in Sensation Cosmos. Deep rose petals overlaid with large well-defined zone of rich crimson. Pkt., 15c; ¼ oz., 40c.

SENSATION. Extremely early free blooming, flowers 4 to 5 inches, plants 4 ft. with rather heavy foliage. White, Pink and Mixed. Pkt., 15c; ¼ oz., 35c.

DOUBLE EARLY FLOWERING MIXED. Blooms 3 in. Height 4 ft. Pkt., 10c; ¼ oz., \$1.00.

CYNOGLOSSUM

(Chinese forget-me-not)

AMABLE. Dwarf sweet scented, blue.

Pkt., 10c; ¼ oz., 25c.

DIANTHUS OR PINKS

These very beautiful and popular biennials flower freely the first year from seed, and in most locations they are quite hardy and produce larger flowers the second year.

TETRAPLOID HEDDENSI. Large long stemmed hybrids, very large double flowers. Plants 10-12 inches. Pkt., 10c; ¼ oz., 50c.

HEDDEWIGI LACINIATUS SINGLE GAUITY MIXED. 10 to 12 in. Large lacy flowers in a brilliant range of colors. Pkt., 15c; ¼ oz., 50c.

DIDISCUS—Blue Lace Flower

COERULEUS. Lavender, blue, lace-like flower; heads blooming profusely from June to September; 1½ feet tall. Pkt., 10c; ½ oz., \$1.00.

DIMORPHOTHECA

***AUBANTIACA (African Daisy).** Very showy flowers for bed or border. Orange-gold daisy-like blooms on long stems. Bushy plants 12-15 inches tall. Bloom until frost. Pkt., 10c; ¼ oz., 90c.

EUPHORBIA

VARIEGATA (Snow on the Mountain). Bright green foliage veined and margined with white, top leaves snow white. Height 2 ft. Pkt., 10c; ½ oz., 60c.

GILIA

Exceedingly graceful and attractive, with azure blue starlike flowers, borne profusely on plants 3 ft. tall; a good cut flower. Blooms from July until frost. Tall mixed. Pkt., 15c; ¼ oz., 35c.

GLOBE AMARANTH-GOMPHRENA

One of the best "Straw flowers." Perfect globe shape. Fine for borders and cutting. Height 2 ft. Blooms mid-summer until frost. Mixed colors. Pkt., 10c; ¼ oz., 30c.



Cosmos Radiance

Varieties marked * suitable for Rock Gardens.



Dimorphotheca



Larkspur



Gilla

GODETIA (Satin Flower)

DOUBLE-DWARF MIXED. Azalea flowered. Plants grow 1 foot high, and bloom from June to August. Flowers 3-4 inches across. Excellent for cutting and easily grown. Pkt., 10c; ¼ oz., 70c.

GYPSOPHILA (Baby's Breath)

Graceful plants with light fairy-like growth. A quick growing annual with myriads of small open bell-shaped single flowers, excellent for their delicate effect in bouquets. Height 2 ft. Pkt., 10c; oz., 50c.

HELIANTHUS

CHRYSANTHEMUM FLOWERED. Golden yellow double blooms 6 to 8 inches across. Used as backgrounds or screens on account of their stately growth. Thrives in almost any soil exposed to the sun, blooms until frost. Height 6-7 ft. Pkt., 10c; ¼ oz., 25c.

HELICHRYSUM (Everlasting Flower)

MONSTROSUM. The center of the double pompon-like flower is nearly covered by the still overlapping petals. Height 2 ft. Blooms from June to November. Mixed, Pkt., 10c; oz., \$1.00.

HOLLYHOCK

SINGLE ANNUAL FINEST MIXED. Pkt. 10c; ¼ oz., 35c.

KOCHIA—SUMMER CYPRESS

Quick growing hedge plant. Very symmetrical and attractive, the bushes taking on a distinctive red tinge late in the summer; for this reason often called Mexican Fire Bush. Height 2-3 ft. Pkt., 10c; ¼ oz., 25c.

LARKSPUR

For Perennial Larkspur see Delphinium.

One of the best known of garden flowers and if planted in April will produce flowering plants by the first of July and continue to bloom until frost.

GIANT IMPERIAL DOUBLE. Height 3-4 ft. White, Carmine Rose, Blue, Pink, or Mixed. Pkt., 10c; ¼ oz., 35c; 1 oz., \$1.10; ¼ lb., \$3.50; 1 lb., \$10.00.

REGAL. Tremendously long thick spikes, full Delphinium-like florets, compact, basal branching habit; vigorous and early. Height 3-4 ft. Dark blue, Rose, White or Mixed. Pkt., 15c; ½ oz., 60c; oz., \$1.15.

ROSAMOND. Tall double stock flowered, early, free flowering, pure deep pink. Height 3-4 ft. Pkt., 15c; ¼ oz., 50c.

LANTANA

DWARF HYBRIDS MIXED. Pkt., 10c; ¼ oz., 60c.

LOBELIA

CRYSTAL PALACE COMPACTA. Desirable for edgings, bedding and pot culture. Dark blue flowers, dark foliage throughout the summer. Height 4 inches. Pkt., 10c; ½ oz., 85c.

CAMBRIDGE BLUE COMPACTA. Light blue, large flowered, green foliage. Pkt., 15c; ½ oz., 60c.

LUPINUS

Free-flowering, easily grown annuals with long graceful spikes of richly colored pea-shaped flowers. During July and August. Prefers a little shade, acid soil and cool weather.

HARTWEGII GIANT KING MIXED. Height 2-3 ft. Pkt., 10c; ¼ oz., 35c.

MARIGOLD

French Marigolds are smaller than the African but are marked and spotted with varied shades of red and orange. The African is very large, double and in solid colors. Excellent for cutting. Blooms July to frost.

AFRICAN (TALL) VARIETIES

AFRICAN. Mixed. Double. Pkt., 10c; ¼ oz., 45c.

MAMMOTH MUM. Large double fluffy light sulphur-yellow flowers resembling Chrysanthemums. Plants bushy, erect and strong. Height 3 ft. Pkt., 15c; ¼ oz., 50c.

GLITTERS. Large, tall, clear yellow. Double Chrysanthemum flowered. Pkt., 25c; ¼ oz., 90c.

GUINEA GOLD. Orange flushed with gold, flowers semi-double. Height 2 to 2½ feet. Pkt., 10c; ¼ oz., 25c

CROWN OF GOLD. Collarette type, rich golden yellow, chrysanthemum formed, fragrant, double. 2½-inch blooms. Height 2 ft. Pkt., 10c; ¼ oz., 35c.

SUNSET GIANTS. Largest known Marigolds, measuring 5 inches or more, ranging in color from deep orange to lemon-yellow, and a new delightful shade of primrose. Fragrant. Height 3-4 ft.; Pkt., 10c; ¼ oz., 40c.

FRENCH (DWARF) VARIETIES

BUTTERBALL. Extra dwarf double, soft butter yellow. Height 6 to 8 in. Pkt., 15c; ¼ oz., 45c.

FLASH. Extra early, free flowering, single orange-red profuse blooms. Height 1½ ft. Pkt., 10c; ¼ oz., 30c.

FRENCH. Dwarf double mixed. Height 1 ft. Pkt., 10c; ¼ oz., 40c.

MELODY. Dwarf French double, solid bright orange. Height 1 ft., Pkt., 15c ¼ oz., 40c.

MARVEL OF PERU—FOUR O'CLOCK

Large showy fragrant flowers, blooming the entire season. Succeed well in any ordinary garden soil in a sunny location. Height 2 ft. Mixed, Pkt., 10c; oz., 50c.

MIGNONETTE

Well known fragrant bedding or potting plant. Sowings made in April and again in July will result in a succession of bloom from early summer until frost.

MACHET GIANT MIXED. Large spikes, very fragrant. Height 12-15 inches. Pkt., 15c; ¼ oz., 40c.

MATHIOLA (Evening Scented Stock)

BICORNIS. Lilac, 2 ft. Pkt., 10c; ¼ oz., 25c.



Lobelia



Lupins



Nigella

NASTURTIUM

Popular plants of the easiest culture. Will bloom most prolifically if given a rather poor soil and an open sunny location. Fine for edgings, beds or borders. Blooms June to frost.

DWARF MIXED. Very brilliant in all shades of yellow, red and purple. Height 9 in. Pkt., 10c; oz., 25c; ¼ lb., 75c.

DOUBLE GLEAM HYBRIDS. Large well-formed, sweet-scented double flowers in an extremely wide range of colors. Height 15 in. Golden, Scarlet or Mixed. Pkt., 10c; oz., 25c; lb., \$3.00.

TALL TRAILING—CHOICE MIXED. Height 10 ft. Pkt., 15c; oz., 25c; ¼ lb., 75c.

NICOTIANA

AFFINIS. Gives a continuous display of very fragrant flowers through the summer and autumn. Height 2-3 ft. Mixed. Pkt., 10c; ¼ oz., 30c.

NIGELLA OR LOVE-IN-A-MIST

Free-flowering plant, producing curious flowers surrounded by the finely cut foliage. Easily grown; useful for cutting. Height 1½ ft.

DOUBLE BLUE. Pkt., 10c; ¼ oz., 25c.

ORNAMENTAL GRASS

Vigorous plants, grown for their gray ornamental seeds which when dried are used for beads. Height 2-3 ft.

COIX LACRYMA. (Job's Tears.) Pkt., 15c; oz., 75c.



Nasturtium

PANSIES

May be sown in April or May for summer flowering or in August for early spring blooming. They thrive best in an open exposure, with protection during the winter. For summer flowers however partial shade will greatly prolong the blooming season. Height 8 in.

MAMMOTH EXHIBITION MIXTURE. True round and solid pansy form of giant size, each color an attraction. Pkt., 10c; ¼ oz., \$1.00; oz., \$6.00.

SWISS GIANTS. Mixed reselected Florist strain. In a fine range of colors. Pkt., 15c; ¼ oz., \$1.00; oz., \$6.00.

TRIUMPH OF THE GIANTS. (Fringed.) Finest for commercial use. Blooms enormous, most striking in brilliancy and color. Pkt., 10c; ¼ oz., \$1.00; oz., \$6.00.

SWISS GIANT ALPENGLOW. Rich garnet and ruby red shades with dark blotches. Pkt., 25c; ¼ oz., \$2.00.

SWISS GIANT CORONATION GOLD. Large golden yellow, without blotches or marking. Pkt., 25c; ¼ oz., \$2.00.

SWISS GIANT ULLSWATER. Marine blue with darker blue blotches showing through. Pkt., 25c; ¼ oz., \$2.00.

SWISS GIANT. White. Pkt., 25c; ¼ oz., \$2.00.

PETUNIAS

Of easy culture. For beds, borders, window boxes or hanging baskets.

GIANTS OF CALIFORNIA. Huge blooms in light and dark colors, fringed and ruffled, with attractive deep throats. Height 12 in. Mixed. Pkt., 10c; 1/16 oz., \$7.50.

BALLERINA. Deep pink, fringed grandiflora. Pkt., 25c.

HOWARD'S STAR. Rose-crimson with a five-pointed white star. Height 18 in. Pkt., 10c; ¼ oz., \$1.70.

DWARF BEDDING VARIETIES (Height 12 in.)

BLUE BEDDER. Mid-blue. **ROSY MORN.** Pink white throat.
ROSE OF HEAVEN. Deep brilliant rose. **SNOW QUEEN.** Large white.

Separate colors or Mixed. Pkt., 15c; ¼ oz., \$1.70.

DWARF ELK'S PRIDE. Deep Purple. Pkt., 25c; 1/16 oz., \$7.50.

FIRE CHIEF. All American, brilliant red. Pkt., 25c; ¼ oz., \$3.25.

FLAMING VELVET—Rich, brilliant, velvety crimson. hybrida type. Height 18 in. Pkt., 10c; ¼ oz., \$1.70.

BALCONY PETUNIAS

HYBRIDA PENDULA. For porch and window boxes, also excellent for bedding in solid masses of one or more colors. Large blooms produced in abundance. Height 18 in. Mixed. Pkt., 10c; ¼ oz., \$1.70.



Stocks



Schizanthus



Salpiglossis

PHLOX

Phlox makes a magnificent show in beds and masses where their brilliant and varied colors produce a gorgeous effect. Very easily raised and afford a bright display of flowers all through the summer.

***DRUMMONDII.** Choice mixture, first quality. Height 15 in. Pkt., 10c; ¼ oz., 90c.

***STAR PHLOX. (Cuspidata.)** With star-shaped flowers, dwarf growth. Height 12 in. Pkt., 10c; ¼ oz., \$1.10.

POPPIES

TULIP POPPY. One of the most brilliant annuals, the flowers are 3 inches in diameter and of a scarlet color, greatly resembling tulips. Height 20 in.

Pkt., 10c; ¼ oz., 60c.

THE SHIRLEY. Special strain mixed; fine for bedding or cutting; single annual. Height 20 in.

Pkt., 10c; ¼ oz., 25c.

ESCHSCHOLTZIA. (California Poppy.) Spreading plants 1 foot high, suitable for beds and borders, blooming from June until frost. Mixed. Pkt., 10c; ¼ oz., 25c.

PORTULACA—Mexican Rose

Very showy annual, easily grown, and very effective when massed in beds or edgings. A profusion of brilliantly colored flowers are produced throughout the summer. They thrive best in rather rich soil in a sunny situation. Height 6 in.

***LARGE-FLOWERING EXTRA DOUBLE MIXED.**

Pkt., 10c; ¼ oz., 90c.

***LARGE-FLOWERING SINGLE MIXED.** All colors.

Pkt., 10c; ¼ oz., 40c.

RICINUS—CASTOR OIL BEAN

Ornamental plants of strong, stately growth, the foliage having the appearance of a tropical plant, very effective when planted in masses or as centers of Canna or Dahlia beds. Height 6-8 ft.

ZANZIBAR. Extra mixed. Pkt., 10c; ¼ lb., \$1.00.

SALPIGLOSSIS

Petunia-like flower borne on bushy stem, about 24 inches tall, various shades, which flower profusely during the summer. Mixed. Pkt., 10c; ½ oz., 90c.

SCABIOSA OR MOURNING BRIDE

Fine free-flowering plants for mixed borders and highly esteemed for cut flowers. The blooms are borne on long, erect stems in globular heads in colors ranging from white to dark maroon. From midsummer until frost. Height 3½ to 4 feet.

IMPERIAL HYBRIDS MIXED. Pkt., 10c; ½ oz., 75c.

IMPERIAL GIANT BLUE MOON. Deep lavender blue.

Pkt., 15c; ¼ oz., 45c.

SALVIA SPLENDENS OR SCARLET SAGE

Very popular bedding plant, extensively used for lawn and conservatory decoration, bearing long spikes of brilliant flowers from July to frost.

BONFIRE. Very dense flowering 2½ foot plants, excellent for beds or massing for color effect.

Pkt., 10c; ¼ oz., \$1.25; oz., \$3.75.

BLAZE OF FIRE. Begins blooming 10 days earlier than any other early flowering Salvia. Dwarf type. Height 12 in. Pkt., 15c; ½ oz., \$1.00.

HARBINGER. Dwarf compact plants with bluish green foliage and a profusion of scarlet flowers. Height 16 in. Pkt., 15c; ½ oz., \$1.50.

SCHIZANTHUS

***MONARCH HYBRID MIXED.** A plant noted for its wonderful variety of coloring and butterfly-like blossoms, fine for cutting, graceful fern-like foliage, height about 18 inches. Blooms May and June. Pkt., 10c; ½ oz., \$1.00.

SNAPDRAGON

See Antirrhinum, page 43.

STATICE (Annual)

Suitable for growing in rock gardens and when dried used for winter bouquets. Splendid clusters of colorful, strawy blooms on stiff stems. Blooms all summer. Height 2 ft.

***SINUATA CHOICE MIXED.** Pkt., 10c; ¼ oz., 25c.

STEVIA

SERRATA. Grown outdoors or as a home plant for its dainty, fragrant, tiny white, star-shaped flowers produced profusely. Excellent cut flower for combining with other varieties. Height 2½ ft. Pkt., 15c; ½ oz., 50c.

STOCKS-10-WEEKS

Deliciously-scented flowers like small rosettes are produced in a wide range of soft and distinct shades. Fine for bedding, borders and cutting. Blooms May to July.

DOUBLE EARLY GIANT IMPERIAL. (Improved Bismarck.) Height 26 in. Mixed. Pkt., 10c; ½ oz., 75c.

DRESDEN PERPETUAL. These fine stocks will live outdoors for several years if protected with a fairly thick layer of straw, which must be lifted early in the spring. Height 20 in. Pkt., 15c; ¼ oz., 85c.

DWARF DOUBLE LARGE FLOWERED MIXED. Height 12 in. Pkt., 10c; ¼ oz., 75c.

Varieties marked * suitable for Rock Gardens.

SWEET PEAS

CALIFORNIA GROWN SUCCESSFUL EVERYWHERE

One Ounce for 30 to 40 feet of row

THE SPENCERS are of exceptionally large size, the petals waved and frilled and the general effect remarkably graceful and effective. The plants are of vigorous growth and remain in bloom for a longer time than the Grandiflora sorts.

CULTURE.—Grow named varieties of the colors you like best; know them by name in your garden and you will derive much more pleasure from them. Early in the spring make a trench three to four inches deep in rich, mellow soil, so arranged that no water can stand in it and plant the seed in the bottom, covering at first only one inch deep. When the plants are two inches high, cultivate; and as they grow, gradually fill in the trench. When the plants are about five inches high they should be supported by poultry netting, strings or brush. Water should be applied thoroughly once or twice a week early in the morning or in the evening. The blooms should be picked before they form pods or the plants will soon stop flowering. Fall sowing has proven very desirable in the vicinity of Baltimore by preparing the ground in October and sowing the seed in November. Plant about 4 in. deep and after the ground is frozen hard, mulch with 3 or 4 in. of light litter. Remove the mulch very early in the spring.

Early Flowering Spencer

(FLORISTS WINTER FLOWERING)

Florists' varieties for early forcing—can also be grown successfully outdoors, coming into bloom a month earlier than original Spencer.

HARMONY. Clear lavender.

MARINER. Best clear blue.

SNOW QUEEN. Pure white, opens and retains pure white color.

VALENCIA. Bright orange, sunproof, long stems.

VULCAN. Vivid scarlet, sunproof.

ZVOLANEE'S ROSE. Bright rose pink.
Pkt., 15c; oz., 25c; ¼ lb., 85c; lb., \$2.50.

MANN'S SUPERB SPENCER MIXTURE.
Pkt., 10c; oz., 20c; ¼ lb., 60c; lb., \$2.00.

Cuthbertson Garden Varieties

An ideal strain for gardeners. Superior to other types in vigor, profusion of large fragrant flowers, and longer stems. The chief advantage outdoors is their longer blooming period, due to their ability to withstand warm weather.

COLINE. Intense Vivid Scarlet.

EVELYN. Salmon Cream Pink.

FRANK G. Rosy Lavender.

JANET. Large Frilled White.

LOIS. Clear Rose Pink.

TOMMY. Clear Medium Blue.

Pkt., 15c; oz., 45c; ¼ lb., \$1.25; lb., \$3.75.

CUTHBERTSON. Finest Mixed.

Pkt., 15c; oz., 35c; ¼ lb., 95c; lb., \$2.75.



Spencer Sweet Peas

SPIDER PLANT

CLEOME. Plants 4 ft. spreading but open growth. White or pink curious flower heads. Blooms continuously until frost. Pkt., 15c; ¼ oz., 75c.

SUNFLOWER

(See also Helianthus)

CALIFORNIA GIANT. Grown for ornamental or commercial use. Gray striped seed. Pkt., 10c; ¼ lb., 20c; lb., 50c.

SUMMER POINSETTIA

See Amaranthus Molten Fire.

SWEET WILLIAM

SEE PAGE 55

TITHONIA

TOECH. Orange scarlet, single flowers with gold centers. Easy to grow, blooms all summer until frost. 5 foot tall. Pkt., 25c; ¼ oz., \$1.30; oz., \$3.85.

TORENIA

FOURNIERI. Plants 6 to 8 in., bushy. Blooms July until frost. Flowers, blue with yellow throat. Pkt., 15c; ½ oz., \$1.50.

VERBENA

One of the finest bedding plants and also suitable for borders, with its heads of brilliantly colored flowers, producing a mass of bloom throughout the summer. Seeds may be planted as soon as the ground can be worked or earlier indoors and transplanted to the beds in April or May. They succeed in almost any good garden soil.

HYBRID MAMMOTH MIXED. Extra large flowered, brilliant colors and vigorous. Height 1½ ft. Pkt., 10c; ¼ oz., 80c.

HYBRIDA GRANDIFLORA. Dwarf mixed. Pkt., 15c; ¼ oz., \$1.30.

Varieties marked * suitable for Rock Gardens.

VINCA (Periwinkle)

Very attractive bushy plants with luxuriant glossy green foliage, producing in abundance handsome flowers that bloom freely all summer. Excellent for borders, summer bedding and window boxes. Height 1 ft. Choice mixed. Pkt., 10c; ¼ oz., 80c.

ZINNIAS—DOUBLE

DAHLIA FLOWERED IN SEPARATE COLORS Height 2½-3 ft.

CRIMSON MONARCH. Deep crimson.

DREAM. Deep lavender purple.

GOLDEN DAWN. Golden yellow.

ILLUMINATION. Deep soft pink.

POLAR BEAR. Pure white.

WILL ROGERS. Scarlet.

Pkt., 15c;
¼ oz., 35c.

DAHLIA FLOWERED MIXED. Pkt., 10c; ¼ oz., 35c.

BURPEE'S HYBRIDS. Giant flowers with quilled petals, wide range of colors. 3 ft. Pkt., 25c; ½ oz., 75c.

GIANT FLOWERED MIXED. Height 3-4 ft. Pkt., 10c; ¼ oz., 35c.

EARLY WONDER FINEST MIXED. Earliest of all Zinnias. 3 to 4 in. flowers on long wiry stems. Plants have no laterals and practically no leaves. Bred for cut flower use. Height 1½ to 2 ft. Pkt., 15c; ¼ oz., 50c.

CROWN O'GOLD PASTEL TINTS. Large well formed flowers each petal tipped with gold. Pkt., 15c; ¼ oz., 35c.

PASTEL GIANTS MIXED. Pkt. 10c; ¼ oz., 35c.

PERSIAN CARPET. Flowers 1 to 1½ in. diameter, each plant different easy to grow, thrives on heat, 12 in. height. Pkt., 25c; ¼ oz., \$1.50.

FANTASY. Large, well-rounded, informal graceful Chrysanthemum shaped blooms on long stems in the usual range of zinnia colors. Height 2½-3 ft. Pkt., 10c; ½ oz., 50c.

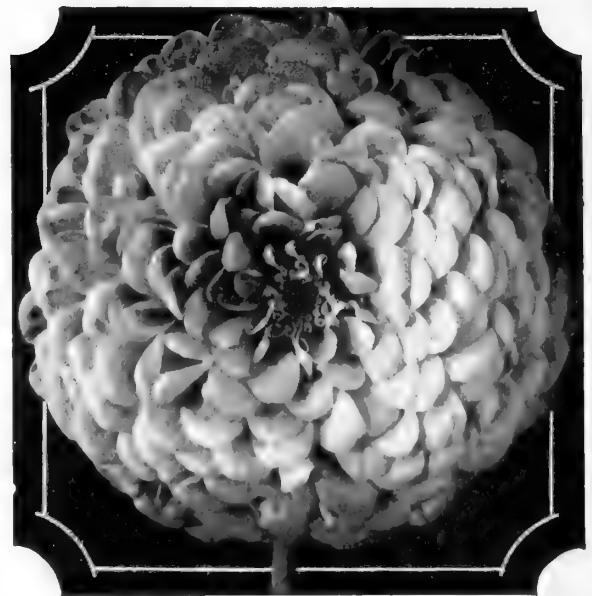

Dahlia Flowered Zinnia

DOUBLE LILLIPUT. Dainty profuse blooming type; flowers 1 inch in diameter, very popular. Orange, Salmon Rose, Lilac, Pink, Scarlet, Mixed. Height 1½-2 ft. Pkt., 15c; ¼ oz., 35c.

TOM THUMB FINEST MIXED. Well formed flowers of the Lilliput type, for pot plants and borders. Height 6 to 8 in. Pkt., 15c; ¼ oz., 50c.

Vines

BALLOON VINE. (Cardiospermum.) Very graceful, rapid grower. Climber with clusters of small white flowers followed by large, inflated balloon-shaped seed pods. Height 10 ft. Pkt., 10c; ¼ oz., 20c.

BALSAM APPLE. (Balsamina.) Fine for trellises or low fences. Rapid growing vines with lobed light green leaves and beautiful fruits of a rich golden yellow color, which when ripe, open up, disclosing the seeds in a carmine covering. (10-12 ft.) Pkt., 10c; ½ oz., 50c.

CARDINAL CLIMBER. (Ipomoea Quamoclit Hybrida.) An easily grown climber developing to perfection in sandy loam soil. The brilliant scarlet flowers are borne profusely. The leaves resemble those of a fine Japanese Maple. (15-25 ft.) Pkt., 10c; ¼ oz., 80c.

COBAEA SCANDENS. Of rapid growth, with fine foliage and large bell-shaped flowers of a beautiful violet blue color. (10-20 ft.) Pkt., 10; ¼ oz., 90c.

CYPRESS VINE. (Ipomoea quamoclit.) Beautiful and very popular, slender vine, with fern-like foliage and a mass of small star-shaped flowers. (10 ft.) Scarlett. Pkt., 10c; ¼ oz., 50c.



Gourds

GOURDS. A large and interesting class producing a great variety of curious fruits, many of which are peculiarly marked. (12 ft.) Pkt., 10c; ½ oz., 50c.

HYACINTH BEAN (Dolichos.) Of extra rapid growth, introduced from Japan and very much superior to the old-fashioned flowering bean. (15 ft.) Mixed. Pkt., 10c; ½ oz., 50c.

KUDZU VINE. Pkt., 15c; ¼ oz., 35c.

MOON FLOWER. (Ipomoea mexicana.) Very pretty, rapid growing vine, with handsome trumpet-shaped flowers. (15 ft.) Pkt., 10c; ¼ oz., 20c.

MORNING GLORY

Giant Japanese Imperial Mixed. (10 ft.) Pkt., 10c; ¼ oz., 30c.

Double Rose Marie. Deep rose. Pkt., 15c; ½ oz., 60c.

Scarlet O'Hara. Rich dark wine red or deep rosy crimson, 3½ inch diameter. (10 ft.) Pkt., 10c; ¼ oz., 50c.

Heavenly Blue. Sky blue, shading golden yellow in throat, 4 inch diameter. (10 ft.) Pkt., 10c; ¼ oz., 25c.

Pearly Gates. Enormous flowers, 4½ inches across, clear shining white. (10 ft.) Pkt., 10c; ¼ oz., 35c.

PASSION FLOWER. (Passiflora.) A most interesting and well known climber, bearing singularly beautiful flowers. Blue and white mixed. Pkt., 10c; ¼ oz., \$1.15.

SMILAX. Pkt., 25c; ¼ oz., \$1.00.

THUNBERGIA. (Black-eyed Susan.) Free-flowering and of rapid growth. May be trained on a slender trellis or allowed to run freely over the ground to cover bare spaces. (5 ft.) Pkt., 10c; ¼ oz., 50c.

SCARLET RUNNER. Of very rapid growth, producing clusters of showy bright scarlet pea-shaped blossoms, followed by edible beans of very fine quality. (20 ft.) Pkt., 10c; oz., 15c.

Varieties marked * suitable for Rock Gardens.

Perennial Flower Seeds

Perennials are used extensively in old fashioned gardens, hardy borders and rock gardens. They are easily grown and when once established become increasingly beautiful year after year. Care should be taken in selecting varieties according to their color, height and season of bloom.

The seeds may be sown indoors or in hot beds early in the spring and transplanted to their permanent locations when three or four inches tall. Very satisfactory results can also be obtained by sowing the seeds early in August and shading from excessive heat by using lath or burlap screens. It is well to give young plants winter protection the first year.

The following list includes those varieties which are most popular because of their beauty, usefulness and adaptability to local climatic conditions:

ALYSSUM

***SAKATILE—Compactum.** An excellent border and rock garden plant covered with bright sulphur-yellow flowers during early spring. Height 9 in. Pkt., 10c; ¼ oz., 40c; oz., \$1.25.

ANEMONE

***CORONARIA ST. BRIGID.** Semi-double and double flowers in a wonderful array of brilliant colors. Blooms in June. Height 18 in. Pkt., 10c; ¼ oz., \$1.50.

AQUILEGIA OR COLUMBINE

LONG SPURRED GIANT HYBRIDS. Very hardy, blooming profusely early in the season and during the summer a dainty cut flower and an attraction in the perennial border. Height 3 ft. Pkt., 10c; ½ oz., \$1.50.

MRS. SCOTT ELLIOTT HYBRIDS. The world's finest strain, consisting of the most wonderful colors, with very long spurred flowers. Height 3 ft. Pkt., 15c; ½ oz., \$1.25.

***COERULEA—The Rocky Mountain Columbine.** Blue, blooms during June. Height 2 ft. Pkt., 10c; ½ oz., \$1.25.

ARABIS—Rock Cress

***ALPINA.** An excellent early blooming dwarf perennial, covered with a mass of white flowers. It makes a fine border for taller perennials. Blooms during April. Height 6 in. Pkt., 10c; ¼ oz., 50c.

ARMERIA—Sea Pink

***FORMOSUM HYBRIDS.** Dwarf plants with grassy leaves and clover-like flower heads from May until July in various shades of pink. Height 1½ ft. Pkt., 10c; ¼ oz., 80c.

BOSTON IVY

AMPELOPSIS VEITCHII. Popular wall ivy with three lobed leaves which turn to bright red late in the fall. Attains a height of 20 to 30 feet in 2 or 3 years. Pkt., 15c; ¼ oz., 40c.

CACTUS

MIXED VARIETIES. All kinds and forms mixed including rare sorts. Easily and quickly grown; very interesting pot plants. Pkt., 10c; 1/18 oz., 75c.



Anemone

BELLIS (Double English Daisy)

Dwarf plant which bears very double aster-like flowers. Useful for border or for cut flowers. Blooms April to July. Height 6 inches.

MONSTROSA. Doubled Red. Pkt., 10c; ½ oz., \$1.50.

MONSTROSA. Double Mixed. Pkt., 10c; ¼ oz., \$1.60.



Aquilegia

Varieties marked * suitable for Rock Gardens.

CAMPANULA—CANTERBURY BELLS

CALYCANTHEMA. Hardy Biennial. Tall, erect growing plants, completely covered with large cup and saucer shaped flowers during May and June. Height 3 ft. Mixed. Pkt., 10c; ¼ oz., 70c.

CANDYTUFT

***IBERIS SEMPERVIRENS.** Large heads of white flowers. Height 1 ft. Pkt., 10c; ¼ oz., \$1.25.

GIBRALTARICA. White flushed lilac. Blooms during June and July. Height 10 in. Pkt., 15c; ¼ oz., 60c.

QUEEN OF ITALY. Rosy lilac. Pkt., 15c; ¼ oz., 60c.

CARNATIONS

With protection these well known half-hardy perennials can be wintered over outdoors. When planted early they will begin to bloom in about four months and continue until late in the fall. For winter blooming they should be cut back by removing the flower shoots early in the fall and transplanted to pots and kept in a cool room.

EARLY DWARF VIENNA. Carnations like lime. Compact plants about a foot tall, displaying an excellent range of bright colors. Height 1 ft. Mixed Dwarf. Pkt., 10c; ¼ oz., \$1.10.

MARGUERITE. Half Dwarf. Height 15 to 18 in. Choice double mixed. Pkt., 10c; ¼ oz., \$1.30.

PERPETUAL (Famous Chaubaud Type). White. Height 2 ft. Pkt., 15c; ¼ oz., \$2.15. Choicest mixture. Pkt., 10c; ¼ oz., \$1.30.

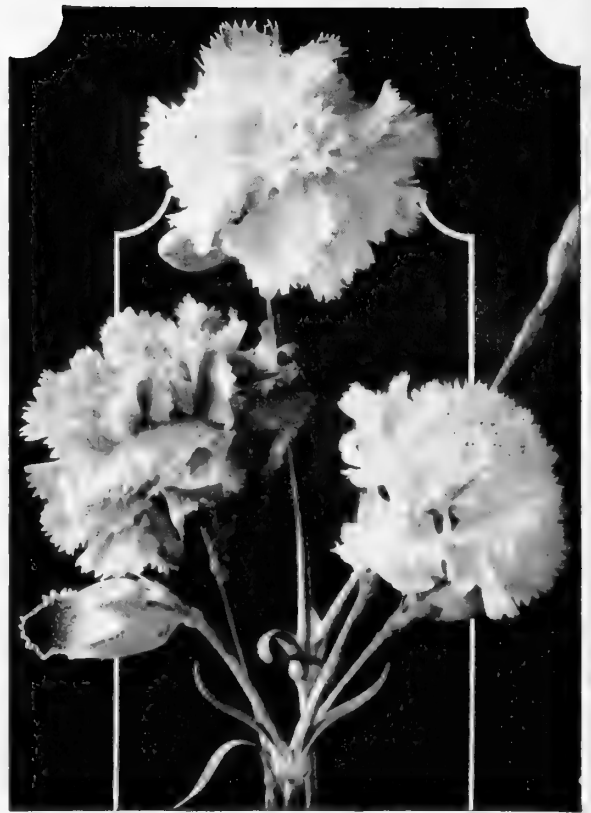

Carnation

CHRYSANTHEMUM PLANTS

Hardy Garden Varieties

40c Each \$4.50 Per Doz.

LARGE FLOWERED

AVALANCHE, white
CHARLES NYE, yellow
EMBER, bronze
MRS. FINDLAY, yellow

MRS. P. D. DUPONT, peach
ORIENTAL GLOEY, red
SEPT. DAWN, lavender
TIFFANY ROSE, rose

NEW LARGE ENGLISH

(Tall Early Flowering)

ALABASTER, white
CONQUEROR, red

GOLD STANDARD, yellow
LEDA, pink

POMPOMS AND BUTTONS

BURGUNDY, wine
CAROLYN YOSICK, lavender
EARLY WONDER, pink
MANDALAY, bronze

IRENE, white
JUDITH ANDERSON, yellow
RED FLARE, red
ZANTEA, yellow

SINGLES

EUREKA GIANT, bronze
GALAHAD, yellow
KRISTINA, rose

MR. ANDREWS, pink
RED HUSSAR, late
SILVER MOON, white

DWARF AND CUSHION VARIETIES

BREECE'S RED CUSHION **JOAN HELEN,** purple
EARLY BRONZE, bronze **MAJOR CUSHION,** pink
GOLDEN GLOEY, yellow **RED GOLD,** red

Varieties marked * suitable for Rock Gardens.

COLEUS (Tender)

HYBRID MIXTURE. Attractive and richly colored foliage plants for house or garden culture. Easily grown bedding plant for any shady or partially shady location. Height 2 ft. Pkt., 10c; 1/16 oz., \$2.00.

COREOPSIS—Golden Wave

GRANDIFLORA. (Mayfield Giants.) Double and semi-double broadly expanded golden yellow flowers. The plants bloom freely during late spring and summer affording a constant supply of cut flowers. Height 3 ft. Pkt., 10c; ¼ oz., 25c.

DOUBLE SUNBURST. Large, golden yellow, fully double, early blooming fine cut flowers. Height 3½ ft. Pkt., 15c; ¼ oz., 35c.

DAHLIA (Half Hardy)

Seed should be planted very early indoors and the plants transplanted in May or June. Most of the plants will bloom the same year. The roots should be dug before freezing weather and stored in vermiculite in a cool place.

DOUBLE FINEST MIXED. Many rich colors. Height 4 ft. Pkt., 10c; ½ oz., \$1.25.

COLTNESS HYBRIDS. Small, neat single flowers on very dwarf plants, for bedding. Pkt., 15c; ¼ oz., 80c.

SINGLE MIXED. Height 3½ ft. Pkt., 15c; ¼ oz., 60c.

UNWINS DWARF HYBRID IDEAL BEDDING MIXED. Double and semi-double flowers in a wide range of color. Flowering within four months from sowing. Height 1½-2 ft. Pkt., 10c; ¼ oz., 50c.

DELPHINIUM

One of the finest summer flowering hardy perennials. To prolong the season of bloom cut the old flower stems off after they have faded and new shoots will produce flower heads successively. Sow Delphinium seed as soon as it is received to insure strong germination.

PACIFIC GIANTS BLACK KNIGHT SERIES. Very dark blue. Pkt., 15c; 1/16 oz., \$1.60.

PACIFIC GIANTS BLUE BIRD SERIES. Clear medium blue, white bee. Height 5 ft. Pkt., 15c; 1/16 oz., \$1.60.

PACIFIC GIANTS GALAHAD SERIES. Clear hugh white. Mildew resistant. Height 5 ft. Pkt., 15c; 1/16 oz., \$1.25.

PACIFIC GIANTS LANCELOT SERIES. Clear lilac self, a rare color, white bee. Height 5 ft. Pkt., 15c; 1/16 oz., \$1.60.

PACIFIC GIANTS MIXED. Florets 2½ to 3½ in. across. Mildew resistant. Height 5 ft. Pkt., 10c; 1/16 oz., \$1.25.

DIANTHUS—Hardy Pinks

FLORISTS' PERPETUAL. Large clusters, fragrant, very useful for cut flowers. Height 1½ ft. Double and Single Mixed. Pkt., 10c; ¼ oz., \$1.25.

***PLUMARIUS—Single Mixed.** Large showy single flowers in wide range of colors during May and June. Height 1 ft. Pkt., 10c; ¼ oz., 70c.

***PLUMARIUS—Double Mixed.** Of very compact growth, double flowers in many colors, during May and June. Height 1 ft. Pkt., 10c; ¼ oz., 70c.

FEVERFEW (Matricaria)

BRIDAL ROSE. Beautiful, small, white button-like double flower heads, from June to October. Plants of bushy growth with finely cut dark green foliage; desirable for bedding. Height 2 ft. Pkt., 15c; ¼ oz., \$1.70.

DOUBLE GOLDEN BALL. 8 in. dwarf. Pkt., 15c; ¼ oz., \$1.15.

FORGET-ME-NOT—Myosotis

***BIENNIAL ALPESTRIS.** Popular plants for massing in beds or borders. Succeeds best in moist, shady locations. Vivid blue flowers from May to July. Height 1 ft. Pkt., 10c; ¼ oz., \$2.00.

FOXGLOVE OR DIGITALIS

In stately appearance the Foxgloves occupy a prominent place among our hardy plants. They succeed well in an average garden soil. Blooms June and July.

MONSTROSA FINE MIXED. This mixture of the Giant Foxgloves is sure to please every gardener. Produces long spikes of beautiful, tubular-shaped flowers in a wide range of rich colors. Height 4-5 ft. Pkt., 10c; ¼ oz., 50c.

GALLARDIA

BURGUNDY. Easily grown, will flower the first year if sown early. Thrives in full sun, will stand drought and hot weather. Long stemmed daisy-like flowers bloom in profusion from June to October. Height 2½ ft. The reddest Gaillardia—shining wine-red petals sometimes tipped yellow. Pkt., 10c; ¼ oz., 90c.

GRANDIFLORA, FINEST MIXED. Pkt., 10c; ¼ oz., 65c.

THE DAZZLER. Bright golden yellow with crimson-maroon center, rather large. Pkt., 10c; ¼ oz., 75c.

GERBERA (Jamesoni Hybrids)

NEW AFRICAN TRANSVAAL DAISY, producing wonderfully beautiful daisy-like blooms of large size, in a wide range of colors. Grown either as a greenhouse plant or propagated in hot-beds and set out early in May. Very profitable cut flower for florists. Height 12 to 18 inches. Pkt., 10 seeds, 10c; 100 seeds, 75c.



Delphinium



Gerbera



Feverfew

Varieties marked * suitable for Rock Gardens.

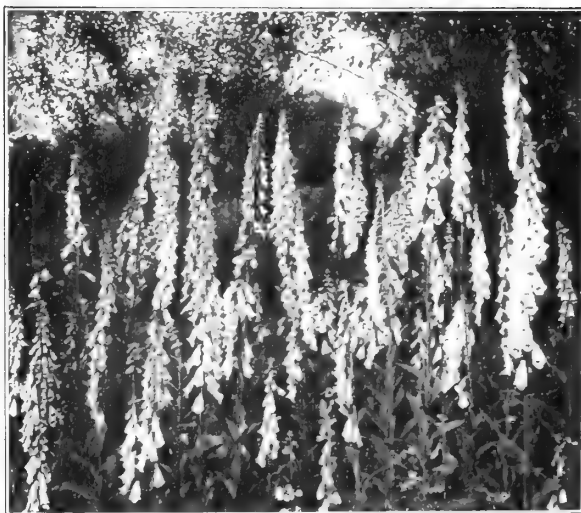

Foxglove



Gallardia



Sweet Rocket

Varieties marked * suitable for Rock Gardens.

GEUM—Coccineum

***MRS. BRADSHAW.** Graceful, double orange-scarlet flowers produced on long stems from June to September. Valuable for cutting; excellent for border. Height 2 ft. Pkt., 10c; ¼ oz., 50c.

GYPSOPHILA—Baby's Breath

SINGLE (PANICULATA). Tiny white flowers borne on slender stems. The plants are covered with blooms during June and July. Height 3 ft. Pkt., 10c; oz., 80c.

DOUBLE BABY'S BREATH. Small, double, white flowers, carried on slender wiry stems. Makes a fine show during June and July. Height 3 ft. Pkt., 15c; ¼ oz., \$2.50.

***REPENS.** An excellent variety for rock gardens. The plants are covered with small white flowers during June and July. Height 6 in. Pkt., 15c; ¼ oz., \$1.85.

HELIOTROPE (Half Hardy)

Excellent bedding plants in summer, desirable pot-plants during winter. Succeeds in any good soil and sunny location. Fragrant. Height 2 ft.

GIANT FLOWERED. Mixed. Pkt., 15c; ¼ oz., \$1.00.

HESPERIS MATRONALIS

(SWEET ROCKET)

Old fashioned garden plants. Bears during the summer, snowy white, lilac and purple fragrant flowers. Height 2-3 ft. Excellent for planting in a border or among shrubbery. Mixed. Pkt., 10c; ¼ oz., 35c.

HOLLYHOCKS

Excellent for a background to dwarfier plants. Succeeds best in deep rich, well drained soil. Sunny location. Blossoms from late spring until midsummer. Height 5-6 ft.

CHATERS DOUBLE CHOICE MIXTURE.

Pkt., 10c; ¼ oz., 90c.

CHATERS SINGLE MIXED. Large, very artistic blooms.

Pkt., 10c; ¼ oz., 30c.

IBERIS—See Candytuft (Perennial)

LATHYRUS—Perennial Sweet Peas

A showy, free-flowering hardy climber. Blooms from midsummer until frost. Excellent for cutting. Height 5-6 ft.

FINEST MIXED. Pkt., 10c; ¼ oz., 80c.

LINARIA—Kenilworth Ivy

***CYMBALARIA.** Small lilac blue flowers, are borne on a charming neat trailing plant. Height 4 to 6 in. Pkt., 10c; ¼ oz., 70c.

LINUM—Perennial Flax

***PERENNE.** Beautiful light blue flowers from July until August. The blooms last only one day but they are produced continuously. Height 2 ft. Pkt., 10c; oz., 45c.

LUNARIA—Honesty

Biennial plant having round, silvery white, paper-like seed-pods which are dried for winter bouquets. Height 1½ to 2½ ft. Mixed. Pkt., 10c; ¼ oz., 50c.

LUPINS

Elegant spikes of pea-flower-like blooms during May and June. Height 3 ft.

RUSSEL. New hybrid. Pkt., 10c; ¼ oz., 90c.

NIEREMBERGIA (Tender Perennial)

PURPLE ROBE. Rich deep violet purple dwarf compact, does not fade, free flowering. Height 6 in. Pkt., 10c; 1/32 oz., \$1.50.

PENTSTEMON

HYBRID GLOXINIOIDES (Beard Tongue). Beautiful bell-shaped flowers. Height 2½ ft. Choice mixed. Pkt., 15c; ¼ oz., \$1.00.

PHLOX

DECUSSATA—New Hybrids. Flowers in all bright colors; sow seeds late in fall and they will germinate in the spring. Height 2-3 ft. Pkt., 10c; ¼ oz., 85c.



Platycodon



Iceland Poppies



Wallflower

PLATYCODON—Chinese Bellflower

GRANDIFLORA. Large showy, deep blue flowers, are produced all summer. A splendid plant for the hardy border. Height 1½ ft. **Pkt., 15c; ¼ oz., \$1.00.**

POPPIES

ORIENTAL SCARLET. The blooms are an intense shade of scarlet red having a conspicuous black blotch on each petal, during June and July. Height 2½ ft. **Pkt., 10c; ¼ oz., \$1.30.**

PRINCESS VICTORIA LOUISE. Salmon pink. **Pkt., 15c; ¼ oz., \$1.50.**

POPPY NUDICAULE—Iceland Poppies

Great numbers of flowers on slender stems 1 foot long throughout the season.

***SUNBEAM MIXED.** Embracing all the graceful, gaily, colored flowers in white, yellow and orange found in Iceland Poppies. **Pkt., 10c; ¼ oz., \$1.00.**

PRIMULA—Primrose

***AURICULA.** Many bright colors, including orange, copper, brown, and other pastel shades. An excellent hardy Primrose for the border. Blooms during spring. Height 6-9 in. **Pkt., 15c; ½ oz., \$1.25.**

PYRETHRUM—Painted Daisy

SINGLE MIXED. A showy perennial with daisy-like flowers, blooming during May and June. Height 2 ft. **Pkt., 10c; ¼ oz., \$1.25.**

DOUBLE MIXED. This mixture contains many bright showy colors, shading from white to deepest red. The blooms are elegantly doubled. Height 2 ft. **Pkt., 10c; ½ oz., \$1.25.**

RUDBECKIA—Cone Flower

MY JOY. Brilliant golden yellow daisy-like flowers with brown centers. Blooms from July until October. Height 3 feet. **Pkt., 15c; ¼ oz., 60c.**

SAPONARIA—Rock Soapwort

***OCYMOIDES.** Splendid hardy rock plant, with rose pink flowers during spring and summer. Height 6 to 9 in. **Pkt., 15c; ¼ oz., \$1.40.**

SCABIOSA

CAUCASICA. Charming perennials for border and cut flower culture. The large lavender blue flowers are borne profusely on fine long stems. Height 2 ft. **Pkt., 10c; ¼ oz., \$2.00.**

SHASTA DAISY

ALASKA. Splendid hardy perennial plants, having large white flowers with yellow center, 4 to 5 in. across, borne singly on long, stiff, wiry stems; excellent for cutting and borders. Height 2 to 2½ ft. **Pkt., 10c; ¼ oz., 50c.**

STATICE—Sea Lavender

Splendid hardy perennials, either for the border or rockery, producing all summer panicles of small flowers, which can be dried and used for winter bouquets. Height 2 feet.

LATIFOLIA. Large deep-blue flowers. **Pkt., 15c; ¼ oz., 90c.**

SWEET WILLIAM—Biennial

DIANTHUS BARBATUS

Sow the seed very early and have vigorous young plants coming into bloom the same season. They may be sown, however, in August to bloom the following May and June. Height 1-1½ ft.

SINGLE MIXED. All shades of white, pink and red. **Pkt., 10c; ¼ oz., 35c.**

SINGLE NEWPORT PINK. **Pkt., 15c; ¼ oz., 75c.**

SINGLE SCARLET BEAUTY. Scarlet. **Pkt., 15c; ¼ oz., 80c.**

DOUBLE MIXED. Very fine; all colors. **Pkt., 10c; ¼ oz., 45c.**

DOUBLE EXTRA DWARF MIXED. **Pkt., 10c; oz., \$4.00.**

TRITOMA—Poker Plant

EARLY HYBRID. Massive orange-scarlet flowers, for border and cutting. Blooms August to October. Needs winter protection. Height 3-4 ft. **Pkt., 10c; ¼ oz., 90c.**

VALERIANA (Coccinea)

Very showy red flowered border plant. Does well in poor soil. Height 2 to 3 ft. **Pkt., 15c; ¼ oz., \$1.00.**

VIOLAS OR TUFTED PANSIES

Well-known, free-flowering hardy perennials, easily grown from seed. While flowers are not so large as the regular type of Pansy, the blooms are produced in such an abundance and the flowering season so much longer that they are superior to pansies for some purposes. Seed sown in April produces flowering plants by June and from then on until frost they are a sheet of bloom. Height 6 in.

LUTEA SPLENDENS (Yellow). **Pkt., 10c; 1/16 oz., 50c.**

HYBRIDA. Choice mixed. **Pkt. 15c; ½ oz., \$1.25.**

VIOLET

ODORATA SEMPERFLORENS. Blue. **Pkt., 25c; 1/16 oz., 70c.**

WALLFLOWER

Showy plants, sweet-scented flowers in bright oriental red and yellow colors in May. Good cut flower. Height 1½ to 2 ft.

DOUBLE MIXED. **Pkt., 10c; ¼ oz., \$1.50.**

Varieties marked * suitable for Rock Gardens.

ANEMONES

GIANT DE CAEN POPPY FLOWERED

Blue Poppy; His Excellency (scarlet); The Bride (white). 10c each; \$1.00 per dozen; \$6.75 per 100.

CANNA ROOTS

City of Portland. 4½ ft. Rosy pink, green foliage. \$1.00 per dozen.

KING HUMBERT. 4 ft. Leaves are purple-brown over bronze. Crowned with immense heads of velvety orange-scarlet. \$1.00 per dozen.

PRESIDENT. 4 ft. The most wonderful green leaved, red flowered canna in cultivation. \$1.00 per dozen.

YELLOW KING HUMBERT. 4 ft. Green leaves, golden-yellow flowers blotched red. \$1.00 per dozen.

GLOXINIA

Blanche de Maru—Pink Montblanc—White
Defiance—Scarlet Roi des Rouges—Red
Emperor William—Blue Violaacea—Violet

Above colors or Mixed—40c each; \$4.50 dozen.

HYACINTHUS CANDICANS

An ornamental midsummer flowering plant, producing from 20 to 100 large bell shaped flowers of a creamy white color on spikes 3 to 5 feet high. 15c each; \$1.50 doz.

PERUVIAN DAFFODIL

(ISMENE CALATHINA)

Summer-flowering bulb with large, amaryllis-like, pure white, fragrant blossoms. 2½-in. size. 75c ea.

IRIS

	Each
Ambassador. Bronze and maroon.....	.20
Black Magic. Deep Purple40
Coronation. Tall Yellow20
El Capitan. Blue30
Germaine Perthuis. Rich blue-purple.....	.30
Gold Imperial. Golden20
Mary Barnett. Lovely light blue.....	.50
Sequoiah. Buff and deep red.....	.40



Hardy Lilies

LILIES

Estate. Hardy pure white Easter lily type, 24 in. tall, blooms Aug. and Sept. 6 to 7 in. cir. bulbs. 45c each; 6 for \$2.25; 100 for \$32.50.

Regal. White shading to yellow in the center with pink tinge on outer edge. Height 3 to 5 ft. Bulbs 7-8 inch size. 40c ea.; 6 for \$1.85; 100 for \$25.00.

Spec. Rubrum Magnificum. Deep pink, healthy. Bulbs 7-8 inch size. 40c ea.; 6 for \$1.85; 100 for \$25.00.

Tigrinum Splendens. Orange-red spotted purple on the reflexed petals. Blooms late Aug. or early Sept. Bulbs 6-7 inch size. 40c ea.; 6 for \$1.85; 100 for \$25.00.

Willmottiae Improved. Dazzling orange, few small maroon spots, large flowering heads of 20 to 25 flowers, very graceful and a superior garden lily. Bulbs 6-7 inch size. 40c ea.; 6 for \$1.85; 100 for \$25.00.

Henryii. Rich orange, reflexed petals spotted brown, stamens long and showy, vigorous and easily grown. Flowers in August. Bulbs 7-8 inch size. 40c ea.; 6 for \$1.85; 100 for \$25.00.

AMARYLLIS

(GIANT AMERICAN HYBRIDS)

The most desirable type of Amaryllis, especially beautiful and easily managed in the amateur's window or conservatory, produces from four to six gigantic blooms of perfect form. Mixed colors, 3 inches up, 60c each. Imported Holland giants. Red or pink. \$2.75 each.

TUBEROUS ROOTED BEGONIAS

Especially adapted to window or conservatory culture. Double scarlet, pink, yellow. 30c each; \$3.50 dozen.

BLEEDING HEARTS

A beautiful hardy garden plant of graceful habit, 2 to 3 feet high. The foliage is of a highly ornamental fern-like appearance, over which hang the drooping spikes of pink, heart-shaped flowers. Blooms in May and June. Can be lifted and potted for winter and spring bloom indoors. 70c each.

EXCELSIOR PEARL TUBEROSE

One of the most fragrant and most popular of the summer flowering bulbs. May be started early in hotbeds or pots, or planted in open ground after the first of May. 15c each; \$1.50 per dozen.

CALADIUM ESCULENTUM OR ELEPHANT'S EAR

Large bulbs, 9-11 inch. 25c each; \$2.50 per dozen; medium sized bulbs, 5-7 inch, 10c each; \$1.00 per dozen.

FANCY LEAVED CALADIUMS

Separate Colors or Mixed. 35c each; \$3.50 dozen.



Hardy Iris



PINK

GEN. EISENHOWER. (75 Days.) Huge, strong grower deep rose-pink.

MARGARET FULTON. (Medium—70 Days.) Clear soft rich dark salmon. 6 to 8 perfectly placed florets open.

PICARDY. (Giant—85 Days.) Soft shrimp pink. A blotch of light flesh pink shading to shrimp pink at edges. 7 to 10 florets open at a time.

ROSA VAN LIMA. (Large—75 Days.) Fine light rose pink with a few white lines in throat. 8 or more large well placed blooms open on a tall strong spike.

RED

CHAMOUNY. (85 Days.) Cerise-rose with silver edge.

DREAM OF BEAUTY. (Medium—80 Days.) Large rose red. Tall, strong grower.

JULES AMOTT. (Large—90 Days.) Glistening deep red, 6 to 8 florets open at a time.

NEW EUROPE. (Large—85 Days.) Vivid scarlet red with a small purple stripe in the throat.

STOPLIGHT. Beautiful large glistening deep red.

VALERIA. (70 Days.) Large bright scarlet red.

WHITE

MARGARET BEATON (Large—80 Days.) Pure snow white with small orange scarlet blotch in the throat. 6-8 well placed blooms on long flowerhead.

VREDENBURG. (70 Days.) Large, pure white.

YELLOW AND CREAMS

GOLD DUST. (85 Days.) Fine clear soft yellow.

LADY JANE. (80 Days.) Clear cream with yellow lip, petals give it general appearance of light yellow. Large blooms well placed and of heavy texture, tall and always straight.

SPOT LIGHT. Large, ruffled deep yellow.

WHITE GOLD. (85 Days.) Very large clear light cream shading to a golden throat. Tall and very vigorous.

YELLOW HERALD. (70 Days.) Early, amber yellow, carmine in throat.

ORANGE

BIT O'HEAVEN. (Medium—90 Days.) Beautiful orange color with yellow throat. 9 to 12 medium sized blooms on a tall straight spike.

GLADIOLI

Plant Manns' Gladioli Bulbs. They are strictly 1 1/4 inches or more in diameter, sound, true to name, and can be absolutely depended upon to produce large, beautiful well-formed blooms. (We recommend planting bulbs not over 2 in. in diameter for best blooms).

Cultural Suggestions: Set bulbs 4 inches deep and 6 inches apart, either in rows or massed in beds, borders or among shrubbery. Successive plantings from April to July will bloom from July until frost. They will thrive in any good garden soil, but a sunny location is best. Cultivate frequently and water freely while blooms are forming.

BLUE

BLUE BEAUTY. (Large—85 Days.) Medium light blue with edges overlaid violet blue.

LAVENDER

ELIZABETH THE QUEEN. (Giant—90 Days.) Beautiful clear mauve with darker lines in the throat.

PURPLE

KING LEAR. Ruffled, dark velvety purple.

PURPLE SUPREME. (80 Days.) Tall plant with many well placed bright purple flowers. Silvery edge on the petals. Superb cutflower.

SMOKIES AND OTHER COLORS

BAGDAD (Large—90 Days.) Smoky old rose, 6 to 8 immense blooms at a time.

SILVER GULL. (80 Days.) Silver bluish grey with a creamy blotch. Very distinct.

VAGABOND PRINCE. (Large—75 Days.) Mahogany brown with a glowing flame scarlet blotch on lip petal.

Variety	PRICES		
	Each	Doz.	Per 100
Bagdad	\$.11	\$1.15	\$8.50
Bit O'Heaven	.09	.95	6.50
Blue Beauty	.09	.90	6.00
Chamouny	.09	.95	6.50
Dream of Beauty	.11	1.15	8.50
Elizabeth the Queen	.10	1.00	7.50
Gen. Eisenhower	.12	1.25	9.00
Gold Dust	.09	.95	6.50
Jules Amott	.11	1.15	8.50
King Lear	.09	.95	6.50
Lady Jane	.10	1.00	7.50
Margaret Beaton	.09	.95	6.50
Margaret Fulton	.09	.90	6.00
New Europe	.10	1.00	7.50
Picardy	.10	1.00	7.50
Purple Supreme	.12	1.25	9.00
Rosa Van Lima	.09	.90	6.00
Silver Gull	.13	1.30	8.50
Spotlight	.11	1.10	7.50
Stoptlight	.11	1.15	8.50
Vagabond Prince	.12	1.25	9.00
Valeria	.10	1.00	7.50
Vredenburg	.12	1.25	9.00
White Gold	.09	.95	6.50
Yellow Herald	.10	1.00	7.50

GLADIOLUS MIXTURES

MANNS' SPECIAL VARIETY MIXTURE:

25 Bulbs (mixed) 1 of each listed \$1.75.

100 Bulbs (mixed) 4 of each listed \$6.75.

100 Bulbs, in multiples of 10, your selection at 100 rates

MANNS' SUPERIOR RAINBOW MIXTURE: Made up of varieties which because of their commercial value and reliable flowering qualities are being produced in such large quantities that low prices are made possible.

70c doz.; 25 for \$1.25; 100 for \$4.85

GLADIOLUS NANUS

Interesting early flowering "baby glads"; require plenty of moisture; grow only half size of standard glads.

Amanda Mahy—Salmon Pink \$.75 doz.

Brilliant—Deep Scarlet85 doz.

Byzantinus—Purplish Mauve 1.25 doz.

The Bride—White85 doz.

ROSE BUSHES

U. S. PLANT PATENTED NOVELTIES

— 3 or More, Less 10% —

Patented varieties not listed can be supplied on order at patentees published price.

CHRYSLER IMPERIAL Distinctive brilliant red ..	\$3.00
COUNTESS VANDAL (38) pink with salmon glow..	1.50
ECLIPSE (172) Rich gold.....	1.75
FASHION (789) Floribunda, luminous coral-pink suffused with gold. Winner of six awards.....	2.00
FORTY-NINER (792) Orient-red and chrome-yellow	2.00
FRED HOWARD (1006) Buff yellow, golden orange and pink	2.50
HAPPINESS (911) Brilliant red	2.50
HELEN TRAUBEL (1028) two toned petals, pink flushed apricot	2.75
LOWELL THOMAS (595) Lemon-chrome.....	2.00
MIRANDY (632) Garnet red	2.00
NEW YORKER (823) Fiery red	2.00
PEACE (591) Yellow with edges picoted cerise.....	2.50
SYMPHONIE (958) Huge blooms, silvery pink.....	2.50
VOGUE (926) Floribunda, cherry coral. International award winner	2.25

SELECT EVERBLOOMING HYBRID—TEA

\$1.35 each, any 6 for \$7.25

These standard varieties have stood the test of time, having become popular by their performance in Baltimore gardens.

AMI QUINARD. Blackish maroon.
CALEDONIA. Large, white, very double, long-lasting, slightly fragrant, long stems, hardy.
EDITOR McFARLAND. Solid glowing pink.
ETOILE de HOLLAND. Bright red, large, loose, semi-double, very fragrant.
GOLDEN CHARM. Yellow sport of Talisman.
GOLDEN DAWN. Sunflower-yellow turning to lemon, well-formed. Fragrant, profuse, continuous.
K. A. VICTORIA. Double Pure White.
MRS. P. S. DuPONT. Yellow tinged with reddish gold.
POINSETTIA. Long buds, poinsettia-scarlet.
PRES. HERBERT HOOVER. Maroon and orange, two-tone. Vigorous, upright, free blooming.
RADIANCE. Cameo-pink; large, intensely fragrant. Blooms all season, in all climates. Tall.
RED RADIANCE. Very large, long-lasting; intensely fragrant, clear, even red, tall.
TALISMAN. Golden yellow and copper; long-lasting. free blooming.
THE DOCTOR. Pink, fragrant, long pointed buds.

CLIMBING ROSES

BLAZE. Vigorous, scarlet flowers, recurrent bloomer.	
CLIMBING CRIMSON GLORY	\$2.25
CLIMBING PEACE	2.75

DAHLIAS

Dahlias do well in almost any kind of soil, but thrive best in a medium loam. The tubers should be planted in a horizontal position, with the sprout up and about four inches below the surface; they should be set three or four feet apart each way, in deeply spaded soil. Mulch with peat moss and allow only one shoot to stand. A good plant food applied just as the buds start to form will increase the size and improve the color of the blooms. If large exhibition blossoms are desired, it is absolutely necessary to disbud. After the frost has killed the flowers, the roots should be removed from the ground, allowed to dry for two or three days, and then stored away in peat moss in a cool, dry, dark place, where frost will not reach them.

A—8 to 12 inches	B—4 to 8 inches
M—Miniature 2 to 4 or 6 inches	
C—Cactus	ID—Informal Decorative
SC—Semi-Cactus	FD—Formal Decorative
STC—Straight Cactus	IC—Incurved Cactus

ADA N. (ID-A) Purple. \$1.00 each.
ARTHUR GODFREY (FD-A) Orange Blend. \$2.00 each.
BLUE ORCHID (ID-A). Lavender. 75c each.
CHEROKEE BRAVE (ID-A). Dark red. 60c each.
ELEANOR K. (SC-A). Yellow, prize winner. \$2.00 each.
FIVE STAR GENERAL (FD-A). Pink with yellow. \$1.00
J. A. KERNOCHE (FD-A). Red and white. 50c each.
JANE COWL (ID). Orange. 35c each.
JANE LAUSCHE (SC-A). Lavender and white. 75c each.
JERSEY BEAUTY (FD). Pink. 35c each.
JIM MOHR (FD). Extra large, salmon pink. 60c each.
KELVIN (ID-A). Pink. 75c each.
KELVIN SUNRISE (IC-B) Yellow, red tip. 50c each.
LAVENDER GLORY (ID). Lavender. 50c each.
LEMON DROP (ID-M). Yellow. 25c each.
MARILYN DALE (SC-A) Fuchsia rose. \$1.50 each.
MICHIGAN WHITE (SC-B). \$1.00 each.
MRS. HESTER A. PAPE (ID-A). Red. 75c each.
POT-O-GOLD (FD). Beautiful golden yellow. 85c each.
PRINCE OF PERSIA (ID). Red. 50c each.
RALEIGH (ID). Miniature, Pink. 50c each.
RED TOP (POMPOM). Yellow and red. 25c each.
SHERWOOD PEACH (ID-A). Orange and red. 60c each.
SON OF SATAN (C). Bright scarlet. 50c each.
SUNSHINE (ID-A). Large yellow. 50c each.
VICTORY (FD-A). Pink. 50c each.
VIRGINIA RUTE (SC-B). \$1.00 each.
WHITE FAWN (FDM). White. 30c each.



Spray Guide

INSECT OR DISEASE	DESCRIPTION	MATERIAL TO USE (See List)	WHEN TO APPLY
Ants	Sweet or grease eating.	Magikill—J	When ants appear.
Aphis	Small green, red or black lice feeding on the tender terminal growth of many plants.	C—E—X	When pests first appear. Wet insects thoroughly. Repeat as necessary.
Asparagus Beetles	Olive colored, both adults and grub like larvae.	A—E—N—S—X	When grubs first appear, preferably when plants are wet with dew.
Bag Worm	Builds ½-inch to 2-inch tapering bag-web.	A—M—P—X	When insects first appear or when evidence of feeding is observed. Repeat as needed.
Bean Beetles	Copper-colored beetles with eight black spots. Yellow larvae, which also devour leaves.	E—K—M—N—S	When pests first appear.
Black Rot	(Grapes) Fungus disease. Shows first as small white spots, later surrounded by brown ring.	B—F—G—L—Q	When leaf buds first open. When shoots are 10 to 15 inches long. Just after blossoms fall.
Blights	Bacterial disease that attacks young shoots and leaves, causing brown or black spots and sudden wilting.	B—F—Q—T—Y	Make first application when growth starts in spring. Repeat weekly until plants start blooming.
Brown Canker	Disease which develops small purple spots on stems and leaves of roses, later turning to light center with purple margin.	B—F—Q	As above.
Cabbage Looper Cabbage Worm	Pale green-white, striped caterpillar. Doubles or loops as it crawls.	A—E—N—S—X	When larvae first appear.
Caterpillars	Woolly or naked. Feed on leaves.	A—E—M—P—S—X	When insects first appear or when evidence is observed. Repeat as needed.
Celery Leaf Tier	Pale green or green striped caterpillars.	A—E—P—X	When first appears.
Corn Earworm	Green worm which eats into ears of corn.	A—M—D—S Corn Earworm Drops	Apply to silk when it first shows through the tips of each ear. Repeat two or three times within week.
Cucumber Beetles	Yellow and black striped.	A—E—I—S—X	When vines begin to run. Repeat at frequent intervals.
Cut-Worms	Destroy plants by cutting stems.	Snarol	When first appear.
Damping Off	Causes plants to suddenly wilt as though rotted at the ground level.	Semesan Formaldehyde	Treat seed or soil.
Downy Mildew	White, down mold on pods of lima bean, or under side of melon leaves.	B—F—S	At weekly intervals.
Flea-beetles	Extremely small black beetles on blades of grass.	J	During warm weather.
Grape Berry Moth	Lays eggs from which small worm develops in fruit.	E—S	Just after blossoms fall. Repeat at monthly intervals until July.
Grubs	White or colored larvae.	A—D—J	Apply to soil, Fall or Spring.
Horn (Tomato) Worms	Large green worms.	A—E—N	When bugs or worms first appear.
Japanese Beetles	Bronzy-green about ½ inch long.	J	When first appear.
Leaf Beetles	Yellow beetles with twelve spots on wings.	A—E—N—S—X	When pests first appear. Repeat at weekly intervals.
Leaf Hoppers	Small greenish insects that suck plant juices.	C—E—N—X	When pests first appear. Repeat as necessary.
Leaf Spot	Fungus disease causing brown spots on leaves.	B—F—Q	Repeat at intervals.
Mealy Bug	White, cottony appearance.	E—V	Every few days until under control.
Mites	Very small sucking insects on azaleas, Holly, etc.	H	Protect new growth and repeat as necessary.
Potato Bug or Blister Beetles	Gray, black or striped beetles up to ¾ inch long.	A—D—P—X	Spray or dust plants as soon as they break through and every ten days thereafter.
Powdery Mildew	White growth on leaves.	B—F—Q	When white growth makes its appearance.
Red Spiders	Small mites that feed on foliage, causing it to assume a rusty appearance.	H—V	When pests first appear; on strawberry use Strawberry Dust (85-15).
Rose Beetle	Long-legged clay-colored beetles on roses and peonies.	A—E—S—X	When pests first appear. Repeat at weekly intervals.
Rust	Orange-colored pustules (fungus) in streaks or patches on leaves or stems.	B—Q—V	When first appears, or early and weekly as a preventative.
Scale	Attacks bark of tree.	L—R	As late dormant spray.
Spittle Bug	Bug surrounded by foamy substance.	D—C—E—J	When first appear. Spray must penetrate foam, repeat as necessary.
Thrips	Tiny winged or wingless insects that rasp leaves and suck juices from plants.	D—C—E—X	When pests first appear. Repeat as necessary.
White Flies	Small whitish flies. In larval stage, tiny, scale-like, greenish objects.	E—O—V	When pests first appear. Repeat as necessary.

LIST OF MATERIALS INDICATED IN ABOVE CHART

A—Arsenate of Lead.
B—Bordeaux, Kopper King.
C—Black Leaf 40.
D—DDT.
E—*D-X, Red Arrow, Evergreen.
F—Dusting Sulphur, Fungtrogen.
G—Grape Dust.
H—Kilmitc.

I—Cucumber-Mellon Dust
J—Chlordane.
K—Kryacide.
L—Lime and Sulphur Solution.
M—Garden Guard.
N—*Rotenone Dust.
O—*Fish Oil Soap.
P—Paris Green, Red River Potato Mix

Q—Sulfocide.
R—Scalecide.
S—*Slug Shot.
T—Tomato Dust.
V—Volck, Emo.
X—Nicotine-Pyrox.
Y—Dithane.

Materials marked (*) are non-poisonous when used as directed. Pyrethrum and Rotenone base materials such as DX and Red Arrow are contact sprays and must strike the insects to be effective.

D.D.T. Controls: Flies, Mosquitoes, Gnats, Horn Flies, Lice, Fleas, Sheep Ticks, Ants, Wasps, Hornets, Codling Moth, Mealy Bug, Japanese Beetle, Leaf Hoppers, Oriental Fruit Moth, Peach Borer, Rose Shafer, Cabbage Worm, Flea Beetles, Onion Thrips, Tomato Fruit Worm, Caterpillars, Boxwood Leaf Miners and many others. Ask for special DDT folder and use with caution.



ALL ROUND SPRAY

For roses, azaleas, shrubs, vegetables, vines, other flowers. A carefully formulated multi-purpose product designed to provide protection against both insects and fungi such as rose chafer, azalea flower spot, thrip, black spot, downy mildews, leaf spot, many rusts, aphids, cabbage worm and many others. For dusting as well as spraying. Lb. \$1.10; 4 lbs., \$3.50.

mildews, leaf spot, many rusts, aphids, cabbage worm and many others. For dusting as well as spraying. Lb. \$1.10; 4 lbs., \$3.50.

ANTROL SET
Set 40c
Individual feeders
Each 10c
ANTROL SYRUP
4-oz. bottle 20c



ANTROL SPRAY (Chlordane)
with sprayer. 89c pint; \$1.19 qt.

ANTROL ANT TRAPS
25c Each
ANT-X
25c Each
ANT-X JHLLY
1 oz., 38c
MAGWELL JHLLY
1 oz., 40c;
3 oz., \$1.00



ARSENATE OF LEAD
(1 lb. makes 25 to 35 gallons)

For fruit trees, vegetables, bushes and tobacco. Can be used as dust or spray. To control Japanese Beetle grub on lawns apply 1 lb. to 100 sq. ft. 1-lb., 65c; 4-lb., \$1.80.



ARSENITE OF ZINC
(1 lb. makes 50 gals.)

Ranks next to Paris Green in strength. It has gained considerable popularity in certain sections for use on potatoes and other hardy ground crops to destroy chewing insects. Mixes well with Lime Sulphur solution which is used to combat psyllid on potatoes. 1 lb., 40c; 4 lbs., \$1.15.



BENEO-FUME POWDER PRESSURE FUMIGATORS
Especially recommended for control of greenhouse red spider. 1/2 lb. size for 5,000 cubic feet of air space.
50c ea.; 12 for \$3.20
75c ea.; 12 for \$5.50

"BLACK LEAF 40"
(1 oz. makes 6 gallons)
Oz., 36c; 5 oz., \$1.05; 1 lb., \$2.42;
2 lbs., \$4.15; 5 lbs., \$7.40; 10 lbs. \$12.65.

BORDEAUX MIXTURE
(1 to 2 lbs. makes 12 1/2 gallons)

Prevents large losses caused by blight, rot, mildew, scab, anthracnose and certain other fungous diseases. It stimulates plant growth and greatly increases the harvests. 1 lb., 50c; 4 lbs., \$1.35.



CALCIUM ARSENATE
(1 to 2 lbs. makes 50 gals.)

Calcium Arsenate is the cheapest arsenical insecticide on the market but of great economy and efficiency for certain purposes. Recommended to combat chewing insects on potatoes, vegetables, cotton and certain fruit trees. 1 lb., 35c; 4 lb., \$1.00.



CARBOLA—WITH LINDANE

Carbola applied to the walls, ceilings, partitions, nests, etc., of your poultry houses will help to prevent contagious diseases among your flock. 5 lbs., 85c; 10 lbs., \$1.35; 50 lbs., \$5.50.

CARBOLINBUM—AMERICA
Kills chicken mites and blue bugs in poultry houses, makes wood Termite proof and Stops Rots. Gal. \$2.15.

CARBON DI-SULPHIDE
For control of insects in grain; 1 qt. per 100 bu. Qt., 65c; gal. (approx. 10 1/3 lbs.), \$2.00



CATALIZER
A combined adhesive and spreader, making spray materials more economical and effective, inexpensive. Use 2 pounds to each 100 gallons of spray. 2-lb. pkg., 90c.

5% CHLORDANE DUST
Do not use on food crops
1 lb. canister, 40c; 5 lbs., 75c.

40% CHLORDANE
(Wettable Powder)
4 lb., bag, \$2.85.

46% CHLORDANE EMULSION
Quart, \$2.50.

6% CHLORDANE DUST
1 lb., 65c; 4 lb., \$1.50.

SYNKLOB 48-E
1/2 pt., \$1.25; gal., \$3.00.

COPPER ARSENATE
(Basic) 4 lbs., \$2.00

COPPER DUST
Duo-copper 7%—5 lbs., 85c;
50 lb. bag, \$5.00

COPPER SULPHATE
(Blue Stone)
Powdered: 30c lb.; 5 lbs., \$1.15; 10 lbs., \$2.00.

CORN EAR WORM DROPS
(2 ozs. treats 100 ears)
2 oz., 35c; quart, 85c.

CROW REPELLENT
NO-CROW—Treat corn and other seeds to repel crows, birds, moles, etc. Economical and easy to use. Liquid, 1/2 pt., 50c; pt., \$1.00.

CUCUMBER—MELON DUST
1% Rotenone, 3.9% Zineb
Lb., 50c; 5 lbs., \$1.50; 50 lbs., \$10.50



CYANOGAS ANT KILLER—A gas-producing powder. 4-oz. spout can is enough to treat ant nests in average lawn. 40c.

CYANOGAS A-DUST — Kills rats, moles, woodchucks (groundhogs) and other rodents instantly. "It's the gas that kills 'em." 1 lb., \$1.00; 5 lbs., \$3.85.

CYANOGAS G-FUMIGANT — Most widely used greenhouse insecticide. Regular use insures insect-free house all season. 5 lbs., \$3.85; 25 lbs., \$12.90.

D.D.T. (Liquid)
30% — pt., \$1.00; qt., \$1.85; gal., \$4.75.

Wettable Powder 50% D.D.T. (Garden). One tablespoon makes 1 gallon.
1 lb., 75c; 4 lbs., \$2.35.

D.D.T. (Dust)
10%—Lb., 40c; 50 lb. bag, \$7.50.

5% D.D.T. DUST
5 lbs., 85c; 50 lbs., \$5.00.

DDT HOUSEHOLD SPRAY 5%
Qt., 65c; gal., \$1.80.

DE-K-PRUF
A compound that makes wood and fabrics immune to attack against 400 sq. ft. wood, 20 lbs. fabric. Color, green. Gal., \$2.85; 5 gallons, \$13.50. mildew, rot, termites and other wood destroying insects. One gallon covers

DIMITE
2 oz., 70c; Quart \$5.00.

Dusting and Spraying Materials (Continued)



REG. U.S. PAT. OFF.

DU PONT DORMANT SPRAY OIL
1 qt. makes 18 gal., \$1.15.

DU PONT FERMATE FUNGICIDE
8 oz., makes 20 to 38 gal., 75c;
3 lb., \$2.25.

DU PONT FLORAL DUST
8 oz., 79c; 1 lb., \$1.15; 3 lb., \$2.65.

DU PONT FRUIT TREE SPRAY
1 lb. makes 13 gal., \$1.15; 3 lb. makes
39 gal., \$2.75.

DU PONT FUNGICIDE-A (Parzate)
6 oz. makes 20 gal., 85c.

DU PONT 50% METHOXYCHLOR (Marlate)
(Wide range—low toxicity)
8 oz. makes 15 to 32 gal., 75c;
4 lb., \$3.40.

DU PONT ROSE DUST
8 oz. Dust Gun, 69c; 1 lb. Canister,
\$1.00.

DU PONT TOMATO DUST
As Spray, 2 lb. makes 10 gallon. 8 oz.
Dust Gun, 69c; 2 lb. Bag, 85c.

DU PONT VEGETABLE GARDEN DUST
8 oz. Dust Gun, 79c; 1 lb. Canister,
\$1.15; 3 lb. Bag, \$2.65.

SEED DISINFECTANTS

ARASAN—For dry application to prevent seed decay and damping off of corn, peanuts, sorghum, vegetables, grains and legumes.
¾ oz., 25c; 8 oz., \$1.00; 2 lbs., \$3.20.

SEMESAN—For vegetable and flower seeds. One ounce to 15 to 30 lbs. seed. ¼ oz., 20c; 2 oz., 60c; 12 oz., \$2.85.

SEMESAN, JR.—For corn, 2 ounces to 1 bushel corn. 12 oz., 62c.

SEMESAN BEL—For potatoes. 1 lb. to 60-80 bu. potatoes. 2 oz., 50c; 1 lb., \$2.30; 4 lbs., \$7.50.

CERESAN (New Improved)—For wheat. ¼ oz. for 1 bu. seed. 4 oz., 50c; 1 lb., \$1.30; 4 lbs., \$4.35.

CERESAN M. For small grains and peas. 14 oz., \$1.25; 3 lb., \$3.55.

DITHANE Z-78

A versatile fungicide that can be used as spray or dust on potatoes, tomatoes, celery, cantaloupes, cucumbers, beans, azaleas, gladiolus and for the control of blue mold on tobacco seedlings. 3 lb. pkg., \$3.00.

DOG REPELLENTS

CHAPERONE. 4 oz., 60c; 12 oz., \$1.25; qt., \$3.00.

DOG CHECK. 3 oz., 60c; 8 oz., \$1.00.

DOG SKAT. 4" tube. Hang on trees or shrubs. The odor does the work. Dogs and cats hate it. 50c ea.; 6 for \$2.50.

DOGKOFF. 3 oz., 60c.

FUMEOGEN. 8 oz., 50c.

REPELLENT ROPE. Emits odor repugnant to wide range of animals. Non-poisonous, non-injurious to hands and harmless to pets. Protect vegetable gardens by placing rope on ground around entire garden. Circle flower beds and shrubs. Protect bulbs by burying the rope in 3 inch trench around the bed. 100 ft., \$1.50.

DX SPRAY

(1 oz. makes 6 gallons)

A rotenone-pyrethrum-D.D.T. spray in an active vegetable oil base for control of sucking and chewing insects on fruit trees, shade trees, vegetables and flowers. 1 oz., 35c; ½ pt., \$1.75; qt., \$5.50; gal., \$14.50.



EMO

(1 pt. makes 4 gallons)

A summer oil spray of fine quality, safe to use, pleasant to handle and of the much desired flowable consistency. Recommended as a contact spray in the control of White Flies, Rust Mites, Blister Mites, Mealy Bugs, Red Spiders, certain scale and other insects. 8 oz., 30c; pt., 50c; qt., 70c.



EMO-NIX

(1 pt. makes 12½ gallons)

Complete contact spray combining nicotine in its most active form with EMO a summer oil emulsion. 4½ oz., 45c; pt., 90c; qt., \$1.40.



KILL PLANT INSECTS



35¢
EVER GREEN GARDEN SPRAY

THE EASY WAY . . . Simply dilute with water in accordance with directions and spray, hitting the insects to be controlled. Non-injurious when used as directed. Deadly to many common varieties of both chewing and sucking insects (1 oz. makes 6 gallons). 1 oz., 35c; 8 oz., \$1.15; pt., \$2.45; qt., \$4.10; gal., \$12.60.

FISH OIL SOAP

Keeps trees, plants and vines clean and healthy, effectively controlling sucking insects and many forms of scale. 1 lb., 45c; 5 lbs., \$1.75.

ACME SPRAY SOAP—1 lb., 45c.

FORMACIDE FORMALDEHYDE DUST

Is a seed and soil treating compound which controls seed borne diseases and when applied to the soil controls "damping off" and other root rots of vegetable and flower seedlings. Usually applied 1 lb. per 10 sq. ft. 1 lb., 85c; 5-lb. can, \$2.50.

FRUIT SPRAY OR DUST

1 lb. makes 6 gallons

Contains Methoxychlor, Ferbam, D.D.T. and Sulphur. Controls insects and diseases. 2 lb., \$1.25.



An effective and scientific preventive and remedy for mildew, black spot and many fungus diseases of Roses and other plants. Dilute one part to 60 parts water. ¼ pt., 75c; pt., \$1.25; qt., \$2.00.

GARDEN AND ROSE DUST

An all-purpose product for controlling the majority of sucking and chewing insects and fungus diseases on all flowers and vegetables—especially effective on roses. 1 lb. Dust Gun, \$1.35; 2 lb. Canister, \$1.65.



GRAPE DUST

A readily diffusible, lightweight powder fungicide, very efficient in destroying mildews and preventing blights. 1 lb., 40c; 5 lbs., \$1.50.



KILMITE (20% TEPP)

Tetra-ethyl-pyrophosphate; kills 17-year locust. Controls red spider and Azalea mites. 2 teaspoons per gal. water. 4 oz., 60c; 1 qt., \$4.50; gal., \$12.50.



KOPPER KING

(1 to 2 lbs. makes 50 gals.)

(Basic Copper Sulphate)

1 lb., 75c; 4 lbs., \$2.00.

Dusting and Spraying Materials (Continued)

KRYOCIDE D-50. Dust mixture containing sulphur. 1 lb., 50c; 3 lbs., 85c.

KRYOCIDE C. With copper. Can be used as a dust or spray. If as a spray 3 tablespoons to 1 gallon water. 3 lbs., 90c.

LIME AND SULPHUR SOLUTION
1 gal., 95c; 5 gal., \$3.25.

DRY LIME AND SULPHUR
Dormant Season: 12 lbs. to 50 gallons.
Growing Season: 3 lbs. to 50 gallons.

For use in dormant spraying against scale, peach blight, leaf curl and twig borer. Summer spraying against scab, soot, blotch, red spider and mite. 1 lb., 60c; 12½ lbs., \$3.85.



LINDANE INDUSTRIAL
Pt., 50c; qt., 85c.

LINDANE 25% WETTABLE
1 lb. makes 50 to 100 gal., \$4.00.

LINDANE SPRAY 5%
Controls most all common insects 3 ways—when eaten—by contact—by fumes; protects foliage and flowers indoors and out (non-discoloring). Recommended as a safe residual spray for fly control. 4 oz. (makes 6 gal.), 80c; pt., \$2.70.

MAGNESIUM ARSENATE
Dust Mixture. 4 lb., pkg., 60c; 100 lbs., \$12.00.

MARVEL SPRAY
4 oz., \$1.00; ½ pt., \$1.75.

MOLE-NOTS
Protects lawns, gardens, flower beds, golf courses, etc. No traps, ready to use. Pkg. of 8, 35c; pkg. of 50, \$1.00.

MOLOGEN

Patents Pending

Destroys moles quickly, easy to use. No odor or gases. Harmless to soil or grass. ½ lb., 50c; 1½ lbs., \$1.25.

"NICO-FUME" POWDER PRESSURE-FUMIGATOR
Improved quality; burns under pressure in special container; more effective and more economical than old methods. Use at approximate rate of 1 lb. per 20,000 to 30,000 cu. ft. of air space.

½ lb., 55c ea., 6—\$2.80, 12—\$4.60
1 lb., 85c ea., 6—\$4.60, 12—\$7.95

ORTAZOL POWDER (Dinitro)
Use in the dormant period to control aphid eggs, bud moth and other pests. Mixes easily in cold water. Use 1 to 2 lbs. in 100 gallons of spray. Lb., 75c.



PARIS GREEN
(1 lb. makes 30 gal.)
A rich, emerald color and of fine fluffy physical character. Containing 55% arsenious oxide, it will give quickest control where extreme measures are necessary. ¼ lb., 25c; 1 lb., 75c; 5 lbs., \$3.35.

PEACH BORER CONTROLS PARA-SCALECID
(1 gallon to 7 gallons water)
(Use 1 pint solution to each three-year-old tree.)
Is effective and safe on young or old trees. Qt., \$1.45; gal., \$3.25.

PARA-DICHLOROBENZENE
Apply September 1st to October 10th, according to latitude. Some growers prefer to make two applications, the first being in the month of June. One pound is sufficient for 10 to 30 trees, according to size. It is not advisable to treat trees under 4 years of age, and apple trees should never be treated. 1 lb., 50c; 5 lbs., \$2.00; 25 lbs., \$7.50; 100 lbs., \$24.00.

PARATHION DUST 1%
Excellent control for wide variety of insects. Kills quickly with no harmful residue. Very dangerous however to humans and animals when being applied—use only with protecting mask. 100 lbs., \$3.45.

PESTEX (Pest Repellent)
Does not kill but repels dogs, rabbits, squirrels, moles, rats, mice, starlings, pigeons, crows, etc. 2 lbs., \$1.00.

PHYGON (Wettable)
A fungicide for the control of all Leaf Blights and Fruit Rot of Tomatoes, Black Spots of Roses, Apple Scab and many other plant diseases caused by fungi. A seed protectant to be dusted on Beets, Tomatoes, Spinach, Swiss Chard, Peppers and other seeds, before planting to prevent decay and "damping-off." 4½ oz., \$1.00.

POMO-GREEN
With Nicotine—1 lb., \$1.00.

PRUNING PAINT
Hammonds, ½ pt., 65c.

PYROX (With Nicotine)
It not only kills leaf-chewing insects, prevents blight and other diseases, but it also kills sucking insects, such as aphids, thrips, and leaf-hoppers. 20 oz., 60c; 5 lbs., \$2.25; 25 lbs., \$8.50; 50 lbs., \$13.50.

RED ARROW
1 oz. makes 8 gal.
Economical and efficient contact spray, non-poisonous, will not injure blossoms, foliage or fruit; positive death to almost all types of insects. 1 oz., 35c; 4 oz., \$1.00; 1 pt., \$2.85; qt., \$5.00; gal., \$18.20.

RED RIVER POTATO MIX WITH D.D.T.
(Special Formula for Potatoes Only)



(1 to 1½ lbs. makes 12½ gals., or as dust)
A copper fungicide with quick-killing arsenic. Kills potato bugs quicker, drives off flea beetle and leaf-hopper, prevents blight from gaining a foothold, stimulates foliage, making more and better potatoes. 1-lb. bag, 80c; 4-lb. bag, \$2.60.

ROSE DUST
Controls insects and diseases. 1 lb., 60c; 5 lbs., \$1.85.

ROSE SPRAY
Lindane-Roteneone
Aerosol 12 oz., \$1.69.

ROTENONE DUST
Strictly non-poisonous and proven to be the most practical, effective and economical insecticide for the control of insects attacking vegetable crops. Contains ¼% Roteneone, plus all the toxic (killing) ingredients of the rotenone bearing roots. Should be used at rate of 15 to 25 lbs. per acre or as a spray 1 lb. to 10 gallons. 1 lb., 25c; 5 lbs., 85c; 50 lbs., \$4.85.

1% Roteneone—50 lbs., \$5.75; (Tubacide) with sulphur, 50 lbs., \$6.00.
Let us quote larger quantities.

ROTENONE GARDEN GUARD
(1 lb. makes 10 gallons as spray, 15 to 25 lbs. per acre as dust.)
1-lb. sifter carton 50c; 4-lb. bag, \$1.00.

ROTENONE GARDEN SPRAY
(NNOR) Containing Roteneone kills most common garden bugs of both sucking and leaf eating types. 1 oz., 35c; 6 oz., \$1.00; 16 oz., \$2.15.

SCALE-TOX
Dormant spray, miscible oil—Qt., 60c; gal., \$1.35; 5 gal., \$7.00.



SCALECID
(1 gallon to 15 gallons water.)
Qt., \$1.15; gal., \$2.75.
5 gals., \$9.30; 15 gals., \$22.00; 30 gals., \$35.60; 55 gals., \$53.00.

SELOCIDE
1 gallon makes 100 to 400 gallons. Kills Red Spider. Gal. \$3.00.

SLUG SHOT
Guaranteed to destroy potato bugs, cabbage worms, lice, fleas, beetles, striped bugs, etc., on currants, egg plants, melons, turnips, beets, etc.; canker worms and caterpillars on fruit and ornamental trees.
1-lb. sifter, 50c; 5-lb. pkg., \$1.95.



Dusting and Spraying Materials (Continued)

SNAROL

Sure death to snails and slugs. Harmless to vegetation, not affected by rain or sprinkling.

1 lb. 35c; 2½ lb., 75c; 6 lb., 1.65; 50 lbs., \$10.75.



SNAROL CUTWORM BAIT

Contains toxaphene. 1 lb., 50c; 6 lbs., \$2.00; 50 lbs., \$13.00.

SPERGON

A seed protectant in powder form to be applied to seed before planting to prevent seed decay and "damping-off," particularly in cold wet weather. Recommended for Peas, Beans, Lima Beans, Corn. It is easy to apply to the seed and non-injurious to the user. 1 oz., 25c; 5 oz., \$1.00; 1 lb., \$2.25.

GLADIOLUS DUST

2 oz., 25c; 1 lb., \$1.50.

STRAWBERRY DUST

Repels red spiders, stops clippers cutting off the blossoms. 10 lbs., \$1.85; 25 lbs., \$3.00; 100 lbs., \$8.50.

SULFOCID

(1 quart to 50 gallons water.)

Sulfocid is a highly concentrated non-poisonous liquid sulphur fungicide—entirely distinct from lime sulphur.

Pt., \$1.00; qt., \$1.50; gal., \$3.00; 5 gals., \$9.75; 15 gals., \$24.00; 30 gals., \$42.00; 55 gals., \$70.00.



SUMMER SPRA-CREAM

A stabilized 83% summer oil emulsion for foliage spraying of fruit trees, shade trees, and evergreens. Used as a sticker for arsenate of lead and bordeaux sprays. (Do not use with sulphur.) Gal. \$2.00.

SULPHUR (DUSTING)

(An Excellent Chigger Chaser)

(2 lbs. makes 35 gallons; or as dust)

Recommended to control mildew, leaf spot, black spot and rust on rose bushes, chrysanthemums, snapdragons, carnations, also red spiders on evergreen. 2-lb. carton, 59c.

SULPHUR

Commercial Flour of Sulphur. 10 lbs., 75c; 25 lbs., \$1.50; 100 lbs., \$4.50.

Superfine Dusting Sulphur. 10 lbs., 75c; 25 lbs., \$1.50; 50 lbs., \$2.75.

SULPHUR (DITOMIO)

5-lb. bags, 75c.

TEROGEN

Especially recommended for the fall treatment of roses. 10 lbs., \$4.75; 25 lbs., \$11.00; 100 lbs., \$40.00.

TOBACCO DUST

Excellent insecticide and fertilizer combined, extensively used against black and green aphids, fleas, beetles, etc. 1 lb., 10c; 10 lbs., 50c; 100 lbs., \$3.75.

TOMATO DUST ACME

1-lb. sifter top, 60c.
4-lb. bag, \$1.50.

PRATT'S

1-lb. sifter, 45c.
5-lbs., \$1.25.

DI-C7

1% DDT—7% Copper
5 lbs., 75c; 50 lbs., \$5.50.



TREE BANDING COMPOUND



ACME STOP—Used to band trees, shrubs and vines; prevents insects from crawling up to the foliage. 6 oz., 50c; 1 lb., \$1.05.

Weed Killers

CRAIG HERBICIDE 1

At rate of 2 to 3 lbs. per acre (mineral soils), 5 to 6 lbs. per acre (organic soils) it kills weed seeds in the process of germination. Controls such weeds as chickweed, purslane, carpetweed; and crabgrass, for periods of two to four weeks depending upon climatic conditions. Harmless to foliage. 8 oz., \$1.65; 2 lbs., \$5.00.

DUPONT AMMATE

Poison ivy weed killer. 1 lb. to 1 gal. water treats 100 sq. ft. 2 lbs., \$1.00; 6 lbs., \$2.70.

HAMMOND'S



Easy and economical to use. One gallon added to 40 gallons of water makes sufficient treating liquid to effectively cover about 1,000 sq. ft. Not malleable. Qt., 70c; gal., \$2.00.

ACME—Qt., 90c; gal., \$2.40.

BARWEED

A 2,4-D weed killer and when applied to weed foliage kills the plant by starvation without harming common grasses. Economical and easy to use.

8 oz. makes 8 gal. treats 1600 sq. ft., 75c.

WEEDONE (New Improved)

Contains powerful 2, 4, 5-T and 2, 4-D, the two most effective chemicals for killing lawn weeds, poison ivy, poison oak, honeysuckle and over 90 other weeds and woody plants with-

TRI-GEN

(Contains FERMATE)

A "Three Way" plant treatment.

Insecticide protection against chewing and sucking insects; fungicide protection against powdery mildew and black spot; plus plant stimulants. Especially recommended for Roses, Asters, Snapdragons, Chrysanthemums, and many other plants including vegetable garden produce.

E Economy Kit (makes 8 qts.) \$1.50

A Small Kit (makes 16 qts.).. 2.35

B Medium Kit (makes 64 qts.).. 6.00

C Large Kit (makes 32 gal.)... 9.00

TRI-GEN DUST

General purpose three-way insecticide-fungicide dust. 5 lbs., \$5.00.

VEGETABLE DUST OR SPRAY

(Pratt's)

Combined insecticide and fungicide containing rotenone and copper. Effective and safe. 1 lb., 75c; 3 lbs., \$1.35.

VOLCK

Oil spray for use against certain mealy bugs, scale insects, red spiders, white flies. 4 oz., 35c; 16 oz., 70c; gal., \$2.85; 5 gal., \$9.95.

out killing the grass. Non poisonous to animals or humans. Prevents re-sprouting of tree stumps. 8 oz., \$1.00; 1 qt., \$2.75; 1 gal., \$6.95; 5 gal., \$25.00.

Weedone Sprayer59c ea.

WEEDUST

The new 2,4-D Weed Killer in dry powder form. No mixing with water, no spraying, just one shake for each dandelion, plantain or other ugly weed. 12 oz., 75c.

WEEDONE BRUSH KILLER 32

Kills a greater range of weeds and woody plants than either 2,4-D or 2, 4, 5-T spray used alone. No vapor injury to nearby susceptible crops. Prevents re-sprouting of stumps. 1 qt., \$3.95; 1 gal., \$8.70; 5 gals., \$41.25.

WEEDONE Concentrate 48

An economical formula for the hard-to-kill weeds. It is soluble in water for ground spraying and miscible with oil for airplane spraying. Gal., \$5.63; 5 gal., \$26.90.

P. C. CRAB GRASS AND CHICK WEED KILLERS

Crab-Nott (Standard) 86%. 4 oz., \$1.00; 16 oz., \$2.95; 6 lbs., \$10.95. (Special—containing 2,4-D). 4 oz., \$1.25; 16 oz., \$3.50; 6 lbs., \$12.50. Weedone (46% Potassium-Cynate). 6½ oz., \$1.00; 26 oz., \$3.00; 6½ lbs., \$8.85.

Millers (76% Potassium-Cynate). 16 oz., \$2.20; 4 lbs., \$8.00.

Sprayers



64D



310G



SMITH NEW STREAMLINE BLIZZARD CONTINUOUS SPRAYER

14G



INSECT-O-GUN



711A

INSECT-O-GUN

No pumping, attaches to water hose. One filling sprays 3 gallons. \$5.95.

- HUDSON**
- 9—Favorite, 1½ gal., galv. \$9.90
 - 291G—Booster, 3½ gal., galv. 7.60
 - 220G—Bugweiser, 2½ gal., galv. 6.96
 - 293G—Leader, 3½ gal., galv. 9.60
 - 335G—Climax, 3½ gal., galv. 11.20
 - 341G—Climax, Jr., 2½ gal., galv. 11.20
 - 310G—Perfection, 4 gal., galv. 13.20

FLAME SPRAYER

- 711A—3½ gal., galv. \$24.00

BROWN OPEN-HEAD

- 68D—3 gal., galv. \$12.30
- 64D—4 gal., galv. 13.75

KNAPSACK

- Champion No. 1—All brass 4½ gal. \$31.78
- 347G—Du-More, (Knapsack) 4 gal., galv. \$32.40



SINGLE ACTION

- 222—Vapor, pint, tin \$.44
- 403—Master Fog, quart, tin70
- 3G—Smith, quart, galv. 1.15
- 205—Bantam, 5 oz., glass29
- 26S—Lowell, 8 oz., tin40
- 409—Rapid, 2 qt. tin. 1.40

BUCKET PUMPS

- No. 12—G.S. Junior \$6.95



HAYES-ETTE \$3.45

HAYS, JR. \$8.45

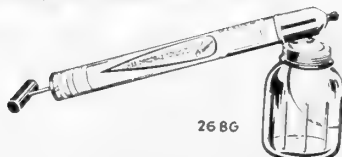

268G

CONTINUOUS SPRAYERS

- 428—Critic, 24 oz., Glass. \$1.90
- 447—Eclipse, 1 qt., Stainless Steel. 4.00
- 431—Comet, quart, tin. 1.10
- 433—Mercury, quart, tin. 1.50
- 436—Cardinal, 3 qt., galv. 2.00
- 268G—Brown, 1 qt., tin, glass jar. 2.35
- 14Q—Blizzard, 1 qt., copper. 4.85
- 3F—Bronx, 1 pt. glass bottle. 1.90
- 8Q—Bronx, 1 qt. glass bottle. 2.10
- 560—Chapin, 24 ounce glass jar. 1.75

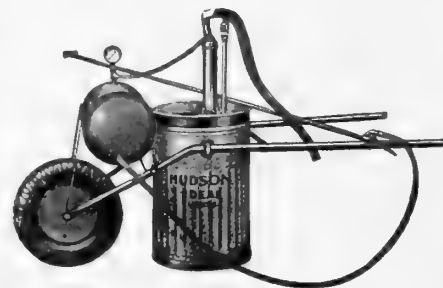

HUDSON IDEAL SPRAYER

- 3505—Hudson With Pressure Tank. 18 gallon galv. tank and operated with a large removable barrel pump. Discharge equipment consists of 10 ft. spray hose, 3 ft. extension rod and angle spray nozzle (Illustrated). \$77.20
- No. 3504—Cushion Tire 66.00
- No. 3503—Steel Wheels 59.60
- 3603—Sunshine, 12½ gal. cap. 30.00

HUDSON POWER SPRAYER

No. 1044H—Defender—15 gallon heavy gauge, galvanized steel tank with open top, drain plug in bottom of tank. 1½ g.p.m. discharge. 0 to 250 pound pressure gauge. 1 h.p. engine. Cushion tired wheel, 16" x 2" overall. Positive piston pump, mechanical and over-flow agitation. Rugged frame of steel pipe. 10 feet of ¾ inch Kem-Oil (oil- and chemical-proof) spray hose and adjustable spray gun \$189.50

Dusters

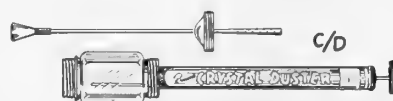

BROWNS CRYSTAL

- No. 806E—Capacity 12 to 25 lbs. \$39.60
- 1A—Stauffer Knapsack. Hopper capacity 20 lbs. \$29.60
- No. 103—Champion Bellows Duster, capacity 8 lbs. Easily filled adjustable nozzle, very efficient. \$9.85
- 673—Cadet \$.65
- 674—Adjutant 1.10
- 612—Patrol 1.30
- 766E—Admiral 2.00
- Browns Crystal 2.25

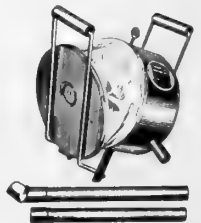

No. 103

FLAT-PAK PLANT FORCES
GRO-QUICK ELECTRIC SEED BED HEATER

SEED UP IN 30 HOURS
 ROOT CUTTINGS IN 6 DAYS
 CUT GERMINATION TIME BY 2/3
 TRANSPLANT 2 WEEKS SOONER

Above user reports show what Gro-Quick soil cable will do. 6 cable sizes for 1 flat to large beds. New catalog, plans free. For hot-beds, cold frames, greenhouse benches, flats, cabinets. Uses house current.

J40A 40' cable & thermo. for 1 sash \$6.75
 S80A for double sash bed (36 sq. ft.) \$9.00

AT-AIR THERMOSTAT\$4.50
 AUTOMATIC MICRO SWITCH \$3.00

HOT BED GLASS
 1 Box will glaze 3 sash. Size 8 x 10; 90 panes, \$6.50; Size 10 x 12; 60 panes, \$6.50.

FEERLESS GLAZING POINTS
 Pound box, 85c.

TWEMLOW'S OLD ENGLISH GLAZING PUTTY
 Semi-Liquid

For bedding glass in sash and filling cracks or seams in roof joints or frames of greenhouses or hotbeds.
 16-pound can (1 gal. capacity), \$4.00

CAULKING COMPOUND
 Gun type, Grey, \$3.50 gal.; White, \$3.65 gal.

CAULKING GUN
 Model D1—Barrel size 9/16 x 2 1/4 in. Capacity, one pint. 1/2 in. nozzle, ratchet rod, breech cap., \$4.50.

PUTTY BULBS
 For applying liquid Putty to sash or greenhouses. 12-oz. size, \$1.25.

SPRAY BULBS
 Centrospray, 12 oz. \$1.75

FENCE RODS
 \$1.75 doz.

TOMKIN CANES
 6 ft., 5/8" to 3/4" dia., 20c ea.; \$2.00 doz.; \$15.00 per 100.

BAMBOO PLANT STAKES
 2 ft. Light 20c per doz.; \$1.00 per 100
 3 ft. Light 25c per doz.; \$1.35 per 100
 4 ft. Light 30c per doz.; \$1.75 per 100

HYACINTH STAKES—Green
 18 in., 80c 100; \$4.75 per 1,000.

PLANT PROPS
 16" 70c doz.; 30", \$1.60 doz.; 42", \$1.90 doz.; 66", \$3.10 doz.; 78", \$4.30 doz.

WOOD STAKES
 3 ft. Green 6c ea.; \$5.00 per 100

TRAIN-ETTS
 Weatherized trellis netting.
 No. 2—60 x 96 in., 85c.
 No. 3—60 x 180 in., \$1.25.

CEMETERY VASE
 Ground level, Aluminum finish, \$2.00.



FLOWER POTS

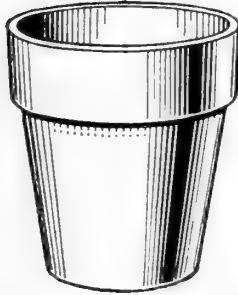

A complete line of regular pots, azalea pots, bulb pans and saucers. Size given indicates top diameter.

Size	Ea.	Doz.	100	1000	Sauc. Each
2"	\$.03	\$.30	\$ 2.10	\$16.75	\$..
2 1/2"	.04	.40	2.60	20.45	..
3"	.05	.50	3.25	26.00	.04
4"	.07	.70	5.15	41.00	.05
5"	.12	1.25	9.30	..	.07
6"	.18	1.85	14.00	..	.10
7"	.27	2.75	21.00	..	.15
8"	.38	3.75	30.25	..	.20
9"	.60	6.0025
10"	.80	7.9040
12"	1.45	14.5060

NEPONSET FLOWER POTS
 Red Shipping

Dia.	per 100	per 1000
2 in.	\$ 8.60	\$ 8.60
2 1/4 in.	1.20	8.70
3 in.	1.30	9.15
3 1/2 in.	12.20	12.20
4 in.	2.00	14.70
5 in.	18.15	18.15
6 in.	3.00	22.25

Let us quote Vita Pots

FLOWER BOXES

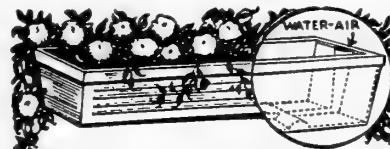

Green, 7 1/2" wide and 5 1/4 inches deep. 20 in., \$3.25; 26 in., \$3.75; 32 in., \$4.25.

WINDOX BOX STANDS
 32 in., \$5.50; 44 in., \$6.00.

GALVANIZED WATERING POTS
 8 qt. \$2.50 10 qt. \$2.75

WOODEN LABELS

Painted
 3 1/2 in.x 5/8 in. Copper Wired.... \$4.20
 4 in.x 5/8 in. Wide, Pot, per 1000.. 3.25
 5 in.x 5/8 in. Wide, Pot, per 1000.. 3.60
 6 in.x 5/8 in. Wide, Pot, per 1000.. 4.00
 8 in.x 5/8 in. Wide, Pot, per 1000... 6.00
 10 in.x 5/8 in. Wide, Garden, per 1000 9.60
 12 in.x 1 1/2 in. Wide, Garden, per 1000 16.00
 Prices, per 100—3 1/2 to 6 in., 65c; 8 in., 85c; 10 in., \$1.25; 12 in., \$1.75.

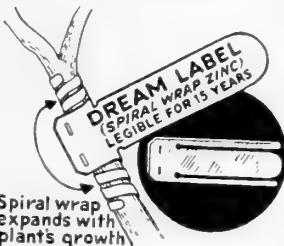

Spiral wrap expands with plant's growth
 No. 1 Kit. Consists of 24 labels, 1 oz. etchant, one applicator. 95c.

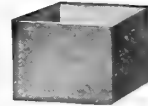

WATERPROOF PLANT BANDS
 (Fertilized)
 Ready-to-use Plant Bands.

VITA BAND 10
 2x2x2 1/2 in. 100, \$.60; 1000, \$4.40
 2 1/2x2 1/2x3 in. 100, .80; 2000, 11.70
 3x3x3 in. 100, .95; 1000, 6.75
 4x4x4 in. 100, 1.20; 1000, 8.85
 4x4x4 in. 100, 1.65; 1000, 11.10

VITA BAND D (Disintegrating)
 2x2x2 1/2 in. 2000 \$9.10
 2 1/2x2 1/2x3 in. 2000 11.90
 3x3x3 in. 1000 6.90
 4x4x4 in. 1000 11.45

PERENNIAL POTS

Height	Top Dia.	Per 1000
5 1/2"	5"	\$36.50
6 1/2"	6"	51.50
9 1/2"	7"	62.85

TOM THUMB FLAT AND PLANT BAND COMBINATION

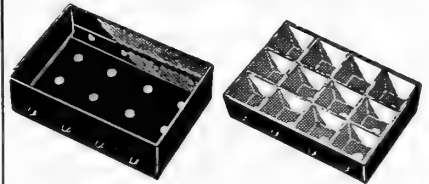

Without Bands **With Bands**
 With Vita Band 10 fertilized Plant Bands. 500 Sets (500 flats, 6,000 bands, 2x2x2 1/2 in.), \$47.85.

WINDOW SILL SEED FLAT
RB22—Waterproofed plant boxes for starting seedlings and plants indoors, consisting of a two compartment seed starter and two transplant boxes. **Set, 29c.**

METAL SEED FLAT
 15x13x2 3/4 ins. deep. Sub-irrigated, brass drain screw. **\$2.75.**
No. 39B 20x5x2 1/2" Sub Irrigated **\$2.15**
No. 40B 20x8x2 1/2" Sub Irrigated **2.35**

CEDAR PLANT TUBS
 (Richmond Style)

Made of Selected Virginia White Cedar, bound with electric welded hoops, painted green.

No.	Inside Top Dia.	Inside Bot. Dia.	Inside Depth	
5	10	7 1/2	9	\$1.65
7	12	9	11	2.40
9	14	11	13	3.35
11	16	12 1/2	15	4.15
13	18	14 1/2	17	5.75

SOIL-SOAKER
Made of Canvas

No. 1, 18 ft. \$2.10
No. 2, 30 ft. 3.05
No. 3, 50 ft. 4.60

SOIL-SOAKER

WATER HOSE



FLOWLINER. 5/8 in. 1 braid, 25 ft. lengths, \$3.85; 50 ft. lengths, \$5.85. (Couplings included.)

MAINLINER. 5/8 in. 2 braid, 25 ft. \$4.75; 50 ft., \$9.85 (Couplings included.)

SURPRISE. 3/4 in. 2 braid, black, smooth, 50 ft. lengths, \$12.75. (Couplings included.)

SUPLEX LP. (Green). Plastic; tested under all climatic conditions and guaranteed for five years. 25 ft., \$4.65; 50 ft., \$7.95; 75 ft., \$11.75.

SPRAY HOSE. 3/8 inch, 25c per ft.



HOSE NOZZLES

161.....\$1.05 155.....\$1.25
139—Shut off nozzle.....\$2.75

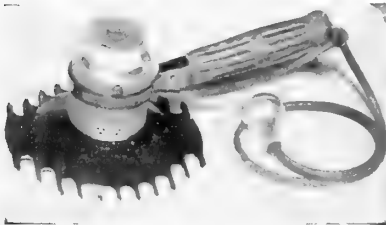

OK-Trim Electric Hedge Trimmer
\$16.75



GRAFTING WAX

Trowbridge Brand. 1/4 lb., 40c; 1/2 lb., 60c; 1 lb., 90c.

FRUIT PICKER—Without pole, 85c.

MOLE TRAPS

200 Roddick (Illus.) \$2.00

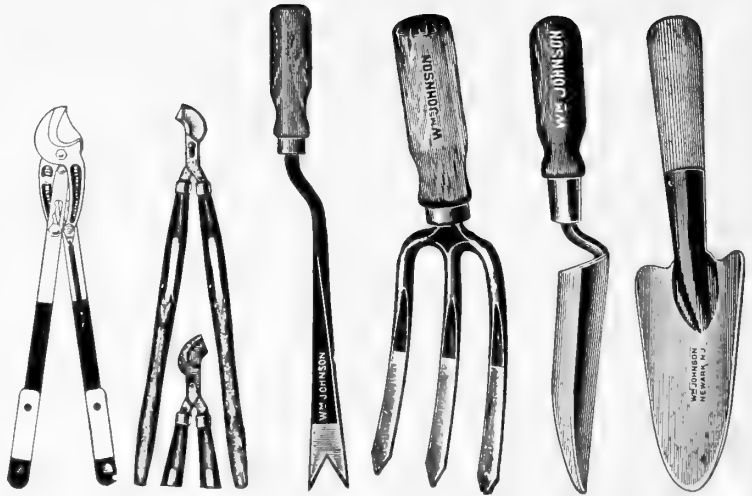

PORTER 5403 2500 300 211 222

LOPPING SHEARS

PORTER POINT CUT No. 1—20-inch steel handles, adjustable draw-cut\$7.50
5406—20-in. hdl. 4.85
5403—22-in. hdl. (drawcut) illustrated 3.85
528—27-in. Steel hdl. 6.00

ASPARAGUS KNIFE

2500J—Short handle \$.65

ASPARAGUS BUNCHER

No. 2 \$ 5.25
Handy 15.00

THERMOMETERS

5140—7 1/2 in. indoor, maroon lac. \$1.00
5126—6 in. indoor, walnut ... 1.25
5316—8 in. outdoor, white enamel 1.25

WEEDER



A—3 Tines, 9 1/4 in. handle.....\$.20
B—3 Tines, 18-in. handle..... .35
BB—3 Tines, 33-in. handle..... .50
C—4 Tines, 10-in. handle..... .35
D—4 Tines, 10 1/4-in. handle with square blade50
E—4 Tines, 10 1/4-in. handle with "V" blade50
SL—12-V shaped cutting edge 3 1/2 ft. handle..... .75
G—4 Tines, 57-in. handle..... 1.75
H—4 Tines, 38-in. handle with square blade 1.85
K—4 Tines, 48-in. handle with "V" blade 1.85

GRASS SHEARS



5600



Miracle

Doo-Klip Snip-Itt\$1.60
Doo-Klip, Standard 2.10
5600 (Wiss), Illustrated 2.50
Doo-Klip, long handle..... 3.75
Miracle 2.50
Miracle, Long handle..... 7.50

CORN KNIVES

Little Giant \$.55
Cumberland Valley55
Black Diamond60
Nowatoco75



HOLE-IN-ONE TOOL

\$1.00

HAND GARDEN FORKS

300—3 Tine \$.75
300—3 Tine, Long hdl. 1.15

GARDEN TROWELS

217J—6 in. Transplanting \$.30
215J—6 in. Steel Blade..... .45
222J—5 1/2 in. Strawberry..... .30

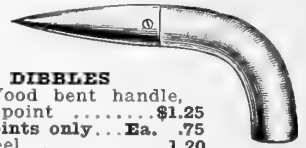

DIBBLES

218J—Wood bent handle, steel point\$1.25
Steel Points only... Ea. .75
751—Steel 1.20

TREE PRUNER

8 ft. \$4.50
10 ft. 5.00
12 ft. 5.50

PRUNING HOOKS

Without Pole
111—Telephone ..\$3.85
166—Pruning shear and hook 3.40
167—Pruning, curved saw, shear and hook 4.50
168—Pruning straight saw, shear and hook 4.50

HEDGE SHEARS



Doo-Klip—9 in....\$4.25
8 1/2 E (Wiss) 8 1/2 in. 4.75
K100—9 in. 4.00
P406—8 in. 3.75
10 in. 4.25
6Y555—Lewis 10 in. 4.25

PRUNING SAW

118—18 inch \$1.90
162—20 inch 3.15
165—10 inch 2.70

PRUNING SHEARS



119

615—(Flower) 6 1/2 in. cuts and holds stem in one operation...\$2.75
908—(Wiss) 8 in. Anvil..... 2.50
119—Snap Cut, 8 in. Anvil..... 2.75
F115—Heavy Duty 2.25



SC14 B14



SL14



YDLR



A36



A54 1/2



E10



EHD5

LEVEL HEAD CURVED TOOTH RAKES
 FR-Floral .. 8 Teeth \$1.25
 RHLSC .. 14 Teeth 1.35
 251-14 .. 14 Teeth 1.85

ROUND BOW CURVED TOOTH RAKES
 250-14 .. 14 Teeth \$2.15

DANDELION RAKES
 Teeth
 DT .. 26-3 1/2 in. \$1.80
 SL11 .. 1.75
 415 .. 26-16 1/4 in. wide 2.05

BROOM RAKES
 Teeth
 24 in. Maguire .. \$1.95
 LC18—Lamcomb .. 2.75
 BRF 22 .. 22-14 in. 1.30
 SL14 .. 22-14 in. 1.35
 Gardex 404 .. 20-12 in. 1.90
 Disston .. 18-14 in. 2.50
 Disston .. 24-14 in. 3.25
 24 Teeth Wire—
 Brooke .. 1.00
 31 Teeth—Bamboo .. 1.50
 Round Wire .. 1.25
 Gardex 403 .. 22 Teeth 1.65

WOOD LAWN RAKE
 24 Teeth .. \$1.50

MANURE FORKS
 Tines
 RHA44 1/2 .. 4-12 in. \$2.20
 A54 1/2 .. 5-12 1/2 in. 3.00
 RHA54 1/2 .. 6-12 1/2 in. 2.45
 RHA64 1/2 .. 6-12 1/2 in. 2.70
 A64 1/2 .. 6-12 1/2 in. 3.25
 A6D .. 6-12 1/2 in. 3.45

HAY FORKS
 Tines
 A36 .. 3-12 in. \$2.95
 RHA36 .. 3-12 in. 2.45

ENSILAGE FORKS
 Oval Tines
 E8 .. 8-16 in. \$5.50
 E10 .. 10-16 in. 6.00

HEAVY FORKS
 Tines
 EHD5 .. 5-16 in. \$6.00

RAPID HOE
 1408 Gardex .. \$3.65

CULTIVATOR HOE
 932 Gardex .. \$1.85

SCUFFLE HOE
 410-7 .. 7 in. wide \$1.95
 120-7 .. 7 in. wide 1.95
 121-7 .. Ladies 1.95
 121-5 .. Ladies 1.85

NURSERY HOES
 N2 1/2—2 1/2 in. blade.. \$1.80
 SL4—2 1/2 in. blade... 1.80

ONION HOE
 STO7—7x1 1/4 in. blade .. \$1.85

HAND PLOW
 200-6 Gardex .. \$2.75

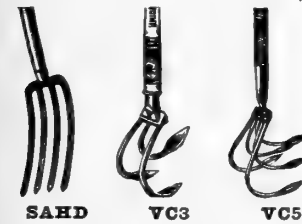

SAHD VC3 VC5



4SC SG 2PWF W7 N2 1/2

SPADING FORKS
 Flat Tines
 SAHD .. 4-11 in. \$3.35
 #001 .. 4-11 in. 2.65
 #002 long .. 4-11 in. 2.65

SPEEDY CULTIVATORS
 Tines
 4SC .. 4 \$2.05
 50 Yoho .. 4 1.50
 51 Yoho .. 3 1.35
 151-4 Gardex .. 4 2.20

SHRUBBERY HOE
 SL19—1 1/2 x6 in. blade .. \$.85
 #171 Gardex .. 1.50

TWO PRONG HOES
 2PWF—3 3/4 in. blade.. \$1.95
 SL7—3 3/4 in. blade ... 1.95
 923—2 3/4 in. blade... 1.60

WARREN HOES
 SL6—4 3/4 in. blade... \$1.80
 W7—4 3/4 in. blade... 1.95

VICTORY CULTIVATOR
 Tines
 VC3 .. 3 \$1.75
 VC5 .. 5 2.00
 #152-3 .. 3 2.20

GARDEN HOES
 L5 (Ladies)
 5 in. blade..... \$1.55
 RHSG—6 1/2 in. blade. 1.55
 SG—6 1/2 in. blade... 1.90
 F—6 1/2 in. Yoho... 1.55

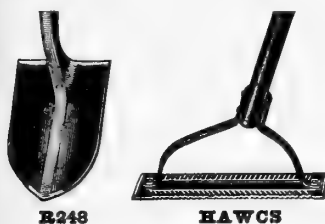

R248 HAWCS



TE 4BOL



SL19 STO7



RHSC



USGT

SHOVELS
 Ed. Pt. Long Hdl.
 R248 Razor Back... \$2.35
 Sq. Pt. Long Hdl.
 HAUL .. 1.25
 No. 2-701 Ingersoll.. 2.25
 S248 Razor Back... 2.25
 Sq. Pt. "D" Hdl.
 GPD-Snow .. 1.40
 No. 6-956 .. 2.55
 Ed. Pt. "D" Hdl.
 FSH-Floral .. 1.95
 R2UD Razor Back... 2.25

WEED CUTTERS
 UWSC .. \$1.65

LAWN EDGER
 Te-Blade—9x4 1/4 .. \$1.95
 Planet Jr. No. 2 .. 2.75

GRASS TRIMMERS
 USGT Union .. \$1.20
 V-165 .. 2.15
 No. 61N "Swing Clip" 1.45

SOIL KNIFE HOE
 SL23 .. \$1.60

SNOW PUSHER
 #90 .. \$2.25

BROOMS
 Palmyrah .. \$1.15
 12B-BASS .. 1.25
 Stable Push .. 1.25

AXES
 Collins, 3 to 4 lbs... \$3.75

MATTOCKS
 5 lb., 3 1/2 in. cutter . \$2.15
 (Handles extra)

SNATH or SCYTHE HANDLES
 Grass Snath, light... \$3.15
 Bush Snath, heavy... 3.45

SCYTHE STONES
 Darby Creek (Flat).. \$.35

BRUSH HOOKS
 No. 18N—36 in. \$3.00
 7N36P—Brush Killer. 2.85

POTATO HOOKS
 Tines
 4BOL .. 4-6 1/2 in. \$2.25
 5BOH .. 5-7 1/2 in. 2.90

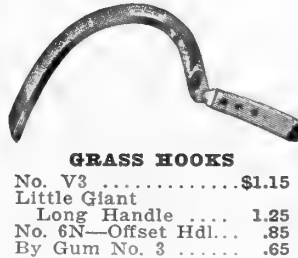

GRASS HOOKS
 No. V3 .. \$1.15
 Little Giant
 Long Handle .. 1.25
 No. 6N—Offset Hdl.. .85
 By Gum No. 3 .. .65

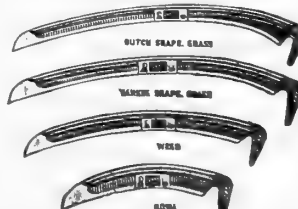

SCYTHES
 32"-34" Grass .. \$2.65
 24"-28" Weed .. 2.65
 22" Bush .. 2.65

HOTKAPS—An Individual Hothouse for Every Plant!



HOTKAPS can make many extra dollars for you this season by assuring you of earlier, bigger crops, and higher early-to-market prices. A patented wax paper cone which completely covers the plant and protects them from frost, rain, wind, ground-crusting and insects.

25 Hotkaps with Fibreboard Setter.....	\$.95
100 Hotkaps with Fibreboard Setter.....	3.15
250 Hotkaps with Fibreboard Setter.....	5.90
1000 Hotkaps....	\$18.35 per 1000; 10,000, \$18.05 per 1000
Fibreboard Setter30
Steel Setter	1.95

FLYING DISK

Scares birds, dogs, cats and other pests away from the garden. Set of 10—**25c.**

TWIST-EMS

E—8 in. box of 100, **25c.**
D—16 in. box of 100, **50c.**
 250 foot continuous roll **\$1.00.**
 Utility Twist-ems, per 1000, 8 in. **\$1.75.**
 12 in. **\$2.75;** 16 in. **\$3.45.**

No.		RUBBER BANDS	
8	7/8 in. x 1/8 in.	8,500 per lb. \$2.15
10	1 1/4 in. x 1/8 in.	6,000 per lb. 2.15
14	2 in. x 1/8 in.	3,750 per lb. 2.15
16	2 1/2 in. x 1/8 in.	3,000 per lb. 2.15
2	Red Ty Bands.	1,600 per lb. 1.65

Asparagus Tape, 1000 yd. tube **\$3.25.**
Binder Twine, 5 lb. **\$1.65;** Bale **\$13.80.**
Cotton Cord, 3, 4, 6 and 8 ply **Lb. 85c;** 10 lbs. **\$8.00.**
Jute Cord, 2 ply, **60c per lb.;** 10 lb. **\$5.80.**
Raffia, Natural color, first quality, **75c lb.**

BACK BANDS

Padded E-5645
351-L50

KNEE PADS

JUDSON. Top quality molded rubber with soft sponge rubber cushion, adjustable straps, nonslip, grips wet or slippery surfaces. For "Every down on the knee job". **Pair, \$2.35.**

AERIFIER

Loosens and aerates soil under turf without disturbing the turf surface, by actual removal of soil cores. Equipped with hollow spoons properly curved to enter and leave the soil without tearing.

Aeriforke —3 pronged fork type.....	\$ 7.75
Aerifier —18 revolving forks, pushes like lawn mower	35.90

GARDEN CART

Light, strong, welded all-steel body, steel axle and wheels with solid rubber tires. 18 in. wide, 27 in. long; capacity **2 1/2 cubic feet.**

Standard	\$7.75
----------------	--------

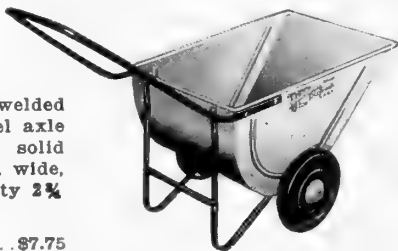

WHEELBARROWS

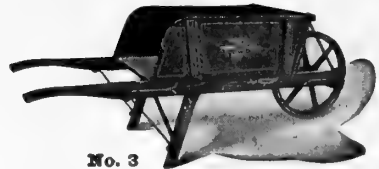

No. 3

No. 3. 26 inches long, 19 to 22 inches wide. Sideboards 12 inches high, tread 2 3/4 in. **\$22.50.**

No. 3-162. Bed 26 1/2 in. long by 18 1/4 and 23 1/2 in. wide, 10 1/2 in. deep, wheel 16 in. x 2 in. semi-pneumatic tire. **\$20.05.**



No. M4-22B

No. M4-22B. Size of tray 37 by 28 in., capacity 4 cubic feet, with 2 ply 4:00 x 8 pneumatic rubber tired wheel, roller bearing.

\$31.05

No. 174

Size of tray 37 by 28 ins.; capacity 4 cubic ft. **\$19.90**



No. 174

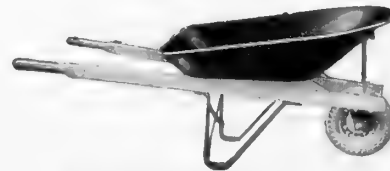

Middy No. 275.

Three cubic ft., 10 in. x 2.75 semi-pneumatic tire.

\$14.65



WHIZ

Home Barrow

3 cu. ft. heaped capacity, tray 32 1/2 in. x 25 in. reinforced rolled edges, tubular steel frame, channel steel legs; 10 in. cushion tired wheel protects turf from indentations and permits easy wheeling. Oilite bearings require a minimum of care—no punctures **\$15.70**

JAX-Delux. Square front-ball bearing. **\$15.70.**

HANDLES

Axe , 36 in., Bent.....	\$.85
Cultivator , Rough, pair	2.00
Hammer , 14 in.15
Hatchet , 14 in. Bobolink.25
Hay Fork , 4 1/2 ft., with ferrule.....	.90
Hay Fork , 6 ft. with ferrule.....	1.15
Hay Fork , No. 38A, 6 ft. with ferrule.....	1.30
Hoe , No. 228, 4 1/4 ft. socket.....	.90
Manure Fork , IDL top, heavy, with ferrule.....	1.25
Manure Fork , No. 102A, 4 1/2 ft. with ferrule.....	1.00
Mattock , 36 in. Natural, Bobolink.....	1.00
Flow , Rough, pair	2.25
Rake , 6 ft., with ferrule.....	.85
Rake , No. 331, 5 1/4 ft.	1.00
Shovel , 4 1/2 ft., single bend.....	.85
Shovel , 4 1/2 ft., double bend.....	.85
Shovel , No. 1004, Razor Back, 4 ft.	1.00
Shovel , No. 1005, Razor Back, 27 in. "D" Hdl.	1.00
Sledge , 36 in.75
Spading Fork , "D" top, with ferrule.....	1.20
Window Brush , 12 ft.	1.00

WATER BALLAST LAWN ROLLERS

Equipped with ball bearings and scraper.



AN INDESTRUCTIBLE ALL METAL TOOL MADE OF QUALITY MATERIALS. WEIGHT 115 POUNDS. OVERALL LENGTH 4 FT. PLATE 9 INCHES SQUARE. SPIKES 1 1/2 INCHES LONG.

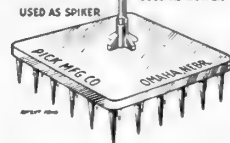

\$7.25

602—18x24, Empty 85 lbs., Filled 265 lbs. Deluxe...	\$21.35
701—14x24, Empty 70 lbs., Filled 175 lbs.	14.80
702—18x24, Filled 265 lbs.	17.65
704—24x24, Empty 110 lbs., Filled 420 lbs.	20.75
No. 4 Dunham—18x24	19.10

SPRINKLERS

5044	\$1.10
Belfont85
156—Tulip	1.60
5040—Ring	1.65
5011—Greelawn	2.55
133—Gold Label	4.50
5018—Propeller, Jr.	2.90



IRRIGATOR

Naturain units are 5 feet long. Primary Unit comes complete with end cap and adjustable stand. Use any number of Extension Units with one primary unit according to size of lot and water pressure.

Primary Unit	\$2.95
Extension Units	2.75 ea.

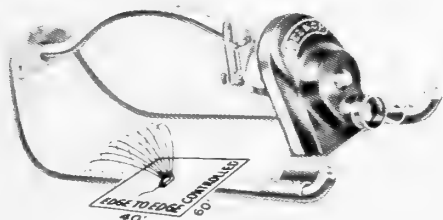

No. 600 Deluxe Swingin' Spray. Rectangular, oscillating. \$11.95.

No. A5-2 Walking Sprinkler. Most popular for medium to large lawns using 50 to 100 ft. hose. \$28.95.

No. B3 Walking Sprinkler. Heavy Duty for estates, parks using 75 to 125 ft. hose. \$36.95.

LAWN MOWERS

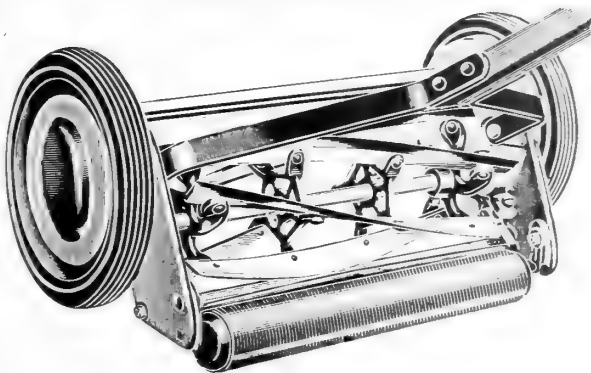

QUIET TURFMASTER BALL BEARING

Streamline design; 5 blades, self sharpening; 10 in. dia. wheels, semi-pneumatic rubber tires, Chromium hub cap, rubber roller, steel handle. 14 in., \$23.50; 16 in., \$24.50; 18 in., \$25.70.

GRASS GROOMER BALL BEARING

Attractive streamlined mower; 5 blades, self-sharpening; 10 in. dia. wheels, semi-pneumatic rubber tires, rubber roller. 16 in., \$22.50; 18 in., \$23.50.

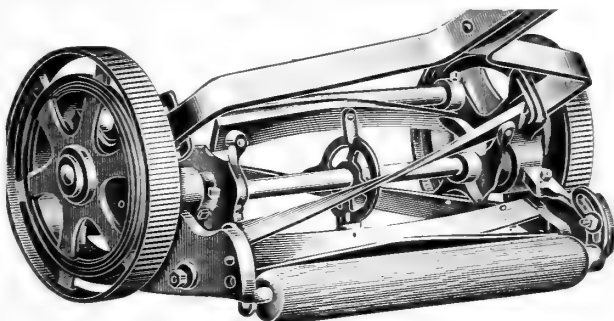

STERLING

Light weight; 5 1/2 in. dia. ball bearing revolving cutters. Four heat treated crucible steel knives; 8 in. dia. wheels. 12 in., \$16.00; 14 in., \$16.25.

SPECIAL

Ball bearing; 10 in. solid rubber tired wheels; five knives. 16 in., \$18.30.

DIAMOND LAWN EDGER AND TRIMMER

The diamond is one-half a small lawn mower with edging device. Will cut very close to wall or tree. Takes the place of Grass shears or grass hook; revolving cutter has 4 knives; 8 in. dia. wheel. \$18.30.

VOGUE

5 Blades, rib tread tires, built-in sharpener. 16 in., \$27.00.

ECLIPSE MODEL "L"

5 Blades, semi-pneumatic rubber tires. 16 in. \$34.50; 18 in. \$36.00; 16 in. Hi-Cut, \$36.00.

ECLIPSE ZEPHYR

5 Blades, rib tread tires. 16 in., \$30.00.

GRASS CATCHERS

For hand lawn mowers 14 thru 18 inches. \$2.50.
For power mowers. \$3.75.



A popular type of glove—for MEN and WOMEN—specially designed for garden wear.

Size 6, 7, 8.....\$1.50 Pair Size 9, 10.....\$1.65 Pair

Soft Touch. Feel like fine kid leather, washable, water-proof material, durable, retain sense of touch. \$.85 pair.

**COOPER
POWER MOWERS**

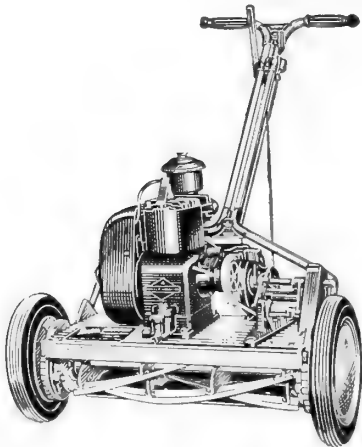

COOPER KLIPPER

A mower of superior quality, designed to give years of economical, trouble free service. Exclusive patented adjustment provides a simple and quick method for adjusting cutting height from a low of 1/2 in. to a high of 2 3/4 in. giving a far greater range of adjustment than any other mower. Cushion rubber tires 10" x 1 3/4"; rope starter, speed control operated by lever and throttle on upper segment of handle. Powered by Briggs and Stratton motor.

18" cut—1 H.P....\$125.00 20" cut—1.6 H.P....\$139.50

COOPER IMPERIAL

27 inch roller type, powered by 3.1 H.P. Briggs and Stratton motor; all steel welded deck heavily reinforced for continuous service on large lawns, cutting height adjustable 3/8 in. to 2 in. Gears steel cut and hardened, speed 1/2 to 6 miles per hour. \$440.00.

Triplex attachment; Used with Imperial 27"—increases cut to nearly 65 inches—includes set of two-19 inch units with one wheel riding attachment. \$247.50.

ECLIPSE POWER MOWERS



ECLIPSE ROCKET POWER MOWER

Briggs & Stratton 4 cycle motor, semi-pneumatic tires, 5 blades, self-sharpening, 20 in. cut. \$149.60.

ECLIPSE PARKHOUND POWER MOWER—21 inch cut. \$190.30

TURFMASTER (Dille and McGuire)

Mowing unit backed by 80 yrs. manufacturing experience plus Briggs and Stratton Motor means top performance and durability.

18 in.\$126.50 21 in.\$149.60

does 26 jobs

**FASTER!
CHEAPER!
EASIER!**

\$248.00
Implements
Extra

Simplicity
REG. U.S. PAT. OFF.

**New Model M-1 3 H. P.
GARDEN TRACTOR**

Mows lawn, cultivates, cuts weeds, removes snow . . . makes light work of many other jobs! Patented "Quick-Hitch". Attach implements in less than one minute, without tools. 5 forward speeds, with new "Lo-Lo" speed. Fully enclosed gears. Briggs & Stratton Model 9 Engine. **COME IN FOR FREE DEMONSTRATION!**

SIMPLICITY TRACTORS

MODEL D —Four Speeds; 1 1/2 H.P. Tractor with 4.00x12 Rubber Tires (Less Equipment).....	\$150.00
5331—Cultivator with rubber tired wheel and depth screw regulator, for models L & M.....	30.00
Model "D" —Cultivator	22.50
5637—30 in. Sickle Bar Mower.....	59.00
5346—24 in. Lawn Mower.....	65.00
5317—Lawn Mower Hitch for Hand Lawn Mower..	7.50
5379—6-12 in. Disc Harrow.....	26.25
5399—6 1/2 in. Plow with 10 in. Swivel rolling coulter and depth screw regulator.....	26.50
5332—30 in. Snow Plow.....	19.50
5350—Counterweight	7.00
5327—Gang Tool Holder with six duck feet. Pair..	5.65
5615—Lawn Roller	13.00
5614—Riding Sulky, 4.00-8 full pneumatic tires and foot brake	48.00
5348—Seeder, one row with marker and hitch....	32.00
5349—Fertilizer Spreader for Seeder.....	11.00

MODEL L-1 —2 H.P. Tractor 5x12 pneumatic tires.	170.00
MODEL M-1 —3 H.P.....	248.00
5511—8 in. Plow with rolling swivel coulter.....	30.50
5378—8-12 in. Disc Harrow.....	30.50

FOB Factory

Free Descriptive Catalog Mailed Upon Request

Planet Jr. Garden Tools



HOES



SHOVEL STEEL



HILLER



TURNING SHOVEL



FURROWER

CATALOG ON REQUEST

3825 3824

CULTIVATOR STEELS

No.	Size	\$	No.	Size	\$
4064	1 x 8	.32	1888	1 1/4 x 10	.38
1156	1 1/4 x 8	.32	1249	1 3/4 x 10	.40
2367	1 3/4 x 8	.34	1199	2 1/4 x 10	.48
2368	2 1/4 x 8	.40	1200	3 x 10	.55
2369	3 x 8	.48	1201	4 x 10	.65
2370	4 x 8	.59			

HILLERS AND PLOWS

No.	Size	\$
1167/8	6" Hiller	\$2.30
495/6	7" Plows	2.85

TURNING SHOVELS

No.	Size	\$
3822/3	5"	\$1.30 pr.
3580/1	6"	1.55 pr.
3824/5	6"	1.90 pr.

FURROWERS

No.	Size	\$
1161	10"	\$1.70
2621	12"	2.30
1162	15"	3.05

IMPROVED SWEEPS

No.	Size	\$	No.	Size	\$
1494	5"	.60	1498	15"	\$1.60
1495	8"	.75	1499	18"	2.15
1496	10"	.95	2731	3"	.50
1497	12"	1.25			

SHOVEL STEELS

No.	Size	\$	No.	Size	Pair
2539	7"	.65	4059/60	4 1/4"	\$1.80
2540	8"	.75	4061/62	6"	1.95

HOES

No.	Size	Pair
4059/60	4 1/4"	\$1.80
4061/62	6"	1.95

SINGLE WHEEL HOE

No. 16 (Illustrated)
\$15.50



19—Garden Plow with cultivator tooth, sweep and plow. \$8.75.
12—Double Wheel Hoe. \$19.95
119—\$8.75 119W—\$9.75

12 TOOTH HARROW

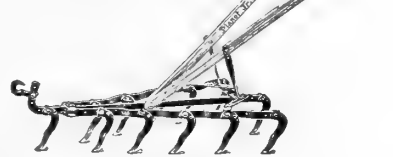

92D—(Illustrated.) Weight 45 lbs. \$18.50.
90D—Expands to 32 inches, contracts to 12 inches. Weight 54 lbs. \$21.75.

HORSE HOE



8—(Illustrated.) \$31.50.
9D—Same as illustrated, less the depth regulator and steel lever wheel. \$24.75.

CULTIVATOR

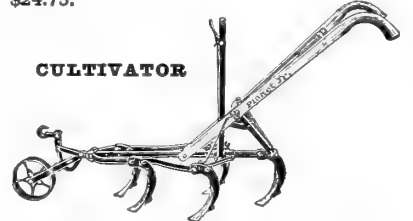

101D—As illustrated, less wheel, weight 44 lbs. \$17.50.
100D—As illustrated, less lever expander and wheel, weight 38 lbs. \$14.95.
4D—As illustrated, less wheel and lever expander, weight 49 lbs. \$16.95.
9D—As illustrated, less wheel, weight 56 lbs. \$21.25.

FERTILIZER DISTRIBUTOR

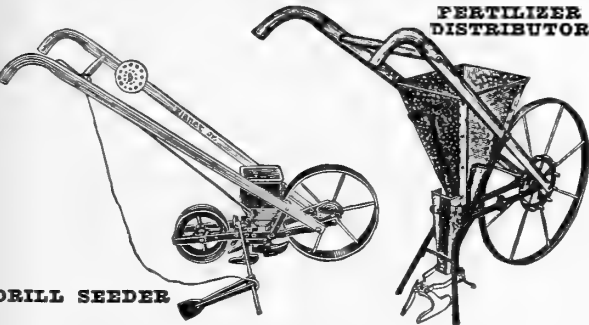

300A 219
4D \$25.50 219 (Illustrated).... \$19.95
300A (Illustrated).. 34.95 220 47.50

PLANET JR.

1 H.P. Tractor with 14" O.D. x 2 3/4" tires. The Multi - purpose Planet Jr. Tractor with its 1 H.P. engine is light, easy to handle, easy to park and useful for many different operations. The power unit for small home owners. (Less Equipment)

\$107.00

1 1/2 H.P. Tractor with 4:00x12 Rubber Tires (Less Equipment) (Model BP-1) ... \$162.50

2 1/2 H.P. Tractor with 5:00x12 Rubber Tires (Less Equipment) (Model BS) \$214.50

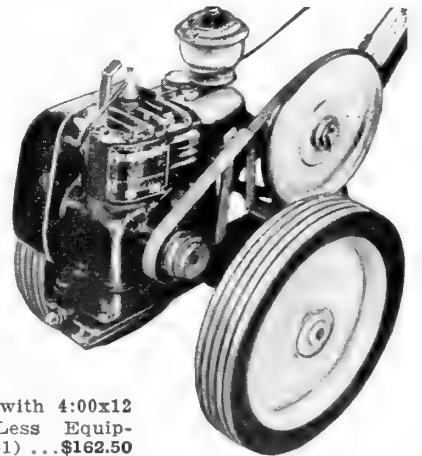

1 1/2 H.P. PLANET JR.



ATTACHMENTS FOR 1 1/2 H.P. TRACTOR

B12—Cultivator	\$29.95	AB56—Field Mower	\$72.50	B62—Disc Harrow	\$43.50
B1—Narrow One row Cultivator	31.95	AB35—Two Row Seeder.....	72.50	B21—6 in. Plow with Coulter..	35.50
B2—Narrow Two row Cultivator	37.50				

FOB Factory

Free Descriptive Catalog Mailed Upon Request

HOLLAND TRANSPLANTERS

ECONOMY • ACCURACY • DEPENDABILITY

Transplants perfectly cabbage, strawberries, tomatoes, tobacco, and all plants which are transplanted.



Mr. H. Castellini and two assistants operating 3 row Self-propelled Transplanter

MECHANICAL ONE ROW. 53 gal. capacity galv. water barrel; with either pole or tractor hitch; Steel wheels; less fertilizer attachment. \$216.00.

MECHANICAL TWO ROW. Row spacing can be adjusted from 2½ ft. to 4 ft.; plant spacing from 16 in. to 5 ft.; (12 in. spacing available at small additional cost.) 53 gal. capacity galv. water barrel, with new type tractor hitch; steel wheels. \$432.00.

ONE ROW FERTILIZER ATTACHMENT, \$54.00.

TWO ROW FERTILIZER ATTACHMENT, \$108.00.

TWO ROW POWER DRIVEN CELERY PLANTER. For celery, onion, and all other small plants set from 3 in. to 12 in. apart in the row. Equipped with 2 H.P. Fairbanks-Morse Water-Cooled Gas Engine, \$416.00.

CELERY PLANTER UNITS, \$94.00.

WATER BARREL AND ATTACHMENTS. For watering plants. \$20.00.

FOB Factory

Illustrated Folder Mailed Upon Request

RODERICK LEAN SPRING TOOTH HARROWS ALL STEEL—"SPW" SERIES

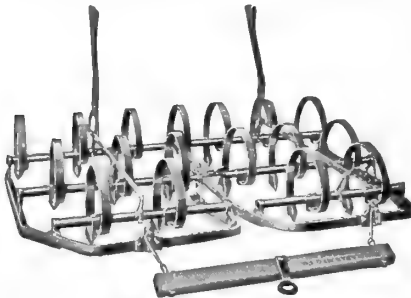

PIPE BAR—Adjusting Lever—Low Frame—Adjustable Teeth—One Short Center Runner.

No.	Teeth	Section	Weight	Price
7SPW.....	17	2	274 lbs.	\$62.75

"TPW" SERIES ONE LEVER CONTROL TRACTOR SPRING TOOTH HARROW

With special draw bar and tractor clevis, plain teeth.

Section	Teeth	Width	Weight	Price
3	25	9	445 lbs.	\$116.75

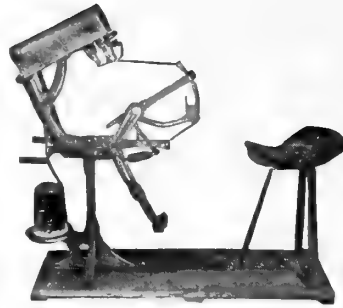

FELINS VEGETABLE TYING MACHINE

Save Hours of Labor with this Machine.
Bigger and Better Than Ever.
\$99.50

"SO-RITE" UNIVERSAL FERTILIZER AND LIME SOWERS

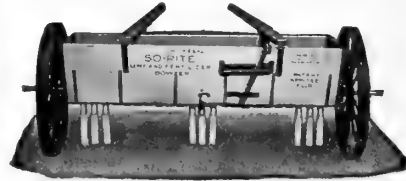

As a Fertilizer Drill—Rubber spouts are adjustable to any width rows. The quantity to be sowed is regulated by lever on back of machine.

As a Broadcaster—Remove all stoppers and spouts.

No.	Width	No. Spouts	Weight	Price
600-U1-9-1	6 ft. 1-Horse.....	9.....	325 lbs.....	\$110.43
800-U1-9-1	8 ft. 1-Horse.....	9.....	375 lbs.....	127.00
800-LA-ELI-TR.	8 ft. Tractor.....	400 lbs.....	136.57

Many other models and sizes 3 ft. to 13 ft. wide.

Extra Spouts Complete \$1.65 Each

RODERICK LEAN SPIKE TOOTH HARROWS "VOW" LEVER HARROW

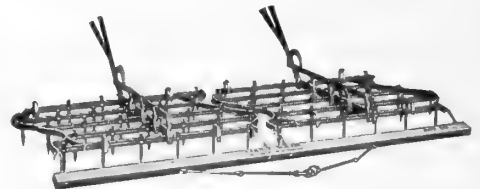

Diamond teeth, 5-bar guarded end adjusting lever.

No. 14VOW—50 teeth, two section, with drawbar, 7½ ft. cut, weight 180 lbs. \$47.95.

No. 15VOW—60 teeth, two section, with drawbar, 9 ft. cut, weight 200 lbs. \$53.05.



RODERICK LEAN WALKING WEEDER

7½ ft., 39 teeth
Less Runners
\$28.95

DRAG SCOOPS

1—	100 lbs.,	\$17.25
2—	90 lbs.,	16.00
3—	80 lbs.,	14.65



MANN'S' CHICKS

FROM UNITED STATES APPROVED—MARYLAND
STATE SUPERVISED AND INSPECTED FLOCKS
PROVEN TO BE PULLORUM FREE

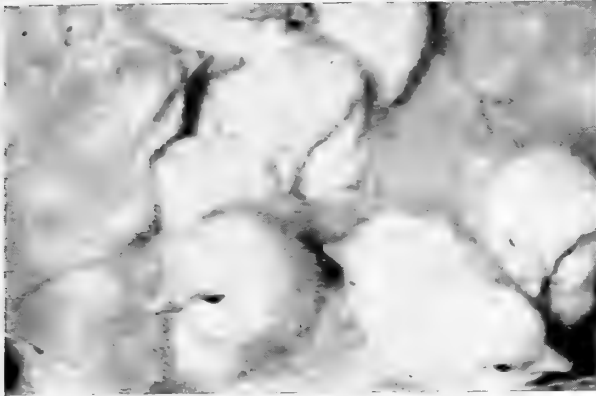

WE GUARANTEE DELIVERY

100% LIVE VIGOROUS CHICKS

With Profit Producing Characteristics Bred Into Them



Mann's chicks are produced from hand selected, Blood-Tested, hens mated to large, true-to-type Blood-Tested, well bred cockerels. These breeders are continually culled for egg production and vigor to insure you of chicks that will not only live, but will grow uniformly, rapidly and profitably for meat or egg production. Upon maturity you will have strong and healthy pullets capable of making money.

ORDER EARLY—SPECIFY DATE WANTED

Order Early. Prices are subject to change but you will be given full benefit of any reduction in prices until shipping date.

Rock-Red Cross	\$16.00 per 100
New Hampshire Reds	16.00 per 100
White Leghorns	16.00 per 100
Leghorn Pullets	42.00 per 100
Heavy Breed Pullets	32.00 per 100

25 add .04c each—
50 add .02c each

TURKEY POULTS,

Broad Breasted Mammoth Bronze. 95c ea.; \$85.00 per 100
Beltsville White. 15 for \$12.00; \$65.00 per 100

High Quality . . . Economical

FUL-O-PEP Feeds

Starter · Grower · Egg Ration
Chick Grains · Scratch Feed
Rabbit Pellets · Pigeon Feed

PRICED RIGHT

LEE'S POULTRY REMEDIES

ACIDOX, 4 oz., 50c; 12 oz., \$1.00; 32 oz., \$2.00; ½ gal., \$3.50; 1 gal., \$6.50.
FLOCK WORMER, 8 oz. \$1.25.
GERMOZONE, 4 oz., 50c; 12 oz., 90c; 32 oz., \$1.75; ½ gal., \$3.00; gal., \$5.25.
GIZZARD CAPSULES—Adult 50-85c; 100-\$1.40.
GIZZARD CAPSULES—Pullet 50-60c; 100-\$1.10.
GIZZARD CAPSULES—Chick 50-45c; 100-85c.
LEEMULSION, 4 oz., 60c; 12 oz., \$1.25; 32 oz., \$2.50.
SULFAMERAZINE, 4 oz. \$1.25; 12 oz. \$3.00.
TONAX, 2 lb., \$1.00.
VAPO-SPRAY, pt., 60c; qt., 90c; gal., \$2.50.

CONKEYS POULTRY REMEDIES

DIA-TAB TABLETS, 25-25c; 55-50c; 125-\$1.00.
INHALENT SPRAY (Concentrated) ¼ pt., 65c; ½ pt., \$1.00.
OLD RELIABLE POWDER, oz., 25c; 2½ oz., 50c; 7 oz., \$1.00.
PICK-END BITTERS, 2¼ oz., 25c; 7¼ oz., 65c.
POULTRY TONIC, 1½ lbs., 30c; 3½ lbs., 55c.

AVICOL

For white diarrhea. 60 tablets, 50c; 180 tablets, \$1.00.

DON SUNG

Makes hens lay. 45 tablets, 50c; 135 tablets, \$1.00.

GROUP-OVER

For Colds, Roup and Canker. 3 oz., 50c; 8 oz., \$1.00.

PHENOTHIAZINE

Very effective for worming livestock, can be mixed with feed or given individually. 1 lb., \$1.25.

"T. S. F."

Kills chicken lice. ½ lb., 50c; 1 lb., 75c.

TOXITE

Disease Control Spray—Controls poultry Coccidiosis, Round Worms and Red Mites which are transmitted by contaminated litter. Qt., 90c; gal., \$2.25.

CHARCOAL

CHARCOAL—Fine or Coarse. 10c lb.; 50 lb. bag, \$4.00.
GRIT, Coarse and fine, 100 lbs., \$1.00.
OYSTER SHELL, coarse and fine, 100 lbs., \$1.25.

CAPONIZING SETS

Dr. Salsbury—Set \$5.35
WRITE FOR FREE POULTRY BOOKS

CEL-O-GLASS

Now guaranteed for 5 years. Unbreakable weather proof, transmits violet rays (Glass does not). Ideal for poultry house, fronts, windows, and doors, and many other uses.

36 inches wide,
45c per ft.; 50 ft.
rolls 39c per foot.

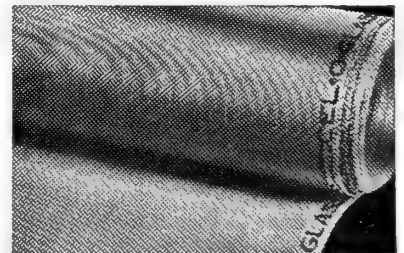

R-V-LITE VITAPANE

36 inches wide (cord base)..... 21c lineal foot
50 ft. roll (150 ft.)..... \$10.25 roll

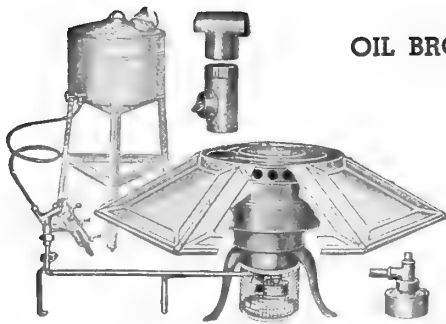

OIL BROODER

256B—54 inch; 8-gallon tank; 700 chicks. Without Fuel Stand. \$27.15.

ELECTRIC BROODERS

No. 50—Galv. 24"x36"x9½" deep, feed and water trough included, thermostat controlled, 100 chick cap. \$19.00.

UB42—Galv. Metal, 500 watt enclosed type heater, with thermostat, size 36 in. by 42 in., capacity 200 chicks. \$20.00.

302. Galv. metal chick battery unit with 150 watt acra heater, micro switch and wafer thermostat. Size 23 x 36 inches. Capacity 100 chicks. \$17.95.

202—Square type canopy, 26 gauge galvanized steel, lined with Masonite presdwood, 500 Watt enclosed Acra Type heater with thermostat. Size 36 in. by 36 in.; capacity 150-200 chicks. \$23.25.



REEL TOP FEEDER

H224—24 in., galv. . . . \$.50 H6360—36 in. galv. . . . \$1.20
H5480—48 in. galv. . . . \$1.80

GRILL TOP FEEDER



H7480—48 in. galv. . . . \$2.60

FOUNTAIN AND FEEDER

CG6—(Crystal). Fits any Mason Jar. 15c.

SINGLE WALL FOUNTAINS



HAS—2 gal. galv. . . . \$1.60
HC3—3 gal. galv. . . . 2.20
HC5—5 gal. galv. . . . 3.00

SPIRAL BANDS

Dark blue, light blue, red, green, white.



Size Per 100
¼ in. \$.30
5/16 in. .30
9/16 in. .60
11/16 in. .65
¾ in. .70

FLOCK FEEDERS

H25S—60 in. galv. . . . \$6.90
H28S—96 in. galv. . . . 10.40



TOP FILL FOUNTAINS

HK5—5 gal. galv. . . . \$4.40
HK5H—5 gal. with heater 7.60
904—Automatic Valve and Float only 1.20

FOUNTAIN HEATERS

H5H—Oil, fits any 15 or 15½ in. pan. \$3.20.
H82—Lamp with burner and wick. \$2.10.
H570—Elec., fits any 5 to 10 gal. fountain. \$7.20.
Trumbull Electric \$5.65

FEEDER AND WATERER

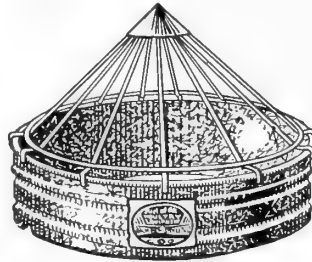

G16L—16 in. dia. 4½ in. high, 16 qt. capacity. \$2.45

GALVANIZED PIPE

2 ft. lengths. 4 in., 35c.

ELBOWS

4 in., 40c; 5 in., 45c.

GALVANIZED CAPS

HPC5—5 in., 35c.

ROOF SADDLE

440. Adjustable. 4 in., \$1.25
HRS5—5 in., \$1.65.
N12—Non-adjustable. 4 in., 45c.

CHICKEN HOUSE FLOOR SCRAPER

Pointed sides for corners. \$2.15.

WAFER THERMOSTATS

T-347—DeLux. 3-in. \$.50
128 Brooder Thermometers \$.50
Incubator Thermometers 65

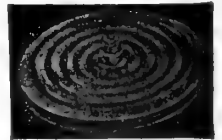

EGG CARTONS

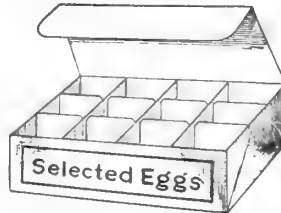

Carry Safe, 3x4. 100, \$1.75; 250, \$3.85.
Eagle, 3x4. 250, \$3.50.
Swanee, 2x6. 250, \$5.75.
Hawk, 2x6. 250, \$4.25.

METAL EGG CRATES

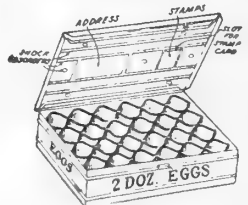

2-dozen size \$2.00
3-dozen size 2.75
4-dozen size 3.25
6-dozen size 3.75
Postage Extra

EGG PRESERVATIVE



Qt., 60c; gal., \$1.70

EGG CANDLER

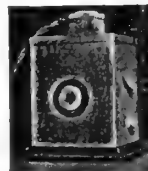

8910

700 \$2.00

842—Capacity 20 lbs. by ounces in two revolutions; adjusted by set screw at top; 8 in. dial, figures in black on white enamel. Heavy galv. scoop and chain. \$9.50.

WIRE EGG BASKETS

44—Cap. 12 to 15 doz. . . . \$1.25

EGG CLEANERS

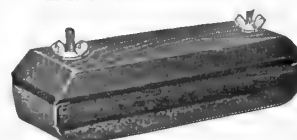

13 \$.35
14—10 ft. Cleaning Cloth .80
Humane Poultry Killer . \$2.25

SCALES

8910—Spring balance. Capacity 100 lbs. by 1 lb. \$6.00.
895—Spring Balance. Capacity 50 lbs. by 1 lb. \$3.25.

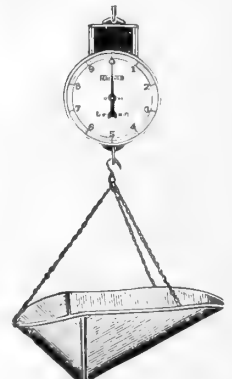

842

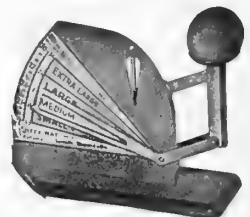

517 Egg Grading \$2.00

POULTRY NETTING
Galvanized After Weaving

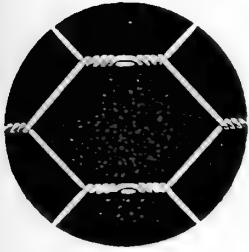

Hex-Cel

150-FOOT ROLLS

2-inch Mesh	1-inch Mesh
20 gauge	20 gauge
24 inch..\$4.70	12 inch..\$5.10
36 inch.. 6.60	18 inch.. 7.30
48 inch.. 8.75	24 inch.. 9.50
60 inch..10.70	36 inch..13.75
72 inch..12.65	48 inch..18.00

25 to 150 foot lengths
2-inch mesh 3c per sq. ft.
1-inch mesh 5c per sq. ft.

BARBED WIRE GALVANIZED

4 point, 12 gauge, 6 ins. between barbs. 80 rod reel \$9.50

POST HOLE DIGGERS
\$3.65

EARTH AUGERS

8-8-14 in.\$11.45

TOWNSEND WIRE STRETCHER

No. 500. Has hickory handle and malleable clamp; can be quickly adjusted. \$3.35.

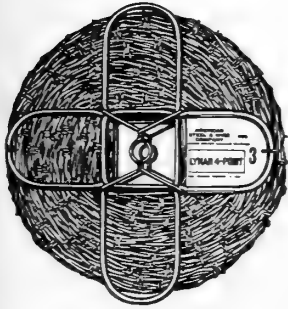

STEEL FENCE POSTS

5 ft., 85c; 6 ft., \$1.10; 7 ft., \$1.25

STICKIT WICKIT FENCING

PROTECTS AND BEAUTIFIES

Easy to hammer into hard ground

21" High, 12" Wide, 1/4" steel enameled green

\$2.40
Doz.

In cartons of two dozens (makes 24 feet of fence)

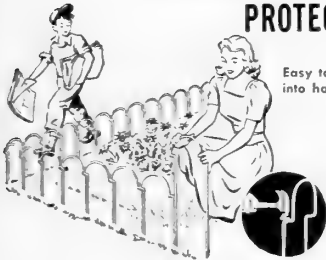

FLOWER GUARD

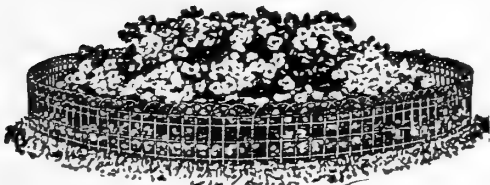

Designed for protecting Flower Beds

22-inch, per foot, 14c; 100 ft. roll, \$12.00.

HARDWARE CLOTH

2x2.....\$.11 sq. ft.	4x4.....\$.12 sq. ft.
3x3......11 sq. ft.	8x8......18 sq. ft.

100 sq. ft. or more deduct 1c per sq. ft.

ORNAMENTAL GATES

Heavy steel frames, filled to match the fence; fittings for 1 1/2 in. iron posts included.

Width	Height	Price
42-inch	36-inch	\$7.75
42-inch	42-inch	8.00
42-inch	48-inch	8.35

How to cure a BALD-HEADED TERRACE



USE BEMIS EROSIONET

Sow Manns' DEEP ROOTING TERRACE MIXTURE and roll out the EROSIONET

Now you can grow grass on that stubborn slope. Unroll this mesh blanket and laugh at the rain. Your seeds will not be washed out, and you will get a sturdy stand of grass. 45 in. wide; 25c yd. 100 yds. or more; 20c yd.

HOSE REELS

REAL-REEL — Portable; unreel only hose actually needed; 5 ft. accessory hose connects leakproof coupling on side to water supply. Holds 150 foot of hose. Sturdy, all metal constructed. \$14.95.

CHAIN LINK FENCE

No. 9 gauge, zinc coated, 50 ft. rolls.
Per foot—36 in., 41c; 42 in., 49c; 48 in., 55c; 60 in., 68c.

ORNAMENTAL LAWN FENCE

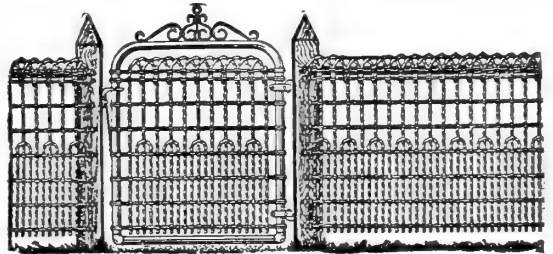

Very attractive and we believe the most durable wire lawn fence made. Heavy galvanized. Spaces, 1 1/2 inches; wire, No. 9 1/2 Crimped Pickets in No. 12 1/2 Tw. Cables.

	36-inch	42-inch	48-inch
	Per ft. 100 ft.	Per ft. 100 ft.	Per ft. 100 ft.
Single Loop ...	\$21 19.50	\$24 22.00	\$28 25.00
Double Loop28 25.00	.32 29.00	.35 32.00

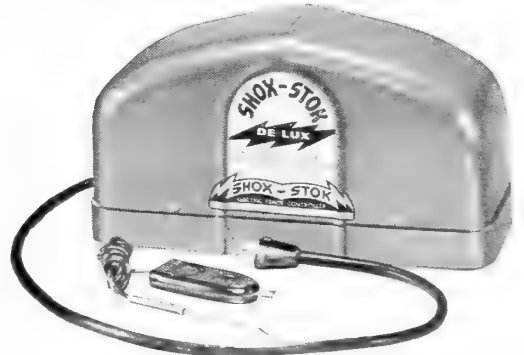

ELECTRIC FENCE CONTROLLER

SHOX-STOK: Precision built for long life, waterproof steel case, charges up to 15 miles of fence. Complete with fence tester, cord and plug.

Delux Electronic Model, Interrupted impulses. Fuse protection against overload.....\$21.95

Electric Model P.H.5, No moving parts, continuous shock\$15.95

EXTENSION LADDERS

Equipped with automatic locks, rope, and pulley. Rails are edge grained Spruce and Hickory rungs. (An allowance of 2 ft. should be made for lap on ladders 20 to 32 ft. and 3 ft. from 34 to 48 ft.)

In lengths from 20 to 32 ft. inclusive, 90c ft.
In length from 34 to 48 ft. inclusive, 90c ft.

SINGLE STRAIGHT LADDERS

10 to 24 ft., 90c ft.



CHERRY SEEDERS

\$3.85

GLASS CHURNS

Size Churns
4 quart—2 quart.....\$3.35
8 quart—4 quart..... 6.85

GLASS JARS ONLY

2 qt., 75c; 4 qt., \$1.25; 6 qt., \$1.40; 8 qt., \$1.65.

CYLINDER CHURN

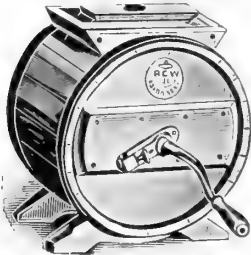

No. 1—3 Gal. (churns 1½ gal.) \$7.50.



PARCHMENT BUTTER PAPER

Sizes 6x9, 9x12.... Lb., 35c
Postage Extra

DANDELION BUTTER COLORING

3 oz. \$.60
1 lb. 2.25

ICE CREAM FREEZER



Snowball (Triple Action). 2 qt., \$3.35; 4 qt., \$10.65; 6 qt., \$13.75.

HUDSON BARN EQUIPMENT

2A—Stall, \$14.70.

181W—Stanchion, \$5.15.

181—Stanchion, \$4.52.

89A—Water Bowls, \$5.80.

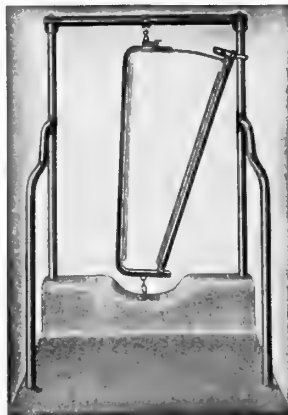

262—Hay Carriers, \$33.00.

268—Harpoon Fork, \$8.00.

249S—Rafters Brackets, 9c ea.

290—Hanger Hooks, 30c ea.

401—Track, 40c ft.

SAW FRAMES

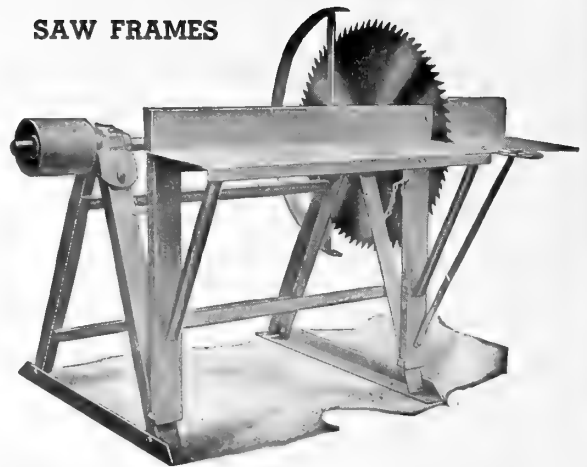

No. 9—All steel saw frame; 3 to 5 H.P. with 30 in. blade and 50 lb. flywheel. \$68.50.

BLADES (Cross Cut)—Bore 1½-inch
18-inch, \$6.85; 24-inch, \$10.80; 26-inch, \$12.65; 28-inch, \$14.75; 30-inch, \$16.85.

SAWS

AA3—24 in. 8 pt. Penna. Hand Saw.....\$4.25
400—3 ft. Penna. One Man Saw..... 3.85
400—3½ ft. Penna. One Man Saw..... 4.40
800—5½ ft. Penna. Cross-Cut Saw..... 5.65
800—6 ft. Penna. Cross-Cut Saw..... 6.50
1½—Penna. Buck Saw 2.00

FARM BELT

Rubber coated canvas transmission belting; 4 in. wide; 4 ply; flat sides; black, 45c ft.

DAIRY SUPPLIES

Bag Balm, \$1.00.
Kow-Kare, 1¼ lbs., 75c; 2¾ lbs., \$1.35.
Conkeys Stock Tonic, 2¾ lbs., 55c; 6 lbs., \$1.10.
CALF WEANERS, No. 103 Medium, 85c; No. 2, \$1.00.
TEAT DILATORS for Cows, box of 18, 25c.
PERFECTION ANTI-COW KICKERS, \$1.75.
MILLERS DAIRY SPRAY, \$2.00 per gal.

GRINDSTONES

VICTOR. Tubular steel frame, adjustable steel seat, treadle type, ballbearing journals and crank attachment. Stone 19 to 22 inches in diameter by 1¼ to 2¼-in. face. \$16.80.



LOOSE GRINDSTONES (centered) 20-22 in. dia. by 2 in. face. \$3.75.
Loose Grindstones, 6c per pound.

TOOL GRINDER

This very useful grinder is especially suited to farm work and can be easily clamped to a mower wheel or bench.

82—With Bevel Tool wheel only\$13.95

83—With both Flat and Bevel Tool Wheels..16.10

171—4½x1½ Dimeo-Grit Tool Wheel 3.25

DG3¼—Beveled Wheel only 2.10



Let Us Send Complete Free Catalog
For Quick Service
Mail Your Order To Us
Prices F. O. B. Baltimore



HONEY JARS

- 5439—Plain Round, 1 lb. size, \$1.60 case 2 doz.
6222—Plain Round, 2 lb. size, \$1.15 case 1 doz.
6558—Honey Jar, 5 lb. size, \$1.50 doz.
White coated caps included

CORN SHELLERS

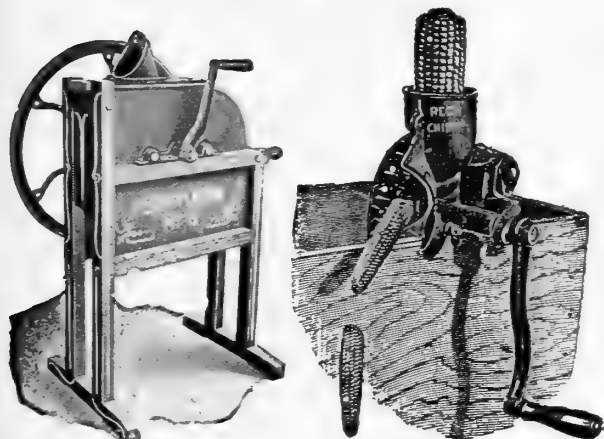

No. 3 \$40.00

Red Chief \$5.00

RURAL MAIL BOX

- 1—18 3/4 in. long, 6 in. wide, 8 3/4 in. high.....\$3.00
2—23 1/4 in. long, 11 in. wide, 13 3/4 in. high..... 7.00

SALT BRICKS

- Worcester\$.20
Worcester Mineralized—
4 lb. brick, 25c; case of 15 bricks, \$3.00

MEAT CURING PRODUCTS

- Mortons Sugar Cure, (Smoke Salt) 7 1/2 lbs., \$1.00.
Mortons Tender Quick, 4 lbs., \$1.00.
Mortons Sausage Seasoning, 10 ozs., 50c.
Mortons Meat Pump, \$2.00.

ROOFING MATERIAL SMOOTH SURFACED

	Weight	Per
	Lbs.	Roll
Fanamold, medium	45	\$2.40
Everlastic, heavy	55	2.95
Everlastic, extra heavy....	65	3.20

(Underwriters' label)

5V-GALVANIZED METAL ROOFING

8 ft. or 10 ft. sheets. \$14.50 per 100 sq ft.



KUR-A-LEKE

A semi-liquid mastic or cement-like composition, not affected by extreme heat or cold; absolutely water tight and fireproof. It "kures" the leaks in wornout tin, galvanized iron or composition roofings. Gal., 95c; 5 gals., \$3.50.



COW TIES

4 1/2 ft.\$.35 each

TIE OUT CHAINS

20 ft.\$.90 each
30 ft. 1.20 each

HALTER CHAINS

4 1/2 ft.\$.30 each

TRACE CHAINS

Lucky Mule, elec. welded; 7 1/2-10-2. \$2.25 Pair.

Victory: 7 ft.—\$1.50 pair

OLIVER PLOW REPAIRS



	Mould-boards	Land-sides	Solid Shares	Slip Shares
AC-2	\$2.80	\$1.20	\$.75
10	4.50	2.00	1.25	\$1.50
13	4.55	2.25	1.30
19	6.80	2.45	1.50	1.80
20	8.15	3.10	1.75	1.85
E	9.80	2.95	1.95	2.20
40 & 40-4X	9.90	3.65	2.10	2.35
83	9.00	2.50
84-88 12 in.	10.15	2.50
SLIP POINTS.....	35c

SYRACUSE PLOW REPAIRS

	Mould-boards	Land-sides	Solid Shares	Slip Shares
1-78	\$2.05
604	1.00	\$1.80
603 & 503	\$6.00	\$2.40	1.60	2.15
602 & 502	7.50	2.80	1.80	2.55
601 & 501	8.05	3.70	2.20	3.45
1462	2.50	1.80
1463	6.00	2.10	1.60
X1441 FQD, Hook or Bolt	2.35
SLIP POINTS, A and B.....	35c

CHATTANOOGA REPAIRS

	Mould-board	Land-side	Solid Share	Slip Share
65	\$7.50	\$2.95	\$1.75	\$2.05

Plant Food Elements

Plants require nitrogen, phosphorus, potassium (the three most important), oxygen, hydrogen and carbon (obtained from air and water) and the minor elements usually found in the soil in sufficient quantity but also supplied in the better brands of mixed fertilizers.

These minor elements are calcium, sulphur, magnesium, manganese, iron and boron. Their functions are largely indirect, but very essential as they aid the chemical changes which render other ingredients more available. Calcium (lime), for example, aids in making the nitrogenous materials more quickly available and changes the physical nature of soils. Sulphur seems to exert a beneficial influence on plant growth and iron is necessary in the formation of chlorophyll.

NITROGEN is the "top growth" element needed for leafy vegetables such as spinach, kale, parsley, etc. Aside from mixed fertilizers, nitrogen can be had in various organic forms as in bone meal, blood meal, tankage, fish meal, cottonseed meal and inorganic forms such as nitrate of soda (tending toward an alkaline reaction), am-

monium sulphate (tending toward an acid reaction), urea and potassium nitrate. The organic materials are safest to use as they react slowly and do not burn.

PHOSPHORUS is generally the most needed element, as the continued use of manures possessing such a little of it, combined with the fact that most crops are heavy phosphorus feeders, soils worked for a number of years are practically depleted of this element. A real fertile soil is rich in readily available phosphorus. It is the element which promotes growth and vigor, flowers, fruit and seeds. Beans, corn, cucumber, tomatoes, turnips and rutabagas seem to respond to heavy feedings of phosphorus. It is available in mixed fertilizers, superphosphate, bone meal and tankage.

POTASH is the root growing element. Asparagus, beets, carrots, celery, cucumbers, lettuce, potatoes and radish all respond to extra potash feeding. Sulphate of potash is best for tobacco, lettuce and leaf crops, while muriate of potash is most beneficial to carrots, potatoes and root crops.

3 AGRICO Fertilizers FOR BETTER LAWNS and GARDENS

Each of these three special-purpose AGRICO Fertilizers is made to do its own job and do it better than any all-purpose fertilizer could possibly do. Yet Agrico costs no more . . . is more economical to use . . . gives you more value, per pound and per dollar.



**AGRICO FOR
LAWNS, TREES
& SHRUBS**

Keep a lawn good by feeding it with Agrico every Spring and Fall. Use Agrico in rebuilding lawns. Also, feed your trees and shrubs. Use 30 lbs. per 1000 sq. ft.



**AGRICO FOR
GARDENS**

Use this special-purpose Agrico for flowers of greater health and beauty—and for larger yields of vegetables, richer in minerals and vitamins. Use 40 lbs. per 1000 sq. ft.



**AGRICO FOR
BROADLEAF
EVERGREENS**

This AGRICO provides all needed plant foods for acid-loving plants,—also acidifies the soil, essential for best results. Use approximately 1 1/2 lbs. per 100 running feet.

100 lbs. (2-50's)	\$5.00	\$4.55	\$5.80
50 lbs.	2.55	2.30	3.00
25 lbs.	1.70	1.70	2.20
10 lbs.	.85	.85	1.15
5 lbs.	.48	.48	.63

VERTAGREEN

For lawns, flowers, shrubs, fruits, vegetables and trees. It contains, in concentrated readily available forms, major and minor plant food elements needed for healthy, vigorous growth. 1 lb., 15c; 5 lbs., 53c; 10 lbs., 95c; 25 lbs., \$1.70; 50 lbs., \$2.80; 100 lbs., \$4.55.

VIGORO

Vigoro is a complete fertilizer containing all necessary minor elements. It is clean, odorless, sanitary and easy to apply. Economical because you need only 4 pounds of Vigoro per 100 sq. ft. to get best results from everything you grow.

1 lb.	\$.15	5 lbs.	\$.53	10 lbs.	\$.95
25 lbs.	1.70	50 lbs.	2.80	100 lbs.	4.55

**FULTON'S
PLANTABBS**
Odorless Plant Food Tablets
Containing Vitamin B₁

10 Tablets, 10c; 30 Tablets, 25c; 75 Tablets, 50c; 200 Tablets, \$1.00; 500 in pot, \$2.00; 1000 Tablets, \$3.50. (By mail add 10%.)

ES-MIN-EL

Essential minor elements not present in depleted soils. Use with fertilizer or separately, about 1 lb. per 100 sq. ft., 50 lbs., per acre. 5 lbs., \$1.25; 100 lbs., \$10.25.

HY-GRO SOLUBLE PLANT FOOD

13-26-13-Plus Trace Elements

3 oz., 25c; 2 lbs., \$1.40; 10 lbs., \$4.50; 100 lbs., \$26.00.
(Gat Spray Head \$1.50)

NUTRI-LEAF (16-16-16)

The Miracle Plant Food Concentrate Soluble Fertilizer and Foliage Spray
3 lbs. to 50 gal. water or spray material

10 oz.	\$.60
22 oz.	1.00
3 lbs.	1.75
30 lbs. (10-3's)	8.50

HYPONEX

Contains Vitamin B-1

For growing plants in soil, sand or water. Ideal for "tank farming," a complete and balanced plant food; odorless and keeps indefinitely.

3 oz. makes 18 gallons	\$.25
7 oz. makes 42 gallons	.50
1 lb. makes 100 gallons	1.00
10 lbs. makes 1000 gallons	8.00
25 lbs. makes 2500 gallons	15.00



TRACEL—(8-16-7)

Complete soluble fertilizer with trace elements. 1/2 lb., 65c; 1 lb., \$1.00; 15 lbs., \$9.00.

VHPF—(6-25-15)

1 lb., makes 30 gal.

Vitamin Hormone plant food soluble fertilizer plus all essential minor elements, in quickly available form. Used as starter solution, side dressing, etc., with outstanding results. 1 lb., 75c; 3 lbs., \$1.50; 30 lbs., \$7.50; 150 lbs., \$32.50.

VIGORO SPREADERS

BR—18 in., 20 to 25 lb. capacity . . . \$10.00
Junior—18 in., 45 to 50 lb. capacity . . . 12.50
Standard—24 in., 80 to 90 lb. capacity . . . 40.00

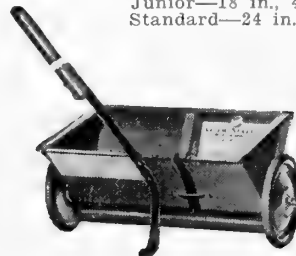

SALEM SPREADERS

Automatic shut off; six quantity adjustments.

16 in., 22 lb. cap.	\$8.25
20 in., 40 lb. cap.	12.75
30 in., 80 lb. cap.	19.40

BUCH SPREADERS

No. 1—15 in., 28 lb. capacity	\$6.15
No. 2—20 in., 40 lb. capacity	12.70
No. 3—30 in., 60 lb. capacity	14.80

Plant Foods for Organic Gardens

	5	10	25	100
Blood Meal	lb.	lbs.	lbs.	lbs.
(3 lbs., 50c).....	\$2.00	\$1.50	\$3.50
Bone Meal, Raw..40	.75	1.60
Bone Meal, Steamed	5.25
Cottonseed Meal..50	.85	2.00
Cow Manure40	.75	1.40
Ground Phosphate Rock	1.85
Pulverized Ground Limestone.....	80 lb. 75c;	160 lbs.	\$1.25
Sheep Manure40	.75	1.40
Tobacco Stems (Meal)	2.50

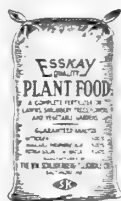

ESSKAY PLANT FOOD (Analysis: 5-9-4)

A complete organic fertilizer consisting of blood, bone meal, tankage and potash scientifically blended for Flowers, Lawns, Vegetables, Trees and Strubs. It builds up the soil and leaves no acid residue. 10 lb. bag, 90c; 25 lb. bag, \$1.75; 50 lb. bag, \$2.90; 100 lb. bag, \$4.25.

GREEN NUTRO Natural Soil Builder

Available 0-2-5; Total 0-18-7
Finely ground natural rock containing phosphorus, potash and thirty minor and trace elements plus an activated carbon base. On lawns and gardens use 10 lbs. per 100 sq. ft. Large areas 1/2 ton per acre. \$2.75 per 80 lbs. \$50.00 ton.

AFRICAN VIOLET SOIL

Specially prepared organic potting soil for African Violets. 4 lb. pkg., 35c.

ACTIVO

Popular composting chemical makes rich organic fertilizer out of vegetable waste. Stretches fertilizer; activates soil. No. 2 Size (approx. 2 lbs.) makes about 425 lbs. compost, \$1.00. No. 7 Size (approx. 6 lbs.) makes about 1400 lbs. compost, \$2.49.

ADCO

Is a powder, which, when mixed with almost any non-woody vegetable waste, and kept wet, gradually converts it into manure.

50 pounds of ADCO makes a ton of manure. Equal to stable manure—Odorless. 5 lbs., \$1.25; 20 lbs., \$2.95.

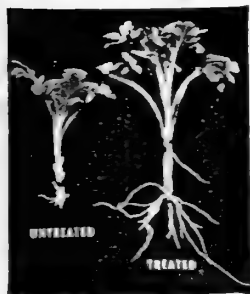

ROOTONE

Reg. U. S. Pat. Off.

Assures better germination of seeds, produces better plants with longer roots, greater top growth and vigor. Rootone kills fungi and prevents damping-off.

1/4 oz. will treat 2 1/2 lbs. seed or 400 cuttings, 25c.

2-oz. size will treat 8 bu. seed or 3,000 cuttings, \$1.00.

1 lb. will treat 30 bu. seed or 30,000 cuttings, \$5.00.

TRANSPLANTONE

Reg. U. S. Pat. Off.

Contains Vitamin B-1 and other parts of the Vitamin B fraction, plus plant Hormones which are active in root formation.

This Vitamin-Hormone tonic stimulates the growth of seedlings, plants, trees, shrubs, rose bushes, lawns, etc., by not only forming new roots but by also continuing their growth and making plant food more available. Very beneficial to transplanted seedlings, shaded lawns and backward garden plants. 1 ounce makes 10 gal. transplanting solution or 900 gal. watering solution. 1/2 oz. pkt., 25c; 3 oz., \$1.00; 1b., \$4.00.

FRUITONE

REG. U. S. PAT. OFF.

When sprayed on blossoms of tomatoes or beans it produces better set and larger crop. 2/5 oz., 25c; 2-oz., \$1.00; 12-oz., \$5.00.

FLORALIFE "B"

Prolongs life of cut flowers, retards wilting, prevents fading, maintains fragrance.

10c size makes two quarts solution
\$1.00 size makes thirty quarts solution

ROSE FOOD

An organic plant food especially for roses.

Miller's (Analysis 7-8-5) ... 5 lbs., 85c.
1bs., \$2.85; 100 lbs., \$9.75.

TRIOGEN. Analysis 5-10-5. 5 lbs., \$1.00; 10 lbs., \$1.70;
25 lbs., \$3.20; 100 lbs., \$9.40.

SPHAGNUM MOSS

Finest quality. Free from sticks and other refuse.
1/2 Pk., 25c; Bu., \$1.65; Bale, \$3.45.

Inoculate all Legume Seeds with

NITRAGIN

OVER FIFTY YEARS OF SERVICE

When ordering, Always state name of seed.

COMBINATION (AB)

Size	Retail
1 bu. each.....	\$.50
2 bu. each.....	.90

SOYBEANS (S)

Size	Retail
2 bu. ea.	\$.35
5 bu. ea.55
25 bu. ea.	2.50

(One can)

ALFALFA (A)

Swt., Bur, Hubam Clovers	
1 bu. each	\$.50

CLOVERS (B)

Red, Alsike, Crimson, White and Ladino.	
1 bu. each	\$.50

BEANS (D)

Navy, Pinto, Wax, String, Kidney and Great Northern	
1 bu. ea.	\$.50

LESPEDEZA (L)

100 lb. size (Inoculates up to 100 lbs.) ..	\$.50
--	-------

PEAS, VETCHES (C)

100 lb. size (Inoculates up to 100 lbs.) ea.	\$.50
---	-------

PEANUTS, COW PEAS (E)

2 bu. ea.	\$.35
5 bu. ea.55

GARDEN SIZE—Peas, Beans, Sweet Peas, Lupines, Lima Beans and Edible Soybeans.

Enough for 8 lbs. seed — Retail Price 15c each

Fertilizers

LIST PRICE

Analysis	Per Ton	100 lbs.
10-10-10	\$70.55	\$4.85
For: Asparagus, Corn, Peas, Potatoes and non-legume pastures.		
0-14-7	\$42.80*	\$3.15
For: Alfalfa, Clover, Soybeans, Cowpeas, Corn, Wheat, Rye, Winter Barley, Pastures, Turf Grasses, Home Lawn.		
10-6-4	\$62.10*	\$4.65
For: Top Dresser, Spinach, Kale, Cabbage, Lettuce, Mustard, Turnip Greens.		
3-12-6	\$47.45*	\$3.50
For: Sweet Corn, Field Corn, Tomatoes.		
4-12-8	\$52.90*	\$3.85
For: Snap Beans, Tomatoes, Asparagus, Potatoes, Sweet Potatoes, Carrots, Parsnips, Turnips.		
5-10-5	\$48.55*	\$2.90
For: Peas, Beans, Sweet Corn, Strawberries, Potatoes, Asparagus, Leafy Vegetables.		
0-20-0	\$35.65*	\$2.35
20% Superphosphate		

* Ton Price, less 10% C.O.D. If hauled from factory deduct \$2.00 additional per ton.

Agricultural Chemicals, Etc.

	10 lb.	25 lbs.	100 lbs.
Aluminum Sulphate	\$.10	\$.75	\$ 1.50
Asparagus Salt40	.75
Borax10	.60
Calcium Chloride60	1.25
Copper Sulphate (powdered)30	2.00	4.25
Epsom Salts10	.75	1.50
Hydrated Lime (50 lbs., 75c)25
Iron Sulphate (Crystal) ..	.20	1.00	2.00
Muriate of Potash.....	.10	.75	1.50
Nitrate of Soda.....	.10	.80	1.50
Sulphate of Ammonia....	.10	.75	1.50
Sulphate of Potash.....	.10	.75	1.50
Super Phosphate (20%)..	.10	.40	.75
Top Soil (500 lbs., \$6.00) ..		.20	.50
Zinc Sulphate20

BUCKWHEAT HULL MULCH

During the growing season it keeps soil cool and moist, discourages weeds, presents smooth clean appearance. In winter it reduces alternate freezing and thawing, thus protecting roots from destructive heaving. Does not form crust but permits even light rains to reach the soil. Packed in 50 lb bags (covers about 65 sq. ft. 2 in. deep), \$1.60; 250 lbs., \$7.75; 500 lbs., \$14.50; Ton, \$50.00.

VERMICULITE (Terra-Lite Brand)

Expanded Vermiculite is a new sensational sterile, inert, plant growing medium obtained from natural deposits in Montana. Work done by the U.S.D.A. at Beltsville and Glen Dale, Md., definitely proves this propagating material far superior to mixtures of sand and soil, sphagnum moss, etc., for producing the finest seedlings and best rooted cuttings. Processed at 2200° heat, there are no weed seeds, no disease organisms, no "dampening off". It holds water, air and applied plant foods readily available, therefore seeds germinate quickly, grow faster with much stronger roots and therefore transplant better. Cuttings of even very difficult varieties are easily rooted. Vermiculite has many other horticultural uses such as soil corrective, mulch, for bulb storage, etc. 20 lb. bag, \$2.25; 12 lb. bag, \$1.75; ½ Bu., 85c; ½ Pk., 40c.

Soil Conditioners

(FOR CLAY SOIL)

1 lb. treats approx. 10 sq. ft. 6 in. deep or 300 sq. ft. for surface mulch.

Convert hard clay soil into good tillable top soil. These chemicals act upon the intensely fine particles of clay, combining them into larger loam-like particles. Two formulations are offered; dry and soluble. The thoroughness of mixing the dry form determines the quality of the resulting soil. The liquid form too, acts only by direct contact with the clay particles and it is therefore necessary to carefully break up the clay, the finer the better, so the solution can give maximum results. Choosing between the dry or liquid form is a matter of opinion as to which is most convenient to the individual gardener and his particular soil problem.

Either form properly applied will enable roots to thrive and produce normal plants. Soil conditioners do not replace plant foods, therefore it is necessary to fertilize as usual.



Krilium*

SOIL CONDITIONER
Special **MERLOAM** Formulation



KRILIUM (Merloam). Dry formulation. Mix thoroughly with clay soils, 6 in. deep for gardens or ½ in. deep for surface treatment on crusted lawn soils or to help control erosion. 1 lb., \$1.39; 5 lbs., \$4.95.



SOILIFE

DRY DUST. ½ lb., \$1.00; 1 lb., \$1.40; 3 lbs., \$3.00

WETTABLE FLAKES (Concentrated). ¼ lb., \$1.25; ½ lb., \$2.00; 1 lb., \$3.75; 2 lb., \$6.75.

A.C.P. SOIL CONDITIONER

Contains the two types of acrylonitrile plus fertilizer, plant hormones and essential mineral elements. Powder can be worked into the soil or mixed with water and sprinkled on. ½ lb., \$1.00; 2½ lbs., \$3.55; 10 lb., \$10.90.

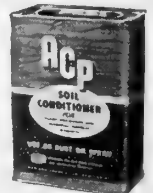

Hyper-Humus

Completely organic, maintains high soil fertility by bacterial conversion. Worked into the soil before planting it makes poor soil loamy and holds moisture and plant foods where they do the roots most good. For faster results add 5 to 10 lbs. organic plant food per 100 lbs. Humus.

AMOUNT TO APPLY PER SQUARE FOOT

NEW LAWNS, 1 to 3 lbs.; **OLD LAWNS,** 1 to 2 lbs.
GARDENS AND FLOWER BEDS, 2 to 4 lbs.

5 lbs., 25c; 10 lbs., 40c; 25 lbs., 90c; 50 lbs., \$1.40; 100 lbs., \$2.25; 500 lbs., \$10.00; 1000 lbs., \$17.50; ton, \$32.00. Let us quote 5 ton and carload lots.

Peat Moss

Promotes Growth by Improving Texture of Soils and as a mulch, keeps roots moist and cool; discourages weeds. Ideal for rose beds and perennial borders.

Standard Bale (approx. 36x19x19) 100 to 120 lbs. when packed. German Horticultural \$4.65; Bu., 75c; ½ pk., 20c.

KNOW which elements are needed in your soil



Practical tests with the Sudbury Soil Test Kit will show the acidity of soil and any possible deficiency in nitrogen, phosphorus, and potash. Each kit is accompanied by complete instructions and tables of plant needs.

2 MINUTE ACIDITY KIT—Tests for acidity only. Complete with instructions and charts.....\$1.49

HOME GARDEN MODEL (as illustrated) — Contains enough soil testing solutions to make 20 individual tests. \$2.98

POPLAR GARDEN MODEL—Makes 50 individual tests for nitrogen, phosphorus, potash and acidity. Cased in handsome sturdy imitation leather.....\$5.89

HORTICULTURAL—In permanent metal case. Contains sufficient chemical for 60 individual tests for nitrogen, phosphorus, potash and acidity. Case contains test tube rack, extra test tubes, special glass funnels, color charts and a supply of filter paper.....\$14.95

DELUXE—Widely used by large growers, nurseries and government departments. Makes 200 individual tests for nitrogen, phosphorus, potash and acidity. In handsome steel carrying case with complete instructions.....\$29.95

TESTING FLUID for refill. Specify whether for nitrogen, phosphorus, potash or acidity. 2 oz., \$1.00; 8 oz., \$2.00.

ACID OR ALKALINE PREFERENCES

(Letters refer to degree of acidity in chart below)

VEGETABLES, GRAINS, GRASSES, ETC.

AlfalfaA	CucumberB	PotatoesD
AsparagusA	CurrantsC	PumpkinD
BarleyA	EggplantB	RadishB
BeansC	EndiveB	RaspberriesB
BeetsA	GooseberryC	Red CloverB
Bent GrassD	GrapesD	RhubarbB
Blue BerriesE	KaleE	RyeC
Blue GrassA	LaurelE	SpinachB
BroccoliB	LeekB	SquashC
CabbageA	LettuceA	StrawberriesC
CarrotsA	MuskmelonsB	TobaccoC
CauliflowerA	OatsC	TomatoC
CeleryA	OnionsA	TurnipC
ChicoryB	ParsleyA	RutabagaC
CornB	ParsnipsD	WatermelonB
CloverA	PeasB	WheatA
CowpeasC	PeppersC	
CranberriesE	PlumsD	

FLOWERS

AzaleasE	Forget Me Not..A	NarcissusB
AnemoneB	FuschiaB	NasturtiumA
AsterB	GardeniaE	OrchidD
BegoniaB	GenistaA	PansyB
Bleeding Heart..C	GeraniumA	PeonyB
BouvardiaC	GerberaA	PrimulaB
CalendulaA	GladiolusB	PoinsettiaB
Candy-tuftB	GodetiaB	PetuniaA
CannaB	HeatherD	PhloxC
CarnationB	HeliotropeA	PoppyB
CentaureaB	HollyE	Rhododendron..C
CinerariaA	HyacinthB	RoseB
Chrysanthemum..B	Hydrangea Blue..E	St. PauliaB
ClarkiaB	Hydrangea Pink..E	ScabiosaB
ClematisAC	SchizanthusB
ColumbineB	IrisB	SnapdragonB
CosmosB	Lady Slipper...E	StocksB
CyclamenC	LarkspurB	Sweet PeasA
DahliaB	LilacB	TulipsB
DelphiniumC	LilyC	VioletB
DidiscusB	LupineC	WesteriaB
Easter LilyC	MarigoldB	WoodbineB
EuphorbiaC	MignonetteB	YuccaB
FeverfewB	Morning Glory..A	ZinniaB
FernsC	MyosotisB	

4pH	5pH	6pH	6½	7pH	7½	8pH
E	D	C	B	A		
Acid				Alkaline		
Neutral						

B, C, D and E indicate degrees of acidity from 7 pH, which is neutral, to 4 pH which is extremely acid. "A" indicates a slightly alkaline condition.—(1000 lbs. Hydrated Lime per acre will change a sandy loam from pH 5 to pH 6.)

BIRD FEEDERS

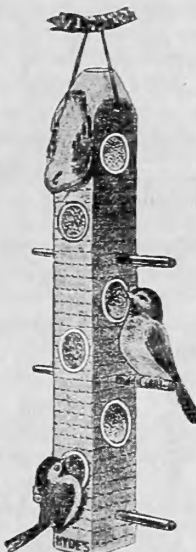

CDD



IDA

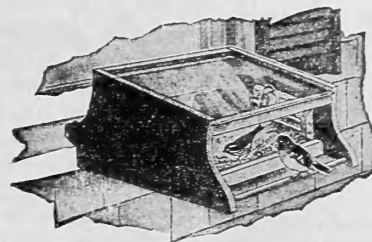

W16

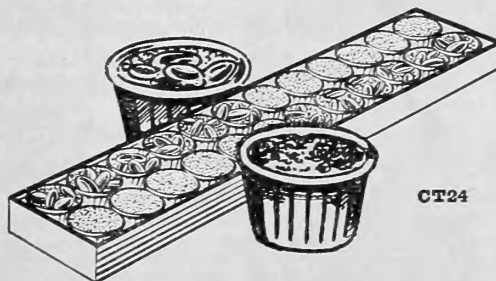

CT24

DIOGENES (IDA), Old fashion lantern design. Made of sturdy metal has glass chimney. Easy to fill, feeds seed automatically. \$4.95

BIRDS FILLING STATION (BH52), Has two cake holders and will hold 4 to 5 pounds of seed. Seed reservoir is glassed in so that one can see when to refill. \$4.25

BIRD CAPE (W16), Glass top protects food from snow and rain, easily attached to window sill from inside. Contains cake holders. \$5.45

COMMUNITY DINER (CDD), For clinging and perching birds. Filled with Seed Suet and Pressed Peanut Suet moulded into paper cups. \$1.65

CHICADEE TIDBITS (CT24), Refills for above box of 24 cups. \$1.25

BIRD SNACK (SS1), Seed Suet Cake. \$35c ea.

WILD BIRD SEED, 5 lb., 75c; 25 lbs., \$3.50; 100 lbs., \$12.00.

SUNFLOWER, Giant plump seed, 3 lbs., \$1.00; 25 lbs., \$7.50; 100 lbs., \$24.50.

RAT KILLERS

WARFARIN. The amazingly effective rat killing ingredient perfected by the Wisconsin Alumni Research Foundation.

K.R.O. CONCENTRATED. Warfarin Rat and Mouse Killer. Active ingredient .5% Warfarin. 2 oz. makes 2½ lbs. bait. 2 oz., \$1.00; 4 oz., \$1.75.

D-CON READY MIX. Active ingredient .025% Warfarin. 1 lb., \$1.69.

SLA-RAT. Contains .025% Warfarin. 8 oz. can, 65c; 1 lb., \$1.00.

RED SQUILL RAT KILLERS are Non-Poisonous to Pets or Live Stock.

K.R.O. Ready Mix. 6 oz., 35c; 1 lb., \$1.00.

K.R.O. Powder. 2 oz. (Mix with 2 lbs. bait) 75c.

RAT NOTS. 9 "Nots", 25c; 50 "Nots", \$1.00.

MOUSE NOTS. 9 "Nots", 25c; 50 "Nots", \$1.00.

INDEX

VEGETABLE SEEDS

Artichoke	3
Asparagus	3
Beans	4, 5, 6
Beets	7
Borecole	18
Broccoli	3
Brussels Sprouts	3
Cabbage	8, 9
Caraway	17
Carrots	10
Cantaloupe	22
Cauliflower	11
Celeriac	13
Celery	12
Chard, Swiss	11
Chicory	13
Chinese Cabbage	9
Chives	13
Collards	13
Corn	14, 15
Corn Salad	13
Cress	13
Cucumber	16
Dandelion	17
Dill	17
Egg Plant	17
Endive	17
Escarolle	17
Fennel	17
Herbs	17
Kale	18, 19
Kohlrabi	19
Leek	19
Lettuce	20, 21
Marjoram	17
Mushroom Spawn	23
Muskmelon	22
Mustard	23
Okra	25
Onion	24
Onion Sets	24
Parsley	25
Parsnips	29
Peanuts	27
Peas	26, 27
Pepper	28
Popcorn	14
Potatoes	32
Pumpkins	29
Radishes	30, 31
Rhubarb	31
Rutabagas	38
Sage	17
Salsify	31
Sorrel	31
Spinach	34, 35
Squash	33
Summer Savory	17
Sweet Potatoes	32
Swiss Chard	11
Thyme	17
Tomatoes	36, 37
Turnips	38
Watermelon	23

FIELD SEEDS, ETC.

Bird Seed	81
Field Seeds	40, 41
Pasture Mixture	41

PLANTS, ROOTS AND NURSERY STOCK

Amaryllis	56
Asparagus Roots	39
Begonias	56
Bleeding Hearts	56
Caladiums	56
Cannas	56
Clematis Vines	50
Daffodil, Peruvian	56
Dahlia Roots	58
Gladiolus	57
Horseradish Roots	39
Iris	56
Lilies	56
Rhubarb Roots	39

Rose Bushes	58
Strawberry Plants	39
Trees	39
Tuberoses	56
Vegetable Plants	39

FLOWER SEEDS

Annuals	43 to 50
Perennials	51 to 55
Vines	50

SUPPLIES, IMPLEMENTS, ETC.

Adco	79
Aerifier	68
Agrico	78
Ant Traps and Sets	60
Arsenates	60
Asparagus Bunchers	66
Asparagus Knives	66
Asparagus Salt	80
Axes	67
Back Bands	68
Bag Balm	76
Bamboo Stakes	65
Barbed Wire	75
Bee Supplies	77
Belting	76
Benzo-Fume	60
Berry Boxes	39
Bird Feeders	81
Black Leaf Forty	60
Blood Meal	79
Bone Meal	79
Bordeaux Mixture	60
Brooders	74
Brooder Thermometers	74
Broom Rakes	67
Brooms	67
Brush Hooks	67
Butter Coloring	76
Butter Paper	76
Calf Weaners	76
Caponizing Sets	73
Carbola	60
Carbolineum	60
Carbon Di-Sulphide	60
Caulking Gun	65
Cemetery Vases	65
Chains	75
Charcoal	78
Cherry Seeder	76
Chicks	78
Churns	76
Copper Arsenate	60
Copper Sulphate	60
Cordage	68
Corn Ear Worm Drops	60
Corn Planter	15
Corn Shellers	77
Cow Manure	79
Crow Repellent	60
Cucurbit Dust	60
Cultivators	71
Cyano Gas	60
DDT	60
De-K-Pruf	60
DX	61
Dairy Supplies	76
Dibbles	66
Dinitro	62
Dog Food	73
Dog Repellents	61
Drag Scoop	72
Dusters	64
Earth Augers	75
Egg Baskets	74
Egg Candler	74
Egg Cartons	74
Egg Cleaners	74
Egg Grading Scale	74
Egg Preservative	74
Electric Farm Fence	75

Ensilage Forks	67
Esskay Plant Food	79
Fertilizer	78, 79
Fertilizer Distributors	72
Fish Oil Soap	61
Flame Sprayer	64
Floralife	79
Flower Guard	75
Flower Pots	65
Formaldehyde	61
Fountain Heaters	74
Evergreen	61
Fruitone	79
Fruit Pickers	66
Fungtrogen	61
Garden Cart	68
Garden Trowels	66
Glass	65
Glazing Points	65
Glazing Putty	65
Gloves	69
Grafting Wax	66
Grape Dust	61
Grass Catchers	69
Grass Hooks	67
Grindstones	76
Grit	73
Halter Chains	75
Handles	72
Hand Weeders	66
Harrowes	72
Hay Carriers	76
Hay Forks	67
Hedge Shears	66
Hoes	67
Hole in One Tools	66
Honey Jars	77
Horse Hoes	71
Hose	66
Hose Reels	75
Hot Bed Heater	65
Hotkaps	68
Hyacinth Stakes	65
Hydrated Lime	80
Hyper Humus	80
Hy-Gro	78
Hyponex	78
Ice Cream Freezers	76
Incubator Thermometers	74
Insecticides	60, 61, 62, 63
Knee Pads	68
Kryocide	62
Ladders	76
Lawn Edgers	67
Lawn Fence	75
Lawn Gates	75
Lawn Mowers	70
Lawn Rollers	69
Lawn Sprinklers	69
Leg Bands	74
Lime Spreader	72
Lime and Sulphur	62
Mail Box	77
Manure Forks	67
Mattocks	67
Meat Curing Products	77
Metal Egg Crates	74
Mole Nots	62
Mole Traps	66
Mologen	62
Neponset Pots	65
Nico Fume	62
Nitragin	79
Norcross Cultivators	67
Nozzles	66
Oyster Shell	73
Paradichlorobenzene	62
Para-Scalecide	62
Paris Green	62
Peat Moss	80
Pestex	62
Phygon	62
Planet Jr. Implements	71
Plantabbs	75
Plant Bands	68
Plant Boxes	65
Plant Forcer	65
Plant Setter	39
Plant Stakes	65
Pomo Green	62
Pot Labels	65
Post Hole Diggers	75
Potato Hooks	67
Potato Mix	62
Poultry Feeds	73
Poultry Fencing	75
Poultry Killer	74
Poultry Remedies	73
Poultry Supplies	73, 74
Pruners	66
Pruning Paint	62
Pyrox	62
Raffia	68
Rakes	67
Rat Exterminator	81
Red Arrow	62
Roofing Materials	75
Rootone	79
Rotenone Dust	62
Rubber Bands	68
Salt Bricks	76
Saw Blades	76
Saw Frames	76
Saws	76
Scalecide	62
Scales	74
Scrapers	67, 72
Scythes	67
Scythe Stones	67
Seeders	71
Selocide	62
Sheep Manure	79
Semesan	61
Shovels	67
Slug Shot	62
Snarol	63
Snaths	67
Soil Conditioners	80
Soil Fumigants	61
Soil Soaker	66
Soil Tester	81
Spades	67
Spading Forks	67
Spergon	63
Spike Tamp	69
Spray Catalizer	60
Spray Chart	59
Sprayers	64
Spraying Materials	60, 63
Spreaders	72, 78
Sprinklers	69
Stalls	76
Stanchions	76
Stock Tonic	76
Sulphur	63
Sulfocide	63
Teat Dilators	76
Thermometers	66
Tobacco Dust	63
Tobacco Stems	79
Tomato Dust	63
Tractors	71
Transplanters	72
Transplantone	79
Traps	66
Tree Labels	65
Tree Pruners	66
Tree Banding Compound	63
Tri-ogen	63
Turkey Poults	73
Twistems	68
Vegetable Tying Mach's	72
Vermiculite	80
Vigoro	78
Volck	63
Watering Pots	65
Weed Cutters	67
Weeders	67
Weedone	63
Weed Killer	63
Weed Slugger	67
Wheelbarrows	68
Wheel Hoes	71
Window Boxes	65

LAWN MAKING AND MAINTENANCE

The very best time of the year to make a new lawn is early in the fall because of ample rainfall, continued cool weather and the winter killing of many weeds. The second best season is very early spring (March and April) because there is sufficient rainfall and cool weather to start the young grass quickly. Spring seeding however must compete with weed seeds in the soil and is sometimes damaged by hot dry weather before it is thoroughly established.

Preparing the Soil

Preparation of the soil is the most important part of lawn making and should have the most careful attention because no amount of effort spent after a lawn is made can equal the results of thorough tillage before the seed is sown.

A successful lawn requires at least 2 to 4 inches of good quality top soil possessing the organic matter and plant foods necessary for sturdy growth of the grasses. However six inches or more of thoroughly prepared finely pulverized and fertilized top soil would be ideal.

If existing top soil is of fair quality and at least 2 to 4 inches deep it should not be necessary to spread additional top soil. It is essential though to apply a good lawn fertilizer which is high in phosphate (such as bone meal or the chemical lawn foods) at the rate of 2 to 4 lbs. per 100 sq. ft. In addition to this an application of a one inch layer of humus or a two inch layer of well rotted manure (it must be very well rotted to be weed free) is necessary to supply sufficient organic matter.

After spreading the plant food and humus materials evenly, they must then be spaded into and mixed with the top soil to a depth of about six inches depending on the quality of the sub-soil and the depth of the top soil. When this newly processed top soil is completely broken up and thoroughly mixed it should be raked and rolled in both directions until there are no uneven places. A good seed bed has now been prepared and is ready for seeding.

Sowing the Seed

Sow at the rate of 1 lb. to 200 sq. ft. broadcasting half of the seed in one direction and the other half at right angles. If the soil is dry the surface may be raked very lightly covering seed not over $\frac{1}{8}$ in. and being extremely careful to avoid "bunching" the seed. Rolling is desirable but only practical if the soil is sufficiently dry so that the seed does not stick to the roller. Many successful lawns are made without raking or rolling in the seed by depending upon the rain or watering to pack the soil firmly about the seeds. If watering is once begun however the soil must be kept damp continuously or the seed may sprout and die off before it has rooted. Clipping should begin when the grass is about 3 inches high but should not be cut closer than 2 inches.

Re-Seeding Old Lawns

Thin turf or lawns with bare spots can be rebuilt by raking lightly so that the existing grass is not damaged and then seeding as though making a new lawn. Another satisfactory method is to mix seed with top soil or sow the seed

and then cover lightly with top soil. In either case the top soil should be free from weed seeds. If the seed is sown early in March it can be broadcast without raking or rolling because the ground is "open" and the late wet snows will carry it in.

Fertilizing

Timely and ample applications of fertilizers have double advantages. Very early feeding whether Spring or Fall forces growth of the grass during its most natural growing seasons, thereby helping it to crowd out crab-grass and more easily survive hot dry summer weather. A strong healthy turf also stands the rigors of winter so much better. Fertilizer materials are most accurately and easily applied by using a fertilizer spreader. Most materials should be applied when the grass is dry at the rate of 2 to 4 lbs. per 100 sq. ft. then watered in. Lawns that are thoroughly established and are thriving should be fertilized once every two years but average lawns require at least one feeding a year.

Rolling

During the winter the alternate freezing and thawing have played "tug-o-war" with the little grass plants in your lawn, heaving them out of the ground so that they are only partly rooted. It is therefore extremely necessary to roll your lawn after the frost is out of the ground and while it is still wet but not soggy. This smooths out uneven places caused by the frost and puts the grass roots back where they can quickly begin producing a luxuriant lawn.

Weed Control

One of the best weed controls is a good heavy turf, well fertilized very early, cut not shorter than 2 inches and kept seeded to grass so there will be practically no space for weeds to grow. Crab-grass which is perhaps the most difficult weed to combat should be killed by chemicals during June or July. Other chemicals such as 2-4-D are available for clearing lawns of dandelions, plantain and most other lawn weeds.

Soil pH

For most Maryland lawns the pH values (acidity or alkalinity) should be between 6.0 and 7.5, that is ranging between slightly acid to slightly alkaline, 7 being neutral. The grasses which thrive best in this climate succeed best in this pH range. If the soil is strongly acid (pH 4.5 to 5.0) an application of 10 lbs. of ground limestone per 100 sq. ft. will reduce the acidity to approximately pH 6. Lime should not be used on lawns unless an actual soil test indicates excessive acidity.

Moss

The presence of moss is often considered an indication of acid soil, but it is more often the result of low fertility. During March apply nitrate of soda (1 lb. per 100 sq. ft.) This will kill the moss but not injure the grass. In about two weeks the dead moss may be raked from the lawn and if there are bare spots they should be reseeded at once.

ALWAYS SOW MANNS' SUPERIOR LAWN SEEDS

See 2nd Cover Page

MANNS' SUPERIOR SEEDS

Ensor & Forrest Sts.

At Belair Market
(South end of Greenmount Ave.)

Baltimore-2, Md.

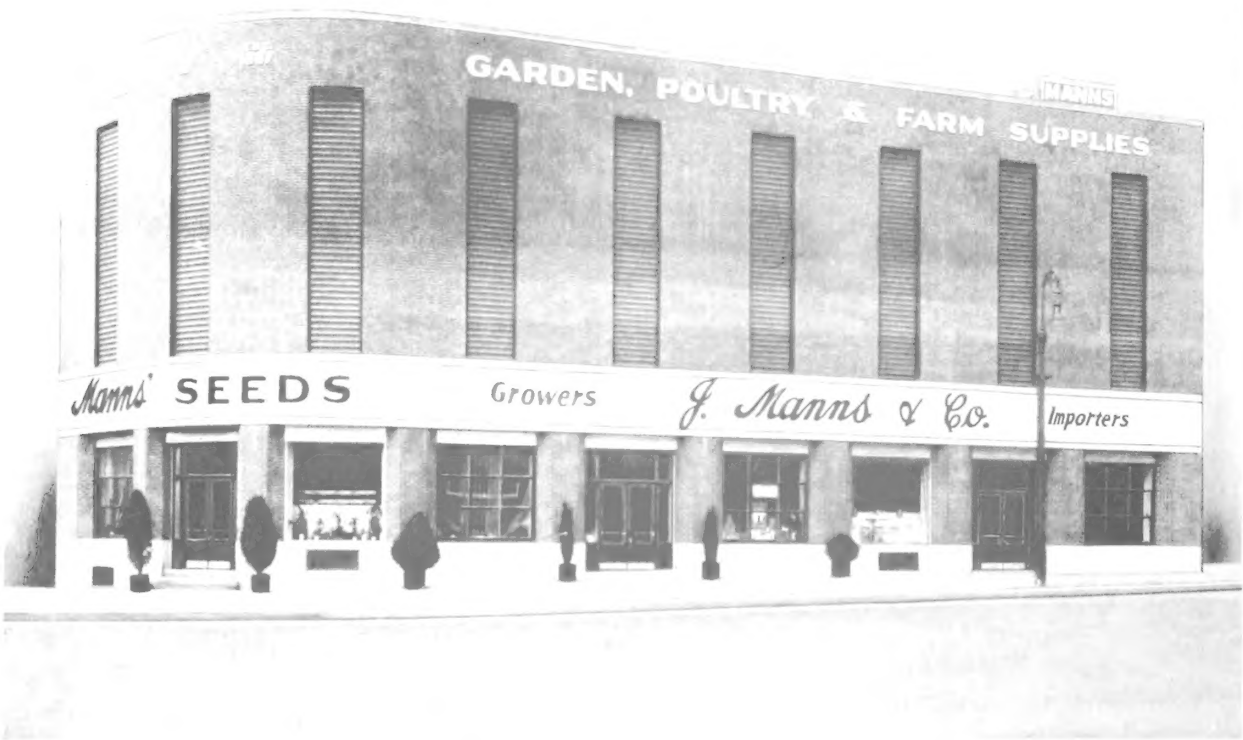

A Convenient, Complete, Modern Seed Store

Plenty of free parking space

Manns is the most accessible seed store in the city. Here you can conveniently buy Superior Seeds, Farm and Garden supplies at reasonable prices — backed by 66 years of reputable service.

ALWAYS EASY PARKING

