

UNIVERSITY
OF
TORONTO
LIBRARY

Mineral.

Traité
de Cristallographie;
Par M. l'abbé Saüy.

ATLAS.

PARIS,
BACHELIER ET HUZARD, GENDRES ET SUCCESEURS DE M^{me} V^e COURCIER,
LIBRAIRES POUR LES SCIENCES,

RUE DU JARDINET-SAINT-ANDRÉ-DES-ARCS, N^o 12.

1822.

89068
16171081

1871



1871

THE GREAT BRITAIN

AND IRELAND

ATLAS

1871

Published by the Admiralty, under the authority of the Board of Admiralty.

London: Printed and Sold by the Admiralty, 1871.

1871

1871

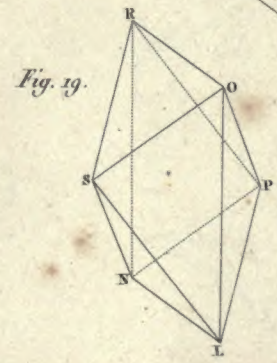
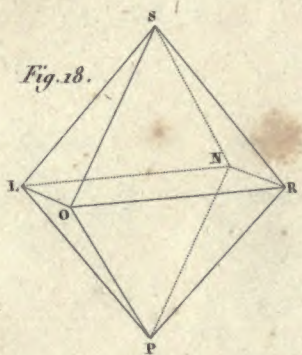
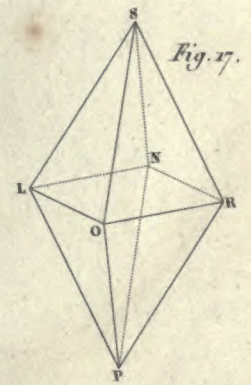
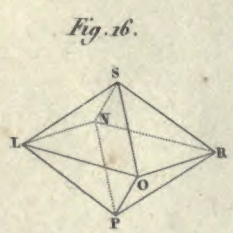
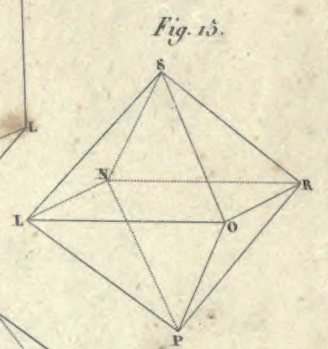
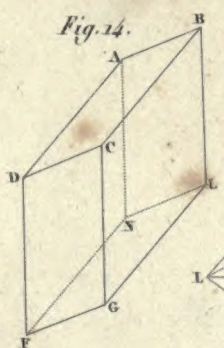
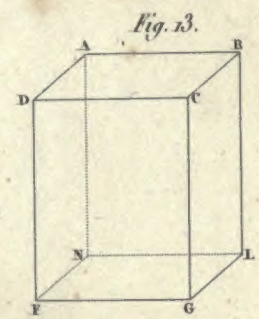
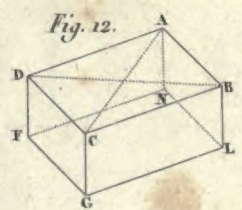
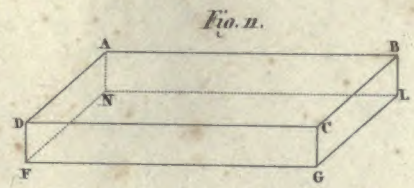
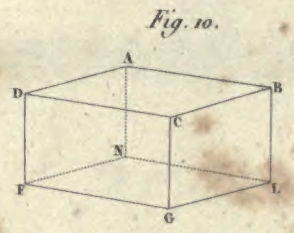
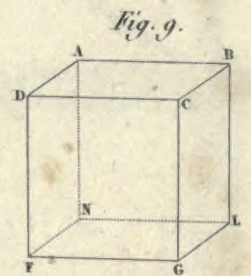
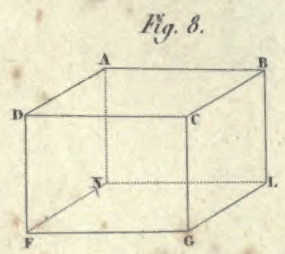
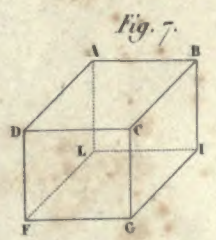
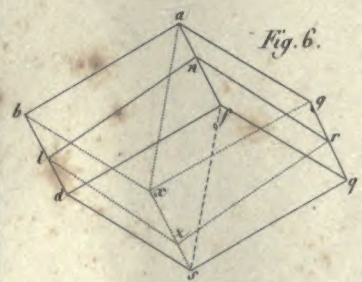
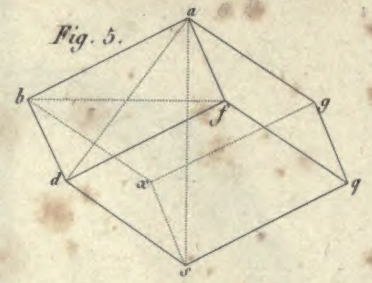
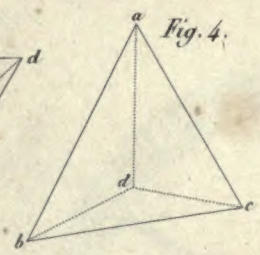
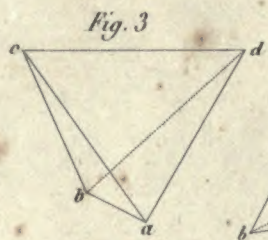
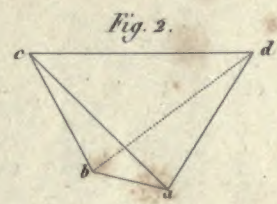
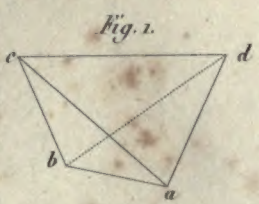

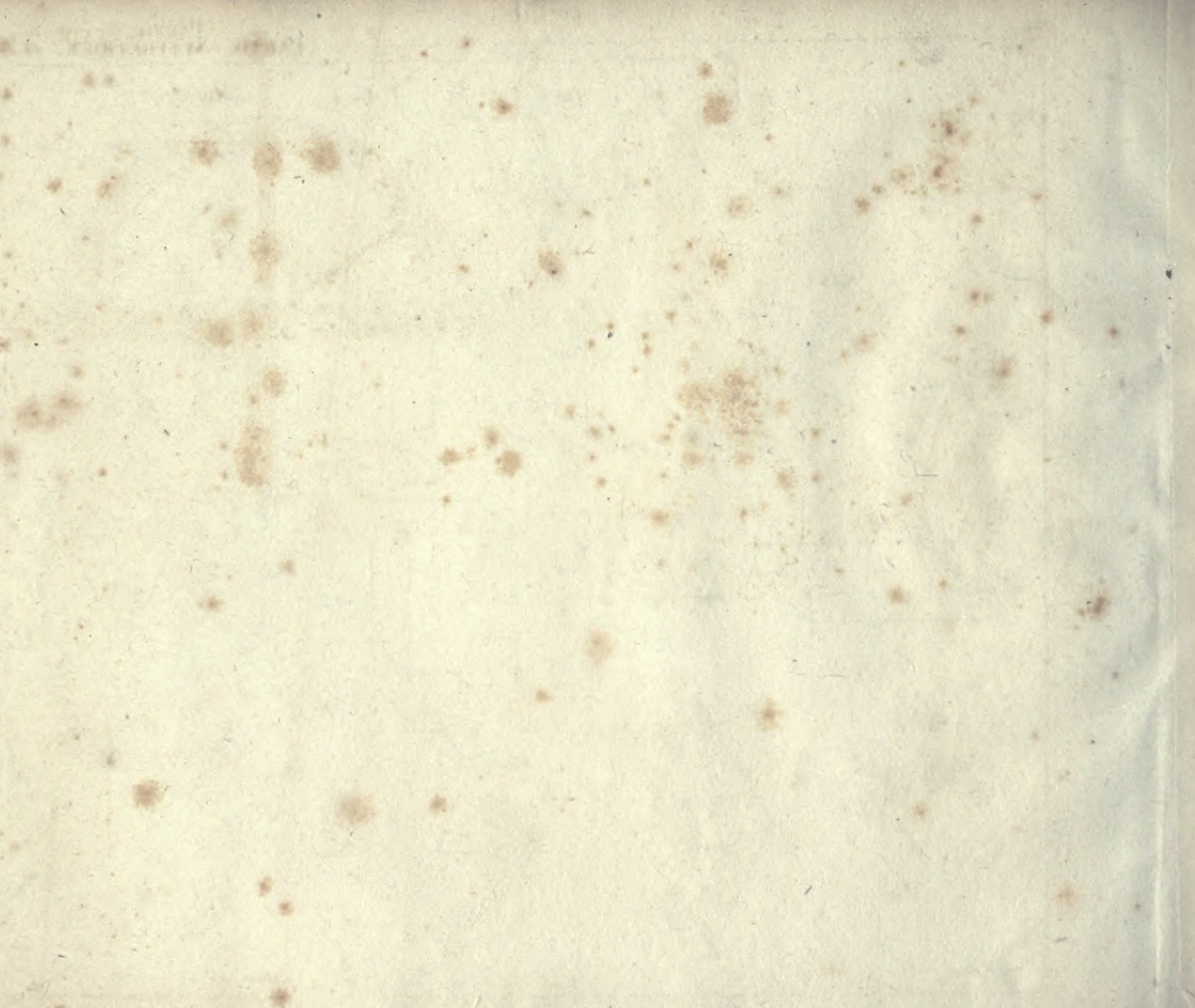

Fig. 20.

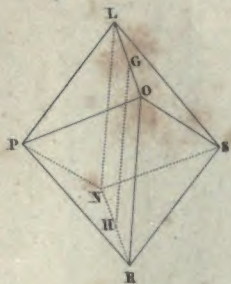

Fig. 21.

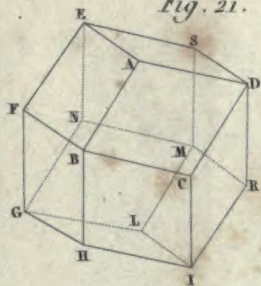

Fig. 22.

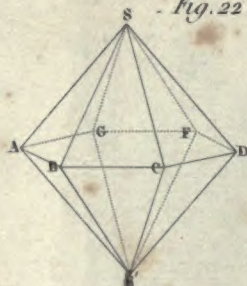

Fig. 23.

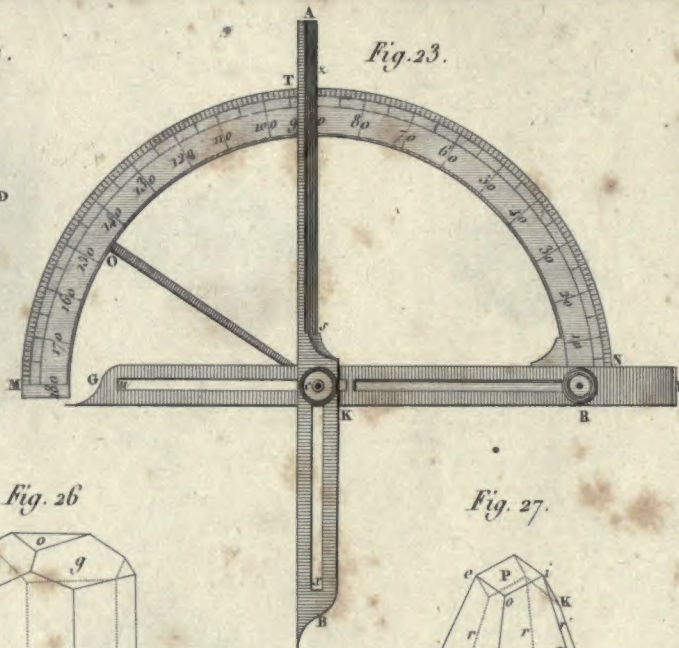

Fig. 24.

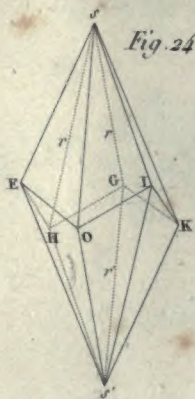

Fig. 25.

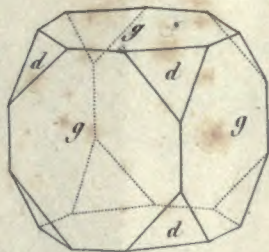

Fig. 26.

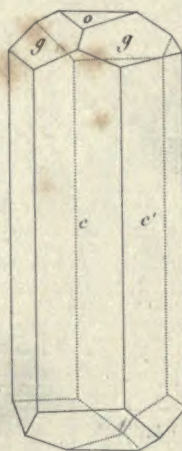

Fig. 27.

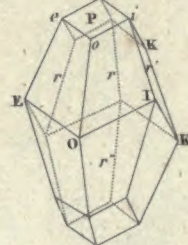

Fig. 28.

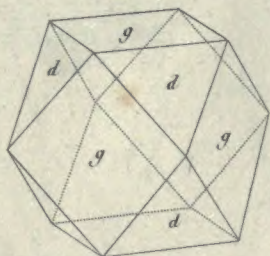

Fig. 29.

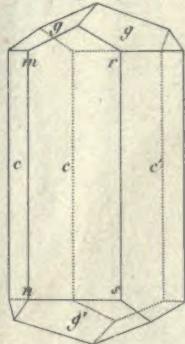

Fig. 30.

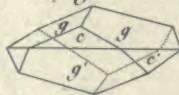

Fig. 31.

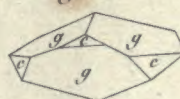
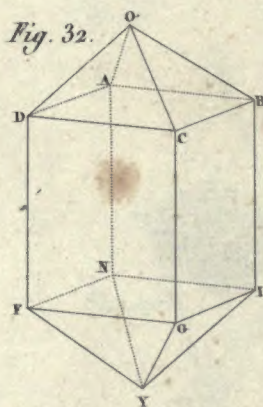

Fig. 32.





Digitized by the Internet Archive
in 2009 with funding from
University of Ottawa

<http://www.archive.org/details/traitdecrystal00ha>

Fig. 33.



Fig. 34.

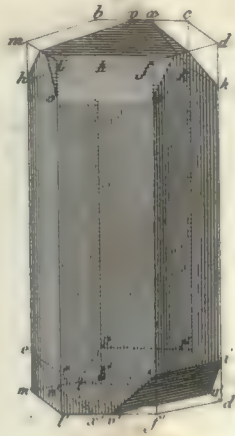

Fig. 35.

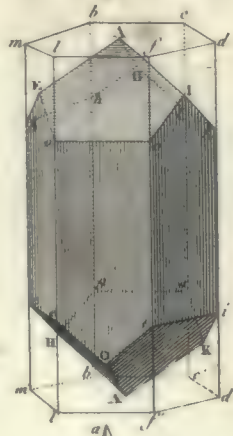

Fig. 36.

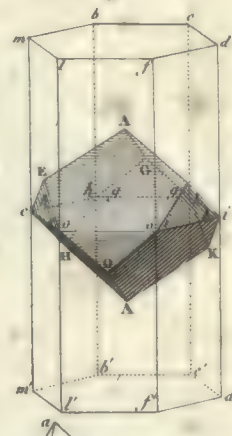

Fig. 37.

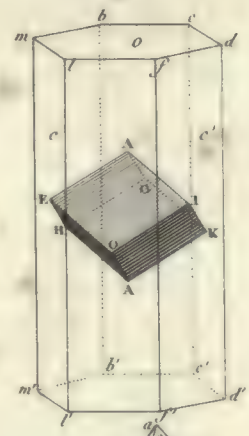

Fig. 38.

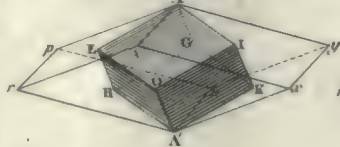

Fig. 39.

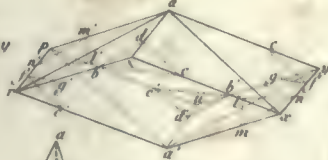

Fig. 40.

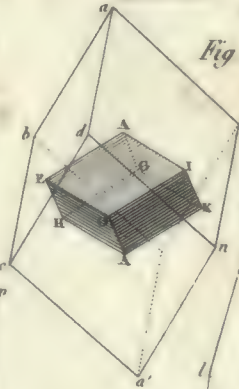

Fig. 41.

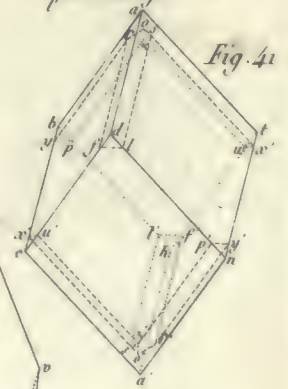

Fig. 42.

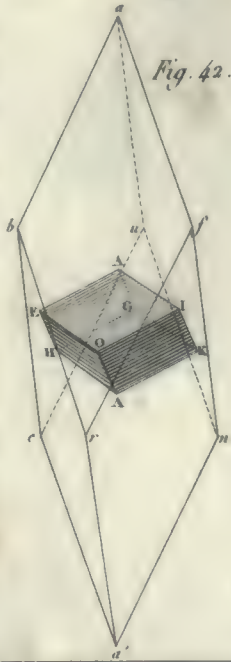

Fig. 43.

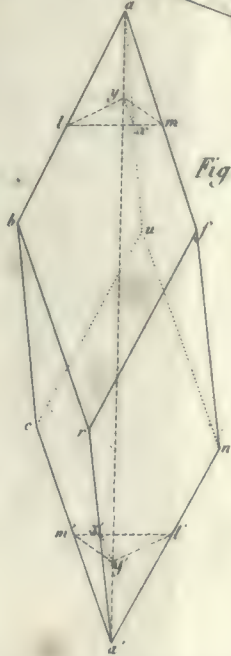

Fig. 44.

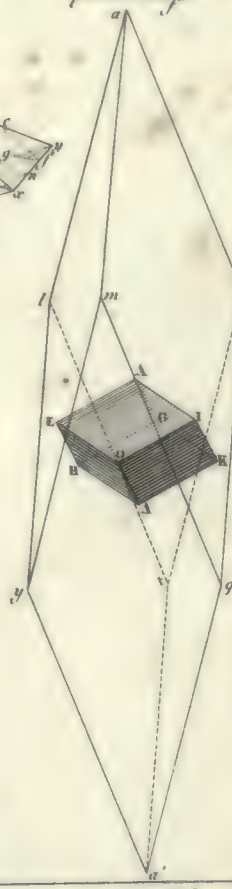
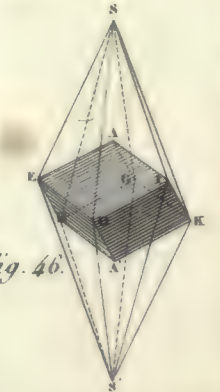

Fig. 45.



Fig. 46.





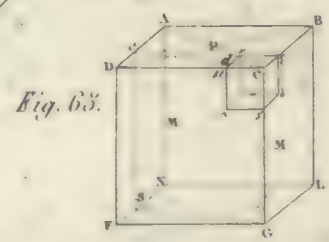
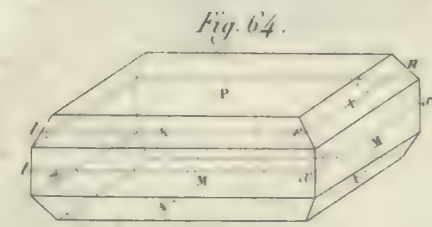
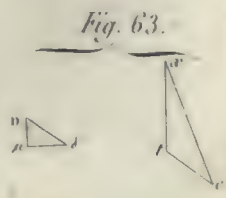
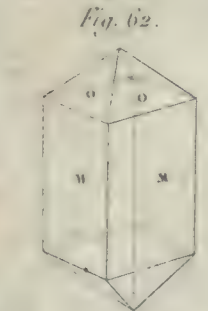
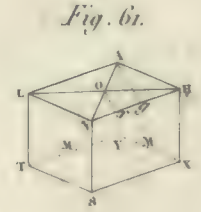
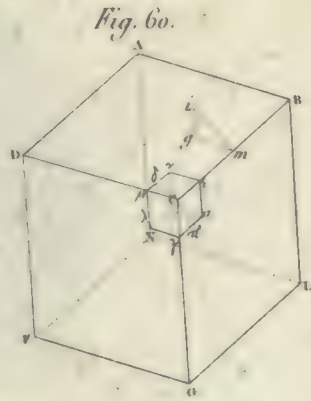
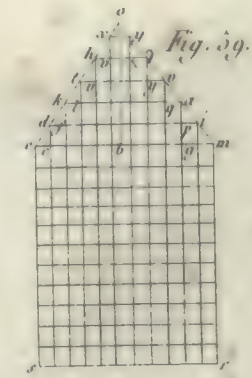
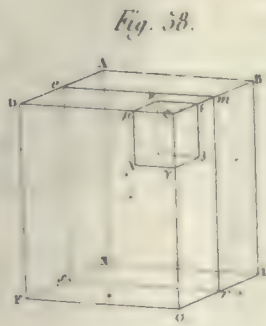
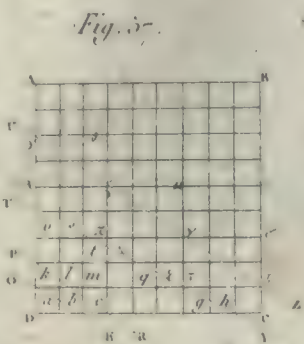
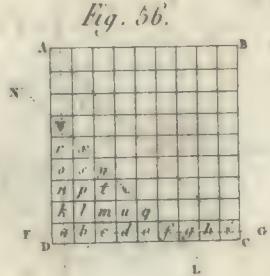
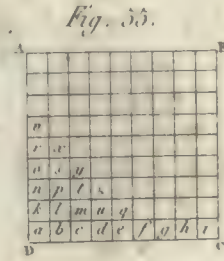
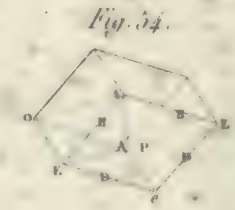
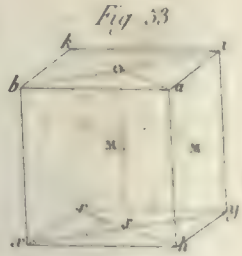
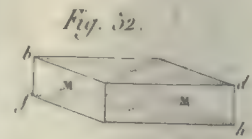
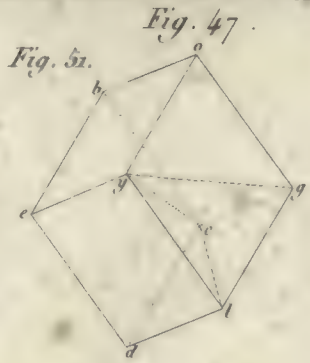
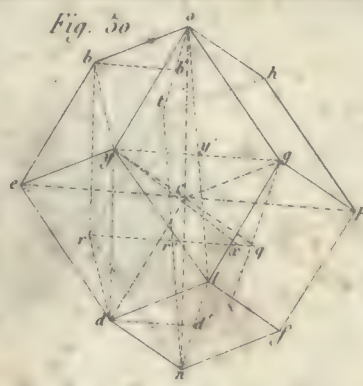
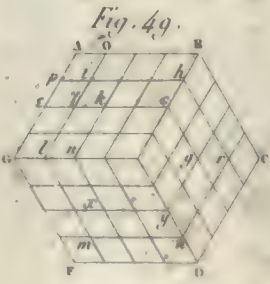
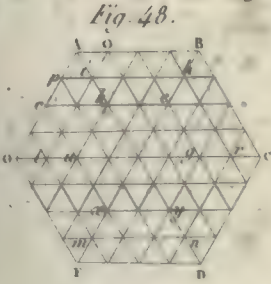
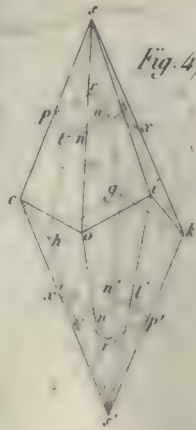



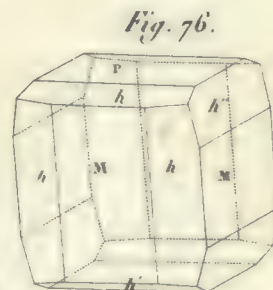
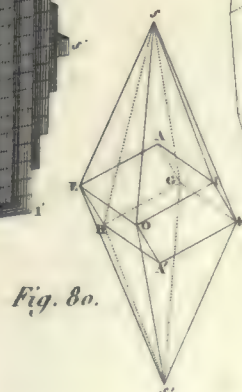
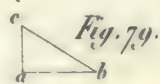
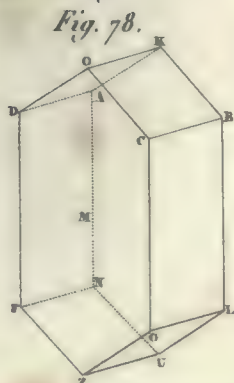
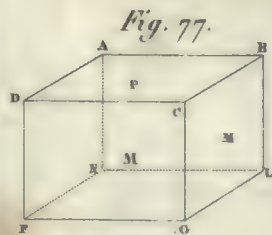
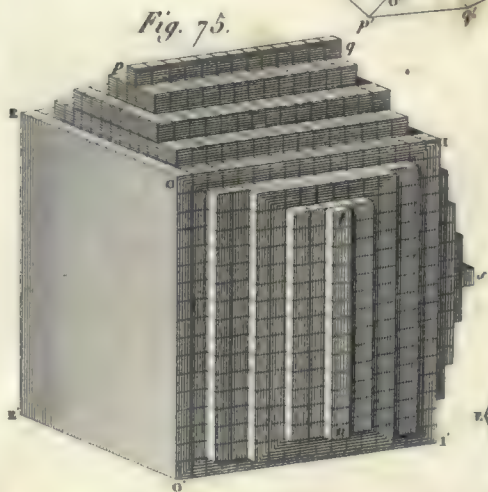
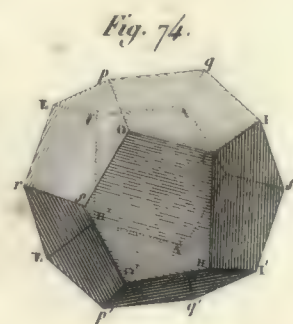
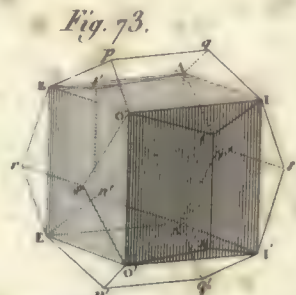
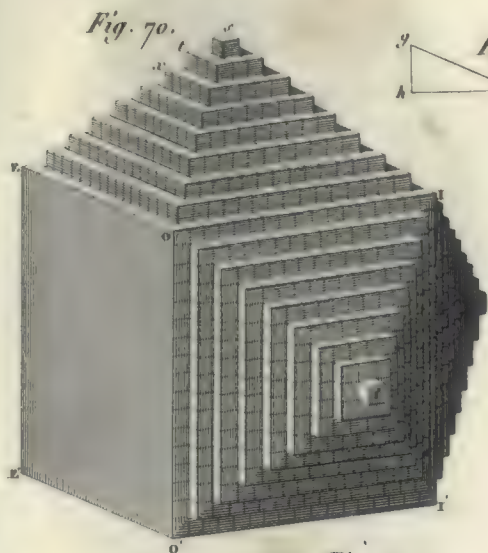
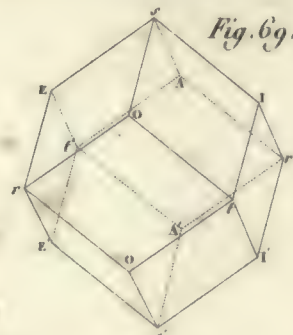
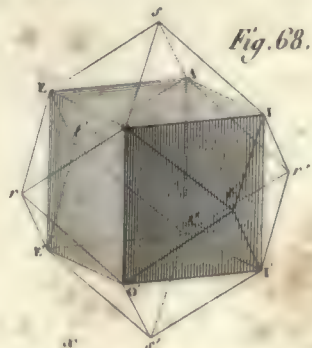
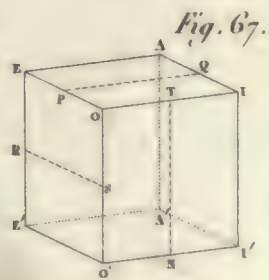
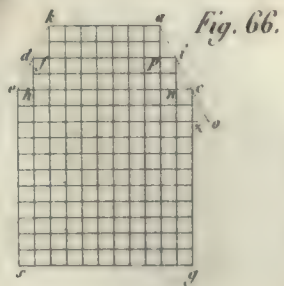



Fig. 81

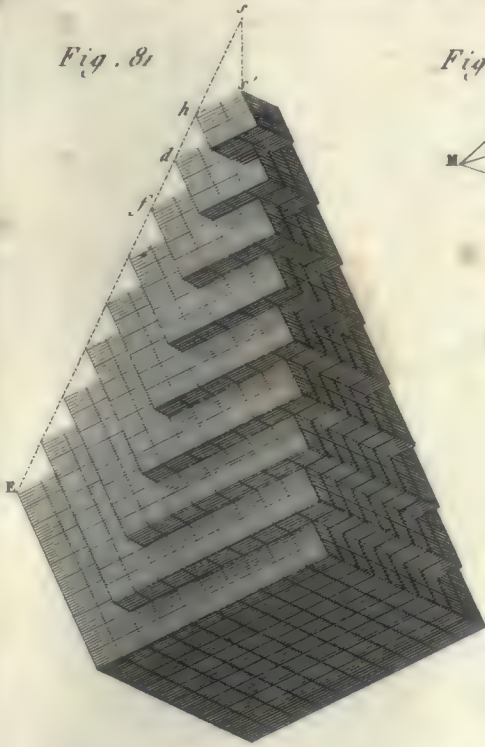

Fig. 82

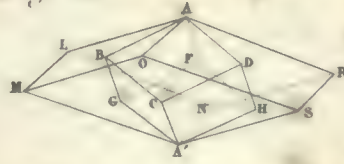

Fig. 83

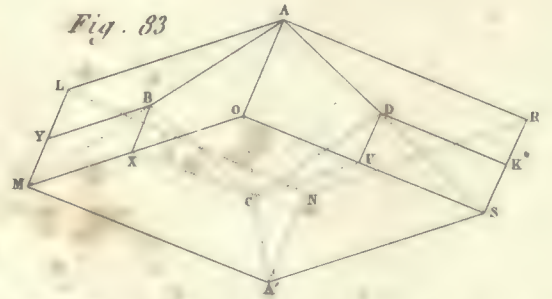

Fig. 84

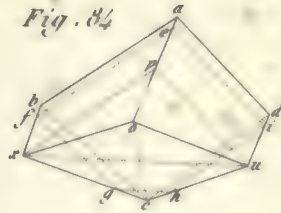

Fig. 85

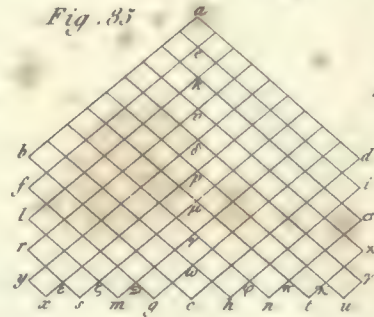

Fig. 86

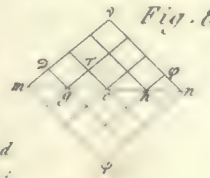

Fig. 88

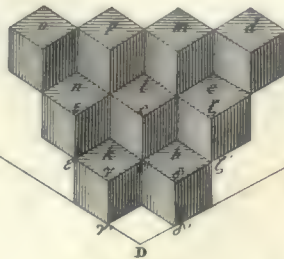

Fig. 90

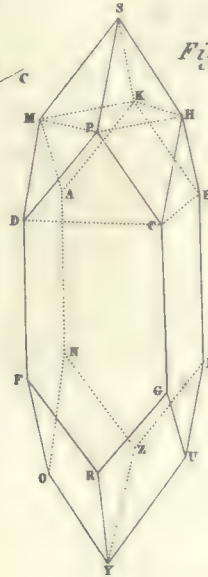

Fig. 89

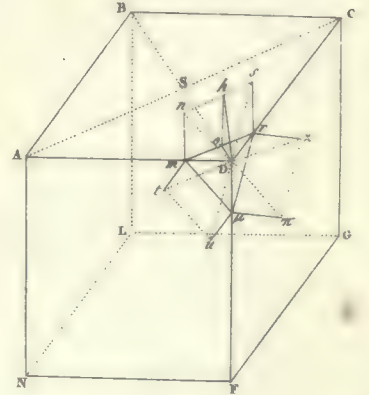

Fig. 87

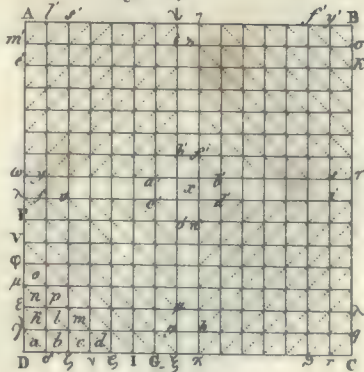
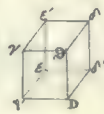

Fig. 92



Fig. 91





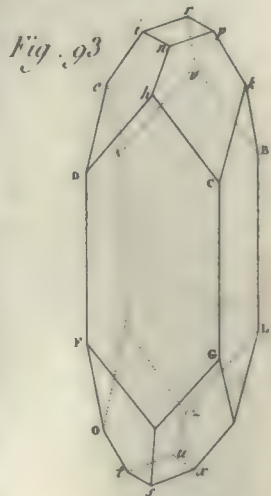

Fig. 94



Fig. 97



Fig. 95

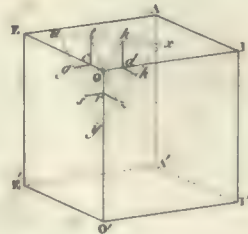

Fig. 96

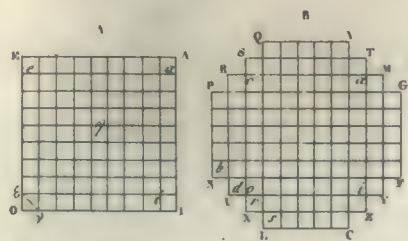
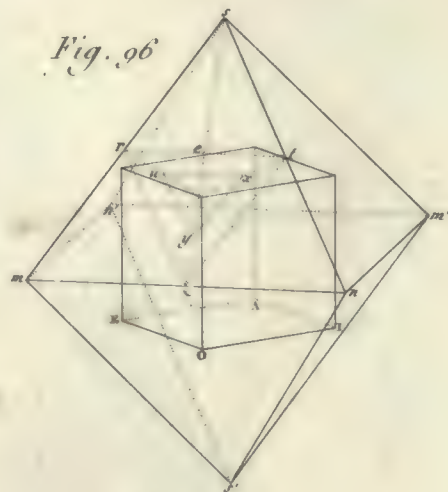

Fig. 98

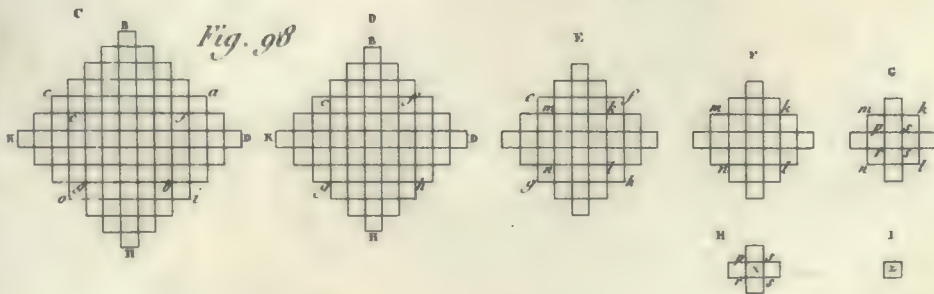

Fig. 99

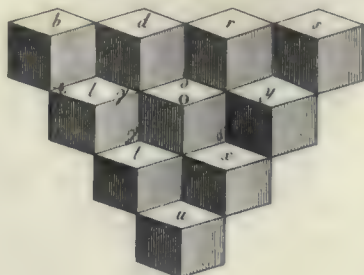

Fig. 100

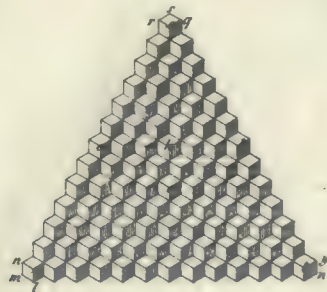

Fig. 101

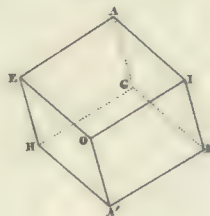

Fig. 102

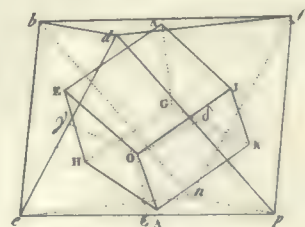



Fig. 103



Fig. 104



Fig. 105

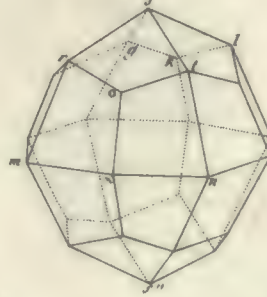

Fig. 106

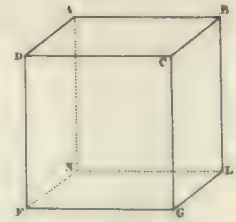

Fig. 111

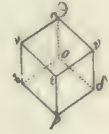

Fig. 108

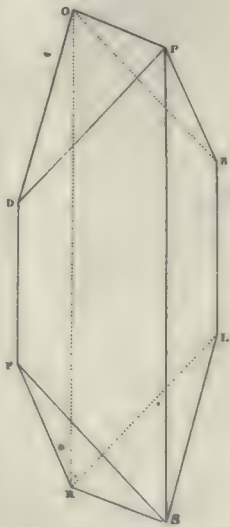

Fig. 109

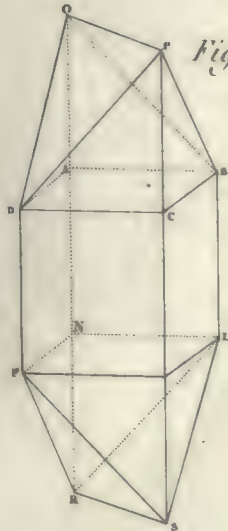

Fig. 110

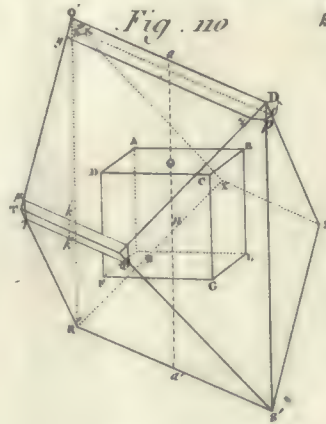

Fig. 107

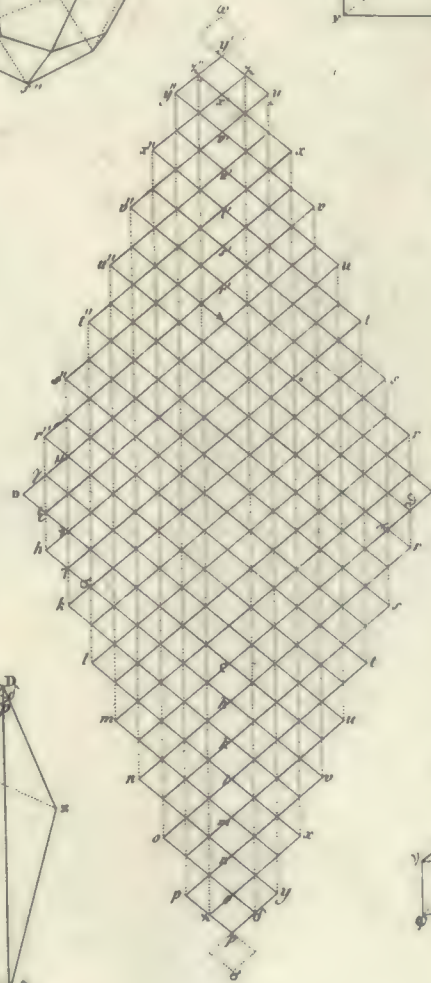

Fig. 112

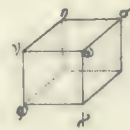



Fig. 113

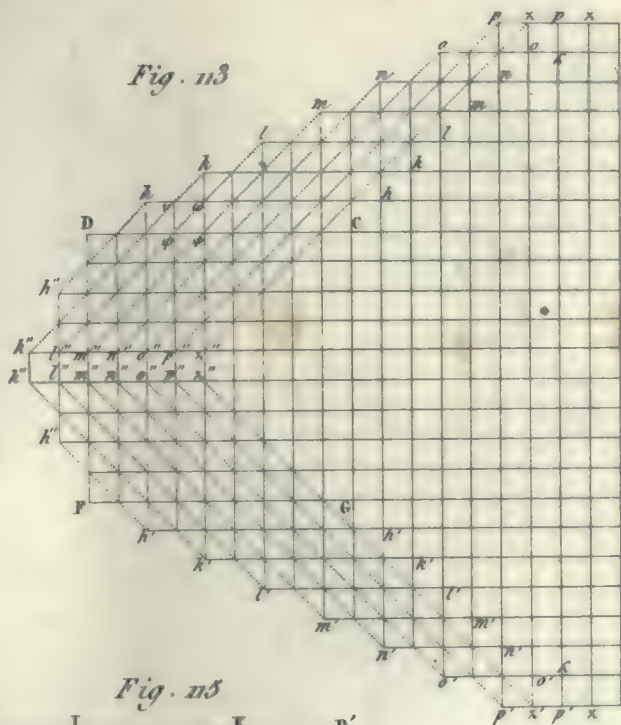

Fig. 114

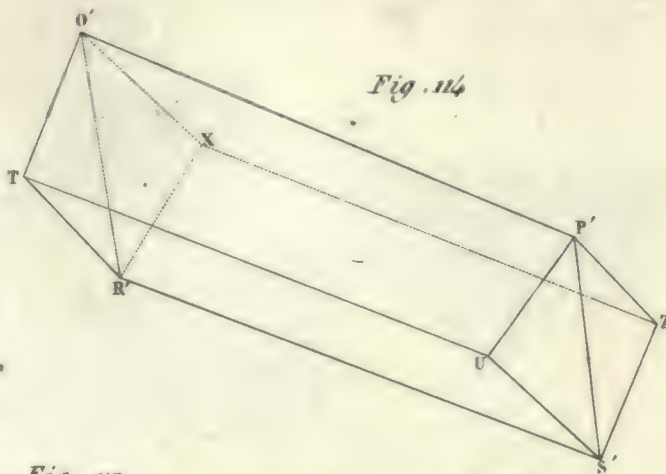

Fig. 117

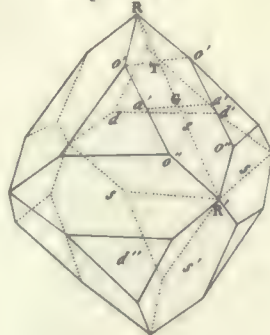

Fig. 119

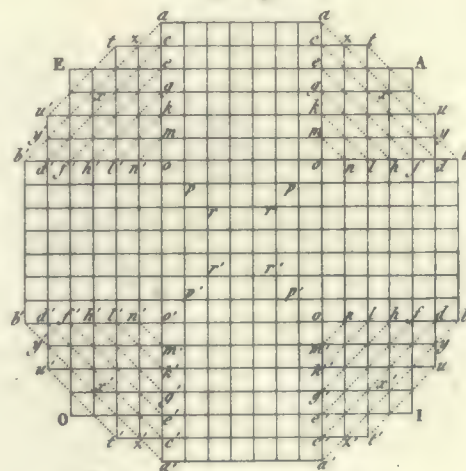

Fig. 115

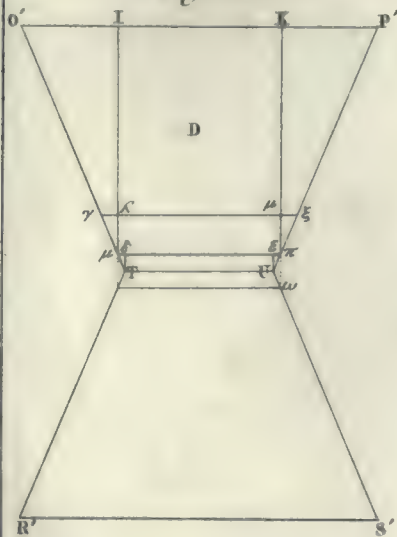

Fig. 110

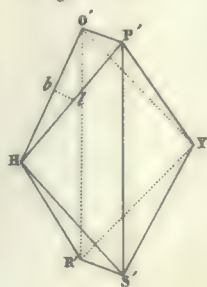

Fig. 118

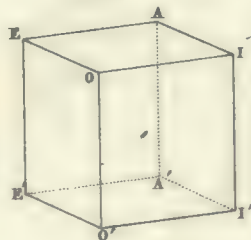

Fig. 120

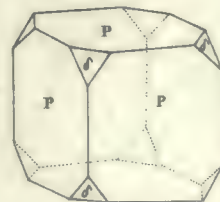

Fig. 121

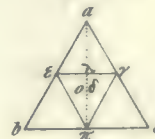



Fig. 122

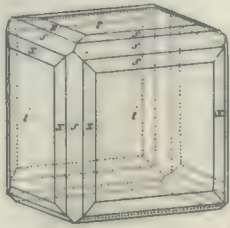

Fig. 123

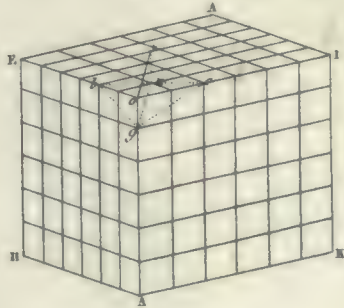

Fig. 124

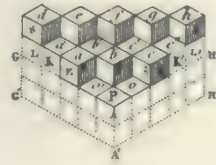

Fig. 125

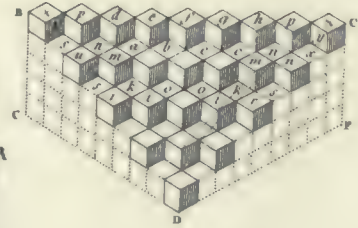

Fig. 128

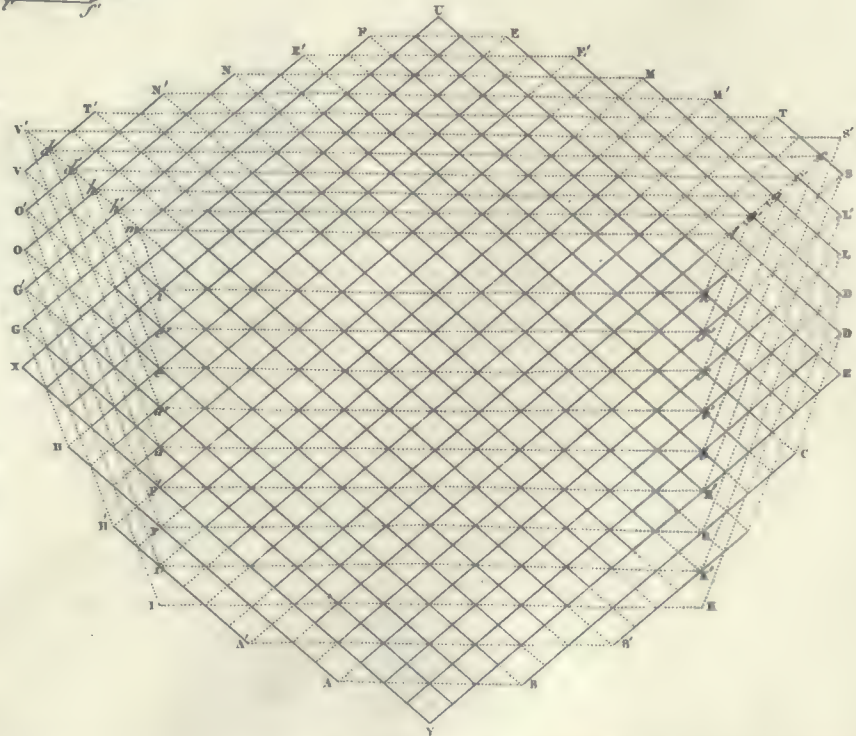

Fig. 127

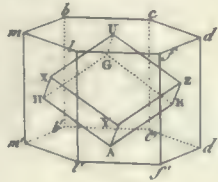

Fig. 126'

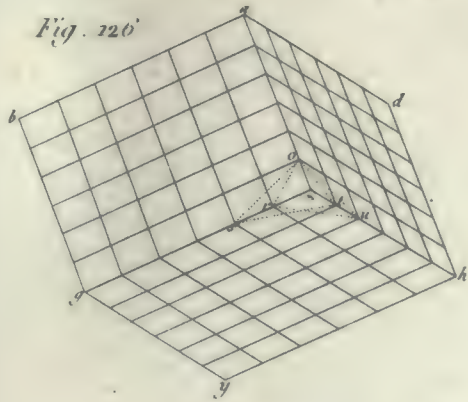

Fig. 130

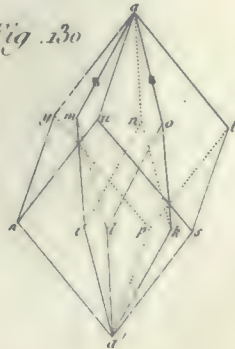
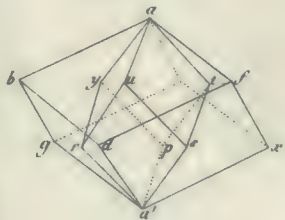

Fig. 129



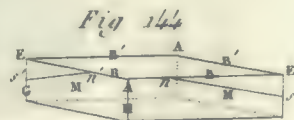
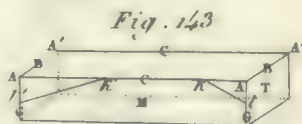
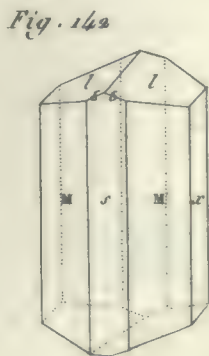
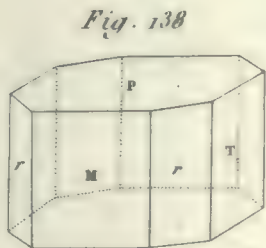
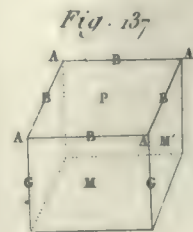
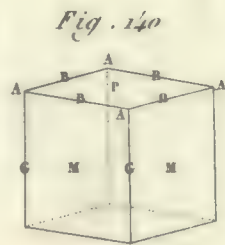
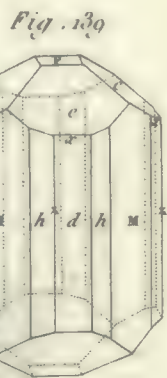
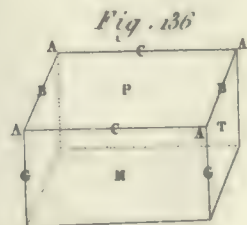
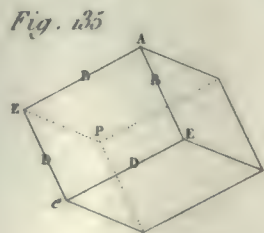
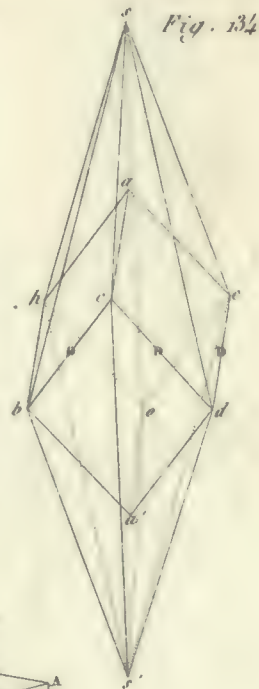
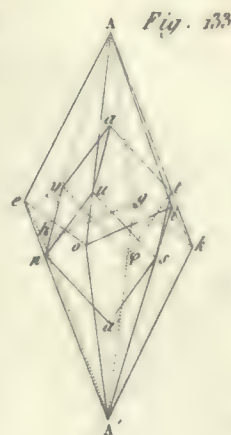
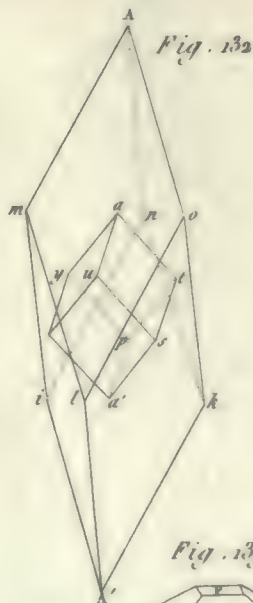
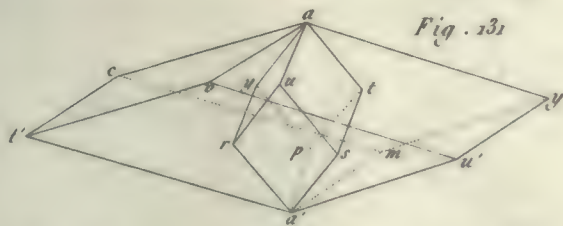

Fig. 146

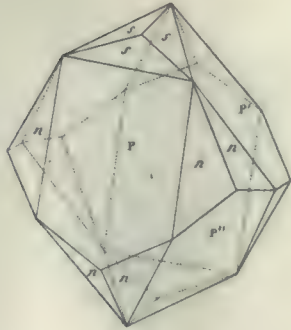

Fig. 147

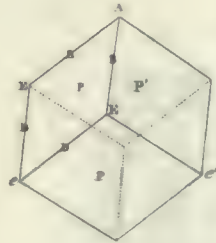

Fig. 148

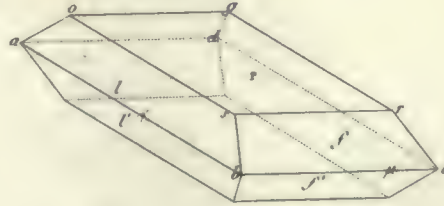

Fig. 149

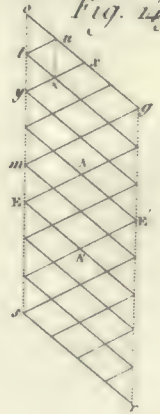

Fig. 150

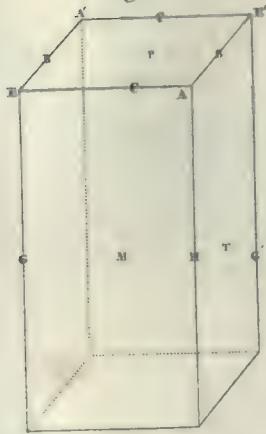

Fig. 151

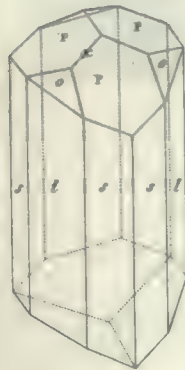

Fig. 152

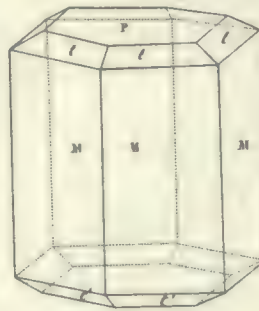

Fig. 153

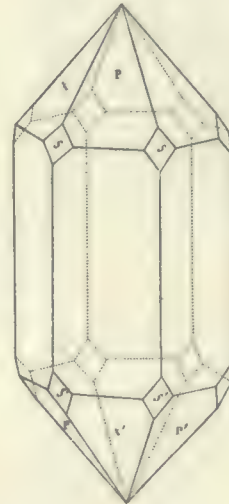

Fig. 154



Fig. 157

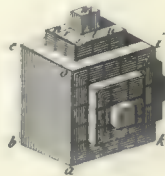

Fig. 159

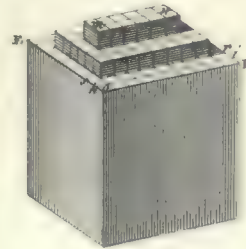

Fig. 155



Fig. 156



Fig. 158

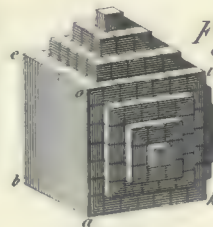



Fig. 160

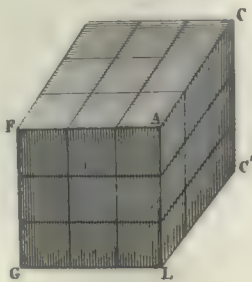

Fig. 161

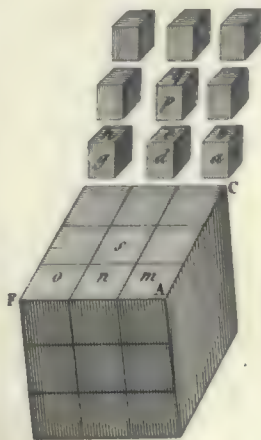

Fig. 162

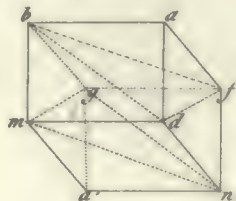

Fig. 163

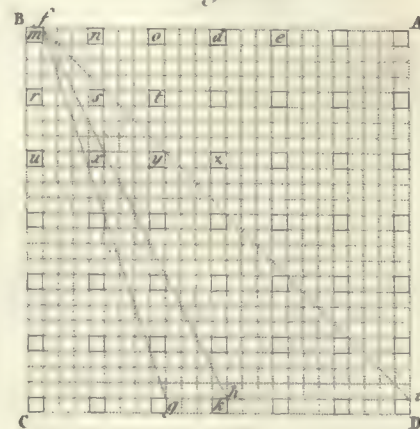

Fig. 164

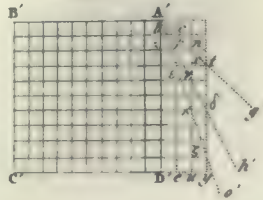

Fig. 165

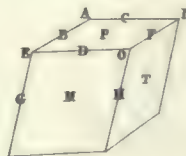

Fig. 167

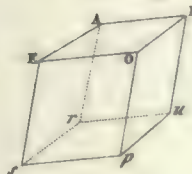

Fig. 168

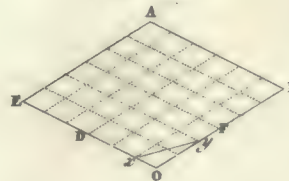

Fig. 169

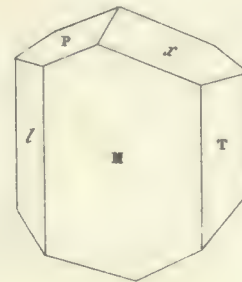

Fig. 166

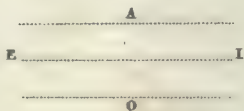

Fig. 171

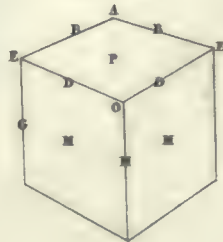

Fig. 170

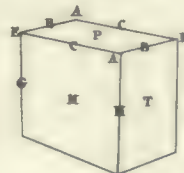



Fig. 172

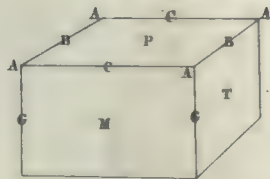

Fig. 173

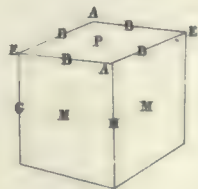

Fig. 174

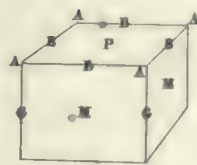

Fig. 175

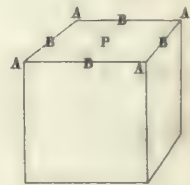

Fig. 176

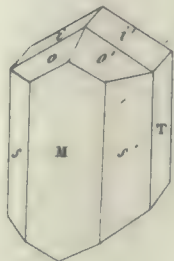

Fig. 177



Fig. 178



Fig. 179

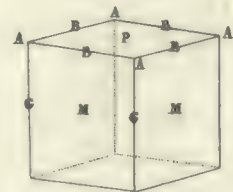

Fig. 181

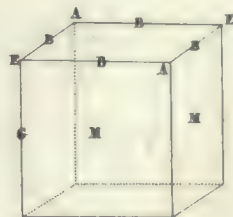

Fig. 183

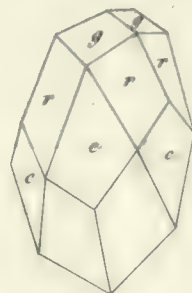

Fig. 180

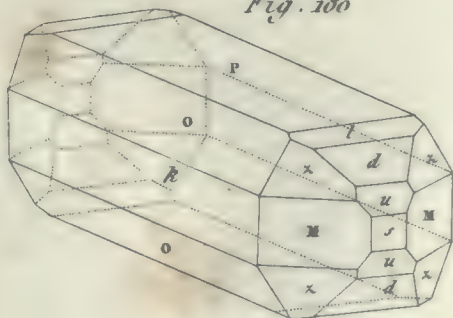

Fig. 182

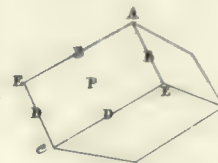

Fig. 184



Fig. 185





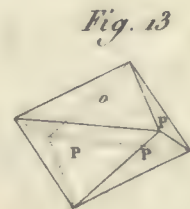
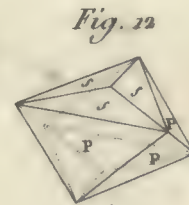
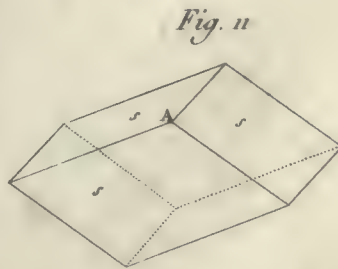
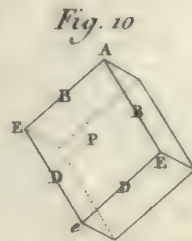
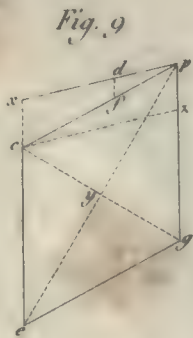
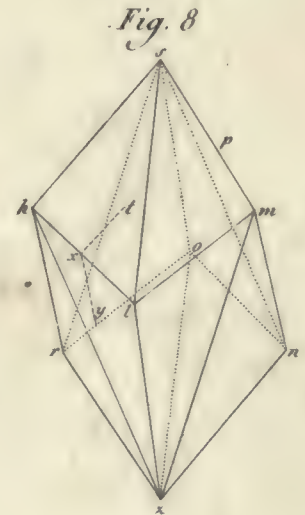
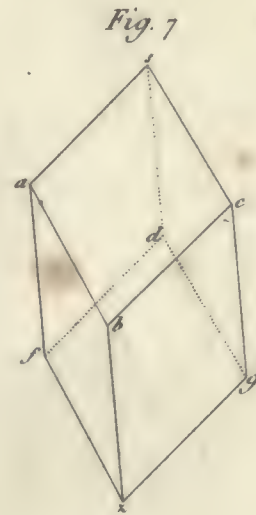
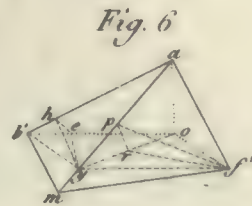
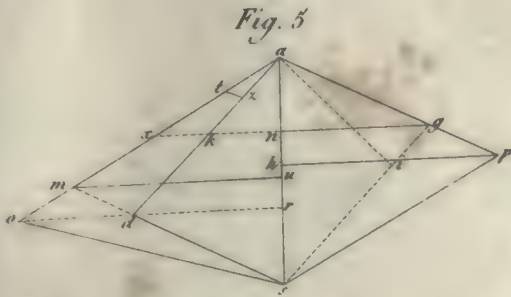
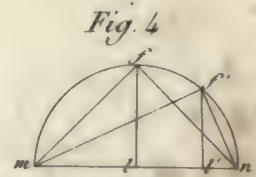
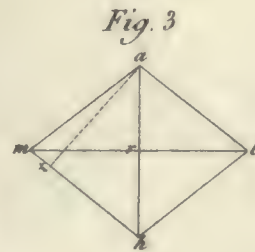
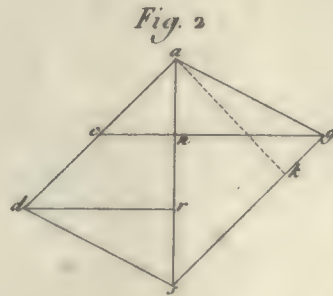
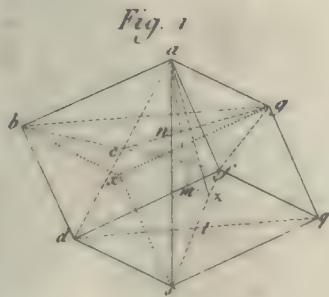





Fig. 24

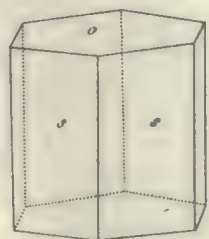

Fig. 25

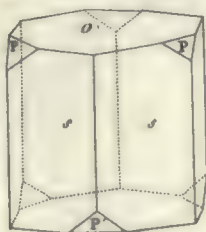

Fig. 26

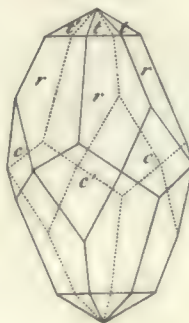

Fig. 27



Fig. 28

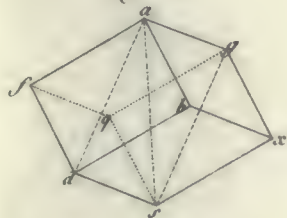

Fig. 29

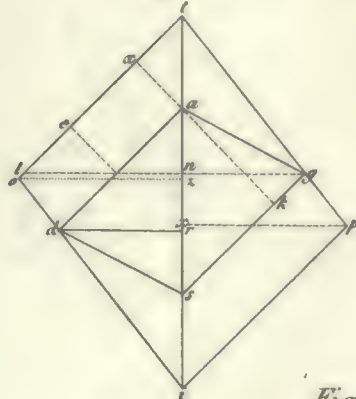

Fig. 30

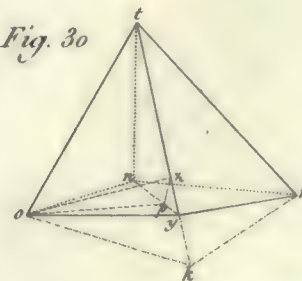

Fig. 31

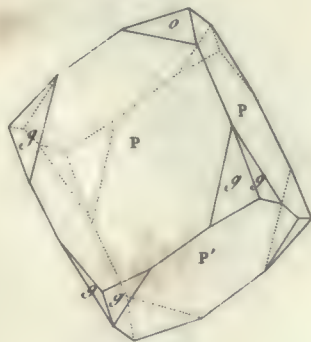

Fig. 33

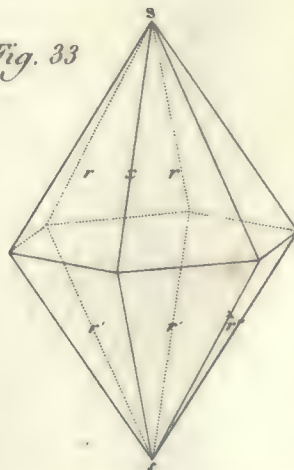

Fig. 34

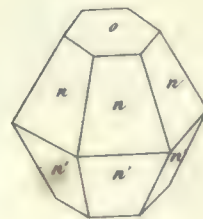

Fig. 32

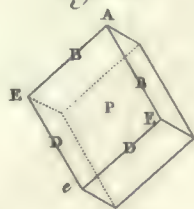



Fig. 35

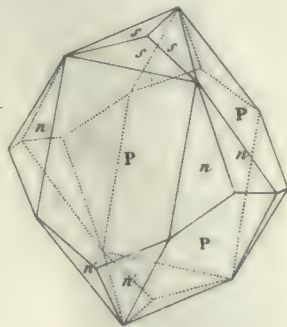

Fig. 36

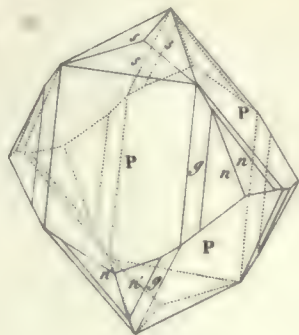

Fig. 37



Fig. 38

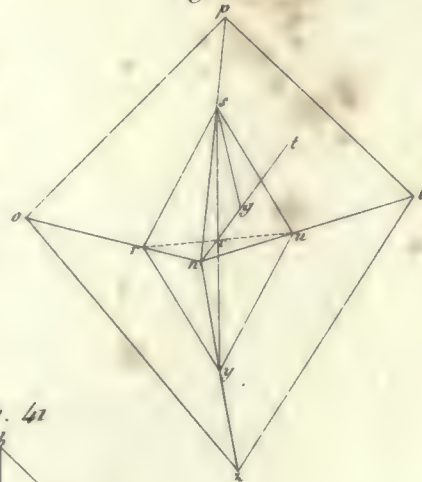

Fig. 39

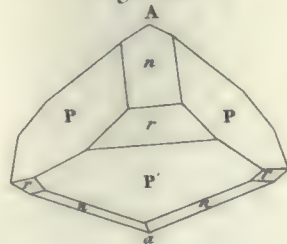

Fig. 40

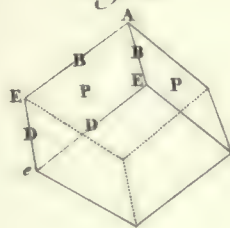

Fig. 41

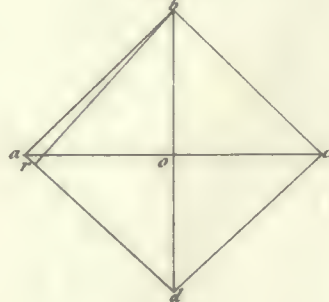

Fig. 42

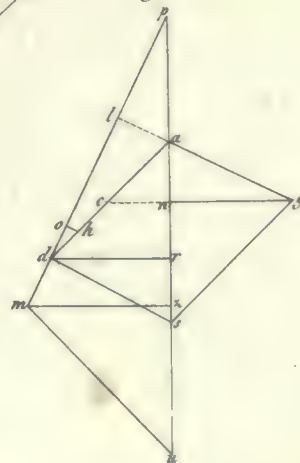

Fig. 43

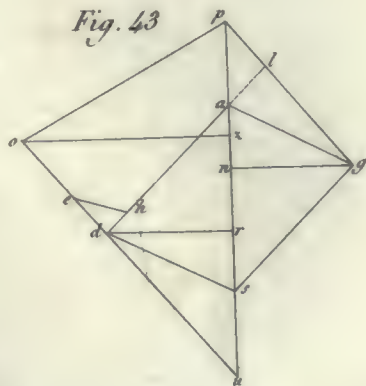

Fig. 44

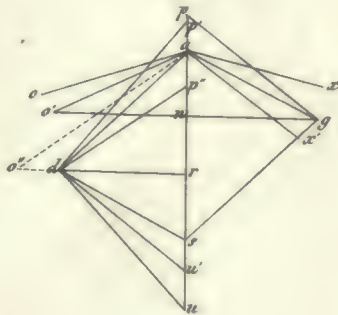

Fig. 45

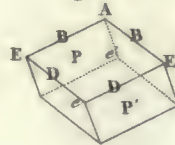



Fig. 46



Fig. 47



Fig. 48



Fig. 49



Fig. 51



Fig. 53

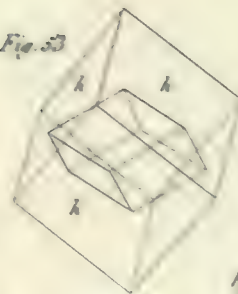

Fig. 52



Fig. 50

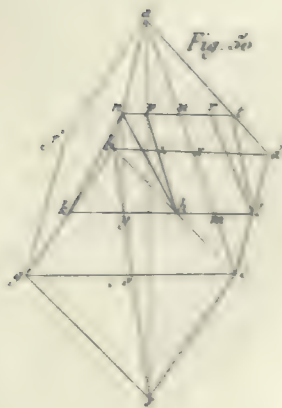

Fig. 54



Date	Particulars	Debit	Credit	Balance
1871	Jan 1			
1871	Feb 1			
1871	Mar 1			
1871	Apr 1			
1871	May 1			
1871	Jun 1			
1871	Jul 1			
1871	Aug 1			
1871	Sep 1			
1871	Oct 1			
1871	Nov 1			
1871	Dec 1			
1871	Total			

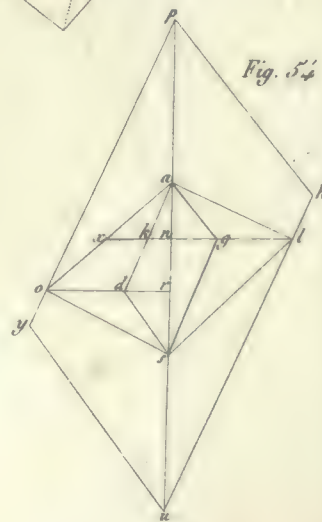
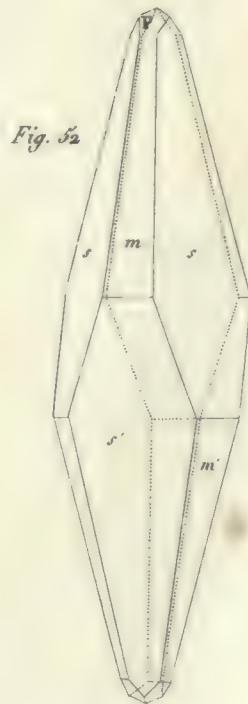
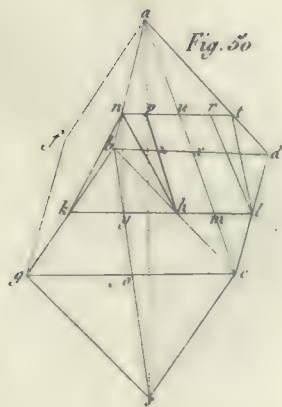
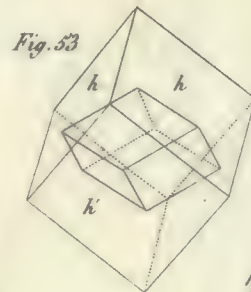
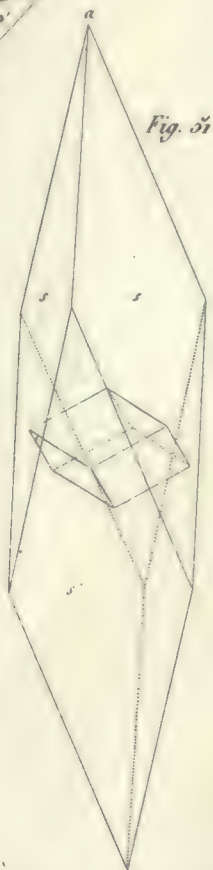
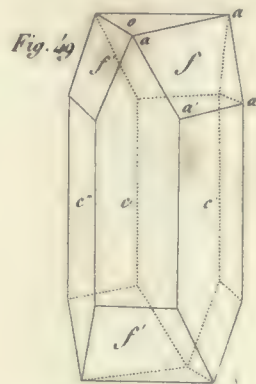
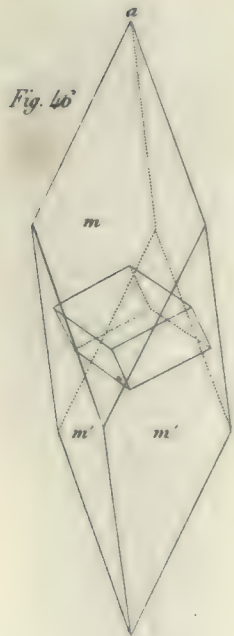



Fig. 55

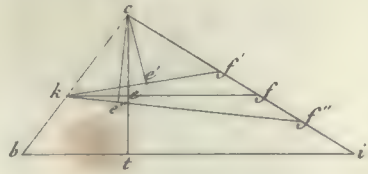

Fig. 57

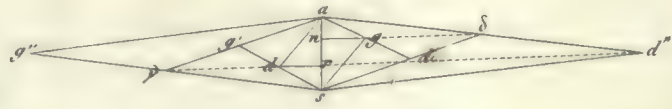

Fig. 56

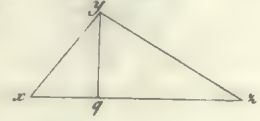

Fig. 59

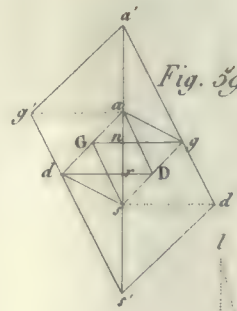

Fig. 60

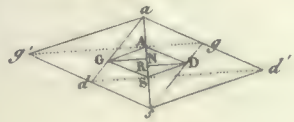

Fig. 61

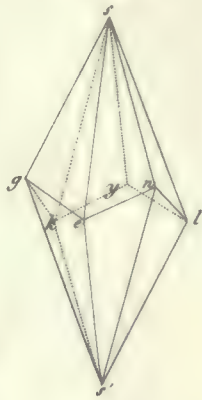

Fig. 62

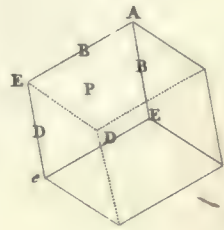

Fig. 58

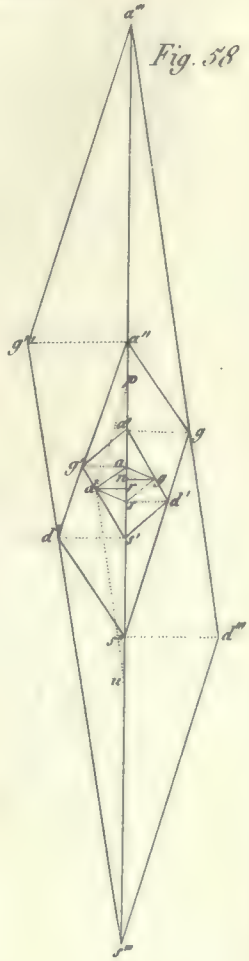

Fig. 63

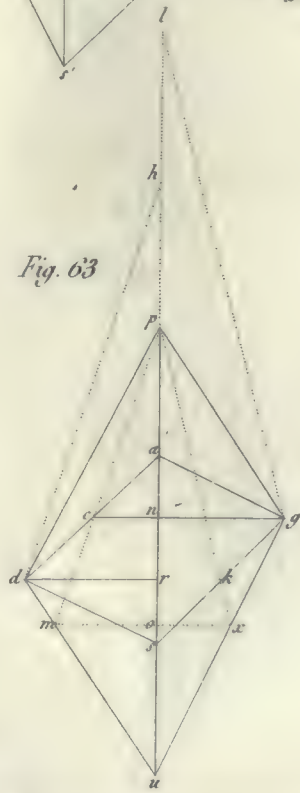

Fig. 64

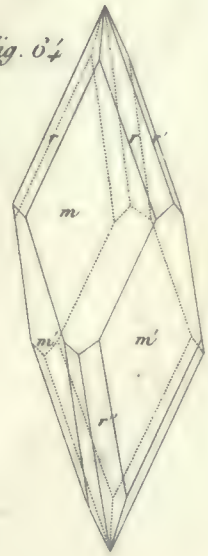
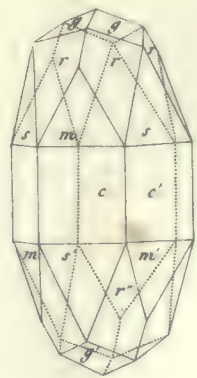

Fig. 65





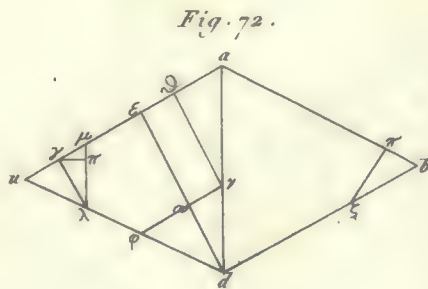
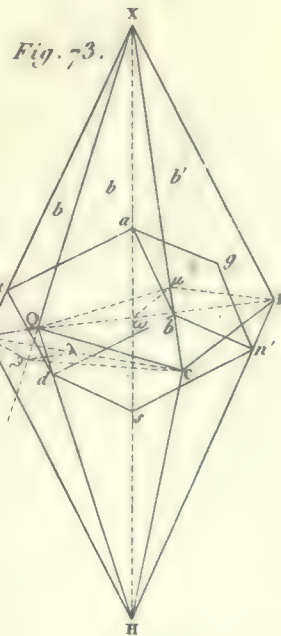
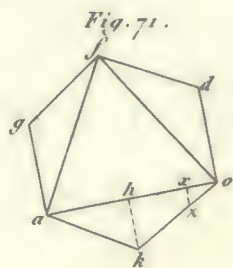
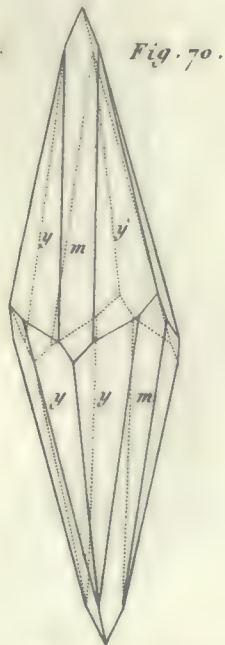
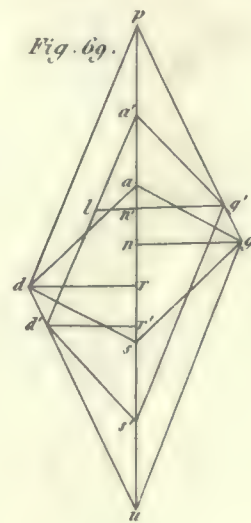
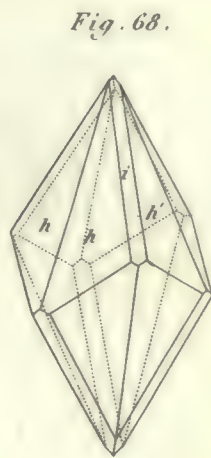
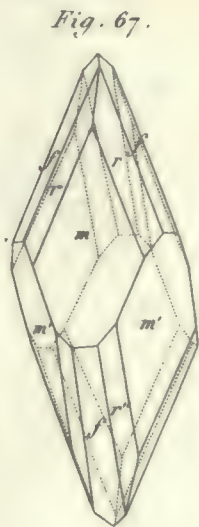
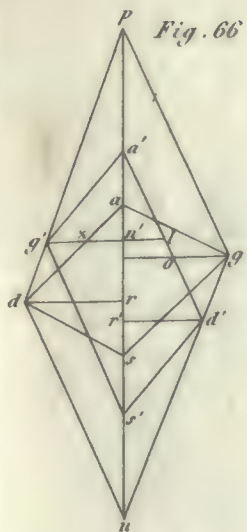



Fig. 74

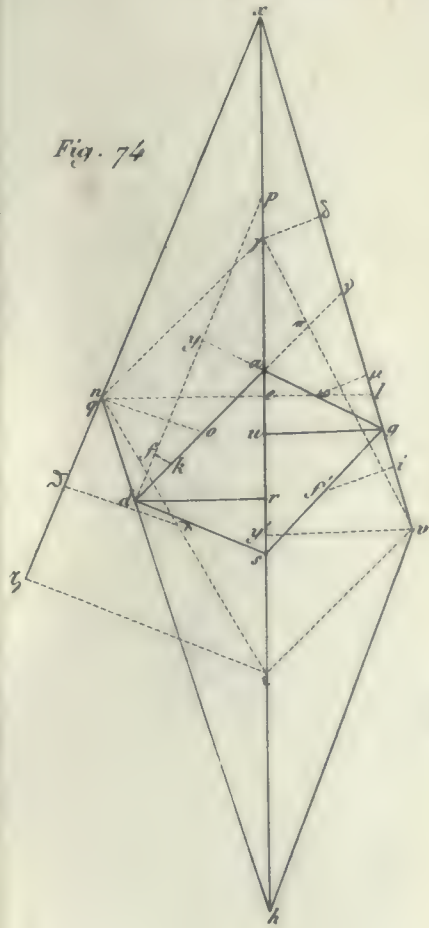

Fig. 75

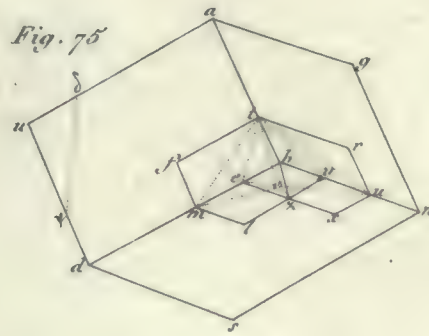

Fig. 76

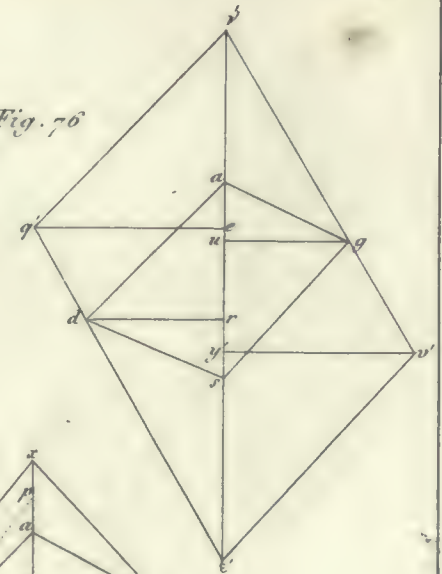

Fig. 77

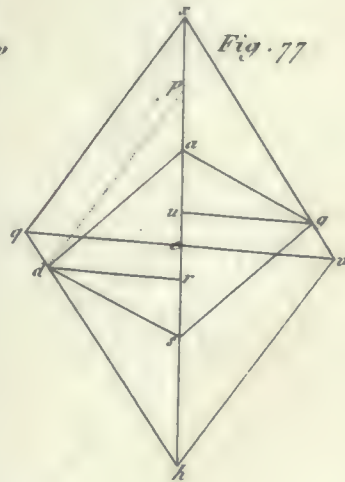

Fig. 78

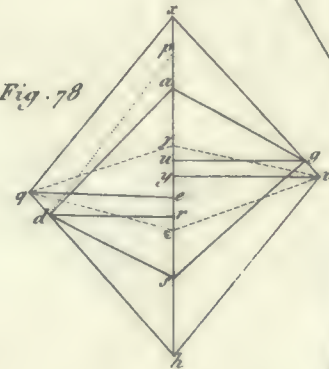

Fig. 80

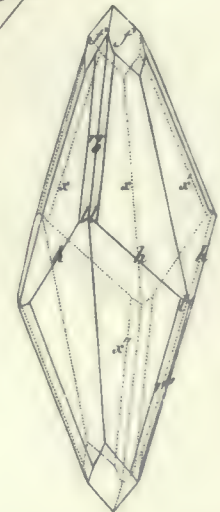

Fig. 81

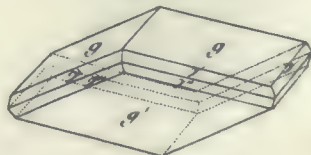

Fig. 79

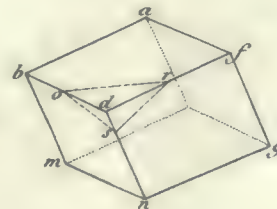



Fig. 82

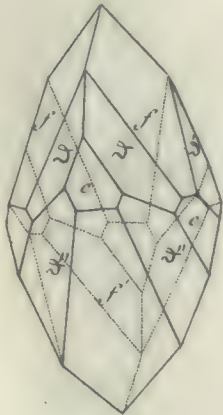

Fig. 83

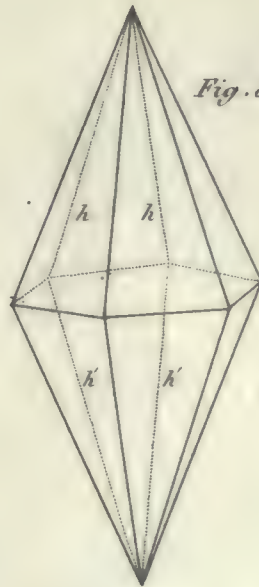

Fig. 84

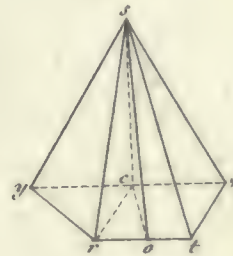

Fig. 85

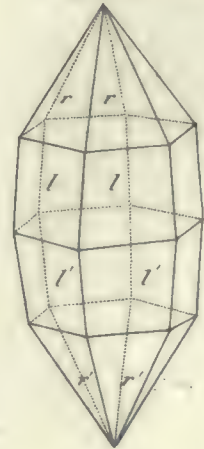

Fig. 86

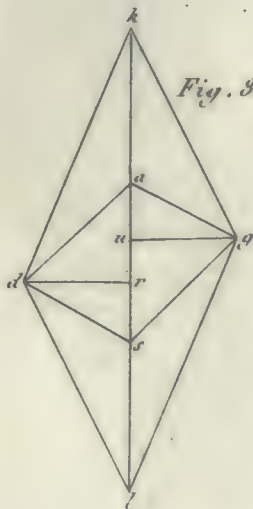

Fig. 88

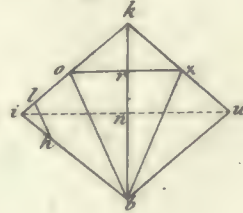

Fig. 89

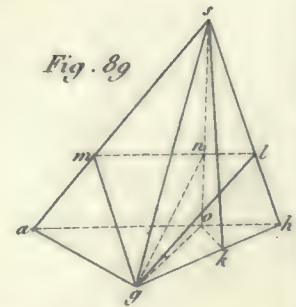

Fig. 87

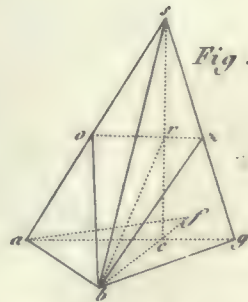

Fig. 90

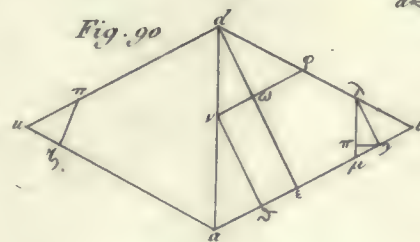



Fig. 91

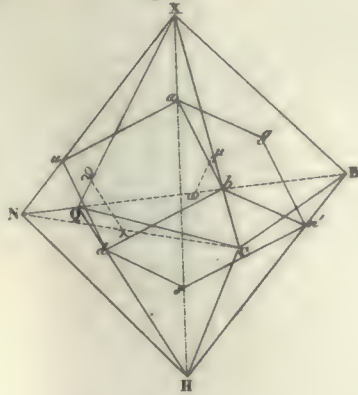

Fig. 92

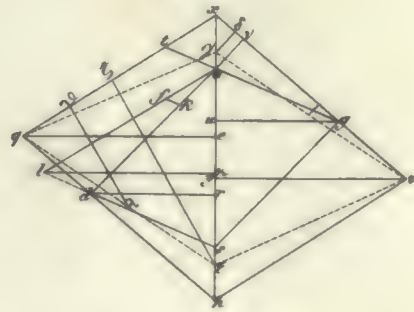

Fig. 93

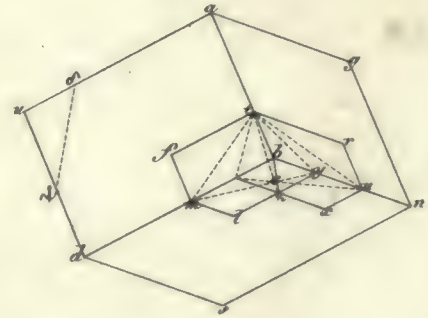

Fig. 96

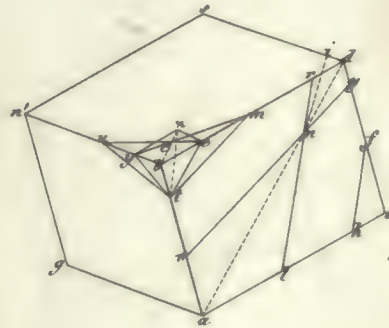

Fig. 94

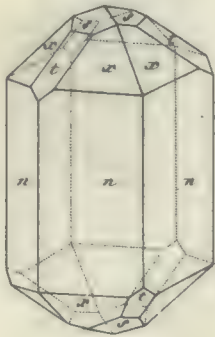

Fig. 97

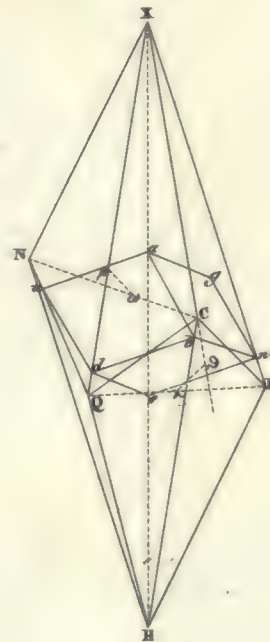

Fig. 98

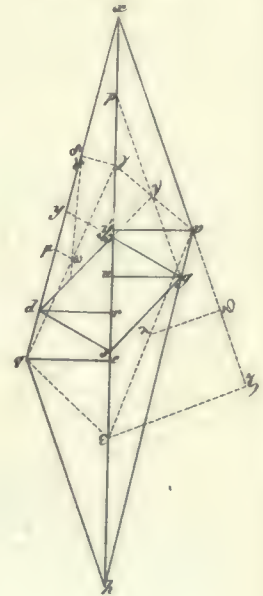

Fig. 95

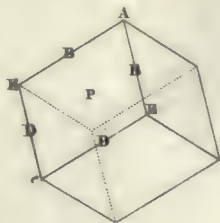

Fig. 99

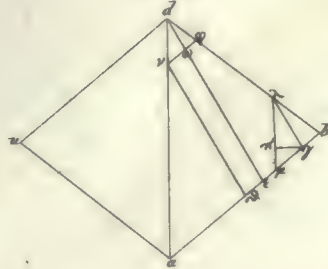



Fig. 100

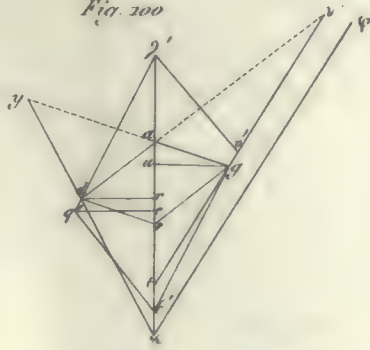

Fig. 101

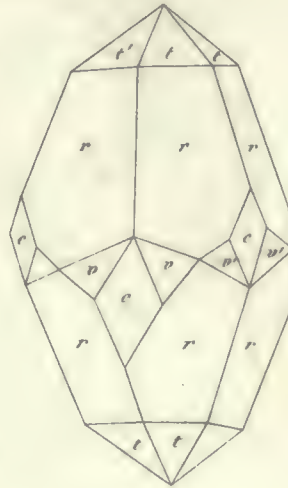

Fig. 102

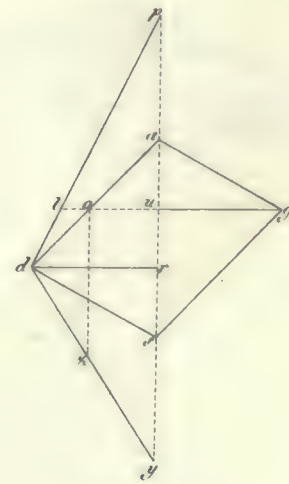

Fig. 103

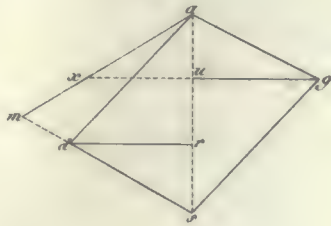

Fig. 104

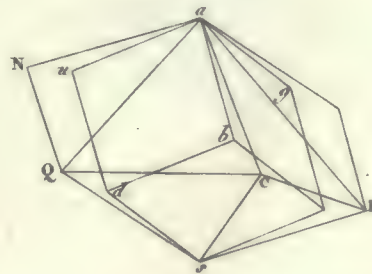

Fig. 105

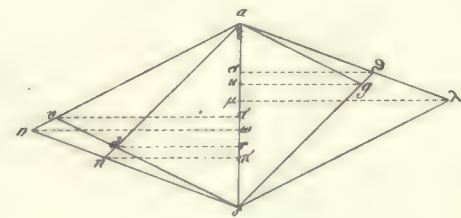

Fig. 106

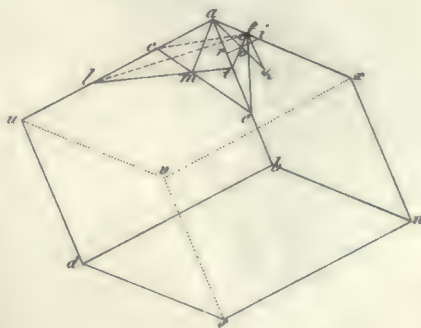

Fig. 108

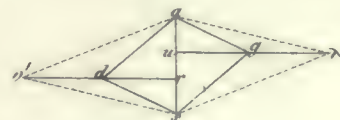
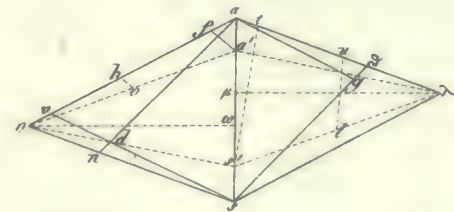

Fig. 107



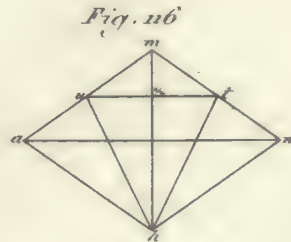
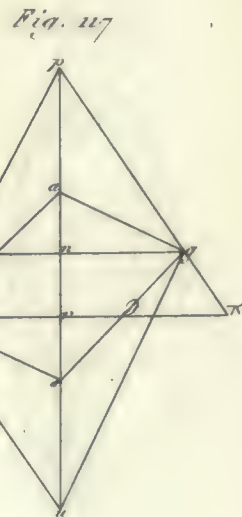
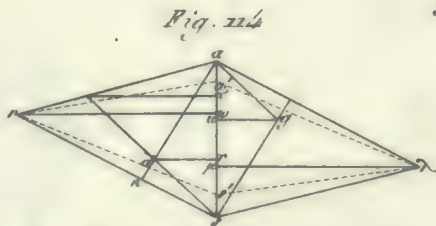
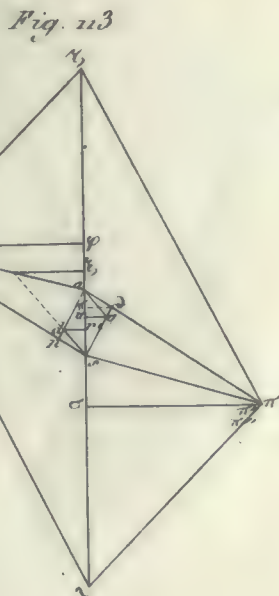
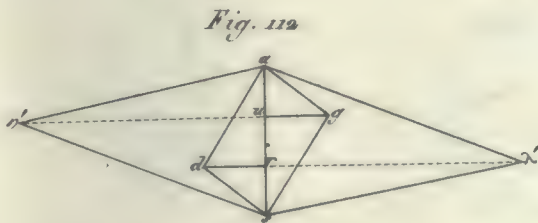
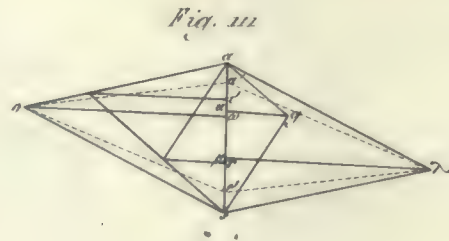
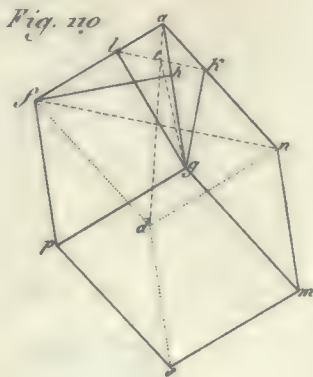
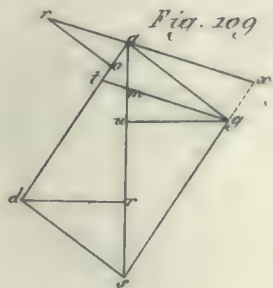



Fig. 118

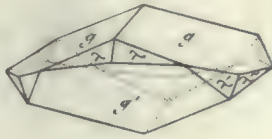

Fig. 120

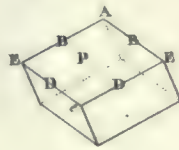

Fig. 123

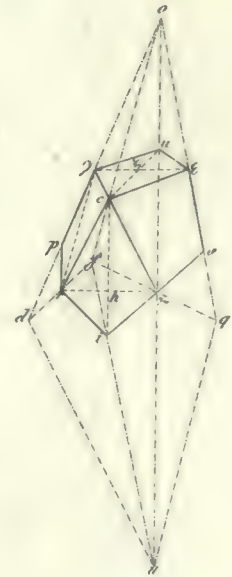

Fig. 119



Fig. 122

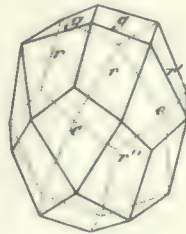

Fig. 122



Fig. 124

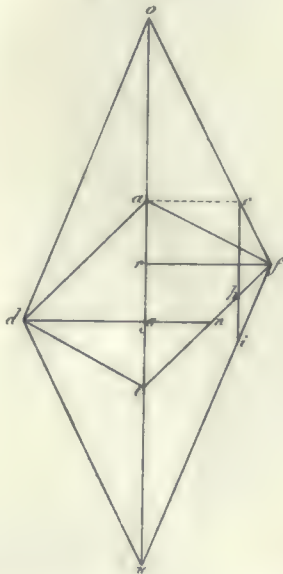

Fig. 125

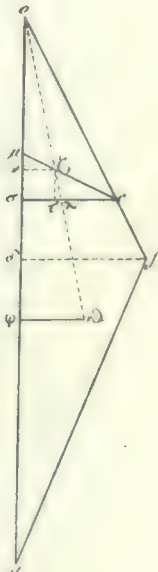

Fig. 126

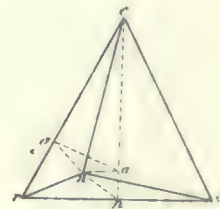

Fig. 128

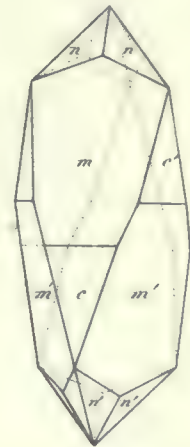

Fig. 127







Fig. 140

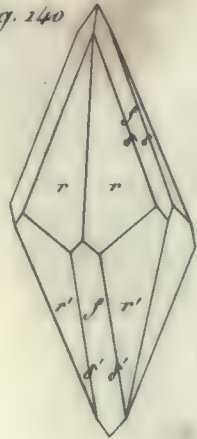

Fig. 141

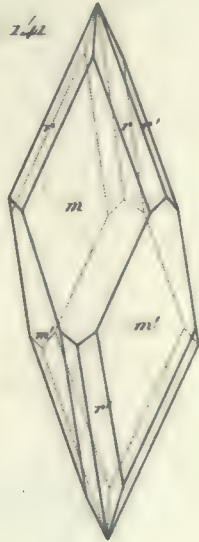

Fig. 142

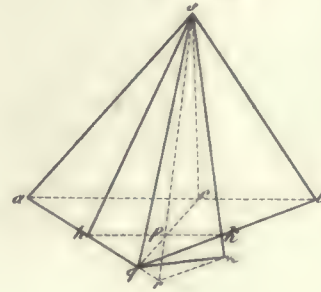

Fig. 143

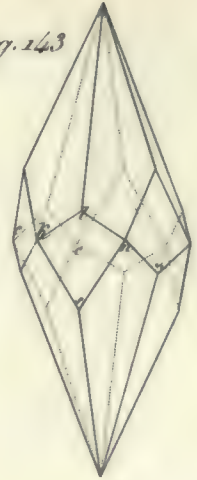

Fig. 144

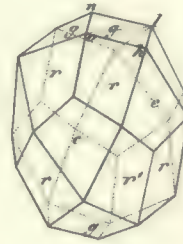

Fig. 145

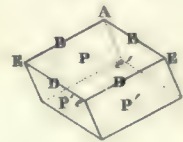

Fig. 146

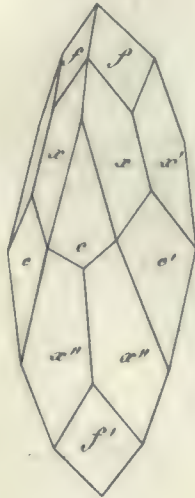

Fig. 147

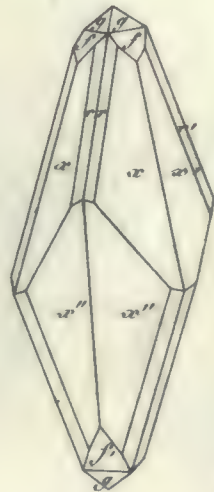

Fig. 148



Fig. 149

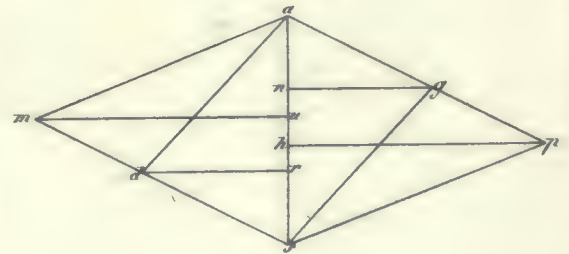



Fig. 150

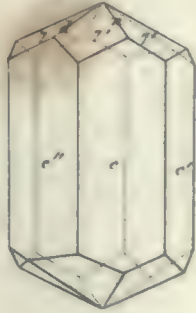

Fig. 151

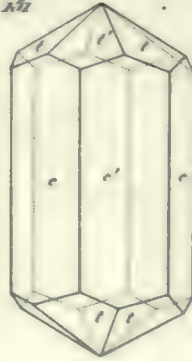

Fig. 152

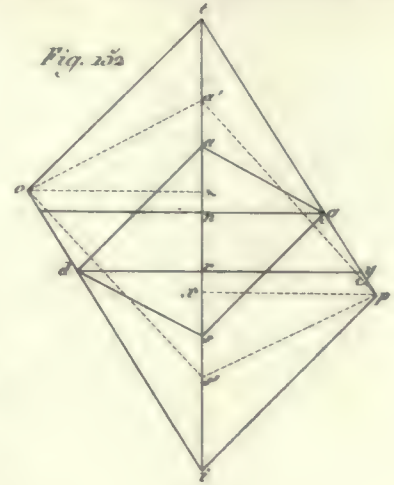

Fig. 153

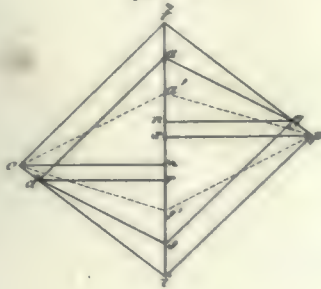

Fig. 154

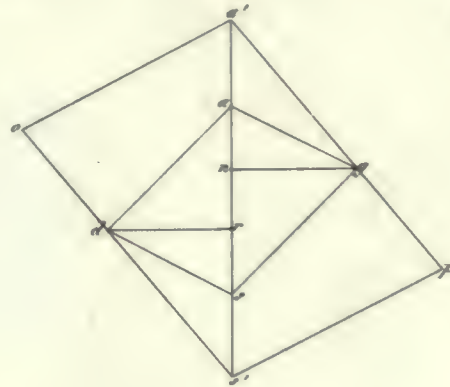

Fig. 155

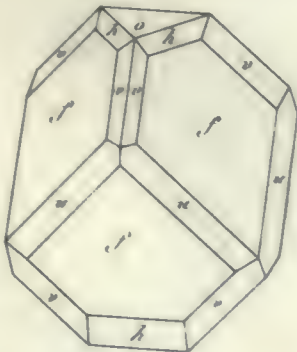

Fig. 156

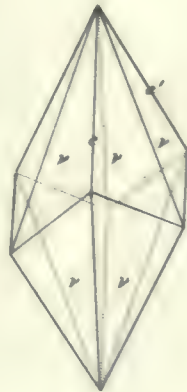

Fig. 157

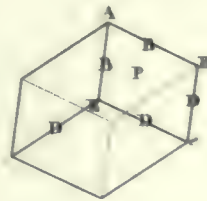

Fig. 158



Fig. 1

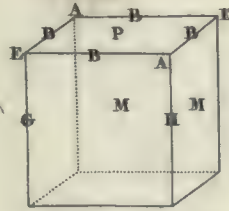

Fig. 2

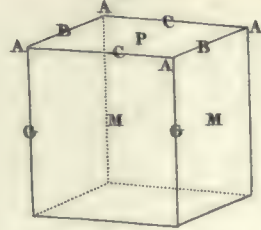

Fig. 3

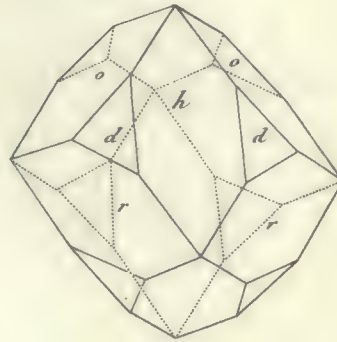

Fig. 4

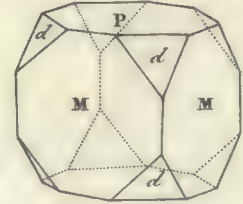

Fig. 5

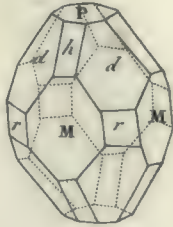

Fig. 6

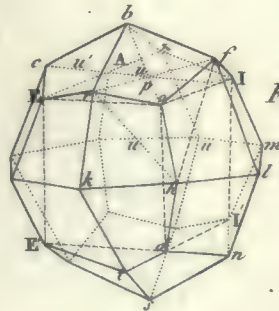

Fig. 7



Fig. 10

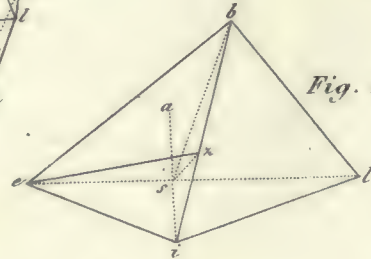

Fig. 8

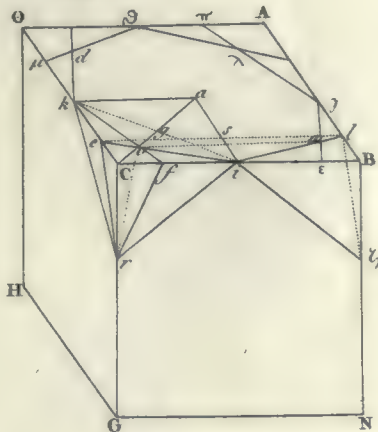

Fig. 9

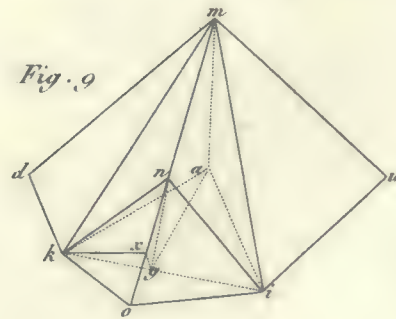

Fig. 11

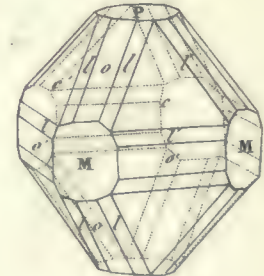





Fig. 23

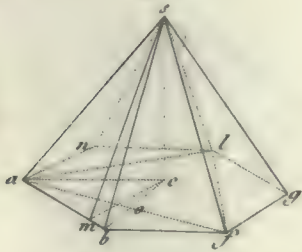

Fig. 24

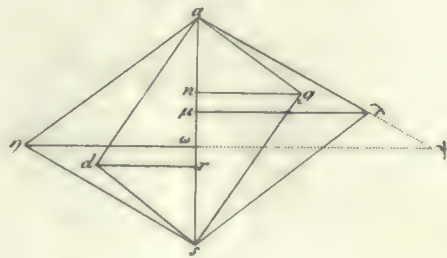

Fig. 25

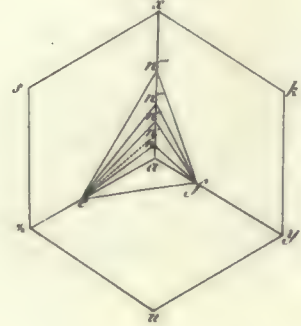

Fig. 26

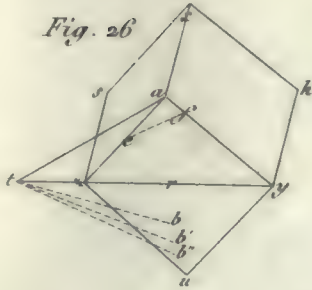

Fig. 27

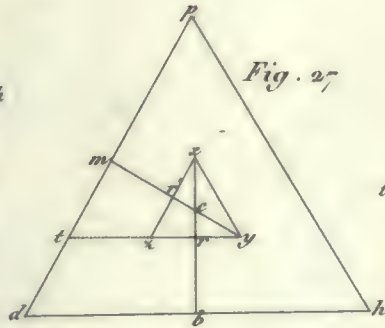

Fig. 28

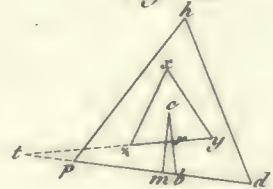

Fig. 29

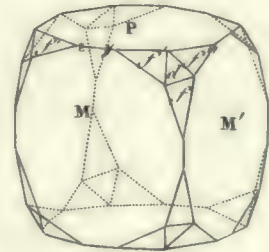

Fig. 30

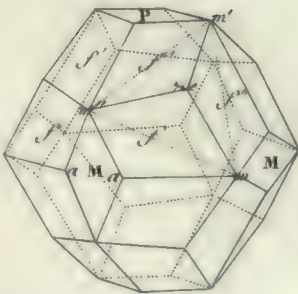

Fig. 31

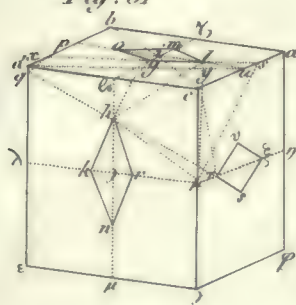

Fig. 32

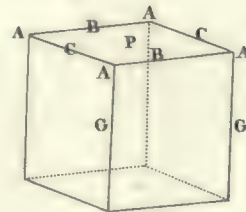

Fig. 33

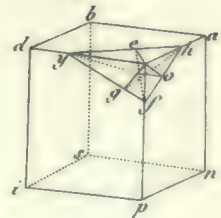



Fig. 34.

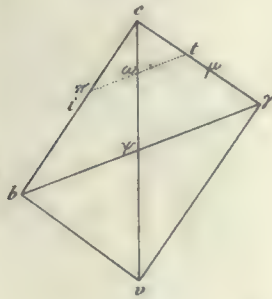

Fig. 35.

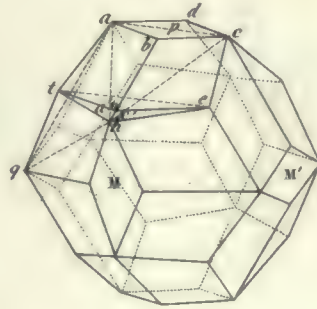

Fig. 36.

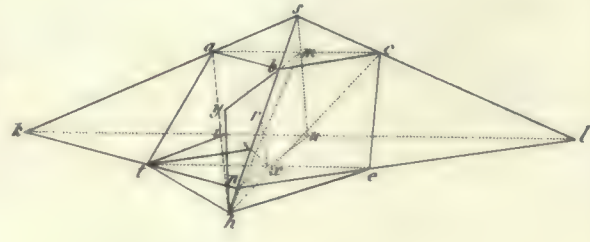

Fig. 37.



Fig. 40.

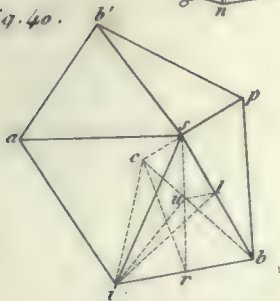

Fig. 38.

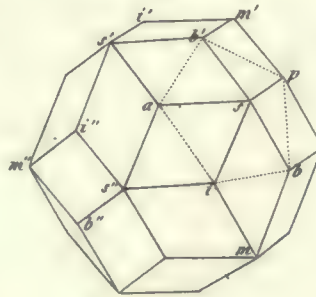

Fig. 39.

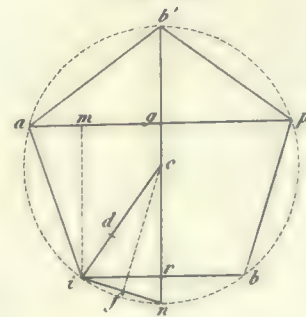

Fig. 41.

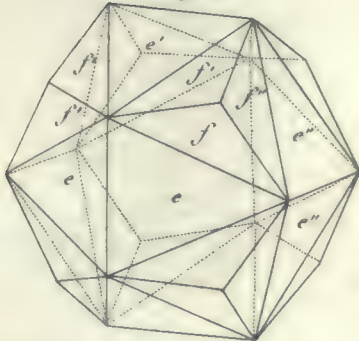

Fig. 42.

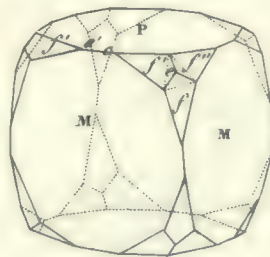

Fig. 43.

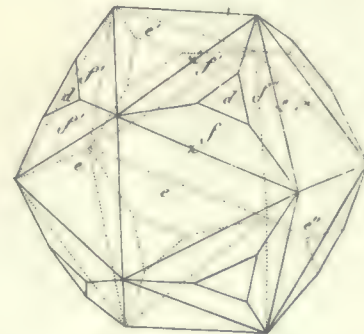



Fig. 57.

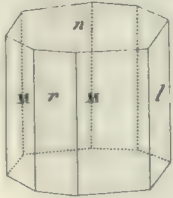

Fig. 58.

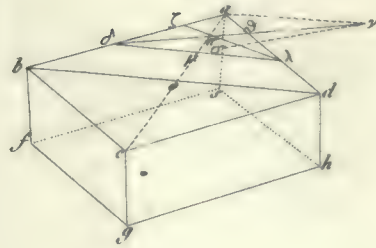

Fig. 59.

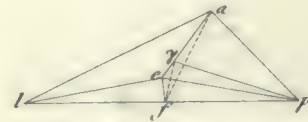

Fig. 61.

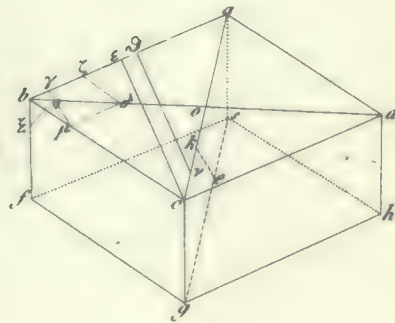

Fig. 60.

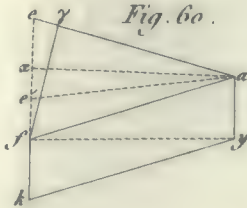

Fig. 62.

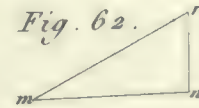

Fig. 63.

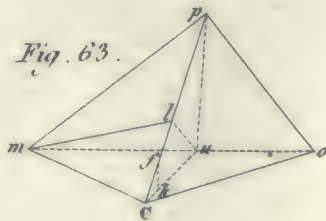

Fig. 64.

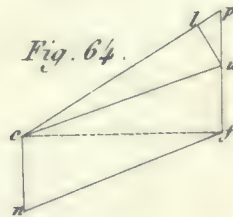

Fig. 65.

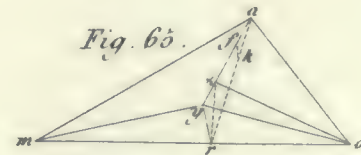



Fig. 66.

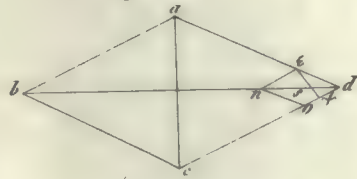

Fig. 67.

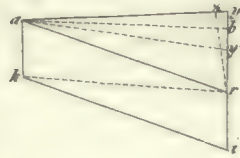

Fig. 68.

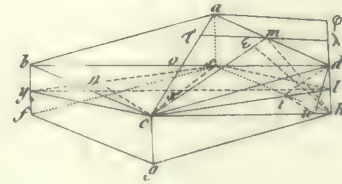

Fig. 69.

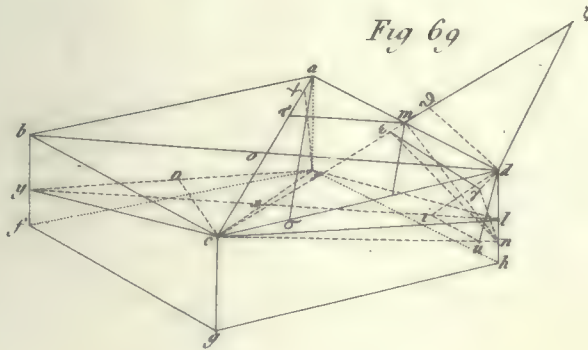

Fig. 70.

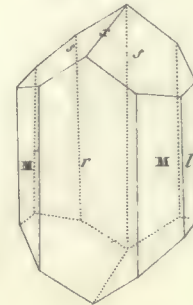

Fig. 71.



Fig. 72.

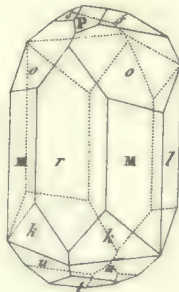

Fig. 73.

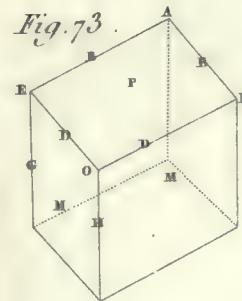



Fig. 74

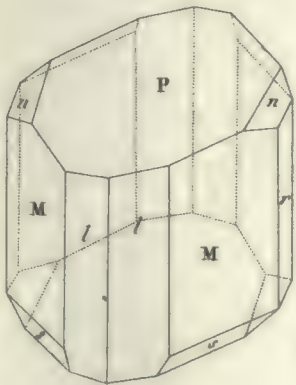

Fig. 76

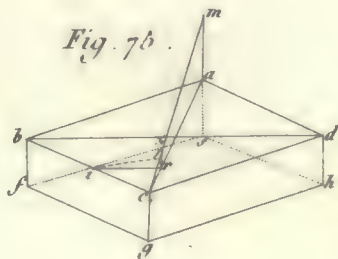

Fig. 76

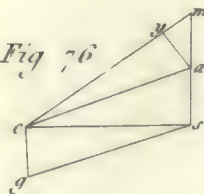

Fig. 78

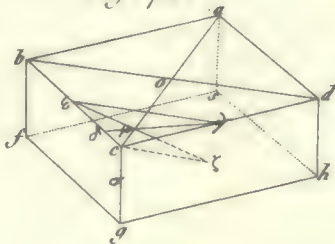

Fig. 79

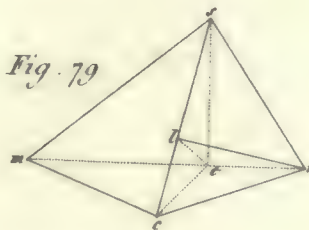

Fig. 77

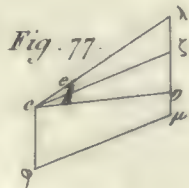

Fig. 80

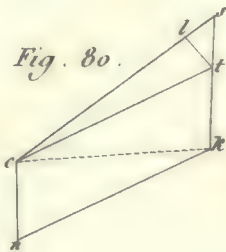

Fig. 81

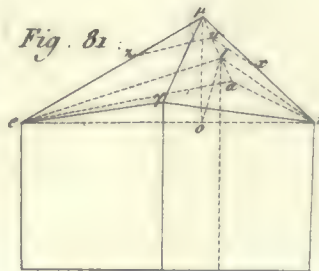

Fig. 82

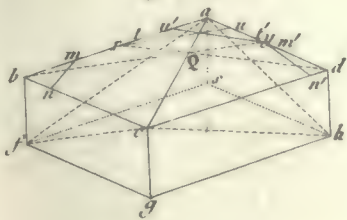

Fig. 83

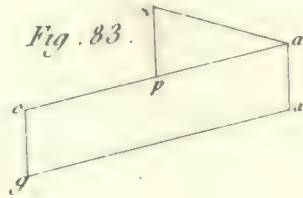

Fig. 84

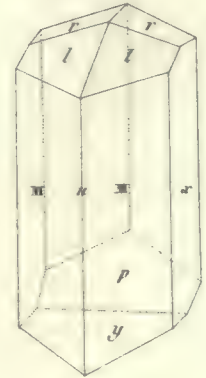

Fig. 85

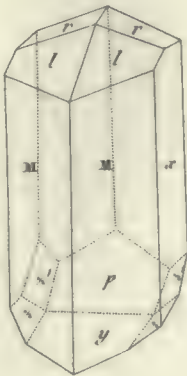

Fig. 86

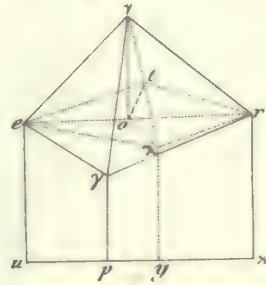

Fig. 87

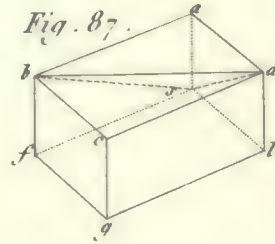

Fig. 88

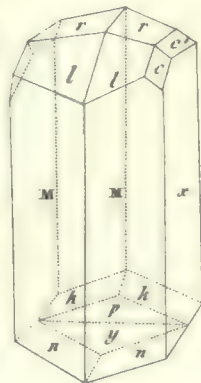

Fig. 89

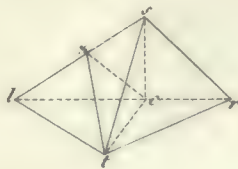

Fig. 90

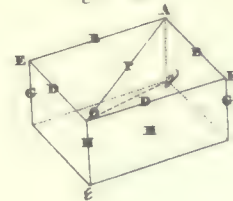
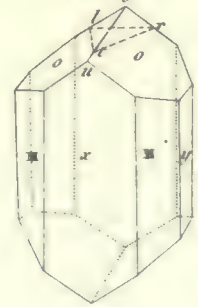

Fig. 90





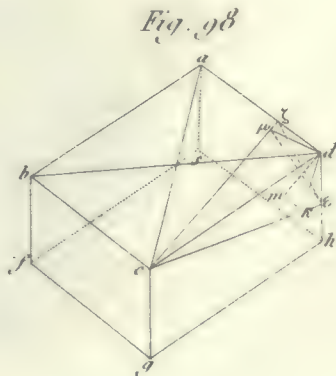
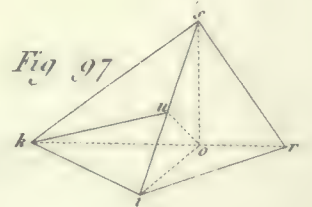
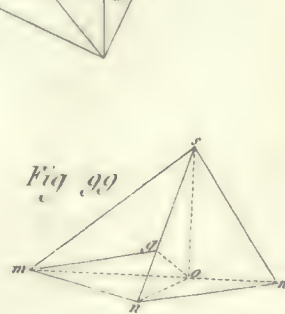
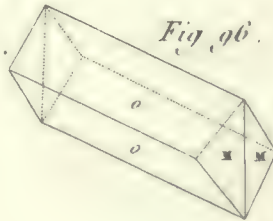
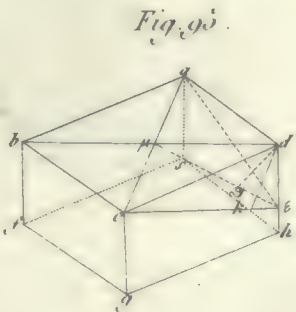
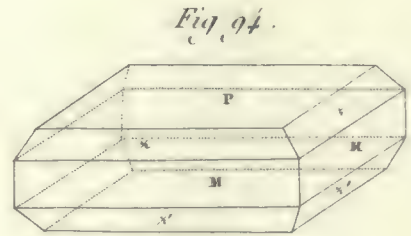
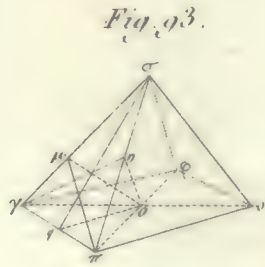
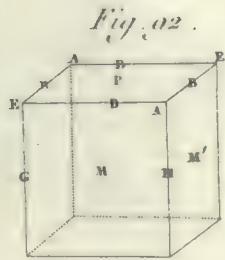



Fig. 101

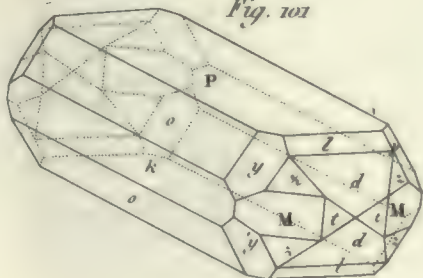

Fig. 102

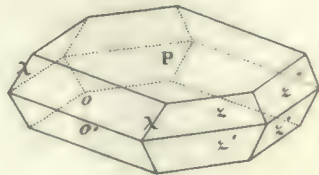

Fig. 103

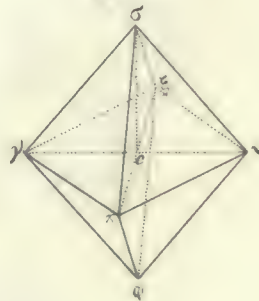

Fig. 104



Fig. 105

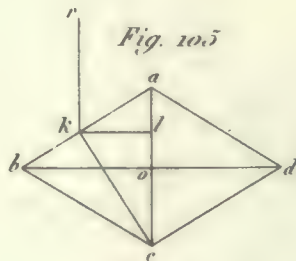

Fig. 108

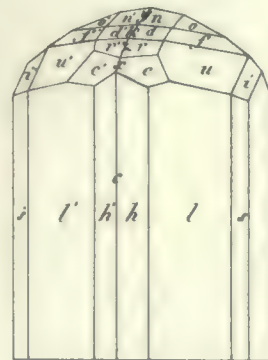

Fig. 106

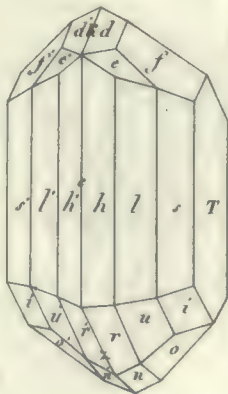

Fig. 107

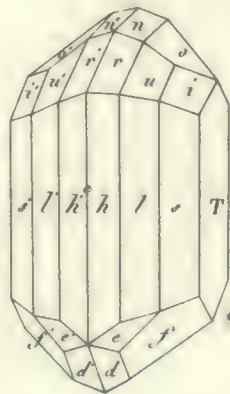



Fig. 109

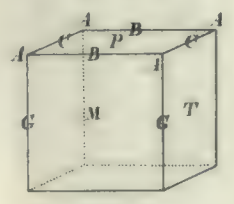

Fig. 110

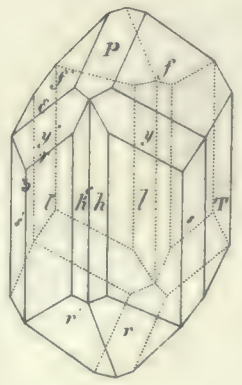

Fig. 111

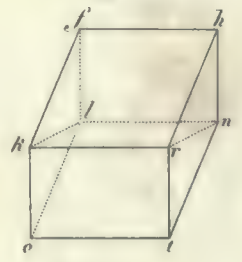

Fig. 112

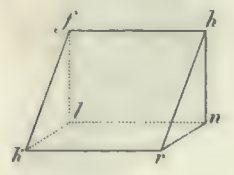

Fig. 114

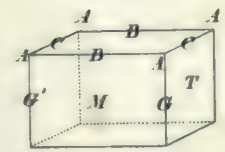

Fig. 116

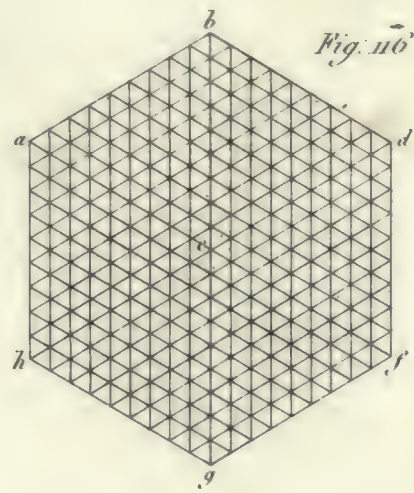

Fig. 113

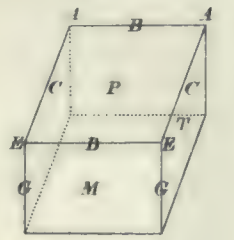

Fig. 115

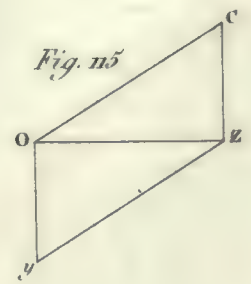

Fig. 117

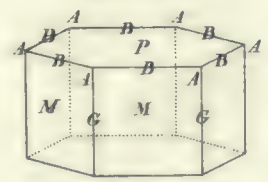



Fig. 118



Fig. 119



Fig. 120



Fig. 121



Fig. 122

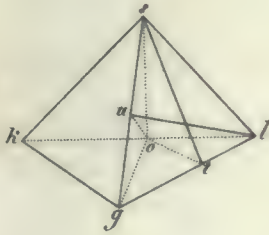

Fig. 123

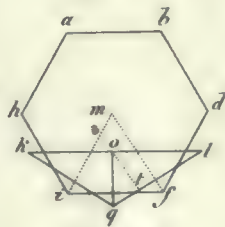

Fig. 124



Fig. 126

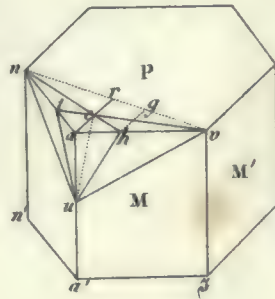

Fig. 127

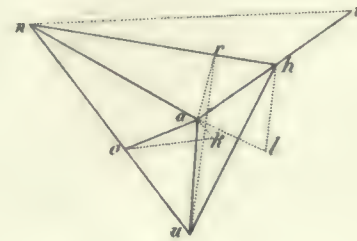

Fig. 125

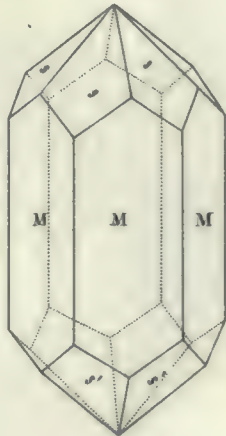

Fig. 129

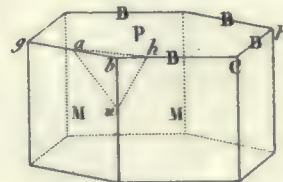

Fig. 128

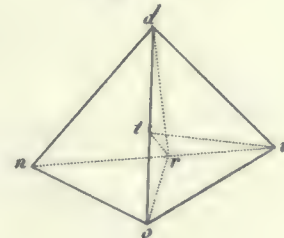



Fig. 130

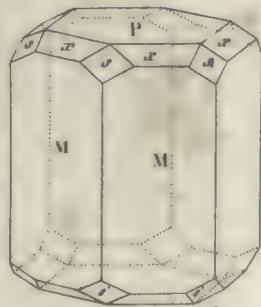

Fig. 131

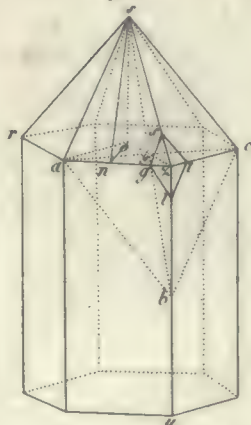

Fig. 132

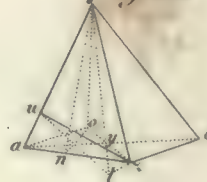

Fig. 133

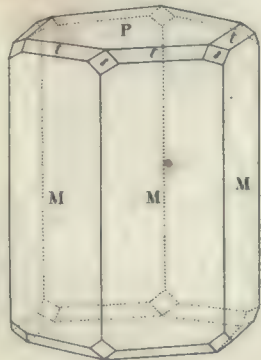

Fig. 134

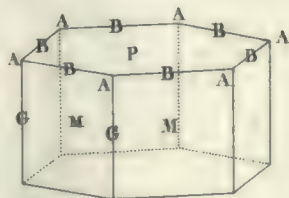

Fig. 135

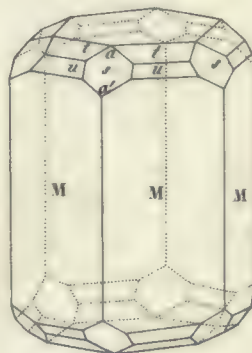

Fig. 136

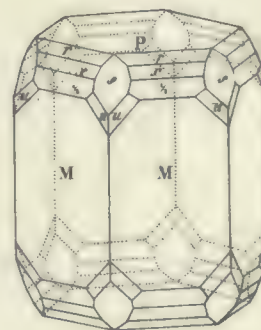

Fig. 137

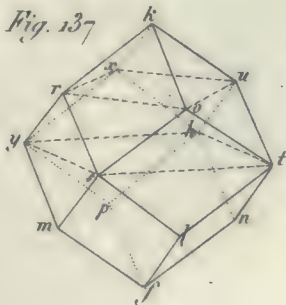

Fig. 138

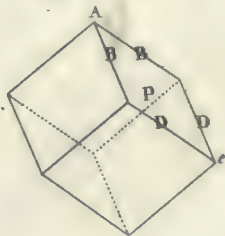

Fig. 139

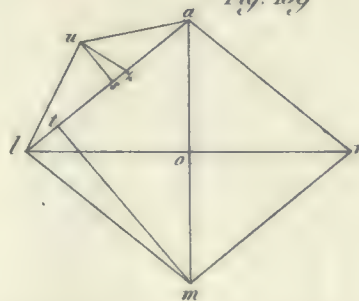



Fig. 140

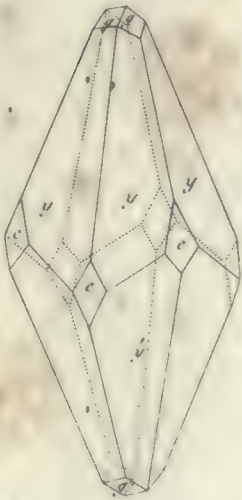

Fig. 141

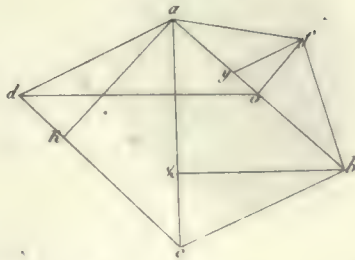

Fig. 142



Fig. 143

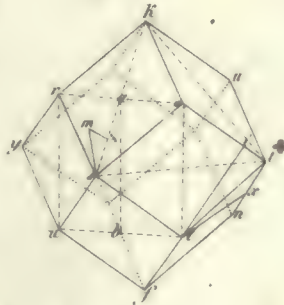

Fig. 144

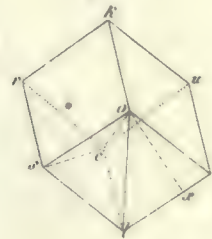

Fig. 145

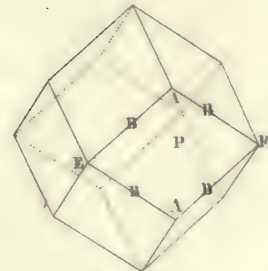

Fig. 146

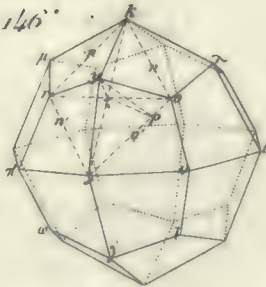

Fig. 147

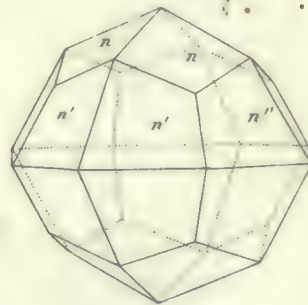

Fig. 148

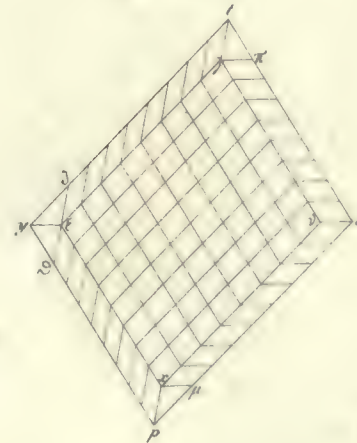

Fig. 150

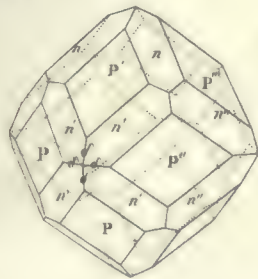

Fig. 149





Fig. 151

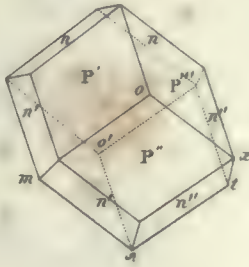

Fig. 152

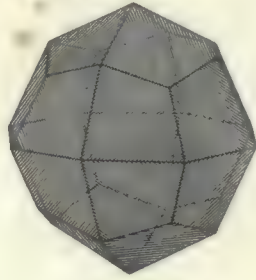

Fig. 153

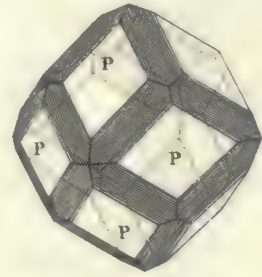

Fig. 154

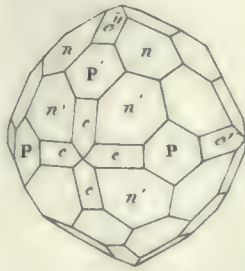

Fig. 155

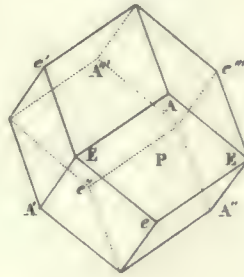

Fig. 156

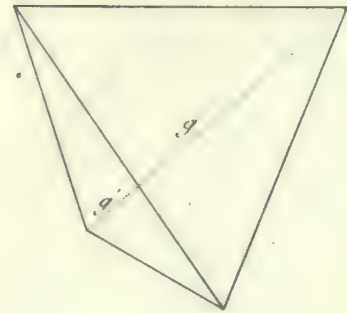

Fig. 157

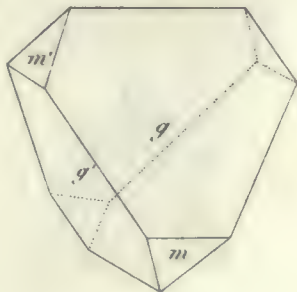

Fig. 158

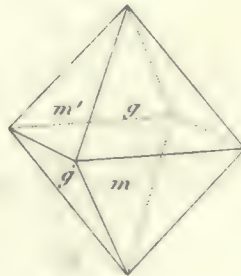
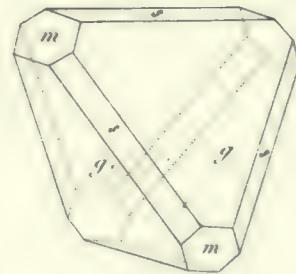

Fig. 159





1871

1871

1871

Fig. 160

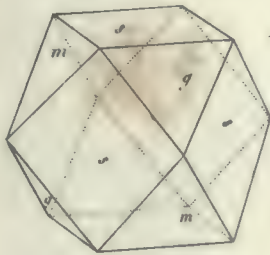

Fig. 161

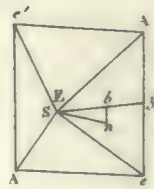

Fig. 162

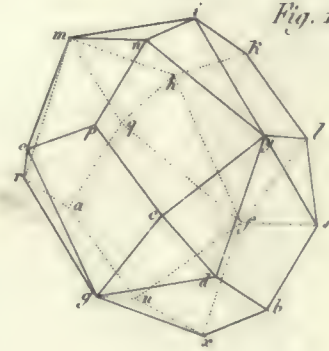

Fig. 163

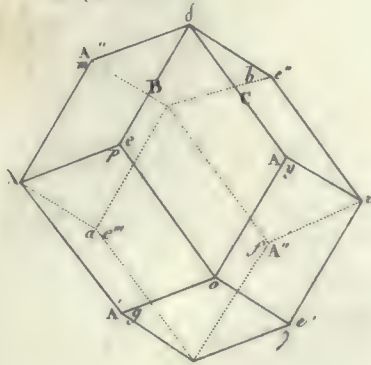

Fig. 164

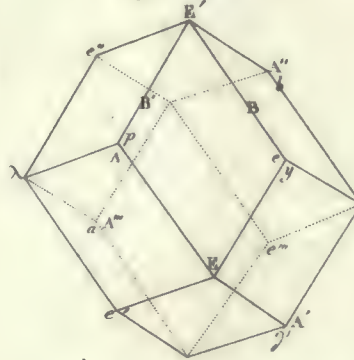

Fig. 165

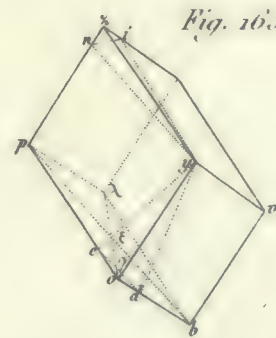

Fig. 166

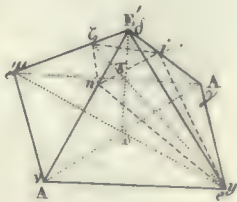

Fig. 167

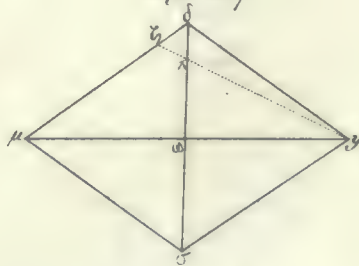

Fig. 168

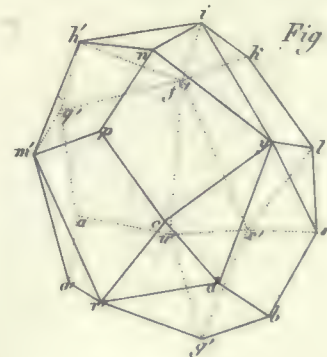



Fig. 169

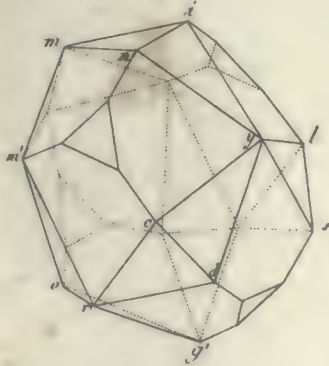

Fig. 170

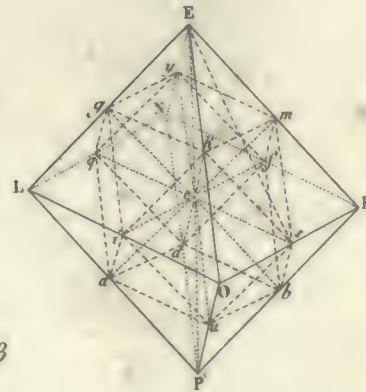

Fig. 171

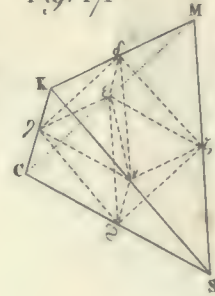

Fig. 173

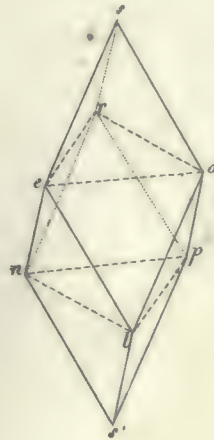

Fig. 174

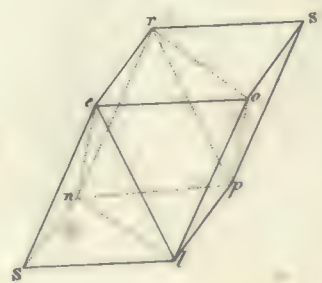

Fig. 177

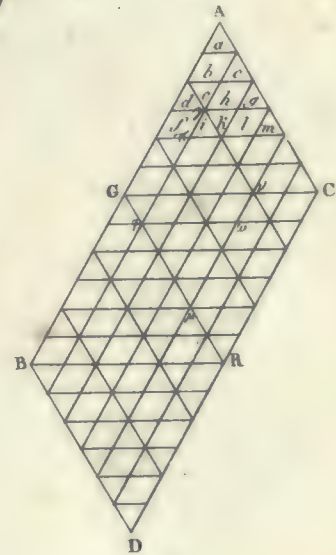

Fig. 172

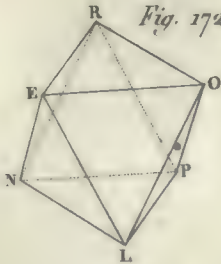

Fig. 175

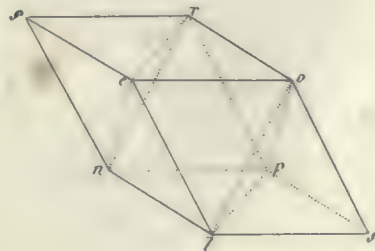

Fig. 176

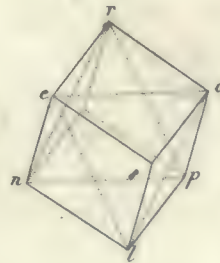



Fig. 178

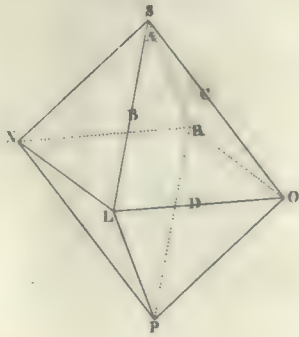

Fig. 179

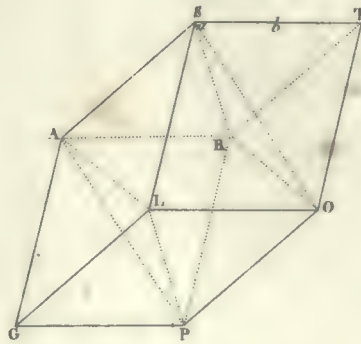

Fig. 180

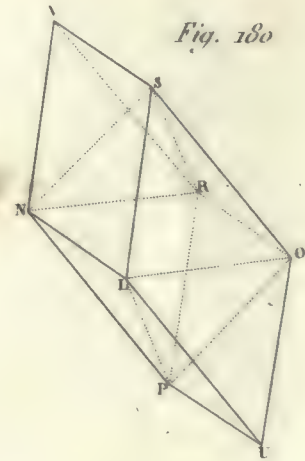

Fig. 181

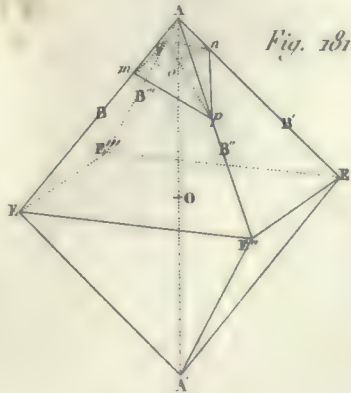

Fig. 182

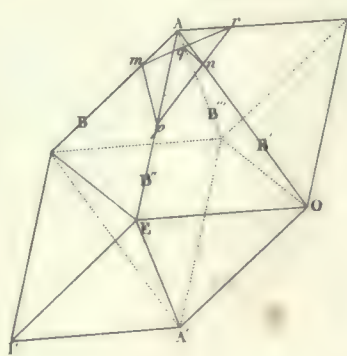

Fig. 183

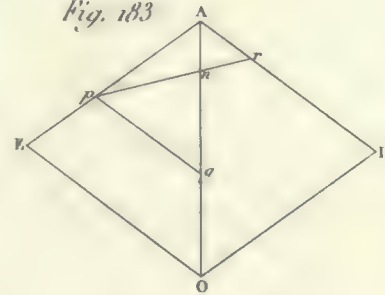

Fig. 184

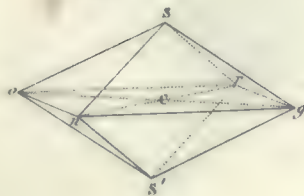

Fig. 185

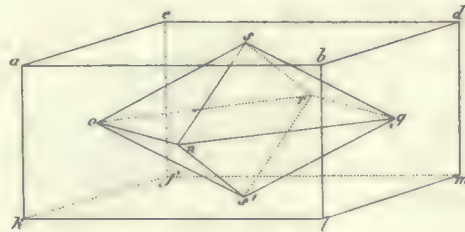

Fig. 186

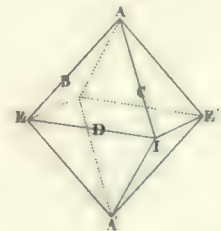



Fig. 187

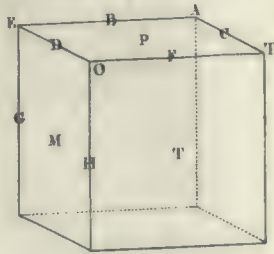

Fig. 188

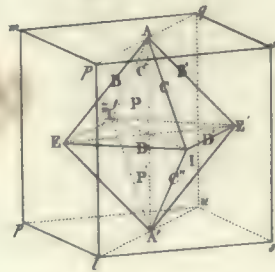

Fig. 189

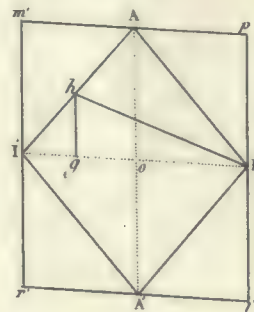

Fig. 190

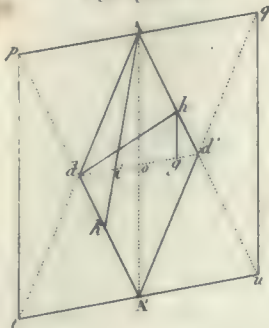

Fig. 191

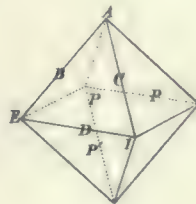

Fig. 192

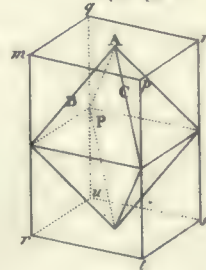

Fig. 195

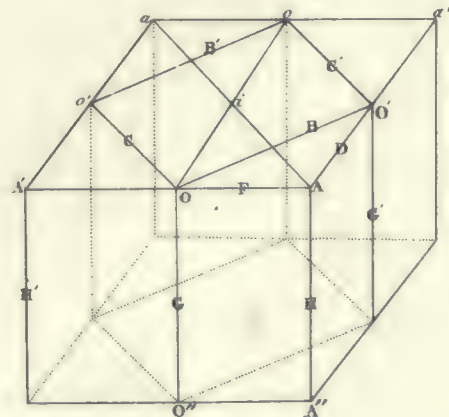

Fig. 193

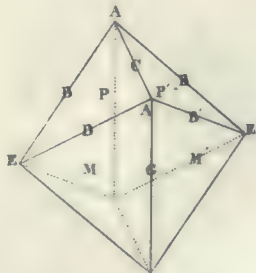

Fig. 194

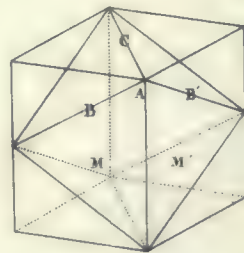



Fig. 190'

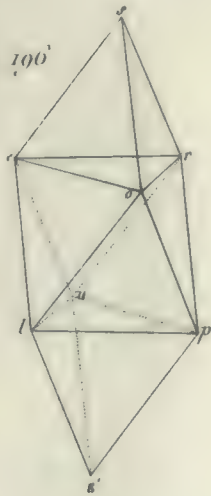

Fig. 197

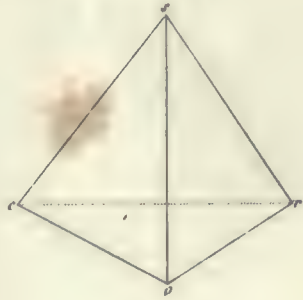

Fig. 208

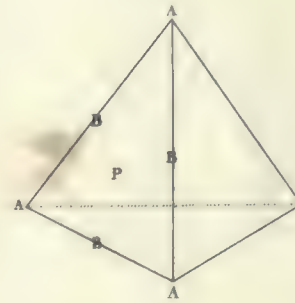

Fig. 200

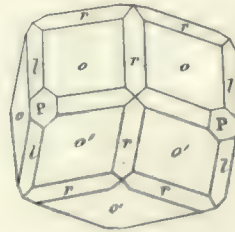

Fig. 201

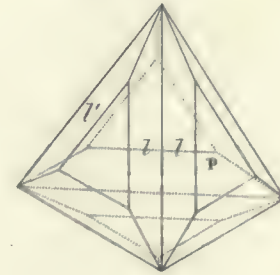

Fig. 199

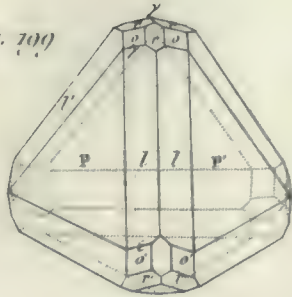

Fig. 203

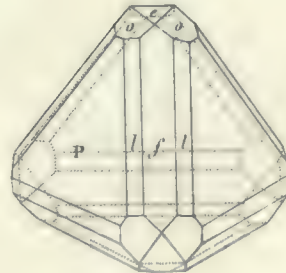

Fig. 204

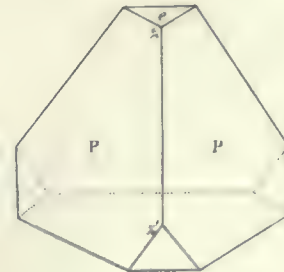

Fig. 202

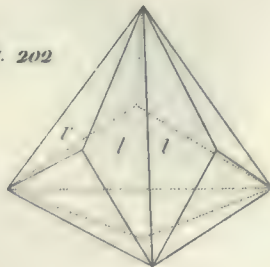



Fig. 205

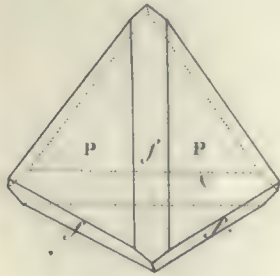

Fig. 206



Fig. 207

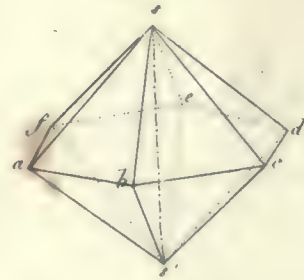

Fig. 208

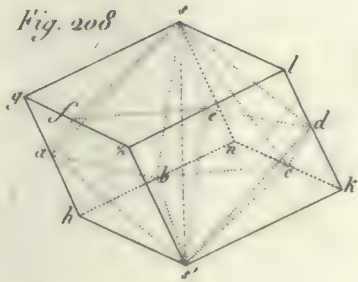

Fig. 209

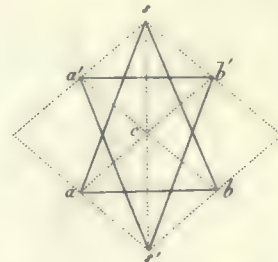

Fig. 210

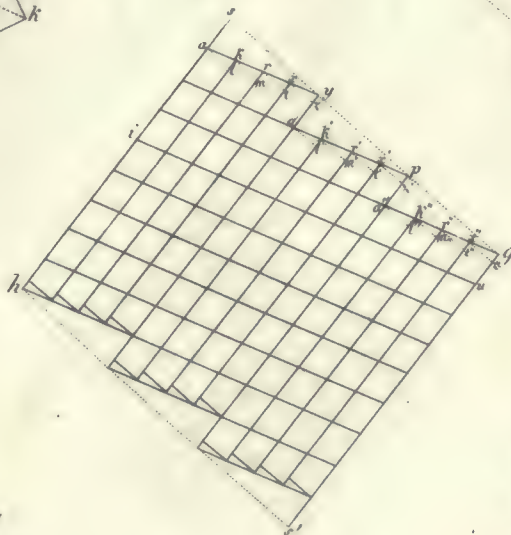

Fig. 211

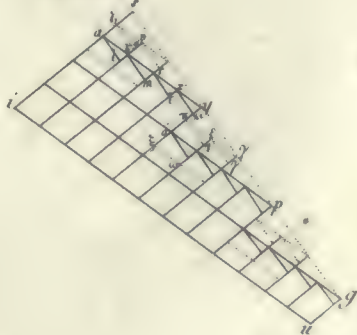
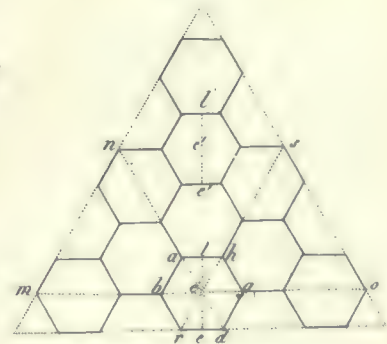

Fig. 212





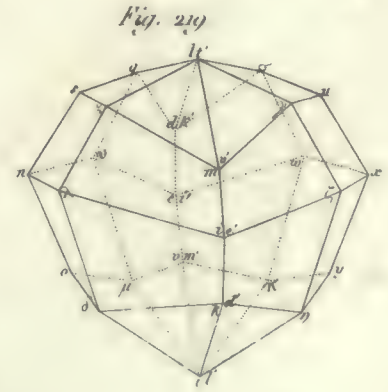
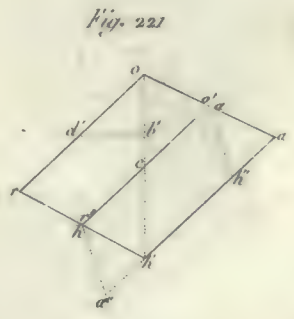
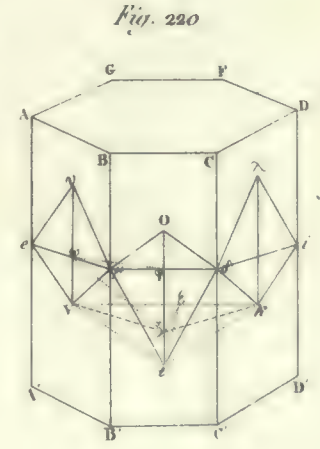
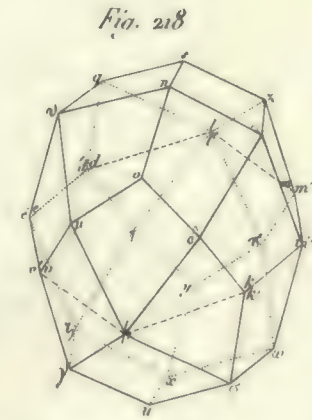
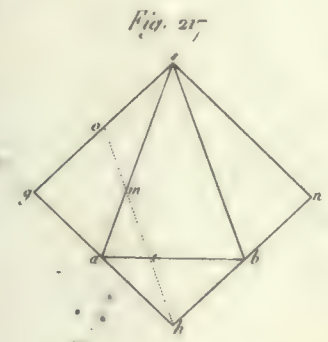
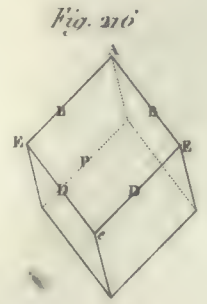
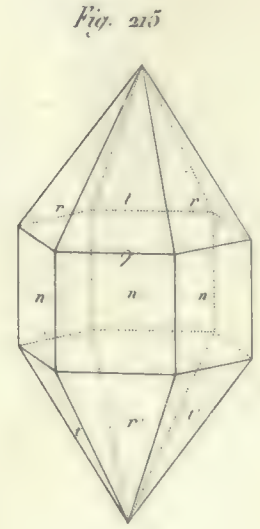
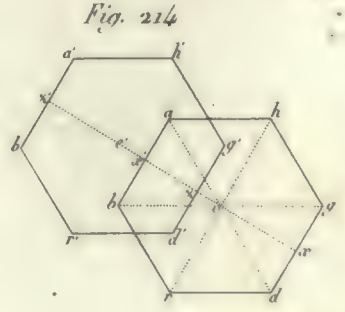
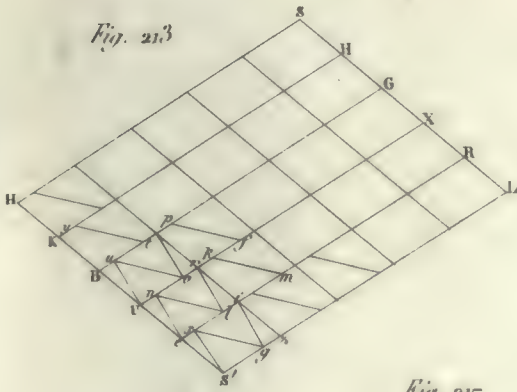



Fig. 222

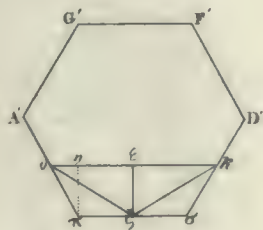

Fig. 223

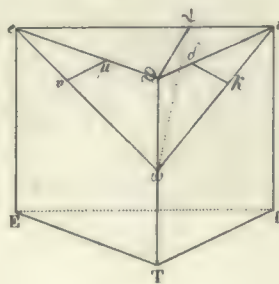

Fig. 224

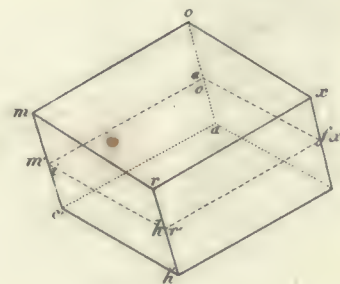

Fig. 225



Fig. 226

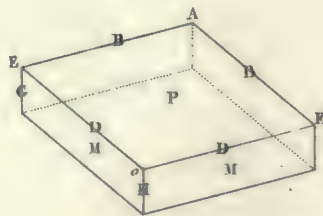

Fig. 227

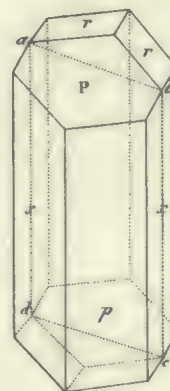

Fig. 228

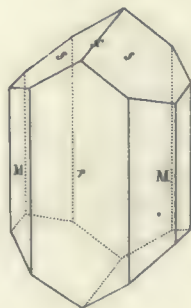

Fig. 229

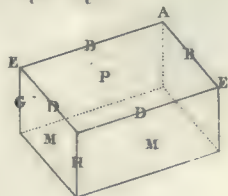

Fig. 230

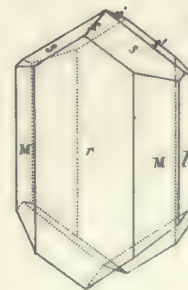



Fig. 231

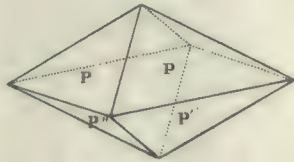

Fig. 232

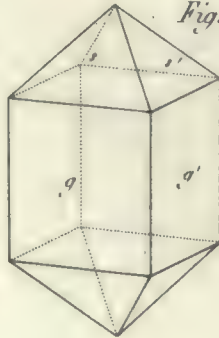

Fig. 233

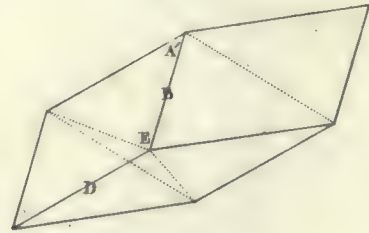

Fig. 234

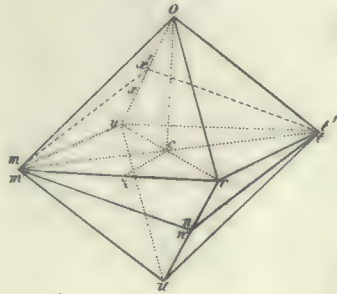

Fig. 235

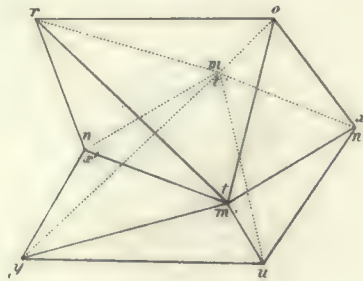

Fig. 236

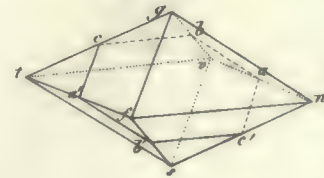

Fig. 237

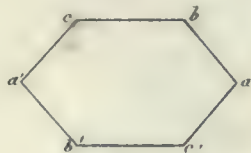

Fig. 238

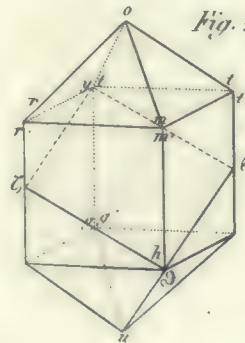
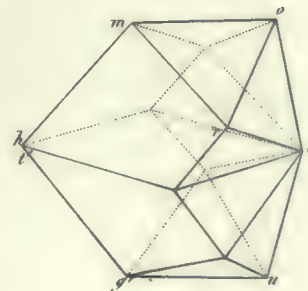

Fig. 239



12/15/2010

12/15/2010

12/15/2010

12/15/2010

12/15/2010

12/15/2010

12/15/2010

12/15/2010

12/15/2010

12/15/2010

12/15/2010

12/15/2010

12/15/2010

12/15/2010

12/15/2010

Fig. 240

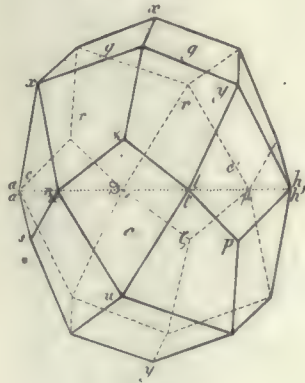

Fig. 241

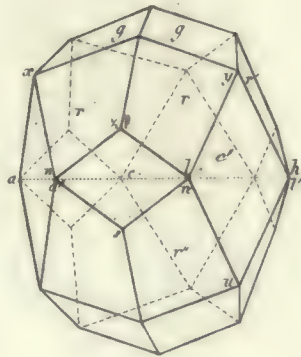

Fig. 242

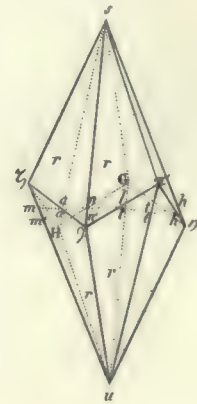

Fig. 243



Fig. 244

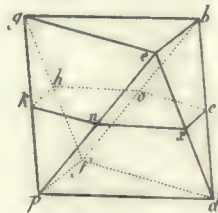

Fig. 247



Fig. 245

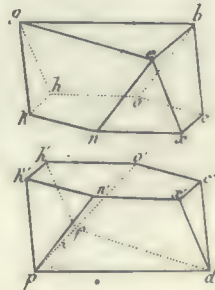

Fig. 246

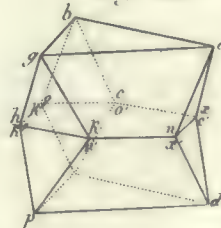



Fig. 248

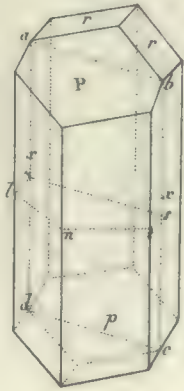

Fig. 249

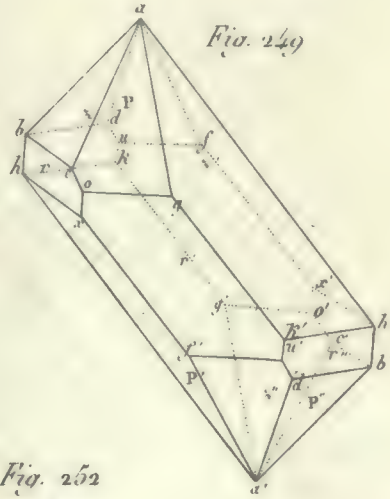

Fig. 250

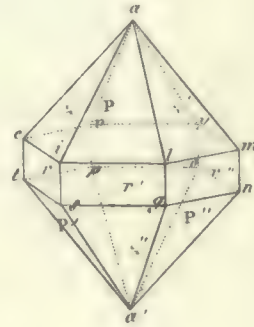

Fig. 252

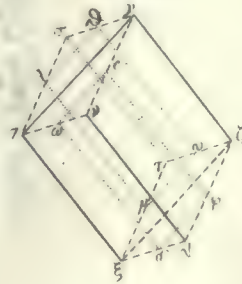

Fig. 254

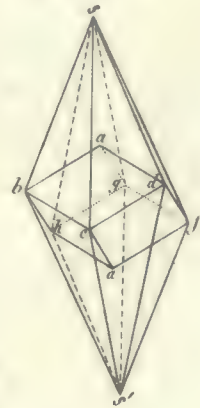

Fig. 255

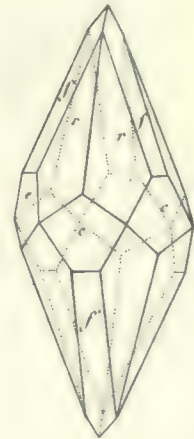

Fig. 251

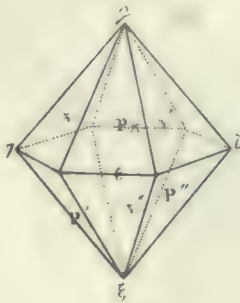

Fig. 253

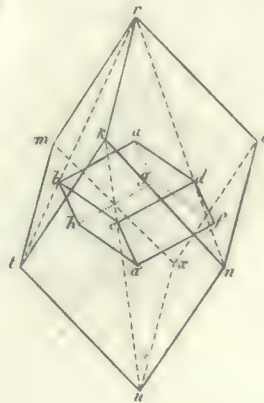



Fig. 256

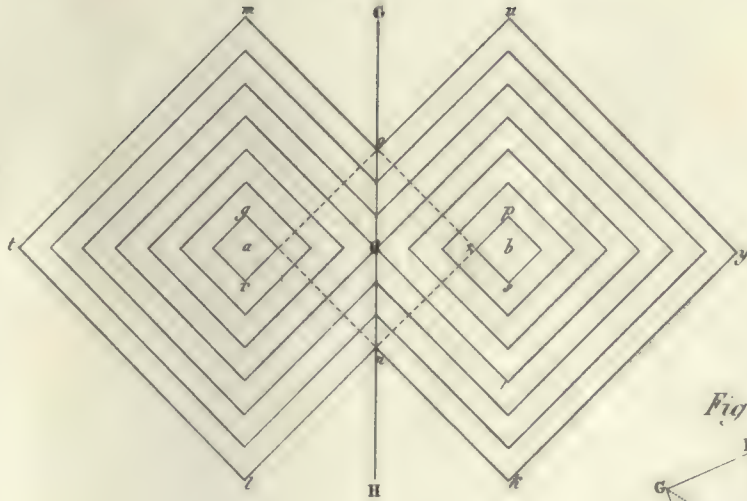

Fig. 258

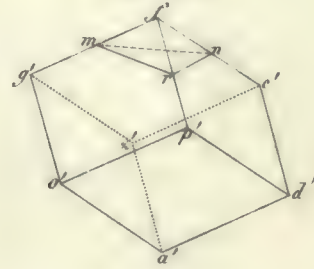

Fig. 260

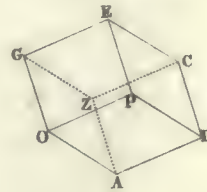

Fig. 259

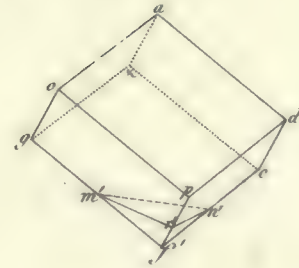

Fig. 257

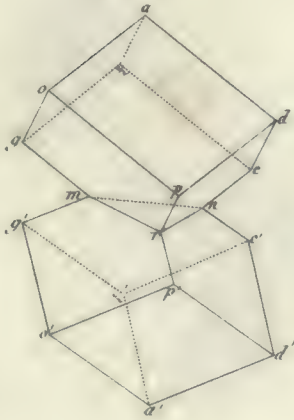

Fig. 261

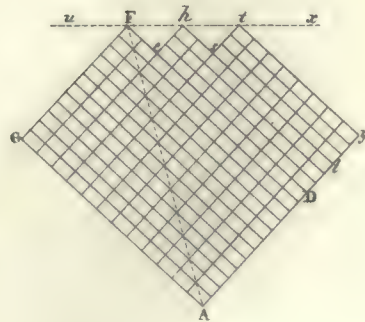

Fig. 262



Fig. 263

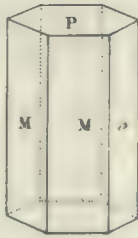

Fig. 264



Fig. 265

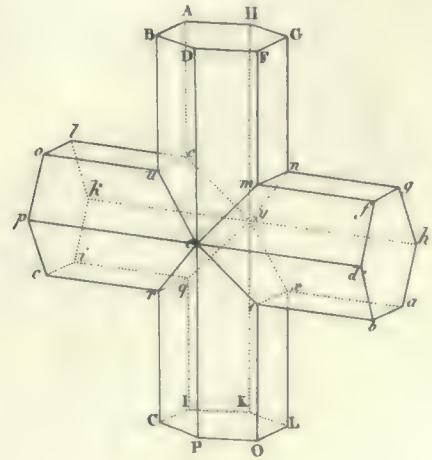

Fig. 267

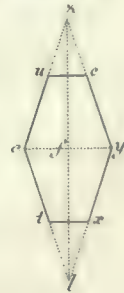

Fig. 266

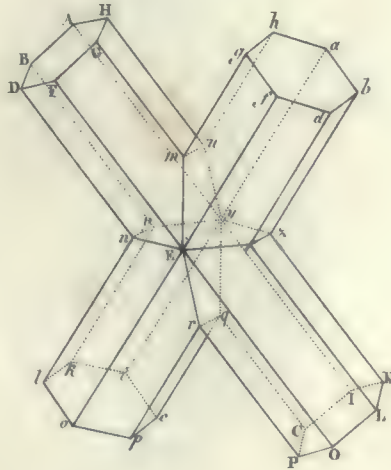

Fig. 268



Fig. 269

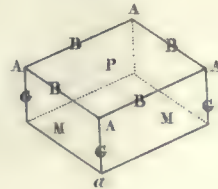



Fig. 270

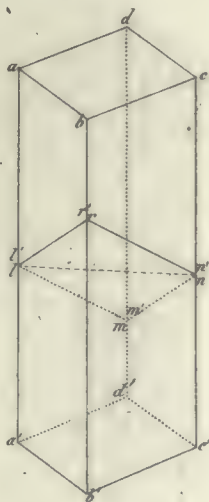

Fig. 271

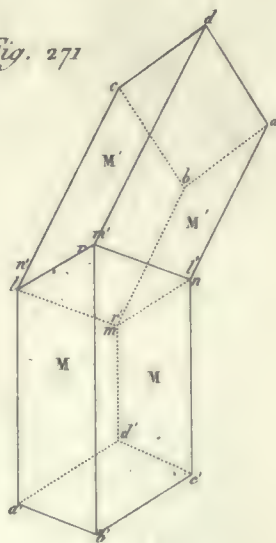

Fig. 272

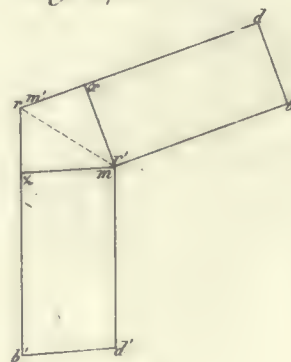

Fig. 273

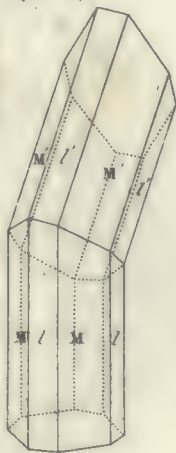

Fig. 274



Fig. 275





Fig. 276

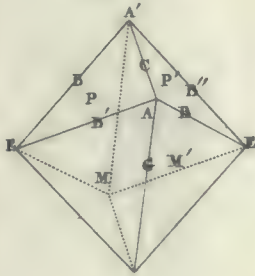

Fig. 277

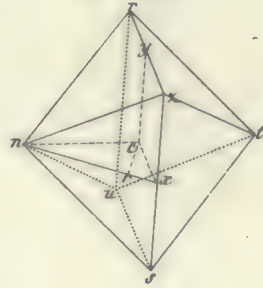

Fig. 278

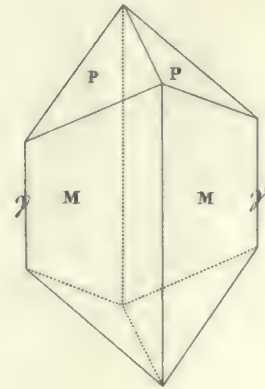

Fig. 279



Fig. 280

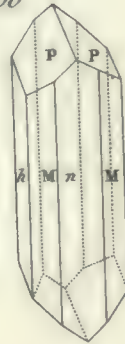

Fig. 283

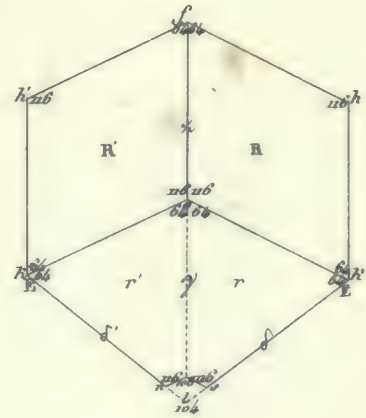

Fig. 281

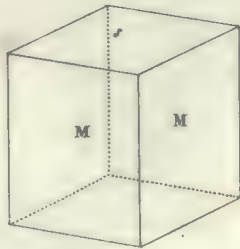

Fig. 282

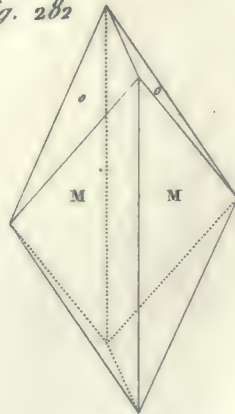



Fig. 284

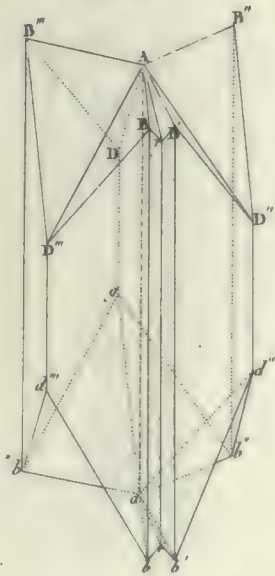

Fig. 285



Fig. 280'



Fig. 288

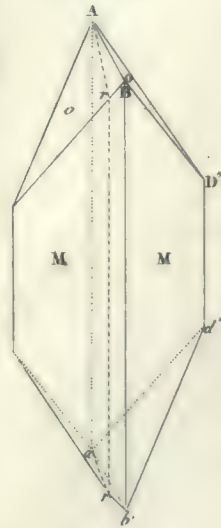

Fig. 287

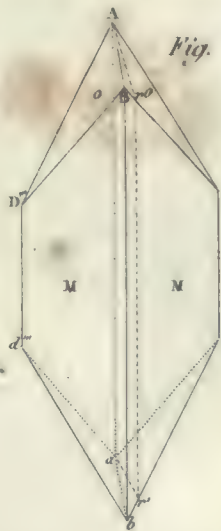

Fig. 280

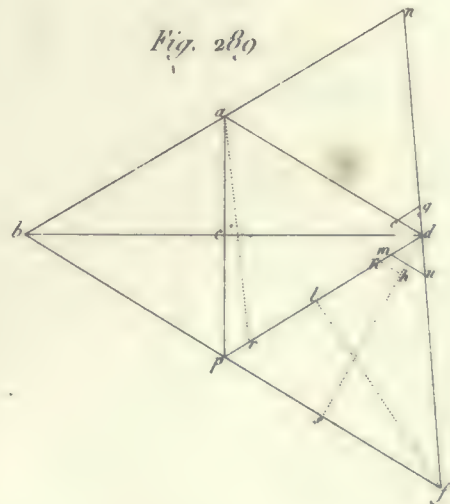



Fig. 290

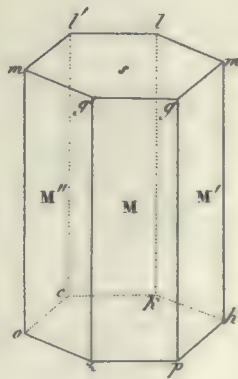

Fig. 291

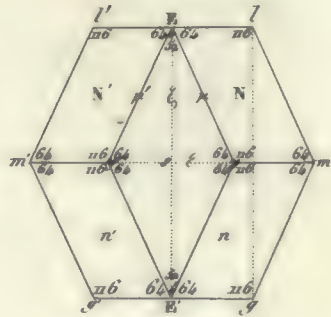

Fig. 292

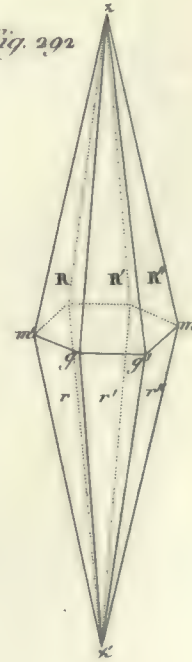

Fig. 293

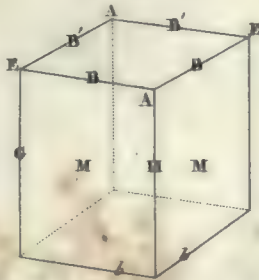

Fig. 294

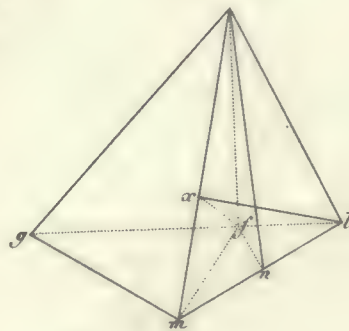

Fig. 297

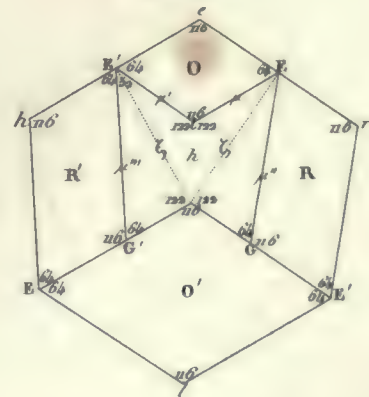

Fig. 295

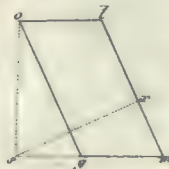

Fig. 296

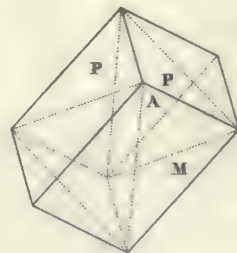



Fig. 298

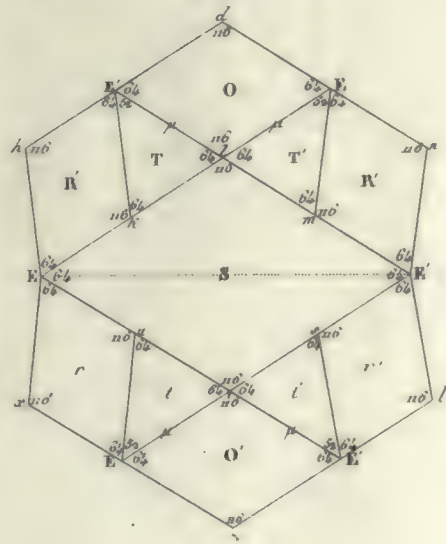

Fig. 299



Fig. 300

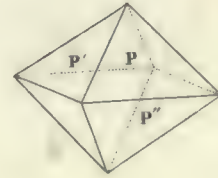

Fig. 301

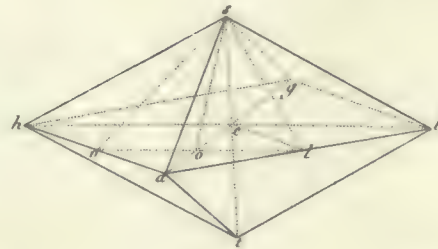

Fig. 303

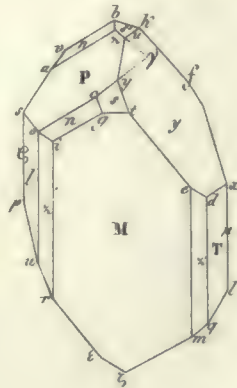

Fig. 302

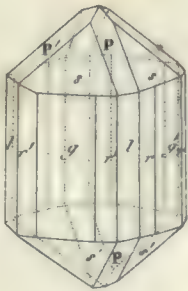
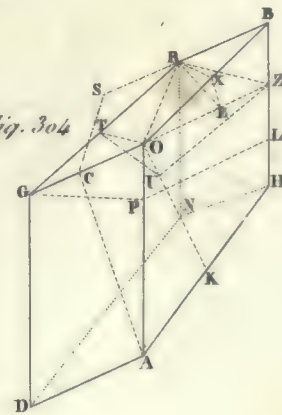

Fig. 304





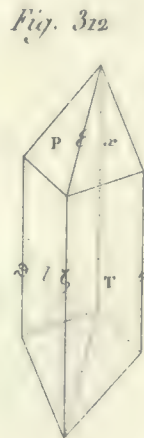
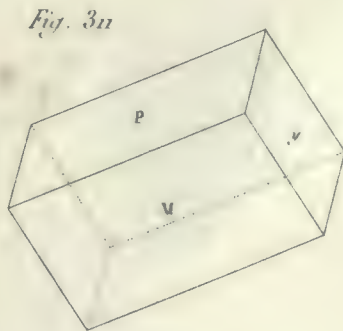
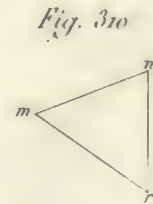
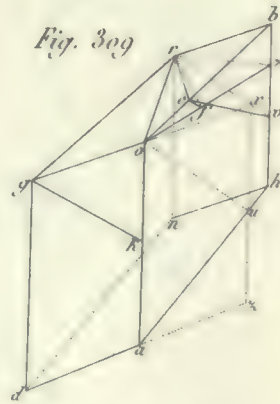
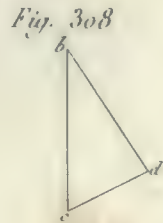
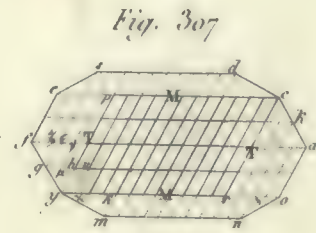
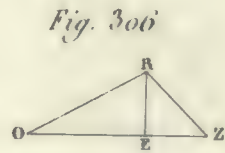
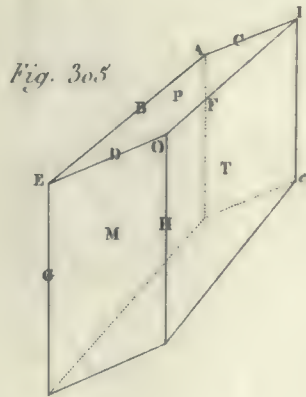



Fig. 314



Fig. 315

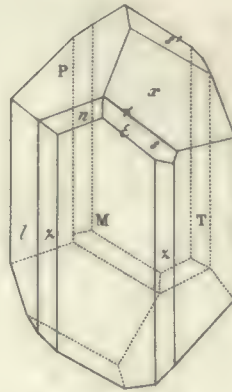

Fig. 310

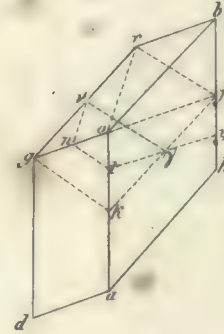

Fig. 317

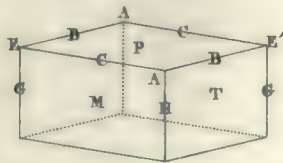

Fig. 318

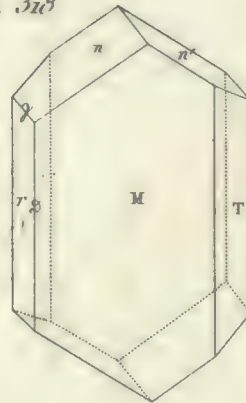

Fig. 319

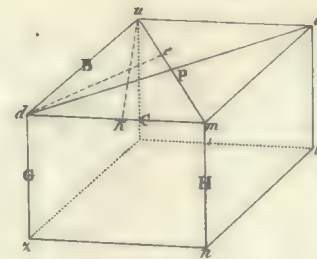

Fig. 320

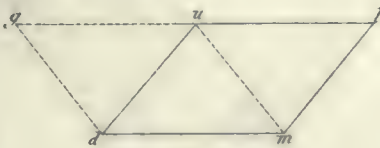
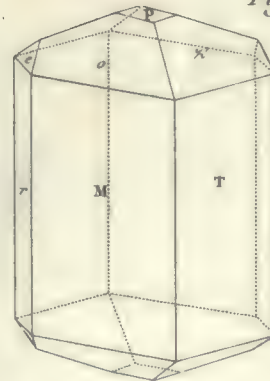

Fig. 321



Fig. 322



The first part of the report
 deals with the general
 situation of the country
 and the progress of
 the various branches
 of the service. It
 is followed by a
 detailed account of
 the operations of
 the different
 departments during
 the year. The
 report concludes
 with a summary
 of the results
 achieved and a
 statement of the
 resources available
 for the coming
 year.

Fig. 323

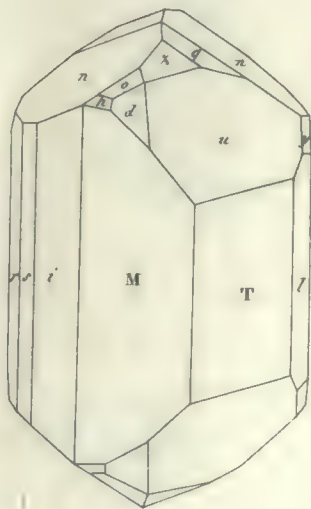

Fig. 324

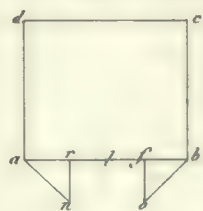

Fig. 325

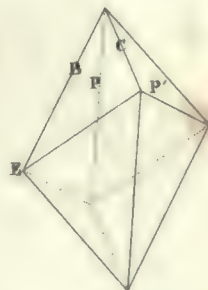

Fig. 326

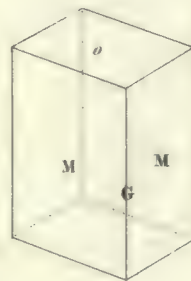

Fig. 328

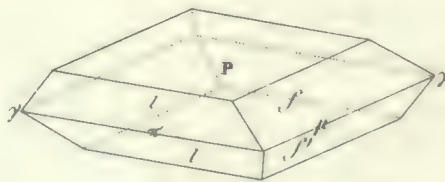

Fig. 330

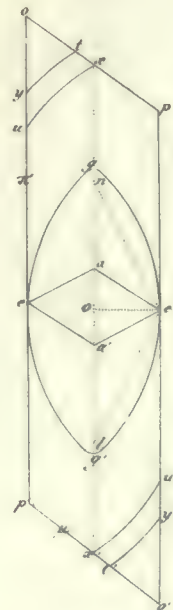

Fig. 327

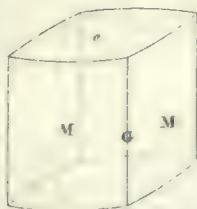

Fig. 329

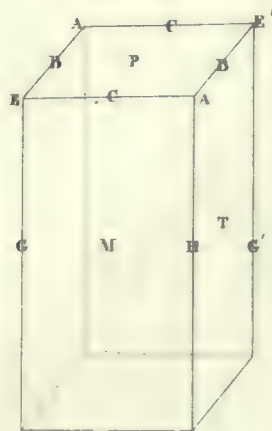

Fig. 331

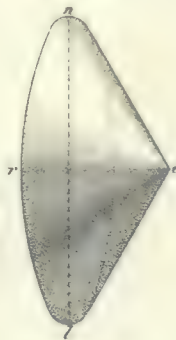



Fig. 1

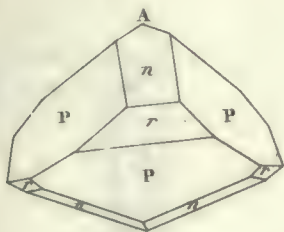

Fig. 2

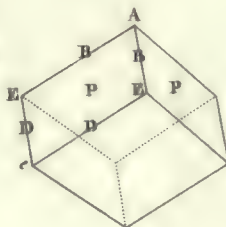

Fig. 3

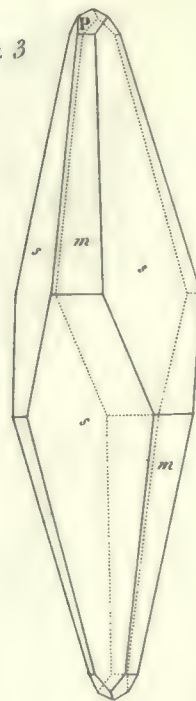

Fig. 5

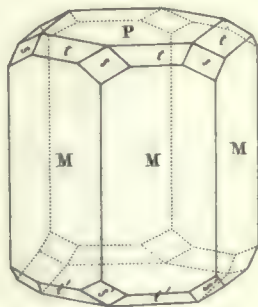

Fig. 4

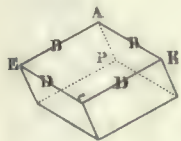

Fig. 6

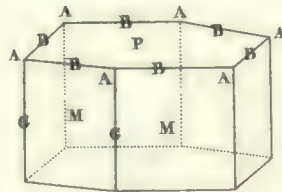

Fig. 7

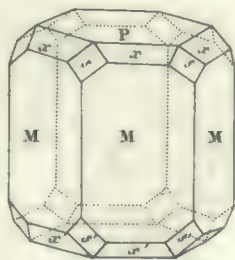

Fig. 8

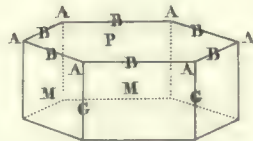

Fig. 9

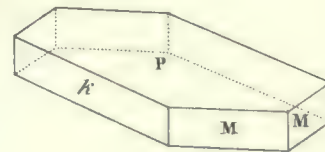



Fig. 10

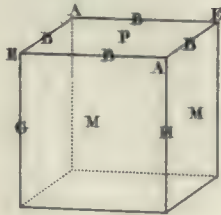

Fig. 11

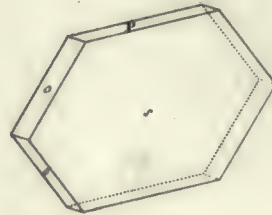

Fig. 12

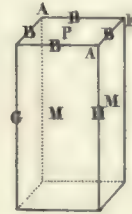

Fig. 13

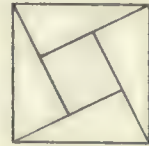

Fig. 14



Fig. 15

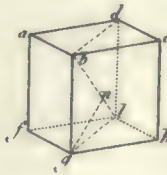

Fig. 16



Fig. 17



Fig. 18

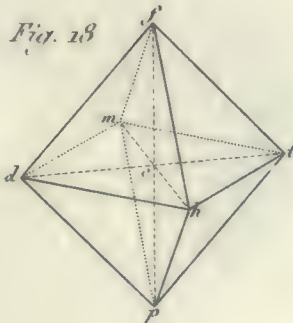

Fig. 19

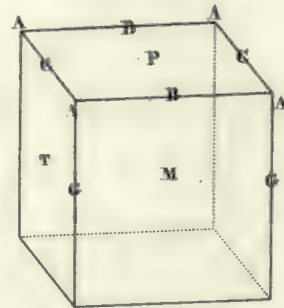
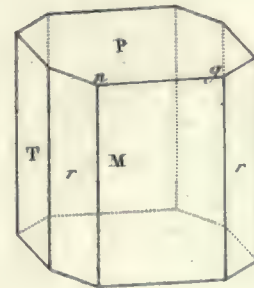

Fig. 20



THE UNIVERSITY OF CHICAGO
LIBRARY

Fig. 21



Fig. 22

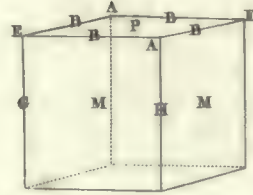

Fig. 23

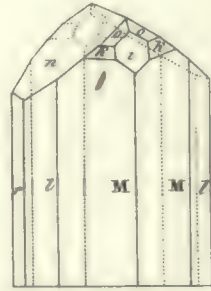

Fig. 24

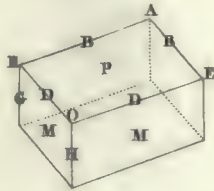

Fig. 25



Fig. 26

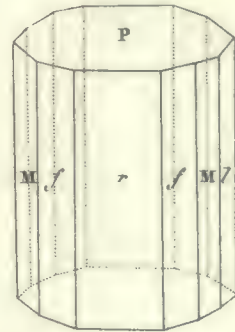

Fig. 27

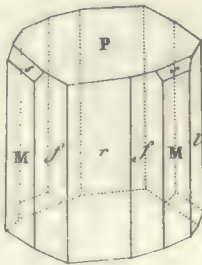

Fig. 28

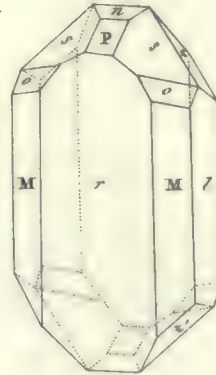

Fig. 29

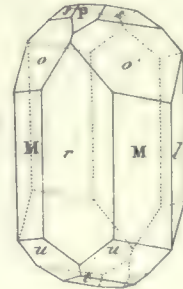



Fig. 30

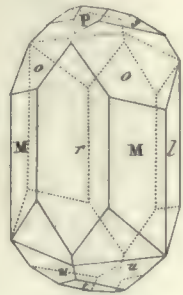

Fig. 31

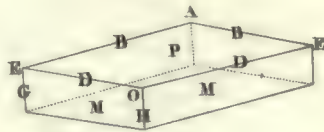

Fig. 32



Fig. 33



Fig. 34



Fig. 35



Fig. 36

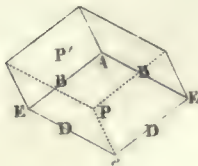

Fig. 37

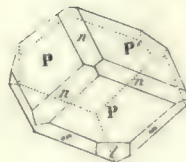

Fig. 38

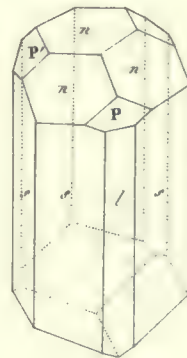



Fig. 39

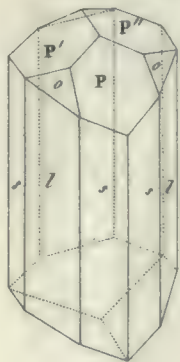

Fig. 40

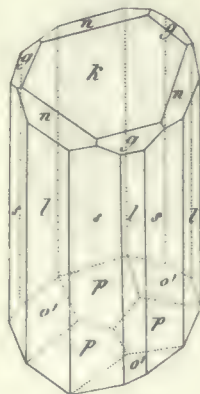

Fig. 41

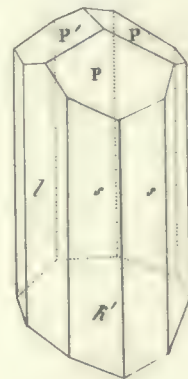

Fig. 42

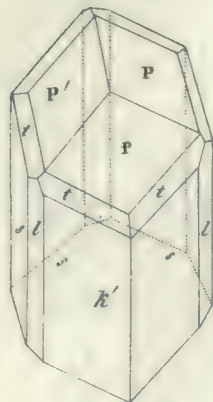

Fig. 43

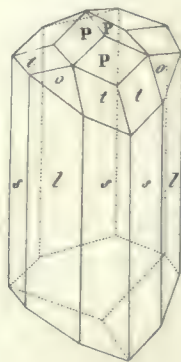

Fig. 44





Fig. 45

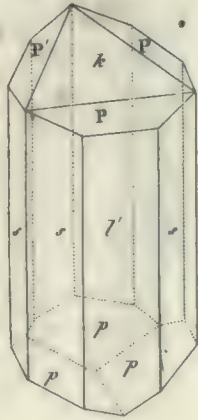

Fig. 46

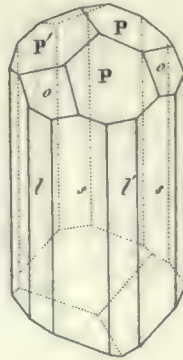

Fig. 47

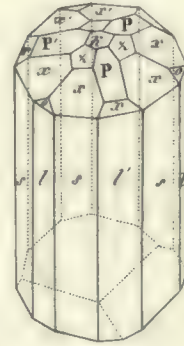

Fig. 48

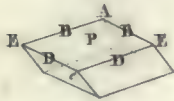

Fig. 49

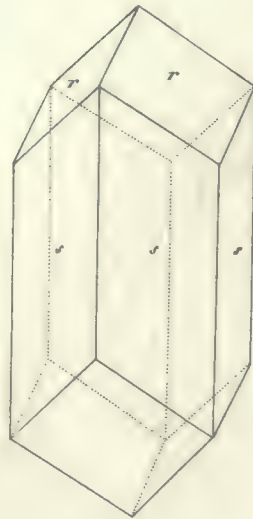

Fig. 50

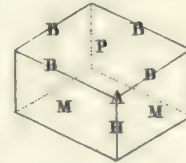

Fig. 51

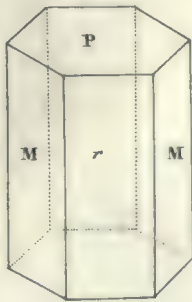

Fig. 52





Fig. 1

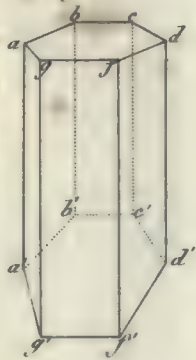

Fig. 2

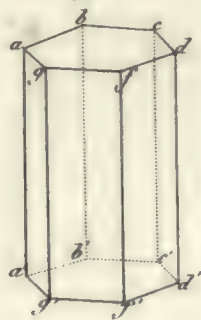

Fig. 3

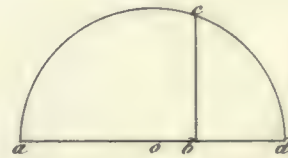

Fig. 4

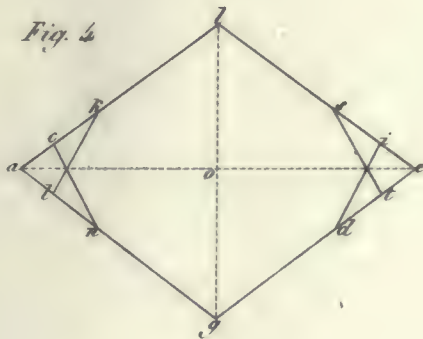

Fig. 5

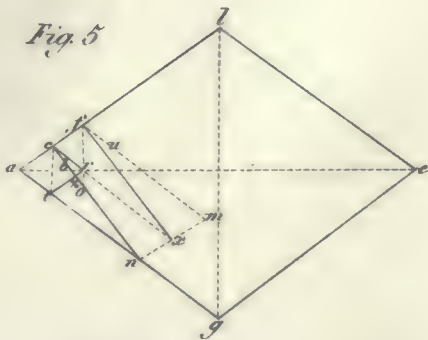

Fig. 6

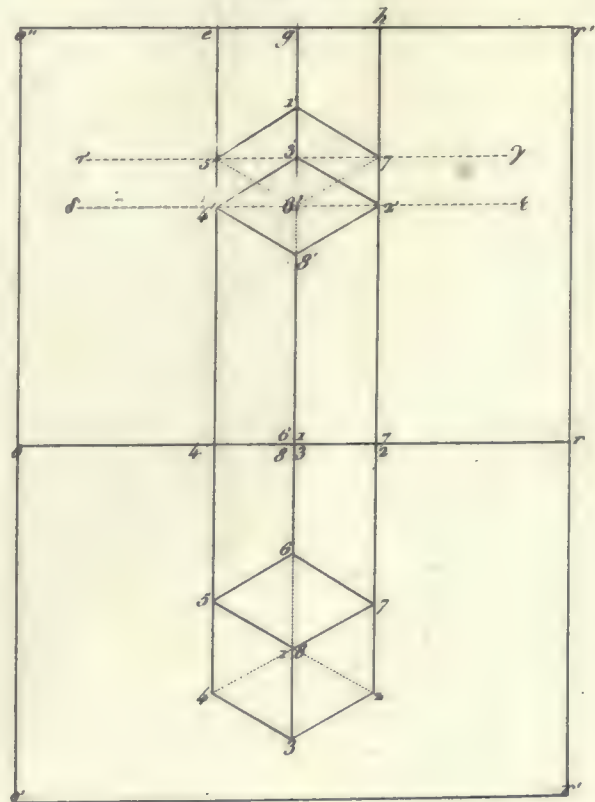



Fig. 7

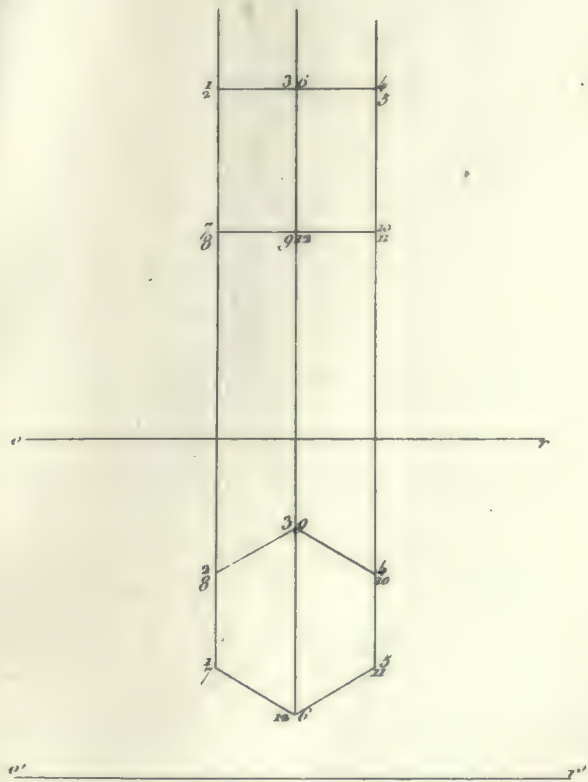

Fig. 8

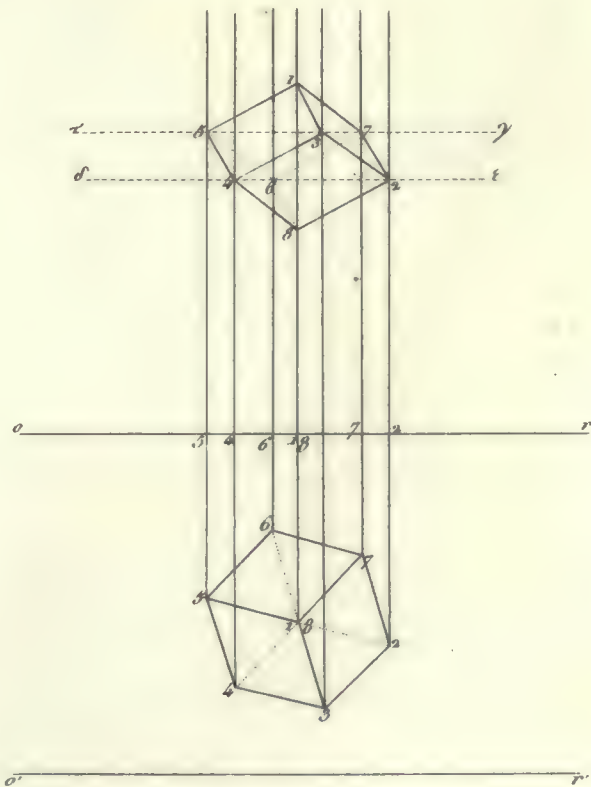





Fig. 14

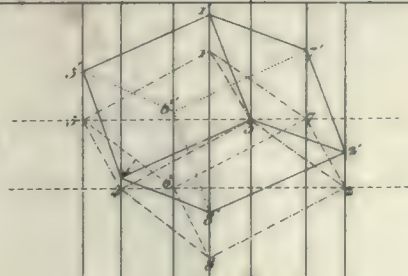

Fig. 15

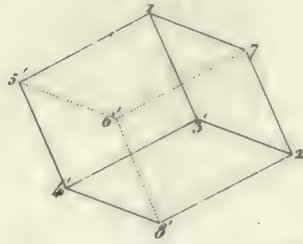

Fig. 18

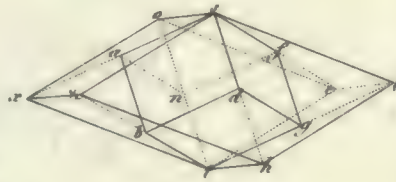

Fig. 16

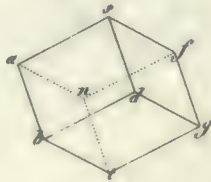

Fig. 17

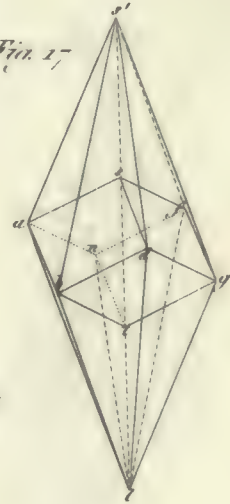

Fig. 13

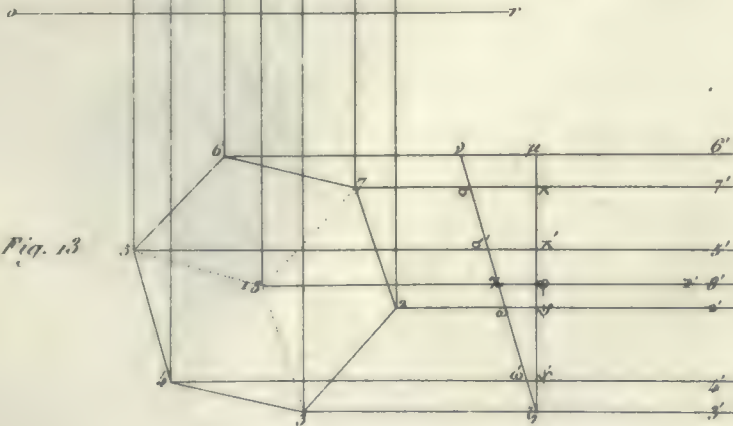

Fig. 20

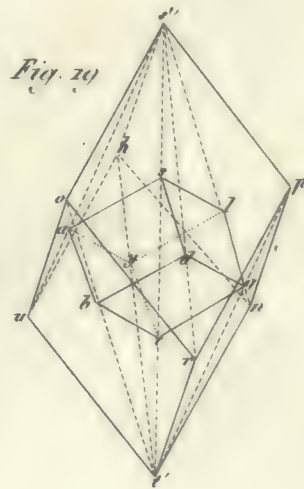





Fig. 26

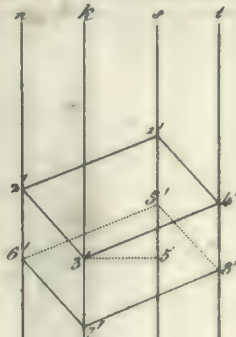

Fig. 27

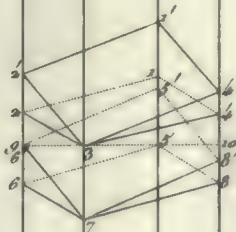

Fig. 28

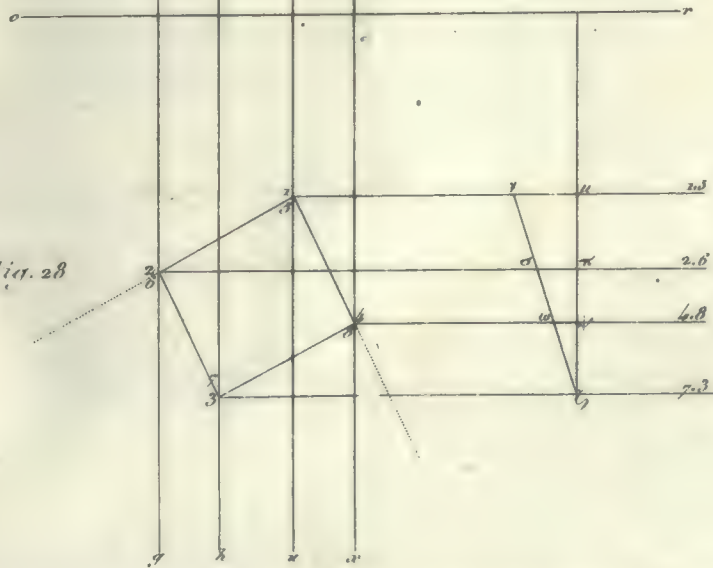

Fig. 29

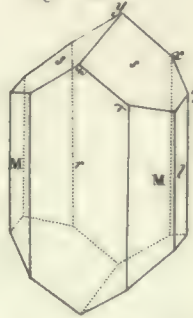

Fig. 30

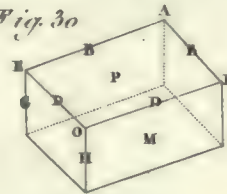

Fig. 31

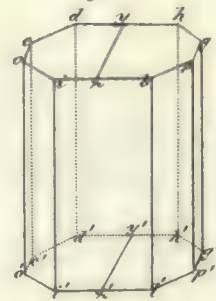

Fig. 32

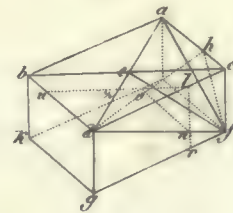

Fig. 33

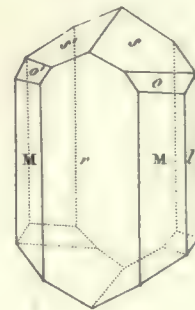

Fig. 34

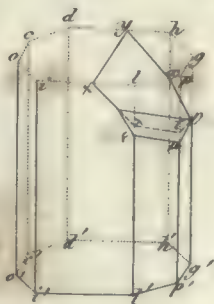

Fig. 35

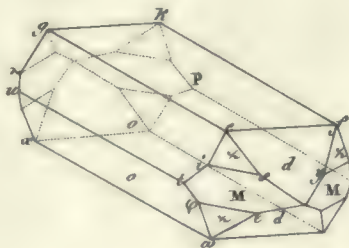

Fig. 36

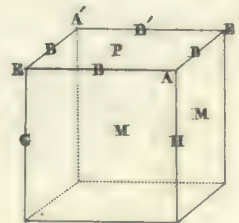

Fig. 39

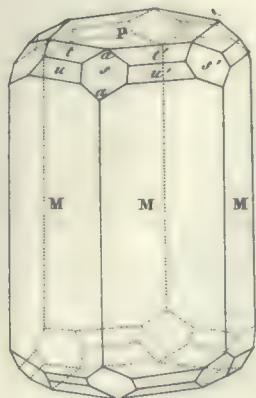

Fig. 37

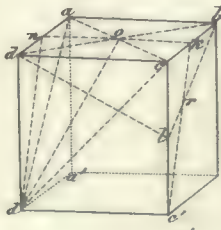

Fig. 38

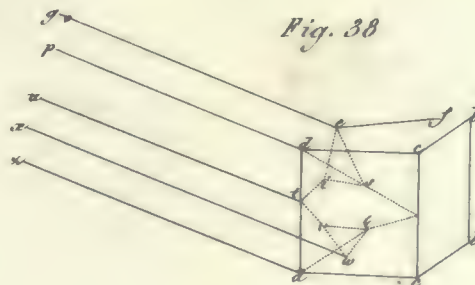
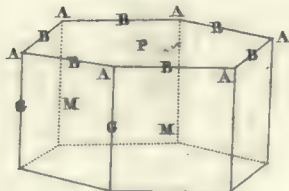

Fig. 40





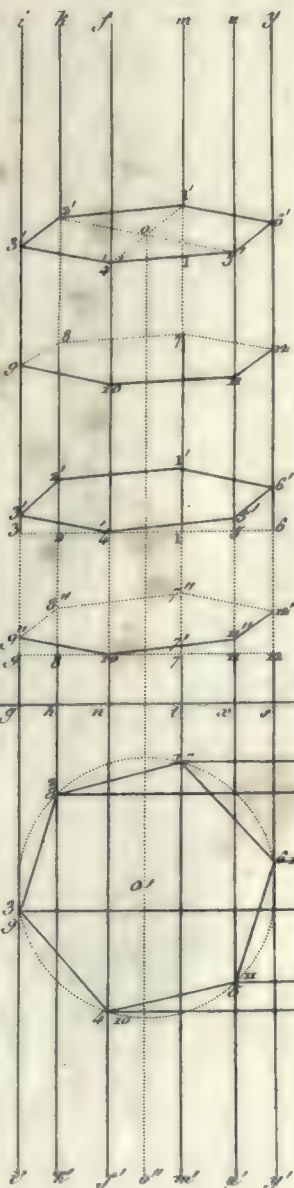

Fig. 41

Fig. 43

Fig. 42

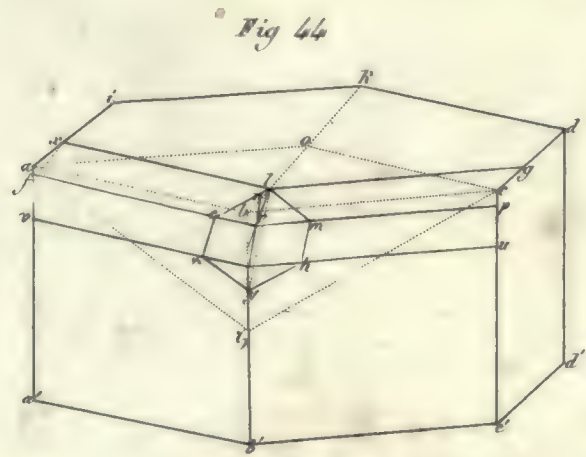

Fig. 44

Fig. 45



Fig. 46



Fig. 47

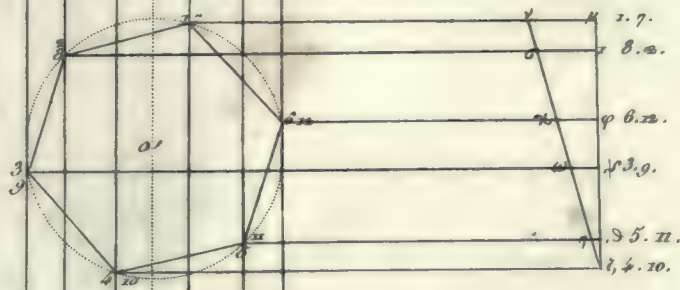
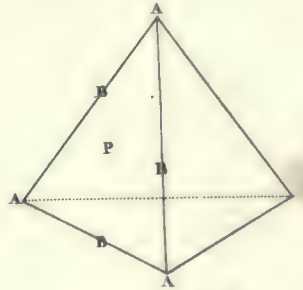





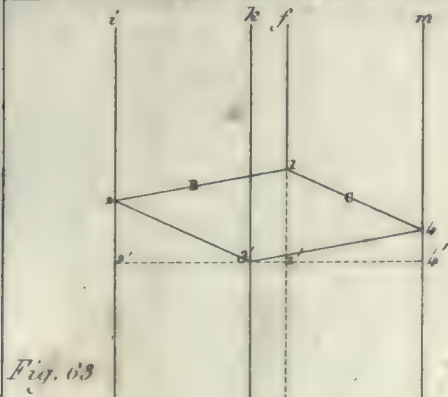

Fig. 63

Fig. 57

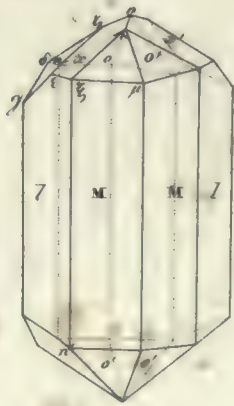

Fig. 58

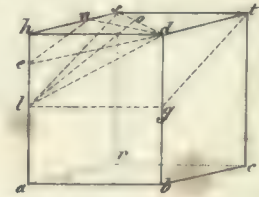

Fig. 60

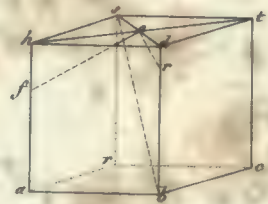

Fig. 60. bis



Fig. 59

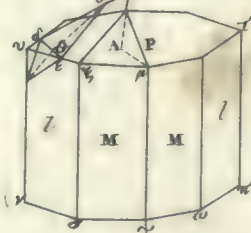

Fig. 61



Fig. 62

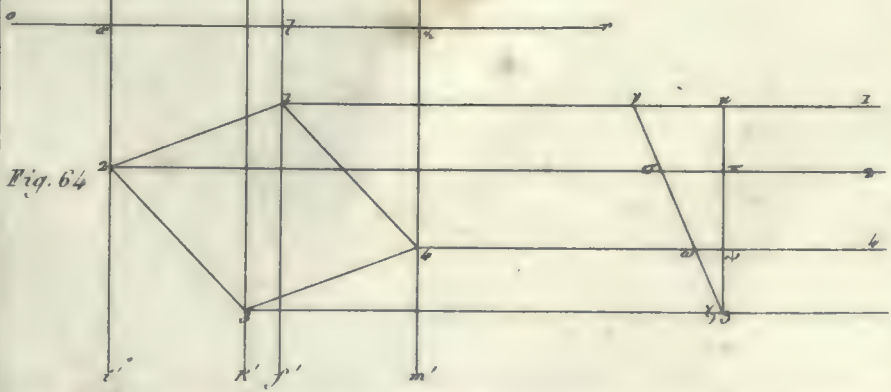
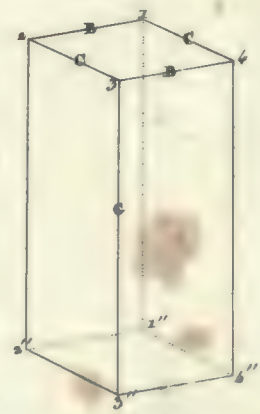

Fig. 64



Fig. 68

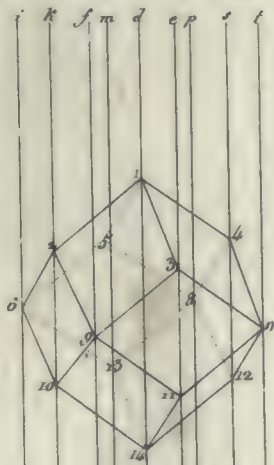

Fig. 70

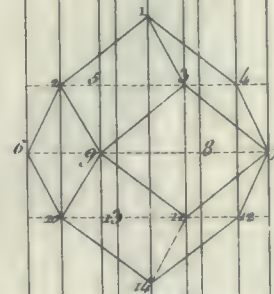

Fig. 69

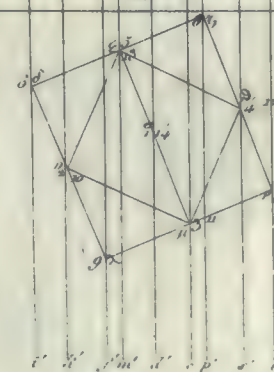

Fig. 65

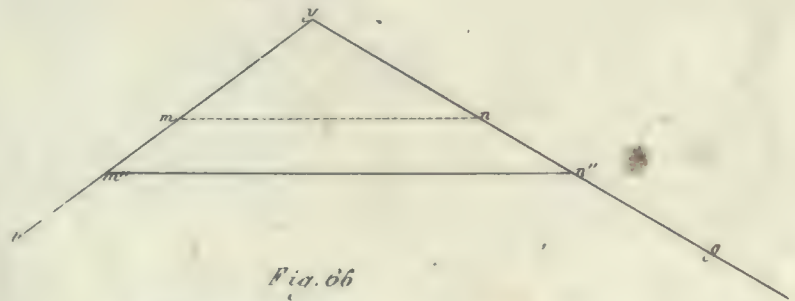

Fig. 66



Fig. 67

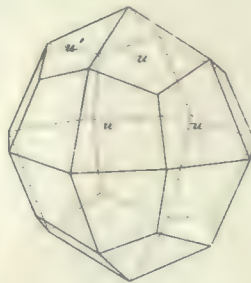

Fig. 71

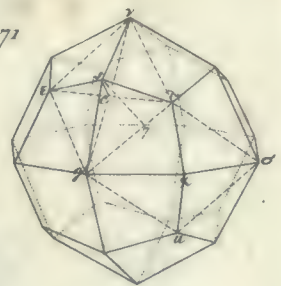

Fig. 72

