



HARVARD UNIVERSITY.



LIBRARY

OF THE

MUSEUM OF COMPARATIVE ZOÖLOGY.

149.

Exchange.

June 8 1906 - March 12, 1907.

TRANSACTIONS
OF
THE ACADEMY OF SCIENCE
OF ST. LOUIS.

VOL. XVI.

JANUARY 1906 TO DECEMBER 1906.

PUBLISHED UNDER DIRECTION OF THE COUNCIL.

ST. LOUIS
NIXON-JONES PRINTING CO.

CONTENTS.

	PAGE.
TABLE OF CONTENTS	iii
LIST OF MEMBERS. Revised to December 31, 1906.....	v
1. PATRONS.	
2. HONORARY MEMBERS.	
3. ACTIVE MEMBERS.	
CONSTITUTION	ci
BY-LAWS	cv
ABSTRACT OF HISTORY.....	cx
RECORD. January 1 to Dec. 31, 1906.....	cxiv
PAPERS PUBLISHED. January 1 to December 31, 1906:	
1. —. — Celebration of the Fiftieth Anniversary of the First Meeting. — Issued July 23, 1906.....	xv
2. FRANK COLLINS BAKER. — Notes on a Collection of Mol- lusks from the Vicinity of Alpena, Michigan. — Plate I. — Issued May 21, 1906.....	1
3. FRANCIS E. NIPHER. — On Pressure Measurements in a Fluid Stream. — Issued May 31, 1906.....	17
4. N. M. GLATFELTER. — Preliminary List of Higher Fungi Collected in the Vicinity of St. Louis, Mo., from 1898 to 1905. — Issued June 14, 1906.....	33
5. ROBERT J. TERRY. — The Nasal Skeleton of <i>Amblystoma</i> <i>punctatum</i> (Linn.). — Plates II-V. — Issued Decem- ber 1, 1906.....	95
6. THOS. L. CASEY. — Observations on the Staphylinid groups Aleocharinae and Xantholinini, chiefly of America. — Issued November 22, 1906.....	125
7. STUART WELLER. — Kinderhook Faunal Studies. IV. The Fauna of the Glen Park Limestone. Plates VI, VII. — Issued December 11, 1906.....	435
8. B. M. DUGGAR. — The Relation of Certain Marine Al- gae to Various Salt Solutions. — Issued December 21, 1906.....	473
9. TITLE-PAGE, prefatory matter and index of Vol. XVI. — Record January 1 to December 31, 1906. — Issued February 28, 1907.	
LIST OF AUTHORS.....	491
GENERAL INDEX.....	493
INDEX TO GENERA.....	495

CORRECTIONS.

- P. XXII, line 23. — Read John H. Watters.
- P. XLI, line 25. — Read John H. Watters.
- P. 8, line 2. — Read *Physa crandalli* Baker (*Physa rhomboidea* Crandall 1901, non Meek and Hayden, 1856.)
- P. 152, line 16. — For Esch., read Mann.
- P. 191, line 11 from bottom. — For 7.2, read 0.72.
- P. 291, line 16 from bottom. — For n. sp., read Mels.
- P. 390, last line. — After *Melanops* insert n. sp.
- P. 435 to 471. — For Plate I, read Plate VII and for Plate II, read Plate VI.
- P. 474, line 5 from bottom. — For isotomic, read isotonic.
- P. 476, line 20. — For determing, read determining.
22. — For accomodate, read accommodate.
- P. 479, line 21. — For labaratory, read laboratory.
- P. 485, line 7 from bottom. — For cleary, read clearly.
- P. 487, line 3. — For s, read is.
6. — For sulphate read Sulphate.
9. — For abou, read about and for he, read the.
- P. 488, line 2. — Omit in.

MEMBERS.

1. PATRONS.

Eliot, Henry W.....2635 Locust st.
†Harrison, Edwin.....
McMillan, Mrs. Eliza.....25 Portland pl.
McMillan, William Northrop.....Century bldg.

2. HONORARY MEMBERS.

Arrhenius, Prof. Svante.....University of Stockholm, Sweden.
Bahlsen, Prof. Dr. Leopold.....Berlin, Germany.
†Boltzmann, Prof. Ludwig.....
†Chavero, Seoñr Alfredo.....
Escherich, Prof. Theodore.University of Vienna, Austria.
Kitasato, Prof. ShibasaburoUniversity of Tokio, Japan.
Lewald, Geh. Oberreg. Rath Theo-
dor.Berlin, Germany.
Limburg, Stirum, Graf.....Berlin, Germany.
Moissan, Prof. Henri.....Sorbonne, Paris, France.
Orth, Geh. Rath Dr. Johann.....University of Berlin, Germany.
Oswald, Prof. Wilhelm.....University of Leipzig, Germany.
Ramsay, Sir William.....Royal Institute, London England.
Rutherford, Prof. Ernest.....McGill University, Montreal,
Canada.
Van't Hoff, Prof. J. WUniversity of Berlin, Germany.
Waldeyer, Geh. Rath Prof. Dr.
Wilhelm.....University of Berlin, Germany.
Wassermann, Prof. Dr. A.....University of Berlin, Germany.
Wittmack, Geh. Reg. Rath Prof.
Dr. L.....University of Berlin, Germany.

3. ACTIVE MEMBERS.

Adkins, James.....Park and Vandeventer avs.
Alleman, Gellert*.....Swarthmore College,
Swarthmore, Pa.

* Non-resident.

† Deceased.

- Gerling, H. J.....4320 Cook av.
 Glasgow, Frank A.....3894 Washington boul.
 Glasgow, William C.....4500 Olive st.
 Glatfelter, N. M.....4720 N. 20th st.
 Goldstein, Max A.....3858 Westminster p.
 Goodman, Charles H.....3329 Washington av.
 Graf, A. V.....1325 S. 7th st.
 Graves, William W.....Vanol bldg.
 Green, John.....2670 Washington av.
 Grindon, Joseph.....3894 Washington boul.
 Gundelach, Chas. H.....4523 Washington boul.
 Gundelach, W. J.....3703 Finney av.

 Haarstick, Henry C.....St. Louis Union Trust bldg.
 Hambach, Gustav †.....1319 Lami st.
 Hardaway, W. A.....4500 Olive st.
 Harris, James Arthur.....Mo. Botanical Garden.
 Hartmann, Rudolph.....2020 Victor st.
 Held, George A.....International Bank.
 Herzog, William.....3651 Castleman av.
 Hirschberg, Francis D.....3818 Lindell boul.
 Hitchcock, George C.....709 Wainwright bldg.
 Homan, George.....323 Odd Fellows' bldg.
 Hough, Warwick.....Circuit Court, Room 1.
 Hughes, Charles Hamilton.....3872 Washington boul.
 Hunicke, Henry August.....3532 Victor st.
 Hurter, Julius2346 S. 10th st.
 Hus, Henri Th. AMo. Botanical Garden.

 Ilg, Theo.....3148 S. Grand av.
 Irish, Henry C.....Mo. Botanical Garden.
 Ives, Halsey Cooley.....Museum of Fine Arts.

 Keiser, Edward H.....Washington University.
 Kinealy, John H.....619 Granite bldg.
 King, Goodman.....78 Vandeventer pl.
 Kirchner, Walter C. G.....1127 N. Grand av.
 Klem, Mary J.....3133 Nebraska av.
 Koch, Waldemar H. A.*.....State University, Columbia, Mo.

† Elected a life-member, January 3, 1882.

- Palmer, Ernest Jesse*.....321 S. Allen st., Webb City, Mo.
Pammel, Louis Hermann*.....Ames, Ia.
Pantaleoni, Guido.....415 Locust st.
Parker, George Ward*.....45 Broadway, New York City.
Pauls, Gustavus.....St. Louis Altenheim.
Pettus, Chas. P.....2804 Pine st.
Pettus, W. H. H.....4373 Westminster pl.
Pike, Sherman B.*.....Seattle, Wash.
Pitzman, Julius.....1900 S. Compton av.
Poats, Thomas Grayson*.....Clemson College, S. C.
Post, Martin Hayward.....5371 Waterman av.
Prynne, Charles Martyn.....Century bldg.
- Randall, John E.*.....Cleveland Lamp Factory, Cleve-
land, O.
- Raphael, Abraham.....5555 Clemens av.
Ravold, Amand.....2806 Morgan st.
Rice, Chas. M.....3733 West Pine boul.
Richter, Phil. George.....2424 S. 18th st.
Robert, Edward Scott.....1105 Missouri Trust bldg.
Roever, William Henry*.....44 Martin st., Cambridge, Mass.
Rofls, Peter H*.....Tropical Laboratory, Miami, Fla.
Rosenwald, Lucian*.....412 Delaware st., Kansas City, Mo.
Ruf, Frank A.....5863 Cabanne pl.
Ryan, Frank K.....2725 Lawton av.
- Sander, Enno.....2807 Lawton av.
Sargent, Charles Sprague*.....Jamaica Plains, Mass.
Sauer, Wm. E.....Humboldt bldg.
Schmidt, Louis.....Franklin Bank.
Schmitz, R.....6th and St. Charles sts.
von Schrenk, Hermann.....Mo. Botanical Garden.
Schroers, John.....1730 Missouri av.
Schrowang, Otto.....Panama bldg.
Schwarz, Frank.....1520 Lafayette av.
Schwarz, Henry.....440 N. Newstead av.
Schweitzer, Paul*.....Columbia, Mo.
See, Thomas Jefferson Jackson*..Naval Observatory.
Mare Island, Cal.
- Selby, Augustine Dawson*.....Wooster, O.
Senseney, E. M.....2829 Washington av.
Sheldon, Walter L.....4533 Westminster pl.
Shepley, John F.....60 Vandeventer pl.

- Shoemaker, William Alfred.....4386 Westminster pl.
 Shutt, C. H.....Emergency Hospital No. 2.
 Simmons, E. C.....9th and Spruce sts.
 Simmons, Wallace D.....9th and Spruce sts.
 Sluder, Greenfield.....3542 Washington av.
 Smith, Arthur George*.....422 N. Dubuque st., Iowa City, Ia.
 Smith, D. S. H.....3646 Washington boul.
 Smith, Irwin Z.....83 Vandeventer pl.
 Smith, Jared G.*.....Honolulu, Hawaiian Islands.
 Soldan, F. Louis.....3634 Flad av.
 Spiegelhalter, Joseph.....2166 Lafayette av.
 Starkloff, H. M.....3623 Cleveland av.
 Starr, John E.*.....258 Broadway, New York City.
 Staudinger, B.....3556 Lindell boul.
 Stedman, John Moore*.....State University, Columbia, Mo.
 Stevens, Charles D.....1749 S. Grand av.
 Stevens, Wyandotte James.....4043 Juniata st.
 Stocker, George J.....2833 S. Kingshighway boul.
 Summa, Hugo.....2249 St. Louis av.
- Taussig, Albert E3519 Washington av.
 Taussig, William.....3447 Lafayette av.
 Terry, Robert James*.....8 S. Strathmore Road, Brookline,
 Mass.
- Thacher, Arthur.....5185 Lindell boul.
 Thomas, John R4128 Washington boul.
 Thurman, John S.....4436 Olive st.
 Timmerman, Arthur H.....2017 Locust st.
 Tittmann, Harold H.....5024 Westminster pl.
 Trelease, William.....Mo. Botanical Garden.
 Tyler, Eliza Edward*.....State University, Columbia, Mo.
 Tyrrell, Warren Ayers.....620 Chestnut st.
- Vallé, Jules F.....3303 Washington av.
 Van Ornum, John LaneWashington University.
 Vickroy, Wilhelm Rees.....2901 Rauschenbach av.
- Walter, Jacob.....1931 S. Compton av.
 Watts, Millard F4362 Morgan st.
 Weller, Stuart*University of Chicago,
 Chicago, Ill.
 Wheeler, H. A3439 Lucas av.

Whelpley, Henry Milton	2342 Albion pl.
Whitaker, Edwards.....	300 N. 4th st.
Whitten, John Charles*.....	Columbia, Mo.
Widmann, Otto.....	5105 Morgan st.
Wilson, Edward Allen	3745 W. Pine boul.
Winkelmeyer, Christopher.....	3815 West Pine boul.
Wislizenus, Frederick A.....	808 Wainwright bldg.
Witt, Thomas D.....	4374 Laclède av.
Wolff, Herbert W.....	5470 Delmar boul.
Woodward, Calvin Milton.	Washington University.
Wright, Geo. M.....	4457 Westminster pl.
Zahorsky, John	1460 S. Grand av.

PAGES XV — XCIX

CELEBRATION OF THE FIFTIETH ANNIVERSARY OF
THE FIRST MEETING.

VOL. XVI. No. 1

JUL 26 1906

CELEBRATION OF THE FIFTIETH ANNIVERSARY OF THE FIRST MEETING.

1. REPORT OF THE COMMITTEE OF ARRANGEMENTS.

To the Academy of Science of St. Louis: —

Your Committee, entrusted with arrangements for a celebration of the semi-centennial anniversary of the organization of the Academy, respectfully submit the following report, through the Council.

At the Council meeting of December 4, 1905, Professor Nipher called attention to the desirability of celebrating in some manner the fiftieth anniversary of the first meeting of the Academy, which was held on March 10, 1856. After an informal discussion the President was authorized, on motion, to appoint a committee of three to consider the feasibility of providing for a suitable celebration, and to outline its general features if it were considered to be practicable, reporting its findings to the Council. The President named as such committee Doctors Nipher, Sander and Trelease.

This preliminary committee met at the house of Dr. Sander on the evening of December 10, 1905, all of the members being present, and on Dr. Sander's motion organized by the election of Professor Nipher as Chairman and Professor Trelease as Secretary. A report which was then unanimously agreed to and ordered submitted to the Council included the following recommendations: —

1. That the anniversary be celebrated by a subscription banquet on the evening of March 10, 1906.

2. That the learned societies with which the Academy stands in corresponding or exchange relations be invited to participate, their delegates to be entertained as the guests of the Academy or its members while in St. Louis.

3. That, in addition to the customary after-dinner speaking, provision be

made for a general address by some scientific man of high standing and wide reputation, and for a short résumé of the Academy's history.

4. That a framed panel of portraits of the members present at the organization meeting be secured and presented to the Academy.

Statements were also made as to the probable expense of carrying out the proposed plan, and the means of insuring its success, and the further recommendation was made that, if the plan were considered practicable by the Council, it be adopted and authorized and the task of carrying it out placed in the hands of a committee of three, to be named by the President.

The report of the preliminary committee was submitted to the Council at its meeting of December 18, 1905, when it was unanimously approved and ordered submitted to the Academy with recommendation that the plan of the committee be adopted and provision made for carrying it out, — it being understood that the treasury of the Academy should not be drawn on beyond the sum of \$25.00 to meet the expenses of the celebration, all of which the committee believed could be provided for otherwise.

At the Academy meeting of December 18, the recommendation of the Council was unanimously adopted and the President announced his continuance of the preliminary committee as a Committee of Arrangements, with full power to act.

Because of his advanced age, Dr. Sander shortly afterward asked to be relieved from duty on the committee, and Dr. Spiegelhalter was named by the President as its third member. It was soon found that in addition to the details suggested by the preliminary committee, it would be practicable to strike a commemorative medal, in bronze, replicas of which might be presented to all persons present at the dinner, to all contributors to the fund needed for carrying out the plans for the celebration, and to all societies represented by delegates, and the committee decided on this step, selecting the seal of the Academy for the obverse, and a portrait of George Engelmann, its first president, for the reverse. It was also decided that members might secure in-

vitations for personal guests, and that the committee might invite a few prominent citizens as guests of the Academy.

The committee associated with itself the following auxiliary committees: On portraits of founders, Doctors Stevens and Grindon; on entertainment of delegates, Mr. Douglas, Dr. von Schrenk and Mr. Thacher; on medals, Dr. Whelpley. Details were left to the officers of the committee, with the assistance of the auxiliaries named. Progress reports were submitted to the Council and to the Academy at all regular meetings.

As the plans matured it was found that time could hardly be found on the banquet evening for the desired historical sketch of the Academy, and the regular meeting of March 5th was therefore set aside by the President for a series of historical papers by officers and members.

To provide for the cost of the dinner itself, all members were invited to be present, paying for covers. To meet other expenses, as it was not possible under the rules to levy the necessary small per capita assessment, the committee were forced to depend upon voluntary contributions. Experience having shown its members the difficulty of raising money by a generally circulated invitation for contributions, it was thought better to personally invite a small number of members, known to be able to do so, to contribute a uniform amount to the general fund. The committee met with the promptest and most cordial responses to such invitations, and in addition to giving the sum asked for, several members expressed their willingness to see that any possible deficit was made good. This procedure of expediency in raising money was obviously unjust to other members equally able and willing to lend their aid in providing for the anniversary celebration, but whom it was not found possible to reach personally when contributions were solicited, and it is regretted for that reason.

Three persons not connected with the Academy volunteered substantial aid, which was gratefully accepted. The Committee desire to express their thanks, through the Academy,

to all contributors, as well as to the members whose subscription to the dinner made it possible.

The open session of March fifth proved an interesting one. President Alt occupied the chair, and fifty persons were present. In addition to customary business, the programme included the following addresses: —

- A SKETCH OF THE HISTORY OF THE ACADEMY, Dr. H. M. Whelpley.
- A TREASURY STATEMENT FROM THE BEGINNING, Dr. Enno Sander, Treasurer.
- A HISTORY OF THE MUSEUM AND LIBRARY, Dr. G. Hambach, Librarian.
- AN ACCOUNT OF THE ACADEMY'S PUBLICATIONS AND THEIR WORTH, Professor F. E. Nipher.
- AN ACCOUNT OF ITS MEMBERS WHO HAVE ATTAINED EMINENCE EITHER WHILE HERE OR AFTER LEAVING ST. LOUIS, Professor C. M. Woodward.

The attendance at the banquet of March tenth was as follows: —

Guests of the Academy —			
Delegates of Societies (including members).....	17		
Corresponding members.....	1		
Individuals.....	3	21	
<hr style="width: 10%; margin-left: auto; margin-right: 0;"/>			
Subscribers —			
Members (including delegates).....	56		
Guests of members.....	14	70	91
		<hr style="width: 10%; margin-left: auto; margin-right: 0;"/>	<hr style="width: 10%; margin-left: auto; margin-right: 0;"/>

At the banquet, President Alt presided and Past-President Nipher officiated as Toastmaster. The proceedings were as follows: —

- ADDRESS OF WELCOME.....President Alt.
- PRESENTATION OF PORTRAITS.....Past-President Nipher.
- PRESENTATION OF MEDAL.....Past-President Green.
- ACCEPTANCE OF PORTRAITS AND MEDAL.....President Alt.

ADDRESSES —

- Dr. E. A. Birge, University of Wisconsin.
- Dr. T. C. Chamberlin, University of Chicago.

GREETINGS OF SOCIETIES —

- Through delegates present.
- In the form of letters and telegrams.

Your Committee account for the medals struck as follows: —

	Struck.	Distributed.	
The Medal of the Academy.....	1		
To the President of the Academy.....		1	1
		<hr/>	
Replicas.....	159		
To designated delegates, for societies.....		36	
To guests present.....		33	
To members present.....		58	
To contributors not present.....		19	
To subscribers not present.....		5	
Sold, through the Secretary of the Academy....		8	159
		<hr/>	<hr/>
Total.....	160		160

The following financial statement is submitted: —

Resources of the Committee —

Contributions of members,

36 at \$10.00.....	\$360.00	
2 at 5.00.....	10.00	\$370.00
	<hr/>	

From persons not members,

2 at \$25.00.....	\$50.00	
1 at 6.00.....	6.00	56.00
	<hr/>	

Subscriptions to dinner,

76 at \$5.00.....		380.00
-------------------	--	--------

Sale of eight medals.....		7.50	\$813.50
		<hr/>	

Expenses —

Invitations, cards and postage.....	\$43.55	
Stenographer.....	10.00	
Scrap books for letters.....	2.00	\$55.55
	<hr/>	

The dinner.....	319.90	
Menus, flowers and music.....	56.00	375.90
	<hr/>	

Expenses of delegates.....		11.70	
Panel of portraits.....		81.75	
Medal and 159 replicas.....		278.60	803.50
		<hr/>	<hr/>

Balance in hands of Treasurer.....			\$10.00
------------------------------------	--	--	---------

In conclusion your Committee suggest that the small balance be covered into the treasury, and request that the

Treasurer's certification of its financial statement may be considered a part of this report, and that the Committee be discharged.

FRANCIS E. NIPHER,
JOSEPH SPIEGELHALTER,
WILLIAM TRELEASE,
Committee.

The foregoing account of receipts and expenditures agrees with my books, and the sum of \$813.50 therein noted has been received and, except for the stated balance of \$10.00, disbursed through my office on vouchers duly approved by the Chairman of the Committee as authorized by vote of the Council.

ENNO SANDER,
Treasurer.

St. Louis, Mo.,
May 21, 1906.

2. ADDRESSES AT THE MEETING OF MARCH 5, 1906.

A SKETCH OF THE HISTORY OF THE ACADEMY.

HENRY M. WHELPLEY, M.D.

The brief history which it becomes my pleasant duty to prepare must of necessity deal with general considerations, for the important special features of the Academy's half century of life will be covered by those contributors taking part in the following portion of this evening's program: —

- | | |
|---|-----------------------|
| A Treasury Statement from the Beginning with Mention of all Gifts received by the Treasurer. | Dr. Enno Sander. |
| A History of the Museum and Library. | Dr. G. Hambach. |
| An Account of its Publications and their Worth,* | Prof. F. E. Nipher. |
| An Account of its Members who have attained Eminence either while here or after leaving St. Louis.* | Prof. C. M. Woodward. |

My remarks will not include my own personal reminiscences, as the Academy was organized several years before I was born. Thus, what I have to say is compiled from accessible records, and that which lacks experience is but lip wisdom.

* These papers are omitted at the request of the writers.

The Prodrome. The Academy of Science of St. Louis did not come into existence *de novo* but, like many great historic events, its birth followed a long period of necessary preparation during which many well meant efforts brought only disappointment.

The first stone placed in the foundation for an edifice of science in the Mississippi Valley and probably the first west of the Allegheny Mountains was an informal meeting, held in St. Louis late in 1836. This was a gathering of men, of high intellectual attainments, who possessed an energy which placed them far ahead of their local contemporaries. The conference resulted in the organization of the Western Academy of Natural Sciences.

The new society obtained a charter from the General Assembly of Missouri, dated February 6, 1837. The incorporators were: H. King, George Engelmann, B. B. Brown, P. A. Pulte, William Weber, Theodore Engelmann and G. Schuetze. The main promoters of this new society in the far West were Drs. George Engelmann and Adolphus Wislizenus who subsequently became respectively founder and active worker in the more fortunate Academy of Science of St. Louis.

Through the efforts of these men, the lamp of science was trimmed in the City of Mounds at a time when the population of St. Louis and its suburbs was only 14,253, and it was scarce more than a little frontier town. The newly chartered society issued an address "to the friends of knowledge" in St. Louis and solicited funds for its support, new members, and contributions to the proposed library and museum. It was pointed out that those with a helping hand would "never perhaps find a more appropriate occasion." Little did those men surmise that the same "appropriate occasion" would extend down to the year of our Lord 1906. The address further states that St. Louis is peculiarly situated as a fortunate place for work in the natural sciences, being on the eastern edge of "that immense tract of country extending from the western borders of civilization to the Pacific Ocean," a country holding the attention of the entire scientific world

on account of its geological peculiarities, immense mineral resources, strange fauna and abundant flora.

But the success of these pioneers in western science did not equal their anticipations and the society dropped into a condition of somnambulism not unknown to many other organizations of more recent times. The books of the library became mouldy, the museum specimens dusty and the five acre botanical garden, near Eighth street and Chouteau avenue was sold, to be used for other and less scientific purposes. Then followed almost a score of years of informal gatherings of the local scientists who, no doubt, often discussed the slumbering Academy and wondered when they could again enjoy the advantage of personal contact at regular meetings for the exchange of thought and experience.

The Initial Meeting. The time finally ripened and after several preliminary meetings, of which no record was preserved, the organizers of the St. Louis Academy of Science met in the hall of the Board of Public Schools, March 10, 1856. The fifteen persons responding to roll call on that occasion were physicians George Engelmann, Moses L. Linton, Wm. M. McPheeters, Moses M. Pallen, Simon Pollak, Charles A. Pope, Hiram A. Prout, Benj. F. Shumard, Charles W. Stevens, Wm. A. Tingley, John H. Walters, Adolphus Wislizenus; civil engineer James B. Eads; lawyer Nathaniel Holmes and fur trader and traveler Charles P. Chouteau. A committee which had been appointed at a previous meeting reported a constitution and by-laws which were promptly adopted. The following officers were elected to serve for the first year: —

President.....	George Engelmann, M.D.
First Vice-President.....	Hiram A. Prout, M.D.
Second Vice-President.....	Nathaniel Holmes, Esq.
Secretaries.....	{ Benj. F. Shumard, M.D.
	{ Wm. H. Tingley, M.D.
Treasurer.....	James B. Eads, Esq.
Curators; Moses M. Pallen, M.D., Adolphus Wislizenus, M.D., B. F. Shumard, M.D., Chas. W. Stevens, M.D.	
Board of Council; George Engelmann, M.D., H. A. Prout, M.D., Nathaniel Holmes, Benj. F. Shumard, M.D., Wm. Tingley, M.D., Chas. A. Pope, M.D., Chas. P. Chouteau, Esq.	

Such are the full records of the initial meeting held at a time when St. Louis had 122,000 population. It was the beginning of the half century of work which closes with our banquet next Saturday evening. Emerson says that while man's life is divided into periods of seventy years each, the first period is after all the most important one. With our Academy which we expect to live for centuries, this period of fifty years just closing is but a mere point in the progress of time.

Objects of the Academy. The constitution said of the Academy, that "It shall have for its objects the promotion of science." Our predecessors did not intend to shirk any responsibility in this direction, for they enumerated the following subjects and distributed them among fourteen standing committees:—

Anatomy, Comparative; Botany; Chemistry; Embryology; Entomology; Ethnology; Geology; Geology, Chemical; Herpetology; Ichthyology; Malacology; Mammalogy; Mineralogy; Monstrosities; Ornithology; Palaeontology; Physics.

Perhaps the division of "Monstrosities" was expected to include all topics not coming under any of the other heads, but the year following added astronomy and meteorology to the list. It is, however, noteworthy that this rather formidable list avoids subjects theological. In this respect, the founders of the Academy were like Versalius who lived in the Middle Ages when theologians believed that each human body contained an imponderable, incorruptible and incombustible bone which served as the nucleus of the resurrection body. Versalius was an able anatomist but he left the question of the resurrection bone to the theologians.

The broad principles on which the Academy was founded are further expressed in the charter which was granted by the Missouri Legislature, February 9, 1857, only three days short of twenty years after the charter of the Western Academy of Natural Sciences. Our charter provides that in case of dissolution of the Academy, the property shall go to the city of St. Louis for educational purposes. The mem-

bers cannot divide the collections, library and property among themselves.

The Infancy of the Academy. The hard work of the prodrome period of twenty years very naturally cut short the usual period of infancy of such an organization. We find substantial work dating from the second meeting which was held, April 21, 1856, when nine new members were elected. The Academy accepted the generous offer of Dr. Chas. A. Pope of a home in the O'Fallon Dispensary of the St. Louis Medical College. Chas. P. Chouteau gave the Academy his one-fourth interest in the celebrated and valuable Hayden Natural History Collection.

The members began their discussions with objects of magnitude, for the Zeuglodon, a gigantic fossil whale, and the Missouriium (*Mastodon giganteus*) were the subjects of the first debates along lines of science. The Academy authorized the spending of some of its first money to pay the expenses of a trip south by Dr. Albert C. Koch who made the journey to study the then much talked about Zeuglodon fossil remains of Mississippi.

The brotherly love of the Academy of Science of Philadelphia was the first to be extended to the infant organization. The name of the St. Louis Academy was placed on the exchange list of the Philadelphia Academy before the new society had any publications to exchange. This act of recognition has never been forgotten by our officers and members.

The Membership. The organization meeting closed with fifteen charter members. In 1860, just before the Civil War, the total had grown to 150. The highest membership record was in 1903 with 298 names. To-day, the roll contains but 261 names. Death has decimated our ranks of late. Those who joined during the first decade are fast passing away. Dr. Wm. M. McPheeters, who died in St. Louis March 15, 1905, was the last survivor of the fifteen organizers.

The Academy has three living patrons and seventeen honorary members. The recent World's Fair in St. Louis was the occasion of several additions to the roll of honorary members. The librarian, Dr. G. Hambach, is at present the only

life member. Mr. James B. Eads was also a life member. How to further increase the membership is one of the important and perplexing problems of to-day.

The Ladies. In 1856, but few ladies were interested in science and the founders of the Academy made specific mention only of men. The constitution and by-laws provides for the election of "men" as active members, and as corresponding members "eminent men of science and other persons." Possibly, the ladies were included in the "other persons."

A few ladies have since been elected to active membership, but only one name is now on the roll. The informal nature of the meetings prior to 1881 rather forbade ladies attending, but at present many members bring their families when the program is an attractive one for them.

The Officers. The Academy has been fortunate in the selection of its officers. The founder, Dr. George Engelmann, was sixteen times president. Dr. Enno Sander has served as treasurer for forty-four years. Dr. G. Hambach, has been librarian twenty-five years. Dr. Wm. Trelease served as secretary for ten years. Professor Francis E. Nipher was president for seven consecutive terms. Not only have these and other men cheerfully given the organization long terms of service, but also faithful work, which was often rendered under trying conditions.

Physicians Active. It would have been surprising if the Academy had not been safely born with twelve of the fifteen organizers practicing physicians. The first thirteen years were spent in a medical college dispensary. When the list of members reached 104, fifty of them were physicians. Since the election of many laymen who have joined for the purpose of contributing their annual dues and moral support to a worthy cause, the proportion of physicians and other professional men has been reduced, but over twenty per cent of the members to-day are practitioners of medicine. Several have been prominent in medical affairs. Dr. Chas. A. Pope was the founder of the St. Louis Medical College, and many of the teaching staff of that college joined the Academy. Dr. Moses M. Pallen presided at the meeting of November 3,

1864, which organized the St. Louis College of Pharmacy. The Academy museum prior to the fire of 1869 contained much medical material. The Dr. Joseph Nash McDowell Museum of Natural History which was turned over to the Academy when the Missouri Medical College was made the Gratiot street Military Prison in 1862 was one of the finest collections of anatomical material in America.

Medicine touches elbows with all the converging sciences which form the foundation upon which is built our knowledge of things material and immaterial. Among the men of science in every age, we find doctors of medicine who have contributed much to sister sciences. It is not surprising to learn that medical men have been and are now prominent in the history of the St. Louis Academy of Science, but it is remarkable that so few contributions of a medical nature have been made to the volumes of proceedings. The medical men, many of them eminent in their own profession, have taken their medical work to the local and national medical bodies, thus giving the Academy the scientific contributions from their hours of pastime rather than the fruit of their professional work.

The regular fortnightly meetings from the very beginning have been harmonious as well as instructive and interesting. No internal strife of a serious nature has ever occurred. Since the revision of the constitution in 1893, the business has all been transacted by the Council, thus leaving the meetings free for scientific work. Many lectures of a popular nature and papers not intended for publication in the proceedings give variety to the meetings and interest the general public. The average attendance during the past year has been twenty-seven, or about ten per cent of the membership.

The Museum. The Academy was organized by men who had the collecting and historical instinct well developed. They were not, as Shakespeare says, "Snappers up of unconsidered trifles," but students who by industry and judgment were able to build up a large and interesting museum. This collection was wiped out by the unfortunate fire of 1869 and for

years the Academy museum was stored in the officers' minds rather than in the Academy rooms.

Now that we have a home of our own, the museum again demands attention, and at present nothing is too small to be noticed nor too large to be coveted by our curators. The entire animate and inanimate world is called upon to pay tribute to the museum now in process of growth.

The Library. Dr. Johnson said: "There is no part of history so generally useful as that which relates to the progress of the human mind, the gradual improvement of reason, the successive advances of science, the vicissitudes of learning and ignorance, which are the light and darkness of thinking beings." The Academy library is rich in serial publications running back more than half a century. It awaits better acquaintance with the thinking public of this great city. What we now need is a fire-proof structure on the ample ground north of this building, so that contributors to the library and museum will feel assured of their donations being preserved for the use and instruction of future generations.

Donations and Bequests. The notion that professional men should be indifferent to pecuniary affairs is an inheritance from the days of ecclesiastical monopoly of all matters scientific or professional. It is as essential for an organization to have funds as it is for an individual to avoid poverty. The affairs of the Academy have always been in the hands of men of good business judgment, but the process of accumulating a reserve fund has been slow and will continue so until more men and women of wealth and generosity come with their aid.

The endowment fund question was mentioned by the chairman of the first meeting of the Academy, in 1856. Treasurer Sander will detail the results of fifty years of appeal to the fostering hands of friends. Dr. Hambach will record the contributions to the museum and library and detail the vicissitudes in the growth of each one.

The Academy Homes. The Academy was born in the hall of the St. Louis Public School Board, March 10, 1856.

The infant was taken direct to the O'Fallon Dispensary of

the St. Louis Medical College, Seventh and Myrtle streets, where it lived and grew for thirteen years.

After the fire in 1869, the Academy returned to the Public School Board rooms and remained for twelve years.

The third home was in the Washington University, Seventeenth and Washington avenue, where it was housed for twelve years from 1881.

The next move was in 1893 to the Missouri Historical Society Building, 1600 Locust street, where it held its meetings for ten years.

The fifth and present home, at 3817 Olive street, was entered in November, 1903. Here the Academy has enjoyed a home in its own building for three years.

The Academy has thus had five homes during fifty years. The longest period spent at any one place was the thirteen years at the Medical Dispensary.

Critical Periods. If we overlook the usual ravenous appetite of youth, we can say that the first three or four years passed without causing the officers great anxiety about the new child of science, but the Civil War came and St. Louis, as a border city, at once felt the effects of the great national struggle. It was the first critical period for the Academy and was safely passed, through the loyalty of its faithful members.

The second and greater calamity was the fire of May, 1869, which destroyed the much valued museum. This irreparable damage followed closely upon the death of the president, Dr. B. F. Shumard, and struck terror to the strongest hearts. Dr. George Engelmann was elected president and in his address said of the membership: "Some are dead, others have removed from here and few remain to help the work, and this is the greatest difficulty we labor under; scarcely any have come to St. Louis to step into their places and work, no new generation grows up to take the work when the pioneers of the Academy have departed." This was the second critical period and probably the darkest days of the Academy. May similar conditions never return.

In 1893 came a third period of note when the constitution and by-laws were revised. Letter ballot for officers was

adopted. Provision was made for a non-office-holding nominating committee. The Council was given increased responsibilities. It was decided to present only previously announced communications at the meetings. Alternate meetings were set apart for popular science of interest to the laymen. The plan, as adopted in 1893, is the one now followed.

There never has been a time when the Academy was not obliged to husband its resources. Private subscriptions have often been necessary to meet the expense of publication. Notable collections for the museum have been purchased only by individual aid. But the Academy has safely passed through war, famine and fire and is hearty and happy in a home of its own on this, the occasion of its golden jubilee.

The Future of the Academy. Any one can read the records of the past but it requires the gift of a seer to write history before it is made. The future of the St. Louis Academy of Science is a matter of much concern to the many who love it well. When we cast an eye in retrospect we are astonished to find mankind so ignorant of what was immediately in advance of them. If I should make a single prediction, it would be that the Academy will find some way of exercising the portion of the constitution providing for sections of the Academy devoted to special subjects.

We have in St. Louis a number of small scientific bodies of an exclusive nature whose members would enjoy and profit by affiliation with the Academy. I will mention the Biological Society, the Botanical Club, the Naturalists' Club, the Medical Science Club, the Medical History Club and other non-clinical medical organizations. May the day come when they are all members affiliated with the St. Louis Academy of Science family!

Bibliography. "Act of Incorporation, Constitution and By-laws of the Western Academy of Natural Sciences at St. Louis. St. Louis, Mo. Printed by William Weber, 1837," is a sixteen page pamphlet to be found in a few libraries.

"The Academy of Science of St. Louis," is the title of a nineteen page illustrated article by Frederick Starr in Appleton's Popular Science Monthly for March, 1898.

“The Academy of Science of St. Louis, A Biography,” by William Trelease, occupies fourteen pages in the *Popular Science Monthly* for December, 1903.

A TREASURY STATEMENT.

DR. ENNO SANDER, Treasurer.

The honor has been conferred upon me as Treasurer of the Academy to give you this evening a short sketch of the financial tide, which this worthy institution has experienced during the last fifty years. It is no easy task to engineer such an enterprise through breakers and floods; but by the united exertions of its members it has been successfully and securely guided into a safe harbor, where it will now remain as a beneficial ornament to its gratified city.

Capt. Jas. B. Eads was the first Treasurer of the society, elected March 10th, 1856. In January, 1857, he left a balance of \$184.45 to his successor, Dr. S. Pollak, who collected in three years' service over \$3,000.00, but left to his successor, Dr. J. S. B. Alleyne, a balance of only \$61.57. The latter, during his two years' service, collected \$936.00, which he expended except for eighty-five cents, left to his successor, Enno Sander, as a nucleus for a future fortune. Dr. Alleyne served during that year of depression and anxiety, the first year of the Civil War, during which time he collected little over \$100.00, perhaps all that could have been expected. Times were hard and the Academy suffered under the misfortunes of the country as much as everybody else, but the energy of the active members was equal to the emergency. Although their means were scant, they succeeded by voluntary subscriptions in collecting sufficient funds to maintain the publication of the *Transactions* and thus secure uninterrupted intercourse with other scientific societies. It has been asserted that St. Louis was little known to the outside world: not so its scientific workers, who toiled incessantly for deserving the recognition which they had thus far obtained from the scientific societies all over the globe through the exchange

of their Transactions. They did not worry when the President, in his annual message in January, 1864, complained that the debts of the society exceeded \$600.00; but they clubbed together, had a sound balance soon reported in the treasury and published the Transactions to be distributed by the Smithsonian Institution and proclaim St. Louis' scientific energy to the scientists of the world.

It seems that scientific societies can best preserve and also increase their membership and their finances by the careful selection of their presiding officers. Always elect the most popular and one who does not lack in energy. The election of Capt. Jas. B. Eads as President brought many new members to the roll and \$1,000.00 could be paid out for printing the Transactions during his administration. However, this good fortune lasted scarcely ten years, when a considerable deficit occurred again. These constant ups and downs were always met bravely by members and Treasurer, but greatly increased the labors of both of them. Ultimately, in the fall of 1888, Col. Geo. E. Leighton bought the lot on Locust street which had been donated by Jas. H. Lucas in June, 1872. The share of the proceeds of the sale belonging to the Academy was \$4,786.52, the safe possession of which seems to have greatly strengthened the financial confidence of the members of the Academy.

The foregoing narration implicitly displays the spirit of liberality existing among the members of the Academy, which is distinctly exhibited by the voluntary contributions which have sallied forth whenever help was required. It affords me great pleasure to mention the many donations that have graced the books of the Treasurer and are still delighting his eyes. They commenced quite early.

In 1857, Mr. Wm. H. Becher is credited with \$70.00; in 1860, Messrs. G. F. Filey, S. Partridge and W. H. Smith jointly contributed \$300.00. In 1862 Dr. G. Engelmann and Br. A. Hill gave each \$50.00. In 1864 Messrs. Holmes and Harrison gave \$55.00; Dr. Engelmann and Dr. Sander, \$100.00, while a list of members jointly signed \$250.00 as a donation. The next year the Treasurer collected \$141.00

towards the publication of the Transactions, and he cheerfully states that whenever he was compelled to ask for extra support he was always met with great liberality. That the citizens recognized the value of the Academy was shown in 1878, when the Executive Committee for the entertainment of the A. A. A. S. gave to the Academy the balance of \$216.39 which was left over from their expenditures. In 1882 the voluntary subscriptions to the printing fund were \$275.00; and \$100.00 was donated, in 1884, to pay for the picture of Dr. George Engelmann, our most revered member and President, who had died that year.

In June, 1872, Mr. Jas. A. Lucas had given a valuable lot on Locust street jointly to the Academy and the Historical Society for building purposes. Neither society had ever money enough to realize the object of the generous donor nor could sufficient sympathy be aroused among the citizens for subscriptions to a fire proof building. After the death of Mr. Lucas his heirs claimed the return of the property, but the litigation against them was successful and, as mentioned before, the Academy received its share in November, 1888. A year later a handsome bequest of one thousand dollars from the estate of Mr. Henry Shaw was gratefully acknowledged.

Until 1894 the Academy had profited by the generosity of corporations and persons who allowed its members free quarters for the library and the meeting room. Dr. Chas. A. Pope gave shelter until his college burned down; afterwards we were benefitted by the School Board. Then Washington University granted the use of a fine large room, which after a few years it was compelled to request us to relinquish and an arrangement was completed with the Historical Society which rented to us suitable quarters for \$500.00 a year.

The year of 1903, however, accomplished ultimately the desire that had been felt by the members for so many years. Mrs. Wm. McMillan and her son graciously and generously donated to the Academy the splendid site occupied by a large building at 3817 Olive street, now used as our meet-

ing place. President H. W. Eliot completed the gift by the donation of \$5,000.00 which he employed to put the building into a condition suitable for the Academy's purposes. Our library and our valuable collections are at length well housed and exhibited. We also enjoy the gratification of offering comfortable quarters to affiliated societies.

No doubt the Academy will continue to increase in value and benefit to the people in whose midst it is situated, and they will endeavor to improve the space which is ready for occupancy, with solid fire proof buildings for a grand celebration of its centennial anniversary.

A HISTORY OF THE MUSEUM AND LIBRARY.

DR. G. HAMBACH, Librarian.

Time in its ceaseless course has brought us to the close of the fiftieth year of our existence and on this occasion we can look back on our library and museum with pride and pleasure and with hope and confidence in their future prospects. It behooves us on this occasion to review the events which have marked our progress, so that we may see how far we have succeeded in accomplishing the noble objects, which are the basis of our organization — “the advancement of science and the establishment of a museum and library for the illustration and study of its various branches.” Hampered for many years by lack of funds and patronage, we have struggled successfully, until we now have treasured in our museum many valuable specimens in all branches of natural science and in our library the memoirs and transactions of learned societies all over the globe, to be resorted to by the students and lovers of natural science in this great Mississippi Valley.

The first meeting of the members, held March 10, 1856, was taken up by the election of officers and the adoption of a constitution and by-laws.

At the second meeting of the Academy, April 21, 1856, Col. John O'Fallon, through Dr. C. A. Pope, offered to the

Academy the free use of the Cabinet Hall and other rooms suitable for the purposes of the Academy in the Dispensary Building of the St. Louis Medical College (also known as Pope's College). This generous offer was thankfully accepted. In this building, which was located on the northeast corner of Seventh street and Clark avenue, were established the first museum and library of the Academy.

At that same meeting the first donations were received. Dr. Albert C. Koch presented a lithographic plate of the "Missourium" (*Mastodon giganteus*) found by him in Missouri, and which played an important part for some time in archaeological and geological discussions in this country. Mr. Charles P. Chouteau, who had then in his possession a large number of fossils collected by Dr. F. V. Hayden from the Bad Lands of Nebraska, placed this collection in the museum of the Academy. His own interest in the collection, amounting to about one-fourth of the whole, he presented as a donation to the society.

Through the liberality of Mr. Charles P. Chouteau the Academy came in possession of an extensive and beautiful collection of mammalian remains from the Eocene Tertiary, together with many finely preserved fossils from the Cretaceous Formation of Nebraska. This collection, which was the nucleus of the Academy's Museum, was later increased by the purchase of the one-fourth interest of Col. A. J. Vaughan, which gave to the Academy an equal share with the Academy of Natural Sciences of Philadelphia in the splendid collection made by the United States Geological Survey of the Territories from the Bad Lands of Nebraska and other portions of the Upper Missouri Country. Unfortunately almost the entire collection was lost in the great fire which the Academy suffered some years later.

At the same meeting Dr. Koch offered to visit, for the benefit of the Academy, a certain locality in Mississippi, where remains of *Zeuglodon*, a gigantic fossil whale, had been discovered. This was the first investigation carried out at the expense of the new Institution.

At the third meeting of the Academy the first donations

toward a library came, when Dr. B. F. Shumard presented Decade VI of the *Memoirs of the Geological Survey of the United Kingdom of Great Britain* and Dr. Engelmann a number of monographs on various scientific subjects.

The first society to recognize the new organization was the Academy of Natural Sciences of Philadelphia, which donated to the Library a set of its "Proceedings" and the second series of its "Journal."

At a special meeting called by the President, August 4, 1856, the library, belonging to the Western Academy of Natural Sciences, consisting of 120 volumes, the mineralogical and geological collections, cases and apparatus, were donated to the Academy. The Western Academy of Natural Sciences had been organized in 1837 by two men, destined to play important rôles in the future Academy of Science, Dr. George Engelmann and Dr. Adolphus Wislizenus. This was, so far as is known, the first scientific association established west of the Alleghany Mountains.

During the first year of its existence the progress of our Museum had been so encouraging that standing committees were appointed in the following subjects: — Ethnology, Comparative Anatomy, Mammalogy, Ornithology, Herpetology and Ichthyology, Chemical Geology and Malacology, Entomology, Botany, Palaeontology and Geology, Mineralogy, Chemistry, Physics, Embryology and Monstrosities. At the end of the second year Astronomy and Meteorology were added. The fostering of these various branches was an immense undertaking for this young society, but fortunately it had among its members, men, not only deeply interested in science and its progress, but also possessing the necessary qualifications to perform the duties assigned to them.

Prominent among the donors appears, again and again, the name of Mr. Charles P. Chouteau, who was ever mindful of the Academy's needs when on his expeditions into the far West in the interests of the fur trade. On one occasion he requested the Academy "to name some naturalist to accompany him on his expedition to the Upper Missouri free of expense to the society." At another time we find recorded in

the minutes that "numerous mounted and preserved specimens of mammals, birds, reptiles and fishes, collected on the Upper Missouri river by the taxidermist sent by the Academy to accompany Mr. Charles P. Chouteau on the annual trip of the American Fur Co.'s boats, were received and deposited in the Museum." Of the many and priceless gifts of Mr. Chouteau only a section of the Fort Pierre meteorite now remains.

Dr. Charles A. Pope, who donated many valuable specimens representative of morphology and comparative anatomy; Dr. Theodore C. Hilgard, the donor of a beautiful series of fish skeletons, a large collection of lichens mounted and of many papier maché models of fungi, colored true to nature; Dr. Chas. W. Stevens, from whom many fine mammal skeletons were received, especially a fine specimen of *Bos cavifrons*, which I am happy to say is still in our possession; Dr. Hiram A. Prout, for whom the gigantic *Titanotherium Prouti* of the Bad Lands of Nebraska will stand as a lasting monument in the world of science; Dr. Adolphus Wislizenus, whose work during his tour to Mexico was publicly acknowledged by Humboldt as of value to him in his studies in that region; Dr. Benjamin F. Shumard, Dr. George Engelmann, Prof. George C. Swallow, Prof. G. C. Broadhead, Mr. Edwin Harrison, and Mr. Nathaniel Holmes will ever be remembered as the principal donors to the Museum and Library in the early days of the Academy.

After five years of prosperous existence came the gloomy days of the War, disturbing the political, social and financial conditions of the whole country. But even these days of strife added to the Academy's museum. The Western Sanitary Commission deposited with the Academy what remained of the Natural History Collection of McDowell College, which had been turned into a war prison—Gratiot Street Prison.

At the close of the war the Academy regained some of its accustomed activity and, in the fall of 1868, a committee was appointed to secure rooms in the Polytechnic Building, as the Museum and Library had far outgrown the quarters in the College Building. While negotiations were still pending, fire

broke out in May, 1869, destroying almost the entire Museum. Fortunately the Library was saved. The loss of its Museum was irreparable and no efforts to re-establish it were made until a few years ago.

During the years that the Academy was tenanted in the Public School Library Building, the Washington University and the Missouri Historical Society, what was left of the Museum and such small accessions as were acquired from time to time were stored in cellars and consequently of no use to the members or to the public.

However, during the bright days of the Archaeological Section in 1876 and 1877, excavations were made by the Academy in the mounds of southeastern Missouri, in northern Arkansas and in Illinois, the partial results of which were published in a quarto memoir. The pottery and the crania obtained then are among the treasures of our present museum.

While no serious efforts were made during some thirty years to re-establish the Museum, the energies of the Academy during that time were devoted to the formation of a library by the liberal exchange of publications. In this way we have come into the possession of many valuable series issued by kindred societies from all over the world. To-day we exchange publications with 420 foreign and 160 home societies.

While we undoubtedly have as valuable a series of the current scientific literature as published by societies of kindred aims, our files are devoid of the works and publications devoted exclusively to certain branches of science, as, for instance, "Zeitschrift für wissenschaftliche Zoologie," "Morphologisches Jahrbuch," "Annals and Magazine of Natural History," "Transactions and Proceedings of the Zoological Society," "Palaeontographica," "Quarterly Journal and Transactions of the Geological Society" and "Poggendorf's Annalen der Physik und Chemie," but which are considered indispensable as references to keep in touch with the progress made in those branches. These are not obtainable by exchange but only by purchase and, since the funds of the Academy have been very limited, no appropriation could be made to supply this necessary addition to the Library. How-

ever, we sincerely hope to overcome this obstacle, as we have others, with the kind and liberal assistance of our worthy members.

In 1900 the Academy purchased the Yandell Collection, consisting of about ten thousand palaeontological specimens, containing many of Yandell's own type specimens and of those described by Shumard, whose collection is now in the possession of Washington University. This collection is especially rich in crinoids of the Devonian Age and many rare types contained in it are described in the first volume of the Transactions. The purchase of this collection by the Academy placed in St. Louis two of the best fossil collections in existence to which students may well refer in their scientific researches for typical specimens characteristic of this section of the country.

In 1901, through the efforts of Mrs. Wm. L. Bouton, the Academy acquired a collection of 635 butterflies, mostly tropical, beautifully mounted on Denton tablets.

When the Academy moved into its own home two years ago — the magnificent gift of Mrs. William McMillan and her son, Mr. William N. McMillan — new efforts were made to again establish a museum of natural history worthy of the name. The entire third floor of the spacious home has been devoted to this purpose, and beside the Yandell and butterfly collections, we now have on exhibition a fine collection of mound builder pottery and some forty human skulls from the mounds near New Madrid, Missouri; many minerals from all parts of the United States; a small collection of fossil leaves; quite a large number of small shells; many specimens of the different kinds of wood of our country; a collection of twenty-five meteorites, among which is a section of the Fort Pierre Meteorite, which originally weighed thirty-five pounds and is the gift of Mr. Charles P. Chouteau; and a remnant of the first museum — some fine fossiliferous slabs, mostly from St. Louis limestone and of great value; some of the fossils of the Hayden Survey, containing the type of *Titanotherium Prouti*; a good specimen of *Bos cavifrons* (a species of fossil ox); a burnt brick from the ruins of Nineveh, described in Volume I.

of the Transactions, and a large rock from Perry County, Missouri, with the human foot-prints chiseled out by the Indians, presented by Dr. Koch.

While the acquisitions made in recent years have been most gratifying, we have, however, at present only a nucleus to the museum we hope to establish at the Academy. It is our intention to procure collections of the various branches of natural science, especially those represented in our own State, which we hope will be a lasting benefit to the public and to the educational institutions of the city.

3. PROCEEDINGS AT THE DINNER OF MARCH 10, 1906.

WELCOME OF THE PRESIDENT.

Dinner having been served, the President of the Academy, Dr. Adolf Alt, greeted its guests as follows: —

DR. ALT: —

Honored and esteemed Guests and Delegates from corresponding Sister Societies. — It is my privilege, and one fraught with great pleasure, to warmly welcome you to this festive board in the name of the St. Louis Academy of Science and to thank you for having accepted our invitation so cheerfully and in such large numbers. We heartily thank your home societies and you personally for the friendly interest thus shown in this birthday celebration of our own organization.

Ladies and Gentlemen. — We have come together this evening to celebrate the 50th anniversary of the founding of the St. Louis Academy of Science. Only when we think back to what the West, what St. Louis, was 50 years ago, are we able to approximately appreciate what kind of men they must have been and of what metal they must have been made, who 50 years ago conceived the idea of founding here in St. Louis an Academy of Science and who succeeded in keeping it alive and giving it the proud position which it has ever

held, thanks to them, among its older and younger sisters. Unfortunately not one of them has been spared to be here and rejoice with us to-night, although we are fortunate enough to still count among our ranks some gentlemen who have been members of the Academy *almost* as long as it has been in existence.

We, being familiar with its history, know what struggles and crises, what — if I may say so — children's diseases the Academy had to go through. Cognizant of these facts and yet seeing that the Academy has reached 50 years of existence, we cannot but feel proud of the undaunted spirit and the constancy of purpose with which these men and their successors have battled for the high aims of this Academy and held up the standard in spite of adversity.

The aims of an Academy of Science are such, that the average citizen is very far from appreciating them at their worth, yet we are fortunate in having a goodly number of members who, though not themselves engaged in scientific work, show sufficient interest in it to be willing to share the small burdens this membership imposes, for the sake of the good that is to come out of it. Would that there were more of their kind! Those, however, who are with us know that the workers in this Academy seek no material gain, but are each and every one imbued with the sole desire to apply their intellectual forces, each one in his special sphere of work, to help to increase knowledge, which is truth. Our only reward lies in the satisfaction of the work itself and we may well point to our 15 volumes of published Transactions, with a feeling of satisfaction and the consciousness that the Academy of Science of St. Louis has, through its working members, from its start gained and held an honored place in the scientific world.

It is almost a custom to compare the life of an organization like ours with the life of man. I refrain from doing so and only wish to make this one point: When a couple have been married for 50 years, we call the fiftieth anniversary of their wedding the golden one. In like manner the daily press have referred to this our fiftieth birthday as our *golden* jubilee.

Yet, this seems to be a poor comparison. Fifty years in a human life mean much, fifty years in wedded life mean nearing the end, but 50 years of life of an organization like ours — though certainly respectable — mean after all, I hope, but a youthful age.

In this sense I ask you all to lift your glasses and drink with me to the

Vivat floreat et crescat Academia Scientiæ civitatis Sancti Ludovici!

I now have the pleasure of introducing to you the toastmaster of the evening, Professor Francis E. Nipher.

ADDRESS OF THE TOASTMASTER.

PROFESSOR NIPHER:—

It is now fifty years since a little company of gentlemen met in the rooms of the Board of Public Schools of St. Louis and organized The Academy of Science of St. Louis. I think their names should be spoken here to-night. I read them from the minutes of that meeting as they appear in Vol. I of the Transactions.

GEORGE ENGELMANN, M.D.
HIRAM A. PROUT, M.D.
MOSES M. PALLEN, M.D.
BENJ. F. SHUMARD, M.D.
CHAS. A. POPE, M.D.
WM. H. TINGLEY, M.D.
JAMES B. EADS.

WM. M. MCPHEETERS, M.D.
SIMON POLLAK, M.D.
CHAS. W. STEVENS, M.D.
ADOLPH. WISLIZENUS, M.D.
NATHANIEL HOLMES.
M. L. LINTON, M.D.
J. H. WALTERS, M.D.

CHAS. P. CHOUTEAU.

They adopted a Constitution and By-Laws, and elected officers for the ensuing year, George Engelmann having been elected President.

We have only the memories of these men with us here to-night. They have all finished their labors, and have left to us the grateful task of carrying on the work which they so worthily began.

On February 9, 1857, the Academy adopted the Charter of

Incorporation previously granted by the Legislature of Missouri. The object of the Academy as therein stated is "the advancement of science, and the establishment in said city of a Museum and Library for the illustration and study of its various branches."

Section 3 of the charter is of sufficient interest to claim our attention for a moment. It provides that "all property owned or held by this corporation shall be exempt from taxation so long as the same shall continue to be held and used in good faith for the objects and purposes aforesaid; but whenever any real estate of the corporation shall be leased to any other person or persons, the leasehold interest therein shall be taxable to the lessee or lessees thereof, as in other cases."

It is evident that these gentlemen intended to lay a broad foundation. The constitution which they adopted at the first meeting provides that the following subjects should be embraced in its field of work: Zoology, Botany, Geology, Mineralogy, Palaeontology, Ethnology (especially that of the aboriginal tribes of North America), Chemistry, Physics, Mathematics, Meteorology, and Comparative Anatomy and Physiology. The field of work here laid out was broad enough to justify the name which they adopted.

At present the oldest member of the Academy is Dr. Enno Sander. He is still a young man [applause]. I don't like to ask him to tell just how old he is, but I think he is over eighty. He was elected a member during the first year of the existence of the Academy, only a few months after the organization. I have always been sorry Dr. Sander was not one of the original incorporators. In 1861, Dr. Sander was made Recording Secretary of the Academy, and the following year, '62, he became Treasurer, which position he has continuously held until this day.

The first list of members published contained eighty-seven names; that was in Volume II of the Transactions, and of those names, we still have five upon our rolls. Nearly all of those men are dead. The five who are still with us are, Dr. G. Baumgarten, Dr. John Green, Dr. Enno Sander, Dr. Wm.

Taussig, and Edward Mallinckrodt. With the exception of Dr. Baumgarten, those gentlemen are all here to-night.

In 1861, Dr. Prout, who was then President, in his annual address made a very strong appeal to the members, and particularly to the younger members, and to those who were not members of the Academy. He tried to influence them to go into something definite, and become masters of it; to become producers, in order that they might take the places of the older men who had thus far done all of the scientific work of the Academy. About that time, or a little later, there was a great deal of talk of that kind, and it seems to have had the desired effect. Here in this city, certainly, that has come about. In all places in this country, that has been steadily coming about. The result is a little different, I think, from what had been anticipated. One might have hoped that those who did become specialists, who did study carefully and closely, some particular subject until they became masters of it, would still retain their interest for other things, but it turned out to be a little different from that. This seems to be our experience. Those who are interested in special lines of work sometimes lose their interest in other things. I think we all feel in that way more or less, but it does seem to be somewhat pitiful that those of us who have looked into our microscopes at something intricate and interesting, should be so intent upon those things that we forget the starry heavens above, and the entire world around. It does seem that we ought to try to do something to broaden our ways of thinking on scientific things. I do think still that we should endeavor to specialize — that one should learn something and pursue it, but why not still maintain our interest in other things as well? I believe that part of the trouble comes from the fact that when papers are offered for publication, they are frequently read in great technical detail. If we could reform our local Academies of Science in such a way that those papers could be presented only in abstract, giving those things vital and essential, leaving details for the published paper, and endeavor to make that presentation as interesting as possible, we should accomplish vastly more. If we, in our Academy of

Science, could have several papers on each evening, giving the results obtained in botany, geology, or what not, presented in such a way as to interest not only our own members but others, then we could accomplish something.

Now I know very well that it is urged that the discussion which follows papers of that sort is valuable, but my observation is to this effect: that the discussion which follows a paper, particularly if very technical, is always about something else, and might just as well be omitted. If that discussion could follow a week later, after having considered the paper, and better still, if it could be made in writing in public, after the paper which was being discussed had been published, then the results would be much more valuable. Impromptu discussions are as likely to be valuable if a paper is presented in abstract as when it is read in minute detail. It is very much better for one who wishes to publish anything to get it all ready, study it carefully, think of it closely, and then file it away for three or four years; then study it again, and then probably the paper will be worth publishing.

Now I have said something about the duty of those who produce these papers. I think there is also another duty which those who are to hear owe to those who produce the papers. When one is reading a paper in detail, and boring everybody, I think our devotion to science ought to be sufficiently great to cause us to listen to the end. In some societies I have attended, where papers of that kind were read, it was evident that not a single person present was really following the reader. I have taken pains to ask them about it. The answer was, "Why I couldn't understand it; wait until it comes out in print." Now, why couldn't such a paper be presented in an attractive way, and then let those who wish read it in print? But suppose a man hasn't that much sense, then I think we ought to take our punishment, and go to the meeting. There is a great inspiration in numbers. There are very few people who like to speak to an audience consisting of the President, the Secretary and one or two other persons. One can sometimes say to a crowd what he couldn't say to empty benches.

PRESENTATION OF PORTRAIT.

THE TOASTMASTER: —

These gentlemen who organized the Academy, certainly worked with very great enthusiasm and self-denial. I have been much interested in reading the proceedings of those early meetings, and I find that they were full of zeal in carrying out the project which they had started, and which we celebrate to-night. We have made an effort, — the committee having this in charge — to secure photographs of all members who attended the first meeting and, with two exceptions, we have succeeded. It is my pleasure, Mr. President, in behalf of friends of the Academy to present to you for the Academy the photographs of these gentlemen who formed the meeting which we celebrate to-night.

PRESENTATION OF MEDAL.

THE TOASTMASTER: —

There is another presentation which friends of the Academy also wish to make this evening, and I will call upon Dr. John Green to make that presentation.

DR. GREEN: —

Members and Guests of The Academy of Science of St. Louis — Ladies and Gentlemen: — The Council of The St. Louis Academy of Science has ordered the striking of a medal in commemoration of the completion of its fiftieth year. The obverse of the medal is a replica of the corporate seal of the Academy, bearing the legend in Latin, “To human knowledge and power,” and a design in low relief, symbolical of different branches of natural science, of instrumental aids to observation, of the orderly collation of observed facts, and of the fundamental principles upon which scientific reasoning is based. The reverse of the medal reproduces the features of the distinguished founder of the Academy, its first President, many times re-elected, the man of whom it may be said, almost without exaggeration, that he was the Academy — Dr. George Engelmann.

It was my privilege to meet Dr. Engelmann about the date of the organization of the Academy, in the working-room of Professor Asa Gray at the Botanical Garden of Harvard University. He had come to Cambridge to collaborate with Dr. Gray upon certain genera of North American plants which he had made peculiarly his own. The picture of a rugged, withal kindly, middle-aged man, working with quick and sure insight through great piles of herbarium specimens, pausing now and again to discuss with his friend some character of a species with which the student at the little table by the window was occupied, is to-day as vivid in memory as it was in his actual presence fifty years ago.

Ten years later the impression was revived. The erstwhile tyro in botany came to St. Louis to take up the practice of medicine in this city. Through the kindness of Professor Gray, he was enabled to enter on new relations with Dr. Engelmann, then as for years past and to come, a busy practicing physician holding a foremost place in the ranks of the profession in St. Louis. But the able and busy physician was still the devoted and indefatigable botanist, utilizing the briefest intervals of release from professional duties in the prosecution of the special work in hand, accumulating a noble herbarium of original types, filling volumes with his personal notes and drawings, and, from time to time, publishing the comprehensive and perfectly elaborated contributions to knowledge which won for him the recognition of leading scientists of the world as a co-worker in their own class.

Dr. Engelmann's scientific activities were not confined to botany. A pioneer in an as yet undeveloped region, he realized the importance of studying climatic conditions. For more than thirty years he observed, recorded and tabulated the daily rain-fall, and barometric, thermometric and hygrometric readings — anticipating, by a full third of a century, the local observations of the U. S. Weather Bureau, and making it possible for the investigator of to-day to utilize continuous, authentic records supplementing those accumulated through existing agencies.

Dr. Engelmann was firmly grounded in natural science out-

side the boundaries of his special department. Conscious of his power, the outgrowth of broad and accurate knowledge supplemented by great achievement, he was without a suspicion of conceit. He dominated the meetings of the Academy as its acknowledged head and leader. A shallow pretender to knowledge withered under his plain and direct statement of fact; the modest seeker after truth was made stronger by his sympathetic appreciation and encouragement.

In the late 60's the meetings of the Academy were held, through the courtesy of Dr. Chas. A. Pope, in one of the buildings of the St. Louis Medical College, on the northeast corner of Seventh and Myrtle streets (the latter now known as Clark avenue). Engelmann, Shumard, Wislizenus, Dr. Enno Sander — then as now Treasurer, the Recording Secretary, Judge Nathaniel Holmes — Corresponding Secretary, Dr. G. Baumgarten — Librarian, and a half dozen others, more or less appreciative votaries of science, made up the regular attendance. Hardly ever were there more than ten or twelve persons present, and those generally the same. The larger body of members, who were not in the habit of attending the meetings, contributed the money needed to defray the cost of the publication of the Transactions.

At an early date, the Academy had collected a notable museum, later destroyed by fire, which was displayed in an upper hall in the building of the Medical College. Its library, already valuable, and consisting largely of publications of learned Societies received in exchange for its own Transactions, was shelved in a room adjoining that in which the meetings were held.

The growth of the Academy in later years has been essentially along the lines so wisely defined by its founders. Its library has been steadily and enormously increased through its affiliations with other scientific bodies in this country and in Europe; its treasures are housed, and its meetings are held, in its own building, provided by private munificence. Its Transactions have appeared in unbroken series, and have been kept up to a high and worthy standard.

Mr. President — Colleague and Friend: — It is my privilege

and my great pleasure to present to you, in the name of the contributors to its cost, the bronze medal which has been struck as a memorial of this semi-centennial celebration of the founding of the Academy.

ACCEPTANCE OF PORTRAITS AND MEDAL.

PRESIDENT ALT: —

Ladies and Gentlemen: — In behalf of the Academy, I accept these gifts which friends of the Academy have been in their liberality so kind as to donate to us, and I think I can assure you that the members of the Academy will highly prize and treasure them.

ADDRESS OF DR. BIRGE.

THE TOASTMASTER: —

When I said that we ought not to specialize in such a way as to cause us to lose our interest in other things, of course I wished it to be distinctly understood that I have nothing whatever to say against most intense specialization. The only point I wished to make is this: that if one does feel called upon to devote his life and to organize a Society or Club for the study of the abdominal parasites of the white ant, he certainly ought still to remember that there are black ants.

We have with us this evening a gentleman representing the Natural History Survey of Wisconsin, who has kindly consented to address us concerning advance in his science, Dean E. A. Birge, of the University of Wisconsin.

DR. BIRGE:—

Mr. President, Members and Guests of the St. Louis Academy of Science: — I deem it a great honor as well as a great pleasure to be present this evening and to take part in the Jubilee Anniversary of the founding of this Academy. I congratulate the Academy on the great service which it has rendered to science throughout the fifty years whose close we celebrate. During the early decades of its life it was almost the only scientific body in the Mississippi valley. Its

example inspired the founding of other scientific associations, with similar purpose, but none of these has had a record more brilliant than this, their older sister. I congratulate the Academy also on the assured prospect of an enlarged work and a greater usefulness in the future. The scientific world of a half century hence will have even greater reason than has that of to-day to commemorate the story of its past and to admire its perennial vigor and youth.

I congratulate the audience also on the fact that I am not going to talk on the subject — The Progress of Science since 1856 — which was suggested to me and which I have let stand in default of a better title for my remarks. The progress of science in the last half century cannot be treated in a fifteen minute speech, even though the time allowance is very liberally construed. It would take rather a book as large as this precious first volume of your Transactions which your Secretary has brought with him. I shall not, therefore, attempt to develop my subject, but shall touch only two thoughts suggested by the condition of science in 1856 and 1906.

The founders of your Academy, like all true scientists, were men of vision, else they would hardly have had faith to select that motto which your seal has always borne :

“ Humanae scientiae et potentiae.”

In 1856 it took some faith to see that science embodied human knowledge and power. That was in the pre-Darwinian age — a period as remote from our own, both on the material and on the spiritual side of civilization, as was Shakespeare's day remote from that time. Half a century ago Wallace was in the Malay archipelago and had not yet thought of the survival of the fittest. Darwin had just published his treatise on barnacles, and, unknown to the world, was seriously at work on that other book whose abstract, published in 1859, started the great revolution in human thought and life whose beginning none foresaw when your Academy was founded, but which has rightly given to the second half of the nineteenth century the name of the Age of Darwin. These revolutionary changes have concerned both

thought and life and in both directions they have resulted from the influence of science.

Let me first say a word on the way in which science has come to sum up human power. Careless observers call this a materialistic age and not wholly without reason, for beyond all ages in the past it depends for its civilization upon material aids. One of the great facts in the world's history during the past half century is that applied science has come to control our daily life—that the engineer has come to his own. I need not speak on the material changes which this revolution has caused. I should think it very foolish were I to attempt to tell you of these facts here in St. Louis, where the assembled products of human effort have just been placed before your eyes and minds. Let me speak of them only as examples of human power. These changes in our environment have not come about as the result of an ignoble love of ease, or of an equally ignoble desire for gain. They have arisen, in part, out of that desire for the mastery of the earth which has been one of the great possessions of the human race from the beginning. That spirit of conquest which inspired all of the pioneers of the world; which has been a peculiar possession of our own race; which led your fathers to found St. Louis; has in these last days, when the earth as a planet has been conquered, greatly inspired men to become masters of the earth in a new sense. It leads them to employ that knowledge which science has brought them, so that they may control and better the conditions of life; to seek new possessions for mankind in the untrodden paths of knowledge instead of the unknown world of forest or prairie.

In still another way this applied science stands for power. It displays before our eyes and makes real in our lives the inner force of man's constructive imagination. We do very ill if the triumphs of engineering skill, among which we live and move, display to us only a desire to add to our comfort. We do still worse if, with those who look on the world in the temper of Carlyle, we feel that they are but the means for fools to move about a little more rapidly, to communicate

their folly to each other a little more easily. Far different is the truth for which these works stand. They represent in concrete form the great triumphs of the human imagination. Man, the artifex — the originator — has been with us ever since Prometheus brought down the fire from heaven, but in no age have the heavenly mysteries been more fully or more freely revealed than they have been in ours. When the English language had come to youthful maturity in the days of Elizabeth, the great dramatists and other great writers used it for the purpose of expressing human thought as it was never used before or since, and to-day in the world about us the masters of engineering skill are using the knowledge accumulated by science in the same easy, powerful, and masterful way, to express the imaginations of their own inner souls. Man has entered into the world as a creative power as he never has done in days past. In these creative works he feels something of the joy of the creator. You remember the words of Kipling in McAndrew's hymn:

“ O' that world-liftin' joy no after-fall could vex,
Ye've left a glimmer still to cheer the Man, the Artifex!”

It is the longing for this eternal joy, the desire for the sense of mastery over the great forces of nature, which applied science has fulfilled for man to-day in a measure unknown to any earlier generation.

Consider such a structure as your Eads bridge, built by one of the founders of your Academy, the first great bridge which spanned the Mississippi River. It is a wonderful production of human skill, of the human hand, but a far more wonderful production of the human mind, for in the mind of the engineer the bridge stood complete before it was built. Every beam, every chord, every rivet of the bridge was present to his thought in an “interdependence absolute, foreseen, ordained, decreed;” each in its place and each exactly proportioned to its strain. In a thousand other works the same creative force is seen and these works — these supreme achievements of the human mind — can look up to man as their creator and give to him that highest praise — “Thine

eyes did see my substance yet being unperfect, and in thy book all my members were written, what days they should be fashioned, when as yet there were none of them." Thus in the half century that has passed since the founding of your Academy the engineer has come to his own. Through him science has become a leader in the advancement of human society, the dominating force in civilization, and her works in the world of to-day are the highest expression of human power.

But the other part of your motto is that of which I would speak with more affection, if not with greater emphasis. Your infant Academy was dedicated, first to human knowledge, and then to human power. Not all men could recognize in the science of fifty years ago that supreme position in human thought which the half century has assigned to it. There were then few men whose work was wholly devoted to science, and their work was not held in the highest esteem by all of the community. Science was hardly a vocation; hardly the business of a man's life. It was something interesting; something for men to play with; something to which the teacher might give his leisure hours in the laboratory; something to which the busy physician, like Dr. Engelmann, could turn in moments snatched from his profession. But, on the whole, the world of the '50's felt that the study of science was quite apart from man's real life. It lay outside of the serious business of the world. To-day the world sees in the achievements of applied science at once the indispensable conditions of our complex civilization and the highest expression of human power. In like manner, though less clearly, it is beginning to see in the results of pure science, of research, the highest expression of human knowledge and the necessary conditions of human progress.

Men devoted to research, in some sense of the term, have been with mankind from the beginning. Their work is on one side an expression of one of the most ancient and fundamental impulses of the race.

" For to admire and for to see
For to behold this world so wide"—

That motive has always influenced men, and fortunately will do so to the end of time. The scientist of the middle ages and of the Renaissance felt, like the Athenian of old, the desire to see and to hear some new thing, and to-day the same desire is with us. We, too, respond to the call of the unknown; that great world of potential knowledge which still "lieth in darkness" has an irresistible attraction for us. But our work as scientists has a deeper significance to the world than this gratification of our desire toward the unknown. Science is no longer a mere matter of curiosity. It is a matter of necessity, and the work of the scientist is a part of the warp and woof of the fabric of civilization. It is peculiarly the function of an Academy like yours to make this truth evident to the community which it serves.

There are only two points to which I would refer in this connection: First, the assurance of the future success and the progress of civilization lies in the progress of science, of human knowledge. The complex adjustments of society to-day come out of the knowledge which the past has accumulated. The engineer is to-day applying the knowledge which pure science has furnished to him. He is developing and exploiting the regions which other explorers have discovered. He is utilizing for the profit, for the advancement of mankind, the results of research in the study and the laboratory. But what is to be the history of the future? Shall the knowledge of to-day be worked out, and the skill of the engineer degenerate into rule of thumb? Or are the scientists of to-day engaged in fruitful research whose results the engineer of tomorrow will employ? Nothing is more certain than that the present must ever be accumulating the knowledge out of which is to come the power of the future. History teaches nothing more clearly than that the great additions to human power have come out of scientific discoveries, which at first seemed far from any chance of influencing human life, and that out of similar knowledge of to-day must come the conditions of life in the future. Science gives us a brilliant example of a series of discoveries that has just now

reached a stage where it begins to reveal to us a glimpse — just a glimpse — of enormous possibilities of future power. A few years ago the study of Lenard rays and Roentgen rays might well have been regarded by the unscientific as only a pastime for the leisure of the philosopher. But to-day, as discovery has advanced, there are disclosed to us in the transformation of radium sources of almost limitless energy in the universe. We cannot avoid the thought that there is at least a remote possibility that in the intra-atomic energy thus disclosed the applied science of the future may secure sources of power incomparably greater than those now at our command; sources of power which, if set at work, would revolutionize our civilization, both on its material and social sides. This is only one item in that capital fund of knowledge which research is accumulating, to be drawn upon by the applied science of the future. This item may not finally prove a valuable asset, but no one who knows the past can doubt that if not here, then elsewhere in the stores of science is the knowledge which will revolutionize the conditions of life for future generations.

In human knowledge then, in science, lies the only assurance of human power for generations still to come. The intellectual temper of a people, therefore — that temper which determines their attitude toward research — becomes a factor of prime importance in their permanent prosperity and happiness; and this is the other phase of the intellectual relations of science of which I would speak. What will men do for science as the world grows older? The reply to this question determines, so far as intellectual matters go, the possibilities of future success. Will men with keen enthusiasm, with undiminished power and interest, press forward to secure the knowledge of the unknown world beyond them? Or will they rest within the boundaries of the knowledge they have attained, satisfied with spending the forces which they already possess? Will men be so absorbed in their gains, in enjoying the possession of the present, as to neglect the conditions of life in the future? Will they cease to amass the knowledge which the practical man of the future is to develop? Will

they exhaust their intellectual possessions as they have exhausted their forests, their mines, and their soils? Or will they make it part of the serious business of life to increase the intellectual resources of the state? Will they learn that this task is so great that it cannot be accomplished by the devoted lives of a few individuals, but that many thousands must give their best powers to the work; that the continued safety of the republic demands the enlistment for this service of a great army of men dedicated to the pursuit of truth, inspired in their toils by a high sense of duty and of public service, and sustained by the sympathy and appreciation of the commonwealth?

In determining the right answer to these questions the influence of an academy like this is all important; gathering together all those in the community who are interested in the development of human knowledge and power, and uniting their efforts, not for the display of knowledge, of the discoveries which they may make, but for the accumulation of that knowledge which may be of interest only to-day, but some of which will certainly be of supreme necessity to-morrow. And beyond and far above this duty is the higher function of fostering and strengthening the scientific temper and the scientific spirit in whose widely diffused and vigorous presence in the community lie the hopes of the future.

If an academy is to take its part in this great work well and truly, it must attempt the task, as your Academy has done, in a spirit even wider than that indicated by the words just spoken. For if science had given to man a new knowledge only, it would have fallen far short of reaching its commanding position in the worlds of thought and of life. With that new knowledge it has given him a new learning; it has enlarged the charter of liberal education — the learning which belongs to a freeman — adding to that learning which makes a man free of human society that which confers on him the freedom of the world. It has given to man a new temper in which to seek and to find the truth; has enlarged and elevated his conceptions of truth, and in so doing has given him new and higher standards of morals. It has given him a new

revelation of the universe in which he lives and of the nature and the methods of God's government. This enrichment of the human spirit, from sources unknown through countless centuries of human life, has been present in some degree and in some men ever since the Renaissance. But it has been extended to the whole race of men and known to the world as the gift of science for a short time only, hardly longer than the half century whose close we commemorate to-night. The real significance of that half century to human life is in this transformation of its inner temper by the spirit of science; and in your part in that transformation lies the real value of your work as an Academy.

A few years ago one of the European academies celebrated its entrance upon a new century. The inscription on its commemorative medal presents the thought with which I would close.

“Humanitatis florem alteri tradens aetati.”

These are the words which I would leave with you as you turn from this jubilee anniversary to enter upon the tasks brought by a new half century. Your high privilege, as well as your duty, is to cultivate and to pass on from generation to generation that flower of the human spirit, in which its knowledge and power alike find best expression; that latest, that best gift of God to man — science.

THE TOASTMASTER: —

On account of, perhaps, some little nervousness, due to the fact that my experience in the performance of such duties is somewhat limited, I passed over the subject of gifts — presentations to the Academy, without allowing of other opportunities. The Academy of Science of Davenport has recently received by will of one of its members, a sum of money amounting to something like seven hundred thousand dollars. The income from part of it is to be used during the life of some of the relatives of the donor, for their purposes, but on their death, the entire sum is to be given to the Academy of Sciences of Davenport, which becomes, therefore, the most

wealthy institution of its kind in the world. I had thought of saying that if any one felt the spirit to move him to announce such a gift here, he may feel free to do so. This indeed might be done at any time, without being considered a breach of the peace.

ADDRESSES OF DELEGATES.

THE TOASTMASTER: —

We have with us this evening the President of another Academy of Science, the Academy of Science of Chicago. Professor T. C. Chamberlin will represent that Academy in an address. In view of the experience I have already had, it is rash to predict what he will say. I did think I knew, but I will let him tell what the subject is.

DR. CHAMBERLIN: —

Members and Friends of the Academy of St. Louis: — It is a very great pleasure to me, Mr. Chairman, to bring to you the warm congratulations of the sister Academy by the lake. That Academy came very near to being a twin sister of your Academy. It was born only about ten months later. I believe the Academy of St. Louis is the senior institution of its class in the interior of this country, and so I suppose it is safe for us to claim that the Academy of Chicago is second on the list. It is a good deal for a Chicago man to admit that we are second in anything, but as a scientific man I am compelled to bow to the facts.

The Academy of Chicago remembers with peculiar pleasure and gratitude the sympathy and assistance of this Academy after our great fire. You not only furnished us a new set of the proceedings of this Academy, but generously resupplied us with valuable material which had been lost, and rendered such additional aid as was in your power.

The history of these two institutions represents typically the successive phases through which the Academies of the interior have been passing, and their present conditions and lines of effort perhaps foreshadow the history of these and like Academies in the immediate future. As your Chairman

has suggested that I talk upon the meaning of an Academy of Science, I cannot perhaps do better than to make the history of western Academies a point of departure, because the meaning of these Academies is expressed in their history. The Academy of St. Louis and the younger western Academies were started under the stimulus of the newness and attractiveness of the rich and virgin field in which the early enthusiasts found themselves situated. This field was just beginning to be appreciated and enjoyed at that time. And so it was rather the enthusiasm of those who were inspired by these sciences, than any mastery of the field, or any great attainments in it, that promoted the organization of these Academies. There were a few men like Dr. Engelmann who had already attained noble things in the mastery of certain departments of natural science, but these were rare and conspicuous exceptions. The great mass of those who assisted in forming these Academies were rather enthusiasts in learning something about the new realm than profound students in it. They were perhaps prompted rather by laudable curiosity and personal wish for knowledge than by a firm and set purpose to develop rigorous science as such.

But that stage soon passed away, and most of these Academies began to experience the untoward effects of the waning of these first enthusiasms. There followed a necessary shifting of effort from enthusiasm to the harder more systematic work of true science. This was accompanied by the evolution of the specialist, and attended by the less popular characteristics of specialism. The Academy in this later aspect necessarily ceased to offer that general attractiveness to the community which it did in the days of its pioneer work, and difficulties of maintenance arose from this. A solution of a part of these difficulties has already been suggested by our Toast-Master. He advises that the less popular studies be committed directly to print without reading in open session where few could appreciate them. In the printed form, they may be studied by the fire-side with care and leisure. As a friend said to me to-day, you can then turn back and review what

has been said at pleasure, and can mull on the subject until its meaning is fully mastered.

While this necessary transition from the earlier to the later phase has been taking place, some of our Academies have not been free from a struggle for existence. It has been difficult to find an appropriate popular substitute for the early papers of general interest. The solution which has been attempted by the Academy which I have the honor to represent, centers in the frank adoption of systematic methods for public instruction in the sciences represented by the Academy. This has been carried out quite apart from the presentation of the new results of research. During each of the last few years a series of lectures has been arranged, given by the best men that could be procured, on subjects with which they were especially familiar. These lectures have been attended with growing numbers and by interest and enthusiasm until the hall is crowded on each occasion, unless there are exceptional circumstances to prevent. The Academy has attempted frankly and directly the work of popular education in science. Its members less frequently than formerly gather to listen to the special results of scientific research. These are published and put before the scientific public directly in printed form without passing through the older process of reading and verbal discussion. In some measure this is the outgrowth of special local conditions.

I think there is a clear hint of the true function of an Academy in the historical fact that the first meeting of the Academy of St. Louis was held in the hall of the Board of Public Schools. This suggests the chief feature in the true relationship of an Academy of Science to the community; it is one of the many educational appointments which are necessary to the ideal evolution of an intellectual people. It performs a peculiar function in bringing together those who are engaged with science professionally, with those who are interested in it as amateurs, and with those who simply desire to learn. By thus bringing together these different elements a community of interest and intelligence is gradually developed. Our friends of the mining profession tell us the coming to-

gether of currents of different kinds often gives rise to the concentration of metallic values. I think something like this is true in the scientific world. The Academy is a means by which interests of diverse kinds arising from varied sources, can be brought together, and through intermingling, develop intellectual values that might otherwise be lost. In the theory of ore deposits, the current which brings in no metallic content, is perhaps as essential as the one that is burdened with riches, and in like manner a membership that seeks knowledge may be as important to the welfare of an Academy as one which has knowledge to give.

Our President has referred to the hope of long life for the Academy. This hope might well have taken the form of an expression of confidence that an Academy, or the lineal descendant of an Academy in such form as the needs of the future may require, is to be a perpetual institution—perpetual at least, so long as man shall be progressive. I do not think we fully realize the importance of the work done by an institution of this kind as a source of intellectual evolution. I feel that as a race, we are just beginning to learn how to think; that we are in the very earliest stages of intellectual development of the higher order. The sounder modes of thought are, in my judgment, just coming into general use. They are being introduced more largely through the natural and physical sciences than through other lines of intellectual endeavor, because in dealing with the tangible things of these sciences, we are forced to recognize the rigor of facts, the complexity of phenomena, and the necessity for distinguishing that which is important from that which is trivial. These are the essential factors of common sense. In many of the older academic studies, the trivial rather than the important has been emphasized. It has been the nice shadings that are subtle, rather than the weighty things that are basal, that have claimed attention. The dative case has occupied more thought than the indispensable cases. It is the discrimination of the fundamental things, it is the laying of weight on the really important things that must become dominant in our intellectual pro-

ceedings before our race becomes, in the higher sense, a race of sound thinkers. The little things must be reckoned as little things, if we would measure intellectual values aright. Those quantitative and composite studies that modern science has taught us, have perhaps done more to point the way to the essence of the best thinking than any other element in our education. I believe that ultimately every one of the subjects of thought must come under the dominion of the methods now best represented in the pursuit of the physical sciences. I believe that our sociological questions, our ethical questions, all our humanistic problems must be solved by inquiries pursued along these more rigorous and more cautious lines. To illustrate, I think that the time must come when the operation of our laws will be as carefully studied, as accurately recorded, and as scrupulously followed out from beginning to end, as are the experiments of the agricultural farm and of the biological or physical laboratory to-day. When a people shall agree to try an experiment in legislation, *as an experiment*, and record the results of that experiment with the utmost scrupulousness, and with untiring persistence and accuracy, and shall be guided by the results in a true scientific spirit, then we will be in the line of really higher legislation, *and not until then*. So, likewise, I believe that our ethics, which are the subject of so much solicitude to-day, are to be worked out on the line of a careful, conscientious study of the whole course of the prolonged administration of the world. You may spell it Administration, as I would choose, or you may give it the form of a common noun, but this will not affect the vital fact that the secret of true ethics is to be found in a study of the actual administration of the world as self-recorded in its own on-goings. Ethical inductions are to be drawn from the great chain of history which has led up to the present time. Our duty to the race, and to all creation will be fulfilled chiefly by the measure of influence we exert on the great chain of events that is yet to follow. As a geologist, I forecast no short period for the unfinished history of the earth. I fondly hope, with no small measure of belief, that the period which remains

to man, or man's higher successor, will be comparable to the great period since organic beings began to live on earth; that the period of intellectual development will compare in its vastness with the periods of physical and of biological evolution that have preceded it. If I were to forecast a future for this Academy, it would be along the lines of these suggestions. The specific work which this Academy will do may indeed be lost in the great mass of concurrent influences, so far as casual observation may go; but it will not be lost in reality. It will be merged into a complex of influences of almost infinite magnitude.

So I think it is not a little thing that is being done here, because, although the Academic influence to-day may be limited, the perpetuity of its effect in the ages to come, is immeasurable. While therefore I congratulate you heartily upon the successful completion of half a century, I predict for you with confidence, not merely a million of years, but millions of years of future influence.

THE TOASTMASTER: —

Before calling on the next speaker, I desire to read a letter which will serve, perhaps, to bring us a little nearer to the men whose memories we honor to-night. This letter I received only a few hours ago, from Mrs. Susan F. Stevens, who was invited to be present on this occasion. Her deceased husband was one of the founders of the Academy.

I very much regret that I cannot be with you at the semi-centennial of the Academy's origin. I fear the excitement would be too much for me. I am eighty years old.

I remember well some of the preliminary conferences which were held in my house, which led to the organization of the Academy. The earnest striving of the few active workers to surround themselves with supporters and encouragers in their efforts to do something for the world in the lines of scientific research. I wish you long life with extended usefulness.

THE TOASTMASTER: —

The next speaker whom I will introduce represents a different phase of scientific work from those who have preceded him. He is the delegate of the American Chemical Society. I call upon Dr. J. H. Long, of Chicago.

DR. LONG: —

Mr. Toastmaster, Ladies and Gentlemen: — Some twenty years after the founding of this Academy, the American Chemical Society was organized; after some years of uncertain work and struggle it finally began to grow and has now reached a membership of nearly three thousand. On behalf of the President and Council of the Chemical Society I bring you greeting, and cordial wishes for your future.

The chairman of your Committee has asked me to say a few words on the trend of chemical development in the last fifty years, on the direction in which advance in this science has been the most marked. A brief discussion of the topic is not a simple matter. Fifty years in the life of a science may mean much or little; in bacteriology, modern physiology and pathology it means everything, but in physics, mathematics and astronomy it counts for far less. To state the importance of the last fifty years in the history of chemistry is not as easy, and I shall not attempt to say anything of the marvelous growth of chemical technology.

If we look over some of our books on the history of chemistry, — the famous work of Kopp, dating from 1843, for example, — we are surprised to find that many of the things which attract our attention now are not even mentioned. Nothing is said of the spectroscope, nothing of ferments as we now know them, nothing of the coal tar dyes, and of our modern equations and reactions there is little that is familiar. If we examine another famous book, the chemistry of Gmelin, the fourth revision of which appeared after 1840, we encounter a nomenclature which is strange to us, and which is hard to read without a glossary. In considering what chemistry has done in the half century we must remember that fifty years ago our modern method of writing formulas was not generally recognized, and in the simplest expressions there was much confusion. Water, for example, was represented by at least four different formulas by as many schools of chemists, and this in spite of the fact that at a much earlier period Avogadro and Dulong and Petit had pointed out the criteria by which the atomic and molecular

weights may be fixed. It remained for Cannizzaro, in 1857, to call attention to these almost forgotten facts and insist on their fundamental importance. Such dates must be kept in mind to appreciate what has been accomplished in fifty years.

In studying the growth of chemistry we easily recognize two general lines of progress. In the one case we have the question of form, of constitution, of what things are; in the other, of action, of what things do, of function, in other terms. In looking first at the questions of constitution it is at once apparent that our greatest interest seems to be extending in two directions, and we are not obliged to go back fifty years to trace the beginning of our efforts. To be sure there is always the routine work of making inorganic and organic compounds and much of this has great value; the journals are full of this, but I have in mind two lines of endeavor of far greater interest, and perhaps of greater scientific importance. In the one direction investigation is concerned with the most minute of material particles out of which, possibly, the larger atoms have grown. Chemists and physicists have long cherished the idea of an ultimate corpuscle or protyle atom, but only within the last few years have the discussions taken any tangible shape. The study of radio-activity and the discovery of radium mean much for the foundations of chemical theory and may lead to the re-writing of several chapters which we had almost come to look upon as forever fixed. It is doubtless too early to properly recognize the full scientific weight of these recent discoveries.

I must say something now about work in the other field of study, regarding the nature or constitution of matter. While one set of investigators has been busy with the minutest of chemical particles, other workers have been making most remarkable advances in the opposite direction. In the early days of the study of organic chemistry the Dutch chemist Mulder thought he had reached the empiric constitution of the nucleus group in the protein molecule. Formulas were even given for certain proteins. Liebig and others were soon able to show, however, that the protein molecule is immensely

larger than Mulder assumed and the idea became in time pretty well established that these bodies are, in fact, so complex as to be beyond our power of reconstruction or analysis.

However, this general view did not shut out all investigation as to the real constitution of the albumins, and in the last twenty years a mass of evidence has been accumulated which shows that even the largest of the protein molecules must be built up by the combination of a number of comparatively simple complexes, among which certain amino acids are the most important. With this much gained the next step was to attempt to unite these groups by synthetic reactions, one by one, and thus build up the great protein bodies of high molecular weight. The idea was a daring one and its practical realization seemed for a time hopeless. However, the problem was at last successfully attacked by two German chemists, Fischer and Curtius, working independently and a remarkable result has been reached. These men have developed methods by which the constituent groups may be gradually linked together and already they have secured synthetic products of relatively great molecular weight, possessing many of the protein properties. The series of bodies made by Fischer are known as polypeptides, and the whole achievement must be looked upon as of the highest scientific importance. The proteins have long been regarded as the most complex of organic structures and the successful solution of this problem, which now appears in sight, will go far toward clearing out the "Rumpelkammer" of organic chemistry, which fifty years ago was the most crowded chamber of our chemical edifice.

In the study of chemical function, the second main direction in which progress has been made, the advances have been even more remarkable. The change has been so marked here as to constitute almost the birth of a new science. We need not go back fifty years to reach a time when chemistry was spoken of as "a science of the second rank," by our colleagues in physics, mathematics and astronomy. The older chemistry knew little of mathematics; but that condition is passed. As early as 1803, to be sure, Berthollet in his famous

Essai de statique chimique suggested a mathematical groundwork for our doctrines of chemical action, but his effort was in a sense premature. It remained for the Norwegians Guldberg and Waage to follow up the idea, which they did in a treatise published in 1867 with the title “*Études sur les affinités chimiques*,” in which problems of mass action and affinity are handled systematically and in simple mathematical treatment. Since that notable beginning many similar investigations have been published and the journals teem with discussions on the conditions of chemical equilibrium. Somewhat later than the labors of Guldberg and Waage came the epoch-marking papers of Gibbs and then the work of van't Hoff in which equilibrium problems are more rigidly handled and in which the many other applications of thermodynamics to chemical questions are pointed out. It may no longer be said that chemistry is “a science of the second rank.”

These advances are but a chapter in the new physical chemistry, which includes much besides. The theory of the independent action of the ions, the relation of this to questions of osmotic pressure, diffusion and electrical conductivity, the relations of organic structure to optical activity and many other chapters which might be mentioned, had I more time, are all developments of the last fifty years. A word must be said of the bearing of these discoveries in pure chemistry on the new physiological or bio-chemistry, in the broad sense. Where formerly we were obliged in the study of the animal or vegetable cell to confine ourselves to questions of form we now look to function as the thing of greatest importance. It is not so much what the cell is, as what the cell does, and how it does it, which claims our attention, and in the search for light in this hidden field it is the new physical chemistry which promises the greatest aid. Problems of fermentation and enzymic activity are problems of chemical change and doubtless must find their solution by the same aids which have been so helpful in other directions. The last fifty years have witnessed practically the whole development of the doctrine of cell ferments; when we come together fifty years from

now to celebrate the 100th anniversary in the history of this Academy a much more brilliant story may be told.

THE TOASTMASTER :

The Secretary of the Committee having these ceremonies in charge has made a list of thirty-one organizations which are represented here by twenty-six delegates, and they have been arranged in alphabetical order. We would like to hear from every one of the delegates present, but as we may not have time for this I shall not closely follow the list, but shall call upon those who have come from a distance or who represent foreign or national societies, before asking to hear from our home institutions.

I find that the American Physical Society is represented by F. E. Nipher. I am requested by that gentleman to say that it is the wish of the President of that Society that he present to you the greetings and good wishes of that body, and to wish for the Academy a long-continued life of usefulness.

I am going to pass one or two on the alphabetical list for the present, hoping to return to them later in the evening. I will now call on a gentleman who comes to us from Canada, representing the Entomological Society of Ontario, — Professor William Lochhead.

PROFESSOR LOCHHEAD :—

I am here to bring to you the congratulations of the Ontario Entomological Society on the good work you have done; and especially on the celebration of your fiftieth anniversary. I can hardly tell you at this late hour how much we are indebted to your Society, and to individual members of your Society. As an Entomological Society, we are a few years younger than your Academy. We originated in '63, so we are in our forty-third year. We are coming close in behind you. Our early members were for many years in close touch with one of your early members, C. V. Riley, who gave us valuable assistance; and many of our members are greatly indebted to him. I did not have the pleasure of knowing him myself, but our oldest members—I may say that three of our

original charter members are still living, but were unfortunately unable to be present this evening, — knew him quite intimately.

Allow me to tell you something about our Entomological Society. It has published thirty-six Annual Reports, each containing much valuable information for the fruit grower, farmer and gardener. These reports are distributed widely over Canada and have done much to popularize the study of insects. The Society has also published the *Canadian Entomologist* for thirty-eight years, twelve numbers each year without a break. This magazine, under the editorship of Dr. Bethune, occupies a high place among the entomological journals of the world, on account of the uniformly important character of the articles published therein.

It has been stated here to-night how much this Academy has done to advance Science and how much the world is indebted to the progress of Science during the last fifty years. The Canadians, at any rate, look with envy at the great progress the United States have made during the last one hundred years; we fully realize that the 19th century was the century of expansion of the United States. However, we Canadians are beginning to look with pride on our country, for we have a grand heritage on our side of the line. (It is not all snow up there, and this year there has been very little; sometimes we have a good deal, but this is not always the case.) We are inclined to believe that the 20th century is to be the century of the expansion of Canada. We expect a great many of you over to see us; a great many of you are coming over, and we hope more of you will come, for we like you. We have been coming over to you for many years for inspiration and for help, but we will requite it now, and ask you to come over and get what you can from us. There are great possibilities for Canada. It used to be called the land of snow, stunted pine and poplar, but the last few years' explorations have shown that the northern belt of human civilization can be extended much further north than we supposed. The great wheat fields of the Northwest were considered, until a few years ago, wholly unfit for wheat growing. More-

over, our Northern Ontario, the great region south of Hudson's Bay, which was not long ago considered a wilderness, is probably one of the richest regions in Canada; and with the exploration of that country, and the building of railways through that country, great developments have taken place in the mining, agricultural and lumber industries.

We look forward with confidence to great achievements in the near future, and we know that science will aid us in these achievements. We ask that you will come over and see the progress for yourselves. I have very great pleasure indeed in congratulating you upon the good work you have done.

THE TOASTMASTER:—

One of the things named in the charter of the Academy of Science is the establishment of a museum in the city of St. Louis. There was a museum here at one time, but it was destroyed by fire. We are beginning to establish another, now that we have a home. I think perhaps we are not yet fully acquainted with the way in which that should be done. I am sure that you would all be glad to hear how they do it in Chicago. We have with us this evening a gentleman representing the Field Columbian Museum; Dr. Oliver C. Farrington.

DR. FARRINGTON:—

Ladies and Gentlemen: — I desire first to express my personal gratitude to the founders of this Academy; for had they not met fifty years ago and founded this Academy, I should not have had the great pleasure which I have enjoyed this evening. I am reminded of an Oxford student who left the University with a number of bills unpaid and some time afterward went up to help celebrate the sexcentenary of the institution. Being immediately besieged by his creditors he replied, "Gentlemen, do you suppose I come up here every six hundred years to be dunned?" The circumstances tonight being somewhat different, I can say that I do hope to come here every fifty years to dine with you.

It is a great pleasure and privilege for me to bring to you

on this occasion the greetings and congratulations of an Institution which is somewhat younger than your own, but which I trust is no less earnest in its purpose and high in its ideals. The motto of Missouri in the vulgar world outside being supposed to be "You will have to show me," it seems quite fitting that the leading city of the State should have founded among its earliest institutions one for the discovery and demonstration of truth, and also fitting that a city whose motto is "I will" should somewhat supersede the older city in the establishment of a great Museum. We are very glad to join with you in honoring the men who in earlier years founded this Academy, for they are names of men like Shumard, Swallow, and Broadhead, who have done work that will last, and the importance of whose work even yet we probably do not fully appreciate. But I was asked on this occasion to say a word regarding the Museum and the Public.

In recalling an experience of fifteen years in acting as mediator between the Museum and the Public, numerous incidents have shown me that the Public does not always understand what the Museum is trying to do. For instance, I remember a gentleman who after wandering disconsolately about the Museum for the space of half an hour, approached one of the guards and said in a despairing tone, "When does the performance commence?" I also remember a six-year old boy who came with his sister to the hall of ancient skeletons and was so frightened by their appearance that he did not dare to go farther until his sister, telling him to shut his eyes and hold her hand, assured him that she wouldn't let the exhibits hurt him. I remember also a teacher who, having been informed that she could gain great benefit by visiting the Museum with her classes, came to the Museum so accompanied and told afterward with great disgust that "they went to the Museum and there they were."

Mr. Dooley says: "You can lead a man up to the University, but you can't make him think." I think that is hardly to be said of the Museum. My experience is that some stray sparks of thought can hardly help being aroused in any one who passes through the halls of a great Museum, well-ordered

and well-arranged. The Chicago public school-teachers tell me that Museum study notably increases the seriousness and earnestness of their pupils, and what is more important perhaps, after Museum study the pupils draw less fiction from the Library and more works of natural history. In other words, the Museum is the foe of the yellow-backed novel. Sociologists tell us that a large amount of the evil of society comes from a lack of broad outlook and of suitable occupation to fill up idle time. May we not believe that we have in the Museum a means of overcoming evils of this character?

There no longer exists, I think, the idea that the Museum is a place where a specialist can ensconce himself and study his favorite bug to the exclusion of all else; for efforts are being made that the Museum shall become of all possible interest to all classes of people. Sometimes, it is true, such efforts are carried a little too far, as was shown when an edict was passed by the British Museum that all scientific names should be translated, but which was rescinded when it was found that such names as *Pygopterus Humboldti* became Humboldt's hind wing and that other similiar absurdities were produced. Such things show us that a Museum cannot descend too far from a dignified position, but it is also true that the public is learning not to be repelled by such an attitude, and to believe in, look up to and search out the Museum. Instruction is, however, but one function of a Museum. Another great function is that of preservation of things that are passing. This is a function whose fulfillment will be appreciated more in coming generations than in our own. Had it been appreciated earlier, we would not have had to go, as we must to-day, to London in order to see a great mastodon which was dug up forty miles from St. Louis; or to Vienna to see a wonderful meteorite which fell a few years ago in Arkansas. We used to think that we ought to feel proud that London and Vienna were willing to exhibit our curiosities, but I am happy to say we are getting over that feeling. We have learned that there is no place like home, and that the more we respect and esteem our own institu-

tions the higher will be the estimate which foreign institutions will place upon us.

All these things lead me to believe that the Public Museum has come to stay, and that the time has come when, to adapt a phrase of Lincoln's, not only Governments, but Museums, "of the people, by the people and for the people, shall not perish from the earth."

THE TOASTMASTER:—

We have also another visitor from another State; Dr. L. H. Pammel, who represents the Iowa Academy of Science.

PROFESSOR PAMMEL:—

Mr. Toastmaster:—The Iowa Academy of Science brings greetings to its sister Academy on the occasion of her fiftieth anniversary. The St. Louis Academy is the oldest Academy of Science in the Mississippi Valley. I believe it is not boastful when the statement is made that from the view point of achievements it has accomplished as much as any similar body in the United States. St. Louis owes much to the Academy. For more than a quarter of a century it was the guiding spirit of scientific thought in this vast empire tributary to St. Louis. The world at large learned of the scientific activities through its proceedings and more and more we have come to look for the announcement of valuable discoveries in its pages. The Iowa Academy more and more feels the obligation it owes to the Academy of St. Louis in starting centers of scientific research.

In our own State we have the Davenport Academy, which has a scope similar to your organization. At first sight it may seem to many that in a State like Iowa there is not room for two organizations. The Davenport Academy has also had a long and honorable career. The work of the Iowa Academy has been largely local in its character, and properly so. The funds for the publication of its proceedings are borne by the State. Its citizens have therefore a right to ask that we confine our work largely to local problems.

Scattered over the State are many small colleges, and in

each more or less scientific work is done, much of it of good quality. The proceedings open an avenue for publication. It seems to me it is far better to publish in such proceedings than to have separate publications from each institution.

I have not the time, nor would you have the patience to listen to a résumé of what the Iowa Academy has done for science in the State, but I may say truthfully that its proceedings compare very favorably with those published by other States. The topics cover a wide range of the sciences of geology, zoology, botany, physics and chemistry. Its best work has, however, been done in promoting a good fellowship among the scientific workers of the State, and in promoting the geological and natural history survey of the State, helping along the cause of pure food legislation, and assisting in the cause of national and local forest legislation, also in stimulating a healthy growth of science teaching in our public schools. We hope, too, that it may be our pleasure to celebrate our fifty year existence in the future, and that we shall have accomplished as much as the St. Louis Academy.

It is our wish also that the St. Louis Academy may continue to cover the whole range of sciences, and that for the publication of scientific achievements it may reach out as it has in the past, for good papers in all parts of the United States. That is its sphere. It is our hope and wish that some liberal citizen of St. Louis will help the good cause along.

The St. Louis Academy needs an endowment as large as that of the Davenport Academy and larger, to carry on its good work. St. Louis is large enough and rich enough to make an endowment of a million dollars at once to further the interests of the Academy and place it forever on a permanent basis. This is important also because the Academy bears a definite relation to the scientific work of St. Louis and especially the Missouri Botanical Garden.

THE TOASTMASTER: —

We have a representative of the Philosophical Society of Washington, and the National Geographic Society, WJ McGee.

DR. MCGEE: —

Mr. Toastmaster, Ladies and Gentlemen: — It is my distinguished honor to represent the Alpha and Omega of Washington science; for the Philosophical Society of Washington is the eldest and the National Geographic Society is among the youngest of the scientific organizations of the national capital.

Two among the great achievements of Joseph Henry stand out prominently in the history of organized science; the first was the founding of the Smithsonian Institution on a plan so lofty yet so definite that its career has been maintained, despite administrative rocks and shoals, in a manner bringing honor and credit to science throughout the globe; the second was the founding of the Philosophical Society of Washington — a contemporary of St. Louis Academy of Science — as the first clearinghouse of Science in the national capital: an organization so wisely planned and so well adjusted to conditions that it has not merely survived but has enlarged knowledge and enriched science by engendering an entire family of scientific organizations — for the Biological Society of Washington, the Anthropological Society of Washington, the Entomological Society of Washington, the Geological Society of Washington, and the Washington Academy of Sciences are direct offspring, and the National Geographic Society, the Columbia Historical Society, and several other organizations are indirect progeny of Joseph Henry's Philosophical Society. By its own effective work and through its offspring this parent organization of Washington science has contributed its quota to the spirit and standards of science throughout the country and the world; and it is with special pleasure that I bring you the greetings of the Philosophical Society.

The National Geographic Society, like its precursor, was largely the foundation of a man of note — Gardiner Greene Hubbard, a promoter of education and a friend of science, the most eminent citizen of his time in the national capital; it was designed to diffuse rather than to increase knowledge, according to a plan which enlisted the sympathy and co-opera-

tion of leading scientists; its methods and purposes were so wisely adjusted to the needs of the capital and the country that it has become the largest geographic society in the world and one of the most effective scientific-educational organizations of the United States. Its active membership extends into every State in the Union and every civilized land; and I feel a peculiar pleasure in conveying to the St. Louis Academy of Science greetings on behalf of the ten thousand members of our cosmopolitan National Geographic Society.

At every stage of their growth the scientific organizations of Washington have both profited by the centralizing influence attending their position in the national capital and reflected this influence to all parts of the country; so that all of the societies situate on the north bank of the Potomac are measurably national in character and have helped promote the development of wholly national organizations. Among these there is one which I may venture informally to represent as chief founder and first president—i.e., the American Anthropological Association; for on behalf of the science for which this Association stands I may speak with confidence concerning the career of Saint Louis Academy of Science, and may prewise a future for the Academy even brighter than its notable past. It is the business of the anthropologist to watch the drift of things human, to note the progress of men and institutions; and I may summarize and integrate the expressions of preceding speakers who have pointed out the enormous progress made in the different branches of science during the last half-century by saying that within the fifty years of its existence Saint Louis Academy of Science has witnessed a full half of the growth of that consciously organized knowledge known as Science. Perhaps this estimate might seem excessive to exponents of those branches of knowledge less intimately connected with the daily and yearly progress of mankind, the daily and hourly extension of conquest over Nature; but the vista of Anthropology is broad and clear—Anthropology, in truth, is the Science of Science-makers—and full of promise; for in the light of human facts and faculties it is clear that the law of Progress is cumulative,

geometric rather than arithmetic, kinetic rather than dynamic. Probably the last century saw the doubling of the entire sum of human knowledge; Saint Louis Academy has seen in its half-century the doubling of the sum of consciously organized knowledge as it proceeds year by year at an ever increasing rate of advance; and it cannot be questioned that both the advance and the rate of advance will continue cumulatively in such fashion that the next quarter or third of a century will see the sum of science doubled again — and that the next fifth of a century will witness another doubling.

How will the Saint Louis Academy of Science keep pace with this progress? Its fifty years of history answer: it will stand in the van. Probably it will progress along lines of extension no less than along the intensive lines to which it has chiefly held; it may work indirectly by fostering off-spring after the fashion of the Philosophical Society of Washington, or it may combine increase and diffusion within and from itself; in either case its influence must grow and it must enter into the solidarity of intellectual life in our interior metropolis: contemporary institutions may plant knowledge, it will water; other organizations may gather crude ore of science, it will smelt and fine and alloy and mint — and the standard coin will circulate afar. Already its influence is strongly felt, as has been that of like institutions before; a germ springing in the Centennial Exposition was fertilized by the influence of Joseph Henry's foundations, and the National Museum took shape in the national capital; an ovum in the Columbian Exposition was fructified by the spirit of Chicago Academy of Science, and the Field Museum was begotten; a nucleus was gathered in the Louisiana Purchase Exposition and vivified by the vitality of Saint Louis Academy, and our Public Museum was conceived — to the future benefit of our city and state.

Hardly half a century ago Huxley declared "Prophecy is not yet exact science;" yet such has been the advance in both knowledge and method that we may now hold: Prediction on a given plane is the function of Science. So, while none may point out the precise lines along which Saint Louis Academy will grow and make its influence felt — since these

lines may fall on new planes of activity — I may, as a representative of institutions of both the intensive and the extensive sort, and also as an anthropologist, revise for the institution we delight to honor to-day a future even more glorious than its past.

THE TOASTMASTER:—

I take pleasure in calling upon the representative of the Wisconsin Academy of Sciences, Arts and Letters, Dr. E. R. Buckley.

DR. BUCKLEY: —

Mr. Toastmaster, Ladies and Gentlemen: — I assure you that it gives me very great pleasure to extend to you the congratulations of the first scientific society of which I became a member. I appreciate that more thoroughly because you have with you to-night two of the gentlemen who have done perhaps more for the success of that organization than any other members with whom I am acquainted,— Professor T. C. Chamberlin, of the University of Chicago, and Dr. E. A. Birge, of the University of Wisconsin. I am not in a position to give you the history of the Wisconsin Academy of Sciences, Arts and Letters, and I feel as I look about this room that possibly you are all very glad I am not going to extend to you that courtesy. I can assure you, however, that my association with the scientific work of the Wisconsin Academy of Sciences, Arts and Letters, has done more to bring about in my mind a thorough understanding of the relations between the different branches of science than perhaps any other society with which I have been connected.

I came here to-night not only representing the Wisconsin Academy of Sciences, Arts and Letters, but also to extend to you the greetings of the Missouri Bureau of Geology and Mines, of which I have the pleasure of being the Director. I am a resident of the State of Missouri, and I am very proud of the fact that the St. Louis Academy had among its founders two of the foremost geologists whom the State of Missouri has ever had, and two men who probably left a greater

impress upon the studies in geology than any other men who have been within the confines of this State. I refer, of course, to Dr. G. C. Swallow and Dr. B. F. Shumard. I think I can say confidently and with authority that one who travels over the State of Missouri to-day cannot but have the highest regard for the work which these men did in the early days. It is complete and accurate; their observations were good, and their conclusions were excellent; and I think that we owe a very great debt of gratitude, not only to these gentlemen personally, but to the St. Louis Academy, from which they undoubtedly derived a very great stimulus in their work.

On behalf of the Wisconsin Academy of Sciences, Arts and Letters, and of the Missouri Bureau of Geology and Mines, I extend to you most cordial greetings. I thank you for the privilege of making this short address at the banquet which commemorates the fiftieth anniversary of the founding of your society.

THE TOASTMASTER: —

One of our own members represents the International Association of Botanists and the Botanical Society of America,— Dr. Hermann von Schrenk.

DR. VON SCHRENK: —

It gives me a great deal of pleasure to present to you on this anniversary occasion the very best wishes and heartiest greetings of the Association Internationale des Botanistes, and the Botanical Society of America. Both of these organizations, when compared with the St. Louis Academy of Science, are young in years, but the expressions of felicitation which they bring to you are none the less cordial.

There are many thoughts which I would like to express in the name of the botanists, but there is one in particular which I wish to say a few words about. I have oftentimes thought that organizations of specialists, such as the ones which I have the honor to represent this evening, owe a debt of gratitude to the organizers of societies such as the St. Louis

Academy of Science. At the time when the St. Louis Academy was founded, as was indicated by a previous speaker, the study of science as we understand it to-day was comparatively a new thing to the general public. It was through the activity of the men who organized such societies as the Academy, that the various lines of scientific research were stimulated; it was a result of their encouragement, and along the lines laid out by them, that scientific thought developed to the high plane which we find it in to-day. We owe much to the early encouragement of the busy men of affairs who yet found time to get together for the promotion of science; such men, for instance as the one whom we are all proud to acknowledge as botanists, the first President of this Society, Dr. Engelmann, who, although a busy physician, yet found time and energy to investigate, not one but many branches of the science of botany. The impetus which these men gave to the development of science in its various branches should be thought of, it seems to me, by us, at the present moment. Out of those early efforts of theirs has grown a widespread interest in natural phenomena, represented to-day by groups of specialists in the various fields of science.

There are more things which I would like to dwell upon but at this late hour I feel that by expressing in a most hearty manner the felicitations of the two botanical societies, my purpose will have been fulfilled.

THE TOASTMASTER: —

We have representation from the National Academy of Sciences, the American Philosophical Society of Philadelphia, which is the oldest society in this country, the Boston Society of Natural History, the American Academy of Arts and Sciences, the International Academy of Botanical Geography, the Society of Physical and Natural Science of Bordeaux, France, and the Missouri Botanical Garden. All these are to be represented by Dr. William Trelease.

MR. TRELEASE: —

Mr. President, Mr. Toastmaster, Ladies and Gentlemen: —
The National Academy of Sciences and the American Philo-

sophical Society have asked me, as a resident member, to represent them at this semi-centennial gathering of the Academy of Science of St. Louis. I have, therefore, the honor and pleasure, on behalf of these organizations, which stand for what is noblest and best in American science, of heartily congratulating The Academy of Science of St. Louis (the first President of which was a member of both these bodies) on the completion of its first half century; on the high ideals that it has always upheld; and on the solid additions that have been made to knowledge by its members, a number of whom have ranked among the foremost men of science of our land. I am also desired to express to the Academy our hope that the coming years may be even more prosperous with it than the period now closed; and our full confidence that, if its ideals be maintained and its scientific activity continue unabated, those who, technically and commercially, owe much to science and are able to do so, will come more and more to its material succor, and that its usefulness will increase in increasing ratio with the passage of the years.

As a corresponding member of the American Academy of Arts and Sciences and of the Boston Society of Natural History, I have been asked to tender similar congratulations, expressions of esteem and of appreciation of what the Academy has already accomplished, and of confidence in its future.

The Société des Sciences Physiques et Naturelles of Bordeaux has honored the Missouri Botanical Garden with a request to act as its representative this evening, and, by direction of the President of the Board of Trustees of the Garden, I am pleased, as its Director, to fulfil this honorable commission. I am also charged, as a member and past-president of the Académie Internationale de Géographie Botanique, to serve it in a similar manner. It gives me much pleasure to tender the heartiest congratulations and good wishes of these societies, the corporate home of which is in France.

Finally, on behalf of the Missouri Botanical Garden, I desire to renew all of these expressions of good will, and to say further that the interest of the Garden in this occasion is a double one, for the reason that we not only celebrate to-night

an important anniversary of the Academy of Science but at the same time call to memory one of the greatest, most active and most painstaking of American investigators, George Engelmann — of whose attainments Dr. Green has so well spoken in presenting the medal bearing his likeness, to whose initiative and constant faith in its future the Academy owes more than I have words to express, and whose wise counsels contributed very largely to the crystallization of Henry Shaw's plans in the form which has resulted in provision for the enduring maintenance in our city of the research institution which it is my privilege to direct and to represent officially on this occasion.

THE TOASTMASTER:—

I shall have to beg indulgence for having omitted in its alphabetical place the Geological and Natural History Survey of Minnesota, — I call on Dr. Conway MacMillan:—

PROFESSOR MACMILLAN:—

Mr. Toastmaster, Members of the Academy and Guests:— It certainly gives me great pleasure to express to The St. Louis Academy of Science the congratulations of the Minnesota scientific institutions which I have the honor to represent.

I thought when this medallion was presented to me and I observed that it bore the familiar features of Dr. Engelmann, that it was very expressive of a certain truth which has been coming to me with greater clearness as the years go by. After all, in our scientific work, it is personality that really counts.

On this occasion I venture to paraphrase the words of Tennyson: "Better fifty years of science than a cycle of superstition." What the great poet really meant when he wrote the famous line was that it is better to have those qualities of the intellect than those other less developed mental aptitudes which are still so common in all of us.

In this connection, I was particularly interested in the remarks made by the delegate from Canada. I had one of the

most interesting experiences of my life in Canada. You know there are some little incidents in life which afterwards turn out to be very vital. Their effect proves to be peculiarly searching and important. I think I will relate the incident which made so profound an impression upon me. One night in June when a friend and I were camping on the shore of a lonely lake in Canada, we heard some three miles away, from a little island, the booming of an Indian drum. I said to my friend: "Let us see what it is." So we put the canoe into the water and went across the bay, in the white moonlight, to the spot where the camp of the Indians was established. We found some fifteen men of the tribe sitting around a pine tree. One of them was beating the drum. The others remained in silence. There were no women in sight. I looked into one of the tepees and within were the women of the tribe, one of whom had in her arms a little child, emaciated and dying. I think its spirit was just leaving the body. They had a string running from the tepee to the top of the pine tree and every twelve inches or so along its course was knotted in a tuft of feathers. It was very plain that they were doing their best to give the soul of the child a favorable passage to the happy hunting grounds, and as the spirit climbed the ladder prepared by love the men were doing their part to keep the forces of evil from seizing it as it made the journey.

In some way it came to me with great strength that we are all concerned in the same deep problems of life, and of late years I have been much more impressed than during my earlier manhood with the unity of purpose between the most scientific and the most superstitious. In considering the place of modern science, I am inclined to take a sympathetic view of the unscientific.

Sir William Dyer wrote to me a few years ago a sentence which seemed to me very pregnant with thought and truth. He said: "Science must not be apart from life; it must be a part of life." I think the academies of science throughout the country are fulfilling their destinies when they make themselves a part of our national life. I was greatly interested in what the toastmaster said a moment ago when he

reminded us that "there are also black ants." We certainly must remember that there are two sides to every question and while technical erudition is admirable, the great duty of scientific men is after all not to disappear into an impenetrable cloud of technicalities and verbiage, but to bring themselves closer and closer to the great pulsing life of the American people and to develop throughout our country the right good and true thought of science.

As you know, we are very much in the habit in these days of calculating our advance by things accomplished. People say: "I can remember when there were no safety matches," or "I remember when the first electric lights were put in." We calculate our advance by the control we exercise over nature and this is the tendency of the scientific man as much as of any other. I believe it was Russell Sage who gave utterance a little while ago to the remark that he "had no time for the good fellow." In his judgment and from his special point of view, the good fellow did not save his money, spent too much of his time in happiness and went through life without very much high financial seriousness. Yet I believe that the best way to mark our advance from year to year is not by the control of nature evidenced in invention and discovery, but by the development of good fellowship in the highest use of the term. This meeting to-night is a splendid example of such good fellowship. It would not have been possible to have such a meeting some years ago. As the world goes on its progress is better marked by the spirit of organization than by material scientific benefits. Events of this sort are among the greatest and best landmarks. Here we have good fellowship of the right sort. Certainly it is fellowship; certainly it is good; certainly we are delighted to be here to-night and to sit around this hospitable board of The St. Louis Academy of Science. I predict a most bright future for the organization. This is just as much the day of creation as any day. Everything is moving and developing. It is a pleasure to us all to live and grow and feel this pulse of advance beating in us. What we witness is the progress of our social organization, the advancement of ourselves as

persons, and the combination of social and personal development, which makes up the civilization of the day. On the obverse of the medal is the face of a splendid scientific worker. There is the personal touch. On the reverse is the seal of the Academy. So organization is symbolized. In the good fellowship extending from person to organization shall we see the true bench marks of progress.

THE TOASTMASTER:

The following other organizations have personal representation here: —

The American Pharmaceutical Association, represented by Dr. H. M. Whelpley; The Engelmann Botanical Club, represented by its President, Mr. C. H. Thompson; The Engineers' Club of St. Louis, President W. A. Layman; The Missouri Historical Society, Mr. James A. Reardon; The Naturalists' Club of St. Louis, Mr. Julius Hurter; The St. Louis Biological Club, President S. M. Coulter; The St. Louis Chemical Society, President H. A. Hunicke; St. Louis Public Museum, President J. H. Terry; The State Historical Society of Missouri, Secretary F. A. Sampson; and Washington University, represented by Chancellor W. S. Chaplin and several members of its Faculty.

[Owing to the lateness of the hour, the representatives of these bodies were not called to their feet, but their messages follow]: —

DR. WHELPLEY: —

Mr. Chairman: — It affords me particular pleasure to represent the American Pharmaceutical Association on this occasion, as I had the honor of serving as president of that organization when it celebrated its own semi-centennial.

The A. Ph. A. was organized in 1852 for the purpose of securing national legislation, regulating the quality of drugs imported into this country and to further the interests of pharmaceutical education. As time passed, the association increased in size and extended its field of work. To-day, it is the largest and broadest organization of its kind in the world.

Every reputable person interested in any department or feature of pharmacy is eligible for membership.

The annual interest on the Ebert Fund is appropriated as a prize for "an original investigation of a medicinal substance." The Centennial Fund provides the means "to aid in the prosecution of original investigations." The by-laws also provide for several general prizes for meritorious work in the sciences and arts which are concerned in pharmacy.

Very naturally, chemistry, botany and physiology have been the departments of science in which the greater proportion of original work has been accomplished by members of the society. It is along these lines that we find the A. Ph. A. touching elbows with your esteemed Academy. Its fifty odd volumes of proceedings, averaging nearly one thousand pages to the book, constitute a useful record of scientific progress in an important department of knowledge.

I am instructed by the president of the organization I represent to convey the hearty greetings of our members. I take part with zeal in the dominating feature of this semi-centennial, which so justly pays tribute to the grand old man whom you honor as the founder, and to his associates in the pioneer scientific work of the Mississippi Valley. One of your veterans to-night is also an ex-president of the A. Ph. A. and one of its patrons: I refer to your treasurer for the past forty-five years, Dr. Enno Sander.

Mr. Chairman: — Time passes rapidly and when the hand that winds the years away has doubled the age of The St. Louis Academy of Science and your successors celebrate the centennial, may a goodly number of those now active remain to tell by tongue and pen of your golden jubilee!

MR. THOMPSON: —

Mr. Chairman, Members of the Academy of Science: — In December, 1897, the professional and amateur botanists in and about St. Louis organized themselves into a society for mutual aid in collecting and distributing botanical knowledge and for co-operation in a fuller study of the problems of plant life in our immediate vicinity. In selecting a name for the

society it was but natural that we should honor the same with the name of the pioneer botanist of the West, Dr. George Engelmann.

It gives me great pleasure to extend to you the cordial greetings of The Engelmann Botanical Club on this occasion, — your semi-centennial anniversary, and to express its hearty sympathy in honoring the memory of your first president. We wish you a future of increasing prosperity.

MR. LAYMAN: —

Mr. Chairman, and Gentlemen of the Academy of Science: — It affords me great pleasure to convey to you the cordial greetings and congratulations of the Engineers' Club of St. Louis. That this is an unusual and also very auspicious occasion is amply evidenced by not only the large number of representative scientists and citizens of St. Louis present, but also by the very complimentary attendance of delegates from other and distant scientific organizations. I am sure this very notable gathering may alone be taken to indicate not only the significance of this occasion, but also the meritorious standing of The Academy of Science of St. Louis.

There are many of your guests from outside the city of St. Louis whom you no doubt desire to call upon for brief responses, and it is therefore becoming that I should only occupy a few moments in responding to your Chairman's invitation. I would be remiss in my duty to the Engineers' Club of St. Louis if I did not convey to you our warmest felicitations at this time and on this occasion.

In many ways our organization has been for a long period of years intimately associated with yours; many of our valued members have also the privilege of membership in your body. We have exchanged with you many courtesies in the way of co-operation in matters of scientific and engineering interest; we have the privilege and honor of sharing your present attractive and commodious Club quarters; and your Transactions constitute an element in our Library records. As a Club, and as individual members we know, perhaps better than any of your associate scientific organizations, the meritorious re-

sults of your long period of scientific investigation, and the high place to which you are entitled in the field of scientific endeavor.

We may, therefore, with propriety, claim some privilege in the recognition of your useful career, and may with peculiar warmth, congratulate you upon the rounding out of the half century of your record. Mr. Chairman and Gentlemen, I esteem it no small honor to be a delegate to this semi-centennial celebration, and to be able not only to extend the congratulations of the Engineers' Club of St. Louis, upon the work you have done in the past, but also to extend our interest and co-operation in your future scientific endeavor. Permit me to express for our Club the hope that your achievements of the future may reflect even greater credit to your organization, and justify even in a fuller measure the purposes and ambitions of your founders.

MR. REARDON: —

Mr. President, Members and Guests of the Academy of Science: —When, on my way to this board, it occurred to me that I might be called on to address this distinguished scientific gathering on behalf of the Missouri Historical Society, my mind reached out for impressions and recollections which might enable me to share appropriately in the mental banquet which I knew to be in store. The more I reflected the oftener my mind wandered back to a "school of learning" once established at Logoda in the land of Laputa, where strange and curious erudition was reputed to flourish during the times of long ago. One of the most erudite of the group was, if I remember rightly, striving to establish a science designed to abolish words from human ken; and it struck me that I am peculiarly unfortunate — and that you are still more unhappy — in that I never enjoyed the benefit of graduating from that institution. This scholar, as the story goes, used to argue that it was extremely advantageous to health and domestic economy never to speak; that speech was highly injurious to the lungs and materially shortened life; and as a substitute he proposed that since words were merely names

for things at the best, it would be infinitely more convenient for people to carry the things around with them to the end that when called upon to discuss or express themselves concerning particular matters they could proceed to a practical and objective demonstration — of the kind, by the way, which our citizens are of late accustomed to demand. This notion has grown upon me; and I am heartily sorry that I did not think in time to have with me the Missouri Historical Society to speak for itself, if for no other reason than to convey to you in silent eloquence, more impressive than words of mine can express, the congratulations and sympathy and rejoicing of a sister organization in your glorious anniversary. Be assured, Mr. President, that the Missouri Historical Society is with you in spirit, sharing your satisfaction over a splendid history and joining in your ambition for a still brighter future. Such an organization as the Saint Louis Academy of Science perfects and presents unsullied memorials of truth, and imparts to successive generations the spotless records of real knowledge. It is the function and felicity of Science to improve, in proportion to its cultivation, the general condition of all mankind; to first ameliorate and then eliminate the ferocities of savage life; and to foster deep-seated feelings of fraternity among all peoples. From the birth of Science in barbaric times through its stages of slow and almost imperceptible progression toward the present, its beneficent effects are plainly evident; and the historian clearly sees that wherever even chance and imperfect rays from the sun of knowledge illuminated the darkness and desolation of ignorance in which the world lay for ages, there prosperity and happiness took root and grew up and flourished. It was but a few times fifty years ago that Science and Art were borne still in infancy across the Atlantic to find an asylum on western shores; yet under the fostering care of organizations such as this Academy they developed apace; and to-day the triumphs of Science are in our hands as means of every day existence. The New World is the world of invention; the prairie schooner gave way to locomotive and automobile, the clumsy candlestick and ill-smelling snuffers to the

cleanly incandescent bulb, and the telegraph and telephone rose to extend our senses in such manner that the whole world opens before us as a picture unveiled. In this great development the Saint Louis Academy of Science has done its share. I have watched your officers unfold the history of this organization from its beginning a half-century ago; have noted the principles which governed the original members, and watched the ways in which their work and that of their successors was performed; and I feel that the utility of this organization has exceeded the most sanguine expectations of its founders, and that all kindred but younger institutions owe Saint Louis Academy a debt too large for ready payment. Our city and State are the better for the work of your body. On behalf especially of the Missouri Historical Society I extend congratulations on the brilliant close of your first half-century and express the hope that our relations may remain intimate, harmonious, fraternal, and mutually beneficial. We have with us about this banquet board poets to picture the Golden Age, artists to outline bright ideals, scientists to analyze nature and bring it within our ken; at my side is an anthropologist, who might point out the steps of progress from the condition of Man Primeval to that of Man the Conqueror of Nature; there are those with us who comprehend those principles of government that tend to unite men in impregnable nations; there are with us authorities on moral and educational institutions, within whose ken lies the power to inspire the human mind and heart with principles of patriotism and virtue; and still others who have helped to harness the lightning and control the powers of the air. Greece in her brightest day would have deified the discoverer of the circulation of the blood; yet there are with us those who count the red and white corpuscles of the life-giving fluid and trace the microscopic germs by which its flow is affected and our lives curtailed or prolonged, and it has been my pleasure to associate with members of this body who have helped to make the rough and rugged hills to laugh like the smoothest valleys in fruitful harvests and to make the barren plains blossom as the garden of roses. So I rejoice in your presence and am glad in meeting

face to face the members of your body who are makers of knowledge and hence of human progress. Long may the Academy live; many be its anniversaries; and ever be its success the pride of Saint Louis and the boast of Missouri: may the history and example of the organization as related and displayed tonight be handed down from generation to generation to the credit and renown of Science! I congratulate you, and in the language of my ancestors I greet you

“*Slainte doibh uille.*”*

MR. HURTER: —

Gentlemen, Members of The Academy of Science of St. Louis and Honorable Guests: — In addressing you to-night I do so, not as a member of the Academy, but as a delegate of the Naturalists' Club of St. Louis. The Club has honored me as the bearer of heartiest sympathies and good wishes towards the Academy of Science. We not only appreciate what the Academy has achieved in the past fifty years, but we hope that in the next half century the Academy will grow to be a much larger body so as to be enabled to carry the results of scientific research and exploration into wider and wider fields. I can assure the Academy that the Naturalists' Club will always work hand in hand with the members of the Academy of Science to its fullest extent and we hope that in the next fifty years the sympathies which unite the two organizations may become very close, founded upon the same love for scientific studies.

PROFESSOR COULTER: —

The Biological Society of Saint Louis, probably the youngest scientific society represented here to-night, desires to present its congratulations to the oldest, the Academy of Science. We sincerely hope that the long and useful career of the Academy, a career whose influence has always been particularly stimulating to younger societies like ours, may be but the prophecy of a much longer and still more helpful

* Health to you all.

future. We esteem it a high honor to be invited to participate in these anniversary exercises and we take great pleasure in bringing our most cordial greetings to add to the many already received.

DR. HUNICKE: —

Mr. Toastmaster and Gentlemen: — The St. Louis Chemical Society offers greetings to The Academy of Science of St. Louis. In behalf of my society I extend the best wishes for your future welfare and sincerely hope that you may be permitted to continue your admirable work for many generations to come.

JUDGE TERRY: —

Mr. President, Ladies and Gentlemen: — As a representative of the youngest among the educational and scientific institutions of Saint Louis, I am especially glad to extend greetings to the oldest scientific organization of this city. The Academy of Science has had a most notable career; it has worked quietly but effectively; its workers have, without exception, stood for the best interests of the city and State; and the influence of the Academy has always been beneficial. On the work and influence of the Saint Louis Academy it would be impossible to improve; but some of our citizens are to-day endeavoring to extend these methods and widen these influences in such manner that they may be felt by our entire people. This is the aim of Saint Louis Public Museum, an institution whose founders are led by the example and inspired by the success of the Academy. On behalf of these founders I extend congratulations to the Saint Louis Academy of Science on its half-century of usefulness, and heartiest wishes for other half-centuries of still greater beneficence.

MR. SAMPSON: —

At this late hour I will take only a few minutes of your time, and that only to briefly introduce to you the society that I represent, a society that is perhaps younger than any other that has been presented to you to-night. The State

Historical Society of Missouri was organized in 1898 by the Missouri Press Association, and was made a trustee of the State by the Legislature in 1899. Its object is "the collection, preservation, exhibition and publication of material for the study of history, especially the history of the State and of the Middle West;" and to this end it collects documents and manuscripts, conducts a historical library, and maintains a historical museum. In the short time since its organization it has been very successful in these objects, and now has a library of not less than 30,000 titles, with duplicates of an equally large number of publications. The library is now larger than any other State Historical Society in the Union had when it was of the same age as this is now. It receives, binds and preserves 760 periodicals of Missouri regularly, a number in excess of that of any other Historical Society. It has more of the official publications of the State than any other library; more publications made by Missouri authors, and more of the local publications relating to different parts of the State, and is fortunate in having a complete set of the publications of this Academy.

For some years its collection of publications has increased on an average of more than 1,000 per month in addition to its periodicals.

The Society had two large exhibits at the World's Fair; one of works by Missouri authors numbering more than 1,800 publications, and the other of the periodicals of Missouri for the year 1903. For these exhibits the Society was given a Grand Prize. The Society has many manuscripts of great importance which it will publish in the future as an important contribution to the history of the West, and it extends its good wishes to the Academy in its investigations of the scientific questions arising in the same part of our country.

MR. CHAPLIN: —

Had there been an opportunity at the dinner commemorating the fiftieth anniversary of the Academy of Science, I should have been very glad to present the congratulations of Washington University to the Academy on its long life

and good service in the cause of science. I believe that the Academy of Science has been of great benefit to this community. It has brought together workers in all fields of science. It has encouraged them to carry on their special investigations, and through its publications it has kept them in touch with scientific men in all parts of the world. The purpose of a University is to educate men in all departments of knowledge; the purpose of the Academy is to give educated scientific men an opportunity to carry on their researches and to encourage them in so doing, as well as to make their works known and to encourage others to follow in their paths.

I wish most heartily that the generous citizens of St. Louis would assist the Academy in its good work. Its collections ought to be in a fireproof building, and its work ought to be supported by generous endowments. I trust that long before the end of a century of its work, it will be provided with these necessities.

THE TOASTMASTER: —

I hold in my hands a great many other messages which I should like to deliver to you this evening. They have been coming to us continually until a few hours ago, with words of most cordial greeting from European societies. Unfortunately we cannot now stop to read them. They include words of cheer from Academies of Science in Paris, Berlin, Rome, Vienna, St. Petersburg. All of the great societies of Europe and many of our own country have sent letters and cable messages

Now, gentlemen, I have to thank you, all those who have come to us from other States, and from our own societies, for your presence here.

ADJOURNMENT.

SOCIETIES SENDING DELEGATES OR MESSAGES.

- Academia Romana. Bukarest, Roumania.
- Académie d'Amiens. Amiens, France.
- Académie de Stanislas. Nancy, France.
- Académie des Sciences. St. Petersburg, Russia.
- Académie des Sciences. Toulouse, France.
- Académie des Sciences et Lettres. Montpellier, France.
- Académie Internationale de Géographie Botanique. Le Mans, France. (*William Trelease*).
- Académie National. Reims, France.
- Academy of Natural Sciences. Philadelphia, Pa.
- American Academy of Arts and Sciences. Boston, Mass. (*William Trelease*).
- American Chemical Society. (*John H. Long*).
- American Entomological Society. Philadelphia, Pa.
- American Geographical Society. New York, N. Y.
- American Museum of Natural History. New York, N. Y.
- American Pharmaceutical Association. Baltimore, Md. (*Henry M. Whelpley*).
- American Philosophical Society. Philadelphia, Pa. (*William Trelease*).
- American Physical Society. (*Francis E. Nipher*).
- American Society of Naturalists.
- Association Française pour l'Avancement des Sciences Paris, France.
- Association Internationale des Botanistes. Leiden, Netherlands. (*Hermann von Schrenk; William Trelease*).
- Australian Museum. Sydney, N. S. W.
- Bataafsch Genootschap der Proefondervindelijke Wijsbegeerte. Rotterdam, Netherlands.
- Berwickshire Naturalists' Club. Alnwick, England.
- Boston Society of Natural History. Boston, Mass. (*William Trelease*).
- Botanical Society of America. (*Hermann von Schrenk*).
- Botanischer Verein der Provinz Brandenburg. Berlin, Germany.
- Bristol Naturalists' Society. Bristol, England.

- British Association for the Advancement of Science. London, England.
- British Museum (Natural History). London, England.
- Brooklyn Institute of Arts and Sciences. Brooklyn, N. Y.
- Buffalo Society of Natural Sciences. Buffalo, N. Y.
- Bureau of American Ethnology. Washington, D. C.
- Bureau of Geology and Mines of Missouri. Rolla, Mo. (*Ernest R. Buckley*).
- California Academy of Sciences, San Francisco, Cal.
- Cambridge Entomological Club. Cambridge, Mass.
- Canadian Institute. Toronto, Canada.
- Carnegie Institution of Washington. Washington, D. C.
- Carnegie Museum. Pittsburg, Pa.
- Chicago Academy of Sciences. Chicago, Ill. (*Thomas C. Chamberlin; W. K. Higley*).
- Chicago Historical Society. Chicago, Ill.
- Colorado College Scientific Society. Colorado Springs, Col.
- Connecticut Academy of Arts and Sciences. New Haven, Ct.
- Davenport Academy of Sciences. Davenport, Ia.
- Deutscher Verein zum Schutze der Vogelwelt. Gera, Germany.
- E. M. Museum of Geology and Archaeology. Princeton, N. J.
- Elisha Mitchell Scientific Society. Chapel Hill, N. C.
- Engelmann Botanical Club. St. Louis, Mo. (*Charles H. Thompson*).
- Engineers' Club of St. Louis. (*W. A. Layman*).
- Entomological Society of Ontario. London, Canada. (*William Lochhead*).
- Essex Institute. Salem, Mass.
- Faculté des Sciences. Marseille, France.
- Field Columbian Museum. Chicago, Ill. (*Oliver C. Farrington*).
- Franklin Institute of Pennsylvania. Philadelphia, Pa.
- Geological and Natural History Survey of Minnesota. Minneapolis, Minn. (*Conway MacMillan*).
- Geological and Natural History Survey of Wisconsin. Madison, Wis. (*Edward A. Birge*).

- Geological Society of Edinburgh. Edinburgh, Scotland.
(*W. M. Davis**).
- Geological Survey of Alabama. University, Ala.
- Geological Survey of Canada. Ottawa, Canada.
- Geological Survey of New Jersey. Trenton, N. J.
- Geological Survey of New South Wales. Sydney, N. S. W.
- Goodsell Observatory, Northfield, Minn.
- Harvard College Observatory. Cambridge, Mass.
- Institut de France. — Académie des Sciences. Paris, France.
- Institut Agronomique de Moscow. — Observatoire Météorologique. Moscow, Russia.
- Institut National Agronomique. Paris, France.
- Institut National Génevois. Geneva, Switzerland.
- Institute of Jamaica. Kingston, Jamaica.
- Instituto Médico Nacional. México, Mex.
- Iowa Academy of Sciences. Des Moines, Ia. (*Louis H. Pammel*).
- Jardin Impérial de Botanique. St. Petersburg, Russia.
- K. K. Centralanstalt für Meteorologie. Vienna, Austria.
- Kaiserliches Gesundheitsamt. Berlin, Germany.
- Királyi Magyar Természettudományi Társulat. (Royal Hungarian Society of Natural Sciences.) Budapest, Hungary.
- Königlich-Preussische Akademie der Wissenschaften. Berlin, Germany.
- Königlicher Botanischer Garten und Museum. Berlin, Germany.
- Koninklijke Akademie van Wetenschappen. Amsterdam, Netherlands.
- Kosmos: Gesellschaft der Naturfreunde. Stuttgart, Germany.
- Lick Observatory. Mt. Hamilton, Cal.
- Magyar Tudományos Akadémia. Budapest, Hungary.
- Marine Biological Laboratory. Woods Holl, Mass.
- Maryland Geological Survey. Baltimore, Md.
- Medicinisch-Naturwissenschaftliche Gesellschaft. Jena, Germany.
- Missouri Botanical Garden. St. Louis. Mo. (*William Trelease*).

* Unavoidably absent.

- Missouri Historical Society. St. Louis, Mo. (*James A. Reardon*).
- Museum Carolino-Augusteam. Salzburg, Austria.
- Museum of Comparative Zoology. Cambridge, Mass.
- National Academy of Sciences. Washington, D. C. (*William Trelease*).
- National Geographic Society. Washington, D. C. (*W J McGee*).
- Natural History Society of New Brunswick. St. John, N. B., Canada.
- Natural History Society of Northumberland, Durham and Newcastle-upon-Tyne. Newcastle-upon-Tyne, England.
- Naturalists' Club of St. Louis. St. Louis, Mo. (*Julius Hurter*).
- Naturforschende Gesellschaft. Emden, Germany.
- Naturforschende Gesellschaft. Freiburg, Germany.
- Naturforschende Gesellschaft. Görlitz, Germany.
- Naturforscher Gesellschaft bei der Kaiserlichen Universität. Dorpat-Jurjev, Russia.
- Naturhistorische Gesellschaft. Nürnberg, Germany.
- Naturwissenschaftliche Gesellschaft. Chemnitz, Germany.
- Naturwissenschaftlicher Verein für Schleswig-Holstein. Kiel, Germany.
- Nederlandsche Dierkundige Vereeniging. Leiden, Netherlands.
- New York Academy of Sciences. New York, N. Y. (*William B. Potter**).
- Nova Scotian Institute of Science. Halifax, N. S., Canada.
- Numismatic and Antiquarian Society. Philadelphia, Pa.
- Observatorio Astronomico Nacional Mexicano. Tacubaya, Mexico.
- Oesterreichischer Reichsforstverein. Vienna, Austria.
- Offenbacher Verein für Naturkunde. Offenbach, Germany.
- Peabody Museum. Salem, Mass.
- Peabody Museum of Archaeology and Ethnology. Cambridge, Mass.
- Philosophical Society of Washington. Washington, D. C. (*W J McGee*).

* Unavoidably absent.

- Physikalisch-Oekonomische Gesellschaft. Königsberg, Germany.
- Portland Society of Natural History. Portland, Me.
- Real Academia de Ciencias Exactas, Físicas y Naturales. Madrid, Spain.
- R. Accademia dei Lincei. Rome, Italy.
- R. Accademia di Scienze, Lettere ed Arti. Modena, Italy.
- Regia Societas Scientiarum. Upsala, Sweden.
- Rijks Observatorium. Leiden, Netherlands.
- Royal Geographical Society. London, England. (*William Libbey**).
- Royal Geographical Society of Australasia. Brisbane, Queensland.
- Royal Irish Academy. Dublin, Ireland.
- Royal Society of Canada. Ottawa, Canada.
- Smithsonian Institution. Washington, D. C.
- Sociedade de Geographia. Lisbon, Portugal.
- Société Centrale Forestière de Belgique. Brussels, Belgium.
- Société d'Émulation du Département des Vosges. Épinal, France.
- Société de Physique et d'Histoire Naturelle. Geneva, Switzerland.
- Société des Lettres, Sciences et Arts. Bar Le Duc, France.
- Société des Sciences. Nancy, France.
- Société des Sciences Physiques et Naturelles. Bordeaux, France. (*William Trelease*).
- Société Fribourgeoise des Sciences Naturelles. Fribourg, Switzerland.
- Société Géologique de Belgique. Liège, Belgium.
- Société Impériale des Naturalistes. Moscow, Russia.
- Société Nationale Académique. Cherbourg, France.
- Société Nationale des Sciences Naturelles et Mathématiques. Cherbourg, France.
- Société Scientifique Industrielle. Marseille, France.
- St. Louis Biological Club. St. Louis, Mo. (*Samuel M. Coulter*).
- St. Louis Chemical Society. St. Louis, Mo. (*Henry A. Hunicke*).

* Unavoidably absent.

- St. Louis Public Museum. St. Louis, Mo. (*John H. Terry*).
- State Historical Society of Missouri. Columbia, Mo. (*F. A. Sampson*).
- U. S. Coast and Geodetic Survey. Washington, D. C.
- U. S. Department of Agriculture.—Bureau of Biological Survey. Washington, D. C. (*A. K. Fisher* *).
- U. S. Geological Survey. Washington, D. C. (*Joseph A. Holmes* *).
- U. S. Naval Observatory. Washington, D. C.
- Verein für Erdkunde. Dresden, Germany.
- Verein für Erdkunde. Leipzig, Germany.
- Verein für Erdkunde. Metz, Germany.
- Verein für Geographie und Statistik. Frankfurt am Main, Germany.
- Verein für Naturkunde. Cassel, Germany.
- Verein für Naturwissenschaft. Braunschweig, Germany.
- Verein für Siebenbürgische Landeskunde. Hermannstadt, Austria.
- Verein zur Verbreitung Naturwissenschaftlicher Kenntnisse. Vienna, Austria.
- Washburn Observatory. Madison, Wis.
- Washington University. St. Louis, Mo. (*W. S. Chaplin, S. M. Coulter, Otto Heller, A. S. Langsdorf, F. E. Nipher, Wm. Trelease, J. L. Van Ornum, C. M. Woodward*).
- Wetterauische Gesellschaft für die Gesamte Naturkunde. Hanau, Germany.
- Wisconsin Academy of Sciences, Arts and Letters. Madison, Wis. (*Ernest R. Buckley*).
- Wisconsin Natural History Society. Milwaukee, Wis.
- Yale University Observatory. New Haven, Ct.
- Yorkshire Geological Society. Leeds, England.
- Zoological Society of Philadelphia. Philadelphia, Pa.
- Zoologisch-Botanische Gesellschaft. Vienna, Austria.

* Unavoidably absent.

CONSTITUTION.

ARTICLE I. NAME.

SECTION 1. This Association shall be called "The ACADEMY OF SCIENCE OF ST. LOUIS."

ARTICLE II. OBJECT.

SECTION 1. It shall have for its object the promotion of science.

SEC. 2. As means to this end the Academy shall hold meetings for the consideration and discussion of scientific subjects; shall take measures to procure original papers upon such subjects; and shall, as often as may be practicable, publish its transactions. It shall also establish and maintain a cabinet of objects illustrative of the several departments of science, and a library of works relating to the same. It shall also place itself in communication with other scientific institutions.

ARTICLE III. MEMBERS.

SECTION 1. The Academy shall consist of *Active Members*, *Corresponding Members*, *Honorary Members*, and *Patrons*.

SEC. 2. *Active Members* shall be persons interested in science, and they alone shall conduct the affairs of the Academy.

SEC. 3. Persons not living in the City or County of St. Louis who may be disposed to further the object of the Academy by original researches, contributions of specimens, or otherwise, may be elected *Corresponding Members*.

SEC. 4. Persons not living in the City or County of St. Louis may be elected *Honorary Members* by virtue of their attainments in science.

SEC. 5. Any person conveying to the Academy the sum of

one thousand dollars (\$1,000), or its equivalent, may be elected a *Patron*.

SEC. 6. Persons may be admitted to any of the preceding classes of membership, or dismissed therefrom in accordance with the regulations prescribed by the By-Laws.

ARTICLE IV. OFFICERS.

SECTION 1. The officers of the Academy shall be chosen from the active members, and they shall consist of a

President,
 1st Vice-President,
 2d Vice-President,
 Recording Secretary.
 Corresponding Secretary.
 Treasurer,
 Librarian,
 Three Curators,
 Two Directors.

Said officers shall be elected at the time and in the manner prescribed by the By-Laws, and shall hold their offices for one year, or until their successors are elected.

SEC. 2. The duties of these officers shall be such as are customary and as prescribed by the By-Laws.

ARTICLE V. COUNCIL.

SECTION 1. The officers shall constitute the Council of the Academy and at its meetings five shall constitute a quorum.

SEC. 2. The duties of the Council shall be to consider all plans conducive to the welfare of the Academy; to audit all bills and order payment of such as they may approve; to consider all applications for membership; and to administer the business of the Academy, subject to the Constitution and By-Laws and to such instructions as may be given by the Academy.

ARTICLE VI. MEETINGS.

SECTION. 1. The meetings of the Academy shall be held at such times and places as the By-Laws may direct.

ARTICLE VII. AMENDMENTS.

SECTION 1. Amendments to this Constitution shall be submitted in writing at a regular meeting. They shall be open to discussion until at least the second meeting thereafter. They may then be adopted by a two-thirds vote of a letter-ballot, conducted in the manner prescribed by the Council.

ARTICLE VIII. SECTIONS.

SECTION 1. To encourage and promote special investigations in any branch of science, members of the Academy may form Sections which shall be constituted as herein provided.

SEC. 2. For the formation of a Section written application shall be made to the Academy, at a regular meeting, by not less than six active members.

On the approval of this application by the affirmative vote of two-thirds of the members present at the next regular meeting, the Section shall be established and the names of the petitioners shall be recorded on its minutes as its founders.

SEC. 3. Sections may increase the number of their members by election, but only members of the Academy shall be elected members of any of the Sections.

SEC. 4. The officers of each Section shall be a Chairman and a Secretary, who shall be elected by its members at the first meeting of the Section, and subsequently at the first meeting in January of each year.

SEC. 5. The collections and books of each Section are the common property of the Academy. Donations of books and specimens made to or for any Section shall be received as donations to the Academy for the use of the Section.

SEC. 6. A report of the proceedings of each Section shall be submitted to the Academy at least once every month. Papers read before any Section with a view to publication by the Academy shall take the same course as papers read before the Academy.

SEC. 7. On all points not herein provided for, each Section shall be governed by the Constitution, By-Laws, and instructions of the Academy.

BY-LAWS.

I. REGULAR MEETINGS.

The regular meetings of the Academy shall be held on the first and third Monday evenings of every month, unless otherwise ordered by the Council.

II. SPECIAL MEETINGS.

Special meetings may be called by the President at his discretion, and shall be called by him on the written request of three or more members.

III. NOTICE OF MEETINGS.

The Recording Secretary shall send a notice of each meeting to every active member at least two days before such meeting.

IV. QUORUM.

Seven members shall constitute a quorum, but four members shall constitute a legal meeting for reading of papers.

V. ORDER OF BUSINESS.

The order of proceeding, at the regular meetings of the Academy, shall be as follows: —

1. Minutes of last meeting.
2. Report of the Council.
3. Reports of Committees.
4. Report of the Corresponding Secretary.
5. Donations to the Museum and Library.
6. Written Communications.
7. Oral Communications.
8. Deferred Business.
9. New Business.
10. Elections.
11. Proposals for Membership.
12. Adjournment.

VI. CORRESPONDING SECRETARY.

It shall be the duty of the Corresponding Secretary to conduct the correspondence and report to the Academy.

VII. TREASURER.

The Treasurer shall collect all moneys due the Academy; be custodian of all its funds, and pay such bills against the Academy as the Council shall approve. The Treasurer shall deposit the moneys and invest the funds of the Academy in its name and by and with the advice of the Council. Besides his annual report to the Academy, the Treasurer shall make such further reports and statements concerning the financial affairs of the Academy as the Council may from time to time require. Before entering upon his duties, the Treasurer shall give bond in such sum as may be required by the Council.

VIII. LIBRARIAN.

The Librarian shall take charge of all books belonging to or deposited with the Academy, and shall be responsible for the same; he shall keep a catalogue thereof, in which the names of contributors shall be inscribed; he shall superintend the distribution of all the publications of the Academy.

IX. COUNCIL.

The Council shall act as a publication committee; shall prepare a program for each meeting, and make rules and regulations for their own guidance, not inconsistent with the Constitution and By-Laws.

X. ELECTION OF OFFICERS.

A nominating committee of three active members who are not officers of the Academy shall be elected at the first regular meeting in December. This committee shall nominate candidates for all the offices for the ensuing year, and report the nominations at the following meeting, when other nom-

inations may be made by any active member. The Recording Secretary shall mail to every active member a list of the nominees for office, at least ten days preceding the annual meeting. The polls shall be closed at 6 p. m. on the day of the annual meeting, after which the nominating committee shall count the ballots and announce the results to the Academy. A plurality of the votes cast shall suffice to elect.

XI. VACANCIES.

All vacancies shall be filled by the Council in a regular or called meeting, notice whereof having been given at least two days previously.

XII. ELECTION OF MEMBERS.

A candidate for admission to the Academy shall be proposed by not less than two members at any regular meeting. The proposal must then be referred to the Council, and if upon examination they shall find the candidate to be eligible and worthy of membership, they shall order the question as to his admission to be submitted to the Academy by ballot. If there be five votes in the negative, the candidate shall be rejected, and shall not be again voted upon for twelve months after such rejection. But if the number of negative votes be less than five, the candidate shall be elected, but shall not be considered a member until he shall have paid the initiation fee and the annual dues for the current year. Any failure to pay the initiation fee and annual dues within thirty days after the candidate has been notified of his election, shall work a forfeiture of all rights under said election, if the Council shall so determine. No entry shall be made on the record of the rejection of any candidate.

XIII. RESIGNATION OF MEMBERS.

Any member whose dues have been fully paid, may withdraw from the Academy by a written resignation. Non-payment of dues for one year or longer may be treated as equivalent to resignation; but before any member is dropped from

the rolls for delinquency, he shall be entitled to not less than four weeks' notice.

XIV. EXPULSION OF MEMBERS.

Upon the written request of five members, that, for cause stated, any member be expelled, the Council shall consider the matter, and if they deem it best, shall advise the member that his resignation will be accepted. He shall, however, have the right to demand and shall be given a copy of the charges against him, and shall have a reasonable time to present a written defense. The Council may then pass finally upon the matter, and if resignation has not been tendered, or a satisfactory defense made, may by an affirmative vote of four of their number expel the member, in which case they shall notify him and the Academy of their action, and his name shall be at once dropped from the list of members.

XV. INITIATION FEE AND DUES.

Resident active members shall pay an initiation fee of five dollars, and annual dues of six dollars, payable at the beginning of each year. Non-resident active members shall pay an initiation fee of five dollars and annual dues of one-half the dues for resident active members, payable at the beginning of each year.

XVI. HONORARY MEMBERS AND PATRONS.

Honorary members and Patrons shall be recommended by the Council, and elected by the unanimous vote of the members present at any regular meeting.

XVII. PUBLICATIONS.

Patrons and all active members not in arrears shall be entitled to one copy of all the publications of the Academy issued subsequent to their election. Authors of papers shall be entitled to twenty extra copies of their individual papers.

XVII. SALE OF REAL ESTATE.

The property conveyed to The Academy of Science of St. Louis on the eighteenth day of March, 1903, by Edgar R. Hoadley and Lavinia L. Hoadley, as a gift from Mrs. Eliza McMillan and William N. McMillan, shall not be mortgaged or voluntarily incumbered by the Academy of Science; and the said property shall not be sold, except with the consent of two-thirds of the members of the Academy of Science, obtained by letter ballot, in such manner as may be prescribed by the Council; and, when sold, the proceeds of the sale or so much thereof as may be necessary, shall be used to provide a suitable location and building for the use of The Academy of Science of St. Louis.

XIX. AUTHORITY.

On all points of order and procedure, not provided for in the Constitution and By-Laws, *Robert's Rules of Order* shall be the authority.

XX. AMENDMENTS.

These By-Laws may be amended by two-thirds vote of all the members present at any regular meeting, provided notice of the proposed amendment shall have been mailed to every member at least one week before the vote thereon is taken.

ABSTRACT OF HISTORY.

ORGANIZATION.

The Academy of Science of St. Louis was organized on the 10th of March, 1856, in the hall of the Board of Public Schools. Dr. George Engelmann was the first President.

CHARTER.

On the 17th of January following, a charter incorporating the Academy was signed and approved, and this was accepted by a vote of the Academy on the 9th of February, 1857.

OBJECTS.

The act of incorporation declares the object of the Academy to be the advancement of science and the establishment in St. Louis of a museum and library for the illustration and study of its various branches, and provides that the members shall acquire no individual property in the real estate, cabinets, library, or other of its effects, their interest being usufructuary merely.

The constitution as adopted at the organization meeting and amended at various times subsequently, provides for holding meetings for the consideration and discussion of scientific subjects; taking measures to procure original papers upon such subjects; the publication of transactions; the establishment and maintenance of a cabinet of objects illustrative of the several departments of science and a library of works relating to the same; and the establishment of relations with other scientific institutions. To encourage and promote special investigation in any branch of science, the formation of special sections under the charter is provided for.

MEMBERSHIP.

Members are classified as active members, corresponding members, honorary members and patrons. Active member-

ship is limited to persons interested in science, though they need not of necessity be engaged in scientific work, and they alone conduct the affairs of the Academy, under its constitution. Persons not living in the city or county of St. Louis who are disposed to further the objects of the Academy, by original researches, contributions of specimens, or otherwise, are eligible as corresponding members. Persons not living in the city or county of St. Louis are eligible as honorary members by virtue of their attainments in science. Any person conveying to the Academy the sum of one thousand dollars or its equivalent becomes eligible as a patron.

Under the by-laws, resident active members pay an initiation fee of five dollars and annual dues of six dollars. Non-resident active members pay the same initiation fee, but annual dues of three dollars only. Patrons, and honorary and corresponding members, are exempt from the payment of dues. Each patron and active member not in arrears is entitled to one copy of each publication of the Academy issued after his election.

Since the organization of the Academy, 1,000 persons have been elected to active membership, of whom, at the present time, 240 are carried on the list. Four patrons, Mr. Edwin Harrison, Mrs. Eliza McMillan, Mr. William Northrop McMillan and Mr. Henry W. Eliot have been elected. The list of corresponding members (Vol. X., p. xii.) includes 226 names, among which are the names of 104 persons known to be deceased.

The presence of a number of eminent scientists from all parts of the world at the International Congress during the World's Fair of 1904, was considered a suitable occasion for electing the following gentlemen as honorary members of the Academy, in recognition of their valuable services to science: Prof. Svante Arrhenius (Stockholm), Prof. Dr. Leopold Bahlson (Berlin), Prof. Dr. Ludwig Boltzmann (Vienna), Señor Alfredo Chavero (Mexico), Prof. Theodor Escherich (Vienna), Prof. Shibasaburo Kitasato (Tokio), Geh. Ober Reg. R. Theodor Lewald (Berlin), Count Limburg-Stürum (Berlin), Prof. Henri Moissan (Paris), Geh. Rath Dr. Johann

Orth (Berlin), Prof. Wilhelm Oswald (Leipzig), Sir William Ramsay (London), Prof. Ernest Rutherford (Montreal), Prof. J. W. Van't Hoff (Berlin), Geh. Rath Prof. Dr. Wilhelm Waldeyer (Berlin), Prof. Dr. A. Wassermann (Berlin), Geh. Rath Prof. Dr. L. Wittmack (Berlin), from all of which courteous letters of acceptance were received.

OFFICERS AND MANAGEMENT.

The officers, who are chosen from the active members, consist of a President, two Vice-Presidents, Recording and Corresponding Secretaries, Treasurer, Librarian, three Curators, and two Directors. The general business management of the Academy is vested in a Council composed of the Officers.

The office of President has been filled by the following well-known citizens of St. Louis, nearly all of whom have been eminent in some line of scientific work: George Engelmann, Benjamin F. Shumard, Adolphus Wislizenus, Hiram A. Prout, John B. Johnson, James B. Eads, William T. Harris, Charles V. Riley, Francis E. Nipher, Henry S. Pritchett, John Green, Melvin L. Gray, Edmund A. Engler, Robert Moore, Henry W. Eliot, Edwin Harrison, and Adolf Alt.

MEETINGS.

The regular meetings of the Academy are held at its building, 3817 Olive Street, at 8 o'clock, on the first and third Monday evenings of each month, a recess being taken between the meeting on the first Monday in June and the meeting on the third Monday in October. These meetings, to which interested persons are always welcome, are devoted in part to the reading of technical papers designed for publication in the Academy's Transactions, and in part to the presentation of more popular abstracts of recent investigation or progress. From time to time public lectures, calculated to interest a larger audience, are provided for in some suitable hall.

The following dates for regular meeting for the year 1907 have been fixed by the Council: —

Jan.	Feb.	Mar.	April.	May.	June.	Oct.	Nov.	Dec.
7	4	4	1	6	3		4	2
21	18	18	15	20		21	18	16

LIBRARY.

After its organization, the Academy met in Pope's Medical College, where a creditable beginning had been made toward the formation of a museum and library, until May, 1869, when the building and museum were destroyed by fire, the library being saved. The library now contains 16,270 books and 15,026 pamphlets, and is open during certain hours of the day for consultation by members and persons engaged in scientific work.

PUBLICATIONS AND EXCHANGES.

Sixteen thick octavo volumes of Transactions have been published since the organization of the Academy, and widely distributed. Two quarto publications have also been issued: one from the Archaeological section, being a contribution to the archaeology of Missouri, and the other a report of the observations made by the Washington University Eclipse Party of 1889. The Academy now stands in exchange relations with 585 institutions or organizations of aims similar to its own.

MUSEUM.

After the loss of its first museum, in 1869, the Academy lacked adequate room for the arrangement of a public museum, and, although small museum accessions were received and cared for, its main effort of necessity was concentrated on the holding of meetings, the formation of a library, the publication of worthy scientific matter, and the maintenance of relations with other scientific bodies.

But now in possession of a suitable home, full attention can again be devoted to the museum, and the same is gradually growing.

RECORD.

FROM JANUARY 1, 1906, TO DECEMBER 31, 1906.

MEETING OF JANUARY 15, 1906.

The Academy of Science of St. Louis met in the Academy Building at 8:00 p. m., January 15, 1906; President A. Alt in the chair; attendance twenty.

The President read his annual report for the year 1905.*

The Treasurer presented the financial report and statement with vouchers, which were referred to an auditing committee, consisting of Messrs. A. H. Hunicke and A. S. Langsdorf.†

The annual report of the Librarian was submitted.‡‡.

The report of the Curators was read.§

The Nominating Committee reported the results of the Annual Election as follows: —

President.....	Adolf Alt.
First Vice-President.....	William Trelease.
Second Vice-President.....	Joseph Spiegelhalter.
Recording Secretary.....	Ernest P. Olshausen.
Corresponding Secretary.....	H. August Hunicke.
Treasurer.....	Enno Sander.
Librarian.....	G. Hambach.
Curators	G. Hambach.
	Frank Schwarz.
	Julius Hurter.
Directors.....	F. E. Nipher.
	Otto Widmann.

The amendments to Article V of the Constitution and to Article XI of the By-Laws were both adopted as proposed.

Mrs. Edwin Harrison donated portraits of Dr. Wm. M.

* Transactions, Vol. XV., Page xl.

† Transactions, Vol. XV., Page xlii.

‡‡ Transactions, Vol. XV., Page xliii.

§ Transactions, Vol. XV., Page xliv.

McPheeters and of Prof. Louis Agassiz, for which the thanks of the Academy were expressed.

Prof. F. E. Nipher offered a resolution, recommending the introduction in the United States of the metric system of weights and measures. The same was adopted and the Secretary instructed to sign for the Academy a petition to Congress to that effect.

FEBRUARY 5, 1906.

President Adolf Alt in the chair; attendance seventeen.

The Committee on the Semi-Centennial Celebration reported progress.

Dr. R. J. Terry presented a paper on "The Nasal Skeleton of *Amblystoma Punctatum*."

FEBRUARY 19, 1906.

President Adolf Alt in the chair; attendance thirty-two.

Dr. John Young Brown and Mr. Frank Collins Baker were elected to active membership.

Prof. J. F. Abbott delivered a lecture on "The Japanese Language and the Development of its Written System."

MARCH 5, 1906.

President Adolf Alt in the chair; attendance fifty.

Dr. W. C. G. Kirchner donated seven pamphlets on fossil botany.

Prof. F. E. Nipher presented on behalf of Mr. Edward S. Morse of the Peabody Museum in Salem, Mass., a pamphlet on fossil remains found in Missouri, written by Albert Koch and published in St. Louis in 1840.

Dr. W. E. Sauer was elected an active member.

The following papers on the history of the Academy during the fifty years of its existence were read:—

A Sketch of the History of the Academy. — Dr. H. M. Whelpley.*

* Vol. XVI No. 1, P. XX.

A Treasury Statement from the Beginning with mention of all gifts received by the Treasurer.—Dr. Enno Sander.†

A History of the Museum and Library.—Dr. G. Ham-bach. ††

An Account of its Publications and their Worth.—Prof. F. E. Nipher.

An Account of its Members who have attained Eminence either while here or after leaving St. Louis.—Prof. C. M. Woodward.

On motion of Prof. Trelease it was resolved that all guests at the dinner, representing corresponding societies and not already members, be elected corresponding members.

MARCH 19, 1906.

President Adolf Alt in the chair; attendance thirteen.

Prof. F. E. Nipher exhibited a new device for measuring the pressure of wind on buildings or of air in pipes.

Mr. F. Schwarz exhibited some specimens of centipedes, tarantulas and scorpions, showing the effect of climate on their development, those found in the South being much larger than those found in Missouri. Tarantulas are quite common at Cliff Cave and scorpions and centipedes at Mera-mec Highlands.

Dr. Wm. Trelease presented a specimen of a *Conularia*, found at Carthage, Mo., and presented by Judge Warwick Hough to the Academy.

Dr. N. M. Glatfelter exhibited some specimens of poisonous mushrooms of the family *Amonita*. He stated that the edible mushrooms were very common around St. Louis while the poisonous ones were very rare. He explained by drawings and colored plates how the poisonous *amonitae* can readily be distinguished, there being mainly three elements of distinction:—the annulus, the remnants of the universal veil, which appear as warts on top of the mushroom, and the poison cup near the bottom of the stem. None of these

† Vol. XVI. No 1, P. XXX.

†† Vol. XVI. No 1, P. XXXIII.

marks is found in the edible kind, while either one, two or all three are found in the poisonous kind.

APRIL 2, 1906.

President Adolf Alt in the chair; attendance twenty-three.

Mr. Charles P. Pettus, Dr. Theodore Ilg, Dr. Noah M. Glatfelter, Dr. W. B. Dorsett, Mr. Henry Boeckler, and Mr. Wm. J. Armbruster were elected active members of the Academy.

Mr. Andrew C. Life delivered a lecture on "Alternation of Generation and its Application to Evolution of Plants," illustrated by plants and lantern slides.

APRIL 16, 1906.

President Adolf Alt in the chair; attendance thirty.

Mr. Julian Bagby donated to the Academy a prehistoric Indian club, found fifteen miles south of New Haven, Mo. He stated that all the clubs found in his neighborhood were made of oolitic sandstone and were found in a kind of cistern covered over with a clay impervious to water.

Mr. Julius Hurter presented the following rare and curious reptiles and amphibia with explanations: —

A giant salamander of Japan (*Megalobatrachus maximus*, Schlegel), the largest species found.

A blind salamander of very small size (*Typhlomolge rathbuni*) found in 1896, 188 feet deep in an artesian well at San Marcos, Texas.

A Surinam toad (*Pipa americana*, Saurentius) of which species the female carries its young in small cavities on the back, where they develop from the eggs. This species is also called the Honey Comb Toad.

A Midwife toad (*Alytes obstetricans*, Saur.)

A tortoise shell turtle (*Chelone imbricata*, Linn.) as found in the warmer parts of the Atlantic, Pacific and Indian Oceans.

A flying lizard (*Draco solans*, Linn.). He described its

habits, showing that it does not actually fly, but leaps from tree to tree like the flying squirrel.

A Moloch (*Moloch horridus*, Gray), from West Australia, a dangerous looking but harmless creature, though its habits are little known.

A cobra snake (*Naja tripulians*, Merrem.) from Java, which in an upright position extends its neck to a kind of disk. It is found in southern India, Java, Sumatra, and is considered the most venomous snake.

An asp (*Aspis naja nage*, Linn.) from Tunis, Africa. It was known to the ancient Egyptians and its representations are found in old temples. Cleopatra is said to have used one of them for her suicide. The snake charmers of Morocco and Egypt use them in their performances, however, first removing the fangs.

MAY 7, 1906.

President Adolf Alt in the chair; attendance thirty.

The Secretary reported that the Academy had received five hundred dollars as a bequest from Mr. M. L. Gray, President of the Academy in 1896 and 1897.

The President presented a medal received from the "Société des Sciences Physiques et Naturelles de Bordeaux," struck in commemoration of the fiftieth anniversary of that society.

Mr. Julian Bagby delivered a lecture on "Natural and Artificial Springs and Pools of the Ozarks."

MAY 21, 1906.

President Adolf Alt in the chair; attendance thirty.

The Corresponding Secretary presented a medal conferred upon the Academy in honor of its fiftieth anniversary by the Académie Internationale de Géographie Botanique."

A collection of minerals and Indian Clubs from Leslie, Franklin County, Mo., was presented by Mr. August Remmert of Leslie, Mo.

Miss Mary Klem read a paper by Mr. Otto Widmann, entitled "Introduction to a Preliminary Catalogue of the Birds of Missouri."

The introduction begins with acknowledgments to contributors for assistance. This is followed by a bibliography, which gives the titles of publications relating to birds of Missouri. The third chapter explains the scope of the catalog, which is a first attempt at listing all the species and subspecies found within the State, based chiefly on the observations of the author during the past twenty-eight years. It also explains why, in addition to the names of the American Ornithologists' Union's Check-List, are given the synonyms used by Wilson, Audubon, Nuttall, Baird and Coues. It states that it was found advisable to prepare and include a detailed treatment of the geographic distribution of each species and subspecies in accordance with the latest sources of information. It explains the terms used to indicate seasonal occurrence and relative abundance, and says that no attempt is made to describe birds, as books of descriptive ornithology are numerous. Besides a statement of the range of the species in Missouri, dates of arrival and departure, manner of occurrence as regards season and abundance, the catalog contains such notes as may be helpful to the student in search of the rarer birds. Then follow chapters on Faunal Areas, Climate, Topography and Physical Conditions, Vegetation and at the close chapters on the Decrease of Birds and on Bird Protection.

JUNE 4, 1906.

President Adolf Alt in the chair; attendance twenty.

The following communication from Prof. G. C. Broadhead of Columbia, Mo., was read:—

“For twenty years I collected botanical specimens whenever I saw any interesting plants. I sent duplicates of these to Dr. Engelmann, who was always glad to get them, name them and write out the results in letters to me, with frequent interesting and important items. The Academy of Science might be pleased to receive these notes in the Doctor's handwriting, with his own signature. I therefore present them to the Academy.”

(Signed) G. C. BROADHEAD.

Enclosed were a number of letters written by Dr. Engelmann from 1864 to 1884. The same were accepted by the Academy and its thanks expressed therefor.

Dr. H. M. Whelpley presented a stone slab from Lyons, Colorado, covered with Dendrites. The thanks of the Academy were extended to the donor.

Dr. H. M. Whelpley also exhibited some interesting specimens of heretofore undescribed forms of Indian flint spades. Some of them were finely polished and showed remarkably denticulated and grooved edges, the origin of which is unexplainable, as they can hardly have been formed accidentally but appear rather to have been the result of some particular use, unknown to us.

Mr. Julius Hurter exhibited photographs of some caves in Sullivan County, Mo., recently visited by him. In one of them he collected twenty-three blind salamanders, about four inches long, which occur only in the caves of that section of the country. He also showed large centipedes and tarantulas found near the cave.

Mr. Frank Schwarz showed a very young ground hog alive.

Dr. Chas. D. Stevens presented a photograph of a Colorado Mountain Sheep.

Dr. Wm. Trelease exhibited specimens of the green-spored *Lepiota* (*Lepiota Morgani*) from the foot of Rascon Mountain, between San Luis Potosi and Tampico, Mexico, which he had received from Dr. Francis Eschangier of the former city. Attention was called to the fact that this record considerably enlarges the known range of this poisonous species of fungi, which, however, has already been reported from various localities between the District of Columbia, Michigan, Nebraska, Kansas, Eastern Texas, and Georgia, the probability being that it will be found through the moist belt, passing down the coast from Galveston to Tampico or further.

OCTOBER 15, 1906.

President Adolf Alt in the chair; attendance thirty-three.

The death of Dr. Ludwig Boltzmann of Vienna, an Honorary Member of the Academy, was reported and on motion

of Mr. H. A. Hunicke was referred to Prof. Nipher for proper action.

The following donations were reported:—

Mr. H. W. Eliot. — An Indian adze, a sledge hammer, a medicine man's mortar and pestle, and a salmon killer from Alaska, and a stone axe found in St. Louis.

Dr. Carl Barck. — Reports of the Illinois Geological Survey under A. H. Worthen, in nine volumes.

Mrs. Edwin Harrison. — Portrait of Mr. Edwin Harrison.

Ewald Iron Co. — Iron ore from Pilot Knob, Mo.

Julius Hurter. — Bird from the Philippines. (*Eurystomus orientalis*).

Dr. Edward Evers made an interesting report of a visit and exploration of a new cave in Crawford Co., Mo., four miles from Leesburg, called the Onondago Cave.

Mr. Julius Hurter reported on a trip through Marble Cave in Stone Co., Mo., where he collected many snakes, lizards and salamanders.

NOVEMBER 5, 1906.

President Adolf Alt in the chair; attendance twenty-nine.

The following resolution on the death of Dr. Ludwig Boltzmann of Vienna, an Honorary Member of the Academy, was presented by Prof. F. E. Nipher and adopted: —

“The Academy of Science of St. Louis has learned with deep regret of the death of Dr. Ludwig Boltzmann of Vienna, an Honorary Member of the Academy.

He was one who was invited to participate in the Congress of Science and Arts, held in St. Louis during 1904, during the Louisiana Purchase Exposition. His presence in our midst was selected by our Academy as the fitting occasion for showing its appreciation of the high service which he had rendered to the world, by electing him to Honorary Membership in the Academy.

The officers and members of the Academy feel, that in his death, in the prime of his powers, the world of science has lost one of its ablest and most advanced thinkers.”

The Corresponding Secretary announced the death of

Don Alfredo Chavero of Mexico, an Honorary Member, and of Dr. E. C. Chase, an active member.

Mr. Edward H. Bowie, in charge of the Weather Bureau in this city read a paper on "Predetermination of Paths of Centers of Cyclonic Areas," illustrated with lantern slides.

After a short introductory sketch of the pioneers of meteorology in the West whose works largely influenced the establishment of the Signal Service and later of the Weather Bureau, the speaker reviewed the writings of meteorologists, treating of the formation and structure of the atmospheric whirls or eddies, called cyclones. He discussed the work of Franklin, Redfield, Espy, Tracy, Coffin, Loomis, Ferrel and Bigelow, which resulted in establishing the following facts concerning the formation and structure of cyclones:—

1. That extra tropical storms are not local in their origin, but have their source in the heat that is transported from the tropics through horizontal currents near the earth's surface.

2. The formation of tropical cyclones or hurricanes is fully accounted for by the vertical convectional theory.

3. The aqueous vapor condensed into water and the latent heat liberated is an effect of, but not necessarily the cause of the formation of a cyclone, being, however, a great factor in intensifying the storm.

4. Observations do not show that abnormal heat in a locality necessarily give birth to cyclones.

5. Cyclones are whirling masses of atmosphere, whose horizontal diameter may be more than four or five miles, except in the cases of tropical storms where it is greater.

The speaker then discussed the forces that propel a storm after it is established. After reviewing the work of such eminent men as Loomis, Abercromby, Ley, Eliot, Rosser, Abbé, Bigelow and Garriott, he discussed at length a method for determining the direction of a storm and its rate of progress as worked out by himself. His method is based upon the assumption that "storms are eddies carried along by the general eastward drift, but having their direction and rate of progression modified by the flow of air from adjacent areas of high pressure."

NOVEMBER 19, 1906.

President Adolf Alt in the chair; attendance sixteen.

Dr. Launcelot W. Andrews read a paper on "Phonetics and Bell's System of Visible Speech," describing the methods of forming the various sounds of speech, not only of the English but of other languages.

DECEMBER 3, 1906.

President Adolf Alt in the chair; attendance forty-three.

Dr. C. H. Shutt, Prof. M. E. McCourt and Mr. Alexander Del Mar were elected active members of the Academy.

Prof. A. S. Langsdorf, Dr. Chas. D. Stevens and Dr. D. S. H. Smith were elected as a Nominating Committee, to prepare a ticket for the annual election.

Dr. N. M. Glatfelter delivered a lecture on "Edible Mushrooms," illustrated with specimens.

Dr. E. A. Cammon of Toronto, Canada, presented a series of fossils collected at Water Works Knob in Columbia, Tennessee, a new locality for collecting. All of the fossils found seem to have been inhabited by parasites. Dr. Cammon donated a full series of the Brachiopoda typical of that locality to the Academy. On motion of Dr. C. D. Stevens the collection was accepted and the thanks of the Academy voted the donor.

DECEMBER 17, 1906.

President Adolf Alt in the chair; attendance twenty-four.

The Nominating Committee reported the following ballot for the annual election, which was ordered printed and mailed to the members: —

- PresidentC. M. Woodward
- First Vice-President.....Arthur Thacher
- Second Vice-President.....Joseph Spiegelhalter
- Recording Secretary.....James A. Harris
- Corresponding Secretary.....H. A. Hunicke
- Treasurer.....Enno Sander
- Librarian.....G. Hambach
- Curators.....G. Hambach
- F. Schwarz
- Julius Hurter
- Directors.....F. E. Nipher
- J. H. Kinealy

Dr. M. A. Goldstein gave a demonstration of the Oto-Projectoscope.

REPORTS OF OFFICERS FOR THE YEAR 1906.

The President addressed the Academy as follows:—

GENTLEMEN: Again being called upon to make the annual report as your president, I can only repeat what I stated last year at the same occasion that we have for another year striven to live up to the exalted aims and purposes for the realization of which this Academy of Science has been founded.

Our regular lectures have been highly interesting and instructive. The year's volume of Transactions contains seven scientific papers which will surely not fail to impress the world of science in their respective special branches with the work done by and through the agency of our Academy.

The attendance at the lectures was very slightly larger than last year, 406 in 1906 against 404 in 1905. Fifteen meetings were held. The largest attendance was noted on March 5th (59), the smallest, 12, on March 19th. Thus the average attendance in 1906 was about like that of 1905, twenty-seven. It is likely that if more lectures of a more general and popular character had been delivered, the attendance would have been larger, as it is but natural that the great majority of our members, who are not themselves engaged in work in some special scientific field, are not attracted by strictly scientific lectures.

The Academy always invites and gladly receives at its meetings guests from the outside. It has always seemed to me in this connection that such an invitation should only mean to apply to the scientific lecture and its discussion. As is now the custom, however, all of our family matters are, also, discussed in the presence of the outside guests. I do not think this should be the case and feel like suggesting that the order of business at our meetings be changed in such a manner as to correct this condition, which, while it has not yet, might at some occasion become very embarrassing.

Our museum which, thanks to our Curators is so well displayed in the large room on the third floor, has during this year again received numerous valuable donations. It is to be hoped that the Academy will in the near future be enabled to procure more cases, as there is still a quantity of valuable material stored away awaiting a chance for display.

In the same manner as the museum our library has grown considerably, not only by the numerous exchanges but also through many valuable gifts.

Death has again robbed the Academy of seven members:—two Honorary ones, Dr. Ludwig Boltzmann and Señor Alfredo Chavero, three active resident members, Dr. E. H. Gregory, Dr. E. C. Chase and Charles F. Miller, and two active non-resident members, Julien Reverchon and Dr. Jacob Schneck. This is a heavier loss than death has caused us for some years.

As far as numbers are concerned, the loss would have been more than counterbalanced by twenty-one new members which we elected during the past year, had it not been the painful duty of our Council to strike eighteen delinquents off the membership list. Our membership is now 385 as against 386 in 1905.

The most important event in the history of the past year was the celebration of the fiftieth anniversary of the birth of our Academy, which we celebrated in a manner befitting the occasion. The banquet with its feast of reason which had been so admirably arranged by your Committee, consisting of Professor Nipher, Dr. Spiegelhalter and Professor Trelease was of so elevating and enjoyable a character that no one whose privilege it was to be present will ever forget it. The memorial number of our Transactions, while giving a full and exact presentation of all that occurred at this memorable occasion, cannot replace what they have missed to those members of the Academy who for some reason were absent. Ninety-one guests graced the table and one hundred and fifty-seven sister societies from the world over had sent their greetings and a respectable number of them were represented by delegates. The Academy may well feel happy and proud of these signs of recognition of its work. May it, when another fifty years have gone by, have ever more and more succeeded in realizing the high ideals which the men had in view who founded this institution.

It will be my pleasant duty this evening to hand over the presidency of the Academy to other and worthier hands. But, before doing so, I wish to again thank the other officers of the Academy for their attention and zeal in managing its affairs and to express my deeply felt appreciation for the high honor which in your kindness you conferred upon me by electing me your president.

The Treasurer presented his report for the year 1906, showing the following recapitulation of accounts: —

RECEIPTS.	
To Balance Jan. 1, 1906.....	\$ 239 30
Collection of dues.....	1,262 50
Rents	695 00
Interest on investment.....	117 64
Mortgage	3,500 00
Certificate of deposit.....	1,000 00
Donations	550 00
Semi-Centennial collection.....	816 00
Sale of Semi-Centennial medals.....	7 65
	\$8,188 09
EXPENDITURES.	
By Printing of Transactions.....	\$ 680 22
Expenses of the Library.....	297 64
Salaries.....	1,080 00
Sundry expenses.....	882 05
Expenses of the Semi-Centennial.....	803 00
Certificates of deposit.....	1,000 00
Loan to Wandel.....	3,000 00
Interest.....	8 25
Discount on checks	3 40
Dividends on investments.....	303 90
Balance.....	129 63
	\$8,188 09

The Librarian made the following report: —

GENTLEMEN: I have the honor to submit my report as Librarian of the Academy of Science of St. Louis for the year 1906.

The accessions to the Library for the year are as follows: —

By exchange.....	602 volumes	736 pamphlets
By donation.....	14 “	45 “
	616 “	781 “

Publications were received from

Home Societies	96
Foreign Societies.....	238
	334

The Transactions of the Academy for the year were sent to

Home Societies.....	164
Foreign Societies.....	421
	585

Five (5) foreign and two (2) home societies were added to the exchange list and one (1) foreign and one (1) home society canceled, making a gain of four (4) foreign and one (1) home society or a total of five (5) on the exchange list.

The Academy sent a complete set of its Transactions and Memoirs as a gift to the California Academy of Science in San Francisco, whose library was destroyed in the earthquake and fire which visited California last spring.

During the year the following donations to the Library were received:—

Dr. Carl Barck: — A set of the reports of the Geological Survey of Illinois by A. H. Worthen in nine volumes.

Prof. G. C. Broadhead: — Letters on botanical subjects written to the donor by Dr. Geo. Engelmann, first President of the Academy.

Dr. W. C. G. Kirchner:—Seven pamphlets on fossil botany.

Dr. Edward S. Morse, Director of the Peabody Museum in Salem, Mass. — A pamphlet entitled “A short Description of Fossil Remains found in the State of Missouri”, by Albert Koch. Published in St. Louis in 1840.

Dr. Enno Sander: — Medical pamphlets and journals.

During the year the usual volumes were bound at a cost of \$48.85. Besides this, \$250.00 of the legacy of Mr. M. L. Gray were set aside by the Council for binding some of the older and more valuable sets of publications. Accordingly 341 volumes were bound for \$254.45.

It is hoped that the Council will see its way clear to make a similar appropriation for the year 1907, as the only way to properly preserve books not only on the shelves but in handling is to have them bound. If some of our valuable series are to be saved to future generations, they must be bound without delay as they will be beyond redemption in a short while. As they are now the volumes are unavoidably subjected to rough handling by readers, which only accelerates their gradual ruin. Another year should not be allowed to pass without steps being taken looking towards the elimination of this condition. Irreparable loss is gaining headway, and that which might be avoided is accumulating, carrying with it great expense which could be obviated by immediate attention.

In exchange for our Transactions we are receiving the publications of a great many institutions of learning throughout the world. In this way we are acquiring daily important additions to our Library, but I desire to again emphasize the lack of proper reference facilities. Our greatest need at present is books relating to the various branches of science. Without access to the literature of any scientific subject it is impossible for an investigator to proceed with his investigation or to obtain satisfactory results. It is very desirable that a sum of money be appropriated for this purpose annually.

During the year the systematic cataloging and indexing of our Library was begun.

Early in the year the Missouri Botanical Garden undertook the compilation of a list of the scientific periodicals to be found in the various libraries in St. Louis. The Academy joined in this undertaking as far as it was possible to do so. The value of such a list—the need of which has been felt for a long time—cannot be overestimated. By having such a list, showing where books may be consulted, the labors of the scientific workers of this great center will be greatly facilitated. It is hoped that there will be active co-operation among the libraries of this city in furnishing students with information as to the location of works which may be of special interest. Co-operation in making the literary treasures of a community available will do much towards advancing the interests of those laboring in the various fields of science.

RECEIPTS AND EXPENDITURES OF THE MUSEUM AND LIBRARY FOR THE YEAR 1906.

Expenses.

Postage.....	\$162 48	
Binding.....	48 85	
Books purchased.....	8 03	
Express, freight and drayage.....	15 01	
Insect cases.....	5 00	
Miscellaneous.....	71 48	\$310 85

Receipts.

Cash from Treasurer.....	\$233 14	
“ “ Transactions.....	75 52	
“ on hand Jan. 1, 1906.....	8 70	\$309 36
Balance due.....		\$1 49

The Curators reported as follows:—

GENTLEMEN: AS Curators of the Academy of Science of St. Louis we beg to submit the following report on the condition of the Museum for the year 1906.

During the year donations to the Museum were received from:—

Académie Internationale de Géographie Botanique du Mans: — A medal conferred upon the Academy in commemoration of the Golden Jubilee.

Julian Bagby: — An Indian stone club found fifteen miles south of New Haven, Mo.

Dr. E. A. Cammon of Toronto, Canada: — A series of fossil brachiopoda from a new locality recently unearthed at Water Works Knob in Columbia, Tennessee.

Mr. H. W. Eliot: — An Alaskan stone club, a salmon killer, used by the native fishermen of Alaska to kill salmon when caught, an Alaskan adze from Sitka, an Indian medicine man's mortar and pestle from Klinkman, Alaska, a map of the coast of Alaska, and a stone adze dug up on a clay field in 1879 at Grand and Chouteau Avenues in this city.

Ewald Iron Co.: — A large specimen of iron ore from Pilot Knob, Mo.

Mrs. Edwin Harrison: — Portraits of Mr. Edwin Harrison, late President of the Academy, Dr. Wm. M. McPheeters, one of the founders of the Academy, and Prof. Louis Agassiz.

Judge Warwick Hough: — A *Conularia* from Carthage, Mo.

Mr. Julius Hurter: — A bird (*Eurystomus orientalis*) from the Philippine Islands.

Mr. August Remmert: — An Indian club and minerals from Leslie, Franklin Co., Mo.

Société des Sciences Physiques et Naturelles de Bordeaux: — A medal struck in commemoration of the fiftieth anniversary of the organization of that Society.

Dr. Chas. D. Stevens: — A photograph of a Colorado Mountain sheep.

Dr. H. M. Whelpley: — A slab of Dendrites from Lyons, Colorado.

The most pressing need of the Museum is the means with which to procure cases for the exhibition of the collections we already possess. The time has come when the question of furnishing the Museum and of installing the exhibits properly becomes a matter of great importance. Cabinets suitable for displaying specimens must be provided. They should be made practically dust proof of plate glass and metal or hard wood, and should be adapted in every instance to the peculiar character of the collections which are to be displayed. We desire to urge upon the members of the Academy the vital importance of securing these pressing necessities. We hope that this matter will receive the consideration which it deserves to have bestowed upon it. Cases are as necessary in a museum as shelves in a library.

As the treasures of science accumulate the treasure house is more and more resorted to, not merely by the curious, who come to gratify the taste which all men possess for the strange and wonderful, but by those who are engaged in mastering the mysteries of nature and who, by their efforts, are adding to the store of human knowledge. Collections should not only be accessible to the public but should be arranged and supplied with descriptions, guides and references to the books in the Library. Every specimen in a museum should be labeled in such a way that every visitor, who comes to the museum for knowledge and improvement, may gain all the information the museum and library afford.

Our present collections are only the nucleus of the permanent museum, the re-establishment of which was auspiciously inaugurated upon our removal to our own home. Its maintenance and growth will depend mainly upon the financial support and material encouragement it will receive from the members of the Academy and from public-spirited citizens. But the time may come and let us hope it is not too far distant, when the Academy will be so liberally endowed that it can procure all these necessary things, and be in a position to extend far beyond its present bounds and to assume a wider scope of great usefulness.

JUL 26 1906

149

Transactions of The Academy of Science of St. Louis.

VOL. XVI. NO. 1.

**CELEBRATION OF THE FIFTIETH ANNIVERSARY
OF THE FIRST MEETING.**

Issued, July 23, 1906.

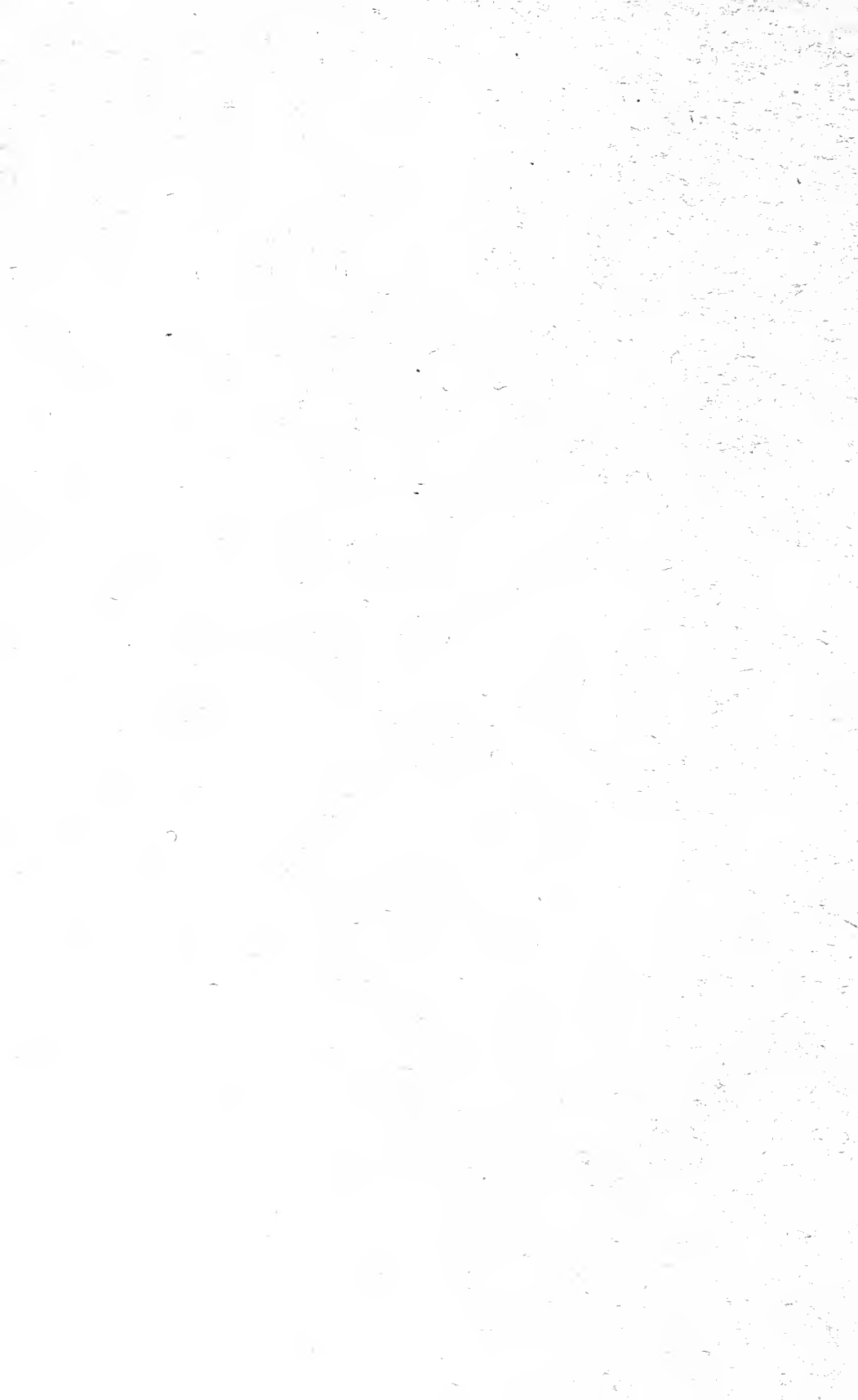

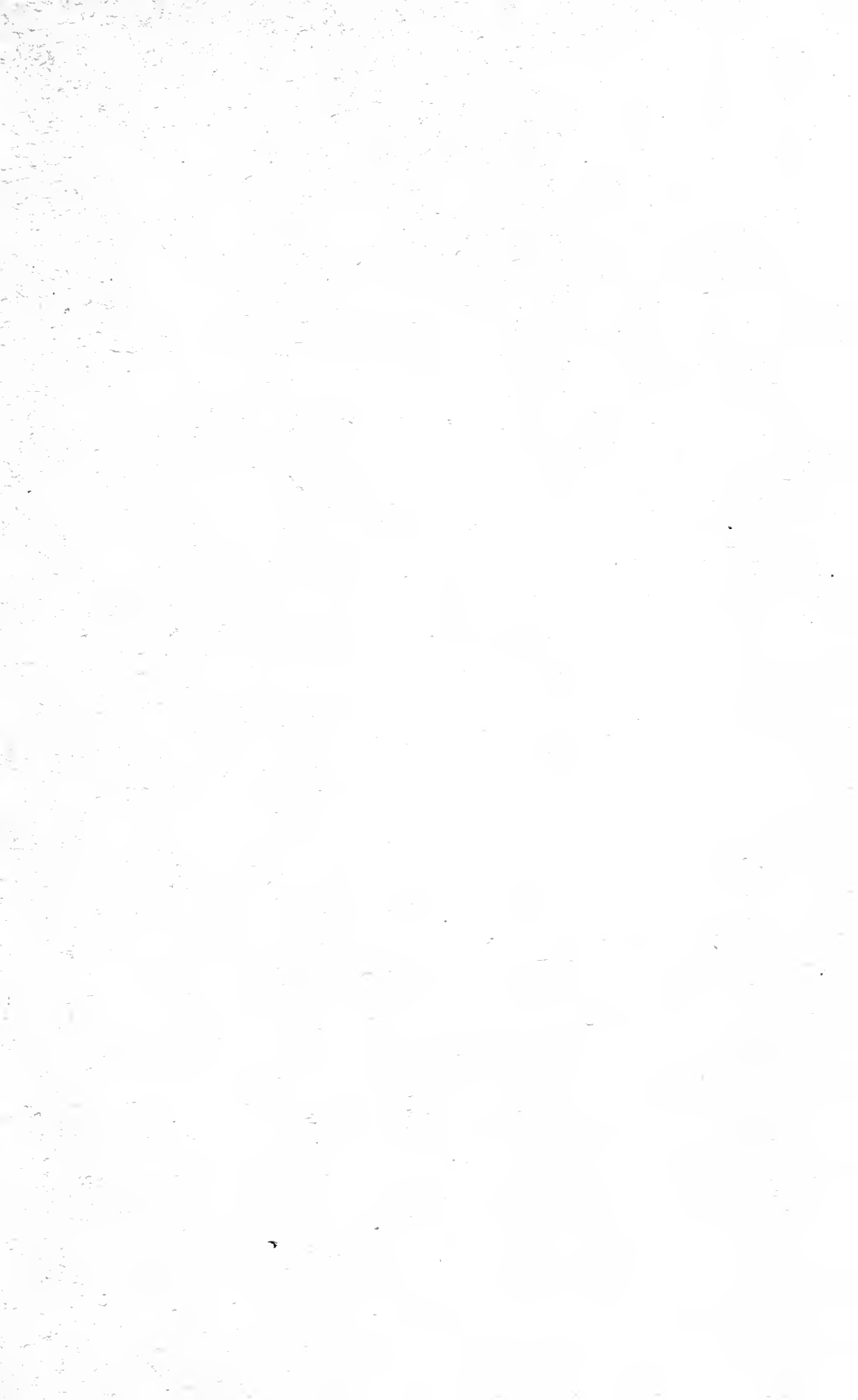

PUBLICATIONS.

The following publications of the Academy are offered for sale at the net prices indicated. Applications should be addressed to The Librarian, The Academy of Science of St. Louis, 3817 Olive St., St. Louis, Mo.

TRANSACTIONS (in octavo).

Vol.	Number.	Price per number.	Price per vol.	Price in set.
1	1*		
	2†	\$4.00	\$7.50	\$7.00
	3, 4	2.00 each.	(Nos. 2-4 only.)	(Nos. 2-4 only.)
2	1 to 3	2.00 each.	5.50	5.00
3	1 to 4	2.00 each.	7.50	7.00
4	1 to 4	2.00 each.	7.50	7.00
5	1-2, 3-4	4.00 each.	7.50	7.00
		(double numbers)		
6†	1, 2, 6, 8, 10, 11, 13, 17 4, 5, 7, 13, 14, 15, 18 3, 9 12	25 cts. each.	7.50	7.00
		50 cts. each.		
		75 cts. each.		
		\$1.00		
7†	2, 3, 4, 6, 7, 8, 13, 15, 16, 18, 19 5, 9 to 12, 14, 20 17 1	25 cts. each.	7.50	7.00
		50 cts. each.		
		75 cts.		
		\$1.00		
8†	1, 3 to 6 8, 10, 12 2, 7, 9, 11	25 cts. each.	3.75	3.50
		50 cts. each.		
9†	1, 3, 4, 7, 9 2, 5, 8 6	25 cts. each.	3.75	3.50
		50 cts. each.		
		\$1.25		
10†	9 2, 4, 5, 10 1 3, 6, 7, 8, 11	10 cts.	3.75	3.50
		25 cts. each.		
		40 cts.		
		50 cts. each.		
11†	2, 3 5-8, 10, 11 1 4 9	15 cts. each.	3.75	3.50
		25 cts. each.		
		45 cts.		
		75 cts.		
		1.00		
12†	1, 9, 10 5 3, 8 2, 4, 6, 7	25 cts. each.	3.75	3.50
		35 cts.		
		45 cts. each.		
		50 cts. each.		
13†	2, 3, 5-9 4 1	25 cts. each.	3.75	3.50
		75 cts.		
		1.50		
14†	2, 3, 6, 7 4, 8 5 1	25 cts. each.	3.75	3.50
		50 cts.		
		75 cts.		
		\$1.00		
15†	1, 3, 4, 5, 6 2	25 cts. each.	3.50	3.25
		50 cts. each.		
		\$1.50		

MEMOIRS (in quarto).

Contributions to the archaeology of Missouri, by the Archaeological Section. Part 1. Pottery. 1850. \$2.00.

The total eclipse of the sun, January 1, 1889. A report of the observations made by the Washington University Eclipse Party, at Norman, California. 1891. \$2.00.

* Supply exhausted.

† Can be sold only to purchasers of the entire volume,—so far as this can be supplied.

‡ Each number is a brochure containing one complete paper (or rarely two).

JUN 8 1906

149

Transactions of The Academy of Science of St. Louis.

VOL. XVI. NO. 2.

[No. 1, soon to appear, contains report of 50th anniversary.]

**NOTES ON A COLLECTION OF MOLLUSKS FROM
THE VICINITY OF ALPENA, MICHIGAN.**

FRANK COLLINS BAKER.

Issued, May 21, 1906.

NOTES ON A COLLECTION OF MOLLUSKS FROM
THE VICINITY OF ALPENA, MICHIGAN.*

FRANK COLLINS BAKER.

Some twenty-five years ago Dr. William A. Nason, of Algonquin, Illinois, made a large and somewhat exhaustive collection of the Mollusca which inhabit the vicinity of Alpena, Michigan. Unlike many collectors of that day (and later days, too, for that matter) he kept the different localities separate and preserved much interesting and valuable data. Dr. Nason has very kindly allowed the writer to make a careful study of the collection and on account of its completeness and exactness it has been thought that a catalogue of the collection, with notes, would be of considerable value to those who might have occasion to work up material from this region which might not be as abundant as the material now in hand.

Of the 48 species and varieties in the collection, 9 are land shells and 39 are fluviatile forms. This shows a very large preponderance of fluviatile over terrestrial species. The fresh water pulmonates comprise 75 per cent. (26 species and varieties) of the fluviatile forms; *Lymnaea* is represented by 10 and *Physa* by 8 species and varieties. The bivalves seem to be few in number, both as to species and individuals, and the tenobranchiates (*Goniobasis*, *Ammicola*, etc.) are but poorly represented. There are many interesting variations among the *Lymnaeas* and *Physas*, these variations being due, in part at least, to the various environments in which the different colonies lived.

The locality is situated in an interesting part of the country, the northern lakes, Superior and Huron, seeming to form particularly favorable environments for producing peculiar and characteristic forms of mollusks. The heavy, light-

* Presented by title to the Academy of Science of St. Louis, Jan. 15, 1906.

horn colored shells seem characteristic of these northern waters.

Dr. Nason has furnished the following notes on the particular habitats or environments where shells were collected. "Thunder Bay Island is one mile east of the north point of Thunder Bay. Here I found the shells in pools of water in ledges of limestone which are accessible to the waves of the lakes during storms or high water. Sugar Island is a low island between Thunder Bay Island and the main land, a little to the north. Following westwardly the north shore of Thunder Bay, Whitefish Point is about half way to the city of Alpena. Isaacson's farm includes a small creek which empties into Thunder Bay between Whitefish Point and the city of Alpena, about one mile inland. Thunder Bay River (Ox Bow) is about two miles from the mouth of the river, northwest of the city. Stony Point is about two miles south of the mouth of the river on the shore of the bay and is a low limestone beach.

"Sulphur Island is a small, low island near the southern point of Thunder Bay, about eight miles from the city of Alpena. Long Lake is about twelve or fifteen miles north of Alpena and its shores are mainly limestone rocks and low bluffs, except at the outlet of the creek which flows into Thunder Bay River. The shells were mainly collected on a broad, sandy beach about the outlet, and in from six inches to a foot of water.

"The change of localities gave the shells a difference in development which is very interesting. The contrast between the solid forms of Thunder Bay Island, where the waves and cool water of Lake Huron was almost daily forced into the pools where the shells developed; and the still, swampy pool where the Sugar Island *Lymnaeas* lived, where the shores were low, but protected from the rough storms of the lake, give a hint of conditions very interesting, biologically."

The collection bears out all that Dr. Nason has said concerning the biologic features, and a study of the material from a biometric standpoint would undoubtedly yield some very interesting results.

My thanks are due to Mr. Frank M. Woodruff, of the Chicago Academy of Sciences, for preparing the photographs for the plate which accompanies this paper, to Mr. Bryant Walker, Detroit, Mich., for identifying several species, and to Dr. Nason for the privilege of studying the collection.

SYSTEMATIC CATALOGUE OF SPECIES.

Class **PELECYPODA.**

Order PRIONODESMACEA.

Family UNIONIDAE.

LAMPASILIS LUTEOLA Lamarek.

Thunder Bay; Stony Point, Thunder Bay; Long Lake.

The specimens are yellowish and very thin from Long Lake, but those from Thunder Bay are very large and heavy, similar to those from Lake Michigan, showing admirably the effect of rough, cold water.

STROPHITUS EDENTULUS Say.

Thunder Bay River; Ox Bow. Very thin (for the species) and much enlarged behind the umbones.

ANODONTA GRANDIS FOOTIANA Lea.

Long Lake; Stony Point; Thunder Bay.

This species exhibits the same variation in its two habitats as does *luteola*. The Thunder Bay specimens are large and heavy, with inflated shell and pronounced umbones. Those from Long Lake are thinner and very variable in form.

ALASMIDONTA MARGINATA Say.

Thunder Bay River; Ox Bow.

Order TELEODESMACEA.

Family SPHAERIIDAE.

SPHAERIUM VERMONTANUM Prime.

Long Lake.

Not as solid as specimens from Lake Michigan.

SPIAERIUM FABALE Prime.

Off Thunder Bay Island, in 30 fathoms.

The specimens are rather thin and fragile. The umbones are a little more elevated than in typical specimens.

Class **GASTROPODA.**Superorder **Streptoneura.**Order **CTENOBRANCHIATA.**Family **VIVIPARIDAE.****CAMPELOMA MILESII** Lea.

Long Lake.

The specimens seem to be quite typical, as figured and described by Walker, *Nautilus*, XVI, p. 121, 1903.

CAMPELOMA RUFUM Haldeman.

Ox Bow; Thunder Bay River.

Family **VALVATIDAE.****VALVATA SINCERA** Say.

Alpena.

VALVATA TRICARINATA Say.

Alpena.

Only the typical form of this species was collected.

Family **AMNICOLIDAE.****AMNICOLA CINCINNATIENSIS** Anthony.

Alpena.

Family **PLEUROGERIDAE.****GONIOBASIS LIVESCENS** Menke.

Trowbridge's Dock, Alpena.

GONIOBASIS LIVESCENS CUSPIDATUS Anthony.

Thunder Bay River.

The specimens are very uniform and the variety seems quite distinguishable from *livescens*.

Superorder **Euthyneura.**

Order PULMONATA.

Suborder **Basommatophora.**Family **Physidae.**

The collection of Physa and Lymnaea made by Dr. Nason is exceptionally fine. The first-named genus is represented by a large number of specimens and embraces some eight species and varieties. This genus is in a bad state of chaos, hardly any two authors agreeing as to what limits shall be assigned to the different species. The various species are but little understood by the majority of conchologists, most of the species being lumped under heterostropha and gyrina. As a matter of fact the Physae may be, for the most part, easily distinguished when carefully and intelligently studied. They are much less variable than the Lymnaeas, the specific limits being easier to determine. Such characteristics as the form of the aperture and outer lip, the spire (acute or dome-shaped), sculpture, and the presence of various bands marking rest periods, are valuable points in the separation of the species.

A careful study of the genus Physa, founded on abundant material from widely separate points, would do much to untangle this interesting group of shells. Mr. O. A. Crandall made a splendid beginning in the Nautilus (volume XV), but he was not permitted to finish the work so well begun, his death having occurred just as the last part of his paper was published. It remains for some careful student to take up the work where he left it and prepare an illustrated monograph of the "tadpole" snails.

The following notes are based on an abundance of material and may aid to some extent in straightening out the northern species.

Aplexa hypnorum Linné.

Stony Point.

PHYSA GYRINA Say.

Stony Point; Sulphur Island; Isaacson's farm; Thunder Bay Island; Thunder Bay River.

Specimens from the last locality are small and shining and are very smooth for the species. Ox Bow specimens rather thin. Sugar Island; some specimens approach variety *oleacea*, having more of a dome-shaped spire. A few specimens are very like Tryon's figure of *aurea* in Haldeman's monograph. *Gyrina* and its varieties may be known by their *looped-shaped aperture* and *obtuse, more or less dome-shaped spire*. Close attention to these two points will greatly aid in their determination. The surface sculpture is also very pronounced, consisting of very strong spiral impressed lines, giving the surface a wavy aspect.

PHYSA GYRINA OLEACEA Tryon.

Thunder Bay Island; Squaw Island (large and shining); Thunder Bay River, Ox Bow; Sugar Island.

Oleacea is distinguished from *gyrina* by having a low, dome-shaped spire which forms an *almost unbroken curved line from the spire to the base of the aperture*. In the writer's report on the Mollusca of the Chicago Area this variety was called *elliptica*; the form thus designated should be called *oleacea*, as *elliptica* appears to be a valid species. On plate 34 of that report the extreme upper left hand figure of 4 is typical *gyrina*, while the two right hand figures of 5 are typical *oleacea*. It is with some hesitancy that the specimens under consideration are referred to *oleacea*. They are wider than the typical *oleacea* (as defined by Crandall), the outer lip is more convex and the sculpture is not as coarse. They have several characteristics in common with *aurea* Lea. The above disposition seems to be the best until more is known concerning some of the ambiguous synonyms.

PHYSA HETEROSTROPHIA Say.

Thunder Bay River; Long Lake: Trowbridge's dock, Alpena.

Specimens from the first-named locality are very large, with elevated spire and smooth, shining surface. A few

specimens have a low spire. Specimens from Alpena are small, *very* smooth and shining.

This species is made to bear the sins of the whole Physa family, many conchologists placing everything from gyrina to ancillaria in it. It is, however, a very distinct species, easily recognized by its *smooth, glossy* shell, oval aperture and regular, pointed spire. It may also be known by the *absence* of the various rest periods, the growth being completed in *one* year, while gyrina occupies *three* years in completing its growth. It is not as common as most of the other northern Physae.

PHYSA ANCILLARIA CRASSA Walker.

(Pl. I. Figs. 7, 8, 9, 10).

Long Lake; Thunder Bay Island.

This very distinct variety seems to be the most abundant Physa in the region under consideration, about 150 specimens being in the collection. It is easily known by its *heavy* shell, *extremely short spire, shouldered* whorls and the two or three heavy, white, varicose bands which show through the shell. Typical specimens measure as follows:

Length 13.00; width 8.00; aperture length 10.00; width 4.50 mill.
 " 13.00; " 8.00; " " 9.00; " 4.25 "

Mr. Walker's description in the Nautilus XIV, p. 98, 1901, will readily distinguish this variety which seems to take the place of typical ancillaria in this region.

Another form occurs with variety crassa (figs. 9, 10), which is referred to it by Mr. Walker, but which differs from that form in several respects, apparently standing between ancillaria and crassa and resembling in a measure, Physa sayii Tappan. The spire is acute and somewhat elevated, the whorls are gracefully rounded and there is no evidence of a shoulder. The shell is thick and solid and the varicose ribs of crassa are present. Specimens measure as follows:

Length 14.00; width 8.00; aperture length 10.00; width 4.25 mill.
 " 12.75; " 8.50; " " 9.00; " 4.00 "
 " 16.00; " 9.50; " " 12.00; " 5.00 "

PHYSA CRANDALLI Baker.

PHYSA RHOMBOIDEA Crandal 1901 (non Mecha Hayden, 1856).

Long Lake.

One semi-fossil specimen. It is with some hesitancy that I identify this specimen with rhomboidea, but no other way seems permissible, as it corresponds with both the figures and description of the species in the Nautilus. (XV, p. 44, plate 2, figs. 6, 7, 1901.) The species is normally southern in distribution, the types being from Sedalia, Missouri. The specimen agrees very well with an undoubted specimen from Knox County, Indiana, collected by Mr. L. E. Daniels. The specimen in question has the same peculiar columella, umbilicus, impressed sutures and somewhat gibbous whorls. It is a little wider than the figures of rhomboidea in the Nautilus and the spire is a trifle more depressed. The measurements for this individual are as follows:

Length 14.50; width 8.50; aperture length 9.00; width 5.00 mill.

PHYSA ANATINA Lea.

Isaacson's farm.

This species is most frequently confounded with gyrina. The difference is principally in the shape of the aperture, which in gyrina is distinctly loop-shaped while in anatina it is *triangularly elongate ovate*. The spire in anatina is also more pointed. A few deformed specimens of anatina had the aperture somewhat loop-shaped, as in gyrina. A typical specimen of anatina measures as follows:

Length 15.00; width 9.00; aperture length 10.00; width 4.00 mill.

PHYSA INTEGRAL Haldeman.

Long Lake; Ox Bow; Thunder Bay River.

The specimens of integra are of good size and are typical in form.

PHYSA WALKERI Crandall.

Pl. I., figs. 5, 6 (Nautilus XV, p. 57, pl. 2, fig. 5. 1901.)

Typical specimens of this quite distinct species were collected on Isaacson's farm. They vary in the elevation and

acuteness of the spire and in the length and width of the shell. It is a triannuan, the three rest periods showing as white varicose bands. *Walkeri* is related to *integra* but has a *longer spire* and *less rotund whorls*. Some characteristic measurements are as follows:

Length	11.00;	width	7.00;	aperture length	7.50;	width	3.50 mill.
"	11.00;	"	6.00;	"	6.50;	"	3.00 "
"	11.00;	"	6.50;	"	6.50;	"	3.00 "

Walkeri was described from specimens collected at Petoskey, Michigan.

Family LYMNÆIDÆ.

SEGMENTINA ARMIGERA Say.

Stony Point; Sugar Island. Very common.

PLANORBIS BINNEYI Tryon.

Sulphur Island; Thunder Bay River; Mill pond, Alpena.

This large, coarse species is widely distributed, ranging from New York to Washington. It has a superficial resemblance to *Planorbis corpulentus*, but lacks the peculiar truncation of the spire whorls and the angular shoulder of the whorls, besides having other differences. *Binneyi* is also abundant in the St. Lawrence River, at Wellesley Island.

PLANORBIS BICARINATUS Say.

Ox Bow; Alpena. Typical and common.

PLANORBIS BICARINATUS STRIATUS Baker. Pl. I., fig. 11.

Long Lake.

About 50 specimens of this variety are before me. The spiral lines are notably distinct, much more so than the fossil type specimens from the Pleistocene deposits at Milwaukee, Wisconsin. In some specimens the spiral lines are deeply incised. The uniformity of the present material and the general absence of spiral lines on typical *bicarinatus* from this locality, would seem to indicate that *striatus* is a good

variety. The lines are very distinct on young shells. Typical specimens measure as follows:

Diameter	12.00;	height	6.50 mill.
“	11.00;	“	6.00 “
“	12.00;	“	6.50 “

PLANORBIS CAMPANULATUS Say.

Long Lake. Common and typical.

PLANORBIS PARVUS Say.

Alpena. Common.

PLANORBIS DEFLECTUS Say.

Long Lake, apparently rare; Alpena, common.

LYMNAEA STAGNALIS APPRESSA Say.

Long Lake. One specimen is very long and narrow.

LYMNAEA STAGNALIS JUGULARIS Say.

Alpena. Fairly common.

LYMNAEA PALUSTRIS Müller.

(1) Thunder Bay Island; (2) Stony Point; (3) Sugar Island; (4) Sulphur Island; (5) Long Lake; (6) Whitefish Point; (7) Isaacson's farm.

The series of *palustris*, embracing several hundred specimens, is a very interesting lot of shells, showing as it does the effect of different environments. The specimens from (1) are very variable with heavy, thick shell, and lip margins joined by a heavy raised callus covering the parietal wall. This callus is sometimes erect, as in *emarginata*. The spire is long, sometimes scalariform, and the shell corresponds closely to the form described by Say as *elodes*. The specimens from this locality exhibit admirably the effect of the heavy seas of Lake Huron.

Specimens from Whitefish Point are thinner and the spire is not so pointed. They are, however, subject to great distortion; in many cases the entire aperture is free from the body whorl and the suture is frequently channelled for quite a distance on the last whorl. Some specimens are slender

and scalariform, while others are fat, with a short spire, but all are distorted, more or less. They remind one of *catascopium* from Pine Lake, Charlevoix, Michigan. Two characteristic measurements of *palustris* from this locality are given below:

Length 20.50; width 7.50; aperture length 8.00; width 5.00 mill.
 “ 15.50; “ 8.00; “ “ 9.00; “ 5.00 “

Locality (2) produces a thinner shelled *palustris* which varies toward the corpulent *nuttalliana* form. Some specimens are heavily shouldered, while others are rather long and narrow. The aperture is sometimes spreading and an umbilicus is not infrequently developed. Some measurements of this form are given below:

Length 23.00; width 9.00 mill.
 “ 22.50; “ 11.50 “
 “ 21.00; “ 10.00 “
 “ 18.00; “ 9.00 “
 “ 23.00; “ 11.00 “

At locality (7) the specimens are rather thin, light-horn colored, with very heavy columellar fold. The specimens from locality (5) are small and very solid, scalariform, with a very heavy columellar pleit.

A single reversed specimen was in the lot from Stony Point. It consists of four whorls and measures 9.50 mill. in length.

LYMNAEA PALUSTRIS NUTTALLIANA Lea.

Sugar Island; Sulphur Island; Long Lake.

It is a question whether *nuttalliana* can be varietally separated from *palustris*. In the lot of shells from Sugar Island there is an almost perfect gradation from typical *palustris* to *nuttalliana*. Typical *nuttalliana* differs from *palustris* in its larger size, more corpulent and swollen whorls, shorter spire and very heavy columellar plait. The shells from this locality are strong but light. Monstrosities occur on the last whorl, one specimen having a blind umbilicus. Many of the specimens are strongly malleated. Some measurements of this variable form are given below:

Length	32.00;	width	12.50 mill.
"	28.50;	"	12.00 "
"	30.00;	"	13.00 "
"	25.00;	"	13.00 "
"	17.00;	"	8.50 "

LYMNAEA PALUSTRIS MICHIGANENSIS Walker.

Stony Point; Thunder Bay.

Small, but typical; associated with palustris.

LYMNAEA EMARGINATA Say.

Squaw Island. Apparently rare.

LYMNAEA CATASCOPIUM Say.

Pl. I, figs. 13, 14, 15, 16.

Trowbridge dock, Alpena.

Several juvenile specimens seem referable to this species, although differing in some respects, and several are figured for future reference.

LYMNAEA NASONI n. sp.

Pl. I, figs. 1, 2, 3, 4.

Shell rather small, roundly inflated, solid; whorls four, rounded, inflated, last whorl very large and bulbous; color whitish, tinged with purple; surface dull, marked by rather coarse growth lines crossed by fine impressed spiral lines; apex small, rounded, smooth, dark brown in color; spire very short, depressed, one-third the length of the shell; sutures well impressed; aperture broadly ovate, almost round in some specimens; outer lip somewhat expanded, thickened internally by a callus; columella with the plait and twist of catascopium; the columellar callus is rather heavy in the columella region but thin where it covers the parietal wall; a small umbilical chink is present.

Length	10.00;	width	6.75;	aperture length	7.00;	width	5.00 mill.
"	10.50;	"	6.75;	"	7.00;	"	4.25 "
"	9.50;	"	6.00;	"	7.00;	"	5.00 "
"	8.50;	"	6.00;	"	6.25;	"	4.00 "

Habitat: — Thunder Bay Island.

Nasoni was at first thought to be a variety of catascopium but it seems distinct enough to be accorded specific rank.

Its chief characteristics are its bulbous, short, dome-shaped spire and wide-spreading aperture. The specimens seem adult, as the outer lip is thickened internally in several specimens.

A large, bulbous form of *catascopium* is found in Lake Superior (collection of J. H. Ferriss) but the individuals are not constant, a lot of ten specimens showing every gradation from typical *catascopium* to the rounded form. They are also more fragile and the aperture does not spread in the same manner as *nasoni*. Typical bulbous forms measure 13×9 mill. Some *catascopium* from Pine Lake, Charlevoix, Michigan, (collection Bryant Walker) have a rather short spire but they are of a different shape; the charlevoix specimens are very variable. *L. woodruffi* Baker is differently shaped and a typical figure is given for comparison. The types of *Nasoni* are in the collection of the Chicago Academy of Sciences and cotypes are in the collections of Dr. William A. Nason and Mr. Bryant Walker.

LYMNAEA DESIDIOSA Say.

The specimens of *desidiosa* vary somewhat in size. The localities and average lengths are as follows:

Ox Bow, 6-8 mill.

Whitefish Point, 10-11 mill.

Long Lake, 10 mill. Very smooth shells.

Sulphur Island. Varies toward variety *modicella*.

LYMNAEA GALBANA Say.

Long Lake.

Galbana is one of the most uniform of American *Lymnaeas* and is a common shell from Maine to Michigan. Its wide shell, short spire and somewhat rounded aperture will distinguish it from *desidiosa* and its varieties.

Suborder **Stylommatophora**.**HETERURETHRA.**Family **SUCCINEIDAE.****SUCCINEA RETUSA** Lea.

Sulphur Island; Sugar Island (large); Thunder Bay Island (small); Ox Bow.

Retusa varies much in the acuteness of its spire. Specimens from Ox Bow are white in color and very transparent. It is frequently identified as *higginsii*.

SUCCINEA AVARA Say.

Considerable variation is exhibited by this species in the matter of size and shape. The following variations occur:

Sulphur Island. Small, long and narrow. 8 mill.

Thunder Bay. Small, with short spire and wide body whorl 7 mill.

Sugar Island. Large and small specimens mixed.

Ox Bow. Very large, rather narrow. 12 mill.

Isaacson's farm. One specimen.

Family **HELICIDAE.****POLYGYRA ALBOLABRIS** Say.

Sulphur Island; Thunder Bay Island; Alpena.

Some specimens are rather depressed and very thin. One specimen is provided with two projecting, triangular, tooth-like processes, caused by the repairing of a break in the shell; one is over the periphery and projects about two millimeters.

POLYGYRA MONODON Rackett.

Sugar Island. Common.

POLYGYRA MONODON FRATERNA Say.

Alpena; Sulphur Island; Thunder Bay Island. Common.

Family **ZONITIDAE.****EUCONULUS FULVUS** Müller.

Thunder Bay Island; Sugar Island. Typical.

ZONITOIDES ARBOREUS Say.

Alpena. Common and typical.

ZONITOIDES NITIDUS Müller.

Thunder Bay Island (very large); Sugar Island. Common.

Family ENDODONTIDAE.

PYRAMIDULA ALTERNATA Say.

Sugar Island; Sulphur Island.

Specimens from the first-named locality are very light colored, the red flames being faint and much broken. The spire of many specimens is very high, an average individual measuring 17 mill. in diameter and 11.50 mill. in height. Specimens from Sulphur Island have a diameter of 22.00 millimeters.

EXPLANATION OF PLATE.

PLATE I.

- Figure 1-4. *Lymnaea nasoni* Baker. Types.
 " 5-6. *Physa walkeri* Crandall.
 " 7-8. *Physa ancillaria crassa*. Walker.
 " 9-10. *Physa ancillaria crassa*. Walker. Variety.
 " 11. *Planorbis bicarinatus striatus*. Baker.
 " 12. *Lymnaea woodruffi*. Baker.
 " 13-14. *Lymnaea catascopium* Say. Variety.
 " 15-16. *Lymnaea catascopium* Say. Variety.
 All figures enlarged three diameters.

Issued, May 21, 1906.

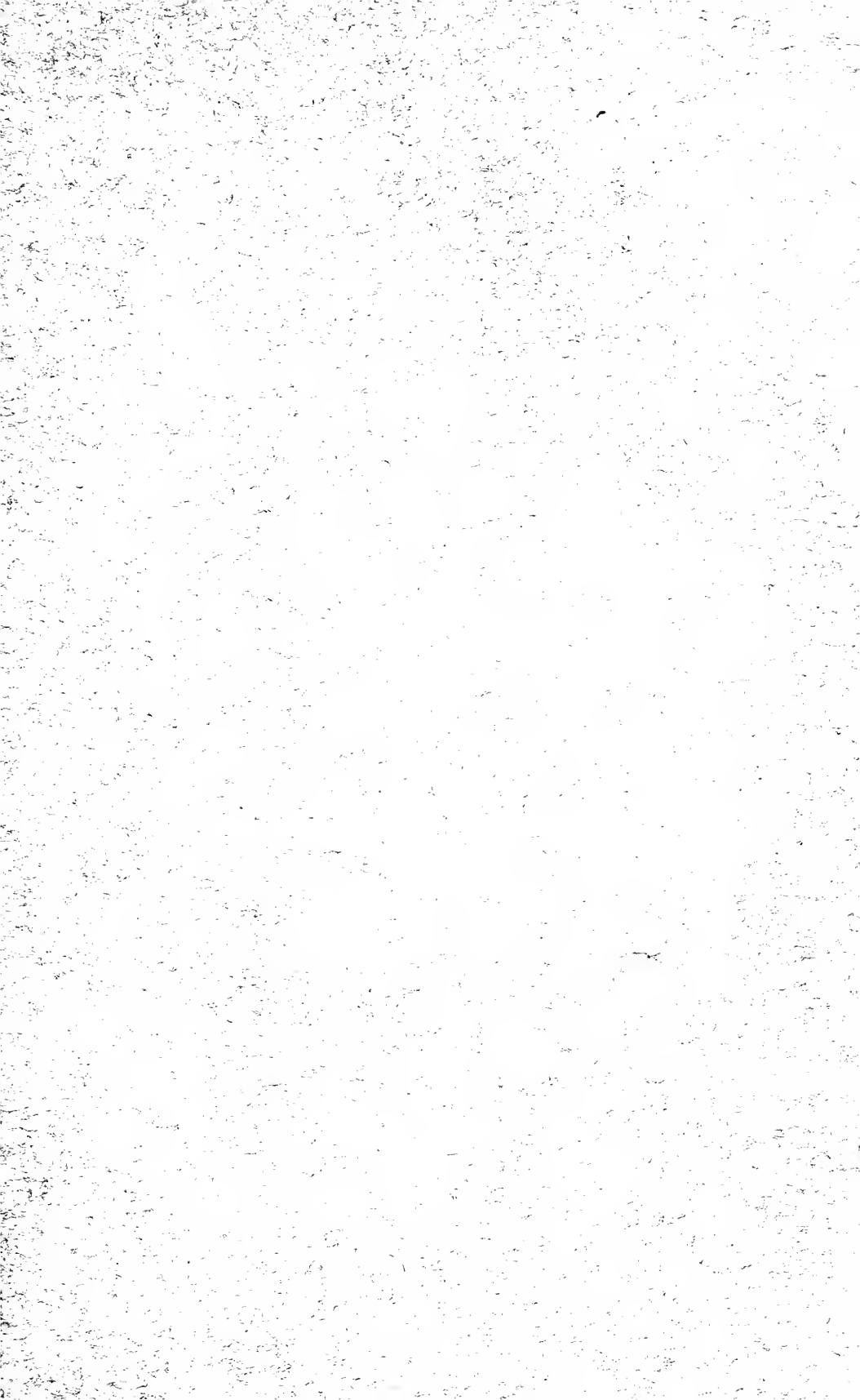

PUBLICATIONS.

The following publications of the Academy are offered for sale at the net prices indicated. Applications should be addressed to The Librarian, The Academy of Science of St. Louis, 3817 Olive St., St. Louis, Mo.

TRANSACTIONS (in octavo).

Vol.	Number.	Price per number.	Price per vol.	Price in set.
1	1*		
	2†	\$4.00	\$7.50	\$7.00
	3, 4	2.00 each.	(Nos. 2-4 only.)	(Nos. 2-4 only.)
2	1 to 3	2.00 each.	5.50	5.00
3	1 to 4	2.00 each.	7.50	7.00
4	1 to 4	2.00 each.	7.50	7.00
5	1-2, 3-4	4.00 each. (double numbers)	7.50	7.00
6‡	1, 2, 6, 8, 10, 11, 16, 17 4, 5, 7, 13, 14, 15, 18 3, 9 12	25 cts. each.	7.50	7.00
		50 cts. each.		
		75 cts. each.		
		\$1.00		
7‡	2, 3, 4, 6, 7, 8, 15, 15, 16, 18, 19 5, 9 to 12, 14, 20 17 1	25 cts. each.	7.50	7.00
		50 cts. each.		
		75 cts.		
		\$1.00		
8‡	1, 3 to 6 8, 10, 12 2, 7, 9, 11	25 cts. each.	3.75	3.50
		50 cts. each.		
9‡	1, 3, 4, 7, 9 2, 5, 8 6	25 cts. each.	3.75	3.50
		50 cts. each. \$1.25		
10‡	9 2, 4, 5, 10 1 3, 6, 7, 8, 11	10 cts.	3.75	3.50
		25 cts. each.		
		40 cts.		
		50 cts. each.		
11‡	2, 3 5-8, 10, 11 1 4 9	15 cts. each.	3.75	3.50
		25 cts. each.		
		45 cts.		
		75 cts.		
		1.00		
12‡	1, 9, 10 5 3, 8 2, 4, 6, 7	25 cts. each.	3.75	3.50
		35 cts.		
		45 cts. each.		
		50 cts. each.		
13‡	2, 3, 5-9 4 1	25 cts. each.	3.75	3.50
		75 cts.		
		1.50		
14‡	2, 3, 6, 7 4, 8 5 1	25 cts. each.	3.75	3.50
		50 cts.		
		75 cts.		
		\$1.00		
15‡	1, 3, 4, 5, 6 2	25 cts. each.	3.50	3.25
		50 cts. each.		
		\$1.50		

MEMOIRS (in quarto).

- Contributions to the archaeology of Missouri, by the Archaeological Section. Part 1. Pottery. 1880. \$2.00.
- The total eclipse of the sun, January 1, 1889. A report of the observations made by the Washington University Eclipse Party, at Norman, California. 1891. \$2.00.

* Supply exhausted.
 † Can be sold only to purchasers of the entire volume, — so far as this can be supplied.
 ‡ Each number is a brochure containing one complete paper (or rarely two).

JUN 8 1906

149

Transactions of The Academy of Science of St. Louis.

VOL. XVI. No. 3.

ON PRESSURE MEASUREMENTS IN A FLUID
STREAM.

FRANCIS E. NIPHER.

Issued May 31, 1906.



JUN 8 1906

ON PRESSURE MEASUREMENTS IN A FLUID STREAM.*

FRANCIS E. NIPHER.

The earlier measurements of wind pressure were made with pressure boards, in which the total force against the boards was measured by means of springs. In some cases the board was moved through the air on a rotating arm. Similar experiments have been made with the board immersed in water.

In all of this work, the information is of little or no value in the study of wind pressures over buildings or other structures. For example, in case of wind pressures in the angle of a building where the wind is practically checked, a pressure board would show no result. The pressures on the front and back sides of the board would be practically equal. And the distribution of pressures over such a board in free air is wholly different from that over any building when exposed in the same current of air.

The Pitot tube has also been used for wind pressure determinations. In this device the rarefaction which exists on the leeward side of the pressure-board is wholly eliminated. The results obtained by the Pitot tube are therefore very different from those obtained from pressure boards.

When a Pitot tube is placed with its open end exposed normally to an air current, the pressure thereby developed within the tube is that which would result from the slowing down of the wind to zero velocity. It is the pressure that would develop in the angle of a building, if still air in contact with the building could not escape over the roof, but were under compression by the stream of air surging against it. Such a consideration is not in general realized on the surface of a building. The air under pressure is not wholly checked.

* Presented by title to The Academy of Science of St. Louis, May 7, 1906.

In the Pitot tube the pressure developed is that to which the velocity of the stream may be considered due. The air current may be assumed to be an efflux from a great tank, filled with air of density δ' to a height h above the orifice. The pressure due to this column would be $gh\delta'$. The velocity of efflux would be $v = \sqrt{2gh}$. By the elimination of h these two equations give Newton's formula for the relation between pressure and velocity.

$$P = \frac{\delta'}{2}v^2 = \frac{b}{2CT}v^2.$$

In this equation the pressure is given in dynes per sq. cm, v being in cm. per sec. C is the Boyle-Gay-Lussac constant in C. G. S. units, which for air is 2.88×10^6 . T is the absolute temperature centigrade and b is the barometric pressure in dynes per sq. cm. This barometric pressure is supposed to be corrected for velocity effects due to the wind sweeping against and through the shelter in which the barometer is placed. These velocity effects disturb all readings of pressure indicators in a stream of air. The compression on the windward side and the rarefaction on the leeward side of every obstacle, whether that obstacle be a barometer case or the building in which the barometer is sheltered produce such effects. Dr. Engelmann long ago (in 1861) called attention to such fluctuations in the barometer reading due to rapidly variable winds. (*Trans. Acad. of Sc. of St. Louis* II 153). In addition the wind sweeping across openings leading into the building or the barometer case, produces an atomizer action causing a flow of air from the opening into the moving stream. The air within a building is therefore both compressed and rarefied by the wind blowing around it. Different buildings behave very differently in this respect. The result depends upon materials of construction and upon the arrangement of windows and doors.

In a former paper* the writer has shown how all such velocity effects may be eliminated. The disk collector there

* *Trans. Acad. of Sc. of St. Louis* VIII: 1.

described and figured has been found effective for wind pressure work. (pp. 4 and 9). For eliminating velocity effects in small pipes through which air is being forced, it is desirable to make the disk small. The leading in tube may also be small, since the pressure is in such cases much more nearly constant, than is the case in wind pressures against buildings. In such cases it is better to place two circular disks of wire cloth on each side of the disk, so that the collector shown in the former paper is sandwiched between them. The arrangement is then as shown in Fig. 1. The collector is now made in this way for all purposes.

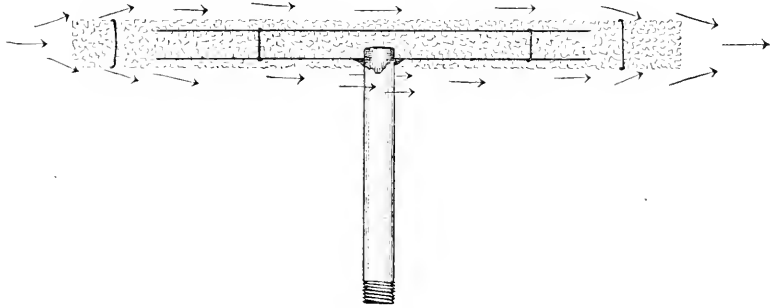

Fig. 1.

It is evident that in measuring wind velocities above the top of a building, by means of a Pitot tube collector attached to the wind-vane, the open end of the water gauge to which the Pitot tube leads, must not be exposed to the stream of air which is being measured, nor must it communicate with the air within the building around which the wind sweeps. It must be connected with a disk-collector (Fig. 1) placed far above the building, and standing edgewise in the wind. The plane of the disk is to be horizontal.

These complications caused the writer to seek some method of verifying Newton's equation in which the Pitot tube itself was moved through the air. One such method has been described in a former paper.* That method involved the exposure of the tube from the window of a railway car, having its windows opened.

* Trans. Acad. of Sc. of St. Louis. X: 215-227.

In 1894 the writer made an attempt to verify Newton's formula by rotating a Pitot tube around the shaft of a steam engine. A pipe about six feet in length was clamped to the rim of the driving wheel. The outer ends terminated in L s which faced in the direction of motion. A T tube at the axis was joined by a flexible connection with a light drum in a water joint, so that the axial pressure could be transmitted to and measured with a water gauge. It was of course expected that the axial pressure would be less than $\frac{1}{2} \delta'v^2$ on account of the rotation. It was however found that the axial pressure was less than that of the atmosphere. The decrease of pressure at the axis, due to rotation was apparently greater than the increase due to the wind blowing into the mouths of the Pitot tubes. It was also found that part of this was due to a vortex motion set up in the air by the engine wheel.

A discussion of the theory of this experiment was then begun and has been continued at intervals up to the present time.

Suppose the tube to be closed at the ends and at the axis, thus imprisoning a column of air whose length measured from the axis of rotation is r . The pressure b and temperature T may be assumed to be that of the atmosphere. By the law of gases

$$\frac{b}{\delta'T} = C = 2.88 \times 10^6.$$

If the tube be rotated with an angular velocity $\omega = 2\pi n$, the pressure will no longer be constant throughout the tube. For constant values of n we may suppose the temperature to become constant throughout. At any distance r from the axis, the density is

$$\delta = \frac{\delta'}{b} (b + P)$$

An element of gas in a column of unit cross section at any distance r is

$$dm = \delta dr = \frac{\delta'}{b} (b + P) dr.$$

The radial acceleration of dm towards the center is

$$a = \omega^2 r.$$

Then

$$dP = a \delta dr = \omega^2 r \frac{\delta'}{b} (b + P) dr.$$

Hence

$$\int_{P'}^P \frac{dP}{b + P} = \omega^2 \frac{\delta'}{b} \int_0^r r dr$$

or

$$\frac{b + P}{b + P'} = \epsilon \frac{\omega^2 r^2}{2CT} \quad (1)$$

The mass m of air in the column of length r is

$$m = \delta' r = \int_0^r \delta dr = \frac{\delta'}{b} \int_0^r (b + P) dr$$

Combining this equation with (1) by the elimination of P , we have for any constant angular velocity,

$$\frac{b + P}{b} = \frac{r}{\int_0^r \epsilon \frac{\omega^2 r^2}{2CT} dr} \quad (2)$$

In this equation the integral in the denominator was determined by planimeter measurements between limits $r = 0$ and $r = 100$ cm, this outer limit being taken as the value of r in the numerator. The temperature T was assumed 293. The number of rotations per second was assumed $n = 10$, in which case $\frac{\omega^2}{2CT} = 2.339 \times 10^{-6}$.

The integration was repeated with values $r = 50$ cm. and $n = 20$.

The result of the two determinations was

$$\frac{b + P'}{b} = \frac{100}{100.7855} = 0.99221$$

$$\frac{b + P'}{b} = \frac{50}{50.3945} = 0.99217.$$

It thus appears that doubling the angular velocity of the tube does not affect the pressure at the axis of rotation, if the linear velocity of the free end is held unchanged by reducing the length to one-half its former length. This of course also means that the pressure P at the outer end is also unchanged under the same conditions. Eq. (1).

In integrating the function contained in the denominator of (2), the rectangular area whose length is in the one case $r = 50$, and in the other 100, and whose breadth is

$$\left(\frac{\omega^2 r^2}{\epsilon 2CT} \right)_{r=0} = 1, \text{ could be left off from the diagram, since its}$$

integral value was in the one case 50, and in the other 100. The curve could thus be drawn upon a large scale. The area actually measured was therefore that corresponding to the two fractional values 0.7855 and 0.3945.

A series of similar integrations was then made for a tube of length $r = 100$ cm., for various speeds n . In the following table the pressure at the axis of rotation in terms of the pressure b throughout the tube when $n=0$, is given in column 3. In the fourth column the pressure at the outer end where $r=100$, is given. These values are computed from those in column (3) by means of equation (1).

n	$v \frac{cm}{sec}$	$\frac{b + P'}{b}$	$\frac{b + P}{b}$
0	0	1.0000	1.0000
10	6283	0.9922	1.0160
20	12566	0.9689	1.0640
30	18850	0.9300	1.1476
40	25132	0.8775	1.2753
50	31416	0.8096	1.4529
60	37699	0.7324	1.6999
70	43982	0.6396	2.0121
80	50265	0.5456	2.3717
90	56549	0.4445	2.9568
100	62832	0.3509	3.6388

After some experimenting, it was found that the values in column 3 may be represented fairly well by the following empirical equation

$$\frac{b + P'}{b} = \frac{2}{1 + \epsilon ar^2} \tag{3}$$

Where a is a constant quantity, to be hereafter discussed, and $v = \omega r$, the velocity of the outer end of the tube.

The value of a for each speed in the previous table is given in column 2 of the following table for a temperature $T = 293$.

n	a	$\frac{b + P'}{b}$ comp.	diff
0	?	1.0000	0.0000
10	3.944×10^{-10}	0.9923	-0.0001
20	3.940 "	0.9691	-0.0002
30	3.946 "	0.9306	-0.0006
40	3.899 "	0.8770	+0.0005
50	3.906 "	0.8092	+0.0004
60	3.888 "	0.7288	+0.0017
70	3.902 "	0.6386	+0.0010
80	3.880 "	0.5423	+0.0033
90	3.917 "	0.4448	-0.0003
100	3.920 "	0.3516	-0.0007
Mean	3.914×10^{-10}		

The mean value of a in the table being put in Eq. (3), the pressure at the axis may be computed. These values are given in column 3. The differences between these computed values and those of the previous table are given in the final column.

If the value a in (3) be assumed $a = \frac{K}{2CT}$, the value of K is found to be 0.6606.

The same determinations were then made for a temperature $T=273$. The results are given in the following table:

n	a	$\frac{b + P'}{b}$		diff
		obs	calc	
0	?	1.0000	1.0000	0.0000
10	4.220×10^{-10}	0.9917	0.9917	0.0000
20	4.202 “	0.9968	0.9969	—0.0001
30	4.211 “	0.9253	0.9255	—0.0002
40	4.217 “	0.8676	0.8681	—0.0005
50	4.216 “	0.7949	0.7957	—0.0008
60	4.168 “	0.7122	0.7101	+ 0.0021
70	4.159 “	0.6181	0.6147	+ 0.0034
80	4.180 “	0.5161	0.5142	+ 0.0019
90	4.205 “	0.4135	0.4141	—0.0006
100	4.225 “	0.3174	0.3200	—0.0026
Mean	4.200×10^{-10}			

Assuming this value of a to be $a = \frac{K}{2CT}$, the value of K is found to be $K = 0.6605$. This is a very close agreement with the value for the temperature of $20^\circ C$.

It is of course understood that (3) is not the real solution of (2) and that no closed solution of (2) is possible. Nevertheless in this range of velocity from 0 to 1406 miles per hour, the greatest differences between the planimeter determinations of (2) and the values computed from (3) are not greater than the errors in the planimeter values. It is also evident that by (3) the value of $b + P'$ will become zero, when $v = \omega r = \infty$, which seems to be a reasonable result. In order to test equation (3) for a wider range of temperature, a planimeter determination of (2) was made for a temperature $t = 100^\circ\text{C}$ or $T = 373$. The case where $n = 100$ and $r = 100$ was selected. The value of $\frac{b + P'}{b}$ was found to be 0.4612. The value computed from (3) is 0.4580, giving a difference of + 0.0032.

If an opening be made in the tube at the axis of rotation, the pressure there will rise from $b + P'$ to b . The pressure at the outer end distant r from the axis may then be determined from (1) by making $P' = 0$ in that equation.

The pressure at the end caps in excess of the pressure b , is when $P' = 0$,

$$\frac{P}{b} = \epsilon \frac{v^2}{2CT} - 1 \quad (4)$$

This value may be represented by the following series: —

$$\frac{P}{b} = \frac{v^2}{2CT} + \frac{v^4}{2.4C^2T^2} + \dots \dots \frac{v^n}{2.4.6\dots n (CT)^{\frac{n}{2}}} \quad (5)$$

For all values of v less than 5000 cm. per sec. (110 miles per hour) the second and succeeding terms of (5) are small. Assuming $T = 293^\circ$, and $v = 5000$, the value of the first term is, for air, 0.014, while the second is 0.000110. For such velocities as occur in ordinary storms, Eq. (5) therefore becomes

$$P = \frac{b}{2CT} v^2 = \frac{\delta}{2} v^2$$

This is identical with Newton's equation applied to the

Pitot tube. This would indicate that for ordinary velocities, if the caps on the ends of the tubes were replaced by short L tubes with open ends turned in the direction of rotation, approximate equilibrium should result.

This was tested by means of a tube 2x92.5 cm. long, balanced on its axis of rotation. It was clamped to the end of a small pulley of an electric motor. The connection through the water joint with the axis of a water column having a rise of 1 in 20, gave a very sensitive indication of the pressure at the axis. With a rotation of $n=5$ per second a decrease of 12 to 15 cm. in the scale reading was found. When a current of air was allowed to drift across the plane of rotation the decrease of pressure diminished to one or two cm. The residual decrease in pressure was in part due to this current of air drifting across the mouths of the tube, and in part to the vortex of the air set up by the motion of the tube itself which was not wholly eliminated by the drift of air.

It is evident that such a method could not be used for the purpose of determining the value of the constant for the Pitot tube. It can only serve as a rough check on other methods.

If Newton's equation be assumed to represent the pressure into the open mouth of the revolving tube, when it is moving with a velocity of v , the pressure shown by a gauge connected at the axis of rotation should be by (1).

$$\frac{P'}{b} = \frac{v^2}{2CT} \epsilon - \frac{v^2}{2CT} + \epsilon - \frac{v^2}{2CT} - 1. \quad (6)$$

The terms of this equation may be represented by the following series: —

$$\begin{aligned} \frac{v^2}{2CT} \epsilon - 1 &= -\frac{v^2}{2CT} + \frac{v^4}{2.4CT^2} - \frac{v^6}{2.4.6CT^3} + \dots \\ \frac{v^2}{2CT} \epsilon - \frac{v^2}{2CT} &= \frac{v^2}{2CT} - \frac{v^4}{(2CT)^2} + \frac{v^6}{(2CT)^3} - \dots \end{aligned}$$

Hence the first approximation to the pressure at the axis of rotation is

$$\frac{P'}{b} = -\frac{1}{2} \frac{v^4}{4C^2T^2}$$

This is numerically equal to the second term in (5). If the length of this rotating tube were $r=100$ cm., the speed being five revolutions per sec., and the temperature were $20^\circ C$, the value of P' should be -0.0176 grammes per sq. cm. The pressure actually observed was somewhat over twice this amount as has been previously explained.

It is evident that if the open end of the L tube were so directed that its axis makes an angle α with the plane of rotation, the compression effect would be decreased. The rarefaction P' at the axis increases, and becomes greatest when the axis is at right angles to the plane of rotation. The current of air then blowing across the open mouth of the tube drags the air out, thus cooperating with the outward tendency due to rotation. A tube of this kind with the L tubes removed and open at the ends, illustrates the action of the ordinary fan blower.

It was found however, that the vortex motion in the outer air could not be wholly eliminated. The result of varying the direction of the axis of the Pitot tube was however studied by a series of measurements made from the window of a railway car. A tube terminating in an L was thrust out of the car window. The tube could be turned in its mounting, its position being determined by a graduated circle. When the mouth of the tube was directed toward the head of the train the circle read $\alpha=0$. When the mouth was directed downwards, towards the rear of the train, and upwards, the angle α was respectively 90° , 180° and 270°

The pressure was measured by means of a water manometer like that described in a former paper before referred to. The methods described in that paper were used.

The pressures measured for various positions of the Pitot tube are given in grammes per sq. cm. in the following table. The readings which were symmetrical with respect to the

zero setting were in very close agreement, and they have been combined in the averages.

The $\sqrt{\text{mean square}}$ velocity of the train while these readings were taken was 41.8 miles per hour. The corresponding relative velocity of the train, with respect to the air at the point occupied by the collecting tube was 32.5 miles per hour. This lesser relative velocity was due to the fact that air is dragged along with the train.

PRESSURES IN PITOT TUBE WHOSE AXIS MAKES AN ANGLE a WITH AN AIR CURRENT OF CONSTANT VELOCITY.

a	P	a	P
0	1.34		
10	1.31	100	-1.29
20	1.26	110	-1.03
30	1.21	120	-0.93
40	1.03	130	-0.89
50	0.695	140	-0.87
60	0.000	150	-0.86
70	-0.625	160	-0.80
80	-1.10	170	-0.66
90	-1.44	180	-0.54

These values are the means of 20 observations made on a day that was peculiarly favorable by reason of absence of disturbing wind. A polar curve representing the observed values is shown in Fig. 2.

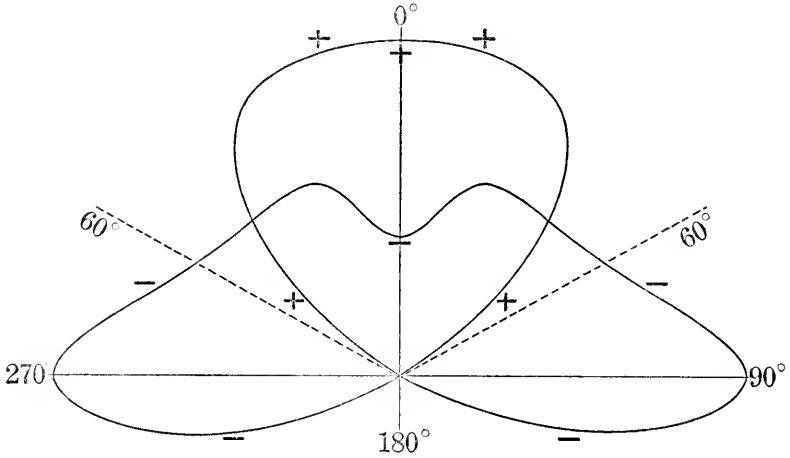

Fig. 2.

The values may be represented by a series of cosine harmonics, but it requires more than ten terms to represent the values, and an equation of this kind is of no particular value.

It is evident from these results that when the Pitot tube is used for determining the velocity of flow in pipes it may be combined with two other independent tubes on either side, making an angle of 60° with it and an angle of 120° with each other. The Pitot tube responds to the combined effect of statical pressure, and that due to velocity.

It should be so placed that its reading is a maximum. The other two tubes should show equal pressures, and represent actual pressures, independent of velocity effects. These tubes must be so placed that the middle tube does not appreciably disturb the stream lines, passing over and into the mouths of the lateral tubes. For small pipes this is not easily done. It is better in such cases and in fact in all cases to use a single tube as the Pitot tube, and to place at a near point a disk collector, like that described in this and a former paper previously referred to.

The practice of using a tube at right angles to the Pitot tube, on the theory that it eliminates velocity effects is well known to be erroneous. It has nothing but time-honored custom to commend it. The rarefaction produced in a tube in this position, is greater than the compression in the Pitot tube.

The disk collector when used in pipes where the pressures are constant may have a leading in pipe of very small diameter, for a distance of half an inch. It may then widen out, in order to give the required stiffness. The wire gauze disks need not then be over an inch in diameter, and the metal disks may be as small as half an inch. These disk collectors may always be tested in an air blast, in order to see whether they are properly designed for specific work.

When the disk collector is used for collecting wind pressure on the sides of buildings, where great and rapid fluctuations occur, the leading-in tube must be larger and the disks of metal should be two and a half inches in diameter, the wire gauze disks being two inches larger. The collectors are placed near the building and with the flat side facing the wall or surface.

A disk collector which is to be placed far above the building, in order to transmit to an air-tight chamber in the building, the real air pressure independent of velocity effects, should have metal disks from 30 to 40 centimeters in diameter. The leading in pipe which taps the lower disk should have a bevelled flange to which the lower disk is fastened. The pipe should extend slightly through the disk in order to prevent moisture which may collect between the disks from passing down the tube. The disks of wire screen may have their central parts cut away, forming a free chamber around the mouth of the pipe, between the metal disks. The screen should be of copper and should project an inch beyond the metal disks, in order to prevent compressions and rarefactions around the edge from penetrating between the disks. Ordinary window screen may be used. A barometer within an air-tight chamber connected with such a collector above the building will not be affected by wind.

In a plant now being placed upon the new Physics building at Washington University, the standard pressure tank has a volume of about 240 liters. Some of the gauges which open into it will show a decrease and others an increase of pressure. It is thought that the tank will be large enough to insure a practical elimination of reactions of the gauges upon each other. More than 3,000 feet of pipe is used in connecting the various pressure collectors with their respective gauges. A photograph of these gauges and other indicating devices, will show the simultaneous values of wind pressures at various points on the building, the wind velocity in free air, and the wind direction with respect to the sides of the building.

If a plant of this kind could be established on a high office building, some very valuable information could be obtained.

Issued May 31, 1906.

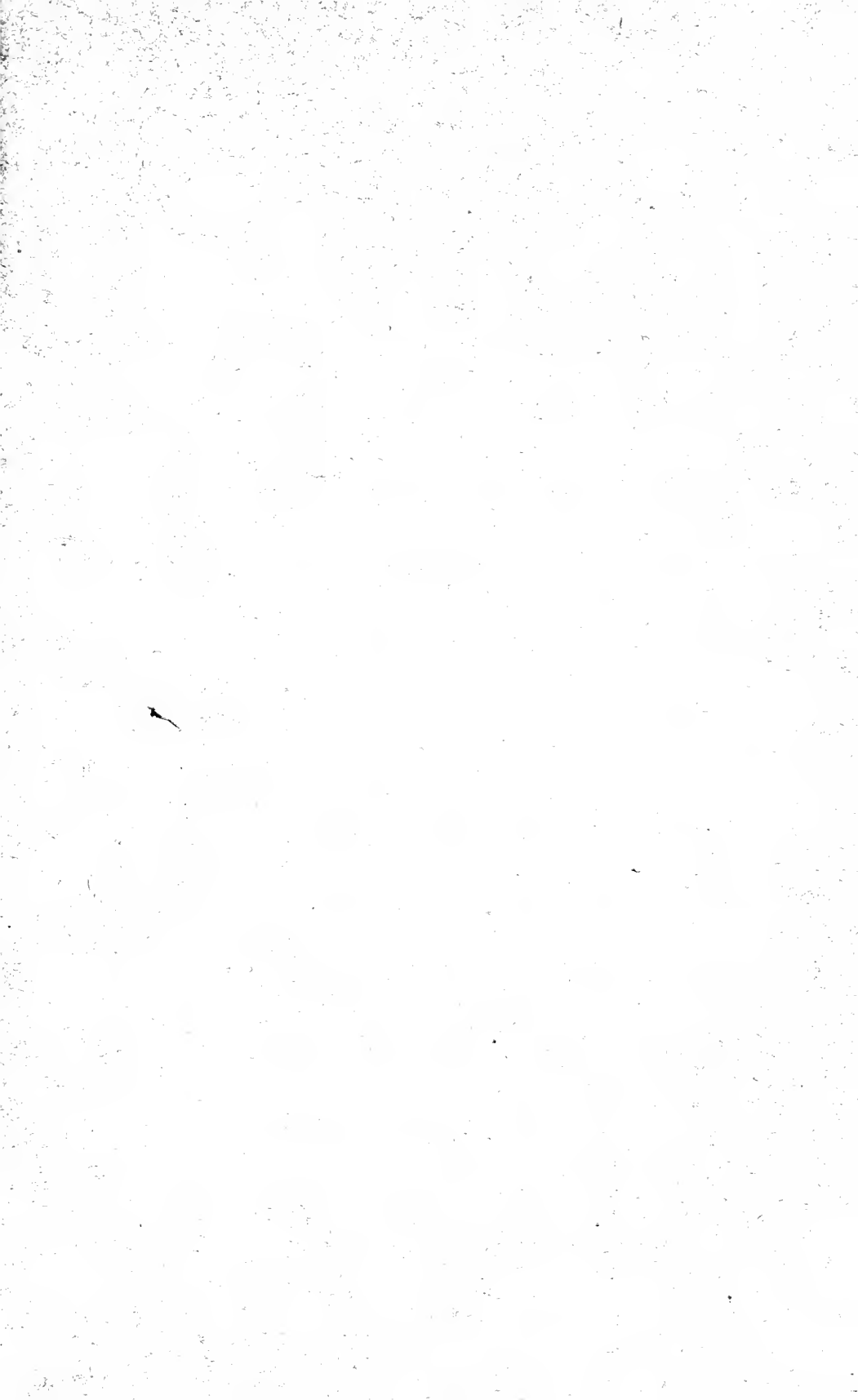

PUBLICATIONS.

The following publications of the Academy are offered for sale at the net prices indicated. Applications should be addressed to The Librarian, The Academy of Science of St. Louis, 3817 Olive St., St. Louis, Mo.

TRANSACTIONS (in octavo).

Vol.	Number.	Price per number.	Price per vol.	Price in set.
1	1*		
	2† 3, 4	\$4.00 2.00 each.	\$7.50 (Nos. 2-4 only.)	\$7.00 (Nos. 2-4 only.)
2	1 to 3	2.00 each.	5.50	5.00
3	1 to 4	2.00 each.	7.50	7.00
4	1 to 4	2.00 each.	7.50	7.00
5	1-2, 3-4	4.00 each. (double numbers)	7.50	7.00
6†	1, 2, 6, 8,	} 25 cts. each.	7.50	7.00
	10, 11, 16, 17			
	4, 5, 7, 13, 14, 15, 18	} 50 cts. each.		
	3, 9 12	} 75 cts. each. \$1.00		
7†	2, 3, 4, 6, 7, 8,	} 25 cts. each.	7.50	7.00
	15, 15, 16, 18, 19			
	5, 9 to 12, 14, 20	} 50 cts. each.		
	17	75 cts.		
	1	\$1.00		
8†	1, 3 to 6	} 25 cts. each.	3.75	3.50
	8, 10, 12 2, 7, 9, 11			
9†	1, 3, 4, 7, 9	25 cts. each.	3.75	3.50
	2, 5, 8 6	50 cts. each. \$1.25		
10†	9	10 cts.	3.75	3.50
	2, 4, 5, 10 1	25 cts. each. 40 cts.		
	3, 6, 7, 8, 11	50 cts. each.		
11†	2, 3	15 cts. each.	3.75	3.50
	5-8, 10, 11	25 cts. each.		
	1	45 cts.		
	4 9	75 cts. 1.00		
12†	1, 9, 10	25 cts. each.	3.75	3.50
	5	35 cts.		
	3, 8 2, 4, 6, 7	45 cts. each. 50 cts. each.		
13†	2, 3, 5-9	25 cts. each.	3.75	3.50
	4 1	75 cts. 1.50		
14†	2, 3, 6, 7	25 cts. each.	3.75	3.50
	4, 8	50 cts.		
	5	75 cts.		
	1	\$1.00		
15†	1, 3,	25 cts. each.	3.50	3.25
	4, 5, 6 2	50 cts. each. \$1.50		

MEMOIRS (in quarto).

Contributions to the archaeology of Missouri, by the Archaeological Section. Part 1. Pottery. 1880. \$2.00.

The total eclipse of the sun, January 1, 1889. A report of the observations made by the Washington University Eclipse Party, at Norman, California. 1891. \$2.00.

* Supply exhausted.

† Can be sold only to purchasers of the entire volume,—so far as this can be supplied.

‡ Each number is a brochure containing one complete paper (or rarely two).

JUN 26 1906

149

Transactions of The Academy of Science of St. Louis.

VOL. XVI. No. 4.

**PRELIMINARY LIST OF HIGHER FUNGI COL-
LECTED IN THE VICINITY OF ST. LOUIS,
MO., FROM 1898 TO 1905.**

N. M. GLATFELTER.

Issued June 14, 1906.



PRELIMINARY LIST OF HIGHER FUNGI COLLECTED
IN THE VICINITY OF ST. LOUIS, MO., FROM 1898
TO 1905.

N. M. GLATFELTER.

GENERAL REMARKS.

I am not aware that our section is rich in these forms of plant life, indeed, I think the contrary is true. I can, however, not claim an exhaustive collection, although my search has been quite thorough.

The number listed is about 500. Of these 433 are believed to be definitely determined. The remaining 67 are more or less in doubt, and are so marked.* The numbers in parenthesis are my record numbers.

The following indicate species new to Science, all determined and named by Prof. Charles H. Peck, State Botanist of New York. They are described in *Bulls. Torr. Bot. Club*, 1900 to 1906: † Nos. 464, 101, 863, 855, 771, 838, 941, 399, 704, 784, 957, 787, 1098, 1100, 1114, 1076, ‡ 102, 1148, 1176, 1177, and 1188, 1091. I consider myself most fortunate in having had the good will of a Peck to appeal to, without whose labors this publication could not have been made. Prof. Peck, year after year, patiently reviewed and determined the specimens (dried) sent him. Where he failed, it was due to insufficient notes, or incomplete material. In the body of the work, the credit of determination is accorded

* Many others, still undetermined, are not included in this list.

† 464 *Lepiota felinoides*, Pk., 101 *Omphalia subclavata*, 453 *Lepiota clypeolaria pygmaea*, 863 *Lepiota brunnescens*, 855 *Lepiota Glatfelteri*, 771 *Entoloma nigricans*, 838 *Bolbitius Glatfelteri*, 941 *Clitopilus Sphaerosporus*, 399 *Lactarius subvelutinus*, 704 *Russula luteobasis*, 784 *Flammula eccentrica*, 957 *Tricholoma viscosum*, 1074 *Boletus castaneus vinicolor*, 787 *Psathyra multipedata*, 1098 *Lepiota maculans*, 1100 *Mycena denticulata*, 1114 *Flammula multifolia*, 102 *Panus meruliceps*, 1148 *Russula nigrescentipes*, 1176 *Lepiota nudipes*, 1177 *Inocybe desquamans*, 1188 *Lentinus microspermus*, 1091 *Russula subvelutinus*.

‡ *Lactarius perplexum*, recently reduced to varietal rank.

him by placing the letter P. immediately before my record numbers.

I desire here also to express the obligations I am under, for kindly assistance rendered, by Professors Macbride, Underwood, Murrell, and Lloyd, whose names appear, in each case, before my record numbers in a manner similar to that of Prof. Peck. I am indebted to our own Dr. Trelease, for kindly advice in the preparation of this paper for the printer. It is remarkable that quite a large number of my list are rare, consisting of only a few specimens, or found but once. For example, *Marasmius Wynnei*, only two specimens. *Collybia myriadophylla*, on one rotten trunk only, producing it three successive years. It seems strange not to have found *Marasmius oreades* or *Russula emetica*, or *Amanita muscaria*. *Cortinarius* was quite rare, until 1905. Facts of this kind are surely very curious.

Though some of the edible species are quite abundant, yet very few of our people collect and eat them, owing to fear of being poisoned. Two kinds only are known to a considerable number of people as being wholesome, viz., the Campester, and Morel. Besides these, *Lepiota naucinoides*, and the Shaggy Coprinus, are also known to a few. The season for fleshy mushrooms opens here about the second week of April, lasting until Fall frosts. This year (1905), however, produced several species as early as March 26th. Most of the species marked "Edible" have been tested by myself. Many besides, not marked, are edible.

I venture some remarks regarding spore measurements. Those given in this paper are my own, five excepted, without reference to recorded ones. As is well known, spore measurements vary considerably in many cases, often markedly, by different authors. This may be accounted for in part by variation of instruments, in part by carelessness, by examination dry or wet, but chiefly, I think, by variation of the spores of different specimens of the same species; for, while in some species the spores measure quite equably, in others the extremes are widely apart; so that unless the extremes be observed, the selection of intermediates necessarily varies

with each observer, more or less. Recently, examining an ascus of a *Peziza*, I found at one end a sporidium 24μ , at the other 33μ , in length. Notwithstanding the foregoing, I deem spore measurement in connection with other spore characters of great value in most cases.

I think, however, a paper specifically devoted to "Spore variation" is one much to be desired. The matter should be definitely determined whether spores of the same species, from different regions do or do not vary, in considerable degree, persistently.

CATALOGUE.

AMANITA.

- A. VERNA, Bull. (822). N. York State Mus. Rept. 23, p. 69.

Found in the woods, sparingly, every year since 1900. The plant is pure white, slender and delicate.

Spores are subglobose, $6-8\mu$.

- A. PHALLOIDES, Fr. ? (1164).

Chain of Rocks, Sept. 20, 1903.

Spores, often irregular, elliptical, $6-9\mu$ or $9 \times 7\mu$.

- A. RUBESCENS, P. (114).

Common in open woods, May to October. Varies from bright yellow to ruddy brown. Cap, up to 8.5 in. broad. Occasionally deformed, covered with a white fungus (*Hypomyces inaequalis*, Pk). See, Mus. Rep. 53, p. 855-1899. Edible.

Spores, $6-9 \times 6-7\mu$.

- A. ONUSTA, Howe, (P. — 374). Journal Myc. 1887, p. 32; Peck's Mus. Rep. 53, p. 839.

Rare, Forest park, July 14, 1899; Calvary cemetery, June 25, 1900.

- A. ONUSTA, Howe (P.— 1075), "white form."

Aug. 4, 1903, Monarch, St. Louis Co.

Spores, $9-12.5 \times 6\mu$.

A. FROSTIANA, Pk. (P. — 483).

Rare. Forest park and Calvary cemetery, June and August, 1899, 1900, 1903. Said to be very poisonous. Mus. Rep. 33.

Spores, subglobose, smooth 6-8 μ .

A. COTHURNATA, Atk. Pk. (P.— 342).

Meramec Highlands, June 28, 1899; Allenton, Aug. 25, 1899, by G. W. Letterman; Chain of Rocks, June 21, 1904. The volva is characteristic. Atkinson, "Mushrooms, a Study of," 1900.

Spores globose and subglobose, 8-9 μ .

A. RADICATA, Pk. (P. — 659).

York Co. Pa., Sept. 26, 1899. Bull. Torr. Bot. Cl. 1900 p. 609. I eat of this raw and found no ill effects. It has the taste and smell of a *Lepiota*. This is one species of but two distant from St. Louis, introduced into this Catalogue for the sake of annotation.

Spores, 8-9 \times 6 μ .

A. PHALLOIDES, Fr. (P. — 1172).

Chain of Rocks, June 21 and July 7, 1904.

"Dwarf gray-brown form."

Spores, globose 7.5-9 μ .

A. RAVENELLII, B & C. (1251).

Meramec Highlands, Sept. 30, 1905. Single. See Ann. & Mag. Nat. Hist. Vol. 4, 3d. Series, p. 284.

Spores, white, globose, 6 μ and elliptic, 6-9 \times 5-6 μ , rough, nucleate.

A. MAGNIVELARIS, Pk. (P. — 996).

Creve Coeur, Sept. 11, 1902. Single, on the ground, in woods. Peck's 50th Mus. Rep. p. 96.

Spores, globose 6-7 and subglobose 6-8 \times 6 μ .

A. MUSCARIA, Fr. (P. — 1174).

See Peck's Mus. Rep. 1901, Bull. 54, p. 961, and Bull. 75, p. 22, 1904. Important remarks in the last.

"A form near variety formosa."

Spores, elliptic, 6-9 \times 5-6.5 μ .

AMANITOPSIS.

- A. VAGINATA, Bull. (113), Peck's Mus. Rep. 23, p. 69.
 Common in open woods and parks, May to October.
 Usually gray or light yellowish brown, occasionally white.
 Wholesome and delicate.
- A. VOLVATA, Pk. ? (1102).
 Woods, Aug. 29, 1903. Rare. Peck's Mus. Rep.
 24, p. 59.
 Spores, $6-7 \times 4.5$ and $4-5\mu$.
- A. VOLVATA ELONGATA, Pk. (P. — 405).
 Forest Park bottom ground, June, July, 1899; woods,
 Ashby road Sept. 2, 1902; Allenton, Aug. 1899, by
 G. W. Letterman. Rare. Peck's Mus. Rep. 53, p. 856,
 pl. A.
 Spores, $9-11 \times 5-6\mu$, nucleate.
- A. FARINOSA, Schw. (P. — 117).
 Range the same as *A. vaginata*.
- A. AGGLUTINATA, B & C ? (1173).
 Chain of Rocks, June 24, 1904. Syll. Vol. v. p. 23.
 Spores, smooth, subglobose $8 \times 6\mu$.
- A. VELOSA, Pk. (1233) ?
 Chain of Rocks, Sept. 23, 1905. A colony on high
 grassy bank, open woods. (Bull., Torr., Cl. Vol. 22,
 p. 485).
 Spores, elliptic, $12 \times 6-7\mu$, one end often acute. Agrees nearly
 with description except spores.

LEPIOTA.

- L. PROCERA, Scop. (P. — 161).
 Common but not abundant. Edible. Peck's Mus. Rep.
 35, p. 152.
 Spores elliptic, $11-13 \times 9\mu$.

L. FELINA, Pers. (P. — 163).

Bellefontaine cemetery. October, 1898, 1900, 1902;
and a single specimen at Creve Coeur, Sept. 14, 1903.
Rare. Mus. Rep. 35, p. 156.

L. FUSCOSQAMEA, Pk. (P. — 163).

Same plant as preceding, later determined. Mus. Rep.
35, p. 156, and Bull. Buff. Soc. Nat. Sci. p. 41. 1873.
Edible.

Spores, $4.5-6 \times 2.5-3\mu$.

L. FELINOIDES, Pk. (P. — 464) n. sp.

Forest park, low ground, now covered by World's
Fair buildings, August, 1899. Rare. Bull. Torr. Bot.
Cl. Dec. 1900; Sacc. Vol. vi. p. 9.

Spores, $5-7 \times 4\mu$.

L. NAUCINOIDES Pk. (P. — 503).

Common, though rarely abundant. Edible. Mus.
Rep. 35, p. 160.

Spores, 9×6 and $6-7\mu$.

L. ACUTESQUAMOSA, Weinm. (P. — 643).

Common, season of 1902. Peck's Mus. Rep. 35, p.
154.

Spores, $6-7 \times 3-3.5\mu$.

L. CLYPEOLARIA PYGMEA, Pk. (P. — 453) *new variety*.

In damp, shady places, Aug. 1899; June, 1902.
Color, yellow. Edible.

Spores, $10-13 \times 3.5-4\mu$, one end acute.

L. CRISTATA, A and S. (P. — 203).

Common, Aug. to Oct. Peck's Mus. Rep. 35, p. 155.
Spores, $6-8 \times 3-4\mu$, one end acute.

L. CRISTATELLA, Pk. (P. — 462).

In low, shaded ground, small, white. Aug. 1899;
June, 1902. Mus. Rep. 31, p. 31; and 35, p. 163.

Spores, elliptic, $6-7.5 \times 4\mu$.

- L. CAERULESCENS, Pk. (P. — 454).
 Habitat same as preceding. July and Aug. Varies from white to brown — scaly. Changes color to green-blue. Bull. Torr. Bot. Cl. p. 63. 1899.
 Spores, elliptic, $5-7 \times 4\mu$.
- L. RUBROINCTA, Pk. (P. — 452).
 Aug. and Sept. 1899. Creve Coeur, 1902, very abundant. Edible. Very delicate. Peck's Mus. Rep. 35, p. 155.
 Spores, ovate-elliptic, $6-8 \times 4-4.5\mu$.
- L. RORULENTA, Panir. (P. — 165).
 O'Fallon and Walnut parks; Sept. and Oct. 1898. Syll. Vol. v. p. 43. Rare.
- L. CEPAESTIPES, Sow. (1109).
 Valley Park, Aug. 16, 1903. Rare. Mus. Rep. 35, p. 158.
 Spores, broadly elliptic $7-10 \times 6-7.5\mu$.
- L. CEPAESTIPES CRETACEA (Bull) Sacc. (P. — 164).
 On dumped rubbish, or manure, also on rotten wood. Oct. 1898; August, 1899. Pure white, very mealy and fragile.
 Spores, $7-9 \times 5-6.5\mu$, one end, often, acutish.
- L. AMERICANA, Pk (364).
 On trunks of black oak, and on ground near manure. Rare. Edible. Mus. Repts., 23, 1869; 35, p. 159; 49. 1896. — pl. 24.
 Spores, $7-9 \times 6-7\mu$ subglobose.
- L. OBLITA, Pk. (P. — 973).
 Creve Coeur, wooded hillside, Sept. 6, 1902. Rare. Mus. Repts. 26, p. 50; 35, p. 163, and Vol. I. Bull. Buff. Soc. Nat. Sci. p. 41. 1873.
 Spores, $4-6 \times 3\mu$.
- L. MIAMENSIS, Morg. (P. — 869).
 "Smooth variety."
 Bellefontaine cemetery, July 8, 1902. Rare. Peck's Mus. Rep. 50, p. 97.
 Spores, $6 \times 4\mu$.

L. FRIESII, Lasch. (P. — 871).

Creve Coeur, July; Calvary cemetery, Aug. 1902.
Rare. Mus. Rep. 35, p. 153.
Spores, $7-9 \times 3-4.5\mu$.

L. MORGANI, Pk. (1108).

Near DeHodiamont Sta. Aug. 21, 1903. Rare. Eaten raw by two children, they became very sick. In Myc. Notes, 256, Mr. Lloyd says *Agaricus gracilentus* (Kromb.) Bres. is a synonym.
Spores, unsymmetrically elliptic, $9-12 \times 6-7.5\mu$, greenish.

L. MACULANS, Pk. (P. — 1098) n. sp.

Woods, Forsythe road, Aug. 16, 1903. Rare. Bull. Torr. Bot. Cl. 32. 1905.
Spores, $7-10 \times 4.5-6\mu$, nucleate, one end apiculate.

L. BRUNNESCENS, Pk. (P. — 863) n. sp.

Bellefontaine and Calvary cemeteries, July and August, 1902. Also, Forsythe road, Aug. 18, 1903. Open woods. Whitish at first, turns blackish-umber. Rare. Bull. Torr. Bot. Cl. 31. Apr. 1904.
Spores, $7-9 \times 3-4\mu$, nucleate.

L. GLATFELTERI, Pk. (P. — 855) n. sp.

Creve Coeur, July, Aug. Sept. 1902. Open woods. Rare. Bull. Torr. Bot. Cl. 31. Apr. 1904.
Spores, fusiform, $7-9 \times 3-4\mu$.

L. GRANULOSA, Batsch (P. — 1005).

Open woods, on Ashby road, 1903. Rare. Peck's Mus. Rep. 35, p. 161.

L. ERIOPHORA, Pk. (P. — 923).

Moselle, Mo., July 1902; Creve Coeur, Aug. and Sept. Very small, on bottom ground, later, much larger on high ground. Rather abundant. Bull. Torr. Bot. Cl. 30. Feb. 1903.

L. NUDIPES, Pk. (P. — 1176) n. sp.

Forsythe woods, July 12, 1904. Rare. Bull. Torr. Bot. Cl. 33. 1906.
Spores, elliptic, $5-6 \times 3-4\mu$.

ARMILLARIA.

A. MELLEA, Fr. (P.—201).

Common from August to frost. Very variable. Excellent for eating. Mus. Rep. 43, p. 42; Syll. Fung. Vol. v. p. 80.

TRICHOLOMA.

T. ALBUM (Schaeff.) Fr. (P.—250)

O'Fallon park, at a stump, Aug. 1898; Meramec Highlands, Sept. 30, 1905.

Spores, subglobose, $5-6 \times 4-5\mu$, nucleate.

T. PERSONATUM, Fr. (781).

Rather common. Aug. to Nov. In moist, shady places. Edible. Mus. Rep. 44, p. 60; 48, p. 170. See important remarks in Rep. 54, p. 165, 1900.

Spores, pale, salmon color, elliptic, $6 \times 3\mu$.

T. NUDUM, Bull. (678).

Calvary cemetery, June and July. Pileus $1-1\frac{1}{2}$ in. broad.

Spores, subglobose, 4.5μ mostly, and some 6×4.5 .

T. MELALEUCUM, Pers. (P. — 788).

June to Nov. Solitary in woods and waste ground. Plentiful on lawn, Tower Grove park, 1903–1904. Varies from white to gray. Edible.

Spores, $6-8 \times 4-6\mu$.

T. VISCOSUM, Pk. (P. — 857) n. sp.

River bottom, North of Baden, only 5 specimens. Aug. 31, 1903. Rare. Bull. Torr. Bot. Cl. Apr. 1904.

T. RUSSULA, (Schaeff.) Fr. (P.—1242).

Meramec Highlands, Sept. 25, 1905, in woods, rather abundant. Mus. Rep. 55, pl. 77, 1902. Edible.

Spores, elliptic, $6 \times 3-4\mu$.

T. INAMOENUM, Fr. ? (810).

White. Known by its foetid smell. Solitary. Sept. and Nov. Forest park. Rare.

Spores, $6-7 \times 4.5\mu$.

T. EQUESTRE, Linn, (1809)?

Meramec Highlands, Nov. 11, 1905.

Spores, subglobose, $4-6\mu$.

CLYTOCYBE.

C. CANDICANS, Pers. (P.—94).

Common, on shaded leaf-covered ground July to October.

Spores, $5 \times 3\mu$.

C. DEALBATA, Sow. (1245).

Bellefontaine cemetery, Sept. 19, 1905. On the grass.

Spores, elliptic $4-5 \times 3\mu$.

C. VIRENS, (Scop.) Fr. (P. — 393).

Common, Aug. to Oct. Habitat, as *C. candicans*.

Spores, elliptic, $6-7 \times 3-4\mu$.

C. INFUNDIBULIFORMIS, Schaeff. (P. — 99).

June to October. In woods, on dumpings, and dead wood. Not plentiful. Edible.

Spores, $3-5 \times 2-3\mu$.

C. OCHROPURPUREA, Berk. (P.—248).

June to October. Open woods. Varies extremely in size. Edible.

Spores, subglobose, rough, $6-8\mu$.

C. LACCATA (Scop.) Fr. (P.—249).

Common, May to Fall. Open woods. Edible. Peck's Mus. Rep. 41.

Spores, globose, echinulate, $7-9\mu$.

C. MONADELPHA, Morgan, (P. — 568).

Common, July to October. At stumps, also, from underground roots. Edible. Mus. Rep. 51, p. 302, pl. 51. See, also, interesting remarks by Lloyd, — Notes, No. 3 p. 17.

Spores, $6-7.5 \times 4.5\mu$.

C. ILLUDENS, Schw. (P. — 100).

June 8 to frost. Very common. At stumps. Edible, if scalded in salt water, a little vinegar added. Peck's Mus. Rep. 49, p. 65: pl. 49.

Spores, globose, $3-3\frac{1}{2}\mu$.

C. ECCENTRICA, Pk. (P. — 800).

Rather common, Aug. to Nov. On much decayed wood. Has penetrating smell. Bull. Torr. Bot. Cl. p. 321. 1898.

Spores, nucleated, $6-9 \times 4-5\mu$.

C. ADIRONDACKENSIS, Pk. (P. — 999).

Creve Coeur, Sept. 1902-3. On leafy ground. Peck's Mus. Rep. 54, p. 174: pl. 69; 23, p. 77.

Spores, $6-9 \times 4-5\mu$, nucleated.

C. ECTYPOIDES, Pk. (P. — 886).

Monarch, St. Louis Co. July and August, 1902-3; also, by Mr. Letterman, at Allenton Mo. Aug. 1899. Mus. Rep. 24, p. 61.

Spores, subglobose. $5-7\mu$.

C. MULTICEPS, Pk. (P. — 683).

Creve Coeur and Calvary cemetery. On rich low ground. Single, or in compact stools, Oct. and Nov. 1899, 1900, 1902. I regard the quality excellent. Mus. Rep. 43, p. 17.

Spores, globose, 6μ .

C. TRUNCICOLA Pk. ? (812).

Forest park, Sept. 30, 1900. On elm trunk.

The 3 species that follow, Prof. Peck made no report on. I insert them with doubt.

- C. FLACCIDUS, var. lobatus, Sow. (908).
 Monarch, Mo. July, 1902. See Cke. pl. 137.
 Spores, $5 \times 3\mu$.
- C. HIRNEOLA, Fr. (1008).
 On the ground, and on a stump.
 Spores, $4-4.5\mu$. subglobose.
- C. ANGUSTISSIMA, Fr. or near it (1047).
 Calvary cemetery, Oct. 1902.
 Spores, $3-4.5 \times 2-3\mu$, elliptic, nucleated.

PLEUROTUS.

- P. SAPIDUS, Kalchb. (P. — 78).
 Common from April to frost. Most frequenting,
 Hickory and Willow. Edible. Mus. Rep. 39, p. 61.
 Spores, pale lilac, $8-9 \times 3-4\mu$.
- P. CANDIDISSIMUS, B and C. (P. — 477).
 Forest Park, Aug. 1899. On dead bark of a living
 elm; also, on trunk, Calvary cemetery, July, 1899.
- P. PETALOIDES, (Bull.) Fr. (P. — 335).
 Creve Coeur, June 1899, 1902, on trunk. Mus. Rep.
 39, p. 64.
 Spores, globose, $3-4\mu$.
- P. OSTREATUS, Jacq. (1322).
 Jefferson Barracks, Nov. 27, 1905. On the ground.
 Spores, white, narrowly elliptic, one end acute, $7-9 \times 3-4\mu$.
- P. ULMARIUS, Fr. (820).
 Creve Coeur, Oct. 1901-2; Monarch, in July; Forest
 park. Rare. Edible. Mus. Rep.
 Spores, $4.5-6 \times 3\mu$.
- P. GEOGENIUS, DC. (P. — 79).
 O'Fallon park on grassy knoll; Bellefontaine ceme-
 tery, Oct. 1898, 1902.
 Spores, $6-8 \times 5\mu$.

P. ATROCAERULEUS GRISEUS, Pk. (P. — 1043).

Creve Coeur, 9-29-'02. On a trunk. Rare. Peck's
Mus. Rep. 39, p. 65.

Spores, elliptic, $7 \times 5\mu$.

P. APPLICATUS, Batsch. (715).

Meramec Highlands, Jan. 14th, 1900. Under dead
bark of oak trunk.

COLLYBIA.

C. RADICATA, Rehh. (P. — 241).

Common. Solitary. In woods. Never numerous.
May to frost. Edible. Mus. Rep. 23, p. 79.

Spores, $12 \times 8-9\mu$.

C. PLATYPHYLLA, Fr. (139) Fr.

Rather common. At stumps and much decayed
trunks. Chiefly in early summer. Sometimes, 6-8 in.
broad. Edible.

Spores, globose, 6μ , or elliptic, $7 \times 5\mu$.

C. DRYOPHYLLA, (Bull.) Fr. (P. — 1135).

Tower Grove park, Sept. 17, 1903. On lawn.

Spores, $5-8 \times 3.5-4.5$.

C. STRIATULATA, Lloyd. (P. — 888).

Creve Coeur July 14, 1902; Monarch, July 15, 1902,
and same spot, Aug. 4, 1903. On leaves, in a moist
ravine. See Myc. Notes, No. 5, Dec. 1900. Lloyd.

Spores, $6-7 \mu$ long.

C. STRICTIPES, Pk. (989).

Creve Coeur, Sept. 1902-3. On leaves. Abundant.
Mus. Rep. 41, p. 62.

Spores, one end apiculate, $5-7 \times 3-4\mu$.

C. LIGNIARIA, Pk. (P. — 984).

Creve Coeur, Sept. 1902; Monarch, May 1899. On
the ground and decayed trunks. Mus. Rep. 54, p. 145.
1900.

Spores, globose, $6-7\mu$ and elliptic, $9 \times 6\mu$.

C. AMABILIPES, Pk. (P. — 845).

Creve Coeur, June and July, 1902. On leaves. Rare.
Bot. Gazette, p. 216. 1879.

C. ACERVATA, Fr. (P. — 122).

Common, all the season. On damp, leaf-covered
ground.

Spores, $6-9 \times 3.5-4.5\mu$, one end apiculate.

C. VELUTIPES, Curt. (173).

Common. On elm and willow, mostly. Early and
late season. Excellent. Mus. Rep. 23, p. 79.

Spores, $6 \times 3\mu$.

C. ZONATA, Pk. (131).

July and August. On dead sticks. Rare. Mus. Rep. 24,
p. 61. See also, remarks by Lloyd, Myc. Notes, No. 5,
p. 43.

Spores, elliptic, $5-6\mu$ long.

C. STIPITARIA, Fr. (1113).

O'Fallon park, June 1903. On the ground. Rare.

Spores, $6 \times 4\mu$.

C. MYRIADOPHYLLA, Pk, (978).

Creve Coeur, Sept. 1902-3. On a much decayed
trunk. Rare. Mus. Rep. 25, p. 75; Bull. Buff. Soc.
Nat. Sci., 1873.

spores, $3-4 \times 2\mu$.

C. XANTHOPODA, Fr. ? (1039).

Creve Coeur, Sept. 29, 1903. On wood. Rare.

Spores elliptic, $7-9 \times 6\mu$.

C. COLOREA, Pk. ? (935).

Creve Coeur, 1902. Peck's Mus. Rep. 26, p. 54.

MYCENA.

M. GALERICULATA, Scop. (663).

Common. Aug. to Oct. On stumps and trunks.
Edible.

Spores, subglobose, about 7μ . or $7-8 \times 6\mu$.

- M. GALERICULATA, var. calopus, Fr. ? (662).
On stump, Oct. 13, 1899.
Spores, $7-8 \times 6\mu$.
- M. GALERICULATA, Fr. (1064), pale form. Maline creek,
Sept. 31, 1902.
Spores, 7 or $8.5 \times 7\mu$.
- M. LEAIANA, Berk, (P. — 254).
On rotten trunks, but somewhat rare. Mus. Rep. 24,
p. 62.
Spores, $6-8 \times 6\mu$.
- M. HAEMATOPA, Pers. (256).
Rather common. On trunks, Sept. 1898, 1902-3.
Mus. Rep. 24, p. 63.
Spores, $7-8 \times 6\mu$.
- M. LEPTOPHYLLA, Pk. (P. — 944).
“A radicating variety.” Shaded, leaf-covered ground,
Sept. to Oct. Mus. Rep. 24, p. 63.
Spores, $6-7 \times 4.5\mu$.
- M. IRIS, Berk. (1046).
Creve Coeur, Sept. 29, 1902. Rare.
Spores, globose, $5-7\mu$.
- M. DENTICULATA, Pk. (P. — 1100) n. sp.
Creve Coeur and other places, Sept. 1902-3. On the
ground and rotten trunks. Bull. Torr. Bot. Cl. 32. 1905.
Spores, $6-9 \times 4.5\mu$.
- M. FILOPES, Bull. ? (860).
Forest park, Aug. 4, 1898; Creve Coeur, July 2, '02.
On rotting leaves.
Spores, $5-7 \times 5\mu$.
- M. — sp. (1199).
Forsythe woods, Aug. 16, 1903. This and preceding
one referred to Prof. Peck, who made no report.
Spores, $6 \times 4.5\mu$.

OMPHALIA.

- O. CAMPANELLA, (Batsch.) Fr. (P. — 472).
Common. On very rotten trunks. June to August.
Mus. Rep. 45, p. 38 ; Syll. Fung. Vol. v. p. 327.
Spores, $6-7 \times 3-4\mu$ (Peck).
- O. PYXIDATA, (Bull.) Fr. (P. — 409).
Forest park, July 28, 1899, on the base of a live elm.
Mus. Rep. 45, p. 36 ; Syll. Fung. Vol. v. p. 313.
- O. FIBULA, (Bull.) Sow. (P. — 286).
Jefferson Barracks, June 2nd, 1899. On the ground.
Spores $4 \times 2\mu$ (Peck).
- O. SUBCLAVATA, Pk. (P. — 101) n. sp.
Forest park, July and August, 1899 ; Meramec Highlands. Plentiful, on dead twigs. Bull. Torr. Bot. Cl. Dec. 1900, p. 27.
- O. — sp. (976).
Creve Coeur, Sept. 6, 1902.
- O. — sp. (1200).
Forsythe woods, Aug. 16, 1903.
This and the preceding referred to Peck. No report.

RHODOSPORAE.

VOLVARIA.

- V. BOMBYCINA, Schaeff. (333).
Jefferson Barracks, June 2, 1899. Single specimen, in a decayed cleft of a living maple. Pileus 8.5×6.5 in. Again, on elm at Creve Coeur 1905. Said to be edible. Spores, elliptic, nucleate, $6-7.5 \times 5-6\mu$.
- V. UMBONATA, Pk. (P. — 1073).
On lawn, Mo. Bot. Gardens, Aug. 10, 1903 ; June 28, 1904. See Myc. Notes, Feb. 1899, Lloyd.
Spores, $3-4.5$ and $6 \times 4.5\mu$.

V. STRIATULA, Pk. (896).

Single specimen. On bottom ground, July 19, 1902, Maline Creek. Also, home yard, 1905. Bull. Torr. Bot. Cl. Vol. 22, p. 488; Volvae, Lloyd, 1898.

Spores, elliptic, uninucleate, $5-6 \times 4.5$

PLUTEUS.

P. CERVINUS, (Schaeff.) Fr. (166).

Common throughout the season, mostly on wood, but also on the ground. In clusters on rotting sawdust. Though rather insipid, may be coaxed into a palatable dish. Varies much in color, from white to umber. Smooth or squamous.

Spores, elliptic, nucleate, $5-7.5 \times 4-5\mu$.

P. CERVINUS, VAR. ALBUS (1134).

1903. On the ground.

Spores, globose, $4-5\mu$ and elliptic, $5-6 \times 4\mu$.

P. CERVINUS VAR. VISCOSUS, Lloyd (384).

See Myc. Notes, Feb. 1899. Forest and O'Fallon parks, July, 1899.

Spores, nucleate, $5-7 \times 4-5\mu$.

P. UMBROSUS, Pers. (P. — 211.)

In pasture, Oct. 1898. Mus. Rep. 38, p. 135.

Spores, subglobose, $4-5$ and $6-5\mu$.

P. LONGISTRIATUS, Pk. (P. — 969).

Creve Coeur, Aug. 22, 1902; Maline creek, Aug. 31, 1902.

On wood and ground.

Spores, subglobose, nucleate, $5-6\mu$ and $7 \times 6\mu$.

P. ADMIRABILIS, Pk. (843).

Creve Coeur, July and Sept. 1902-3. On rotten trunks and leaves. Mus. Rep. 24, p. 64; 38, p. 137.

Spores, subglobose, $5-7.5\mu$.

P. UMBONATUS, Pk. ? (357).

Forest park, July, 1899.

Spores, subglobose, $5-7\mu$, occasionally, $8 \times 7\mu$.

- P. PHLEBOPHORUS, Ditm. ? (334).
 Forest park and Creve Coeur, June and July, 1898-99.
 Spores, subglobose, 4-5 and $6 \times 4 \mu$.
- P. NANUS, Pers. ? (385).
 Several localities. On the ground. Mus. Rep. 38
 p. 136.
 Spores, nucleate, 5-6 μ and $6 \times 4-5 \mu$.

ENTOLOMA.

- E. NIGRICANS, Pk. (P. — 771) n. sp.
 Forest park, Oct. 20, 1900.
 Only one locality, creek bottom, now covered with
 World's Fair buildings. Bull. Torr. Bot. Cl. Feb. 29,
 1902.
 Spores, angular-globose and subglobose, $7-10 \times 7$ and $7-9 \mu$.
- E. GRAYANUM Pk. (P. — 965).
 Common. July to September.
 Moist, shady places. Very variable in size and color.
 Mus. Rep. 24, p. 64.
 Spores, irregular, angular, $7-9 \mu$.
- E. — sp. (1132).
 Monarch, Mo. July 23, 1902.

CLITOPILUS.

- C. SPHAEROSPORUS, Pk. (P. — 941). n. sp.
 Creve Coeur, Aug. and Sept. 1902-3. In wooded
 ravine. Bull. Torr. Bot. Cl. 31, Apr. 1904.
 Spores, subglobose, 4.5-7 μ .
- C. PRUNULUS, (Scop.) Fr. (P. — 1086).
 Creve Coeur, Aug. 20, 1903. White. Mus. Rep. 42,
 p. 41.
 Spores, $9-11.5 \times 4.5-6 \mu$.
- C. UNDERWOODII, Pk. (P. — 1087).
 Valley Park, Mo. Aug. 16, 1903. Mus. Rep. 49, p. 18.
 Spores, $4-5 \times 3 \mu$, ovate.

C. MICROPUS, Pk. (P. — 1256).

Meramec Highlands, Oct. 2, 1905. Rare. Edible.

Mus. Rep't. 55, p. 970, pl. 78. 1902.

Spores, irregular, angular, $9-12 \times 5-7\mu$.

C, ABORTIVUS, B & C. (P. — 1294).

Middlebrook Mo. Aug. 13, 1905. Woods. Edible.

Mus. Rep. 55, pl. 78. 1902.

Spores, irregular, angular, nucleate $7-9 \times 6\mu$.

C. — sp. (1055).

Creve Coeur, July 10, 1902. No report from Peck.

Spores, $4.5-6 \times 3-4\mu$.

CLAUDOPUS.

C. NIDULARIS, Pk. (P. — 681).

Pleurotus nidularis, Fr.

Forest park and Creve Coeur, May to November. On willow trunks.

Spores, curved, elliptic, $6 \times 3\mu$.

BOLBITIUS.

B. TENER, Berk. (P. — 1124) "probable".

Tower Grove park, June 2, 1903.

Spores, very variable, globose or elliptic, $8-14.5 \times 7.5-9\mu$.

B. GLATFELTERI, Pk. (P. — 836) n. sp.

Creve Coeur and East St. Louis, May, 1902; Tower Grove park, on lawn, May, 1903. Bull. Torr. Bot. Cl. 30, Feb. 1903.

Spores, $12-13 \times 7.5-9\mu$.

NOLANEA.

N. — sp. (995).

Creve Coeur, Sept 11, 1902.

N. PICEA, Kalchb. (P. — 1230).

On my fern bed Sept. 21 and Oct. 10, 1905.

Spores, slender, elliptic, $9 \times 3-4\mu$.

ECCILIA.

- E. — sp. (931).
Creve Coeur, Aug. 23, 1902.

OCHROSPORAE.

PHOLIOTA.

- P. PRAECOX, (Pers. Fr.) P. — 192.
Forest Park and Creve Coeur, May to July, 1898, 1900, 1902, and March 26, 1905. On trunks and ground.
Spores, $6-8.5 \times 5-6\mu$.
- P. ADIPOSA, Fr. (P. — 1117).
Creve Coeur, Oct. 1, 1903 and Sept. 29, 1904, on black oak trunk. Edible, (McIlvaine) Mus. Rep. 49, p. 60; pl. 46. Rare.
Spores, $7.5-9 \times 5-6\mu$.
- P. LUTEA, Pk. (P. — 796).
St. Louis, only one locality, October, 1900, 1902. Mus. Rep. 51, p. 288.
Spores, $6-7 \times 5-6\mu$.
- P. COMOSA, VAR. ALBA, Pk. (P. — 1003).
Calvary cemetery, Sept. 20, 1902. On coniferous trunk, growing from both, sawed ends.
Spores, $6-7.5 \times 4-5\mu$.
- P. DETERSIBILIS, Pk. (P. — 874).
Creve Coeur, July, 1902. On much decayed wood. Rare. Mus. Rep. 28, p. 49.
- P. MARGINATA, Batsch. (P. — 1058).
On very rotten trunks, early and late season. "Excellent quality," (McIlvaine). Cke. Hdb'k. p. 148; illust. pl. 372.
Spores, $6-8.5 \times 4-6\mu$.
- P. AUTUMNALIS, Pk. (P. — 1033).
On rotten trunks, late season. Appears to me the same as the preceding.
Spores, $7-9 \times 5-6\mu$.

P. AGGERICULA Pk. (P. — 1226).

Creve Coeur, Sept. 21. 1905. On the ground, in woods, a few specimens every year since 1902, always in September. Mus. Rep. 24, p. 67.

Spores, narrowly ovate, or fusiform, nucleate, $12-15 \times 5-6\mu$.

P. DESTRUENS (1326).

Arboretum, 1874, on wood. Specimen in herb. Mo. Bot. Gardens. Identified by Farlow.

FLAMMULA.

F. SPUMOSA, Fr. (P. — 676).

Common. Oct. and Nov. 1899, 1900-2. On wood or ground.

Spores, subglobose, $4.5-6\mu$.

F. LUBRICA, Fr. (P. — 777).

Forest park, Calvary cemetery, Oct. 24, and Oct. 9, 1900.

On elm and hickory. Caespitose.

Spores, subglobose $4.5-6 \times 5\mu$.

F. MULTIFOLIA, Pk. (P. — 1114) n. sp.

Monarch, Mo. Aug. 4, 1903; July 17, 1904, on trunk. Bull. Torr. Bot. Cl. 32. 1905.

Spores, elliptic, $6-7 \times 4-5\mu$, nucleate.

F. UNDERWOODII, Pk. (P. — 1115).

Bellefontaine cemetery, Nov. 7, 1903. On wood.

Spores, $6-7 \times 4-5\mu$.

F. BRAENDLEI, Pk. (P. — 1008).

Forest park, May 7, 1899; Creve Coeur, Sept. 21, 1902. On trunk. Bull. Torr. Bot. Cl. 31, Apr. 1904.

Spores, $6-7.5 \times 3-4\mu$.

F. CONISSANS, Fr. (P. — 675).

At base of elm and maple, usually a caespitose cluster. Rare.

Spores, $6-7.5 \times 4.5-6\mu$.

F. ECCENTRICA, Pk. (P. — 784) n. sp.

Forest park Oct. 26, 1900. On wood. Bull. Torr.
Bot. Cl. 31. Apr. 1904.

Spores, elliptic, nucleate, $6-7.5 \times 5\mu$.

F. HIGHLANDENSIS, Pk. (P. — 1020).

Bellefontaine cemetery, Sept. 25, 1702. A colony on
a stump; Forest park, Apr. 1903, on the ground.
Mus. Rep. 50, p. 138.

Spores, $6-7 \times 4-5\mu$.

F. SAPINEA, Fr. (P. — 392).

“Or near allied.” F. Underwoodii?

Allenton Mo. July 24, 1899 by G. W. Letterman, “on
wood;” also, at Creve Coeur, Sept. 19, 1904, on trolley
post.

Spores, nucleate, $6-7.5 \times 4.5\mu$.

F. INOPODA Fr. ? (677).

Forest park, Nov. 20, 1899, at pine stump.

Spores, $7.5-9 \times 5-6\mu$.

F. — sp. (805).

Forest park, Apr. 25, 1900. Pale tawny white.

Spores, $6-8 \times 5-6\mu$, nucleate.

F. — sp. (179).

Allied to F. braendlei.

The last 3 species referred to Peck, without report

F. — sp. (486).

HEBELOMA.

H. MESOPHAEUS, Fr. (P. — 167).

College view, and Creve Coeur, 1898-'99-'01.
October.

Spores, elliptic, $6-7.5 \times 4-5\mu$.

INOCYBE.

I. RIMOSA, (Bull.) Fr. (P. — 1193).

Creve Coeur, Sept. 21, 1902. Woods, on the ground.
Mus. Rep. 23, p. 95.

Spores, $7-9 \times 5-6\mu$.

- I. *UMBONINOTA*, Pk. (P. — 176).
 Bellefontaine cemetery, Oct. 9, 1898, on the ground.
 Mus. Rep. 38, p. 87.
 Spores, nodulose, $7.5-8.7\mu$ (P).
- I. *MARGARITISPORA*, Berk. (P. — 304).
 Forest park and Creve Coeur. Mus. Rep. 41, p. 66.
 Spores, irregular-angular, $6-9 \times 4-6\mu$.
- I. *EUTHELOIDES*, Pk. (P. — 610).
 July and August, on the ground, different places.
 Mus. Rep. 32, p. 29; 37, p. 13.
 Spores, unsymmetrical-elliptic, nucleate, $9-10 \times 6\mu$.
- I. *ASTEROSPORA*, Quel. (P. — 1099).
 Forsythe woods, Aug. 16, 1903; Creve Coeur, Aug.
 20, 1903. Mus. Rep. 41, p. 66.
 Spores, warted, $6-9\mu$.
- I. *RIGIDIPES*, Pk. (P. — 1111).
 Forsythe woods, Aug. 18, 1903. Mus. Rep. 51, p.
 289.
 Spores, globose, echinulate, $8-9\mu$.
- I. *HIRSUTA*, Lasch, (1110).
 June to Sept. On the ground, many places.
 Spores, smooth, elliptic, $7-10 \times 5-6\mu$.
- I. *ALBODISCA*, Pk. (P. — 1194).
 Ramona park. July 9, 1904. On the ground. Mus.
 Rep. 51, p. 290.
 Spores, warted, very irregular, seldom roundish, 6 and $8 \times 6\mu$.
- I. *DESQUAMANS*, Pk. (P. — 1177) n. sp.
 Monarch, July 17, 1904; Creve Coeur, Aug. 20,
 1903. In woods. Bull. Torr. Bot. Cl. 33. 1906.
 Spores, irregular, angular, subglobose, $5-6$ and $6 \times 4.5\mu$.
- I. *PLUMOSA*, Bolt. (1180).
 Forsythe woods, July 13, 1904. Single.
 Spores, renoid-elliptic, $9-11.5 \times 4-5\mu$.
- I. *SUBOCHRACEA*, Pk. (P. — 1270).
 Meramec Highlands, Oct. 5, 1905. In woods. Mus.
 Rep. 54, p. 167 ?
 Spores, ovate-nucleate $7-9 \times 6\mu$.

I. Several species undetermined.

PHYLLOPORUS RHODOXANTHUS, (Schw.) Bres. (P.—1083).

Paxillus paradoxus, Cke., *Flammula paradoxus*, Kalchb., *Agaricus tammii*, Fr., *Agaricus pelletieri*, Lev., *Paxillus flavidus*, Berk., *Clitocybe pelletieri*, Gill, *paxillus tammii*, Pat., *Gomphidius rhodoxanthus*, Sacc. Vol. v. p. 1139, and Mus. Rep. 29, p. 43.

Ramona park, July 13, 1903; Chain of Rocks, Sept. 20, 1903. Open woods, grassy ground. Rare.

Spores, light brown, with tinge of green, elliptic, or narrowly ovoid, $9-11.5 \times 4-5\mu$.

The spores are measured as follows: by Peck, $10-15 \times 4.5-5.5\mu$; Sacc. $10-13\mu$; Bresadola, $10-16 \times 3.5-5\mu$; Massee, $20-22 \times 7-8\mu$!

CREPIDOTUS.

C. MOLLIS, (Schaeff.) Fr. (P.—330).

Common on trunks, June.

Spores, ferruginous-clay color, subglobose, $6-7.5 \times 4-5\mu$.

C. PUTRIGENA, B & C (P.—354).

Forest park, July 9, 1899. On rotting trunk. Mus. Rep. 39, p. 72.

Spores, rusty-brown, globose, $4-6\mu$.

NAUCORIA.

N. SEMIORBICULARIS, Bull. (P.—832).

Common in old pastures, and lawns. 1902-3. Mus.

Rep. 23, p. 93.

Spores, $11-13 \times 7-9\mu$.

N. TABACINA, DC ? (1128).

Forest park, May 4, 1900. On the ground.

Spores, elliptic, $8-10 \times 4-5\mu$.

N. UNICOLOR, Pk. (P.—1191).

Calvary cemetery, June 6, 1904. On wood and decaying leaves. Mus. Rep. 41, p. 68. 1887.

Spores, pale umber, ovoid, $6 \times 4.5\mu$.

N. Several species undet.

GALERA.

- G. RETICULATA, Pk. (P. — 684).
Calvary cemetery, Nov. 22, 1899. Mus. Rep. 54,
p. 150.
Spores, $7-9 \times 5\mu$.
- G. TENERA, Schaeff. (1129).
On horse dung, July, 1899. Mus. Rep. 46, p. 63.
Spores, $11-14.5 \times 7-10\mu$.
- G. LATERITIA, Fr. (P. — 736).
Forest park, June, 1900. Mus. Rep. 46, p. 62.
Spores, $11.5-14.5 \times 7-9\mu$.
- G. CAPILLARIPES, Pk. (P. — 854).
On lawn, Bull. Torr. Bot. Cl. 1899, p. 66.
Spores, $8.5-11 \times 7-8\mu$.
- G. COPRINOIDES, Pk. (1121).
Lawn, June 21, 1904. Mus. Rep. 26, p. 59, and 46,
p. 69.
Spores, elliptic, $6-7 \times 4.5$.
- G. OVALIS, Fr. ? (880).
East St. Louis Stock-yards, July 12, 1902.
Spores, elliptic-ovoid, $9-10 \times 5-6\mu$.
- G. — sp. (1130).
Creve Coeur, June 4, 1904. On new, cultivated
ground.
Spores, elliptic $7-9 \times 5-6\mu$.

TUBARIA.

- I. CONTRARIA, Pk. (P. — 797).
In pasture, near Walnut park, Oct. 30, 1900; Creve
Coeur, July 23, 1904.
Spores, ovate, nucleate, unsymmetrical, $7-9 \times 5-6\mu$.

PLUTEOLUS.

- P. ALEURIATUS, Fr. (P. — 930).
Creve Coeur, Aug. 23, 1902. On rotten trunks, and
ground.
Spores, nucleate, elliptic-unsymmetrical, $8.5-10 \times 5-6\mu$.

PORPHYROSPORAE.

PSALLIOTA.

P. CAMPESTRIS, L. (213).

Common, all through the season.

Spores, $4.5-6 \times 3\mu$.

P. CAMPESTRIS, VAR. HORTULANA, Auct. (786).

Forest park, Oct. 26, 1900.

Spores, $6-7 \times 4-5\mu$.

P. CAMPESTRIS, VAR. RUFESCENS, Berk.

Creve Coeur, Sept. 2, 1902. Rare.

Spores, $6-9 \times 4-5\mu$.

P. PLACOMYCES, Pk. (246).

Rather frequent in places somewhat shaded. Edible.

Mus. Rep. 29, p. 40; 36, p. 48.

Spores, $4-6 \times 3\mu$.

P. SYLVICOLA, Vitt. (247).

P. arvensis abruptus. Pk.

Common in moist shady places. In drying turns tawny yellow. Edible. Mus. Rep. 36, p. 47.

Spores, subglobose, $3-4.5\mu$.

P. RODMANI, Pk. (1323).

Near Sherman School, St. Louis, by Mr. Wm. R.

Maddern, 1905. Mus. Rep. 36.

Spores, $5-6 \times 4-5$. — Pk.

PILOSACE.

P. EXIMIA, Pk. (P. — 966).

Creve Coeur. Sept. 1, 1902. Single specimen, sent to Prof. Peck. Has an exceptionally bad smell. Mus. Rep. 24, p. 70; Bull. Torr. Bot. Cl. 75, p. 25. 1903.

Spores, reddish, $6.2 \times 4\mu$ (Peck).

STROPHARIA.

S. AERUGINOSA, (Curt) Fr. (P. — 773).

Frequent, never abundant. July to November. On wood and ground.

Spores, $5-7 \times 3-4\mu$, nucleate.

S. BILAMMELATA, Pk. (P. — 188).

On the ground, Oct. 7, 1898; on horse dung, 1902.

Bull. Torr. Bot. Cl., 1895, p. 204.

Spores, $9-11.5 \times 6-8\mu$.

S. SEMIGLOBATA, Batsch. (P. — 1096).

Creve Coeur, May 20, 1903; St. James, Mo., May 30, 1903. Judging from the size of the spores, this should

be S. STERCORARIA, Fr.

Spores, $15-20.5 \times 9-10\mu$.

S. — sp. (831).

River bottom Apr. 30, 1902.

Spores, $9-11.5 \times 5-6\mu$.

HYPHOLOMA.

H. PERPLEXUM, Pk. (P. — 152).

Common, at stumps, and on ground. Early and late season. Our form is scarcely edible, and fits better the described *H. sublateritius*. Mus. Rep. 23, p. 99; 49, p. 61: pl. 47.

Spores, $6 \times 3-4\mu$.

H. INCERTUM, Pk. (P. — 141).

Common on lawns. In woods, at stumps, all the season. Excellent. Mus. Rep. 29, p. 40; 1898, p. 676: pl. 58.

Spores, $7.5 \times 5.5\mu$.

H. HYMENOCEPHALUM, Pk. (P. — 378).

Smaller than the preceding, but resembling it. In shaded places, on sticks and ground. July to October Mus. Rep. 31, p. 34.

Spores, $6-7.5 \times 4.5\mu$.

H. CUTIFRACTUM, Pk. (P. — 993).

Creve Coeur, Sept. and Oct. 1902-3; May 20, 1904. On the ground. Bull. Torr. Bot. Cl. 1895, p. 490.

Spores, $7-10 \times 4.5$.

H. HIRTOSQUAMULOSUM, Pk. (P. — 846.)

Creve Coeur, June 8, 1902; Oct. 1, 1903, on trunk.
Rare. Vol. 1, Buff. Soc. Nat. Sci. p. 53; Mus. Rep.
25, p. 79.

Spores, nucleate, cymbiform, 6.25μ long (Peck).

H. SUBAQUILUM, Bann. (P. — 1019).

Bellefontaine cemetery, Sept. 25, 1902. A colony, in
a grassy road. Also, at College View. Mus. Rep. 44,
p. 70, 1890.

Spores, $4-5 \times 3-4\mu$.

H. ORNELLUM, Pk. (P. — 1067).

Creve Coeur, Aug. 23, 1902; Ramona park and
Forsythe woods. Common and plentiful, 1903. Mus.
Rep. 34, p. 42.

Spores, $6-7 \times 4.5\mu$.

H. VELUTINUM, Pers. (P. — 763).

Rather common. Late in the season.

Spores, $7-9 \times 6\mu$, ends acutish.

H. VELUTINUM, LEIOCEPHALUM, B & Br. (1017).

Calvary cemetery, Sept. 24, 1902. Very peculiar,
growing from an aborted mass of fungous material (*H.*
velutinum). A single plant springs from the centre of
the mass. Pileus dirty white, floccose-squamous,
slightly viscid, even, soft, spongy, brittle. Spores,
black.

H. STOREA VAR. CAESPITOSUS, Fr. ? (673).

Bellefontaine cemetery, from underground stump,
Oct. and Nov. three successive years, 1898-1899 and
1900. No report from Prof. Peck.

Spores, $4.5-6 \times 3-4.5\mu$.

H. HYDROPHILUM, (Bull) Fr. (P. — 1306).

O'Fallon park and Meramec Highlands, Oct. 29, 1905,
at stumps, and on the ground, plentiful. Edible.

Spores, umber brown, $4-6 \times 3-3.5\mu$.

DECONICA.

- D. COPROPHILA, (Bull) Fr. (P. — 955).
On horse dung, Aug. 30, 1902.
Spores, $11.7 \times 6-9\mu$, elliptic, with acutish ends.

PSILOCYBE.

- P. FOENISECHII, Pers. (P. — 1084).
Tower Grove park, May 11, 1903. Abundant, on
manured lawns.
Spores, $12-14 \times 7-8\mu$.
- P. — sp. (829).
- P. — sp. ? (P. — 1181).
Creve Coeur, June 25, 1904.
Spores, ovate, truncate base, $6-7.5 \times 4\mu$.

PSATHYRA.

- P. MULTIPEDATA, Pk. (P. — 787) n. sp.
Calvary cemetery, Oct. 1900-2-3, on grassy ground,
very abundant; Creve Coeur, on a stump, June 25,
1904.
Densely caespitose stools of one radicle. Edible. Bull.
Torr. Bot. Cl. 32. 1905.
Spores, $6-7.5 \times 4.5\mu$.
- P. — sp. Nos. 1116, 1119, 1120, and several others, undet.

MELANOSPORAE.

PANAEOLUS.

- P. SOLIDIPES, Pk. (P. — 199).
Common. On horse dung. Mus. Rep. 23, p. 101:
pl. 4.
Spores, $9-11 \times 7-9\mu$.

- P. PAPILIONACEUS, Pk. (P. — 372). Common. Usually on manured ground. Quite variable in color and size. Mus. Rep. 23, p. 101.
Spores, $11.5-14.5 \times 7-9\mu$. Acute ends.

COPRINUS.

- C. MICACEUS, Fr. (200).

Common and abundant, April to Nov., grows in temperature under 52° . At stumps and trees. Delicate. Mus. Rep. 23, p. 104.
Spores, $6-9 \times 5-6\mu$.

- C. COMATUS, Fr. (321).

Common. On rich or filled ground, throughout the season. Excellent. Mus. Rep. 23, p. 103.
Spores, $9-11 \times 7-9\mu$.

- C. ATRAMENTARIUS, Fr. (507).

Not as frequent as the preceding. Edible.
Spores, $7-9 \times 6\mu$.

- C. SQUAMASUS, Morg. (195).

Forest park, Aug. 8, 1899; June 3, 1900. On very rotten trunk. Quality inferior to the two preceding species. Jour. Cin. Soc. Nat. Hist., Vol. 6, p. 173: pl. 8.
Spores, $7-9 \times 5-6\mu$.

- C. QUADRIFIDUS, Pk. (P. — 380).

Maline Creek, a colony, on heap of flooded rubbish; July 17, 1899; Creve Coeur, July 14, 1904, on wood. Mus. Rep. 50, p. 106.
Spores, $7-9 \times 4-4.5\mu$.

- C. Plicatilis, Fr. ? (196).

O'Fallon park; on grassy ground.
Spores, $11.5-14.5 \times 9-10\mu$.

- C. EPIHEMERUS, Fr. ? (1178).

On lawn. Ep. 252.
Spores, $14-19 \times 9\mu$.

C. JONESII, Pk. ? (1169).

On horse dung. Bull. Torr. Bot, Cl. 22, p. 206.

Spores, $7-10 \times 5-6\mu$, one end apiculate.

C. PULCHRIFOLIUS, Pk. ? (1179). May 10, 1904, home yard.

Mus. Rep. 29:41.

Spores, umber, oblong-elliptic, $7-8.5 \times 4.5-6\mu$.

C. FIMETARIUS, Fr. ? (1206).

On cow dung, in hot-house, March 18, 1905. Ep. 245,

Spores, elliptic, $12-13 \times 6-7\mu$.

C. Several more, undet.

PSATHYRELLA.

P. DISSEMINATUS, Fr. (P. — 366.)

Common, Mus. Rep. 23, p. 103.

The spores are not black, but umber.

P. — sp. (783) undet.

CORTINARIUS.

C. DISTANS, Pk. (P. — 1125).

Forsythe woods, Aug. 16, 1903-4. On the ground.

Mus. Rep. 23, p. 111.

Spores, $7-9 \times 5-6\mu$.

C. CALOCHROUS, Fr. ? (1267).

Meramec Highlands, Oct. 5, 1905.

Spores, elliptic, nucleate, an end often acute, $7-8 \times 4-5\mu$.

C. VARIUS, Fr. ? (1265).

Meramec Highlands, Oct. 5, 1905. Cke. pl. 698.

Spores, nearly regular elliptic, $8-10 \times 4-5\mu$.

C. BALTEATUS, Fr. ? (1266).

Meramec Highlands, Oct. 5, 1905.

Spores, elliptic, un-symmetric, $9-10 \times 6-7\mu$.

C. CAERULESCENS, Fr. ? (1227).

Creve Coeur, Sept. 21, 1905. Meramec Highlands,
Oct. 6, 1905.

Spores, elliptic, ends acute, $9-10 \times 5-6\mu$.

C. PURPURASCENS, Fr. (1296).

Meramec Highlands, Oct. 6, 1905.

Spores, elliptic, an end acute, $19-12 \times 6\mu$.**C. SANGUINEUS, Fr. ? (1217).**

Creve Coeur, Aug. 20, 1905,

Spores, elliptic, often an end acute, $7.5-9 \times 4.5-6\mu$.

NOTE.— In addition to the foregoing I have probably about 25 species as yet unidentified. The genus was rare until the autumn of 1905.

HYGROPHORUS.**H. GLUTINOSUS, Pk. (P. — 1238).**Meramec Highlands, Sept. 25, 1905. *Mus. Rep.* 55,
p. 950. 1902.Spores, elliptic, $9-11 \times 5-6\mu$.**H. CHLOROPHANUS, Fr. (P. — 1236).**

Meramec Highlands, Sept. 24, 1905.

Spores, oblong, $11.5-14.5 \times 7-9\mu$.**H. LAURAE, Morg. (P. — 1248).**Meramec Highlands, Sept. 30, 1905. *Mus. Rep.*
55, p. 967: pl. 77. 1902. Edible.Spores, $6-7 \times 4\mu$.**H. PRATENSIS, Fr. ? (1275).**

Meramec Highlands, Oct. 5, 1905. Rare.

Spores, white, elliptic, $5-7 \times 3-4\mu$.**LACTARIUS.****L. CORRUGIS, Pk. (P. — 285).**In the woods, various places, 1899 to 1904. Ruddy-
chocolate color. Edible. Rare. *Mus. Rep.* 32, p. 31.Spores, echinulate, $7-9\mu$ broad.**L. SUBDULCIS, Fr. (P. — 96).**Common, June to frost. On mossy slopes, in shade.
Edible. *Mus. Rep.* 23, p. 117.Spores, echinulate, 6, or $7 \times 6\mu$.

- L. GLYCIOSMUS, Fr. (P. — 1203).
Common, in shaded places. Mus. Rep. 23, p. 120.
1869, and 38, p. 123.
Spores, cream, warted, subglobose, 5-7 μ .
- L. THEIOGALUS, (Bull) Fr. (P. — 565).
Open woods, June and July. Rare. Mus. Rep. 38,
p. 117.
Spores, echinulate, light brown, 7-8.5 μ .
- L. FULIGINOSUS, SUMSTINEI, Pk. (P. — 1077).
Woods, July 13, 1903. Rare. Mus. Rep. 38.
Spores, light brown with tint of green, echinulate-spined, 8-10 μ .
- L. INSULSUS, Fr. (P. — 303).
Woods, May 30, 1899.
Allenton, by Mr. Letterman; Meramec Highlands, 1905,
plentiful.
Spores, subglobose, echinulate, 6-8 μ .
- L. PIPERATUS, Fr. (345).
Common and abundant, in moist shady places. June
to October. Edible, — acidity lost in cooking. Mus.
Rep. 23, p. 118.
Spores, smooth, subglobose, 5-6.
- L. VELLEREUS, Fr. (346).
Locality, same as the preceding. Very acrid. Rare.
Spores, smooth, globose, 7-10 μ .
- L. VOLEMUS, Fr. (P. — 1078). "Subglabrous form".
Ramona park, Aug. 1, 1903; Chain of Rocks, June 24,
1904. Pale cream color. Edible.
Spores, globose, 7-9 μ minutely warted.
- L. SUBVELUTINUS, Pk. (P. — 399) n. sp.
In open woods. Rare. Mus. Rep. Bull. 75, p. 18,
1903. Edible.
Spores, 7-9 μ , minutely warted.
- L. DISTANS, Pk. (P. — 1079).
Woods, scattering, rare. Mus. Rep. 23, p. 117; 38,
p. 129; 52, p. 656; pl. 59, 1898.
Spores, 7-9 \times 6 μ minutely warted.

L. LUTEOLUS, Pk. (P. — 1076).

Ramona park, July 13, 1903; Bellefontaine cemetery, July 20, 1903. Low, grassy places. Mus. Rep. 1903, p. 43 : pl. 83.

Spores, $7-8 \times 6\mu$, very minutely warted.

L. FULIGINOSUS, Fr. (P. — 1096).

Forsythe woods, Aug. 18, 1903. Rare. Mus. Rep. 38, p. 128.

Spores, pale yellow, globose, echinulate, $6-7.5\mu$.

L. TRIVIALIS, Fr. (P. — 1249).

Meramec Highlands, Sept. 30, 1905. In woods.

Spores, subglobose, nucleate, minutely warted, $7-10\mu$.

RUSSULA.

R. NIGRICANS, (Bull) Fr. (1143).

Ramona park and Forsythe woods, Aug. 15, 1903. Perhaps the largest of our russulas, being up to 6' broad, stipe 5' long, $1\frac{1}{2}$ ' thick. Mus. Rep. 54, p. 178; 32, p. 31.

Spores, subglobose, smooth, $6-9\mu$.

R. SORDIDA, Pk. (P. — 485.)

Calvary cemetery, June 25, 1900. Ramona park, 1903. Mus. Rep. 26, p. 65; 41, p. 85.

Spores, subglobose, smooth, 9×7 .

R. COMPACTA, Frost, (P. — 350).

Forest park, abundant. July, 1899. Scattering, other places. Edible. Mus. Rep. 32, p. 32; 37, p. 14.

Spores, subglobose, white, rough, $7-8.5\mu$.

R. MUSTELINA, Fr. (P. — 754), "variety."

Bellefontaine cemetery, June 28, 1900. Same place, 1903. Rare.

Spores, minutely echinulate $7.5 \times 6\mu$.

R. LEPIDA, Fr. (P. — 707).

Red form, shading off into the next. Forest and Ramona parks, June to Aug. 1899, 1903. Mus. Rep. 41, p. 75.

Spores, subglobose, $7-9\mu$.

- R. LEPIDA, Fr. (P. — 707).
Pale form. Ramona park, 1903, abundant.
- R. VIRESCENS, Fr. (157).
Open woods, scattering. Mus. Rep. 24, p. 75.
Spores, smooth, subglobose, 5-6 μ .
- R. CRUSTOSA, Pk. (P. — 1145).
Ramona park, Chain of Rocks, 1903-4. Mus. Rep.
39, p. 41; 56 : pl. 84.
Spores, white, smooth, subglobose, 6-7.5 μ .
- R. DECOLORANS, Fr. (P. — 526).
Woods, generally.
Spores, subglobose, minutely echinulate, 7-9 μ and 9 \times 7 μ .
- R. CHAMAELEONTINA, Fr. (P. — 158).
Common, June, through summer.
Spores, yellowish, subglobose, echinulate, 6-7 and 6 \times 7.5 μ .
- R. PUSILLA, Pk. (P. — 817).
Common. On mossy sward under trees, all summer.
Mus. Rep. 50, p. 99.
Spores, white, subglobose, echinulate, 6-9 μ .
- R. LUTEOBASIS, Pk. (P. — 704) n. sp.
Forest park, June 22-1900; Ramona park and
Forsythe woods, 1903, Rare. Bull. Torr. Bot. Cl.
April, 1904.
Spores, smooth, pale cream, subglobose, 6-8 μ .
- R. UNCIALIS, Pk. (P. — 1072).
In woods, scattering. Rare. Small. Mus. Rep. Bull.
No. 2, p. 10. 1887.
Spores, white, subglobose, echinulate, 6-8 μ .
- R. PURPURINA, Quel, (P. — 848).
June and July. Scattering. Mus. Rep. 42, p. 24.
Spores, subglobose, minutely warted, 6-7 μ .
- R. SORORIA, Fr. (P. — 156).
The commonest russula.
Gray. Spores, subglobose, smooth, 6-7 μ .

- R. PECTINATA, (Bull.) Fr. (P. — 1147).
Common. Mus. Rep. 43, p. 21.
Spores, pale cream, subglobose, echinulate, 6-8 μ .
- R. MARIAE, Pk. (P. — 1081).
Jefferson Barracks, June 8, 1903; later, at Ramona park, Forsythe woods. Rare. Mus. Rep. 24, p. 74; 25, p. 109; 57, pl. 85.
Spores, cream, globose, warted, 6-7.5 μ .
- R. INTEGRATA, Fr. (P. — 484).
Common, June to frost. Excellent.
Spores, cream to yellow, subglobose, echinulate, 7-9 \times 7 μ .
- R. NIGRESCENTIPES, Pk. (P.—1148) n. sp.
Forsythe woods. Sept. 13, 1904. Rare. Bull. Torr. Bott. Cl. 33. 1906.
Spores, white, rough, subglobose, 4 \times 6 μ .
- R. DENSIFOLIA, Secr. ? (1080).
Bellefontaine cemetery. July 31, 1903. Very distinct. Rare. No report from Peck.
Spores, white, smooth, subglobose, 5-7 and 8 \times 6 μ .
- R. HETEROPHYLLA, Fr. ? (527).
Forest park, July 9, 1899. Rare.
Spores, white, subglobose, 6-8 μ .
- R. OCHROPHYLLA, Pk. (P. — 1092).
Woods, generally, scattering. Mus. Rep. 50, p. 100.
Spores, subglobose, echinulate, 7-9 μ .
- R. LUTEA, (Huds) Fr. 702.
Bellefontaine cemetery, Aug. 24, 1899. Only 3 specimens.
- R. OLIVASCENS, Fr. ? (1094).
Ramona park, Aug. 15, 1903. Rare. Mus. Rep. 32, p. 32.
Spores, white, globose, 6-9 μ .
- R. FOETENS *var.* SUBFOETENS, Smith, Jour. Bot. 1873, (1146).
Ramona Park, June 30, 1903.
Spores, cream, subglobose, minutely echinulate, 6-8 and 9 \times 7 μ .

- R. SUBVELUTINUS, n. sp. (P. — 1091).
 Forsythe woods, Aug. 16, 1903. One of our finest
 reds. Large. Bull. Torr. Bot. Cl. 33, 1906.
 Spores, cream, smooth, globose, 6-8 μ .
- R. CYANOXANTHA, Schaeff. (1254).
 Meramec Highlands, Sept. 30, 1905, abundant.
 Spores, white, smooth, subglobose, nucleate, 5-7 μ .
- R. ALUTACEA, Fr. (1259).
 Meramec Highlands, Oct. 2, 1905, abundant.
 Spores, yellow, subglobose, echinulate, 8-9 μ .
- R. — sp. (1183).
 St. Louis, Sept. 10, 1902.

CANTHARELLUS.

- C. CIBARIUS, Fr. (P. — 393).
 Open woods. Never abundant. Gregarious. Mus.
 Rep. 37, p. 38.
 Spores, 6-9 \times 3-5 μ .
- C. AURANTIACUS, Fr. (406).
 Ramona park, Aug. 1, 1903. Rare. Mus. Rep. 37,
 p. 35. 1887; and 23, p. 123.
 Spores, subglobose, smooth, 6-7.5 \times 4-5 μ .
- C. CINNABARINUS, Schw. (P. — 89).
 O'Fallon park, June 16, 1899, Ramona park, 1903.
 Not common. Edible. Gregarious. Mus. Rep. 37,
 p. 39; 52: pl. 60. 1898.

MARASMIUS.

- M. ANOMALUS, Pk. (P. — 137).
 Common, on trunks and decaying leaves. Mus. Rep.
 24, p. 76.
 Spores, 4-5 \times 3 μ .
- M. SUBNUDUS, (Ellis) Pk. (P. — 224). *M. peronatus sub-*
nudus, Ellis.
 Common on dead wood. Mus. Rep. 51, p. 287.
 1897.
 Spores, apical, 6-8 \times 4-5 μ .

- M. POLYPHYLLUS**, Pk. (P. — 668).
 Monarch, and Moselle, Mo. May 27, 1899, and July,
 1902. Mus. Rep. 51, p. 286. 1897.
- M. SPONGIOSUS**, B. and C. (P. — 127).
 Forest park, Aug. 14, 1899. Also, at Creve Coeur.
 On the ground. Sacc. V. 137, 573.
 Spores, $4.5 \times 3\mu$.
- M. ELONGATIPES**, Pk. (P. — 856).
 Creve Coeur, July 2, 1902. Rare. Mus. Rep. 27, p. 66.
- M. SCORODONIUS**, Fr. (P. — 326).
 White form. Common and abundant, May to Sept.
 On the ground and sticks, in damp shady places.
 Edible. Mus. Rep. 23, p. 125.
 Spores, $6 \times 4.5\mu$.
- M. SCORODONIUS**, (P. — 916).
 In dry pasture, dry weather, (light brown form).
- M. CAESPITOSUS**, Pk. (P. — 1051).
 Creve Coeur, Sept. 6, 1902. Mus. Rep. 26, p. 65.
- M. SALIGNUS**, Pk. (P. — 408).
 Forest park, July 8, 1899. On base of live elm.
 Mus. Rep. 35, p. 125; 41, p. 85.
- M. WYNNEI**, B & Br. (P. — 942).
 Creve Coeur, Aug. 26, 1902. On mucky bottom
 ground. Only two specimens. Illust. "Fungi Tridenti-
 tini" Bres.
- M. CAMPANULATUS**, Pk. (P. — 119).
 Common on leaves and twigs, shady places. Mus.
 Rep. 23, p. 126.
- M. ROTULA**, (Scop.) Fr. (P. — 120).
 Very common on leaves and dead wood. Mus. Rep.
 23, p. 126.
- M. RESINOSUS NIVEUS**, Pk. in ed. (P. — 1052).
 Creve Coeur, Sept. 6, 1902.

- M. NIGRIPES, Schw. (853).
 Creve Coeur, July and Aug. 1902. On twigs and leaves. Rare. See Myc. Notes, no. 5; illust. p. 46, — Lloyd.
- M. RAMEALIS, (Bull) F. (P. — 949).
 Calvary cemetery, Aug. 29, 1902. On dead herbaceous plants.
- M. — sp. (401).
 Allenton, Mo., by Mr. Letterman.
- M. — sp. (1140).
 Moselle, Mo. On wood.
- M. — sp. (1063).
 Creve Coeur. On wood.
- Note — Several more species undet.

LENTINUS.

- L. LECOMPTEI, Fr. (P. — 42).
 Very common. On stumps.
 This is *Panus rudis*, Fr. of Europe, (Lloyd).
- L. LEPIDEUS, Fr. (298).
 Creve Coeur, May 30, 1899, on R. R. pine lumber; St. James, Mo. on Willow. Specimen 8.5 in. broad. Rare. Mus. Rep. 23, p. 126; 41, p. 91; illust. to show destructive character.
 Spores, $7-8.5 \times 3\mu$.
- L. URSINUS, Fr. (P. — 778).
 Calvary cemetery, Oct. 24, 1900, on elm trunk. Rare. Mus. Rep. p. 964. 1901.
 Spores, subglobose, $3-3.5\mu$.
- L. TIGRINUS, Fr. (839).
 Creve Coeur, May 6, 1902, on stump; E. St. Louis, May 8 and July 12, 1902. On R. R. tracks, roots and ground, quite plentiful. It roots deeply, and is often caespitose.
 Spores, $5 \times 3\mu$.

L. MICROSPERMUS, Pk. (P. —1188) n. sp.

Creve Coeur, May 20, 1904. Three specimens only,
on wood. Bull. Tor. Bot. Cl. 33. 1906.

Spores, globose, white, 3-4 μ .

PANUS.**P. STYPTICUS**, (Bull) Fr. (P. — 43).

On dead wood. Late season.

P. MERULICEPS, Pk. (P. — 102) n. sp.

Forest park, June 1, 1898; Creve Coeur, 1902; Calvary cemetery, Sept. 22, 1904, always on elm. Very rare. Bull. Torr. Bot. Cl. 32, 1905.

Spores, pale pinkish, rough, subglobose, 7 \times 6 μ .

SCHIZOPHYLLUM.**S. COMMUNE**, Fr. (P. — 76). *S. alneum* (L.) Schroet.

Common.

LENZITES.**L. BETULINA**, Fr.* (P. — 41).

Common.

L. VIALIS, Pk. (P. — 140).

O'Fallon park, June 3, 1898; St. Charles, and Creve Coeur. On trunks. Rare. Mus. Rep. 26, p. 67; Bull. Buff. Soc. Nat. Sci. p. 59, 1873.

L. SEPIARIA, Fr. (Undw. — 258).

On bridge timber, (yellow pine), July 10, 1898; 1904. Rare.

POLYPOREI.**BOLETACEAE.****BOLETINUS POROSUS**, Berk (P. — 104).

July to October. 1902, very abundant at Creve Coeur. Low shaded ground. Mus. Rep. 37, p. 32.

Spores, smooth, 9-12 \times 6-7 μ .

* *T. trabea*, Fr. (Lloyd).

BOLETUS.

- B. RUBINELLUS, Pk. (P. — 105).
 June to October. Our most abundant boletus. Dry mossy banks and wooded hillsides. Mus. Rep. 33, p. 33 : pl. 2.
 Spores, $9-11 \times 4-5\mu$.
- B. CASTANEUS, Bull. (P. — 106).
 April to end of summer. On mossy sward. Scarcely common. Edible.
 Spores, $9 \times 5\mu$.
- B. CASTANEUS VINICOLOR, Pk, (P. — 1074) n. var.
 I find a few every year. Habitat same as preceding. Rare.
 Spores, $9.8 \times 6\mu$.
- B. INDECISUS, Pk. (P — 744).
 June to Sept. Rather common. Open woods. Excellent. Large. Peck's "Boleti" p. 153. 1889.
 Spores, $9-11.5 \times 4-5\mu$.
- B. SUBTOMENTOSUS, L. (P. — 108).
 June to October, all places, but scarce.
 Spores, green-olive, $10-12 \times 4-5\mu$.
- B. PIPERATUS, Bull. (P. — 1189).
 Bellefontaine cemetery, July 14, 1904.
 Spores, green-olive, $11-13 \times 4-4.5\mu$.
- B. ALUTARIUS, Fr. (probably) (P. — 1175).
 Ramona park, July 9, 1904. Peck's "Boleti," p. 153.
 Spores, light-chocolate, fusiform, $11.5-14.5 \times 3-4.5\mu$.
- B. ILLUDENS, Pk. (P. — 1107).
 Ramona park, Aug. 1, 1903; Creve Coeur, Aug. 20, 1903. Rare. Mus. Rep. 50, p. 108. 1897.
 Spores, green-olive, fusiform, $7-10 \times 4.5\mu$.
- B. MUTABILIS, Morg. (P. — 1190).
 Bellefontaine cemetery, June 28, 1904. Peck's "Boleti" p. 120; Mus. Rep. 53, p. 845. 1898.
 Spores, $10-11.5 \times 4-5\mu$.

B. NIGRELLUS, Pk. ? (1104).

Forsythe woods, Aug. 18, 1903. Single. Mus. Rep. 29, p. 44.

Spores, narrowly ovoid, $8.5-11.5 \times 4-5\mu$.

B. SEPARANS, Pk. (489).

July and August. Open woods. Boleti, U. S. Pk.

Spores, $10-12 \times 4-5\mu$.

B. EDULIS, Bull. (349).

June to Sept. Rare. Mus. Rep. illust. 1895.

Spores, dingy-olive-brown, $11-14 \times 4.3\mu$.

B. SORDIDUS, Frost, (413).

June to August, a few scattering, in woods.

Spores, pale brown with pinkish tint, $11.3-13 \times 4-5\mu$.

B. ORNATIPES, Pk. (396).

Allenton, July and August, 1899 by Mr. Letterman.

Also Middlebrook, Mo. Aug. 13, 1905. Mus. Rep. 55, p. 975 : pl. 80. 1901.

Spores, light snuff-brown, $11.4 \times 4.3\mu$.

B. CHRYSENTERON, Fr. ? (803).

Forest park, June 20, 1900. Rare.

Spores, fusiform, $10-12.5 \times 4.5-6\mu$.

B. AURIPORUS, Pk. (1105).

Forsythe woods, Sept. 10, 1903. Only a few specimens.

Spores, elliptical, $6-8 \times 5-6\mu$.

B. FERRUGINEUS, Frost. ? (1106).

Chain of Rocks, Sept. 20, 1903; Allenton, 1899, by Letterman.

Spores, very variable, $4-14 \times 2-6\mu$, usually, $7-10 \times 4\mu$.

B. BICOLOR, Pk. (P. — 474).

Ramona park, Sept. 1905. Mus. Rep. 23, p. 78 : pl. 2; 24, p. 78; 54 : pl. 81.

Spores, $9-10.5 \times 3-4\mu$.

- B. SCABER, Fr. (1108).
 Forsythe woods, Aug. 18, 1903. Single. See Peck's
 "Boleti."
 Spores, 12-15 \times 4-6 μ .
- B. RIMOSELLUS, Pk. ? (480).
 Bellefontaine cemetery, Aug. 22, 1899. Rare.
 Spores, 13-15 \times 5 μ .
- B. PALLIDUS, Frost. ? (535).
 St. Louis. Mus. Rep. (Boleti) p. 113; 54: pl. 81.
 Spores, very pale-brown, spindle, 9-12 \times 4-5 μ .
- B. PURPUREUS, Fr. ? (475).
 Bellefontaine cemetery, Oct. 13, 1898; Allenton, Aug.
 15, 1899, by Mr. Letterman. Rare.
 Spores, elliptic, fusiform, very variable, 7.5-11.5 \times 4.5-6 μ .
- B. SULLIVANTH B. & M. ? (395).
 Allenton, Mo. July 24, 1899, by Mr. Letterman.
 Single.
 Spores, narrowly fusiform, 10-17 \times 3-4.5.
- B. RADICANS, Pers. ? (1167).
 Woods, Ashby road, St. Louis Co., Aug. 20, 1903.
 Single.
 Spores, 10-13 \times 5-6 μ .
- B. — sp. (1303).
 Meramec Highlands, October 5, 1905.
- B. GRISEUS, Frost (1237)?
 Meramec Highlands. Oct. 25, 1905.
 Spores, brown-olive, subfusiform, 12 \times 4 $\frac{1}{2}$ μ .
- B. SUBVELUTIPES, Pk. (429).
 Aug. 2, 1899. Allenton, by G. W. Letterman. Mus.
 Rept. 23 p. 130.
 Spores, elliptic, 10-13.5 \times 3.5-4.5 μ .
- B. RUBEUS, Frost, (1325).
 Forest park, Aug. 14, 1899. Peck's "Boleti."
 Spores, elliptic, 9-10.5 \times 4-5 μ .

NOTE. — Several species undet.

STROBILOMYCES.

S. STROBILACEUS, (Scop.) Berk. (103).

June to Sept. Open woods and grassy swards. Frequent but not plentiful. Edible.

POLYSTICTUS.

P. VERSICOLOR, Fr. (P. — 1).

Very common, on stumps and trunks. Sacc. Vol. vi. p. 253.

P. PERGAMENUS, Fr. (P. — 14).

Common.

P. PERGAMENUS, Schw. (P. — 14). “Whitish form.”

Mus. Rep. 33, p. 36. See remarks by Peck; Sacc. Vol. 6, p. 225.

P. PSEUDO-PERGAMENUS, (Thun) Sacc. (P. — 37).

Common. Sacc. Vol. 6, p. 242.

P. HIRSUTUS, Fr. (P. — 16).

Common. Sacc. Vol. 6, p. 257.

P. HIRSUTUS ALBIPORUS, Pk. (P. — 813).

Forest park, Jan. 24, 1900, and May 8, 1902. On bark.

P. PARVULUS SIMILLIMUS, Pk. (P. — 34).

P. parvulus, *klatsch*. Mus. Rep. 32, p. 34.

POLYPORUS.

P. PERENNIS, Fr. (971).

Creve Coeur, May 23, 1903, abundant on ground of burnt trunks. Brown, turns gray when old.

Spores, subglobose, echinulate, 6-7 μ .

P. VARIUS, Fr. (P. — 915).

Monarch and Creve Coeur. July, 1902. On the ground. Rare.

P. HUMILIS, Pk. (P.—903).

Creve Coeur, July 23, 1902, on wood. Rare. Mus. Rep. 26, p. 69; McLvaine, p. 484.

P. PICIPES, Fr. (P.—2).

On trunks. Rather common.

P. ARCULARIUS, (Batsch) Fr. (P.—33).

Common, on hard, dead wood. Early summer. Sacc. Vol. vi. p. 67.

P. RADICATUS, Schw. (P.—6).

On the ground. Scattering. Rare. Sacc. Vol. vi. p. 58.

P. FLAVO-VIRENS, B & R. (Undw.—436).

Allenton, by Letterman, 1 specimen; Aug. 1. 1899; Chautauqua — Piasa, Ill. Aug. 1, 1902, one. Meramec Highlands, abundant, on the ground Sept. 1905.
Spores, subglobose, 3-4.5 μ .

P. ANAX, Berk.* (P.—15).

Seems a Syn. of *P. frondosus*. On the ground, at base of black oaks. Common. Only in late season. Edible, when young.

P. GIGANTEUS, Fr. (P.—18).

June to October. At stumps. May weigh 15-20 lbs. Edible when young.

P. SULPHUREUS, (Bull) Fr. (P.—19).

Rather common, on trunks and stumps. Excellent when young.

P. BERKELEYI, Fr. (P.—864).

Creve Coeur, July 2, 1902, on the ground near stump weight 20 lbs; later, another fine specimen, near base of white oak; same place, 1904; Monarch, one.
Spores, globose, echinulate, 5-6 μ .

* This is *P. frondosus*, Fr. — Lloyd.

P. EPILEUCUS, Fr. var. CANDIDUS, Pk. (P. — 918).

Horse-Shoe lake, Ill., Aug. 5, 1902, on willow trunk;
Walnut park, Aug. 21, 1902, on old stump. Sacc. vi.
p. 109.

P. SPRAGUEII B. & C. (Murrill, — 424).

Forest park, July 26, 1899; Chain of Rocks, Sept.
20, 1903. At base of black oaks. Grev. i, p. 50; Sacc.
vi. p. 117.

Spores, globose and subglobose, 4.5–6 μ .

P. NIDULANS, Fr. (Murrill — 910).

Monarch, July 27, 1902; Ramona park, 1903. Very
rare. Mus. Rep. 30, p. 45.

Spores, elliptic, or globose, 3 \times 2.5 μ .

P. RESINOSUS, (Schrad.) Fr. (Undw. — 665).

On rotting trunks. Occasionally. Sacc. vi, p. 137.

P. OBTUSUS, Berk. (Undw. — 490).

On hard, dead trunks. 1904, specimen on dead,
standing black oak. Rare. Sacc. vi, p. 134.

P. CONNATUS, Fr.* (Undw. — 680). *Fomes populinus*,
(Schum.) Cke.

Oct. 1899–1900. On Linden and Willow. Rare.
Seems same as *P. fumosus*. Fr. (P. — 693).

P. GILVUS, Schw. (P. — 12).

Very common, on dead wood.
Sacc. Vol. vi, p. 121.

P. ADUSTUS, (Willd.) Fr. (P. — 17).

Very common. On trunks.

P. FUMOSUS Fr. (P. — 693).

See above, *P. connatus*. My specimens seem to
belong here.

P. DISTORTUS, Schw. (P. — 8).

On hard Sycamore trunk. Seems like *P. adustus*,
(P. — 17). Sacc. Vol. vi, p. 101.

* *P. connatus* found only on *Acer*, — Lloyd.

- P. RENIFORMIS, ? (Undw. — 446).
 “Specimen too old.” Determined with a doubt, by Prof. Murrill, as *Ganoderma sessile*. O’Fallon park, in decaying cleft of a black oak.
- PYROPOLYPORUS EVERHARTII, Ell & Gall. (Murrill — 257).
 On black oak. Rare.
- P. CAUDICINUS (Scop) Murr. (Murr. — 1187).
 Calvary cemetery, June 1, 1904. Single, on hard, dry trunk. Bull. Torr. Bot. Cl. 31, Jan. 1904.
- P. IGNIARIUS, Fr. ? (1214).
 St. Louis, April 22, 1905. Old, single specimen on living *Quercus imbricaria*.
 Spores, globose, 6μ and elliptic, $6-7.5 \times 4-5\mu$.
- INONOTUS HIRSUTUS, (Scop.) Murr. (Murr. — 1321).
 Bellefontaine cemetery, Oct. 2, 1904. On living black oak. Bull. Torr. Bot. Cl. 31, Nov. 1904.

FOMES.

- F. FRAXINOPHILUS, Pk. (Murrill — 696).
 On ash trees. Mus. Rep. 35, p. 136. See interesting brochure, Bureau of Plant Industry, Bull. 32, by H. von Schrenk.
- F. RIMOSUS, Berk. (von Schr. — 1215).
 On *Robinia pseudacacia*, about 40 miles south of St. Louis, by von Schrenk. See paper by H. von Schrenk, 12th Annual Rept. Mo. Bot. Garden.
- F. LUCIDUS (Leys) Fr. (P. — 10).
 Common. Chiefly on black oaks. Sacc. Vol. vi, p. 158.
- F. OBLIQUUS, (Pers.) Fr. (P. — 1338.)
 Meramec Highlands, Apr. 14, 1906, by Mr. Perry Spaulding.

F. CURTISII, Berk. (P. — 11).

Same as F. lucidus, with stipe added. Sacc. Vol. vi, p. 121.

F. APPLANATUS, (Pers.) Wallr. (P. — 7.)

F. *Leucophaeus*,—(Undw.). Now, *Elfvingia megaloma*, (Leav.) Murrill. Sacc. Vol. vi, p. 176. Very common.

Spores, 8-9 × 5 μ . — (Murrill).

BJERKANDERA.

B. ROBINIOPHILA, Murrill. (Murr. — 1212), n. sp. (Soon to be published).

Single, March 11, 1905. On a living Locust, near Tower Grove park.

Spores, globose and ovoid, 6-8 μ .

TRAMETES.

T. CINNABARINUS (Jacq.) Fr. (P. — 20).

Mostly on *Prunus serotina*. Rather rare. Sacc. Vol. vi, p. 353.

T. SEPIUM, Berk. (P. — 32) “*Pale form.*”

Rare. Sacc. Vol. vi, p. 342.

T. PECKII, Kalchb.* (P. — 840.)

East St. Louis, May 8, 1902; River bottom, St. Charles, Mo. On willow trunks. Rare.

GLOEOPORUS.

G. CONCHOIDES, Mont. (P. — 26).

Calvary cemetery and Forest park, 1902. Rather rare. Sacc. Vol. vi, p. 403.

* Known in Europe as *T. Troglit*, Berk, and in some books as *T. hispida*. (Lloyd).

DAEDALEA.

D. CONFRAGOSA, Pers.* (P. — 3).

Very common, especially on Willows. See Peck's Mus. Rep. 30, p. 71, for interesting dissertation on its relations.

D. AMBIGUA, Berk.† (P. — 4). *Trametes ambigua*, (Benth) Fr.

Common. One specimen, now in Herb. Mo. Bot. Garden, by Mr. Russel, measures 22 in. broad.

D. UNICOLOR, Fr. (P. — 16).

On oak. Rather rare.

FAVOLUS.

F. EUROPAEUS, Fr. (P. — 27), *Favolus alveolaris* Quel. (Undw. — 641).

On hard dry wood. Rare. Sacc. vi, p. 392.

F. CANADENSIS, Klotsch. (P. — 35).

On dry, dead wood. Rare. Sacc. Vol. vi, p. 400.

MERULIUS.

M. TREMELLOSUS, Schrad. (P. — 708).

October and November. Somewhat common.
Spores, cymbiform, $3-4 \times 1\mu$.

M. LACHRYMANS, Fr. (821).

Common. Under plank walks, of pine material.

M. RUBELLUS, Pk. (1327 — P).

Middlebrook, Mo., Aug. 13, 1905, on wood.
Spores, elliptic, $5-6 \times 3\mu$.

* In Europe, called *trametes* (or *Daedalea rubescens*, (also *Bulliardii*). — Lloyd.

† In Europe, called *Lenzites applanata*. — Lloyd.

HYDNEI.

- H. GELATINOSUM, Scop. (445). *Tremelodon gelatinosum*, Pers.
Allenton, on decayed Sycamore by Mr. Letterman.
Rare. See remarks: Myc. Notes, 259, and illust. — Lloyd.
- H. OCHRACEUM, P.* (P. — 38).
Rather common.
- H. ADUSTUM, Schw. (Undw. — 440).
Meramec Highlands, 1899; Creve Coeur, 1902; Allenton, by Letterman. Rare. Sacc. Vol. vi. p. 444.
- H. REPANDUM, L. (Undw. — 471).
Found several times; Also, by Letterman. Rare.
- H. AMPLISSIMUM, B & C. (P. — 438).
Allenton, by Letterman, on Amelanchier, Aug. 1, 1899.
- H. FLABELLIFORME, Berk. (Undw. — 497).
Allenton, Aug. 25, 1899, by Letterman.
- H. ERINACEUS, Bull. (Undw. — 811).
Found one specimen, 1904; earlier, one at Eureka, Mo., by Mr. Pauls; and, Meramec Highlands, 1905, one of very large size.
- H. CAPUT-URSI, Fr. (1045).
Creve Coeur, on white oak trunk, one specimen. Mus. Rep. 51; pl. 56. Rare.
- H. CORALLOIDES, Scop. (894).
Monarch, Mo., July, 15, 1902, on white oak trunk, a great quantity; Meramec Highlands, 1905. Mus. Rep. 22.
- H. PULCHERRIMUM, B. & C. (P. — 36).
Creve Coeur, Sept. 17, 1898; Bellefontaine cemetery, Sept. 19, 1903; Ramona park, Aug. 1, 1903.
Spores, $3 \times 1.5\mu$.

* *Irpex pachydon*, as known in Europe = *I. crassus*, Berk. of Morgan. — Lloyd.

IRPEX.

I. MOLLIS, B. & C. (P.—39).

Rare. Mus. Rep. 35, p. 136.

I. OBLIQUUS, Fr. (P. — 819).

Calvary cemetery, Oct. 30, 1901. On dead wood.

CRATERELLUS.

C. CANTHARELLUS, Schw. (348).

Common and plentiful, in semi-moist places, open woods. Edible, but without flavor.

C. CORNUCOPIOIDES, Pers. (1253).

Meramec Highlands, Sept. 30, 1905. A numerous colony.

Spores, broadly elliptic, $10-12 \times 7-8\mu$, salmon color, not apiculate as stated by Masee.

THELEPHORA.

T. CARYOPHYLLEA (Schaeff.) Pers. (P.—85).

Open woods, on the ground. Have found but 3 specimens. Ramona park, 1904.

T. PALMATA AMERICANA, Pk. (P. — 1204).

Very common. Semi-moist places, open woods. Gregarious. Mus. Rep. 53, p. 857. 1899.

T. WILLEI, Clint. (P. — 914).

Creve Coeur, and Monarch, June and July. On wooded hillsides. Mus. Rep. 26, p. 71.

T. SCHWEINITZII. (P. — 92). *T. pallida*, Schw.

June to August. Common. Sacc. Vol. vi. p. 534.

Note. — Found the same (1905) in Southern Pennsylvania much larger and better developed.

STEREUM.

S. FASCIATUM, Schw. (P. — 45.)

Common, on trunks. Sacc. Vol. vi.

S. SPADICEUM, Fr. (P. — 44).

Rather common.

S. FRUSTULOSUM (Pers). Fr. (1337).

Meramec Highlands, April 14th, 1906, coll. by Mr. Perry Spaulding, on Quercus, sp.

HYMENOCHAETE.

H. TABACINA, (Sow) Lev. (P. — 711).

Collected, by Mr. Russel.

CLAVARIA.

C. PUSILLA, Pk. (P. — 82).

Forest park, June to August. The only locality, now covered with Fair buildings. Bull. Buff. Soc. Nat. Sci. p. 62. 1873; Sacc. Vol. vi. p. 708.

C. FLACCIDA, Fr. (P. — 912).

Monarch, July 15, 1902; Creve Coeur, Sept. 6, 1902, on or near rotten trunk.

C. STRICTA, P. (1044).

Monarch July 15, 1902.

C. BOTRYTES, Pers. (P. — 83).

Piasa Chautauqua, Ill. 1898.

C. CORALLOIDES, L. (692).

Allenton (Dec. 2, 1899) by Mr. Letterman. Single.

C. PYXDATA, Pers. (749).

Calvary Cemetery, June 25, 1900.

C. CRISTATA, Holmsk. ?

Jefferson Barracks, June 2, 1899.

C. AUREA, Schaeff. (P.—1252).

Meramec Highlands, Sept. 30, 1905. On the ground in massive clusters.

Spores, elliptic, $10-12 \times 4-5\mu$.

C. DENSA, Pk. (P.—1257).

Meramec Highlands, Oct. 2, 1905. A colony on rocky hillside. Mus. Rep. 41, p. 79.

Spores, dingy yellow, $12-15 \times 4-5\mu$.

TREMELLINEAE.

EXIDIA ALBA, (Huds.) Bref. (P.—49).

Common. On trunks.

HIRNEOLA, AURICULA-JUDAE, Berk. (P.—48).

Common, especially on elm. Edible. Relished by some.

SUB-FAM. — DACRYOMYCETEAЕ.

GUEPINIA.

G. BIFORMIS, Pk. (P.—877).

Creve Coeur, July 10, 1902. On trunk. Rare. Bull. Torr. Bot. Cl. p. 20. 1900; Sacc. Vol. 16. p. 222.

G. PALMICEPS, Berk (1336 — P).

St. Louis, 1905.

GASTEROMYOCETES.

PHALLOIDEI.

MUTINUS ELEGANS, Fisher (Lloyd.—867).

Woods and parks. Scattered. Myc. Notes, Jan. 1902, p. 13; illust. Fig. 15.

DICTYOPHORA DUPLICATA (Bosc.) Fisher (755).

Occasionally. Bot Gazette, Nov. 1896, p. 387,—E. A. Burt.

GEASTER.

G. SACCATUS, Fr. (P. — 56).

June to August. Common, in damp, shady places.

Spores, globose, minutely echinulate, 3-3.5 μ .

This includes *G. lageniformis*, Vitt. — Lloyd.

G. HYGROMETRICUS P. (Lloyd, — 1059).

Allenton, by Mr. Kellogg, Apr. 28, 1899. Single.

Spores, globose, echinulate, 9-10 μ .

G. TRIPLEX, Jungh. (Lloyd, — 1029).

Allenton, by Letterman. Single. Sent to Mr. Lloyd.

Sacc. vii, p. 74.

G. MORGANI, Pk. (Lloyd, — 1028).

Creve Coeur 1902. Single. Sent to Mr. Lloyd.

G. VELUTINUS, (Lloyd, — 1027).

Monarch, July 15, 1902. On rotten trunk. See

“ Geastrae ”, — Lloyd, p. 33.

Spores, globose, 2-3 μ .

LYCOPERDON.

L. PYRIFORME, Schaeff. (P. — 59).

Common. On trunks.

Spores, globose, smooth, 3 μ .

L. PYRIFORME VAR. TESSULATUM, (Pers.) Lloyd.

Habitat same as preceding.

L. GEMMATUM, Batsch, (P. — 61).

Common. On trunks and low ground. Variable.

Spores, globose, smooth, 3-4 μ .

L. SEPARANS, Pk. (P. — 62). *L. cruciatum*, — Lloyd.

Common, in parks and pastures.

Spores, smooth, globose, 4-4.5 μ .

L. PULCHERRIMUM, Morg. (496). *L. frostii*, (Pk.), Lloyd.

Allenton, by Letterman, Aug. 25, 1899. Single.

B and C. N. Amer. Fungi; Sacc. vii, p. 112.

- L. CEPAEFORME, (Bull.) (Lloyd, — 1026). *L. coloratum*, Pk.
In pasture, 1902. Mus. Rep. 29, p. 46; 32, p. 71;
Sacc. vii. p. 124, 486.
Spores, smooth, subglobose, 4-5 μ .
- L. MOLLE, Morg. (Lloyd, — 1049).
Lloyd says Peck's *L. molle* is different. On grassy
ground, Sept. 1902. Mus. Rep. 32, p. 69.
Spores, smooth, globose, 4 μ .
- L. CRANIFORME, (Schw.) Fr. (65).
Common in pastures and moist woods. Sacc. vii.
p. 106.
Spores, globose, smooth, 3 μ .
- L. ATROPURPUREUM, Vitt. (Lloyd, — 1024).
Creve Coeur, on wooded hillside. Sacc. xvi, p. 241.
Spores, globose, finely warted, 5-6 μ .
- L. RIMULATUM, Pk. (Lloyd, — 1022).
Creve Coeur, Aug. 31, 1902; Bellefontaine cemetery,
(July 21, 1902), on grassy ground.
Spores, globose, echinulate, 5-6 μ .
- L. —, sp. (1021).
“I think an unnamed species, related to *L. velatum*,”—
Lloyd, Creve Coeur, in woods on the ground.
Spores, pedicillate, globose, 4-5 μ .
- L. GLABELLUM, Pk. (Lloyd, — 1023).
Creve Coeur, Aug. 31, 1902. U. S. sp. Lyc.—Pk. p. 20.
Spores, pedicillate, smooth, subglobose, 3-5 μ .
- L. LONGISPORUM, Berk. (Lloyd, — 1025).
Creve Coeur, Aug. 21, 1902. On trunk. “Possibly
not to be distinguished from *L. oblongisporum*, Berk.”
Sacc. xiv. p. 263.
Spores, pedicillate, elliptic, 4-5 \times 3-4 μ .

CALVATIA.

- C. LILACINA, Berk. (Lloyd, — 65). *C. Cyathiforme*, Bosc.
C. fragilis, (Witt) Pk.
Common in old pastures. Mus. Rep. 32, p. 63.
Spores, globose, echinulate, 5-6 μ .

C. RUBROFLAVA, Cragin. (P. — 64).

July and August. Forest park, Bellefontaine cemetery, Creve Coeur, 1902. Low ground.

Spores, globose, smooth, 3-4 μ .

C. CAELATUM, Bull. ? (Lloyd, — 1195).

“Specimens too young.” World’s Fair ground, June 16, 1904. Sacc. Vol. vii, p. 115.

BOVISTELLA.

B. OHIOENSIS, (Lloyd, — 826).

In pastures, 1900-2. Not common.

Spores, pedicillate, elliptic, 4.5 \times 3 μ .

So far as known, all the Puff-balls are edible.

SECOTIUM.

S. WARNEI, (P. — 54). *S. acuminatum*, (Lloyd).

Dallas, Tex. June 18, 1898.

The second exception, to my rule of including only St. Louis species.

ARACHNION.

A. ALBUM, Schw. (P. — 57).

In pastures and parks. See, Myc. Notes: 249, — Lloyd.

SCLERODERMA.

S. TENERUM, Berk. (Lloyd — 917). *S. vulgare*, (P. — 566).

Rare. See Myc. Notes, Lloyd: 156 — Note 12, and Fig. 27; also, Fig. 35, pl. 7.

Spores, globose, echinulate, 11-13 μ .

S. VERRUCOSUM, Pers. (Lloyd, — 827).

In woods, 1902, very plentiful.

Spores, globose, echinulate, 10-13 μ .

S. CEPA, Pers. (Lloyd, — 420).

In woods, 1903. Calvary cemetery, Aug. 2, 1902. See note, p. 13 — “The Gastromycetes,” — Lloyd.

Spores, globose, echinulate, 9-10 μ .

POLYSACCUM.

P. PISOCARPIUM, Fr. (Lloyd, — 893).

Forest park, June 1902; Bellefontaine cemetery,
Sept. 1903; Chain of Rocks, Sept. 20, 1903, plentiful.
Sacc. vii. p. 148.

Spores, globose, warty, 7.5-10 μ .

PHALLOGASTER.

P. SACCATUS, Morg. (Lloyd, — 337).

Meramec Highlands, June 18, 1899, on trunk. Single.

Rare.

Peridiola, 3-4 \times 1 $\frac{1}{2}$ -2 μ .

NIDULARIACEAE.

CYATHUS.

C. VERNICOSUS, DC. (815).

On the ground, Oct. 18, 1902.

C. STRIATUS, Hoffm. (883).

Creve Coeur, July 14, 1902. On mossy trunk. See
Myc. Notes, : pl. 2, Fig. 19, — Lloyd.

C. LESUERII, Tul. (P. — 75).

On old carpet, July 31, 1898. Mus. Rep. p. 954.
1901.

CRUCIBULUM.

C. VULGARE, Tul. (323).

On dead bark and rubbish.

MYXOMYCETES.

TILMADOCHÉ VIRIDIS, (Bull.) Sacc. (P. — 274).

Forest park, June 8, 1899.

Spores, 7-9 μ .

TILMADOCHÉ POLYCEPHALA, (Schw.) Macbr. (P. — 1060).
Physarum polymorphum, Rost.
 Spores, 7-9 μ .

FULIGO OVATA, (Schaeff.) (Macbr. — 277).
 Rather common, on stumps and rotting trunks.
 Spores, globose, smooth, 6-7.5 μ .

LYCOGOLA EPIDENDRUM, Fr. (P. — 52.)
 Forest park. On trunks, May 18, 1898.

STEMONITIS.

S. MORGANI, Pk. (Macbr — 261).
 May to July. Common. On trunks. Bot. Gazette,
 p. 33, March, 1880.
 Spores, smooth, 7.5-9 μ .

S. SMITHII, Macbr. (Macbr. — 262).
 Forest park, June 8, 1899. On trunks.
 Spores, 6 μ .

S. MAXIMA, Schw. (Macbr. — 1153).
 Forest park, June 8, 1899.
 Spores, 7-9 μ .

ARCYRIA.

A. DENUDATA, (L) Sheld. (Macbr. — 69). *A. punicea*, Pers.
 Forest park, June, 1899. See, Myx. p. 195,— Macbr.
 Spores, 5-7.5 μ .

A. ALBIDA, (Pers.) Lister (275). Mycetozoa, p. 186. *A. cinerea*, (Bull.) Pers. Myx. p. 196, (Macbr.).
 Forest park, June 8, 1899, June 20, 1900.
 Spores, smooth, 6-7 μ .

A. DIGITATA, (Schw.) Rost. (P. — 66).
 A variety of *A. albida*, — Lister.

HEMIARCYRIA RUBIFORMIS, (P. — 68). *Hemitrichia vesparium*, (Batsch) (1154) Macbr.: Myx. p. 203.
 Forest park, May and June, 1898-99.
 Spores, 9-10 μ .

HEMITRICHIA, STIPITATA, Mass. (Macbr. — 719).

Forest park, Jan. 24, 1900.

Spores, 9-10 μ .

COMATRICHA, STEMONITIS (Scop). Sheld. (Macbr. — 1157).

Forest park, 6-20-1900.

TRICHIA SCABRA, Rost. (Macbr. — 1156).

Forest park, Jan. 1900.

Spores, rough, 11.5-14.5 μ .

ASCOMYCETES.

MORCHELLA.

M. ESCULENTA, Pers. (312).

Common, along the bottoms and bluffs of the Missouri and Mississippi rivers. From middle April to early part of May. Plentiful in market at this period.

GYROMITRA.

G. BRUNNEA, Undw. (P. — 835).

In St. Louis market, April 25, 1902.

From South Mo. One specimen, by Letterman, Alenton, Mo.; 2 at Chain of Rocks, May 5, 1904. One of these weighed, 1 $\frac{3}{4}$ lbs. being 7 in. tall, 6 in. di. Apr. 14, 1906, some specimens at M. Highlands. Edible. Proc. Ind. Acad. 1893, p. 33.

Sporidia, nucleate, 20-29 \times 12-15 μ .

HELVELLA.

H. CRISPA, Fr. (1012).

Creve Coeur, Sept. 21, 1902. Single. Woods.

Sporidia, 17.5 \times 10-11.5 μ .

H. SULCATA, Afz. (313).

May, 1899. Woods, on Florrissant road.

Sporidia, 20-23 \times 11.5 μ .

H. ELASTICA, Bull. (305).

Cemetery. Jeff. Barracks, May, 30, 1899 and June 2, 1899.

H. MACROPUS, (Pers.) Karst. (P. — 234).

On mossy ground, Oct. 23, 1898. Single.

PEZIZAE.

P. BADIA, Pers. (P. — 836).

Bellefontaine cemetery, May 5, 1902.

A colony on the ground.

Sporidia, $16-20 \times 7-8\mu$ rough.

P. VESICULOSA, Bull. (P. — 1082).

Missouri Bot. Gardens, April 22, 1903; May 6, 1904, same place. On manure and ground. Taste like Morchella. Edible. See pl. 19, Pilze, Deutschlands, Vol. i, p. 38,—Ditmar.

Sporidia, $20-24 \times 10.5-12\mu$.

P. — sp. (1211).

On wood.

Sporidia, $30 \times 6\mu$.

P. — sp. (1066).

Creve Coeur, July 2, 1902, on rotting trunk. No report from Peck.

Sporidia, smooth, $13-16 \times 9-10$. Large.

SARCOSCYPHA.

S. COCCINEA, Jacq. (717).

Forest park, Jan. 14, 1900. Two specimens. On dry sticks.

Sporidia, $24-33 \times 9-12\mu$.

S. FLOCCOSA, (Schw.) Cke. (P. — 336).

Creve Coeur, June 24, 1899. On sticks. Sacc. viii.

p. 156.

Sporidia, $24-30 \times 12-15\mu$, smooth.

LACHNEA.

L. SCUTELLATA, (L.) Son. (P. — 70).

Forest park, June to Aug. On rotten wood; also,
in hot-house, on cow dung, March 18, 1905.

Sporidia, $17-20.5 \times 11-12\mu$.

L. — sp. (828).

Meramec Highlands, Apr. 14, 1900.

Sporidia, $15 \times 4-6\mu$, smooth.

GEOPYXIS.

G. HESPERIDIA, C & P Sacc. (P. — 72).

On dry twigs, May to July.

BULGARIA.

B. RUFa, Schw. (P. — 398).

Forest park, June and July. Also by Letterman.
On small sticks.

Sporidia, elliptic, $17-20 \times 9-11\mu$.

DERMATEAE.

URNULA CRATERIUM (Schw.) Fr. (P. — 322).

Allenton, by Letterman. Sacc. Vol. viii. p. 549.

Sporidia, $23-33 \times 10-13\mu$.

SPHAERIACEI.

XYLARIA.

X. POLYMORPHA, (Pers.) Grev. (P. — 88).

Common on rotting trunks, June to Aug.

Sporidia, $24 \times 7.5-9\mu$.

X. DIGITATA (L) Grev. (86).

Habitat same as preceding. Mus. Rep. 31, p. 59; 50,
p. 133.

Sporidia, $10-12 \times 4-5\mu$.

X. FLABELLIFORMIS, Schw. (P. — 77).

Forest park, July 14, 1899. On wood. Rare.

X. CORNIFORMIS, *Isaria flabelliformis*, (conidial) (Undw. — 701).

Forest park. June 8, 1899. Rare.

USTULINA.

U. VULGARIS, Tul. (Undw. — 293).

“Conidial Stage.” May. Rare.

Sporidia, $4-6 \times 3 \mu$, white, subspindle shape.

HYPOXYLON.

H. CONCENTRICUM Grev. *Daldinia concentrica*, (Bolt.) C. & D. (P. — 50).

On dead wood. Occasionally.

MISCELLANEOUS.

HYPOMYCES LACTIFLUORUM, (Schw.) Tul. (Undw. — 604).

The host is *Lactarius piperata*, which becomes deformed. Mus. Rep. 53, p. 858. 1899.

OZONIUM AURICOMUM, LINK. (Pammel, — 47).

Common on bark. Sec. Myc. Notes, 257, — Lloyd for interesting comments.

SEPIDONIUM CHRYSOSPERMUM (Bull.) Fr. (P. — 112).

On Boleti, especially, *B. rubinellus*, which is often clothed white all over.

DIATRYBE STIGMA (Hoffm.) Fr. (von Schrenk, — 1165).

On dead stick. See N. A. Pyrenomycetes, p. 565, Ellis & E.

RHIZOMORPHS, (1166).

Forest park, Apr. 18, 1900. These are an extraordinary development, of anastomosing hyphae, under the bark of a decaying elm trunk.

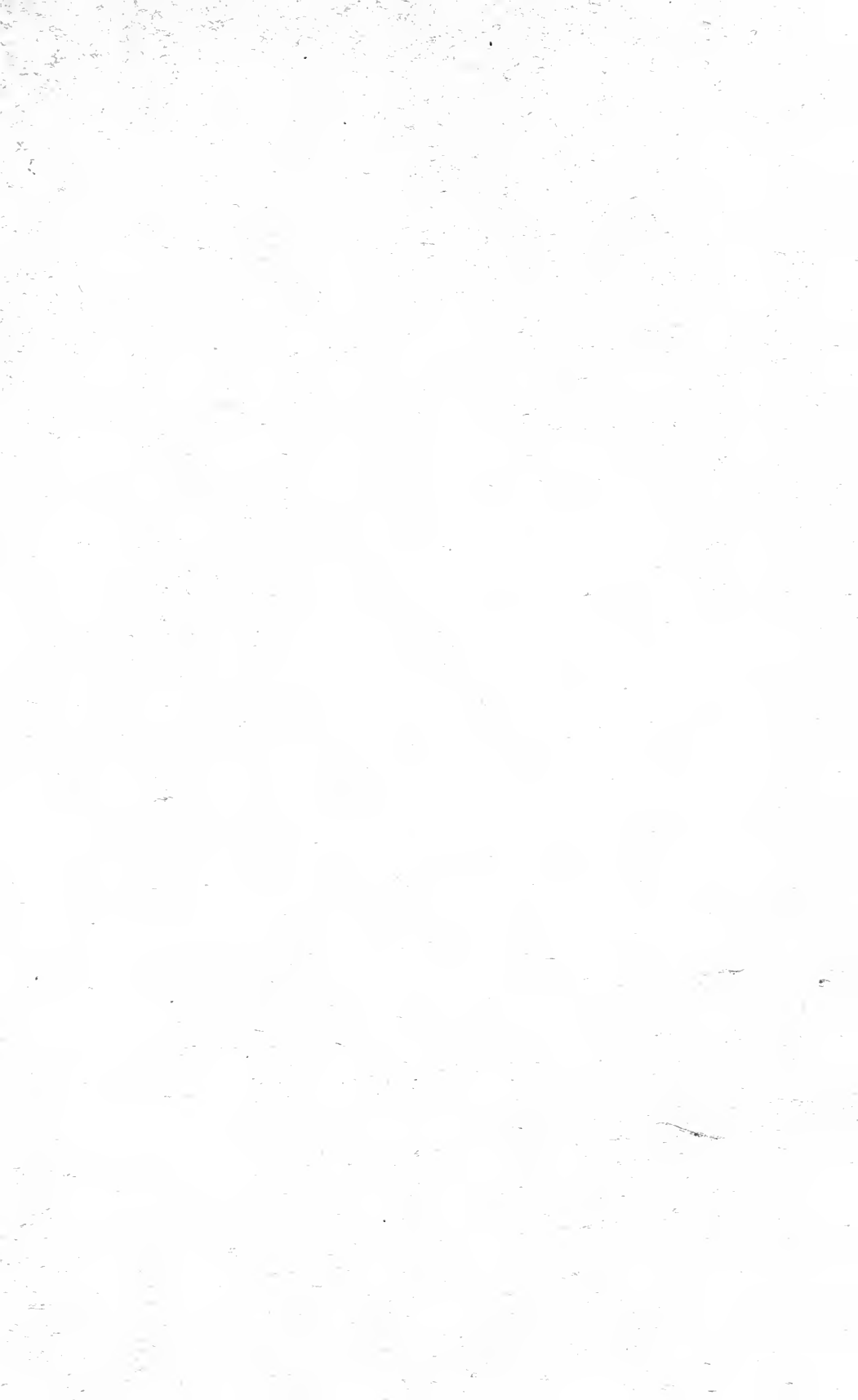

PUBLICATIONS.

The following publications of the Academy are offered for sale at the net prices indicated. Applications should be addressed to The Librarian, The Academy of Science of St. Louis, 3817 Olive St., St. Louis, Mo.

TRANSACTIONS (in octavo).

Vol.	Number.	Price per number.	Price per vol.	Price in set.
1	1* 2† 3, 4 \$4.00 2.00 each.	\$7.50 (Nos. 2-4 only.)	\$7.00 (Nos. 2-4 only.)
2	1 to 3	2.00 each.	5.50	5.00
3	1 to 4	2.00 each.	7.50	7.00
4	1 to 4	2.00 each.	7.50	7.00
5	1-2, 3-4	4.00 each. (double numbers)	7.50	7.00
6†	1, 2, 6, 8, 10, 11, 16, 17 4, 5, 7, 13, 14, 15, 18 8, 9 12	} 25 cts. each. } 50 cts. each. } 75 cts. each. } \$1.00	7.50	7.00
7†	2, 3, 4, 6, 7, 8, 13, 15, 16, 18, 19 5, 9 to 12, 14, 20 17 1	} 25 cts. each. } 50 cts. each. } 75 cts. } \$1.00	7.50	7.00
8†	1, 3 to 6 8, 10, 12 2, 7, 9, 11	} 25 cts. each. } 50 cts. each.	8.75	3.50
9†	1, 3, 4, 7, 9 2, 5, 8 6	25 cts. each. 50 cts. each. \$1.25	3.75	3.50
10†	9 2, 4, 5, 10 1 3, 6, 7, 8, 11	10 cts. 25 cts. each. 40 cts. 50 cts. each.	3.75	3.50
11†	2, 3 5-8, 10, 11 1 4 9	15 cts. each. 25 cts. each. 45 cts. 75 cts. 1.00	3.75	3.50
12†	1, 9, 10 5 3, 8 2, 4, 6, 7	25 cts. each. 35 cts. 45 cts. each. 50 cts. each.	3.75	3.50
13†	2, 3, 5-9 4 1	25 cts. each. 75 cts. 1.50	3.75	3.50
14†	2, 3, 6, 7 4, 8 5 1	25 cts. each. 50 cts. 75 cts. \$1.00	3.75	3.50
15†	1, 3, 4, 5, 6 2	25 cts. each. 50 cts. each. \$1.50	3.50	3.25

MEMOIRS (in quarto).

Contributions to the archaeology of Missouri, by the Archaeological Section. Part I. Pottery. 1880. \$2.00.

The total eclipse of the sun, January 1, 1889. A report of the observations made by the Washington University Eclipse Party, at Norman, California. 1891. \$2.00.

* Supply exhausted.
† Can be sold only to purchasers of the entire volume, — so far as this can be supplied.

‡ Each number is a brochure containing one complete paper (or rarely two)

Transactions of The Academy of Science of St. Louis.

VOL. XVI. No. 5.

**THE NASAL SKELETON OF AMBLYSTOMA
PUNCTATUM (Linn.)**

WITH PLATES II, III, IV, V.

ROBERT J. TERRY.

Issued Dec. 1, 1906.

THE NASAL SKELETON OF AMBLYSTOMA
PUNCTATUM (Linn.)

ROBERT J. TERRY.*

The nasal skeleton of the Urodela presents itself in a number of forms which differ more or less widely from each other as well as from the types met with in the Anura; that is to say, comparisons of the fully formed skeletons have shown apparently no common order of structure.

One object of this work was to study the early stages in the chondrification of the nasal skeleton of an Amphibian and to compare them with the developing nasal skeletons in others in the hope of finding resemblances which in the adults are not marked. For this purpose *Amblystoma* was selected because it is a typical form and because a certain part of the work has already been accomplished. A second object concerned the plan of chondrocranial formation and perfection in the ethmoidal region for which *Amblystoma* seemed suitable in the vigorous development of its cartilaginous head-skeleton. The bony framework of the nose has not been included in the present investigation.

Winslow ('98) used *Amblystoma* as the basis of his work on the chondrocranium describing five stages, viz., in the body-lengths of 10, 11, 12, 39 and 69 mm., and though he does not deal specially with the nasal skeleton, his descriptions of this region are full. I have selected and described stages between the total lengths of 12 and 39 mm., but was unable to obtain animals between 45 and 69 mm., the want of which was much felt.

The excellent series of young larval heads which were at my disposal were kindly loaned by my friends Professor and Mrs. Simon H. Gage, to whom I offer my best thanks. This material from the Cornell Embryological

* Presented to The Academy of Science of St. Louis, Feb. 5, 1906.

Laboratory, consisted in eight heads of *Amblystoma punctatum*, serial sectioned.

The animals were of the following total lengths:

No. 57.....	12mm.
“ 58.....	13mm.
“ 59a.....	17mm.
“ 59.....	19mm.
“ 60a.....	21-24mm.
“ 61.....	24-27mm.
“ 62.....	27-30mm.
“ 63.....	30-33mm.

All of these heads were transected, except the last one in the list which was cut in the frontal plane; all sections were 10μ thick.

Besides this full series of small larval heads the nasal region in *Amblystoma* of 40-45mm. in length was studied by means of serial sections and dissection. These animals were obtained at Woods Hole, and I take this opportunity to express my appreciation of the courtesies shown me while finishing the work at the Marine Biological Laboratory. Dissections of adult heads also were made, and frontal sections of an adult right nasal capsule were prepared and studied. For this material I am indebted to my friend, Mr. Julius Hurter.

The ethmoidal region of Nos. 58, 59a and 60a, and the left nasal sac and skeleton of head No. 62 were modeled in wax after the method of Born with Bardeen's ('01) modifications. These are referred to in the description as stages I, II, III and IV. *Amblystoma* of 40-45mm. is my stage V.

The olfactory organs of *Amblystoma* have been described by Bawden ('94) in his work on the nose and Jacobson's organ. It will be necessary here to make only a brief

statement regarding the anatomy of the olfactory bulb, nerve and nasal sac.

The caudal limit of the olfactory bulb in young larvae of *Amblystoma* is indicated on the surface by a slight groove on the lateral aspect of the cephalic end of the brain (Fig. 2, Olf.). Stieda ('75) describes a limiting furrow for the *Tuberculum olfactorium* in *Axolotl*; Gaupp ('99) has shown one to be present in *Rana*; and Kingsbury ('95) finds the area of olfactory glomerules in *Necturus* outlined by a furrow, better marked on the lateral surface of the brain. Corresponding closely to the position of this groove is the limit of the terminations of the olfactory nerve fibers which make a conspicuous field in the sections; the glomerular arrangement itself, however, is hardly discernible. The direction of the olfactory nerve is laterad in the younger animals in conformity with the position of the nasal sac. This is at first lateral of the brain and projects further ventrad, while the cephalic extremities of the two organs reach about the same level. These relations are considerably changed while the animals are still very small. The nasal sac presents thick walls except laterally where the narrow lumen lies near the surface. The general cavity of the nose in the younger animals is a simple tunnel running between the external and internal nares. Midway between these openings is the mouth of a diverticulum from the main nasal sac, the Jacobson's organ of Bawden's account (J. O. in the figures). The position of Jacobson's organ in young larvae is at the ventral side of the main-sac; in older ones lateral and beneath it. This organ presents a small surface toward the median plane where the duct of Jacobson's gland opens. The latter lies between the ventral wall of the main nasal sac and the floor of the nasal capsule, extending mesad to the olfactory foramen. In older animals a small protrusion from the side of the general cavity near its cephalic end receives the nasolacrimal duct (Fig. 4, N. L. P.).

Winslow's stage III. is a larva of 12mm. in which the trabeculae terminate in the plates known as *Cornua* and present crests which have grown dorsally serving in this and

later stages as cranial side-walls. Each *Crista trabeculae*, highest caudally, gradually descends toward the snout. There is no union between the trabeculae in front; antorbital processes are not present and with the exception of the *Cornua trabecularum* no mention is made by Winslow of a cartilaginous nasal skeleton.

These conditions were found as described, in the larva of 12 mm. which I studied.

STAGE I.

Amblystoma 13mm. Fig. 1.

The simple, somewhat oval, nasal sac lies laterad of the brain, extending beyond its level ventrally. A groove on its lateral surface separates Jacobson's organ from a dorsal prominence. The narial passage is simple; everywhere, except laterally, its walls are thick. A narrow off-shoot from the general cavity close to the internal naris leads into Jacobson's organ.

The trabeculae (*Tr.*) are unconnected anteriorly and lie ventrad of the brain beyond which they project to the level of the cephalic ends of the olfactory organs. The *Crista trabeculae* (*C. tr.*) reaches forward, almost to the level of the nasal sac and olfactory bulb where it ends in an abruptly descending edge. The trabecula is triangular in section from the crest as far as the horn. Opposite the latter it sends a blunt process (*Medial Process of the trabecula; Pr. med.*) mesad toward its fellow, and also dorsad a little way. The trabecular horn (*Co. tr.*) lies beneath and supports the olfactory sac; in this function the neighboring part of the trabecula also shares.

The left "Processus" antorbitalis is present in the form of a slender stick of cartilage between the olfactory organ and eye-ball. It is just behind the internal naris and is continued as a prochondral rod medialwards to the trabecula, joining it at the level of the cephalic end of the *Crista*.

Ossification of the roof of the cranium is already well advanced at this stage but there is no bone in the olfactory region

of the cranial wall. Here a thin membrane extends dorsad from the trabecula to the roof bones and from the cephalic edge of one crista forward and across the middle line in front of the brain to become continuous with the same sheet of the opposite side. In the dorsal part of this membrane there is present a small rod of cartilage (Col. eth.) running in the long axis of the head and therefore parallel with the trabecula, its anterior end just dorsad of the above mentioned medial process, its caudal extremity over the olfactory nerve. The little column of cartilage projects laterally among the loosely disposed cells of the perirhinal tissue, and faces medially the olfactory bulb.

The anlage of this independent cartilage appears in the 12mm. embryo as a group of closely arranged, oval cells (Fig. 5, Anl.) between which and the end of the trabecula, and connecting the two, is a column of large cells of irregular forms. This column reaches the anterior end of the anlage of the rod passing in front of the olfactory nerve (Fig. 5, C.).

STAGE II.

Amblystoma 17mm. Figs. 2, 6 and 7.

The nasal sacs now project about one-fourth of their length in front of the brain so that an Internasal Space can be spoken of; brain and sac reach the same level ventrally. The groove on the side of the main nasal sac is wide and deep and is limited below by the now prominent Jacobson's organ.

The trabeculae (Tr.) are connected by a narrow Anterior Trabecular Plate (Ant. tr. pl.), the ethmoid plate of Winslow's description, beyond which they extend to the level of the ends of the nasal sac, separated by an intertrabecular notch. The Crista trabeculae (C. tr.) is high, reaching half way up the side of the brain and presenting a straight cephalic margin; it is still caudad of the olfactory bulb. The trabecular horn (Co. tr.), broad at its origin at the trabecula, is directed laterad and caudad and is hol-

lowed dorsally to receive the nasal sac; the narrow end of the horn is in contact with the organ of Jacobson. An antorbital process (Pr. ao.) is present on each side and is chondrified throughout and connected by cartilage with the trabecula. The line of union is easily distinguishable by the presence of young cartilage, and is just opposite the cephalic free margin of the trabecular crest. The little rod of cartilage (Col. eth.) present in the 13mm. larva dorsad of the olfactory nerve, has lengthened considerably and reaches nearly to the trabecular crest. It extends along the caudal two-thirds of the nasal sac between it and the brain, inclining cephalo-ventrad to join by a broad base the trabecula in front of the level of the anterior trabecular plate. While the rod follows the dorso-mesal edge of the nasal sac it, on the other hand, crosses the surface of the olfactory bulb. Its ending is noteworthy: it bends ventrally in a small but distinct hook (Pr. unc.) just behind the olfactory bulb and a very short distance in front of the corner of the Crista. Where the rod expands to join the trabecula two processes arise; one of these, the Ethmoidal Process, (Pr. eth.) points dorso-mesad in front of the olfactory bulb and approaches its fellow; the other the Medial Nasal Process, (Pr. n. med.) grows cephalo-ventrad along the internasal surface of the olfactory sac. The latter process is separated from the end of the trabecula and the horn by a notch, the Medial incisure (Inc. med.) which allows the passage of the third main branch of the ophthalmic V (Fig. 4, Oph. V₃). Another little spur of cartilage on the rod in question, the Lateral Process (Pr. lat.), is present near the hinder end and reaches out into the perirhinal membrane of the dorsal side of the nasal sac. No separate centers of chondrification in this membrane were discovered either in this or in subsequent stages.

Reviewing the cartilaginous rod (Col. eth.) at this stage, it is seen to arise from the trabecula just in front of the anterior trabecular plate by a thick base from which two processes spring, then to arch backward across the olfactory bulb and over the olfactory nerve to end free in a ventrally turned

hook a little way in front of the dorsal corner of the trabecular crest.

The anterior trabecular plate (Ant. tr. pl.) underlies the cephalic end of the brain and connects the trabeculae some distance caudad of their extremities; its cephalic margin is a little behind the level of the junction of the trabecula and the base of the rod (Col. eth.). I could not discover that this plate chondrifies independently of the trabeculae.

STAGE III.

Amblystoma 21–24mm. Figs. 3 and 8.

The nasal sac, which has a cephalo-caudal direction in the 13 and 17mm. larvae, now holds an oblique position, the caudal end being farther from the middle line than the cephalic extremity. About one-third of the nasal sac is cephalad of the brain and the internasal space is correspondingly increased. The organ of Jacobson (J. O.) is quite prominent, projecting laterally as well as ventrally. The groove dorsad of it is relatively wider than in the younger animals and its floor now shows a slight convexity, best marked in front.

A narrow cartilaginous cranial floor is formed by the anterior trabecular plate and by a ledge extending from the medial side of the trabecula. The broad horn of the latter (Co. tr.) sends its upturned end around the under surface of Jacobson's organ. The blunt end of the trabecula projects a little way beyond the cephalic margin of the Cornu. The anterior part of the main nasal sac does not rest directly upon the upper concave surface of the Cornu, as does Jacobson's organ, but is separated by a narrow but well defined Subnasal Space (Sub. s.) which is occupied by a loose web of mesenchymal tissue and by some of the branches of Jacobson's gland.

The antorbital process (Pr. ao.) juts out from the trabecula just caudad of the Olfactory Window (Fen. ol.); between it and the Cornu trabeculae there is a wide notch, or bay, in which

lie the caudal part of the main nasal sac with the posterior naris and also the caudal part of the organ of Jacobson.

The olfactory window (Fen. ol.) has resulted from the union of the rod (Col. eth.) with the dorsal corner of the Crista trabeculae; its ventral boundary is the trabecula while the cephalic limit is made by the union of the latter and the rod. The distance between the middle of the rod and the trabecula, (i. e., the height of the olfactory window) has increased relatively, the rod suffering a bend, convex dorso-laterally. This appears to be due to the growth dorsally of the nasal sac to which the rod is now indirectly fixed through the lamina cribrosa to be described presently. Through the window passes the olfactory nerve; in its ventral and cephalic corner is the end of Jacobson's gland. This does not enter the cranial cavity but presses against a membrane which fills the window and which is traversed by the olfactory nerve. The caudal boundary of the window is the anterior free edge of the trabecular crest and also to some extent, the ventrally turned end of the rod (Pr.unc.) which has grown behind the olfactory nerve. Just as the nasal sac itself, so the olfactory window has an oblique position and forms an obtuse angle with the sagittally directed Crista trabeculae.

The rod (Col. eth.) is now considerably flattened and sends an irregular edge over the nasal sac into the perirhinal membrane. The rods of opposite sides are in this stage connected across the middle line by a bridge of cartilage which I shall call the Ethmoidal Bridge (Eth. br.). This is formed, in part at least, by extension and fusion of the ethmoidal processes (Pr. eth.) of Stage II. The bridge passes in front of the brain, partially separating the cranial cavity and internasal space, and lies in a transverse plane cephalad of the anterior margin of the anterior trabecular plate. Between these parts and the bases of the rods (Col. eth.) laterally is the ethmoidal window (Fen. eth.) filled with membrane; part of it is beginning to chondrify.

The medial nasal process (Pr. n. med.) has grown forward and widened in the dorso-ventral direction in the perirhinal

tissue. It makes the medial wall of the nasal capsule in its anterior part; ventrally it is still separated from the extremity of the trabecula by the notch (Inc. med.) described for the 17mm. larva.

The Lamina cribrosa (Winslow), (L.), is a broad plate of cartilage, connected medially with the dorsal arch over the olfactory window, and bent outward to cover the caudal part of the main nasal sac above and at the side. It occupies part of the perirhinal membrane, and while it consists of but one piece it is fenestrated and irregular along its margins. The pointed extremity of the Lamina is just dorsad of Jacobson's organ; a wide gap separates its caudal edge from the antorbital process.

The anterior trabecular plate (Ant. tr. pl.) is no longer in a frontal plane but is inclined cephalo-dorsad so that it now enters into both the floor and cephalic wall of the cranium. The ethmoidal bridge, window and anterior trabecular plate form a curved partition in front of and below the olfactory bulbs.

STAGE IV.

Amblystoma, 27–30mm. Fig. 4.

The nasal sac of this larva is only in its posterior half alongside of the brain. Its contour is less regular than in preceding stages, due mainly to the increase in the size of the organ of Jacobson and to the further separation of this part from the main-sac. The latter presents a great thickening of its dorso-lateral wall appearing on the surface as a rounded eminence sharply marked off from the middle lateral region by a groove. The floor of this sulcus had already, in the 21–24 mm. larva, lifted itself into a convexity and in the present stage a small diverticulum of the main nasal cavity bulges the floor into a little eminence (N. L. P.) which connects with the end of the Nasolacrimal Duct (D. nl).

Jacobson's organ lies ventrad of the lateral region of the main-sac and has pushed its way mesad between the latter and the trabecular horn. Into its medial side opens the

long, branched, tubular Jacobson's gland with wide lumen and rather thick walls. The end of this gland occupies a position close to the ventral cephalic corner of the olfactory window, and in the rest of its extent is situated between the main-sac and the upper surface of the Cornu trabeculae in the space (Sub. s) already mentioned.

The differences that are noticed in the cartilaginous framework over the preceding stage are due chiefly to growth of existing parts; there are no new centers of chondrification.

The cranial floor in the olfactory region is broader, the part made by the anterior trabecular plate giving support to the bulbs. The olfactory window is of the same size as it was in the third stage; the opening is therefore relatively smaller and begins to assume the appearance of the adult olfactory foramen. The part of the capsular wall occupied by the olfactory foramen is obliquely placed and faces forward and outward. Since the nasal sac has increased in length very much, extending in half its length beyond the cranial cavity and ending behind the olfactory foramen, it happens now, for the first time, that a part of the cartilaginous cranial side wall, made by the Crista trabeculae, stands between the brain and the sac.

There is a complete cartilaginous wall separating the cranial cavity and internasal space, stretching from side to side at the level of the anterior margins of the olfactory foramina. Although it is thin in its middle part, this partition, which I have called the Ethmoidal Plate (Eth. pl.) in the same sense that Gaupp* uses the term, is chondrified throughout. Its caudal surface slopes gently into the dorsal surface of the anterior trabecular plate without interruption. The cephalic surface of the ethmoidal plate is thickened along its dorsal and lateral margins corresponding to the positions of the ethmoidal bridge and base of the rod (Col. eth.) in the earlier stages of development. At these places the growth of cartilage in the mesenchymal tissue of the internasal space appears to be most active. In later stages (30-33mm.) as a

* *Morph. Arbeit.* 2, p. 313.

result of the growth of the ethmoidal plate in these regions the nasal capsules are connected by a broad commissure which has the form of an arch covering dorsally and laterally the hinder part of the internasal space. The Fenestra ethmoidalis has been obliterated through chondrification, but the cartilage here is thin as compared with the dorsal and lateral parts of the plate. This manner of growth of the ethmoidal plate explains, then, the adult form of the nasal septum and its relation to the internasal space. Intermaxillary glands were not present in this or preceding stages, the space being filled with mesenchyma.

The medial nasal process (Pr. n. med.) has begun to take part in forming a roof over the anterior part of the nasal sac, its dorsal edge bending laterally and presenting several irregular projections. The ventral margin inclines laterally also toward the ventral surface of the main nasal sac; it is separated from the conical end of the trabecula and horn by the medial incisure (Inc. med.) the width of which is greater than in Stage III. The medial incisure leads from the internasal space into the narrow cave (Sub. s.) between the under surface of the nasal sac and the upper concave side of the Cornu trabeculae. Into the lateral part of this space the medial portion of the organ of Jacobson (J. O.) has grown, and through the space from the latter organ to the olfactory foramen stretches the large branched Jacobson's gland already mentioned. The end of the trabecular horn supports Jacobson's organ, around the side of which it is bent.

The antorbital process at this stage is turned forward toward the internal naris; its free end presents two little tubercles, one pointing forward, the other laterally. The caudal end of the nasal sac overhangs the antorbital process and the curve of the latter appears to be in adaptation to the adjacent posterior naris.

The Lamina cribrosa (L.) covers the caudal half of the main sac. It is connected with the side wall of the cranium opposite the whole length of the olfactory foramen and a little way caudad of this. As it stretches outward it becomes narrower, terminating opposite the groove which separates

the dorsal enlargement of the main nasal sac from the lateral diverticulum in which the nasolacrimal duct ends. The latter is supported by a little process of cartilage which grows forward from the Lamina cribrosa and turns ventrad toward the trabecular horn.

The cartilaginous nasal skeleton of Stage IV. is far from completion; dorsally the nasal organ is only partly covered by the Lamina cribrosa and the edge of the medial nasal process; the future anterior and posterior cupolas are only suggested by these processes of cartilage which are inclining in their growth toward the antorbital process and the trabecular horn respectively.

The conditions present in the ethmoidal region of a 39mm. larva of *Amblystoma jeffersonianum* have been described by Winslow. The nasal capsule of my Stage IV seems to be less advanced.

STAGE V.

Amblystoma of 40-45 mm. Gills partly atrophied.

The nasal sac is in front of the brain except for its caudal one-third; the olfactory foramen looks more forward than outward.

The nasal capsule is provided with a broad, continuous roof extending over nearly the whole dorsal aspect of the main-sac. Its caudal part is the Lamina cribrosa; its cephalic part the medial nasal process which now reaches beyond the external naris and forms the anterior cupola. Between these parts is a broad bay within which are the external naris and the cephalic end of the nasolacrimal duct. This bay becomes the Fenestra narina (Gaupp '05. 2, foot-note, p. 280).

The ventral edge of the medial nasal process turns under the main-sac a little way and is still separated from the trabecular horn by the now widely extended medial incisure. The extreme lateral end of the process is, however, very near the trabecular horn. The latter sends dorso-caudad a cylindrical process the end of which is connected by precartilage with the tip of the little cartilaginous support afforded the nasolac-

rimal duct by the Lamina cribrosa. The nasolacrimal duct crosses this little bridge to end in the nasal sac. Followed in the opposite direction, the duct runs back in a slight groove on the side of the nasal capsule (original Lamina cribrosa). A little elongate (in section) mass of densely packed cells is applied to the medial side of the bridge near the trabecular horn. I suspect that this is the anlage of the dilator naris muscle.

The cartilaginous nasal capsules of the 69mm. *Amblystoma* described by Winslow ('98) present conditions which are, in the main, probably the results of continued growth and readjustment of the parts present in the stage just described. The capsules are mostly anterior to the brain-case and the olfactory foramina look forward and a little outward. There is no longer a medial incisure, only a small foramen (Fig. 12, ni.), the Foramen apicale (Gaupp '05.1), transmitting a branch of the *Nasalis internus*. The Lamina and antorbital process are united in a posterior wall or cupola, a foramen (orbito-nasal) being enclosed. Three windows are shown (fig. 12) in the capsular wall. The largest is situated dorsally and is separated by a strip of cartilage called "dorsal process" from the other two foramina. These openings are placed laterally, separated from each other by a "short connecting rod." The hinder of the two is at about the middle of the capsule in its cephalo-caudal extent. In the explanation of the figures (p. 199) "nl.", which points to this foramen, refers to "nostril;" and in the text (p. 159) the short connecting rod (the anterior boundary of the foramen) is said to be in front of the nasal duct.

In the nasal capsule of the adult studied by means of frontal sections I find these windows. Jacobson's organ appears in the posterior of the lateral openings, the *Fenestra infraconchalis* (Gaupp, '05.1) while the external naris and the termination of the nasolacrimal duct were found in the anterior one, the *Fenestra narina*.

The nerves were reconstructed in my stage IV in order to observe their relations to the nasal skeleton; the refer-

ence letters will be found in figs. 4, 6 and 8. My results in the main agree with Herrick's ('94).

The olfactory nerve, consisting at its origin of two parts as described by Loey, ('99) Coghill ('02) and others, runs through the olfactory foramen and divides into four large branches. One of these passes ventro-laterad among the tubules of Jacobson's gland; a second goes dorso-laterad, a third ventrad, the fourth caudad. They were not followed to their ends.

The Ramus frontalis V (F.) runs forward above the Lamina cribrosa and then upon the laterally turned edge of the medial nasal process. A twig communicates with a branch of the third division of the ophthalmic (C. F.).

The Ramus maxillaris V (Max.) breaks up into twigs laterad of Jacobson's organ and among the external nasal glands in this region. Its relation to the maxillary bone has been mentioned by Herrick.

The first of the three main branches into which the Ramus ophthalmicus trigemini divides at the fore part of the orbit (Oph. V₁.) turns around the caudal end of the nasal sac in the wide interval between the antorbital process and the Lamina cribrosa. In older animals this nerve enters the nasal capsule by the orbito-nasal foramen in the posterior cupola. Further forward it passes under the tip of the Lamina and then runs close to the side of Jacobson's organ.

The second main branch of the ophthalmic (Oph. V₂) enters the space between the nasal sac and the Crista trabeculae and turning ventrad passes over the antorbital process to anastomose with the Ramus palatinus of the VII (P).

The third main branch of the trigeminal in the orbit (Oph. V₃) enters the nasal capsule beneath the caudal margin of the Lamina cribrosa close to the cranial side wall. It passes forward dorsal to the olfactory nerve and comes out of the nasal capsule at the medial incisure (later a foramen). The communicating branch to the Ramus frontalis (C. F.) and the branch accompanying the nasolacrimal duct (R. nl.) run under the Lamina cribrosa and emerge through slight notches in its cephalic edge.

The Ramus palatinus of the VII (P.) appears to consist of two bundles which run together along the lateral edge of the trabecula and then under the trabecular horn. The medial bundle is joined by the second branch of the ophthalmic.

SUMMARY OF OBSERVATIONS.

1. The nasal sac is at first laterad of the brain. In the last stage it is laterad of the brain in its caudal third only; in their cephalic two-thirds the sacs are in front of the brain, separated from each other by the nasal septum and the inter-nasal space. Jacobson's organ, at first ventrad of the main-sac, later lies in a ventro-lateral position. Between the main-sac and the trabecular horn is a narrow space occupied in part by Jacobson's organ and glands.

2. The Crista trabeculae, in the early stages, reaches forward only as far as the olfactory bulb.

3. The trabeculae in the ethmoidal region are at first separate and end in medially directed processes.

4. The Cornu trabeculae extends beneath the cephalic end of the olfactory sac; its extremity is always near Jacobson's organ which it supports in the older stages.

5. The antorbital process chondrifies independently in *Amblystoma*. Its union with the trabecula is at the level of the anterior edge of the trabecular crest.

6. The rod (Col. eth.) chondrifies independently in the membranous cranial wall of the ethmoidal region. Its position is opposite the dorso-cephalic part of the olfactory bulb and dorsad of the olfactory nerve; the rod is in the same sagittal plane as the trabecula and alongside of the dorso-mesal angle of the nasal sac.

7. The rod (Col. eth.) becomes connected secondarily with the trabecula and with the trabecular crest completing the boundaries of the olfactory foramen.

8. Growth of cartilage takes place actively at certain regions along the rod and spreads, a) into the membranous cranial wall of the ethmoidal region and b) into the perirhinal tissue.

9. Thus there appear: a *Processus uncinatus* turning back of the olfactory bulb and entering into the cranial side wall; a *Processus ethmoidalis*, the first piece in the formation of the anterior cranial wall, the later ethmoidal plate; a *Processus nasalis medialis* which builds the anterior cupola and the medial wall of the nasal capsule in its anterior part; a *Processus lateralis* which gives rise, in part to the *Lamina cribrosa*.

10. The anterior trabecular plate was formed in connection with the trabeculae; it supports the olfactory bulbs, participates in the ventral boundary of the ethmoidal window, and is secondarily connected with the bases of the rods (*Col. eth.*) and their ethmoidal processes through the chondrification in the ethmoidal window.

11. A nasal septum begins by growth along the dorsal and lateral regions of the cephalic surface of the ethmoidal plate, extending forward through the mesenchymal tissue of the internasal space.

12. The capsular wall about the olfactory foramen is at first medial, but later caudal and medial of the nasal sac.

13. The nasal capsule in the 40–45 mm. *Amblystoma* possesses a continuous roof.

14. The *Fenestra narina* begins as a bay between the anterior cupola and the *Lamina cribrosa*. It includes the external naris and the end of the nasolacrimal duct.

15. A bridge of cartilage and precartilage connects the trabecular horn and *Lamina cribrosa*. It is crossed superficially by the nasolacrimal duct.

(A) The primary position of the rod (Col. eth.) of the 13 mm. larva (a) in the membranous cranial wall of the ethmoidal region, (b) over the olfactory nerve and (c) in close relation to both the olfactory bulb and nasal sac; (B) its secondary connections and changes through growth in adaptation to the olfactory organs, —these things indicate, I believe, a direct relationship between the rod and the latter structures.

In its further development it has been noticed how the cartilage spreads in two directions: toward the central olfactory organ on the one hand and about the peripheral organ on the other. The ethmoidal processes, bridge and finally the ethmoidal plate are adapted to the fore part of central olfactory region, while the rod itself with its hooked end is applied to the olfactory bulb laterally and caudally. The rod also covers the olfactory nerve in its short course between the nasal sac and the brain. Through the formation of cartilage growing laterally into the perirhinal membrane (lateral process and medial nasal process) a roof and side wall are given to the nasal capsule.

The relations of the Crista trabeculae to the nasal organs I regard as wholly secondary since they are brought about in the ontogeny of *Amblystoma* by disproportion in the rate of growth of these parts. In the youngest stage the crest took no part in the skeleton of the ethmoidal region and it is only in later stages of development when the nasal sac and olfactory bulb have increased in size that it affords a protection for them.

The antorbital process, it was noticed, occupied a position between the eye-ball and the internal naris in the first stage described. The anlage of this process is in connection with the trabecula to which the independently forming cartilage later extends. The process projects from the trabecula at the level of the anterior edge of the Crista and therefore behind the level of the olfactory organs. In the early stage I cannot determine that the process is adapted more to the nose than to the eye. In later stages, however, it curves forward and comes in contact with the nasal sac; and finally, entering into the formation of the posterior cupola, it becomes an

integral part of the nasal capsule. In considering this participation in the nasal skeleton, it must be remembered that the nasal sac has grown backward into the region of the antorbital process. Special relations of the antorbital process to the nasal skeleton of *Amblystoma* are developed rather late.

The trabecular horn is, from the first stage on placed ventrad of the anterior end of the nasal sac and Jacobson's organ. To the latter, the tip of the horn seems specially adapted, conforming closely to the curves of its inferior surface. The relation which this broad plate of cartilage holds to the roof of the mouth must, of course, be thought of in studying its development.

The anterior trabecular plate supports the cephalic end of the brain, mainly the olfactory bulbs. It appears to have its origin in the medial processes of the trabecula and from its earliest appearance through all stages studied holds a position beneath the olfactory bulbs. It acquires connection with the ethmoidal plate secondarily. The latter, it will be remembered, has its beginning in the ethmoidal processes of the rods (Col. eth.) The association of the trabecular plate with the olfactory region of the brain may be taken to indicate a special relationship between them, a view which is supported by its secondary connection with the ethmoidal plate, resulting in the perfection of the ethmoidal skeleton in front of and below the olfactory bulbs. I am inclined to regard the anterior trabecular plate as the floor for the olfactory region of the brain and look upon it as a special part of the ethmoidal skeleton but without denying its adaptation also to the mouth. That it does form a solid roof for the mouth in front and brace the trabeculae is of great importance, especially in some forms such as *Rana* with its long larval period as Gaupp ('93) has said, but I look upon these functions as subordinate to the ethmoidal skeleton function in *Amblystoma*.

The anterior trabecular plate has nothing to do with the origin or subsequent development of the so-called nasal septum of *Amblystoma*; this develops in connection with the

ethmoidal plate as already pointed out. In no stage except the adult were intermaxillary glands present. It is easy to observe how, in *Amblystoma*, the disproportion in the longitudinal growth of the brain and ethmoidal skeleton results in the final relations of these organs. Concerning the formation of an internasal space, Gaupp ('05.1) has suggested the influence of cover bones in this region.

In the four stages modeled the trabeculae have a constant relation to the nasal organs. The trabecular plate, and so far as I am able to determine from my material and from the literature, the Cornua are developed in connection with the trabeculae, as is also the anlage of the rod (Col. eth.). The Crista, as has been shown, gains its relation to the nasal sac secondarily. The relations of the trabecula to the mouth do not concern us in the present work.

The development of the cartilaginous nasal skeleton of *Amblystoma* is comparable in many respects with the processes in *Triton* as described by Born ('76). The changes in the position of the nasal sacs and the formation of an internasal space are very similar in the two. The origin of a cartilaginous mesal nasal wall from the trabecula and the subsequent growth of the nasal capsule from the same are conditions not actually met with in *Amblystoma*. The anlage of the rod (Col. eth.), it is true, is in connection with the trabecula and it is in connection with the rod that a large part of the capsule arises, including a medial nasal wall. The cartilaginous rod does not chondrify from the trabecula out, but spreads toward it. However, this independent chondrification of the rod does not mean that genetically it has nothing to do with the trabecula; the anlage indicates a close relation between the two and so it appears to me that there is after all not much difference in the origin of the capsule in these two animals. In larval *Amblystoma* a proper medial nasal wall is present only for the anterior part of the olfactory sac; it

is formed in the perirhinal tissue in connection with the rod through chondrification of the medial nasal process and it is separated in all the larval stages studied by a notch (*Incisura medialis*) from the trabecula.

Parker ('77) has described under the name of "foremost paraneural cartilage," a term used by Huxley ('74), a shell-like cartilage over the nasal sac of *Siredon*. The cartilage is concave forward, one limb directed laterad over the nasal sac, the other cephalad along the mesal margin of the sac. It is at first independent but later joins with the trabecular plate. This appears much like the rod (*Col. eth.*) and the *Lamina cribrosa*.

Wilders's ('92) figure of the ethmoidal region of *Salamandra* larva shows very much the same conditions which I have described in Stage III. A rod arches over the olfactory nerve and extends cephalad at the side of the internasal space; a process goes laterad in front of the level of the antorbital process; a bridge connects the cartilages of opposite sides at the level of the anterior margins of the olfactory foramina, forming the dorsal boundary of an ethmoidal window. The origin of these cartilages is not given in the description.

Gaupp ('93) in his well known splendid work on the primordial cranium of *Rana*, has, after Born, given the name *Ethmoidalpffeiler*, *Columna ethmoidalis*, to a little pillar of cartilage which grows upon each side from the dorsal surface of the already formed anterior trabecular plate. These two pillars grow caudad and laterad over the olfactory nerves around which they help to form a cartilaginous ring by uniting with the side walls of the cranium (the trabecular crests). Thus the olfactory foramen is formed. An ethmoidal window, filled with mucous tissue, is made through an inclination of the ethmoidal columns toward each other. In Fig. 12, Taf. XIV, there is a little salient angle on each column directed dorso-medially and helping to bound the window.

The roof of the hinder division of the nasal skeleton in *Rana* arises in connection with the anterior part of the cranial side wall as far forward as the level of the ethmoidal plate which has formed at the site of the ethmoidal window as in

Amblystoma. This roof cartilage then arises in connection with what was originally ethmoidal column and Crista trabeculae. Subsequently it spreads over the caudal end of the nasal sac to fuse with the antorbital process, leaving a passage way for the Ramus nasalis trigemini.

The early relations and form, and the later secondary connections and development of the ethmoidal column of Rana are the same as obtained for the rod (Col. eth.) in Amblystoma and even the origins of the two are not essentially different: the one growing in connection with the anterior trabecular plate (itself a development of the trabecula), the other chondrifying in a mass of cells streaming up from the end of the trabecula at the spot where the trabecular plate is growing.

The nasal skeleton in Necturus and in Proteus remains unconnected with the brain-case throughout life and in both consists of a lattice-work of cartilage as described by Wiedersheim ('77 and '02 Fig. 200) and Wilder ('03). In Necturus this incomplete capsule covers the simple nasal sac dorsally and in part medially; also to a considerable extent at the poles.

My own studies have shown that the position of the nasal sac of Necturus is laterad of the brain in young animals and latero-cephalad in older ones, the bony wall of the cranium intervening and the branches of the olfactory nerve running an extra-cranial course to the nasal sac.

Miss Platt ('97) and Winslow ('98) have described the independent origin of the nasal skeleton in Necturus and in the work of the former writer we learn that the internal (anterior trabecular) plate and the dorsal part of the Crista trabeculae chondrify independently. The latter is never high in Necturus as it is in Amblystoma and Rana and its cephalic ending is gradual, not abrupt. In the 45mm. larva described by Winslow a curved bar of cartilage appears on the dorso-mesal surface of the olfactory organ running about parallel with the anterior end of the trabecula, dorsad of which it lies. From this bar a number of shorter processes extend laterally over the nasal sac and there are also some sep-

arate pieces of cartilage in the neighborhood of the processes as shown in Winslow's fig. 16. The same figure shows the dorso-mesal pillar ending caudally at the level of the antorbital process.

An examination of the larvae of *Necturus* from 28mm. to 49mm. in length has proved that the olfactory lobe as described by Kingsbury ('95) and the nasal skeleton reach the same level caudally and that the antorbital process is connected with the trabecula where this bar is changing from the prismatic shape of the *Crista* region to the cylindrical form in the nasal region. The bar of cartilage described by Miss Platt and Winslow I have found in a 28mm. larva lying in the perirhinal membrane of the dorso-mesal side of the nasal sac, opposite the olfactory lobe and dorsad of the olfactory nerve branches. The lattice work of cartilage first described in the adult nasal capsule by Wiedersheim ('77) arises, as Winslow has it, as processes of the bar and as separate chondrifications. All of these I find to be located in the perirhinal membrane.

The foregoing facts respecting the origin and relations of the dorso-mesal bar in *Necturus* recall some of the early conditions of the nasal skeleton in *Amblystoma* and *Rana*. In the former, an ethmoidal column (Col. eth.) developed independently in the membranous wall of the olfactory region of the cranium where a cartilaginous wall was wanting, the *Crista trabeculae* ending caudad of the olfactory bulb. The column lies opposite the olfactory bulb and along the dorso-mesal edge of the nasal sac; in connection with it there grows a cribriform roof for the sac in its enveloping membrane. The column arches over the olfactory nerve and secondarily joins the trabecula and its crest to complete the olfactory foramen. In *Necturus* there is no cartilaginous wall in the olfactory region and the *Crista trabeculae* slopes gradually to end behind the olfactory lobe. A rod of cartilage is developed along the dorso-mesal angle of the nasal sac opposite the olfactory lobe in the perirhinal membrane, parallel to the trabecula and over the olfactory nerve. From the bar a part of the lattice-like roof of the nasal sac extends. The trabecular

crest never grows high and the dorso-mesal bar joins neither it nor the trabecula to form the boundaries of an olfactory foramen; still the nerve passes between the bar and the trabecula and in front of the crest. The formation of the nasal capsule in *Rana* up to the point so far considered seems to me not fundamentally different from that of *Amblystoma*. The specialized nasal sac of *Rana* is provided with a highly specialized and complicated nasal capsule such as is not encountered at any time of life in *Amblystoma*. There are however some features in these capsules which I believe can be drawn into comparison but first it will be necessary to compare the parts about which the capsule in each case is adapted.

As stated in the beginning of this paper the nasal sac of *Amblystoma* is at first a simple ovoid body with a narrow lumen, becoming later complicated by the development of diverticula, one of which is Jacobson's organ. Another much smaller pouch grows out of the lateral side of the main-sac and receives the nasolacrimal duct. The main-sac and its diverticula are shown in figure 4.

The main-sac of the Urodela is in all essential respects comparable with the upper blind-sack of the Anura. The lateral pouch of *Amblystoma* is indicated as the possible homology of the lateral diverticle of the tadpole by Bawden while Seydel compares only that part in each group which receives the tear-duct, regarding the anterior blind end in Anura as a special development. Seydel homologizes the inferior blind-sac of the frog with the Jacobson's organ of the Urodeles, and points out the absence of this organ in fishes and the Dipnoi, as well as in *Proteus* and *Menobranchus* and its primitive state in *Amphiuma* and *Menopoma*.

Besides the roof cartilage of the hinder division of the main-sac which is described on P. 414 of Gaupp's work ('93) and which has already been mentioned in the comparison with *Amblystoma*, a separate chondrification of the perirhinal tissue anterior to this is described which later joins with the first roof cartilage and also grows around the medial side of the upper blind-sac to form its mesal wall. Roof and mesal wall are continuous in the anterior half of the nasal capsule

of my 40-45mm. *Amblystoma*. Winslow's Fig. 12 shows that in an *Amblystoma* of 69mm. the roof of the anterior part of the nasal capsule is very slight but that it is continued into the medial wall without interruption. This roof and medial wall I found to be formed in connection with the Columna ethmoidalis, beginning as the medial nasal process. As in *Rana* it is in relation to the main-sac only. In *Rana* this medial wall turns under the upper blind-sac to form the Crista intermedia, a partition between the cavities for the upper and lower blind-sacs. There is no such partition in the stages of *Amblystoma* which I studied but the ventral edge of the medial wall is free and turns laterally a little way under the main-sac (Fig. 4). The ventral edge of the anterior cupola forms a little shelf beneath the main-sac, while the medial incisure exists.

In *Amblystoma* the caudal part of the medial surface of the main-sac faces an obliquely placed olfactory window; in *Rana* a corresponding part looks toward a transversely placed olfactory foramen; the middle part is opposite the ethmoidal plate (beginning septum); in *Rana* the same is opposite the nasal septum; the anterior part of this surface is covered by a proper medial wall, as it is in the frog. Thus the main-sac of *Amblystoma* agrees with the upper blind-sac of *Rana* in its relations to the medial wall of the nasal capsule. A proper medial wall for the inferior room of the nasal capsule does not exist in *Rana* and the same is true in larval *Amblystoma* for that space which contains the medial portion of Jacobson's organ and glands. This subnasal space (Sub. s.) is limited medially only by the nasal septum; in the larvae it opens into the internasal room through the Incisura medialis while back of the ethmoidal plate it is limited by the membrane of the olfactory window against which the glands are pressed. The Incisura medialis transmits the septal branch of the ophthalmic V and is later converted into the apical foramen.*

* There is an analogy between this foramen and the Fenestra naso-basale of *Rana* in its use as the passage way of a branch of a nasal nerve; but while the adult relations are somewhat similar their development appears to be different.

The ethmoidal bridge of *Amblystoma* is a transitional structure in the building up of the ethmoidal plate as is the case in *Salamandra*; in *Triton* the bridge is permanent. The formation of the nasal septum of *Rana* bears no resemblance to the process in *Amblystoma* where an arch is at first made over the internasal room and later a strong commissure is formed between the nasal capsules.

The Cornu trabeculae of *Amblystoma* supports at its end the organ of Jacobson. (Compare Seydel, '95 p. 478, and fig. 7). In *Rana* the horn takes part in the posterior division of the floor of the inferior room; in the anterior part the floor is formed by new chondrification. A floor for the anterior part of the nasal capsule seems to be the rule for *Amphibia*; what part the trabecular horn plays in its formation is known in but a few cases. In *Necturus* and *Proteus* which do not possess a Jacobson's organ a nasal capsular floor is not present. On the other hand a Jacobson's organ is described by Seydel for *Siren* but according to Wilder's ('91) description of the capsule there appears to be no floor; yet there is to be found in Wilder's figure on the ventral side of the anterior end of the nasal skeleton a peculiar "inferior process" which is described on P. 35 where it is also stated that the R. ophthalmicus profundus is ensheathed by cartilage. The foramen of exit for this nerve is at the medial, ventral corner of the nasal capsule at its cephalic end. The meaning of the trabecular horn cannot be told until more is known of its early development and its later history.

Among the later developments, the slender bridge connecting the trabecular horn and Lamina cribrosa is interesting. The nasal capsule of my stage V, closely resembles that of the 12 cm. *Siredon* described and shown in fig. 7 of Seydel's work ('95). In its connections with roof and floor and in its relations to the Fenestra narina and nasal duct the little bridge is comparable with that marked "d" in Seydel's figure. Through further chondrification a fenestrated sidewall is formed for the nasal capsule as Winslow has shown (fig. 12), and in the partition between the two lateral windows I see the little bridge of my stage V. Bruner ('02) has

found in *Triton alpestris* that the dilator naris muscle takes origin from a similar process, which he calls the anterior end of the Planum terminale. The dorsal part of this bridge in *Amblystoma*, begins as a process of the Lamina cribrosa, supporting the nasolacrimal duct and later coming to limit the Fenestra narina behind.

The dorsal window of Winslow's fifth stage cannot be explained through my material. There is a continuous cartilaginous roof for the nasal capsule in the 40-45 mm. animal; but whether the dorsal foramen is due to reduction, as I am inclined to think, or is circumscribed by the primary formation of the dorsal process, I cannot say. The dorsal process appears to be a common feature in the nasal capsule of Urodeles. Bruner ('02) calls it the Cartilago obliqua, a term used by Gaupp also for an oblique process of the nasal capsule of *Rana*.

Huxley* on theoretical grounds believed that the chondrocranium was formed phylogenetically by continuous growth and conceived that separate cartilages could have no significance in the perfection of the continuous-walled brain case. Separate pieces are regarded by the supporters of this theory as the results of reduction of the chondrocranium through the appearance of bones. It was Goette* who first brought forward the view that the chondrocranium was made by the fusion of primitively separate elements.

Regarding the significance of the independent chondrification of the ethmoidal column in *Amblystoma*, the claim can hardly be maintained that this piece is morphologically a separate element. Its anlage is in a mass of cells continuous with the incompletely differentiated cartilage of the trabecula. Through the mass, chondrification takes place, beginning in a spot away from the trabecula and then spreading toward it. In *Rana*, which possesses a much more complete chondrocranium than *Amblystoma*, in accordance with its long larval life (Born, Gaupp,) the ethmoidal column develops in direct connection with the basal skeleton. I am therefore inclined

* See Gaupp. ('00.)

to regard the independent chondrification of the ethmoidal column of *Amblystoma* as evidence of a phylogenetic reduction process in its nasal skeleton.

In *Amblystoma* the cartilaginous nasal capsule does not arise independently of the brain-case. It is from the beginning a part of the ethmoidal skeleton which is built in connection with the trabeculae, ethmoidal columns and antorbital processes. In the development of the cartilaginous ethmoidal skeleton there are formed *pari passu*, a capsular covering for the epithelium of the nasal sac and protecting walls for the olfactory bulb.

LITERATURE REFERRED TO.

- '01. Bardeen, C. R., Born's method of reconstruction by means of wax plates. Johns Hop. Bull. XII. 1901.
- '94. Bawden, H. H., The nose and Jacobson's organ with especial reference to the Amphibia. Jour. Comp. Neurol. IV. 1894.
- '76. Born, G., Ueber die Nasenhöhlen und Thränennasengang der Amphibien. Morph. Jahrb. II. 1876.
- '02. Bruner, H. L., The smooth facial muscles of *Anura* and *Salamandrina*. Morph. Jahrb. Bd. XXIX. 1902.

- '02. Coghill, G. E., the cranial nerves of *Amblystoma tigrinum*. *Jour. Comp. Neurol.* XII. 1902.
- '93. Gaupp, E., Beiträge zur Morphologie des Schädels. 1: Primordial-Cranium und Kieferbogen von *Rana fusca*. *Morph. Arbeiten.* II. 1893.
- '99. Gaupp, E., Ecker's und Wiedersheim's Anatomie des Frosches. *Zweiten Abthlg.* 1899.
- '00. Gaupp, E., Alte Probleme und neuere Arbeiten über den Wirbeltierschädel. *Ergebnis. der Anat. und Entwickl.* X. 1900.
- '05.1 Gaupp, E., Kopfskelet, *Handbuch der vergleichenden und experimentellen Entwicklungslehre der Wirbeltiere.* O. Hertwig. Jena, 1905.
- '05.2 Gaupp, E., Neue Deutungen auf dem Gebiete der Lehre vom Säugetierschädel. *Anat. Anz.* Bd. XXVII. 1905.
- '94. Herrick, C. J., The cranial nerves of *Amblystoma punctatum*. *Jour. Comp. Neurol.* IV. 1894.
- '74. Huxley, T. H., On the structure of the skull and of the heart of *Menobranchus lateralis*. *Proc. Zool. Soc. Lond.* 1874.
- '95. Kingsbury, B. F., On the brain of *Necturus maculatus*, *Jour. Comp. Neurol.* V. 1895.
- '99. Locy, W. A., New facts regarding the development of the olfactory nerve. *Anat. Anz.* XVI. 1899.
- '77. Parker, W. K., On the structure and development of the skull in the Urodelous Amphibia. *Philos. Trans.* 167. Pt. 2. 1877.
- '97. Platt, J. B., the development of the cartilaginous skull and of the branchial and hypoglossal musculature in *Necturus*. *Morph. Jahrb.* XXV. 1897.
- '95. Seydel, O., Ueber die Nasenhöhle und Jacobson'sche Organ der Amphibien. *Morph. Jahrb.* XXIII. 1895.
- '75. Stieda, L., Ueber den Bau des centralen Nervensystems des Axolotl. *Zeitschr. f. Wissenschaft. Zool.* Bd. XXV. 1875.
- '77. Wiedersheim, R., Das Kopfskelet der Urodelen. *Morph. Jahrb.* III. 1877.

- '02. Wiedersheim, R., *Vergleichenden Anatomie der Wirbelthiere*, 5 Auflage. 1902.
- '91. Wilder, H. H., *A contribution to the anatomy of Siren lacertina*. Zool. Jahrb. IV. 1891.
- '92. Wilder, H. H., *Die Nasengegend von Menopoma alleganiense und Amphiuma tridactylum*. Zool. Jahrb. V. 1892.
- '03. Wilder, H. H., *The skeletal system of Necturus maculatus*. Mem. Bost. Soc. Nat. Hist. V. 1903.
- '98. Winslow, G. M., *The chondrocranium in the Ichthyopsida*. Tufts College Studies, No. 5, 1898.

DESCRIPTION OF FIGURES.

The drawings of the wax-models have been made by Dr. R. W. Mills of the Washington University Medical Department. The tracings of the transections were made with the camera lucida.

Fig. 1. Model of Stage I, showing the anterior part of the brain, left eye-ball and nasal sac, the trabecular horns and ethmoidal columns. About $\frac{1}{10}$.

Fig. 2. Model of Stage II, showing the right half of the anterior end of the brain, the left eye-ball and nasal sac; the changes in the ethmoidal column and other parts of the ethmoidal skeleton appear. About $\frac{1}{10}$.

Fig. 3. Model of Stage III. The ethmoidal skeleton and the left nasal sac are shown. The latter, as in Fig. 2, is sectioned caudad of the external naris. The olfactory and ethmoidal windows are present. About $\frac{7}{10}$.

Fig. 4. Model of Stage IV. Left nasal sac and left half of the ethmoidal skeleton. The nasolacrimal duct and the nerves of this region are shown. About $\frac{1}{10}$.

Fig. 5. Transection passing through the anlage of the ethmoidal column, showing also the column of cells between it and the trabecula. *Amblystoma* 12 mm.

Fig. 6. Transection at the level of the base of the antorbital process and cephalic end of the trabecular crest. Stage II. $\times \frac{1}{10}$.

Fig. 7. Transection at the level of the middle of the ethmoidal column and olfactory bulb. Stage II. $\times \frac{1}{10}$.

Fig. 8. Transection passing through Jacobson's organ and gland at the level of the caudal edge of the trabecular horn. Stage III. $\times \frac{1}{10}$.

ABBREVIATIONS.

- Anl. Anlage of ethmoidal column.
 Ant. tr. pl. Anterior trabecular plate.
 C. Cell column between anlage and trabecula.
 C. F. Communicating branch from Ramus frontalis to the third main division of the Ophthalmic V.
 Col. eth. Columna ethmoidalis.
 Co. tr. Cornu trabeculae.
 C. tr. Crista trabeculae.
 D. nl. Ductus nasolacrimalis.
 E. Eye-ball.
 Eth. br. Ethmoidal bridge.
 Eth. pl. Ethmoidal plate.
 F. Ramus frontalis trigemini.
 Fen. eth. Fenestra ethmoidalis.
 Fen. ol. Fenestra olfactoria.
 F. olf. Foramen olfactorium.
 I. N. Branch of olfactory nerve.
 Inc. med. Incisura medialis.
 J. gl. Jacobson's gland.
 J. O. Jacobson's organ.
 L. Lamina cribrosa.
 Max. Ramus maxillaris trigemini.
 M. D. Main division of nasal sac.
 N. L. P. Nasolacrimal pouch.
 N. S. Nasal sac.
 O. F. Olfactory nerve fibers.
 Olf. Olfactory bulb.
 Oph. Vi, 2, 3. First, second and third main divisions of the Ophthalmic V nerve in the orbit.
 P. Ramus palatinus VII.
 Pr. ao. Processus antorbitalis.
 Pr. eth. Processus ethmoidalis.
 Pr. lat. Processus lateralis (of the ethmoidal column).
 Pr. med. Processus medialis (of the trabecula).
 Pr. n. med. Processus nasalis medialis.
 Pr. unc. Processus uncinatus (of the ethmoidal column).
 R. nl. Branch of the third main division of the Ophthalmic V nerve, following the nasolacrimal duct.
 Sub. s. Subnasal space.
 Tr. Trabecula.

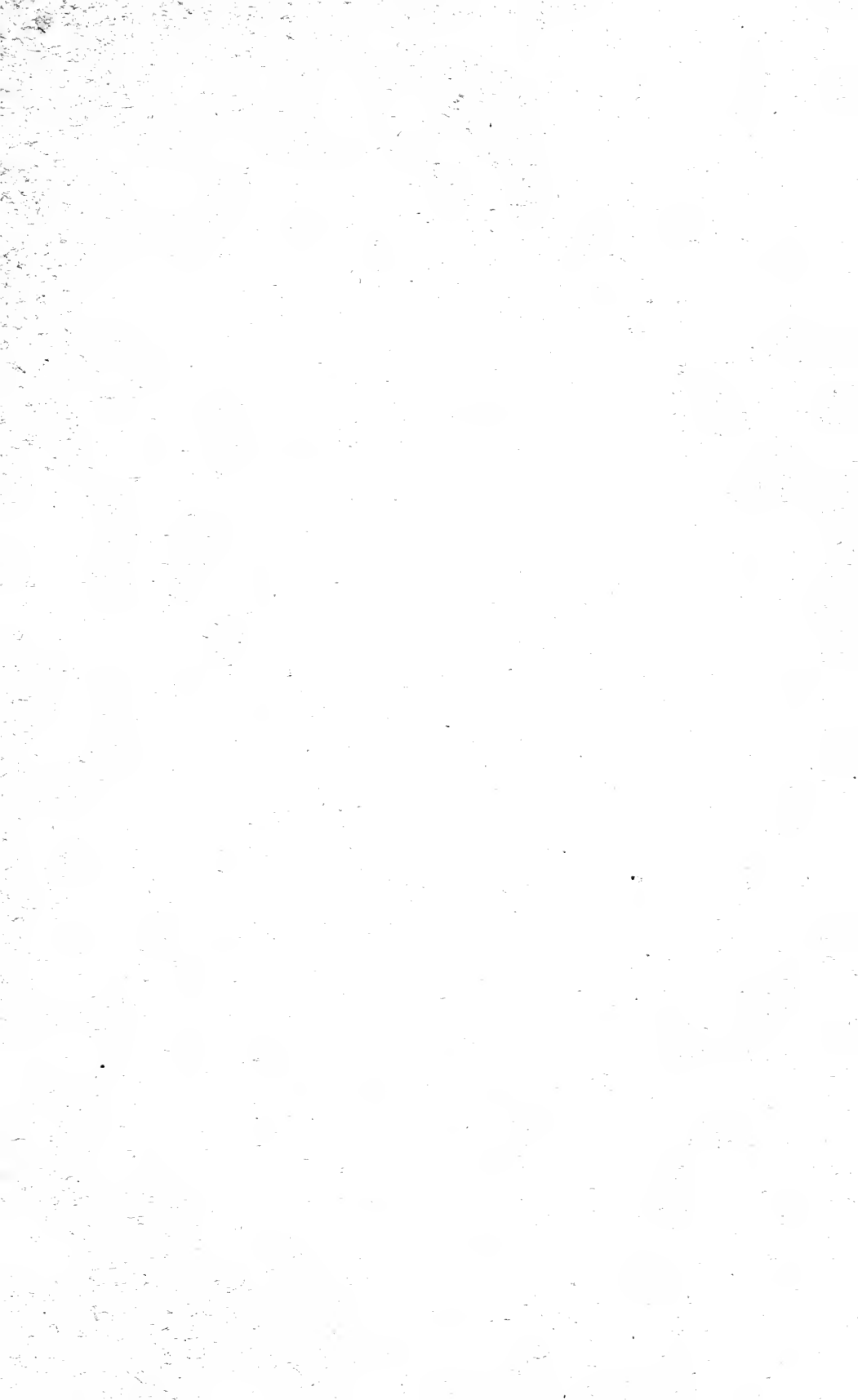

PUBLICATIONS.

The following publications of the Academy are offered for sale at the net prices indicated. Applications should be addressed to The Librarian, The Academy of Science of St. Louis, 3817 Olive St., St. Louis, Mo.

TRANSACTIONS (in octavo).

Vol.	Number.	Price per number.	Price per vol.	Price in set.
1	1*		
	2†	\$4.00	\$7.50	\$7.00
	3, 4	2.00 each.	(Nos. 2-4 only.)	(Nos. 2-4 only.)
2	1 to 3	2.00 each.	5.50	5.00
3	1 to 4	2.00 each.	7.50	7.00
4	1 to 4	2.00 each.	7.50	7.00
5	1-2, 3-4	4.00 each. (double numbers)	7.50	7.00
6‡	1, 2, 3, 8, 10, 11, 16, 17 4, 5, 7, 13, 14, 15, 18 8, 9 12	25 cts. each.	7.50	7.00
		50 cts. each.		
		75 cts. each.		
		\$1.00		
7‡	2, 3, 4, 6, 7, 8, 13, 15, 16, 18, 19 5, 9 to 12, 14, 20 17 1	25 cts. each.	7.50	7.00
		50 cts. each.		
		75 cts.		
		\$1.00		
8‡	1, 8 to 6 8, 10, 12 2, 7, 9, 11	25 cts. each.	3.75	3.50
		50 cts. each.		
9‡	1, 3, 4, 7, 9 2, 5, 8 6	25 cts. each.	3.75	3.50
		50 cts. each.		
		\$1.25		
10‡	9 2, 4, 5, 10 1 3, 6, 7, 8, 11	10 cts.	3.75	3.50
		25 cts. each.		
		40 cts. 50 cts. each.		
11‡	2, 3 5-8, 10, 11 1 4 9	15 cts. each.	3.75	3.50
		25 cts. each.		
		45 cts.		
		75 cts. 1.00		
12‡	1, 9, 10 5 3, 8 2, 4, 6, 7	25 cts. each.	3.75	3.50
		35 cts.		
		45 cts. each. 50 cts. each.		
13‡	2, 3, 5-9 4 1	25 cts. each.	3.75	3.50
		75 cts.		
		1.50		
14‡	2, 3, 6, 7 4, 8 5 1	25 cts. each.	3.75	3.50
		50 cts.		
		75 cts.		
		\$1.00		
15‡	1, 3, 4, 5, 6 2	25 cts. each.	3.50	3.25
		50 cts. each.		
		\$1.50		

MEMOIRS (in quarto).

Contributions to the archaeology of Missouri, by the Archaeological Section. Part I. Pottery. 1860. \$2.00.

The total eclipse of the sun, January 1, 1889. A report of the observations made by the Washington University Eclipse Party, at Norman, California. 1891. \$2.00.

* Supply exhausted.
† Can be sold only to purchasers of the entire volume,—so far as this can be supplied.
‡ Each number is a brochure containing one complete paper (or rarely two).

149

Transactions of The Academy of Science of St. Louis.

VOL. XVI. No. 6.

**OBSERVATIONS ON THE STAPHYLINID GROUPS
ALEOCHARINAE AND XANTHOLININI,
CHIEFLY OF AMERICA.**

THOS. L. CASEY.

Issued, November 22, 1906.

OBSERVATIONS ON THE STAPHYLINID GROUPS
ALEOCHARINAE AND XANTHOLININI,
CHIEFLY OF AMERICA.

BY THOS. L. CASEY.

The following pages are devoted to the revision of several detached groups of Staphylinidae, which have been almost completely neglected heretofore in American literature. In the Aleocharinae, the parts of the series selected for present review are those which are of more general interest and therefore somewhat systematically collected, although this is only true in a relative sense, there being many most interesting genera and species still to be discovered. Besides these groups of the Aleocharinae, a revision of the tribe Xantholinini is presented, based upon such material as could be conveniently brought together. Here, as well as among the Aleocharinae, a number of foreign genera and species are included, more for instructive comparison than anything else, and a list of these will be appended with record of the page of publication, in order to facilitate bibliographic reference. Practically the only published work bearing upon the groups here revised is that of Dr. J. L. LeConte, consisting of some short notes and abbreviated descriptions, which could scarcely be termed synopses, even of the species then known to collectors, being restricted to a few more distinctive or representative forms; in fact, according to the more rational or at least discriminative modern concepts, a very large proportion of them represent distinct genera, and some, originally included within a single genus such as *Falagria*, even prove to be the types of genera not at all closely related. Several of the published species are not represented before me at this time, but these would scarcely alter in any way the general scheme of classification adopted for the several groups; they are, however, referred to with all the detail now accessible.

Throughout the present work and in future publications of the author, the title "America," will refer to the United States of America alone. The continent of which America forms a part, is named North America by common usage; the continent south of Panama is, in a similar way, universally known as South America. Having assumed the name United States of America at our birth as a nation, the single word standing for the country, and the only name from which an adjective can be properly derived, is America, in a manner conforming to that by which Mexico is derived from the full official title of the country—the United States of Mexico—or Colombia from the United States of Colombia. It is thought that by following this geographic terminology consistently no doubt or ambiguity need arise.

As on previous occasions, an asterisk will be prefixed to those subtribes, genera or other groups, which do not occur within the confines of America.

St. Louis, June 5, 1906.

Subfamily ALEOCHARINAE.

Omitting for the present certain aberrant forms of Staphylinidae, for the most part having small anterior coxae, the remainder of this great family may be assigned, apparently with some degree of propriety, to two subfamilies. One of these subfamilies may be formed from what are now known as the tribes Aleocharini and Tachyporini, the second comprising the succeeding tribes such as Staphylinini, Stenini, Paederini and others. It is easy to recall certain bonds of affinity uniting together the discordant elements of each of these vast complexes; for example, the dilatation of the anterior tarsi is unknown or extremely rare in the Aleocharinae and very frequent in the Staphylininae, and, again, the external sexual characters of the male generally evince themselves on the dorsal plates of the abdomen in the former and on the ventral surface alone in the latter. As a rule, also,

the mode of antennal insertion differs in the two subfamilies.

Assuming, therefore, a subfamily Aleocharinae constituted as above, it may be subdivided into a number of tribes depending upon tarsal, antennal and other characters, to which simple group names have been hitherto attached. For example, the Aleocharini comprise those genera of the former heterogeneous tribe Aleocharini having the antennae 11-jointed and the tarsi 5-5-5-jointed, the Myrmedoniini those with similar antennae but having the tarsi 4-5-5 jointed, then the Bolitocharini with the tarsi 4-4-5 jointed and so on through the series. These tribes may then be further subdivided into subtribes based upon various less important structural peculiarities. The Aleocharini would include, for instance, a subtribe Aleocharae, including all those genera of the tribe Aleocharini having a small additional or fifth joint at the tip of the slender fourth joint of the maxillary palpi and the Oxypoda would be a subtribe characterized by a narrower and less heavy body, as a rule, and absence of the palpal appendage; there would also be other subtribal groups defined by special characters.

In the following pages I have selected for systematic study certain of these subtribal groups of genera as they occur in America.

Tribe ALEOCHARINI.

Subtribe Aleocharae.

This subtribe of the restricted tribe Aleocharini is well represented in America by numerous genera which may be defined as follows, the table including also all the known European genera: —

- Hypomera strongly inflexed, not at all visible from a lateral point of view. 2
 Hypomera feebly inflexed, in part at least visible from a lateral point of view in a horizontal plane passing through the axis of the body..... 11
 2 — Mesosternum without trace of carina at any point; elytra not sinuate at tip externally..... 3
 Mesosternum carinate, the carina generally extending to the tip of the process but sometimes abbreviated..... 5
 3 — Abdomen with the first three tergites narrowly and acutely impressed

- at base, the first two strongly, the third feebly, the fourth also apparently slightly impressed or with the basal plate equally strongly elevated. Mesosternum more or less wide between the coxae, attaining the metasternum, which is broadly rounded or subangulate and but slightly produced; head small, distinctly and arcuately narrowed to the base, the eyes large, the front between them angulate; antennae variable; basal angles of the prothorax obliterated; abdomen always coarsely and very sparsely punctate; hind tarsi with the basal joint much elongated. Cosmopolitan..... **Aleochara**
- Abdomen with the basal tergite alone impressed at base; body stout but much smaller in size; antennae short, very stout, compact, slender at base; basal angles of the prothorax more evident though very broadly rounded..... 4
- 4 -- Mesosternal process moderately broad, extending to the tip of the coxae, meeting the very short and broadly rounded metasternum and emarginate at tip; head small, strongly narrowed at base, the eyes large, the front obtusely triangular between them; prothorax much narrowed in front as in *Aleochara*, the abdomen strongly, more evenly and rather less sparsely sculptured; hind tarsi shorter than the tibiae, with the basal joint elongate as in *Aleochara*: male sexual characters evinced in irregular acute pectination of the sixth tergite and discal tuberculation of the fifth. Europe..... ***Ctenochara**
- Mesosternal process slightly abbreviated and extremely narrow toward tip, the latter very narrowly truncate, attaining the acute tip of the somewhat elongate metasternal process; head large, abruptly and only moderately narrowed at base, the eyes relatively less developed, the front between them very broadly subtruncate; prothorax subparallel; abdomen much more finely, closely and evenly sculptured than in *Aleochara*; hind tarsi very elongate, slender, fully as long as the tibiae, with the basal joint much elongated as in *Aleochara*; male sexual characters undetermined. Pacific Coast of America..... **Aidochara**
- 5 -- The carina entire and unusually elevated but formed, at least posteriorly, by a general bilateral compression of the surface, the summit generally more declivous toward the tip of the process, where it becomes setose; maxillary palpi normally slender and elongate, with the fourth joint aciculate; mesosternal process rather narrow toward tip, extending to the end of the coxae, where it meets the extremely short and broadly arcuate metasternum; hind tarsi well developed, with the basal joint much elongated as in *Aleochara*..... 6
- The carina generally entire though frequently abbreviated, always fine, even and formed by an abrupt elevation of the medial line only, never modified or setose toward tip..... 7
- 6 -- Body more or less stout as in *Aleochara*, the head rather small, arcuately narrowing behind the well developed eyes, the front angulate between them; antennae rather well developed; prothorax much narrowed in front, nearly as in *Aleochara* but with the basal angles much more evident; elytra feebly but very obviously sinuate externally at tip; abdomen finely and very closely punctate, the first two tergites alone distinctly, though rather acutely, and only moderately, the remainder not definitely, impressed. Europe and America..... **Xenochara**

Body less stout, the head and prothorax nearly as in *Xenochara* but with the basal angles of the latter more rounded; elytra evenly arcuato-truncate at tip, not at all sinuate externally; abdomen more coarsely and only moderately closely sculptured, with the first tergite alone distinctly impressed. South Africa.....**Nectiochara*

7 — Anterior and middle tibiae finely spinulose or setose, the former elongate and not dilated.....8

Anterior and middle tibiae very coarsely spinulose externally, the former much shorter than usual, dilated and somewhat arcuate.....10

8 — Fourth joint of the maxillary palpi conical, the third elongate and moderately slender as usual. Body stout, parallel; mesosternal process slightly abbreviated, narrow, gradually tapering to the narrow emarginate apex, which attains the acutely angular apex of the pronounced metasternal projection; carina very fine, confined to the anterior half of the mesosternum; head rather large, but little narrowed behind the moderate and somewhat prominent eyes to the broad neck, the front between the eyes very broadly angular; antennae relatively short and very stout; prothorax with unusually distinct basal angles; elytra truncate or very feebly and broadly subsinuate externally at tip; abdomen finely, very closely punctured, the first three tergites broadly, deeply and subequally concave at base, the others not impressed; hind tarsi very long, fully equaling the tibiae in length, gradually tapering from base to apex, the basal joint longer than the next two combined; femora and tibiae densely fulvo-setulose. Western America.....*Oreochara*

Fourth joint of the maxillary palpi aciculate..... 9

9 — Third palpal joint unusually short, broad at apex, obconical, not twice as long as wide, the fourth rapidly enlarged toward base; mesosternal process acutely pointed. Form narrower, more depressed and parallel; mesosternal process very narrow, gradually narrowed nearly to the apex, then more strongly and arcuately so to the actual tip, which nearly extends to the end of the coxae and fully attains the broadly but sharply angulate apex of the metasternum, the carina fine, confined to anterior two-fifths of the mesosternum; head large, the sides rapidly and arcuately converging behind the well developed eyes, the front between the latter very broadly parabolic; antennae well developed; prothorax with the basal angles broadly obtuse but distinct, the disk uniformly punctured; elytra with the apex narrowly and feebly sinuate at the sides; abdomen with the first four tergites broadly and roundly impressed at base, gradually less strongly so, the impressions deep on the basal plates, feeble but distinct on the fourth and all much more finely though more closely punctate than the remainder of the surface; hind tarsi rather shorter than the tibiae, with the first joint only as long as the next two combined and scarcely as long as the fifth, the tibiae more sparsely setulose than in *Oreochara*. Pacific Coast of America.

Calochara

Third palpal joint elongate, moderately slender, the fourth slender and never more than feebly tapering throughout. Form generally similar to that of *Calochara*, less stout than in *Aleochara* and *Oreochara*, rather convex; mesosternal process variable in width but long, always truncate or sinuate at tip, generally nearly attaining the tip of the

- coxae and abutting against or slightly overlapping the broad apex of the metasternal projection; carina generally entire though frequently abbreviated, sometimes as much so as in the two preceding genera; head rather small in size, subparallel or only slightly narrowed behind the well developed eyes, the front between the latter angulate; antennae variable but more or less well developed; prothorax variable in sculpture, the basal angles more or less broadly rounded and indistinct; elytra each broadly arcuate at apex, not sinuate externally; abdomen densely to very sparsely punctured, the first three tergites alone impressed at base, gradually and rapidly less strongly as a rule; hind tarsi variable. Cosmopolitan.....**Baryodma**
- 10— Body only moderately stout, parallel, strongly convex, the mesosternal process somewhat abbreviated, attaining the acute apex of the rather strongly produced metasternum, the carina strong and entire; head rather small, parallel behind the well developed eyes, the front angulate; maxillary palpi normal; antennae unusually small, the second joint much longer than the third; prothorax sparsely, irregularly and strongly punctured, with two deeply impressed median sulci, the base broadly lobed in the middle, the angles obsolete; elytra very coarsely sculptured, each strongly sinuate laterally at tip; abdomen parallel, finely, closely punctate throughout except along the more or less impunctate median line, the first four tergites strongly impressed at base, successively somewhat less strongly so, the depressions more coarsely punctured; hind tibiae sparsely setose, very slender at base, swollen thence to the tip, equal in length to the tarsi or but slightly longer, the first joint of the latter elongate. Pacific Coast of America...**Eucharina**
- 11— Middle coxae widely separated. Body more or less stout, frequently very large in size, with partially opaque integuments; mesosternum wholly without trace of carina, the process extending only slightly beyond the middle of the acetabula, rounded or truncate at tip and abutting against or received within the truncate or sinuate and generally broader apex of the long broad metasternal projection; head moderate, strongly and arcuately narrowed behind the very moderate eyes, the front broadly parabolic; palpi elongate and normal; antennae well developed, generally stout; prothorax broadly arcuate at base, either continuously with the sides, the basal angles being obsolete, or discontinuously, the angles being distinct; elytra each arcuato-truncate at tip, not at all sinuate near the sides; abdomen with the first two tergites deeply and broadly, the third less deeply and less widely impressed at base, the fourth and fifth broadly and feebly concave toward base, all the depressions impunctate though somewhat rugulose along the raised basal margins, the punctures fine, confined to posterior half of all the tergites except the sixth, which is wholly punctured; legs stout, the tibiae setulose, the hind tarsi much shorter than the tibiae, with the basal joint moderately elongate. Sonoran fauna of America and Mexico. [= *Tithanis* Csy.].....**Maseochara**
- Middle coxae narrowly separated to subcontiguous, the mesosternal process generally extending to apical third or fourth of the acetabula, frequently very slender, truncate to very acute at tip; hypomera generally less visible from the sides than in *Maseochara*.....12

- 12 — Abdomen with the first four tergites impressed at base, successively less strongly, the surface more or less sparsely and finely punctate... 13
- Abdomen with the first three tergites impressed at base, the fourth and fifth not at all impressed, the impressions narrow, deep and subequal except in *Pinalochara*..... 15
- Abdomen with the first two tergites alone impressed at base, the impressions rounded, deep and subequal..... 16
- 13 — Posterior tarsi shorter, the basal joint frequently but little longer than the second; body depressed. Form parallel, the integuments in great part opaque and with inconspicuous punctures nearly as in *Maseochara*; mesosternal process truncate to acute, separated from the angulate apex of the distinctly produced metasternum by a short depressed longitudinal discontinuity; head rather large, parallel behind the very moderate and somewhat prominent eyes, the palpi rather short and thick; front broadly subtruncate; antennae well developed; prothorax broadly arcuate at base, subparallel at the sides, the basal angles more or less distinct; elytra well developed, not sinuate at tip externally; abdomen parallel, with the basal impressions impunctate, the punctures elsewhere fine and sparse. Cosmopolitan. [= *Polystoma* || Auct.]..... **Emplenota**
- Posterior tarsi longer, the basal joint greatly elongated, equal to the next three combined or nearly so; body normally convex..... 14
- 14 — Body parallel, rather large in size, the integuments polished almost throughout, the punctures fine and not very conspicuous, very sparse on the abdomen; mesosternal process very narrow, gradually and very finely pointed, separated from the metasternum, which is very broadly rounded and does not enter the intercoxal space, by a very long deep longitudinal discontinuity; head well developed, parallel, somewhat swollen at the sides behind the moderate and slightly prominent eyes, the front obtusely angulate, the palpi normally long and slender; antennae well developed, the second and third joints much elongated; prothorax subparallel, the base arcuate, the angles obtuse and rounded; elytra well developed, each distinctly sinuate at tip externally; abdomen narrowed toward tip behind the middle, the impressions deep, rounded and unusually large, involving the greater part of each tergite, except the fourth, the fifth unimpressed, the impressions more coarsely punctate than the remainder; male sexual characters evincing themselves by a tubercle on the basal one or two and fifth tergites, the under surface of the second and third sometimes broadly excavated at base except near the sides; legs rather short, moderately stout, the tibiae somewhat closely setulose. Europe..... * **Ceranota**
- Body narrow, parallel, convex, the integuments finely punctate, slightly alutaceous, the abdomen polished; mesosternal process extremely narrow, gradually and acutely pointed, just attaining the acutely angulate apex of the pronounced metasternal projection without longitudinal discontinuity but on a higher level — viewed ventrally; head moderate, parallel and arcuate behind the rather small eyes, rapidly narrowed at the extreme base, the palpi slender; front angulate; antennae well developed; prothorax subparallel, unusually feebly arcuate at base, the angles obtuse but distinct; elytra only very obsoletely sinuate externally at tip; abdomen narrowed slightly toward tip, the first three tergites each with a large

- deep rounded basal impression occupying from about a half to a third the entire length of the tergite, the fourth with a very feeble concavity toward base, having a prominent basal margin but without the same character of depression as the first three, the impressions all rather more coarsely punctured than the remainder of the surface; legs rather long and slender. Atlantic districts of America.....**Echochara**
- Body stouter but equally convex, the integuments finely punctate, somewhat alutaceous in lustre, the abdomen polished; mesosternal process narrow but with the apex subtruncate, extending posteriorly much further than usual in this group and attaining fully apical fifth of the acetabula and almost the end of the coxae, the tip extending to the moderately produced and parabolically rounded metasternal projection without longitudinal discontinuity; head rather small, parallel and somewhat arcuately inflated behind the moderate and slightly prominent eyes, abruptly narrowed at the extreme base; front broadly arcuato-truncate: palpi normally slender, the antennae well developed, with the second and third joints much elongated; prothorax subparallel, much more arcuate at base than in *Echochara*, with the basal angles obtuse and more rounded; elytra not sinuate at tip externally; abdomen slightly narrowed from base to the tip of the fifth segment, the impressions all unusually narrow and shallow, that of the fourth tergite very feeble, all more finely but more perforately punctate than the remainder; legs rather short and slender. Europe.....***Polystomota**
- 15 — Form somewhat narrow and depressed, parallel, the sculpture sparse; mesosternal process extending to apical fourth of the coxae, moderately narrow, the tip truncate and fully attaining the apex of the unusually elongate metasternal projection; head well developed, orbicular, the eyes well developed, the neck but little more than two-thirds as wide as the head, the antennae moderate, gradually incrassate, with the elongate second and third joints subequal; prothorax subparallel, with obtuse and slightly rounded though distinct basal angles, the hypomera almost as fully visible from the sides as in *Maseochara* and extending to the apex; elytra moderately developed, not in the least sinuate laterally at tip, the external angles rounded; abdomen with the first three tergites rather broadly, feebly and decreasingly impressed at base; hind tarsi short, nearly as in *Emplenota*, the first four joints subequal or with the first very slightly longer than the second. Sonoran regions.....**Pinalochara**
- Form rather stout, convex, alutaceous in lustre, the punctuation fine and very close throughout, including the abdomen; mesosternal process rather narrow but not strongly acuminate, flat, the apex arcuato-truncate, not attaining the very short and broadly rounded metasternal projection by a short deep longitudinal discontinuity; head rather small, feebly narrowed behind the somewhat prominent eyes, the front broad, feebly, evenly declivous to the apex; palpi somewhat short and thick; antennae moderately well developed, stout and somewhat compact, the second and third joints elongate, the fourth short, transverse and much shorter than the fifth as usual; prothorax unusually transverse and narrowed from base to apex, with the base broadly arcuate and the angles distinct; elytra large, each dis-

- tinctly sinuate externally at tip; abdomen of normal width, narrowed slightly behind the middle, the impressions continuous in punctuation with the rest of the surface; legs short, the hind tarsi much shorter than the tibiae, with the basal joint as long as the next two together or but little longer. Europe and Atlantic America. **Rheochara**
- Form less stout, convex, the integuments strongly shining, feebly and inconspicuously punctulate, the abdomen very sparsely punctulate, with the punctures of the impressions barely as large as the others and still sparser; mesosternal process very slender, much abbreviated as usual but very narrowly rounded or subacute at tip, the surface near the apex deeply concave, the tip failing to attain the very feebly rounded metasternum, which exhibits scarcely any tendency to project between the coxae, by an extremely large and deep longitudinal discontinuity, the mesosternum, with a low broad and flat irregular cariniform elevation in about anterior half; head relatively larger though moderate, abruptly constricted at base, the sides subparallel, the eyes moderately prominent, the front broadly arcuate, the antennae much larger and more developed, with the fourth joint abnormal, slightly elongate and not differing much from the fifth; palpi elongate and slender; prothorax only slightly narrowed from base to apex, broadly arcuate at base, the angles obtuse but distinct; elytra long and well developed, each deeply sinuate externally at apex; abdomen unusually narrow, rather strongly narrowed in apical half; legs slender, the hind tarsi shorter than the tibiae but very slender, filiform, with the basal joint as long as the next three combined and longer than the fifth. Pacific Coast of America..... **Rheobioma**
- 16 — Body as in *Rheobioma*, shining, the integuments less sparsely and rather more distinctly sculptured; mesosternum without trace of carina anteriorly, the process very slender, excavated near the narrowly acuminate tip which just attains a long and very pronounced, narrowly rounded or subangulate projection of the metasternum; head and palpi nearly as in *Rheobioma*, the antennae almost as well developed but with the fourth joint much smaller than the fifth, though nearly as long as wide; prothorax subparallel, with the base strongly and evenly arcuate, the angles rounded but not obliterated; elytra long and well developed, each broadly and moderately sinuate externally at tip; abdomen normally broad at base but rapidly narrowed behind the second segment, the basal impressions scarcely visibly more coarsely but less closely punctured than the remainder of the first two tergites; legs rather long and slender, the hind tarsi as in the preceding genus. Pacific Coast of America..... **Rheocharella**

The genera above described are rather numerous and it may seem more appropriate to consider some of them as subgenera. In regard to this, however, it should be stated that it seems very difficult to make any such combinations without including all of them as subgenera of *Aleochara*. After careful study it appears to me absurdly inconsistent to main-

tain *Maseochara* and *Emplenota* (*Polystoma*) distinct from *Aleochara*, as admitted in current literature, and not admit *Rheochara*, *Ceranota* and the others as likewise valid. In my own opinion they are all equally valid genera or else are all subgenera. The final conclusion will be revealed by future concurrence of opinion and the function of the writer is fulfilled in simply pointing out the numerous divergencies of structure. The attempt to determine the actual value of these anatomical discordances should, however, only be made by those willing to give the subject close and thorough study with adequate optical appliances. The talented systematists Thomson and Rey have been the only ones thus far to really examine these generic groups and I agree fully with their conclusions. Many of Rey's species, also, have been carelessly and unjustly suppressed, in addition to considerable unwarranted discrediting of his genera.

The foreign genera above indicated may be alluded to in brief as follows: —

CTENOCHARA n. gen. — This genus is founded upon a very small species of the European fauna, sent to me some years ago under the name *Aleochara clavicornis* Redt. It may or may not be correctly determined, but whatsoever its true name may prove to be, it can readily be recognized by the characters given the table. Whether other species should enter the genus at present is unknown to the writer.

NOTIOCHARA n. gen. — Two species from the vicinity of Cape Town in South Africa seemed at first to be aberrant members of *Xenochara*, but closer observation revealed certain peculiarities of structure which necessitate generic separation, these relating principally to the very important abdominal characters as stated in the above table, together with the entire absence of sinuation at the tips of the elytra near the sides. The types may be described as follows: —

Form moderately stout, convex, polished, deep black throughout, the elytra not at all paler; antennae black, the basal parts and legs dark piceous, the tarsi paler; pubescence very short, not dense, dark fuscous in color and inconspicuous; head not quite half as wide as the prothorax, strongly deflexed and deeply inserted, the eyes and palpi well developed,

the latter slender and normal; antennae stout, somewhat longer than the head and prothorax, gradually and strongly incrassate distally, the outer joints less than twice as wide as long, the second and third moderately elongate, equal, the fourth obtuse, as long as the fifth but much narrower; prothorax three-fifths wider than long, strongly narrowed from base to apex, with the sides strongly and evenly arcuate, the base evenly arcuate; punctures like those of the head, very minute and rather sparse, evenly distributed; elytra short, but little wider than the prothorax, the sides much shorter than those of the latter, the suture barely three-fifths as long as the median line; punctures small but strong, close-set and very strongly asperate; abdomen at base almost as wide as the elytra, gradually but only very feebly narrowed thence to tip, finely but strongly, asperately and rather closely punctured, sparsely so toward tip; hind tarsi very nearly as long as the tibiae, with the basal joint longer than the next two combined and much longer than the fifth; mesosternal ridge feebly elevated, the finely cariniform summit even throughout, setose toward tip. Length 3.6 mm.; width 1.2 mm. South Africa (Wellington).....*subaspera* n. sp.

Form less stout, parallel, equally convex, deep black throughout; antennae black, faintly piceous at base, the legs paler, rufo-piceous; pubescence very short, dark and inconspicuous; head and antennae nearly as in *subaspera*, the latter somewhat shorter and more incrassate, not as long as the head and prothorax, the penultimate joint very nearly twice as wide as long; prothorax minutely, sparsely and evenly punctulate, transverse, nearly as in the preceding but rather less narrowed from base to apex, with more arcuate sides; elytra not at all wider though shorter than the prothorax, the suture nearly two-thirds as long as the median line, the punctures fine, less close-set but almost as strongly asperate; abdomen as wide as the elytra, arcuately narrowing in apical half, finely, asperately and less closely punctate; hind tarsi as long as the tibiae; mesosternal ridge low, the summit finely and strongly cariniform anteriorly but broadening into a transversely rounded polished surface posteriorly with setae toward tip as usual. Length 2.9 mm.; width 0.9 mm. South Africa (Cape Town).....*stibiosa* n. sp.

CERANOTA Steph. — The characters of the description given above are drawn from a specimen kindly given me by Mr. A. Fauvel, under the name *erythroptera* Grav. It is a highly specialized genus, remarkable not only in the broad turgitical impressions, but in the very large shallow excavation occasionally observable at the bases of the second and third ventrals, which may be sexual, and the male tubercles of the first one or two and the fifth dorsal plates. In the long and well developed, externally sinuate elytra and other characters, such as the feebly inflexed hypomera and conformation of the intermesocoxal parts, it is an evident ally of *Rheochara*, and

yet these two genera are placed at the opposite ends of the series in the catalogue of Heyden, Reitter and Weise. The species are rather numerous but appear to be very rare in individuals. Mr. Reitter has recently sent me a male of *ruficornis* Grav.

POLYSTOMOTA n. gen. — This genus is founded upon the European *Polystoma grisea*, of Kraatz, and there may be one or two other species of the palaearctic fauna which will prove to be congeneric. On comparing this species with *Emplenota* (*Polystoma*) *algarum*, of Fauvel, it can be readily seen that the upper surface has none of the exceptionally depressed character that distinguishes the genus *Emplenota*, and closer observation shows that the intermesocoxal parts and hind tarsi are very different in organization. In fact *Polystomota* forms a bond between the isolated *Emplenota* and the equally distinct *Rheochara*, but with characters differing so greatly from either as to necessitate a separate genus.

Aleochara Grav.

The chief special characters of this genus are the simple non-carinate mesosternum, always more or less widely separating the coxae and extending to the posterior limits of the latter, the metasternal process being short and broad or occasionally subobsolete, the strongly inflexed hypomera and the feebly modified third ventral plate, the first two being distinctly and acutely impressed. In addition, the punctuation of the pronotum is invariably rather fine and even, that of the elytra but little coarser and somewhat closer, while the punctures of the abdomen are more or less obviously coarse and notably sparse throughout the genus. The elytra are feebly sinuato-truncate at apex, without trace of external sinus. The species are somewhat heterogeneous in antennal structure, some having these organs short, thick and fusiform, while in others they are much longer, less thick and gradually enlarged to the tip, also in the nature of the male sexual characters, the apex of the sixth dorsal plate being either simple and subtruncate in that sex or pectinate as in

Maseochara, though much more finely and less strongly. I have never observed any pectination of this plate in genera having the mesosternum carinate, though it may occur. The mesosternum and its intercoxal process are margined at each side along the acetabula by a smooth polished and rather deep gutter, which is better developed than in any other genus; these channels will be alluded to below as *coxal grooves*. Our species are moderately numerous but do not seem to occur in the true Pacific coast fauna to any notable extent, the nearest approach known to me being the single example of *tahoensis* which I took some years ago. The sixteen species in my cabinet may be readily known by the following characters: —

- Sixth dorsal plate broader at apex in the male than in the female and pectinate with short triangular teeth, simple in the female; antennae more or less stout, short or moderate in length, the outer joints strongly transverse, the last obtusely pyriform..... 2
- Sixth dorsal simple and subtruncate at apex in both sexes, broader in the male, the antennae variable..... 8
- 2 — Head obviously more than half as wide as the prothorax. Body moderately stout, subparallel, shining, the head and pronotum blackish-piceous, the elytra pale, blackish at the sides except near the base, the abdomen deep black, the apex scarcely picescent; head and pronotum finely, evenly, rather sparsely punctate, the eyes large, not prominent; antennae not quite as long as the head and prothorax, the joints four to six gradually increasing, six to eleven equal in width, stout, the subapical obtrapezoidal, scarcely twice as wide as long; prothorax three-fourths wider than long, narrowed anteriorly, the sides and base broadly rounded; elytra twice as wide as long, distinctly shorter than the prothorax, finely, rather closely but feebly punctate; abdomen as wide at base as the elytra, thence, gradually, moderately narrowed to the tip of the fifth segment and coarsely, only moderately sparsely punctate, the sides straight; mesosternal process wide, flat, not quite extending to the tip of the coxae, truncate at tip, the sides extending further than the median punctate part, which, at the apical width of the process before the tip, is nearly four times as wide as the coxal grooves; metasternal process broadly angulate, between points of tangency with the acetabula about six times as wide as long; basal joint of the hind tarsi not quite as long as the next three combined. *Male* with the sixth tergite subrectilinearly truncate and having about eleven small equal triangular teeth, each wider at base than long. Length 4.3 mm.; width 1.4 mm. Texas.....*texana* n. sp.
- Head not more than half as wide as the prothorax and generally less..... 3
- 3 — Sixth tergite of the male broadly sinuate at tip. Body stout, shining,

- dark rufous, the head more piceous, the elytra feebly clouded at the sides and near the scutellum, the abdomen blackish, the sixth segment and tip of the fifth rufous; antennae dusky, pale at base; head rather sparsely, the pronotum finely and not very closely punctured, the eyes large, the antennae short, not as long as the head and prothorax, very stout, fusoid, the tip narrower than the sixth joint which is twice as wide as long; prothorax nearly as in *texana*; elytra rather less than twice as wide as long, though obviously shorter than the prothorax, finely, rather distinctly, closely punctured; abdomen as in *texana* but with the punctures very sparse; mesosternum similarly broad between the coxae, the metasternal process still shorter and more rounded; first joint of the hind tarsi distinctly shorter than the next three combined. *Male* with the apex of the sixth tergite having about ten small equidistant teeth, the median four smaller and more acute than the three at each side. Length 4.8 mm.; width 1.5 mm. North-eastern States of America.....**fusicornis** n. sp.
- Sixth tergite of the male truncate at tip..... 4
- 4 — Teeth of the sixth male tergite even and equal in size or nearly so toward the middle.....5
- Teeth of the sixth tergite uneven, the medial tooth broadened, forming a small lobe.....7
- 5 — Median punctate part of the mesosternal process very wide, subparallel toward tip, the latter broadly arcuate and usually extending somewhat over the apex of the extremely short and broadly rounded metasternal process, with the sides of the process less advanced posteriorly, its width, at the apical width of the process in front of the latter, being about four times that of the coxal grooves. Body moderately stout, shining, blackish-piceous, the elytra more rufous, except toward the sides posteriorly and broadly in the region of the scutellum; abdomen black, the apical margin of all the segments dull rufous; antennae blackish, pale toward base, the legs pale as usual; head small, distinctly less than half as wide as the prothorax, finely, sparsely, the latter finely but rather closely, punctured; eyes large; antennae nearly as in the preceding species but less stout, the sixth joint slightly wider than the apical but scarcely twice as wide as long; prothorax two-thirds wider than long, strongly narrowed anteriorly, the sides and base broadly rounded with the basal angles obliterated as usual; elytra nearly twice as wide as long, shorter than the prothorax, the suture nearly three-fourths as long as the latter; abdomen only moderately narrowed from base to apex, the former as wide as the elytra, the punctures coarse and very sparse; hind tarsi rather distinctly shorter than the tibiae, the first joint obviously shorter than the next three combined and equal to the last two. *Male* with the comb of the sixth tergite composed of about twelve short triangular teeth, the two or three at each side generally smaller than the others. Length 4.8-6.0 mm.; width 1.2-1.65 mm. New York (Catskill Mts. and Ithaca), — H. H. Smith.....**sternalis** n. sp.
- Median punctate part of the mesosternal process less broad and more tapering behind, not extending as far posteriorly as the sides of the process and with its tip rounded or narrowly truncate, its width, at about the

- width of the tip of the process before the latter, being about three times that of the coxal grooves.....6
- 6 — Form stouter than in *sternalis*, with the abdomen more strongly narrowed from base to apex, the coloration throughout nearly similar, the pronotum sometimes faintly paler toward the sides, the punctuation similar, except that the abdomen is fully as coarsely, though rather less sparsely, punctate; head somewhat larger, nearly half as wide as the prothorax, which is relatively larger than in *sternalis* but similar in form; antennae similarly short but rather stouter; elytra finely, closely, subasperately and very distinctly punctured nearly as in *sternalis* throughout. *Male* with the teeth of the sixth tergite about twelve in number, short, stout and triangular, those at the sides not appreciably smaller than the others; first joint of the hind tarsi as long as the next three together and distinctly longer than in the preceding species. Length 3.8-6.0 mm.; with 1.2-1.9 mm. New York (Long Island), Indiana, Virginia (Norfolk) and Louisiana.....*lustrica* Say
- Form slender, small in size, shining, dark rufo-testaceous, the head slightly darker, the elytra feebly shaded at the sides and toward the scutellum, the abdomen blackish, rufous at the apical margins of all the segments; legs pale, the antennae blackish, pale toward base as usual; punctures rather smaller, feebler and less close-set than in the two preceding species; head about half as wide as the prothorax, the antennae about as long as the head and prothorax combined, very stout, the joints about the sixth twice as wide as long and somewhat wider than the apical; prothorax short, fully three-fourths wider than long, rather less narrowed anteriorly than in *lustrica*, the sides and base broadly rounded, the basal angles somewhat evident though very obtuse and broadly rounded; elytra not quite twice as wide as long, the sides as long as the prothorax, the suture nearly four-fifths as long; abdomen as in *lustrica*, the punctures very coarse; hind tarsi about as long as the tibiae, the basal joint not quite as long as the next three combined. *Male* with the teeth relatively somewhat larger than in the two preceding species and only about eight in number, the one at each side usually being rudimentary. Length 3.7 mm.; width 1.1 mm. Ohio (Cincinnati).
- algonquina* n. sp.
- 7 — Body less stout than usual, shining, flavo-testaceous, the head, median parts of the pronotum and scutellar region of the elytra pale piceous; abdomen blackish, the apices of the segments pale; antennae dusky, paler toward base; punctures coarser but feeble and very sparse on the head, smaller and less sparse on the pronotum, stronger, dense and asperate on the elytra, the abdominal punctures coarse and very sparse; head fully half as wide as the prothorax, the eyes large, the antennae of the usual type though less stout, as long as the head and prothorax, the outer joints subequal in width, obtrapezoidal and distinctly less than twice as wide as long; prothorax three-fourths wider than long, only moderately narrowed anteriorly, broadly rounded at the sides and base, the basal angles broadly arcuate; two approximate anterior punctures placed transversely unusually distinct; elytra less than twice as wide as long, the sides about as long as the prothorax, the suture nearly four-fifths as long; hind tarsi distinctly shorter than the tibiae, the basal

- joint unusually short, but little longer than the next two combined; mesosternum moderately wide, arcuately narrowed at tip, the median punctate part obtusely acuminate, barely reaching the apex, and, at a short distance before the apex, not quite three times as wide as the coxal grooves. *Male* with the teeth of the sixth tergite large, broadly triangular, about nine in number, the middle tooth wider and forming a rounded lobe. Length 4.5 mm.; width 1.18 mm. New York (Catskill Mts.), — H. H. Smith.....*medialis* u. sp.
- 8 — Antennae somewhat as in the preceding group, short, very stout and fusoid, narrowing toward the tip, distinctly shorter than the head and prothorax combined, the joints compactly placed and very strongly transverse. Body very stout, large, parallel, shining, deep black throughout, the legs and antennae also black, the latter not distinctly paler at base, the tarsi piceous; head much less than half as wide as the prothorax, sparsely punctate, the eyes large; prothorax two-thirds wider than long, strongly rounded at base, the sides strongly converging anteriorly and less arcuate than usual, but with the basal angles broadly arcuate and obliterated, the punctures minute and rather sparse; elytra not twice as wide as long, the sides evidently longer than the sides of the prothorax, the suture two-thirds as long as the median line of the latter, the punctures close-set, strong and asperate, much larger than those of the prothorax; abdomen at base as wide as the elytra, only very slightly narrowed thence to the apex of the fifth segment, the punctures coarse and moderately sparse; hind tarsi thicker toward tip than in the preceding division, the tarsi shorter than the tibiae, very slender, with the basal joint not quite as long as the next three combined; mesosternal process very wide, the sides more converging than in the *lustrica* group, the apex arcuately narrowed. Length 5.0-7.5 mm.; width 1.6-2.3 mm. New York and Virginia to Iowa.....*lata* Grav.
- Antennae longer and more slender, the outer joints much less transverse, gradually thicker to the tip, the eleventh joint being wider than any preceding.....9
- 9 — Punctured part of the mesosternal process broad, truncate at tip and extending fully to the apex of the process.....10
- Punctured part of the mesosternal process finely acuminate at tip.....11
- 10 — Form moderately stout, subparallel, blackish-piceous throughout anteriorly, the antennae dull rufous at base; elytra dark rufous, broadly blackish about the scutellum and at the sides, except, as usual, near the humeri; abdomen black throughout, the legs dull rufous; head distinctly less than half as wide as the prothorax, both finely, rather closely punctate; antennae longer than the head and prothorax together, rather slender toward base, moderately thick distally, the eyes moderate; prothorax two-thirds wider than long, moderately narrowed anteriorly, the sides unusually arcuate and as strongly so as the base; elytra two-thirds wider than long, finely, moderately densely and somewhat asperately punctured, the suture scarcely two-thirds as long as the prothorax; abdomen formed as usual, the punctures normally sparse but not very coarse, the impressious very minutely, sparsely punctate; sixth tergite trapezoidal, the apex broadly sinuato-truncate; basal joint of the hind tarsi as long as the last two combined, shorter than the succeeding

three; mesosternal process moderate in width in comparison with the preceding species, the metasternum very broadly, feebly angular. Length 4.8 mm.; width 1.3 mm. California (Lake Tahoe).

tahoensis n. sp.

Form less stout, smaller in size, shining, black, the elytra bright rufous, with the inflexed flanks black; legs pale, the antennae black, piceous at base; head distinctly less than half as wide as the prothorax, finely, sparsely punctate; antennae much longer than the head and prothorax, less incrassate than in *tahoensis*, the third joint much longer than the second and relatively more elongate than in that species; prothorax three-fifths wider than long, strongly narrowed toward apex with the sides moderately arcuate, more strongly so toward base, the angles much more broadly rounded than in *tahoensis*, the base broadly arcuate; punctures fine and rather sparse; elytra short, the sides evidently shorter than those of the prothorax, the suture two-thirds as long as the median line, the punctures finer and less asperate than in the preceding species, moderately close-set; abdomen nearly similar but rather more coarsely and sparsely punctate, at base as wide as the elytra, moderately narrowed thence to the tip; basal joint of the hind tarsi somewhat shorter than the last two combined; metasternum nearly as in *tahoensis*. Length 3.7 mm.; width 1.2 mm. Kansas (Douglas Co.),—
F. H. SNOW.....*kansana* n. sp.

11—The punctured part abbreviated, not attaining the tip of the process by the width of the coxal grooves approximately; metasternum broadly angulate.....12

The punctured part attaining the apex of the process or virtually so.....13

12—Body moderately stout and convex, shining, black, the sixth abdominal segment rufous toward base; elytra bright red, the base and sides black except at the humeri; antennae dusky, the legs pale piceo-rufous; head small, much less than half as wide as the prothorax, sparsely, feebly punctate, the antennae rather stout distally, with the second joint much shorter than the third, longer than the head and prothorax, the latter scarcely two-thirds wider than long, the sides unusually convergent anteriorly and rather feebly arcuate, the base only moderately rounded, the angles very much rounded though not obliterated, the punctures very fine and not dense; elytra shorter than the prothorax, the punctures stronger and asperate, irregular, fine and very dense along the basal concavity, elsewhere much less close-set and rather coarse; abdomen distinctly narrowed from the base, the punctures coarse and moderately sparse, very conspicuous, the sixth tergite sinuato-truncate at tip. Length 4.4 mm.; width 1.2 mm. New York (near the city).....*pleuralis* n. sp.

Body moderately stout, less parallel, the prothorax much smaller, black, the elytra bright rufous with the sides and basal margin black, the sixth abdominal segment rufous, black toward tip; legs pale red-brown, the antennae black, rufo-piceous at base; head larger, half as wide as the prothorax, finely, sparsely punctate, the antennae attaining the middle of the elytra, less incrassate distally, the subapical joints only moderately transverse, the second and third joints much elongated, the former much the shorter; prothorax less narrowed from base to apex,

- with the sides evenly and strongly arcuate throughout, three-fifths wider than long, finely, somewhat closely punctured; elytra distinctly wider than the prothorax, the sides equal in length to those of the latter, the suture nearly three-fourths as long as the median line, the punctures rather fine, sparse and uneven; abdomen nearly as in *pleuralis* but rather less coarsely and more sparsely punctured. Length 3.8 mm.; width 1.2 mm. Kansas (Douglas Co.),—F. H. Snow. *ellipticollis* n. sp.
- 13 — Elytra pale flavo-testaceous, shaded with blackish-piceous at the sides behind the humeri.....14
- Elytra pale and uniform in color throughout.....15
- 14 — Form moderately stout, somewhat rounded at the sides when contracted, shining, blackish-piceous, the abdomen blacker with the tip rufescent; head small, not much more than two-fifths as wide as the prothorax, sparsely, feebly punctate; antennae much longer than the head and prothorax, gradually stout distally, the penultimate joints as usual but little wider than long, the second joint much more elongate than in *pleuralis* and almost as long as the third; prothorax shorter and more transverse than in *pleuralis* and less narrowed anteriorly; elytra shorter than the prothorax, the suture three-fourths as long as the latter, the punctures rather fine but distinct, somewhat asperate and evenly, moderately closely placed; abdomen strongly narrowed from the base, coarsely, sparsely punctured as usual, the sixth tergite narrow, truncate; hind tarsi long, almost as long as the tibiae, the first joint distinctly shorter than the next three together. Length 4.0 mm.; width 1.18 mm. Massachusetts.....*americana* n. sp.
- Form stouter, the size larger, shining, black, the elytra except on the flanks and about the scutellum, the tip of the fifth and entire sixth ventrals, bright rufous; antennae dusky, the basal parts and legs pale, the femora somewhat dusky on the under surface; head not quite half as wide as the prothorax, minutely, sparsely punctulate, the antennae long, extending to the middle of the elytra, the subapical joints slightly transverse, the third greatly elongated and very much longer than the second; prothorax strongly transverse, two-thirds wider than long, distinctly narrowed toward tip, the sides broadly rounded, rather more strongly toward base, the latter evenly but not strongly arcuate, the punctures fine, rather sparse; elytra transverse, scarcely wider than the prothorax, the outer side equal in length to the side of the latter, the suture two-thirds as long as the median line, the punctures fine, even, only feebly asperate and well separated; abdomen at base as wide as the elytra, very sparsely and only moderately coarsely punctured, only slightly narrowed thence to the tip of the fifth segment, the sixth broader than in *americana* and wholly red; hind tarsi much shorter than the tibiae, with the basal joint as long as the last two combined, shorter than the succeeding three. Length 4.5 mm.; width 1.4 mm. Colorado (Buena Vista),—H. F. Wickham.....*postpicta* n. sp.
- Form still stouter, shining, black, the elytra, except on the flanks and about the scutellum, dark piceo-rufous, the sixth ventral not much paler, piceous-black; antennae black, dark rufo-piceous toward base, the legs paler, piceo-rufous; head much larger than in *postpicta*, fully half as wide as the prothorax, the antennae distinctly longer than the head

and prothorax, moderately incrassate, the second and third joints elongate as in the preceding; prothorax nearly three-fourths wider than long, rather more strongly narrowed anteriorly, with the sides less arcuate, the punctures fine but more distinct, moderately sparse; elytra larger, more evidently wider than the prothorax, the sides obviously longer than those of the latter, the suture three-fourths as long as the median line, the punctures less fine, strongly asperate and close-set throughout; abdomen at base as wide as the elytra, but little narrowed thence to the tip, the punctures coarser than in *postpicta* and equally sparse; hind tarsi similar. Length 4.4 mm.; width 1.45 mm. Montana (Kalispell).— H. F. Wickham.....*montanica* n. sp.

- 15— Form rather stout, parallel, piceous-black, the sides of the prothorax, entire elytra, abdominal tip and legs rufous; antennae dusky, gradually rufous toward base; head finely, sparsely, the pronotum minutely and closely punctate, the former small, scarcely more than two-fifths as wide as the latter, the eyes large as usual; antennae long, extending to the middle of the elytra, gradually, strongly incrassate to the tip, the second joint more elongate than usual but still much shorter than the third; prothorax unusually large, dilated and strongly rounded at the sides, moderately narrowed at apex, the base less arcuate than the sides, the basal angles broadly rounded; disk three-fifths wider than long; elytra not at all wider than the prothorax, and, at base, narrower, distinctly shorter than the latter, the suture three-fifths as long, the punctures fine, close-set and asperate; abdomen but little narrowed behind, at base fully as wide as the elytra; punctures moderately coarse, unusually close-set toward base but extremely sparse toward tip; metasternal process less abbreviated than usual, triangular; hind tarsi very slender, almost as long as the tibiae, the basal joint very long, equal to the next three combined. Length 3.3–4.0 mm.; width 1.15–1.3 mm. Canada (Grimsby).....*thoracica* Csy.

Form much less stout, less parallel, polished, the head blackish-piceous, the prothorax paler piceous, the elytra throughout pale flavo-testaceous, the abdomen black, pale at tip; antennae fuscous, the basal parts and legs pale; head nearly half as wide as the prothorax, somewhat longer than wide, very finely, sparsely punctate, the antennae nearly as in *thoracica*, extending rather beyond the middle of the elytra; prothorax much smaller than in *thoracica*, strongly narrowed toward apex, rounded laterally toward base, the latter evenly arcuate as usual, the angles subobliterated; disk three-fifths wider than long, very finely, evenly but not very closely punctate; elytra much shorter than the prothorax, the sides more diverging from the base than in the preceding, strongly closely and asperately punctate, the suture three-fifths as long as the prothorax; abdomen distinctly narrowed from base to apex, coarsely, sparsely punctured throughout, the punctures gradually smaller posteriorly; metasternal process nearly as in *thoracica* but more obtuse at apex; hind tarsi shorter than the tibiae, the basal joint not quite as long as the next three combined. Length 3.2 mm.; width 1.0 mm. Rhode Island (Boston Neck).....*collusor* n. sp.

The species as above arranged are readily divisible into three groups, one comprising the first six species of the table, the second represented by *lata* and the European *fuscipes*, which is closely related thereto but apparently wholly foreign to America, and the third by the last nine species of the table, which differ greatly from the others in the long antennae, gradually and evenly incrassate to the tip. The characters of the genus as given in the table of genera are common to all, however, and these groups could not be considered worthy of subgeneric designation in any way. The second antennal joint is always distinctly shorter than the third, generally very distinctly so but less conspicuously in some of the species of the third group. The vestiture throughout the genus is short, stiff, subdecumbent and fulvous in color, rather close and conspicuous on the anterior parts but, though still stiffer and longer, it is very sparse and less distinct on the abdomen. The male pectination of the sixth tergite in the first division of the table is more constant than in *Maseochara*, where it is subject to considerable accidental variation, but, at the same time, it is somewhat uncertain in *Aleochara* as well and is only employed in the table in conjunction with other peculiarities of structure.

The identification of *lustrica* Say, with *fuscipes* Fabr., is another instance of carelessness in systematic work, tending to render our lists of Coleoptera common to Europe and America virtually useless. The European examples of *lata* Grav., appear to have the elytra a trifle shorter than the American as a rule, and, although in my opinion perfectly conspecific, they may be the form inscribed in the lists as *Staphylinus (Aleochara) brachypterus* Fourc; if not, I do not know this species, described from France; it is not in the European catalogue of Heyden, Reitter and Weise. The European *crassicornis* Lac., and *lateralis* Heer, resemble *pleuralis* very much in outward form but do not in reality belong to the same group, the form of the antennae showing that they are members of the *lata* and *fuscipes* division of the genus. They are not specifically identical, if the specimens in my cabinet are correctly identified, one having the punctured

part of the mesosternal process truncate at tip as in *tahoensis*, the other having this finely acuminate at tip as in *americana* and other allied species. *Thoracica* was originally described as a *Baryodma*, only the fine tip of the central elevated part of the mesosternal process being visible in the specimen described and presenting the appearance of a low obtuse carina; there is no trace of real carina, however, and the species is a true *Aleochara*.

Aidochara n. gen.

This genus appears to replace *Aleochara* in the fauna of the Pacific coast, although represented at present by only a single small species. The general habitus differs from that of *Aleochara* in being more parallel, with much greater development of the head and more quadrilateral prothorax. It differs further from *Aleochara* in the fact that the second antennal joint is much longer and not shorter than the third and the last joint, instead of being pyriform, is here shorter and evenly pointed from near the base, scarcely longer than wide in the type species. The mesosternal process differs in being very much narrower, obtusely pointed at tip and somewhat abbreviated, extending to about apical fifth of the coxae, the metasternal process being correspondingly longer, triangular and about as long as wide; it meets the mesosternal process at apex in much the same way as in *Aleochara*, and, similarly, the mesosternum is without vestige of carina at any point. The abdomen differs decidedly, being impressed only on the first dorsal plate, the others being flat and evenly, more closely and finely punctate throughout their extent. The type may be defined as follows: —

Moderately stout and convex, slightly shining, the surface very minutely reticulate in addition to the punctuation, black, the entire elytra and abdominal tip rufous; legs pale, the entire antennae darker, piceo-testaceous; head wider than long, fully three-fourths as wide as the prothorax, finely, rather sparsely punctate, the eyes moderately large; antennae very short, stout and compact, cylindrical beyond the middle, with the penultimate joints rather more than twice as wide as long, not as long as the head and prothorax, the latter one-half wider than long, only slightly narrower at apex than at base, the latter broadly and

strongly, the sides more feebly, arcuate; basal angles very obtuse, rounded but not wholly obliterated; punctures not so fine as usual in *Aleochara*, moderately close-set, even, the disk feebly impressed transversely near the base toward the middle; elytra short, less than twice as wide as long but much shorter than the prothorax and equally wide, the sides shorter than the sides of the prothorax, the suture two-thirds as long as the median line; punctures moderately strong, somewhat close-set and feebly asperate; abdomen only slightly narrowed from the base, where it is as wide as the elytra, to the apex; hind tarsi subequal in length to the tibiae, the basal joint as long as the next two combined. Length 2.8 mm.; width 0.87 mm. California (San Francisco).

planiventris n. sp.

I found but a single specimen of this interesting species somewhere in the vicinity of the city and appear to have made no notes as to habits. The basal part of the second tergite seems to bear traces of impression toward the axial line in certain lights, but it does not resemble the usual abdominal impressions.

Xenochara Rey.

Although similar in many characters to *Aleochara* and having much the same general habitus, the few species of this genus may be known at once by the remarkable structure of the mesosternum, which gradually becomes strongly elevated posteriorly, the process of moderate width becoming compressed toward tip; the summit of the elevation is finely acute and extends to the anterior margin of the mesosternum, forming on the anterior and scarcely elevated parts, a fine carina similar to that of *Baryodma* and allied genera. The summit of the ridge slopes posteriorly toward apex, this sloping part bearing coarse suberect setae. The metasternum is even less developed between the coxae than in *Aleochara*, and, in the European *puberula*, forms a transverse and feebly, evenly arcuate line, which is just attained on the same level by the mesosternal process, the latter being arcuato-truncate at tip, with the lateral edges reflexed nearly as in *Aleochara*. The head and antennae are nearly as in the third group of *Aleochara* referred to above, but the abdomen, though similarly impressed, differs very greatly in being finely, densely and uniformly punctate throughout. The pubescence is sim-

ilarly subdecumbent and fulvous but is denser than in *Aleochara*, and the body has somewhat the same stout compact build, differing in many minor points, such as the relatively less developed prothorax with better defined hind angles. Our only species may be described as follows: —

Rather stout, convex, shining, piceo-castaneous in color, the abdomen black, each elytron obliquely shaded with dark rufous on the disk from the humeri toward the sutural apex; antennae blackish, gradually paler toward base, the legs pale; head moderate, rather wider than long, fully half as wide as the prothorax, finely, rather closely punctulate; antennae longer than the head and prothorax, gradually and moderately incrassate distally to the tip, the eleventh joint elongate, subpyriform, the tenth about one-half wider than long, the second and third elongate and equal; prothorax nearly three-fourths wider than long, the sides strongly, anteriorly converging and rather feebly arcuate, the base broadly, circularly arcuate, the angles evident though well rounded; punctures fine, even and dense throughout; elytra at the sides as long as the sides of the prothorax, continuing the curvature of the latter, but becoming parallel and arcuate posteriorly, the suture three-fourths as long as the prothorax, the punctures fine, asperate and very dense throughout; abdomen at base as wide as the apex of the elytra, rather strongly, evenly narrowed thence to the tip, less finely and closely punctate than the elytra. Length 3.75 mm.; width 1.22 mm. Texas (Galveston). [= *Baryodma bip.*, Csy.]

bipartita Csy.

This species was erroneously described as a *Baryodma*. There are two other species of the genus known to me, one inscribed in the European lists as *Xenochara puberula* Klug, differing from *bipartita* in its narrower form, less converging sides of the prothorax, relatively less dense punctuation, somewhat larger head and in the form of the metasternal projection — very broadly rounded and subobsolete in *puberula* and more abruptly and parabolically rounded at the middle in *bipartita*, — and a species identified for me by Mr. Reitter as *Baryodma milleri* Kr. The latter of these species is larger than *puberula*, blacker in color and with a smaller head, the oblique rufous band of each elytron, characterizing *puberula*, being obliterated toward the humeri, resulting in an angulate rufous apical spot. The identification of the species may not be correct, but the specimen before me was collected in the Caucasus.

Oreochara n. gen.

The obviously conical fourth papal joint isolates this genus and constitutes a very remarkable exception, not only in the present group but in the subfamily itself, where the constancy of this joint in general form is a notable peculiarity. The body is broad and heavy, nearly as in some of the stouter forms of *Aleochara*, such as *fuscipes*, but is more finely and closely sculptured, especially on the abdomen, and the prothorax is shorter and transversely subquadrilateral. Other structural features separating it from any form of *Aleochara* are the deeply and subequally impressed first three tergites and the narrowly separated middle coxae, with the process of the mesosternum not quite attaining their apices and having the smooth coxal grooves, so well developed in that genus, narrower and deeper and meeting at the tip behind the finely acuminate and finely punctate median part, which does not quite attain the truncate apex of the process. The level of the process at apex is considerably below the angulate metasternal process, the latter being overlapped slightly. The single known species may be described as follows: —

Stout, parallel, moderately convex, shining, finely, closely fulvo-pubescent, the vestiture decumbent, piceous-black, the elytra and legs throughout rather pale rufo-testaceous, the antennae dusky rufous; head rather large, nearly three-fifths as wide as the prothorax, wider than long, but little narrowed behind the eyes which are rather convex and at somewhat more than their own length from the base, the punctures fine and moderately close-set; antennae stout, not quite as long as the head and prothorax, gradually thickened from the fourth to sixth joints and thence parallel to the apex, the subapical joints not quite twice as wide as long; prothorax two-thirds wider than long, truncate at apex, broadly arcuate at base, the sides very moderately converging from base to apex and broadly, evenly arcuate; basal and apical angles obtuse but only slightly rounded, the punctures fine, rather close-set and even throughout; elytra rather more than two-thirds wider than long, broadly, arcuately impressed at base, the sides much longer than the sides of the prothorax, the suture shorter than the median line, together broadly sinuate-truncate at tip, the punctures fine but strong, very close-set; abdomen about as wide as the elytra, parallel, finely, rather closely punctate, gradually less closely toward tip, the lateral border strong; legs finely pubescent. Length 5.0 mm.; width 1.65 mm. Wyoming (Laramie),—H. F. Wickham..... **laramiensis** n. sp.

The male sexual characters are probably feeble and of the usual form in *Baryodma* and allies. The sixth ventral in the type of *laramienseis* is broadly sinuato-truncate at tip. The scutellum does not extend behind the depressed base of the elytra and is densely and asperately punctate. The basal margin of the pronotum is finely reflexed, the surface adjoining feebly and finely impressed, then rising and convex to the general level, the portion near the base almost impunctate except toward the middle. The punctures of the head and pronotum are simple and impressed, but there are, besides the pubiferous punctures, numerous very minute punctules scattered over the interspaces; the punctures of the abdominal impressions are noticeably larger than the others but not notably coarse.

Calochara n. gen.

In this genus and the preceding we observe a transition in some respects from those having a perfectly simple and unmodified mesosternal surface to the allies of *Baryodma* with carinate mesosternum, for here we have a fine short carina in about anterior half only, as in some of the species of the next genus. In other features, however, the genus *Calochara* is an isolated type. As in *Aidochara*, the head is unusually developed. The sculpture of the anterior parts, particularly of the elytra, is rather conspicuously coarse and sparse, contrasting with the fine close sculpture of all the other genera of Aleocharae, excepting *Eucharina*. The feature which however decides its isolation among the genera with strongly inflexed hypomera, besides the form of the the third palpal joint as stated in the table, is the form of the mesosternal process, which is here finely acuminate at tip, contrasting with the truncate apex in all other genera of the first group of the subtribe. This very acute form of apex is common among the genera having feebly inflexed hypomera, but among those of the first series this is the only instance known to me, for while in the genus immediately following, the mesosternal process sometimes becomes very narrow, it is invariably

truncate or sinuate at tip. The type may be recognized by the following characters:—

Form moderately stout, elongate, parallel, polished, black in color, the antennae paler toward base, the abdomen not paler at tip, the entire elytra and legs bright rufo-testaceous; head wider than long, fully four-fifths as wide as the prothorax, distinctly and rather sparsely punctate, the eyes well developed; antennae as long as the head and prothorax, gradually and rather strongly incrassate to the tip, the eleventh joint elongate, pointed and triangular, the tenth fully one-half wider than long, the second slightly shorter than the third; prothorax two-thirds wider than long, the sides parallel, becoming arcuate and converging anteriorly and posteriorly, the apex but little narrower than the base, which is broadly and strongly arcuate, the basal angles very obtuse but less rounded than in *Aleochara*, the punctures fine but strong, annular, not very close-set but evenly distributed, the two anterior discal punctures distinct; elytra one-half wider than long, slightly longer and wider than the prothorax, the suture somewhat shorter than the median line of the latter, the punctures rather coarse, even, rounded, scarcely asperate and separated by more than their own diameters; abdomen subparallel, scarcely at all narrowed from base to apex, rather finely, very sparsely punctate throughout, the depressions of the basal segments with still smaller, simple and sparse punctures; basal joint of the hind tarsi as long as the next two combined. Length 4.4 mm.; width 1.05 mm. California (Lake Co.),—Charles Fuchs.

rubripennis n. sp.

The pubescence is rather long and fulvous but sparse, and, unlike that of the preceding genera, is erect and bristling on the head and pronotum but more decumbent on the elytra; it is very sparse and inconspicuous on the abdomen, though the usual apical porrect fringe of each segment is well developed. I have seen only one specimen which is of undetermined sex.

Baryodma Thoms.

There is considerable latitude of variation among the components of this large and universally distributed genus, particularly in the extent of the mesosternal carina, sculpture, especially of the pronotum, and relative length of the tarsi and tarsal joints. It would appear at first sight as though such divergencies as observable in the pronotal sculpture of *imbricata*, *sculptiventris* and many others, where the punctures are fine, close-set and even throughout and of *bimaculata*,

verna and others, where there is a broad convex impunctate median line defined by shallow and confusedly punctate impressions, should indicate some differences of generic weight, or that such an extreme abbreviation of the mesosternal carina as that of *castaneipennis*, or widely separated middle coxae as in *imbricata*, or very narrowly separated coxae as in *defecta*, might betoken other differences of at least subgeneric value, but such does not seem to be the case and I can find no rational means of dividing the genus, even subgenerically. The most conspicuous character in a taxonomic arrangement of the species is the sculpture of the pronotum, but such forms as the European *laevigata* Gyll., if my representative is correctly identified, are intermediate in this respect between those species with even punctuation and those having two impressed punctured series, the case being somewhat similar to that of *Sphenophorus*, of the Rhycho-phora. The generic characters of *Baryodma* have been sufficiently stated in the table and need not be further considered at present. The twenty-six species before me may be separated as follows: —

Punctures of the pronotum evenly distributed throughout the disk, generally fine.....	2
Punctures of the pronotum more sparsely and unevenly distributed toward the sides and aggregated into two shallow longitudinal impressions at the middle, particularly evident toward base, the space between the series always devoid of punctures.....	13
2 — Mesosternal carina very much abbreviated, not extending posteriorly as far as the middle of the axial length of the mesosternum and scarcely more than reaching the anterior line of the middle acetabula; mesosternal process very narrow toward tip.....	3
Mesosternal carina abbreviated but only slightly so, the process always narrow toward tip.....	4
Mesosternal carina entire and attaining the tip of the process, the latter very variable in width but always at least somewhat wider than in the preceding groups.....	10
3 — Head and prothorax small, the latter narrower than the basal part of the elytra. Body moderately stout and convex, shining, black, the elytra and legs very dark castaneous in color; antennae blackish, gradually slightly paler toward base; head small, three-fifths as wide as the prothorax, somewhat wider than long, minutely, sparsely punctate, the eyes moderately large, slightly prominent; antennae distinctly longer than the head and prothorax, gradually and moderately increas-	

sate to the tip, the tenth joint about one-half wider than long, the second and third elongate, the former slightly the shorter; prothorax small, nearly two-thirds wider than long, only moderately narrowed from base to apex, rather strongly, evenly rounded at the sides, the base broadly arcuate, the punctures fine and inconspicuous, not very close; elytra large, scarcely one-half wider than long, distinctly wider and longer than the prothorax, the suture about equal in length to the latter, the punctures fine, close-set and asperulate; vestiture of the anterior parts rather sparse, fine, fulvous and subdecumbent; abdomen at base not quite as wide as the prothorax, only feebly narrowed thence to tip, rather finely, sparsely punctured, the punctures becoming very fine and sparse apically, the basal impressions with extremely minute, sparse and nude punctules; basal joint of the hind tarsi scarcely as long as the next two combined. Length 3.5-3.8 mm; width 1.0-1.1 mm. British Columbia (Glenora) to Middle California (Lake Co.). [= *Aleochara cast.* Esch.].....**castaneipennis** Esch.

Head and prothorax relatively larger, the latter as wide as the base of the elytra. Body evidently stouter, similar in coloration and vestiture, except that the elytra are only just visibly paler and piceous; head wider than long, sparsely punctulate, three-fifths as wide as the prothorax; antennae attaining the middle of the elytra, the tenth joint scarcely a third wider than long; prothorax proportioned nearly as in the preceding, but rather more narrowed from base to apex, the sides slightly less arcuate, the punctation fine and not dense; elytra still larger, much longer, and, near the middle, distinctly wider than the prothorax, the suture fully as long as the latter, the punctures rather fine but more distinct, close-set and asperate; abdomen at base as wide as the elytra, somewhat distinctly narrowed thence to the tip; sparsely punctured and polished nearly as in *castaneipennis*; basal joint of the hind tarsi as long as the next two combined. Length 3.4 mm.; width 1.2 mm. California (Pomona), — H. C. Fall.....**robustula** n. sp.

4 — Abdomen rather finely punctate and polished, the punctures notably sparse. Pacific Coast and Rocky Mountains..... 5

Abdominal punctures much more close-set but not dense. Atlantic regions.....9

5 — Mesosternal carina much abbreviated, not attaining the tip of the process by more than twice the width of the process at the posterior end of the carina. Body moderately stout, polished, piceous, the abdomen blackish, the elytra and legs pale rufous, the antennae fuscous, pale toward base; vestiture rather sparse and inconspicuous; head small, as long as wide, one-half as wide as the prothorax, the eyes well developed but at an unusual distance from the base; antennae as long as the head and prothorax, gradually, rather strongly incrassate to tip, the tenth joint scarcely twice as wide as long, the second and third elongate and subequal; prothorax of the usual transverse form and fine, rather sparse punctation, but unusually narrowed from base to apex, the sides and base rounded; before the middle of the base there are two feeble approximate impressions, homologous with the discal lines of *bimaculata* and allies; elytra scarcely one-half wider than long, subequal in length and width to the prothorax, the suture four-

fifths as long as the latter, the punctures asperate and moderately strong but not very close-set; abdomen at base scarcely as wide as the elytra, only moderately narrowed thence to the tip; basal joint of the hind tarsi rather longer than the next two combined, joints two to four equal, the tarsus distinctly shorter than the tibia. Length 3.5 mm.; width 0.95 mm. British Columbia (Glenora), — H. F. Wickham.

glenorana n. sp.

- Meso-sternal carina less abbreviated, not attaining the tip of the process by about the apical width of the latter, and sometimes much less.....6
- 6 — Elytra evidently much longer than the prothorax.....7
- Elytra about equal in length to the prothorax or at least not conspicuously longer, the form more elongate, parallel and linear.....8
- 7 — Head small, half as wide as the prothorax, the sides of the latter strongly converging and evenly, moderately arcuate from base to apex; antennae longer and less incrassate, longer than the head and prothorax, the tenth joint less than one-half wider than long, the second and third elongate and subequal. Body only moderately stout, more parallel than in *rotundicollis*, polished, black, the elytra dark piceo-rufous, the legs dark piceous, the antennae blackish, not distinctly paler at base; head and prothorax finely, sparsely punctulate, the latter less transverse than usual, scarcely one-half wider than long, the pubescence very fine, sparse and inconspicuous; elytra parallel, scarcely wider but evidently longer than the prothorax, the suture about as long as the latter, the punctures fine, unusually feeble and widely separated, not at all dense; abdomen at base nearly as wide as the elytra, moderately narrowed thence to the apex, very finely and sparsely punctate, polished; hind tarsi almost as long as the tibiae, the basal joint as long as the next two combined. Length 3.2-3.8 mm.; width 0.82-1.0 mm. California (San Francisco to Humboldt Co.).....*avidula* n. sp.
- Head larger, three-fifths as wide as the prothorax, the sides of the latter very feebly converging from base to apex and more rounded; antennae shorter, more compact and incrassate, as long as the head and prothorax, the tenth joint nearly twice as wide as long, the second and third elongate, the former slightly the shorter. Body slightly stouter, less parallel, shining, piceous, the abdomen black, the elytra piceo-rufous; antennae black, piceous at base, the legs paler, piceous; head and pronotum minutely, sparsely, the latter less sparsely, punctate, the eyes rather distant from the base; prothorax small, one-half wider than long, strongly rounded at base, the disk with two feeble approximate longitudinal impressions toward base; elytra large, much wider as well as longer than the prothorax, the suture slightly longer than the median line of the latter, the punctures fine, asperulate and close-set, much less separated than in the preceding species; abdomen at base distinctly narrower than the elytra, moderately tapering, very finely, sparsely punctured; hind tarsi somewhat shorter than in *avidula*. Length 3.4 mm.; width 1.0 mm. Queen Charlotte Island....*rotundicollis* n. sp.
- Head rather more than half as wide as the prothorax, the latter transversely elliptical, with the sides only just visibly converging from base to apex and strongly, evenly arcuate; antennae very well developed, gradually and strongly incrassate to the tip, the tenth joint less than twice as

wide as long, the eleventh conoidal, ogivally pointed, longer than the two preceding together, the second and third moderately elongate and subequal. Body moderately stout, subparallel, pale brownish-testaceous in color, the elytra still brighter and rather more rufous, the abdomen piceous; prothorax rather small, slightly narrower than the elytra, fully one-half wider than long, finely, evenly and somewhat sparsely punctured, the pubescence rather long, sparse but distinct; elytra at the sides much longer than the sides of the prothorax, the suture scarcely shorter than the median line, the punctures fine, subasperate and only moderately dense, the pubescence distinct; abdomen nearly as wide as the elytra, narrowing slightly behind the middle, the punctures fine, moderately close-set basally but becoming gradually very sparse on the last four segments, the punctures of the impressions slightly larger and rather less sparse than the others, and, as usual, bearing only infinitesimal hairs; basal joint of the hind tarsi as long as the next two combined. Length 2.9 mm.; width 0.85 mm. New Mexico (Santa Fé Cañon),— F. H. SNOW.....*acomana* n. sp.

- 8 — Larger and more convex, shining, black, the elytra and legs rather pale rufous, the antennae piceo-rufous, pale toward base; vestiture sparse and rather inconspicuous, fulvous as usual; head well developed, three-fifths as wide as the prothorax, and, like the latter, finely and sparsely punctulate; antennae scarcely as long as the head and prothorax, gradually, strongly incrassate to the tip, compact, the tenth joint three-fifths wider than long, the second and third elongate, the former but slightly the shorter, prothorax large, less transverse, two-fifths wider than long, moderately narrowed from base to apex with the sides strongly arcuate, the base arcuate as usual, the angles very obtuse but evident; elytra only two-fifths wider than long, the sides as long as those of the prothorax, the suture three-fourths as long as the median line, the punctures fine, feebly asperate and well separated; abdomen nearly as wide as the elytra, parallel and straight at the sides, not at all narrowed posteriorly from the base, finely, very sparsely punctate; hind tarsi distinctly shorter than the tibiae, the basal joint not quite as long as the next two combined. Length 3.8–4.4 mm.; width 0.9–0.98 mm. British Columbia (Kamloops and Glenora),— H. F. WICKHAM.....*mannerheimi* n. sp.

Smaller, more depressed, polished, black, the elytra scarcely visibly paler, piceous, the legs paler, rufous; antennae deep black, not at all paler at base; pubescence fine, decumbent, sparse and inconspicuous; punctures anteriorly fine and notably sparse, of the elytra but little larger, asperulate and well separated, of the abdomen fine and very sparse, but larger, rounded and moderately sparse in the basal depressions; head moderate, scarcely more than half as wide as the prothorax; antennae less developed than in *mannerheimi*, less incrassate, not quite as long as the head and prothorax, the tenth joint scarcely more than a third wider than long, the second much shorter than the third; prothorax short and strongly transverse, two-thirds wider than long, moderately narrowed anteriorly and rather strongly rounded at the sides, the base circularly arcuate; elytra strongly transverse, very slightly wider and somewhat longer than the prothorax, the suture just visibly shorter

than the median line; abdomen not quite as wide as the elytra, the sides parallel and straight, feebly converging through the last two or three segments; hind tarsi very slender as usual, as long as the tibiae, which are shorter than usual, the basal joint as long as the next two combined. Length 3.3 mm.; width 0.87 mm. Queen Charlotte Island (Massett).—J. H. Keen.....*insulana* n. sp.

- 9 — Slender, convex, subparallel, shining, piceous-brown in color throughout, the abdomen rather blackish and the elytra somewhat paler than the anterior parts; legs pale, the antennae dark red-brown, paler toward base; pubescence fine, decumbent, short, rather dense on the elytra but not conspicuous; head and prothorax minutely punctulate, the former sparsely, the latter closely but inconspicuously; head but little more than half as wide as the prothorax, the antennae moderate, somewhat strongly incrassate, the second and third joints only moderately elongate and equal, the eighth almost twice as wide as long; prothorax one-half wider than long, rather strongly narrowed from base to apex, the sides rounded toward base, the latter arcuate, the disk even; elytra transverse and somewhat wider and shorter than the prothorax, the suture three-fourths as long as the latter, the punctures fine, strongly asperate and dense; abdomen at base nearly as wide as the elytra, but little narrowed thence to the apex, finely, closely punctulate, sparsely at the tips of the segments, nearly throughout the fifth and sixth; mesosternal process very slender toward tip, the carina not attaining its apex by nearly twice its width at the carinal tip; metasternal process angulate as usual, about one-third as long as the transverse distance between the ends of the acetabula; hind tarsi with the basal joint somewhat longer than the next two combined. Length 3.4–4.0 mm.; width 0.77–1.15 mm. New York (Catskill Mts.).—H. H. Smith.....*defecta* n. sp.
- 10 — Abdominal sculpture simply punctate, the interspaces polished; elytra uniform in coloration.....11
- Abdominal sculpture imbricate, each elytron with an apical pale spot....12
- 11 — Abdominal impressions moderate as in the preceding species, and scarcely more conspicuously punctured than the remainder of the surface. Body slender, black, shining, the elytra and fine apical margins of the ventrals dull rufous or piceo-rufous; legs paler, testaceous, the antennae dusky, pale toward base; punctures of the head and pronotum fine, sparse and inconspicuous, of the elytra less fine, rather strongly asperate and close-set, of the abdomen fine but strong, close-set except at the apical margins of the segments and nearly throughout the fifth and sixth, where they become sparse; vestiture fulvous, decumbent, moderately distinct; head small, not quite half as wide as the prothorax, the antennae about as long as the head and prothorax, somewhat strongly incrassate to the tenth joint which is three-fifths wider than long, the eleventh scarcely as wide as the tenth, obtusely ogival in form and longer than the two preceding combined, the second and third elongate and equal; prothorax well developed, scarcely one-half wider than long, strongly narrowed from base to apex, the sides moderately arcuate, the base rounded; elytra not at all wider than the prothorax and about of equal length, the suture very slightly shorter;

abdomen elongate, parallel, nearly as wide as the elytra; mesosternal process only moderate in width, the carina stronger than in the preceding groups and similar to the following, the metasternal process very short, broadly parabolic; hind tarsi much shorter than the tibiae, the basal joint as long as the next two combined. Length 3.2-4.5 mm.; width 0.7-0.9 mm. British Columbia (Kamloops and Glenora), — H. F. Wickham..... *affluens* n. sp.

Abdominal impressions unusually large, deep and extremely coarsely, subconfluent punctate, the remaining part finely, closely punctate but polished. Body stouter, linear, parallel, black, the elytra scarcely visibly paler, piceous, the legs blackish-piceous, the antennae black, but little paler at base; vestiture fine, short, decumbent, close but not very conspicuous; punctures of the head and pronotum very fine, extremely close-set on the latter, less so on the former, fine, asperate and very dense on the elytra; head half as wide as the prothorax; antennae somewhat longer than the head and prothorax, rather stout, gradually incrassate to the tip, the second joint shorter than the third; prothorax transversely suboval, not much narrowed from base to apex and strongly rounded at the sides; elytra transverse, slightly shorter and evidently wider than the prothorax, the suture fully two-thirds as long, the apical margin finely rufescent; mesosternal process moderately wide but not extending to the posterior limits of the coxae, the metasternal process longer than usual, narrowly rounded under the tip of the mesosternal process, with its margins thickened and much elevated; hind tarsi much shorter than the tibiae, which are unusually finely and closely pubescent, the basal joint long, distinctly longer than the next two combined. Length 3.7-4.4 mm; width 0.85-1.05 mm. New York (Ithaca and Catskill Mts.) to North Carolina (Asheville).

sculptiventris Csy.

12 — Moderately stout, sublinear, polished, convex, deep black, the elytra not distinctly paler, each with a small rufous spot at apex near the suture; legs blackish-piceous, the antennae black, somewhat piceous at base; vestiture moderately distinct, rather sparse, decumbent; punctures of the head very fine and remote, of the pronotum nearly as fine and notably sparse, of the elytra fine but rather strongly asperate and close-set, of the abdomen fine and somewhat close-set throughout, the punctures evenly in quincunx order and joined anteriorly and posteriorly by fine lines, forming a regular imbricate sculpture; head fully as long as wide, not quite half as wide as the prothorax, the antennae unusually slender, attaining the middle of the elytra, the tenth joint only very slightly wider than long, the eleventh longer than the two preceding combined, the second much elongated and — very exceptionally in the genus — slightly longer than the third; prothorax transversely suboval, strongly narrowed from base to apex, the sides only moderately arcuate, the base broadly rounded; elytra slightly longer than the prothorax and about equally wide, the suture equal thereto in length; abdomen long, parallel, not quite as wide as the elytra, the impressions normal; mesosternal process unusually wide, normal in length, the metasternal process broad and very obtuse; hind tarsi short, very much shorter than the tibiae, which are more slender and more coarsely and sparsely

setulose than in *sculptiventris*, the basal joint unusually short, shorter than the fifth and shorter than the next two combined. Length 3.3-4.2 mm.; width 0.73-1.0 mm. California (San Francisco, Humboldt Co., and Lake Tahoe), Nevada (Reno) and Montana (Kalispell).

***imbricata* n. sp.**

Moderately stout, shining, nearly similar in general form, coloration and sculpture to the preceding, the head larger, rather more than half as wide as the prothorax, the antennae somewhat less elongate though evidently longer than the head and prothorax, the tenth joint more evidently wider than long, the eleventh much longer than the two preceding combined, the second and third subequal; prothorax less transverse, about two-fifths wider than long, the sides less converging from base to apex and more rounded; elytra about equal in length and width to the prothorax, the suture four-fifths as long as the latter, the pale spots somewhat larger and more anteriorly angulate; abdomen nearly similar throughout; mesosternal process nearly similar but arcuately narrowing toward apex through a greater distance from the tip, the metasternal process equally broad and obtuse; hind tarsi relatively longer, the tibiae shorter, the basal joint relatively much abbreviated, scarcely more than two-thirds as long as the fifth and one-half longer than the second. Length 3.0 mm.; width 0.85 mm. New Jersey.

***idonea* n. sp.**

More slender, linear, the body and antennae black, the latter piceous toward base; legs blackish, paler distally, the elytra black, without distinct maculation but becoming broadly and suffusedly piceo-testaceous toward the inner apical angles; sculpture and vestiture throughout nearly as in the two preceding species; head about half as wide as the prothorax; antennae long, feebly incrassate, nearly as in *imbricata* but with the tenth joint more distinctly wider than long and the second and third equal; prothorax nearly as in *imbricata*; elytra transverse, much shorter than in *imbricata*, shorter than the prothorax but fully as wide, the suture scarcely four-fifths as long; abdomen nearly similar; mesosternal process nearly similar but with the carina less acute and the tip not concealing the apex of the metasternal process, which is evidently more narrowly parabolic in form; hind tarsi not so markedly shorter than the tibiae as in *imbricata* and more elongate, the tibiae relatively shorter, the very short basal joint nearly as in *idonea*, the first three almost uniformly decreasing in length. Length 3.5 mm.; width 0.77 mm. California (Colorado Desert at Salton), — H. F. Wickham.

***salicola* n. sp.**

13 — Mesosternal process wide as usual.....14

Mesosternal process very narrow; species small in size; punctures of the abdominal impressions much finer.....21

14 — Sides of the prothorax strongly converging from base to apex and only moderately arcuate.....15

Sides of the prothorax feebly converging and strongly arcuate; antennae rather strongly incrassate, with the tenth joint about twice as wide as long, the second and third moderately elongate and subequal; basal joint of the hind tarsi about as long as the next two combined.....20

- 15 — Elytra closely punctured; punctures toward the sides of the pronotum closer and more distinct.....16
- Elytra sparsely and less strongly punctate, the pronotum finely, very sparsely and sometimes barely perceptibly punctate.....19
- 16 — Abdomen extremely densely punctured and opaque. Body small in size, slender, black, the elytra piceous-black, rufescent along the apical margin, more broadly toward the suture; legs dark rufo-piceous, the antennae black, picescent toward base; head relatively well developed, three-fifths as wide as the prothorax; antennae rather strongly incrassate distally, as long as the head and prothorax, the second and third joints elongate, equal, the tenth fully twice as wide as long, the eleventh large, obtusely conoidal, distinctly longer than the two preceding combined; prothorax one-half wider than long, not wider than the base of the elytra, the punctures toward the sides unusually sparse and feeble in the present group; elytra transverse, somewhat wider than the prothorax, the sides slightly longer than the sides of the latter, the suture three-fourths as long as the median line, the punctures small, asperate and close-set but much less dense than those of the abdomen, the latter at base not quite as wide as the elytra; mesosternal process squarely truncate at tip, the latter only tangentially attaining the broadly, evenly parabolic metasternal process and with the angles right and only very narrowly rounded; hind tarsi distinctly shorter than the tibiae, the basal joint equal in length to the next two combined. Length 3.3 mm.; width 0.73 mm. New Mexico (Las Vegas), Arizona and California (Humboldt Co.).....**densiventris** n. sp.
- Abdomen very closely and strongly punctured, the punctures similar to those of the preceding species but narrowly separated, the interspaces polished.....17
- 17 — Antennae unusually short, rather strongly incrassate distally, extending scarcely beyond the middle of the prothorax, the second and the third joints short, stout and equal, each much less than twice as long as wide in the female but longer in the male, feebly obconical, the fourth distinctly transverse, the tenth about twice as wide as long, the eleventh still broader, very obtusely conoidal, longer than the two preceding combined. Body small, rather stout, polished, piceous-black, the elytra rufo-piceous with the region toward the suture nubilously more flavate, except near the base, the abdomen deep black; head rather more than half as wide as the prothorax, the latter larger than in the preceding, less than one-half wider than long, the punctures laterally moderately distinct, the usual large discal puncture at each side conspicuous; elytra slightly wider than the prothorax, the sides somewhat longer than the sides of the latter, the suture two-thirds as long as the median line; abdomen subequal in width to the elytra, parallel; basal joint of the hind tarsi rather short, three-fourths as long as the fifth and much shorter than the next two combined. Length 3.2 mm.; width 0.86 mm. California (Monterey Co.).....**obsolescens** n. sp.
- Antennae having the second and third joints much more elongate, the former somewhat the shorter of the two.....18
- 18 — Basal joint of the hind tarsi unusually short, three-fourths as long as the last, the first three joints decreasing uniformly in length. Body

rather small, only moderately stout, polished, black, the elytra blackish-piceous, not distinctly nubilate with paler at any part, the legs pale piceo-rufous, the antennae black, piceous toward base; head three-fifths as wide as the prothorax, the antennae short, rapidly and strongly incrassate distally, scarcely one-half longer than the prothorax, the tenth joint fully twice as wide as long; prothorax about one-half wider than long, the punctures toward the sides somewhat feebly impressed and inconspicuous, the two large sublateral punctures before the middle distinct; elytra slightly wider than the prothorax, the sides evidently longer than the sides of the latter, the suture nearly three-fourths as long as the median line; abdomen subequal in width to the elytra, parallel; metasternal process unusually narrowly rounded. Length 3.0-3.9 mm.; width 0.72-0.95 mm. New Mexico (Las Vegas).....*recta* n. sp.

Basal joint of the hind tarsi fully as long as the next two combined; metasternal process much more broadly rounded. Body stout, parallel, polished, black, the elytra scarcely at all paler, each with a large, clearly defined and anteriorly rounded spot at apex and near the suture of flavotestaceous; legs piceo-rufous, the antennae black, but little paler at base; head rather small, not quite half as wide as the prothorax, sparsely but somewhat strongly punctured, the antennae longer and less incrassate than usual, almost as long as the head and prothorax, the tenth joint evidently less than twice as wide as long; prothorax well developed, three-fifths wider than long, distinctly, rather closely but somewhat unevenly punctured toward the sides, the sublateral puncture rather before the middle as usual; elytra at the sides about as long as the sides of the prothorax, the suture two-thirds as long as the median line; abdomen as wide as the elytra, closely and strongly punctured throughout, gradually more coarsely in the impressions of the the basal tergites. Length 3.8-6.4mm.; width 1.05-1.68 mm. Entire northern parts of the continent, from the Atlantic to the Pacific, descending on the Pacific coast as far as Monterey, and, along the highlands of the Rocky Mountains to Guanajuato, Mexico. *bimaculata* Grav.

19 — Form moderately stout, parallel, highly polished, deep black, the elytra scarcely at all paler but each with a large rounded flavate spot near the suture, beginning slightly before the middle and expanding to the apical margin, along which it extends narrowly to the outer margin; legs and basal parts of the antennae piceo-rufous, the remainder of the latter blackish; head fully half as wide as the prothorax, having a few fine and remotely scattered punctures; antennae one-half longer than the head, moderately incrassate, the third and fourth joints elongate and subequal, the tenth rather less than twice as wide as long; prothorax large, one-half wider than long, the strongly converging sides feebly and evenly arcuate, the base strongly rounded throughout; elytra at the sides as long as the sides of the prothorax, the suture two-thirds as long as the median line, the punctures fine, evenly and sparsely distributed, feebly asperulate; abdomen as wide as the elytra, parallel, finely, rather sparsely punctulate, the subbasal impressions coarsely but not densely so; mesosternal process unusually wide; basal joint of the hind tarsi as long as the next two combined.

Length 3.1-4.6 mm.; width 0.85-1.22 mm. Texas (Galveston, Waco, Austin and Brownsville) and Mexico (Guanajuato)...**nitidicollis** n. sp.

Var. A — Abdominal and elytral sculpture rather stronger and less sparse, the elytral spots much reduced and forming a fine apical margin, somewhat broadened toward the suture. Texas (Austin) and California (Yuma).

Form slender, the size minute, polished, piceous in color, the abdomen blackish, each elytron with a relatively still larger subsutural flavous spot; legs pale flavo-testaceous, the antennae blackish, piceo-rufous toward base; head three-fifths as wide as the prothorax; antennae as long as the head and prothorax, rather strongly incrassate distally, the tenth joint fully twice as wide as long, the second and third joints moderately elongate, the former distinctly the longer; prothorax in form and sculpture nearly as in *nitidicollis*; elytra at the sides slightly longer than the sides of the prothorax, the suture four-fifths as long as the median line, the punctures fine and extremely sparse; abdomen as wide as the elytra, parallel, the punctures very sparse; basal joint of the hind tarsi much shorter than in the preceding species, distinctly shorter than the next two together. Length 2.25 mm.; width 0.65 mm. Texas (Brownsville),—H. F. Wickham..**nanella** n. sp.

20 — Elytra unusually short, the sides not as long as those of the prothorax. Body only moderately stout, parallel, shining, black, the elytra pale piceo-rufous, becoming nubilously more flavate toward the suture and apex of each; legs pale red-brown, the antennae black, only feebly picescent at base; head relatively well developed, three-fifths as wide as the prothorax, the antennae not as long as the head and prothorax, with the last joint thickest, pyriform and as long as the two preceding combined; prothorax small, transverse, the apex only slightly narrower than the base, the sides strongly arcuate, the punctures laterally very distinct and somewhat close-set; elytra finely, closely and asperately punctate as usual, the suture two-thirds as long as the median line of the prothorax; abdomen nearly as wide as the elytra, strongly, rugosely and closely punctured as usual in this group of the genus. Length 3.8 mm.; width 0.93 mm. California (Newhall)..**innocua** n. sp.

Elytra normally long, the sides as long as those of the prothorax; form stouter, the abdomen but little narrower than the elytra and parallel as usual. Body polished, black, the elytra piceous-black, each with a very large subflavous pale spot in the position of that of *bimaculata* but less distinctly defined; legs rufo-piceous, the antennae black throughout; head distinctly more than half as wide as the prothorax, the antennae much shorter than the two together, strongly incrassate, the eleventh joint longer than the two preceding combined; prothorax larger and less transverse, about one-half wider than long, the sides subparallel and strongly arcuate, the punctures toward the sides much finer, somewhat sparser and notably less conspicuous than in *innocua*; elytra well developed, finely, densely and asperately punctate, the suture two-thirds to nearly three-fourths as long as the prothorax; abdomen with sculpture similar to *bimaculata*, but rather finer and noticeably less dense. Length 3.3-3.8 mm.; width 0.9-1.06 mm. Arizona (Benson),—G. W. Dunn.....**deserticola** n. sp.

21 — Elytra black, each maculate with rufous apically near the suture...22
 Elytra nearly uniform in color throughout or at least never definitely maculate.....23

22 — Form moderately stout, polished, black, the elytra each with a small rounded rufous spot near the suture, occupying apical two-fifths to fourth; antennae black throughout, the legs blackish-piceous; head three-fifths to nearly two-thirds as wide as the prothorax, finely but distinctly, sparsely punctate, the antennae moderately incrassate to the tip, nearly as long as the head and prothorax, the second and third joints elongate, subequal, the former slightly the longer, the tenth fully three-fifths wider than long, the eleventh longer than the two preceding combined, stout and subpyriform; prothorax one-half or more wider than long, the sides distinctly converging from base to apex and somewhat arcuate, the punctures toward the sides fine and somewhat sparse but strong and distinct, the sublateral puncture of the preceding section not distinct; elytra well developed, longer than usual, at the sides much longer than the sides of the prothorax, the suture fully as long as the median line, the punctures somewhat coarse, deep, only slightly asperate and well separated though not very sparse; abdomen subparallel, not quite as wide as the elytra, finely, subrugosely and somewhat closely punctured throughout, not more coarsely in the subbasal impressions; hind tarsi very slender, the basal joint about as long as the next two combined. Length 2.5-3.8 mm.; width 0.78-0.98 mm. Entire northern regions of the continent, from the Atlantic to the Pacific, apparently extending less to the southward than *bimaculata*.

verna Say

Form less stout, smaller in size, polished, black, the elytra each with an elongate nubilously rufescent spot in about apical half near the suture; legs and antennae black or piceous-black; head about three-fourths as wide as the prothorax, very finely, sparsely punctate, the antennae one-half longer than the head, somewhat strongly incrassate distally, the second joint long, very much longer than the third; prothorax a third to two-fifths wider than long, the sides rather strongly converging from base to apex and distinctly to feebly arcuate, the punctures very sparse, nearly as in *verna* but very fine or almost obsolete; elytra somewhat shorter than in *verna*, at the sides scarcely longer than the sides of the prothorax, the suture very distinctly shorter than the median line, the punctures fine but distinct, even, not very close-set; abdomen nearly as wide as the elytra, subparallel, finely, rather sparsely punctate, the punctures of the impressions not differing from the others and fully as sparse; impression of the third tergite almost completely obsolete; basal joint of the hind tarsi very short, one-half longer than the second and barely three-fourths as long as the fifth. Length 1.4-2.25 mm.; width 0.55-0.63 mm. California (San Francisco to Pomona) and Iowa..... **minuta** n. sp.

23 — Form moderately stout, parallel, polished, deep black, the abdomen not paler at tip, the elytra pale rufous, feebly clouded with blackish on the flanks and toward the scutellum; legs piceous-black, the antennae black throughout; head nearly three-fifths as wide as the prothorax, remotely and obsoletely punctate, the antennae somewhat longer than

the head and prothorax, gradually and moderately incrassate from the base of the fourth joint, the latter fully as long as wide and as long as the fifth, the tenth not twice as wide as long, the eleventh unusually elongate, almost equaling the three preceding combined, the second and third moderately elongate, subequal; prothorax as wide as the elytra, wider than the base of the latter, somewhat more than one-half wider than long, strongly convex, distinctly narrowed from base to apex with the sides broadly and evenly arcuate, the punctures toward the sides very fine, remotely scattered, the two median impressions subobsolete, feebly punctured and only traceable toward base; elytra at the sides evidently longer than the sides of the prothorax, the suture four-fifths as long as the median line, the punctures moderately fine, very strongly asperate and close-set throughout; abdomen as wide as the elytra, but slightly tapering, finely but strongly, asperately and rather closely punctate, the punctures of the impressions larger and more circular than the others; hind tarsi as long as the tibiae, the basal joint somewhat longer than the next two together, two to four decreasing in length; mesosternal process narrowly subtruncate. Length 4.0 mm.; width 0.95 mm. Colorado (Breckenridge). — H. F. Wickham.

suffusa n. sp.

Form rather slender, polished, black, the elytra very dark rufo-piceous, almost imperceptibly shaded with black at the sides and broadly toward the scutellum; legs and antennae black or piceous-black; head nearly two-thirds as wide as the prothorax, scarcely at all punctate, convex, the antennae much smaller than in *suffusa*, two-thirds longer than the head, feebly incrassate, the second joint longer than the third; prothorax two-fifths wider than long, strongly narrowed from base to apex, the sides evenly and only slightly arcuate, the punctures extremely remote and subobsolete laterally, the two median impressed lines feebly punctate and obsolescent; elytra at the sides but little longer than the sides of the prothorax, the suture four-fifths as long as the median line, the punctures moderate in size, asperate and somewhat close-set; abdomen not quite as wide as the elytra, subparallel, the punctures sparse, rather closer toward base, elongate, parallel and acuminate in form except in the impressions; basal joint of the hind tarsi as long as the next two combined, two to four rapidly decreasing in length; mesosternal process unusually narrow, gradually narrowed almost to a point at tip, the latter however very narrowly truncate, the carina entire as usual. Length 3.5 mm.; width 0.82 mm. Colorado (Leadville).

acuminata n. sp.

The species above described may be assigned to six well defined groups, the first of which (1) includes all those from *castaneipennis* to *defecta*, together with the European *cuniculorum* Kr., according to the identification of Mr. Fauvel, and is characterized by a narrow mesosternal process, very fine and more or less incomplete carina and generally fine and sparse abdominal punctures, those of the impressions

being extremely minute in some cases. The second group (2), consisting of *affluens* alone, is characterized by a broader though still rather narrow, process, normal and entire carina and closer abdominal sculpture, with the close-set punctures of the impressions moderately coarse and the third group (3), composed of *sculptiventris*, is remarkably isolated by reason of the unusually coarse deep and subconfluent punctures of the abdominal impressions, the latter being deeper than in any other group and also because of the normally wide though rather abbreviated process with correspondingly longer metasternal process, normal carina and fine dense punctures throughout. The fourth group (4) consists of the three species from *imbricata* to *salicola*, and is distinguished by a peculiar imbricate sculpture of the abdomen, almost similar to that of the European *bipunctata* Ol., where, however, the mesosternal process is much narrower and the basal joint of the hind tarsi normally elongate; the process is of unusual width and the basal joint of the hind tarsi very short in the American species. The species from *densiventris* to *obsolescens* constitute another group (5), characterized by the bi-impressed, sparsely and irregularly punctate pronotum and normally wide process, and, finally, *verna* and others of the table, the European *nitida* Grav., and *bilineata* Gyll., and a small, apparently undescribed Mexican species before me, constitute a special group (6), resembling the preceding in pronotal sculpture but differing in the narrow, though normally carinate, process, and generally finer sculpture of the abdominal impressions; the process is indeed as narrow as in the first group, but, except in *acuminata*, with less converging sides. The last two groups are the only ones containing species of very wide geographic distribution, all the others being confined to special faunal regions. A very small species in my cabinet, taken near the city of Mexico, constitutes still another distinct group, having the fine abbreviated carina and narrow process of the first group above defined, with the medially biseriate and otherwise sparsely and unevenly punctate pronotum of the fifth and sixth groups, this being an additional reason why the biseriate impressed pronotum of the last

two groups cannot be considered a generic character in any sense.* The species are readily distinguishable among themselves, as a rule, by structural peculiarities relating to the intermesocoxal parts, sculpture, antennal characters, length of the basal joint of the hind tarsi and other easily observed features.

Verna has been inscribed in our lists under the name *nitida* Grav., but is by no means identical, having longer and more closely punctured elytra and more finely and closely sculptured abdomen; it is given in the European catalogue as a species different from *nitida*, but I have seen no European representatives. It varies noticeably, not only in size but to some extent in development of the elytra and density of sculpture, as might be inferred from its very extended range, although *bimaculata*, which is even more widely distributed, is notably less plastic. The southern California *innocua* closely approaches *bimaculata* Grav., in general structure, but is rather less stout, having also obviously shorter and paler elytra and a smaller, more parallel prothorax. The male of *obsolescens* possesses one character which, as far as known to me, is unique in the subtribe, the sixth ventral plate having at tip a small, abruptly incised and acutely angulate cleft,

* This species may be described as follows:—

Form moderately stout, parallel, convex, shining, deep black, the elytra scarcely visibly picescent, not definitely maculate, the legs and antennae black; head fully three-fifths as wide as the prothorax, finely, remotely punctate, the antennae barely one-half longer than the head, strongly incrassate and compact distally, the second joint much longer than the third and almost as long as the next two combined; prothorax nearly one-half wider than long, slightly narrower from base to apex, with the sides evenly and strongly arcuate, the base arcuate, the angles obtusely rounded, the punctures very sparse, disposed as in *verna* throughout; elytra scarcely at all wider than the prothorax and about as long, the suture not quite as long as the median line, the punctures and pubescence as in *verna*; abdomen parallel, nearly as wide as the elytra, finely, rather sparsely punctured throughout, the punctures of the impressions not larger; mesosternal process narrow, the carina very much abbreviated, not extending quite to the middle of the acetabula; hind tarsi as long as the tibiae, the basal joint fully as long as the fifth and as long as the next two together. Length 2.7 mm.; width 0.83 mm. Mexico (Federal District).—*composita* n. sp.

twice as deep as wide and about a fourth as long as the segment. The species *languida* Grav., and *cognata* Mäkl., are unknown to me at present.

Eucharina n. gen.

This genus, though having a type of pronotal sculpture not unusual in *Baryodma*, differs profoundly in the very coarsely spinose anterior and middle tibiae, the former, especially, being much shorter, more dilated and somewhat arcuate, in its more abbreviated mesosternal and longer, more narrowly angulate metasternal process and very small antennae, with unusual relative development of the second joint. It also differs in its extremely coarse sculpture and in having the first four tergites impressed at base, gradually less strongly, instead of three as in *Baryodma*. The hind tarsi are longer than in that genus, about equal in length to the tibiae, the latter being normally and very sparsely setose and wholly devoid of the very coarse spinules of the other two pairs. The species are only moderately numerous and are confined wholly to the sea-beaches of the Pacific coast from Alaska to Lower California. The five indicated by material before me may be distinguished among themselves as follows:—

- Elytra at the sides distinctly longer than the sides of the prothorax; elytral sculpture denser..... 2
- Elytra at the sides not longer than the sides of the prothorax; species southern in range; pubescence coarse but sparse and inconspicuous. 4
- 2 — Form very stout, parallel, the prothorax distinctly transverse. Body deep black throughout, the legs and antennae piceous, polished; head one-half to three-fifths as wide as the prothorax, with a few very coarse, unevenly and remotely scattered punctures, the antennae only about a third longer than the head, gradually and moderately incrassate to the tip, the subapical joints transverse, the eleventh barely as long as the two preceding combined, conoidal, the second joint as long as the next two together; prothorax large, one-half wider than long, the sides distinctly converging from base to apex and only moderately arcuate; sulci deep and strongly, irregularly punctured as usual, the surface elsewhere having very few coarse punctures, aggregated especially toward the sides near the middle, with a few at lateral fourth near the base and also minutely, rather closely punctulate throughout; elytra at the sides much longer than the sides of the prothorax, the suture three-fourths as long as the median line, the punctures very coarsely rugose

and close-set, the upper part of the flanks broadly impunctate except at the middle; abdomen subequal in width to the elytra, parallel, somewhat finely and closely punctured, more coarsely in the impressions, a rather wide median line on segments two to five impunctate except at base; vestiture throughout coarse but sparse and not very conspicuous. Length 5.0 mm.; width 1.35 mm. California (Monterey Bay).

tibialis n. sp.

Form only moderately stout, parallel, the prothorax but slightly wider than long; integuments shining, the pronotum with minute and indistinct punctulation as usual. 3

- 3 — Body black, the legs and antennae dark piceo-rufous, the elytra very faintly picescent; head rather smaller than in the preceding, barely half as wide as the prothorax, having similar very coarse punctures aggregated in a transverse, medially interrupted line near the base, with one or two at each side of the middle anteriorly, the antennae nearly similar; prothorax barely a fourth wider than long, the sides distinctly converging from base to apex but only very feebly arcuate, the punctures coarse and closely aggregated in the deep narrow sulci, the surface generally also having a sparsely placed series near the side margins, two or three in the middle at lateral fifth and a cluster of three or four at lateral fourth near the base; elytra at the sides only slightly, though distinctly, longer than the sides of the prothorax, the suture three-fourths as long as the median line, the punctures very coarse and close-set, rugose as usual, the upper part of the flanks with a small impunctate spot posteriorly; abdomen punctured nearly as in *tibialis*, the median smooth line generally less wide and frequently feebly defined; pubescence throughout coarse but sparse, rather pale but not very conspicuous. Length 3.0-4.6 mm.; width 0.8-1.0 mm. California (San Francisco) to Alaska. [= *Aleochara sulc.*, Mann.].

sulcicollis Mann.

Body deep black throughout, the elytra not paler, the legs rufo-piceous; head nearly as in *sulcicollis*, barely half as wide as the prothorax, the latter more rounded at the sides and even less transverse, about a fifth wider than long, the sides only slightly converging from base to apex and conspicuously arcuate, the punctures similar but more numerous and more confused toward the sides; elytra well developed, barely a third wider than long, the sides distinctly longer than the sides of the prothorax, the suture fully four-fifths as long as the median line, the punctures coarse, very dense, rugose, the upper part of the flanks impunctate in apical half; abdomen not quite as wide as the elytra, parallel, rather finely but strongly and very closely punctured, nearly as in the preceding species but more closely and with a very narrow, abruptly defined median impunctate line; pubescence very coarse, unusually long, moderately close, fulvous and conspicuous. Length 4.0-4.4 mm.; width 0.95 mm. Queen Charlotte Island (Massett.),— J. H. Keen.

rugosa n. sp.

- 4 — Moderately stout, convex, shining, deep black, the elytra not paler, the legs and antennae pale brownish-red; head well developed, fully as long as wide, rather more than half as wide as the prothorax, the latter, as well as the head, punctured nearly as in *sulcicollis* but with the very

minute punctulation finer and sparser; antennae slender, only very slightly and gradually incrassate distally, barely one-half longer than the head, the second joint as long as the next two together, the tenth three-fourths wider than long, the eleventh as long as the preceding two combined, very obtusely pyriform, truncate at tip; prothorax unusually elongate, only just visibly wider than long, fully as wide as the elytra, the sides moderately converging from base to apex and feebly arcuate; basal angles broadly rounded as usual, the median lobe of the base strongly rounded; elytra short, the sides much shorter than the sides of the prothorax, the suture two-thirds as long as the median line, the punctures very coarse and asperate but much less close-set than in *sulcicollis*, the flanks impunctate, narrowly at base, very broadly and almost to the lower edge behind, with a few punctures just behind the humeri; discal punctures externally tending to form oblique series; abdomen slightly narrower than the elytra, parallel, finely, rather closely punctate, somewhat broadly impunctate along the middle; hind tarsi fully as long as the tibiae, the basal joint almost as long as the next three combined. Length 4.5 mm.; width 1.05 mm. California (San Diego).

***debilicornis* n. sp.**

Moderately slender and much smaller, convex, parallel, polished, black, the elytra dark piceo-rufous throughout, the legs and antennae pale brownish red; head relatively large, three-fifths as wide as the prothorax or more, with a few large scattered punctures, the antennae nearly as in the preceding but somewhat more rapidly incrassate distally, the second joint scarcely as long as the next two combined, the tenth twice as wide as long, the eleventh more pointed; prothorax fully as wide as the elytra, scarcely a fifth wider than long, the sides only slightly converging from base to apex and distinctly arcuate, punctured nearly as in the other species, except that the punctures near the base, just outside of the sulci, tend to form a short transverse series, the minute punctulation very fine, sparse and indistinct; elytra rather short, moderately transverse, the sides equal in length to those of the prothorax, the suture fully two-thirds as long as the median line, the punctures very coarse and asperate but less close-set than in *sulcicollis* and tending to form oblique series throughout, the upper part of the flanks impunctate except before the middle, very broadly so behind; hind tarsi even somewhat longer than the tibiae but with the basal joint only as long as the next two combined. Length 2.7–2.9 mm.; width 0.65 mm. California (San Diego).....***cylindrella* n. sp.**

The tendency of the coarse elytral punctures to range themselves into oblique series in *cylindrella* and partially so in *debilicornis*, is a rather singular character; this tendency is not so obvious in the first three species of the table, and, where observable at all, the series are less oblique; the large impunctate areas at the sides of the elytra are also a distinguishing feature as in many Xantholinids.

Maseochara Shp.

At this point we arrive at a series of genera, sharply distinguished from those which precede by having the hypomera feebly inflexed, in such manner as to be visible in part from a lateral point of view in a strictly horizontal plane. There is nearly as much divergence in general structure among the various genera of this series as in the preceding section of the subtribe, but it may be noted that the mesosternal process is shorter as a rule and there are numerous instances where the tip of this process fails to attain the metasternum, sometimes by a long distance,—a character never observable in that group of genera. The genus *Maseochara* is an exception, however, in this respect, as well as in the very widely separated coxae, the mesosternal process attaining or even slightly overlapping the broad apex of the metasternum. The species are generally of large size, comprising in fact the largest of the subtribe and have remarkably opaque integuments, due to a minute reticuliform granulation, the true punctures of the head and pronotum, where this fine sculpture is especially evident, being feeble, sparse and ill defined as a rule. The pubescence is coarse, sparse, generally moderate in length and more or less inconspicuous. The sixth tergite of the male is armed throughout the width of its truncate apex with six long porrect and spiculiform teeth, the three on each side being somewhat curved toward the axial line. These appendages are homologous with the much finer and closer dentiform pectination characterizing the first division of *Aleochara*, as heretofore noted, but are more plastic or variable and can seldom be employed in the definition of species. The seven species in my cabinet may be described as follows:—

- Large species, never materially less than 7 mm. in length.....2
 Small species never notably exceeding 5 mm. in length.....6
 2— Elytra black.....3
 Elytra dull rufous in color; prothorax transverse.....5
 3— Prothorax almost as long as wide. Body black throughout, the legs
 and tarsi throughout and the antennae, gradually toward base, piceous-
 black; head and pronotum opaque, the former rather distinctly, the

latter extremely finely, rather closely but indistinctly punctate throughout, the elytra more shining, finely but distinctly, subasperately, evenly and closely punctured, the abdomen strongly shining, finely, somewhat closely punctured, becoming gradually very sparsely so posteriorly; head orbicular, three-fourths as wide as the prothorax, the antennae stout, only feebly incrassate distally, the second joint distinctly shorter than the third, the tenth about a third wider than long, the eleventh rather narrower than the tenth, somewhat shorter than the two preceding; combined and feebly pyriform; prothorax very slightly wider than long, the apex but little narrower than the base, the sides evenly and rather strongly arcuate, the basal angles obtuse but distinct; elytra very short and transverse, the sides very much shorter than the sides of the prothorax, the suture barely three-fifths as long as the median line; abdomen not quite as wide as the elytra, parallel, arcuately narrowed toward tip, the latter not at all paler in color; hind tarsi shorter than the tibiae, the basal joint less than one-half longer than the second, three-fourths as long as the fifth, two to four equal in length. *Male* with the ventral spines short and slender, the two sets of three separated by an unusually wide interval, this being equal to the width of either set. Length 7.0 mm.; width 1.7 mm. Arizona (Benson).

decipiens n. sp.

Prothorax transverse, strongly and continuously rounded at the sides and base, the angles subobsolete, black, the abdomen rufous at tip, the two sets of male abdominal spinules separated by a much narrower interval than in the preceding.....4

4 — Mesosternal process very broad, its apex broadly, almost evenly arcuate and received in a broadly arcuate impression in the usually still broader tip of the metasternum. Body very stout; elytra, legs and antennae deep black; head rounded, three-fifths as wide as the prothorax, feebly, sparsely punctate and opaque; antennae as long as the two together, very stout, the second joint much shorter than the third, the tenth fully one-half wider than long; prothorax two-fifths wider than long, opaque, with very fine and rather sparse, indistinct punctures and short, suberect, blackish hairs; elytra well developed, at the sides as long as the sides of the prothorax, the suture three-fourths as long as the median line, the punctures very fine, only moderately close-set, shallow and indistinct; abdomen at base as wide as the elytra, the segments finely punctured but only in apical half, rather closely on the basal, sparsely on the apical, tergites; hind tarsi stout, scarcely two-thirds as long as the tibiae, the basal joint about a third longer than the second and but little more than half as long as the fifth. Length 9.0-11.0 mm.; width 2.3-2.8 mm. California (near Los Angeles).

valida Lec.

Mesosternal process less broad, with its sides more rapidly converging, as a rule, the tip narrower and less rounded though variably so. Body less stout, the antennae and legs slightly piceous; head orbicular, two-thirds as wide as the prothorax, feebly, sparsely punctate, impunctate toward the middle anteriorly as in *valida*, opaque; antennae less stout, barely as long as the head and prothorax, the second joint much shorter than the third, the tenth distinctly less than one-half wider than long,

- the eleventh more elongate than in the preceding species; prothorax opaque, less transverse, one-third wider than long, the punctures fine, feeble and rather more close-set than in *valida*; elytra nearly similar in form but more shining, the punctures fine but stronger and very distinct, moderately close-set; sides scarcely as long as those of the prothorax, the suture two-thirds as long as the median line; abdomen polished, as wide as the elytra, finely, sparsely punctured in apical half of the tergites; hind tarsi about three-fourths as long as the tibiae, the basal joint about one-half longer than the second and three-fourths as long as the fifth. Length 7.8-9.5 mm.; width 1.75-2.2 mm. California (Los Angeles and San Diego).....**californica** Csy.
- 5 — Body large and very stout, subparallel, black, the elytra pale but dull rufous, blackish at the basal margin; abdomen piceo-rufous at tip, the legs dark piceous, the antennae piceous-black throughout; head opaque, strongly but rather sparsely punctured except along the middle as usual, two-thirds as wide as the prothorax; antennae very stout, rather strongly incrassate distally, not quite as long as the head and prothorax, the second joint much shorter than the third, the tenth fully two-thirds wider than long, the eleventh comparatively small, pyriform; prothorax opaque, finely but strongly, moderately closely punctured, two-fifths wider than long; elytra less opaque, distinctly broader than the prothorax, the sides as long as the sides of the latter, the suture two-thirds as long as the median line, the punctures fine but distinct, moderately close-set; abdomen nearly as wide as the elytra, parallel, finely, rather sparsely punctured in about apical half of all the tergites; mesosternal process very wide, arcuate at tip, nearly as in *valida*; hind tarsi two-thirds as long as the tibiae, the basal joint fully one-half longer than the second and four-fifths as long as the fifth. Length 8.0-11.0 mm.; width 1.9-2.8 mm. Arizona.....**ponderosa** n. sp.
- Body smaller and more slender; coloration as in *ponderosa* but with the tip of the abdomen bright and pale rufous; head and pronotum opaque, finely but very distinctly punctate, the former well developed, orbicular as usual, nearly three-fourths as wide as the prothorax, the antennae nearly as in *ponderosa*, the prothorax nearly similar but with the punctures more close-set; elytra alutaceous, black toward the scutellum, at the sides not quite as long as the sides of the prothorax, the suture barely two-thirds as long as the median line, the punctures fine, rather feeble and moderately sparse; abdomen punctured nearly as in *ponderosa*; mesosternal process less broad and more truncate at tip, the apex of the metasternal process much broader than the tip of the mesosternal and broadly emarginate in circular arc as usual; hind tarsi nearly as in *ponderosa*. Length 7.0 mm.; width 1.65 mm. Arizona (Benson), — G. W. Dunn.....**ruficauda** n. sp.
- 6 — Body somewhat slender, black, the elytra obscure rufous, generally blackish at the sides and base; legs rather pale, the antennae darker, brownish-rufous; integuments opaque, the elytra less so and the abdomen shining; vestiture longer and more abundant than in any of the preceding species; head orbicular, much narrowed at base, the basal parts not more shining except toward the sides; antennae about as long as the head and prothorax, rather strongly incrassate distally but

unusually slender toward base, the second and third joints equal; punctures fine and obscure; prothorax equally finely but rather closely punctate, scarcely one-half wider than the head, about a fourth wider than long, the sides subparallel, evenly and distinctly arcuate, the base arcuate, the angles very obtuse but distinct; elytra obviously wider than the prothorax, the sides distinctly longer than those of the latter, the suture four-fifths as long as the median line, the punctures very fine but close-set; abdomen about as wide as the elytra, finely and moderately closely punctured almost to the bases of the tergites; mesosternal process narrower than in *valida* and allies, truncate or feebly sinuate at tip, abutting against the truncate and unemarginate apex of the metasternum; hind tarsi fully three-fourths as long as the tibiae, the basal joint one-half longer than the second. Length 3.8–5.0 mm.; width 0.78–1.2 mm. Arizona (Benson) and California.....**puberula** Csy.

Body just visibly stouter and less parallel, black, the elytra and antennae dark piceous, the latter toward base and the legs paler, testaceous; pubescence rather shorter, finer and less conspicuous; head not orbicular and much narrower, only slightly narrowed from the eyes to the base, with the sides scarcely at all arcuate, the surface opaque except broadly along the base, where it becomes abruptly shining and with dense asperate punctures except at the sides; antennae nearly similar, strongly incrassate distally but with the second joint not quite as long as the third, although subequal; prothorax rather small, about a fifth wider than long, the sides parallel, evenly and more strongly arcuate, the angles obtuse but distinct, the punctures very fine, rather close-set, but indistinct, the surface opaque; elytra less opaque, finely but strongly, closely punctured, much wider than the prothorax, the sides equal in length to the sides of the latter, the suture four-fifths as long as the median line; abdomen polished, broader than in *puberula*, as wide as the elytra, very finely, rather sparsely punctured almost throughout, the punctures becoming close-set toward base; hind tarsi fully three-fourths as long as the tibiae, the basal joint a little less than one-half longer than the second and about two-thirds as long as the fifth. Length 3.8 mm.; width 0.92 mm. California (Arrowhead)**basalis** n. sp.

The species above described range themselves into three rather well defined groups, the first and last of which are closely allied, though separated in the table by the second for convenience in identification. The first group consists of *decipiens* alone, having moderately broad meso- and metasternal processes, coming together on a straight transverse line, heavy antennae like those of the second group and having a similarly short second joint, distinct basal angles of the prothorax and abdomen punctured almost throughout. The second group includes the species from *valida* to *rufi-*

cauda, they being of stouter build, large size as a rule, with very broad meso- and metasternal processes, the former generally rounded at tip and the latter broadly and circularly emarginate and frequently wider than the mesosternal, very stout antennae, which however are not very strongly incrassate, and with the second joint much shorter than the third, broadly rounded sides and base of the prothorax, with subobsolete basal angles and with the abdomen only punctured in apical half of the dorsal plates. The third consists of much smaller species, resembling the first group in the intermesocoxal parts, abdominal punctures and parallel prothorax with distinct basal angles, but the antennae are much more slender basally and more strongly incrassate distally, with the second and third joints equal or nearly so. *Semi-velutina* Solsky, does not occur within our borders but belongs to the fauna of the warmer parts of Mexico, the head, prothorax and elytra are all red. *Ponderosa* of the table was formerly labeled *valida* in some cabinets but is not the same as the species of LeConte, which has black elytra. I formerly regarded *californica* as identical with *valida*, but more ample series of specimens show that it is a smaller and notably less stout species. *Decipiens* is closely allied to *opacella* Shp., but is probably not the same, differing in its smaller size and stouter antennae. The type specimen of *basalis* has a remarkable deformity on the surface of the pronotum, consisting of a very large, strongly and obliquely elevated protuberance in the form of a volcanic cone, having an elliptical crater at the summit.

If this genus is ever subdivided, the name *Maseochara* may be applied to species of the *opacella* type and *Tithanis* to those of the *valida* type. Mr. Fauvel has recently assigned some East Indian species to *Maseochara*, but in all probability they are not really congeneric.

Emplenota Csy.

As the name *Polystoma*, employed by Stephens for this genus, is a preoccupied name, and, since the word "*Poli-*

stoma," suggested by me some time ago (Annals N. Y. Acad. Sci., VII, p. 289) seems to be a mere printer's error, it becomes necessary to use the name above given, which was published in 1885 (Cont. Descr. and Syst. Col., II, p. 123). In this genus the body becomes more depressed in form than in any of our other types of Aleocharae except *Pinalochara*, and the integuments are duller because of minute reticulation and granulation, than in any except *Maseochara*, and, even there, the abdomen is polished and not minutely reticulate as it is here. The pubescence also becomes rather conspicuous, pale, close and erect though never very long. In *Emplenota* and all others of the following genera of this subtribe, the prothorax differs greatly from that of *Rheochara* in being relatively smaller as a rule and parallel or nearly so at the sides. The mesosternal process is not materially wider than in *Rheochara* but is more abbreviated, extending usually to about apical third of the acetabula, and is subacute to narrowly truncate at tip; the metasternal projection is correspondingly longer, though separated from the tip of the mesosternal by the same depressed discontinuity of surface, which is only slightly variable in longitudinal extent within the limits of the genus. The species, like those of *Eucharina*, appear to be confined to the ocean beaches, those of our fauna being characterized as follows:—

Species of the Atlantic coast. Body unusually slender, finely graulato-reticulate and dull, the abdomen feebly reticulate and polished, the pubescence stiff, fulvous and distinct, black, the elytra more or less rufo-piceous, the legs and antennae blackish, the tarsi slightly paler; head nearly four-fifths as wide as the prothorax, parallel, slightly inflated and arcuate at the sides behind the moderate eyes, rather abruptly narrowed at base, strongly, somewhat closely punctured, impunctate along the median line, the antennae shorter and more slender than usual, rather feebly incrassate distally, about one-half longer than the head; prothorax small, scarcely a fifth wider than long, the sides arcuate, rather more strongly convergent and straighter toward base than apex, the latter fully as wide as the rounded base; angles very obtuse, the punctures rather impressed, coarse and distinct, moderately close; surface flattened toward the middle; elytra well developed, only slightly transverse, the sides very much longer than the sides of the prothorax, the suture as long as the median line, the disk much wider; punctures moderately fine, rather strongly impressed and close-set;

abdomen narrower than the elytra, parallel and straight at the sides throughout, finely, sparsely punctured, the basal parts of the tergites impunctate; mesosternal process acute, with a longer sloping posterior margin than in any other species, the apparent distance between the two apices being therefore greater. Length 3.0-4.0 mm.; width 0.75-0.8 mm. New York to Virginia (Norfolk). *maritima* Csy.

Species of the Pacific Coast. 2

2 — Antennae stout and strongly incrassate, the ante-apical joints strongly obtrapezoidal, short and very strongly transverse, the second and third joints moderately elongate, subequal in length, the former somewhat the shorter; basal joint of the hind tarsi as long as the third and fourth combined. Body stout, parallel, opaque, the elytra less so, the abdomen shining, black, the entire elytra dark rufo-piceous; legs red-brown, the antennae infuscate; vestiture short and inconspicuous, rather sparse; head large, subquadrate, wider than long, three-fourths as wide as the prothorax; finely, somewhat sparsely punctate, the median line impunctate as usual; antennae slightly shorter than the head and prothorax, the latter large, more transverse, a third wider than long, parallel and evenly, rather strongly rounded at the sides, the base almost continuously and strongly arcuate, the angles very obtuse and barely visible; punctures fine, not very distinct, well separated and evenly distributed throughout; elytra distinctly wider and somewhat longer than the prothorax, the sides evidently longer than those of the latter, the suture scarcely as long as the median line, the punctures fine, moderately close-set and rather distinct; abdomen nearly as wide as the elytra, parallel, finely, sparsely punctate, the punctures very remote toward apex, the impressions impunctate as usual; mesosternal process acute, the space between the two apices unusually deeply excavated. Length 3.5 mm.; width 1.0 mm. California (Sta. Barbara and La Jolla).

pacifica Csy.

Antennae less strongly incrassate distally, the outer joints less narrowed from apex to base and less strongly transverse, the second joint always longer than the third; basal joint of the hind tarsi still shorter, but little longer than the second. 3

3 — Second antennal joint only very slightly longer than the third. Form only moderately stout, parallel, dull in lustre, the abdomen polished, the vestiture moderate in length and abundance though distinct, black, the elytra very dull rufo-piceous, black at the sides, the legs pale red-brown, the antennae nearly black; head relatively large, four-fifths as wide as the prothorax, finely, strongly punctured except along the middle, the antennae about as long as the head and prothorax, the latter a fifth wider than long, parallel, with evenly and moderately arcuate sides and rounded base, the punctures fine but distinct and rather close, the surface somewhat flattened toward the middle, with two feebly tumescent smoother spots at the basal margin and separated by half the width; elytra but slightly transverse, much wider and evidently longer than the prothorax, the suture as long as the median line, the punctures rather fine but strong, somewhat close-set; abdomen narrower than the elytra, parallel throughout, the punctures fine and sparse, wanting at the bases of the tergites; mesosternal process acuminate, the

- tip extremely narrowly rounded. Length 3.5-4.0 mm.; width 0.8-0.85 mm. California (San Diego).....**arenaria** Csy.
- Second antennal joint much longer than the third; elytra bright testaceous except broadly along the sides and base; vestiture fulvous, rather abundant and conspicuous.....4
- 4 — Form very broad, parallel, dull as usual, the abdomen shining, black, the legs piceous, the antennae black, scarcely paler toward base; head relatively smaller than in *arenaria*, somewhat wider than long, two-thirds as wide as the prothorax, finely, rather feebly and not closely punctate, with the parallel median line impunctate; antennae nearly as long as the head and prothorax, stout throughout, though only moderately incrassate distally; prothorax about a fourth wider than long, parallel and rounded at the sides, the base broadly arcuate, the punctures fine and rather close, the surface subeven, convex, with the two widely separated basal tumidities feeble; elytra large, distinctly longer and wider than the prothorax, slightly transverse, the suture as long as the median line, the surface flat, finely but distinctly, unusually closely punctured; abdomen broad, nearly as wide as the elytra, parallel, punctured finely and sparsely except at the bases of the tergites as usual; mesosternal process narrow, short, becoming parallel toward tip, the latter arcuato-truncate. Length 3.6 mm.; width 1.1 mm. California (Redondo),— H. C. Fall**quadrifer** n. sp.
- Form narrow, parallel, depressed as usual, dull, the abdomen moderately shining, black, the legs piceous, the antennae black, slightly picescent toward base; head nearly as long as wide, three-fourths as wide as the prothorax, finely, feebly punctured in the usual way, the antennae moderately stout and incrassate distally; prothorax smaller, parallel, about a fifth wider than long, the sides and base rounded, the punctures feebly impressed, somewhat close-set, the basal tumid spots distinct; elytra very much wider and longer than the prothorax, the suture slightly longer than the median line, the punctures rather fine but somewhat less close-set than in *quadrifer*; abdomen evidently narrower than the elytra, parallel, finely, rather sparsely punctured as usual; mesosternal process short, still somewhat broader than in *quadrifer* and more gradually narrowed to the arcuato-truncate apex. Length 3.6 mm.; width 0.78 mm. California (Alameda).....**trilimbata** n. sp.

The European *algarum*, of Fauvel, belongs to this genus, although the mesosternal process is evidently longer than in any of the American species and still somewhat wider than in *trilimbata*, gradually becoming parallel toward the abruptly arcuato-truncate apex near apical fourth of the acetabula; the second antennal joint is longer than the third and the basal joint of the hind tarsi very short as usual, and there is the usual depressed discontinuity between the tips of the meso- and metasternal processes. The species described by

Kraatz as *Polystoma grisea* will, however, have to be placed in another genus as previously defined, the body being more convex, the basal joint of the hind tarsi long and the mesosternal process much longer, attaining the tip of the metasternum and closing the gap so characteristic of *Rheochara*, *Emplenota* and many other genera of this section of the Aleocharae. It is probable that other species of this genus will be found on our Florida and Gulf coasts, but I have seen none as yet.

Echochara n. gen.

This is an isolated type, necessitating a special generic title, as suggested above, for a species originally described by the writer under the provisional name *Rheochara lucifuga* (Annals N. Y. Acad. Sci., VII, p. 288). The middle coxae are subcontiguous, the very finely acuminate mesosternal process being more or less bilaterally compressed and it differs from *Rheochara* in addition, by the long, acutely angulate metasternal process projecting anteriorly between the coxae. The tarsi are of nearly the same type as those of *Rheobioma* and *Rheocharella*, but are stouter, more decidedly shorter than the tibiae, with the basal joint somewhat longer than the fifth, though only intermediate in length between the next two and three together. The abdomen differs greatly from either in having the first four tergites impressed at base, successively less strongly, the fourth feebly so, and even the fifth is noticeably and broadly concave, almost as strongly so as the fourth; these basal impressions differ from those of *Maseochara* and *Emplenota* in being strongly punctured. The antennae are of the usual type, with the fourth joint smaller than the fifth, and, as is sometimes the case, the outer sides of the penultimate joints are a trifle longer than the inner, causing the rectilinear apices to be feebly oblique. The eyes are smaller than usual, though still well developed, and are at a long distance from the base. The punctures of the head and pronotum are extremely minute and but little larger than the base of the hairs borne by them; each is surrounded by a minute incised ring; those

of the elytra are normal and transversely crescentiform. The integuments are finely, very obsoletely reticulate, except the abdomen, which is wholly devoid of minute ground sculpture. The type may be characterized as follows: —

Form elongate, slender and parallel, normally convex, subalutaceous, the abdomen shining, pale ferruginous throughout, the legs and antennae concolorous; head and abdominal dorsal plates piceous, pale toward apex, the sixth wholly pale; pubescence rather abundant, decumbent and distinct; head somewhat elongate, three-fifths as wide as the prothorax, widest near the base, the sides arcuate, the punctures sparse and indistinct, the antennae stout, somewhat longer than the head and prothorax, strongly incrassate distally, the outer joints transverse, the second and third elongate and equal; prothorax scarcely more than a fourth wider than long, subparallel, the sides evenly, rather strongly and the base feebly, arcuate, the apex narrower than the base, the basal angles obtuse and rounded, the punctures somewhat sparse and very indistinct; elytra scarcely visibly wider and somewhat shorter than the prothorax, the outer side equal in length to the side of the latter, the suture scarcely more than two-thirds as long as the median line, the punctures rather strong, asperulate and close-set; abdomen long, subparallel, slightly narrower than the elytra, finely punctulate, very sparsely toward tip, the punctures slightly coarser, rather close-set and distinct in the basal impressions; legs rather long, finely, closely setose. Length 4.5 mm.; width 0.8 mm. Kentucky (Lexington). [= *Rheochara luc.* Csy.].....*lucifuga* Csy.

There are some inaccuracies in the original description which are here corrected: the abdomen, for example, has no subapical cloud, though the apical pale margin of the fourth tergite is somewhat narrower than that of the basal segments, and the punctures of the basal depressions are coarser than the others. The mesosternal process does not more than just attain the acute apex of the metasternum, but on a lower level — in the natural position of the body. This species is said to inhabit caves, but probably only incidentally.

Pinalochara n. gen.

In many structural features and in appearance this genus resembles both *Maseochara* and *Emplenota*, having a somewhat similar reticulate sculpture, the depressed form and short basal joint of the hind tarsi characterizing *Emplenota* and the feebly inflexed hypomera of *Maseochara*. It is

founded upon a single species which may be briefly described as follows:—

Body parallel, depressed, rather shining, black, the elytra bright red; legs pale, the antennae blackish, gradually testaceous basally; integuments coarsely and not strongly micro-reticulate, the elytra very feebly so, the abdomen finely and obsoletely transversely strigilato-reticulate; punctures fine and sparse but distinct, rather larger, more close-set and somewhat feebly impressed on the elytra, fine and somewhat sparse on the abdomen, except the basal region of all the tergites which is impunctate; pubescence short and inconspicuous but with many longer erect and bristling setae along the sides; head rather longer than wide, the sides behind the eyes evenly and strongly arcuate to the neck, slightly widest behind the eyes; antennae attaining the middle of the elytra, gradually, strongly incrassate distally, the subapical joints distinctly transverse, the eleventh obtusely pointed and almost as long as the preceding three combined; prothorax only very slightly wider than the head and about a fourth wider than long, the sides parallel and feebly arcuate; base broadly rounded; surface extremely finely and feebly impressed along the median line from apex nearly to the base; elytra transverse, rather distinctly wider than the prothorax but not quite as long, the suture four-fifths as long as the median line, the humeri scarcely exposed, the basal concavity infumate; abdomen parallel and straight at the sides, slightly narrower than the elytra. Length 3.5 mm.; width 0.81 mm. Arizona (Santa Rita Mts.),—H. F. Wickham.
wickhami n. sp.

The sixth tergite is truncate at tip in the unique type, with the edge even, and the sex of this specimen is not clearly determinable. The infra-lateral carina of the head in this genus is feebler than usual, becoming almost obsolete anteriorly.

Rheochara Rey.

This genus is very isolated, differing greatly from any other with feebly inflexed hypomera, in the dense sculpture of the abdomen and in the apically narrowed prothorax. The body in *Rheochara* is small in size, normally convex, with transverse subconical prothorax, very broad front between the antennae and moderately slender hind tarsi, having the basal joint as long as the next two combined. The punctures of the head and pronotum are evenly distributed, small but strongly annular in form, those of the elytra more impressed, coarser and transversely subasperate, while on

the abdomen, they are small but very close-set and rugose throughout, not differing materially in the concave depressions of the three basal tergites. We have as yet but a single species which may be described as follows:—

Moderately stout, convex, alutaceous, piceous-black, the elytra rufous, becoming nublously black about the scutellum and obliquely at each side. more broadly toward apex, each abdominal segment rufescent toward tip above and beneath; antennae fuscous, the basal parts and legs throughout pale testaceous; pubescence fine, subdecumbent, dense and rather conspicuous; head three-fifths as wide as the prothorax, finely, rather closely, the latter still more finely and very closely punctate; eyes unusually prominent; antennae as long as the head and prothorax, the basal joints slender, the second and third equal, fourth to the tip much stouter but increasing only very slightly outwardly, compact, the tenth nearly twice as wide as long, the eleventh well developed, longer than the two preceding combined and fully as wide, ogivally pointed; prothorax strongly transverse, compactly joined to the elytra, the base exactly as wide as the base of the latter but slightly narrower than the apical parts, the sides strongly converging from base to apex and evenly, moderately arcuate, the surface very evenly convex; elytra well developed, fully one-half wider than long, the sides much longer than those of the prothorax, the suture fully as long as the median line, the punctures fine and dense; abdomen distinctly narrower than the elytra, parallel, arcuately narrowing posteriorly, finely, very closely and evenly punctured throughout; mesosternal process extending fully to apical fifth of the coxal cavities, the metasternal very short, broadly parabolic, between the posterior ends of the cavities some five times as wide as long; basal joint of the hind tarsi as long as the next two combined. Length 3.0 mm.; width 1.0 mm. Pennsylvania (Westmoreland Co.), — P. J. Schmitt. . . . *nebulosa* n. sp.

Some time ago one of my European correspondents sent me a specimen under the name *Aleochara lugubris*, which is placed in the catalogues as a synonym of *moerens* Gyll., under the subgeneric name *Baryodma*. On examining this specimen I found the hypomera to be feebly inflexed and in considerable part visible from the sides, and therefore conclude that it is not the species stated, but — the antennae being rather stout and compact — a representative of *Rheochara* and assume that it represents the unique type of that genus, named *spallicea* by Erichson. The present species, described above from the mountains of Pennsylvania, is exactly congeneric, but is stouter, less parallel and with finer, less densely crowded punctuation.

In the European species the abdomen is not narrowed toward tip but remains perfectly parallel from base to the very broad tip of the fifth tergite, and the mesosternal process is not only a little narrower but also somewhat shorter than in the American species, with the metasternal process somewhat longer and only very narrowly rounded, the cavity between the two apices being about equal in length in the two species.

Rheobioma n. gen.

This genus is allied to *Rheochara* in having the three basal tergites subequally impressed at base, though otherwise there is but little community of facies. The prothorax, instead of being very transverse and strongly narrowed from base to apex, closely applied to the elytra and densely sculptured, is here but feebly narrowed anteriorly, rather loosely articulated and finely and sparsely punctulate, but the abdomen, especially, differs in its fine remote punctulation and the antennae are much more elongate. The genus is wholly isolated in some features of the under surface, the tip of the long slender and parallel mesosternal process being separated from the metasternum by a much longer longitudinal discontinuity than in any other, and the metasternum does not enter at all between the acetabula, being merely broadly and feebly arcuate. The mesosternal carina, which also seems to be a peculiar feature, extends from the dilated anterior margin to a transverse line through anterior third or fourth of the acetabula but is not similar to the carina of *Baryodma* and allies, being irregular, broadly flattened and very feebly elevated. Another singular feature is the elongate fourth antennal joint, which is even somewhat longer than the fifth and distinctly longer than wide. The hind tarsi are extremely slender and evenly filiform throughout, though not quite as long as the tibiae, with the basal joint almost as long as the next three combined and somewhat longer than the fifth. The type may be described as follows:—

Moderately stout, subfusiform, convex, shining, pale piceous, the elytra throughout rather more rufous, the abdomen blackish; antennae some-

what infuscate, the basal joint and the legs throughout pale brownish-testaceous; pubescence rather long, abundant, fulvous and distinct; integuments finely, very obsoletely reticulate, the abdomen excessively minutely strigilate in transverse wavy lines but strongly shining; head three-fifths as wide as the prothorax, arcuately narrowed behind the moderately large but not prominent eyes, the punctures extremely minute, sparse and indistinct; antennae extending at least to basal third of the elytra, slender basally, gradually somewhat strongly incrassate distally, with the joints moderately transverse, closely joined and narrowed but little from their apices to their bases, the second and third much elongated and equal; prothorax not quite a third wider than long, convex, the sides very slightly though obviously converging from base to apex and evenly, moderately arcuate, the base broadly arcuate, the disk apparently somewhat flattened toward the middle posteriorly; punctures extremely minute, rather sparse and scarcely observable; elytra large, wider and much longer than the prothorax, the suture about a third longer than the median line, the punctures very fine and feeble, close-set; abdomen much narrower than the elytra, parallel toward base, gradually and arcuately narrowing in apical half, extremely minutely, feebly and remotely punctulate, the depressions almost wholly impunctate. Length 3.0 mm.; width 0.88 mm. California (Tehachepi Pass),—H. F. Wickham.....*disjuncta* n. sp.

The extremely minute close-set strigilation of the abdomen is a feature wholly wanting in *Rheochara fenyesi* Bernh., and in *Rheochara nebulosa*, there is, besides the close strong punctuation, only a feeble coarse reticulation visible toward the tip of the abdomen. The abdomen is also narrower, in proportion to the width of the elytra, than in any other genus of the subtribe known to me. This is in fact a widely isolated type.

Rheocharella n. gen.

In this genus the general habitus is nearly as in *Rheobioma* and the hind tarsi are similarly extremely slender and filiform though shorter than the tibiae, with the basal joint much longer than the last and as long as the next three combined, but there are so many points of divergence that no other course seems appropriate but the suggestion of generic separation. The very slender and acutely rounded process of the mesosternum extends to the rather strongly produced and narrowly rounded, though much broader metasternal projection, without trace of the long discontinuity characterizing *Rheo-*

bioma, and, besides this, the two differ radically in the form of the abdomen, there being only two basally impressed tergites here, instead of the three of that genus and *Rheochara*. The general surface of the abdomen is perfectly smooth and highly polished, without trace of minute ground sculpture of any kind. The single known species may be identified by the following characters:—

Moderately stout, convex, subparallel, strongly shining, piceous-black, the elytra pale rufo-testaceous, clouded with blackish at the sides in the vicinity of the apical angles; antennae blackish, the basal joint and legs throughout pale testaceous; vestiture fine, subdecumbent and somewhat inconspicuous; head nearly as long as wide, about three-fifths as wide as the prothorax, extremely minutely, sparsely punctulate; antennae fully as long as the head and prothorax, gradually and strongly incrassate distally, slender basally, the subapical joints about two-thirds wider than long, the second and third elongate and equal, the fourth normal, much shorter and narrower than the fifth; prothorax about a fifth wider than long, parallel, the sides broadly and evenly arcuate, the base similarly arcuate, the punctures very fine, rather sparse and indistinct; elytra somewhat transverse, evidently though not very greatly wider and longer than the prothorax, the suture equal in length to the median line, the punctures fine but distinct, rather close-set; abdomen at base almost as wide as the elytra, gradually narrowing in apical half, parallel toward base, the punctures very fine but distinct, evenly distributed throughout each tergite though becoming sparser in the two basal impressions, rather close-set toward the abdominal base but becoming excessively sparse toward tip. Length 2.8 mm.; width 0.8 mm. California (Pasadena).....*fenyesi* Bernh.

I owe a representative of this very interesting species to Dr. A. Fenyés, of Pasadena, in honor of whom it was recently named by Mr. Bernhauer, (D. Ent. Zeit., 1905, p. 249).

A number of European Aleocharae have been noted from time to time as occurring in America, besides *fuscipes* and *nitida* before mentioned; among these are *Xenochara puberula*, which has doubtless been confounded with our *bipartita*, *moerens* Gyll., and *morion* Grav., the last being a very isolated minute and peculiarly sculptured species with very broad mesosternal process. *Graciliformis* Fauv., of the Henshaw list of 1895, is unknown to me; it is probably a manuscript name.

Tribe MYRMEDONIINI.

The genera of this tribe here defined have a certain community of facies which is rather difficult to characterize rigorously, but resulting mainly from the fact that the head and prothorax are always narrower than the elytra, with the former strongly constricted at base and the sculpture of the abdomen more or less sparse, the first two or three tergites being deeply and conspicuously impressed at base. They are the genera that range themselves about *Gnypeta*, *Tachyusa* and *Falagria*. Possibly some European genera placed in proximity to these three genera in the catalogue of Heyden, Reitter and Weise, other than those defined in the accompanying tables, should be included, but it is certain that *Echidnoglossa*, placed next to *Falagria* in that work, should be excluded, as the tarsi are all 5-jointed and *Thinonoma* Thom., and *Brachyusa* Rey, which come after *Gnypeta*, are also to be excluded, they having scarcely any points of habitual resemblance. *Ischnopoda* and *Xenusa*, however, seem to be close allies of *Gnypeta* and are included in the following table. These genera form two independent subtribes of the Myrmedoniini as follows:—

Prosternum wholly membraneous under the coxae; neck only moderately narrow.....	Tachyusae
Prosternum corneous under the coxae, either wholly or partially; neck very slender.....	Falagriae

These subtribes both include numerous genera.

Subtribe **Tachyusae.**

In delimiting the genera of this subtribe considerable taxonomic value is attached to the form of the intermediate acetabula, whether sharply outlined throughout by a fine beaded edge — closed, — or having the beaded edge widely interrupted behind, the bottom of the cavity merging gradually through a continuous convex surface into the metasternum — open. Other characters which are held to be of

greater or less generic import relate to the degree of separation of the middle coxae and conformation of the intermesocoxal parts. The pronotum, although frequently broadly impressed along the middle, seldom has any very distinct trace of the longitudinal groove distinguishing most of the Falagriae. The genera represented in my cabinet may be briefly described as follows:—

- Middle acetabula complete and closed throughout by a fine beaded edge** 2
Middle acetabula broadly open behind.....5
 2 — Middle coxae well separated, the mesosternal process obtuse.....3
 Middle coxae approximate, the mesosternal process narrower, sometimes very acute, free.....4
 3 — Body slender; mesosternal process very short, broadly rounded at tip, extending only to anterior third of the acetabula and on exactly the same plane as the obtusely truncate tip of the long metasternal projection, from which it is separated by a very short broad isthmus; prosternum moderate before the coxae, not extending more than half way to the mesosternum, angularly tumid behind, the exposed part separated from the concealed inner edge by a fine beaded margin, the inner part somewhat produced posteriorly but very broadly rounded; head small, orbicular, the antennae long, the neck not quite one-half as wide; eyes rather small, not prominent; prothorax narrow, broadly impressed; elytra depressed, short, prominently elevated along the sides; abdomen broad, subimpunctate, the first three tergites narrowly and subequally impressed at base, the impressions sculptureless; legs and antennae long, the hind tarsi long and slender, filiform, the first joint fully as long as the next two combined. Pacific Coast of America...**Trachyota**
 Body stouter, nearly as in *Meronea*; mesosternal process very short and broad, transversely truncate at tip, not extending quite to anterior third of the acetabula and separated from the truncate apex of the long wide metasternal projection by a very short broad isthmus on the same plane as both the apices; middle coxae widely separated; prosternum unusually developed before the coxae, posteriorly and sharply angulate between the latter, the very finely aciculate apex extending to the mesosternum and finely carinate for a short distance from the tip; head well developed, arcuato-truncate at base, the eyes large and prominent; palpi slender, moderate in length, the antennae slender, rather long; neck unusually narrow, less than a third as wide as the head; prothorax wider than long, obtrapezoidal, strongly and almost evenly convex; elytra evenly convex, not angulate at tip externally; abdomen parallel, almost as in *Gnypeta*, the first three tergites rather strongly but narrowly and subequally impressed at base, the fourth and fifth also very feebly impressed near the basal margin; legs and tarsi very slender. Cuba and Central America.....***Neolara**
 Body usually rather stout but variable in form, the mesosternal process narrowly rounded, extending to about the middle of the acetabula, very slightly free and separated from the rounded tip of the metasternal

projection by a short and broad undepressed isthmus, which is however notably longer than in *Trachyota*; prosternum nearly as in that genus but much shorter before the coxae, the head larger and the eyes much more developed; antennae short or long; neck wide, two-thirds to four-fifths as wide as the head; prothorax generally transverse, usually more or less impressed in the middle posteriorly and with a short transverse impression before the scutellum; elytra not prominent along the sides; abdomen generally somewhat narrower than the elytra though always broader than in *Tachyusa*, with the three basal tergites deeply and subequally impressed at base; legs moderate, the hind tarsi short, with the basal joint generally much shorter than the next two combined. America and Europe.....**Gnypeta**

Body rather stout, nearly as in *Gnypeta* but clothed throughout, including the legs and tarsi, with extremely fine short pale and subdecumbent hairs, the basal angles of the prothorax not at all rounded; mesosternal process not extending quite to the middle of the coxae, strongly narrowed to the broad and arcuato-truncate tip, which attains, on a slightly different level, the apex of the very elongate broad metasternal projection; prosternum before the coxae short, with an obtusely rounded, short posterior projection; neck three-fourths as wide as the head, the eyes large and somewhat coarsely faceted; antennae very slender with the second joint much longer than the third; abdomen broad with the first three tergites feebly impressed at base; legs long and slender, the hind tarsi filiform, nearly as long as the tibiae, with the basal joint somewhat longer than the next two combined, two to four rapidly decreasing in length, the fifth very short, the claws slender, arcuate. Sonoran fauna.....**Teliusa**

4 — Form moderately stout, nearly as in *Gnypeta* throughout; mesosternal process extending to the middle of the acetabula and separated from the acutely rounded apex of the metasternal projection by a very narrow, rather long and distinctly depressed isthmus; prosternum short before the coxae; head moderate, with well developed and rather prominent eyes, long antennae and unusually elongate third joint of the maxillary palpi, the neck broad, fully three-fourths as wide as the head; prothorax, elytra and abdomen as in *Gnypeta*, the first three tergites broadly, strongly and subequally impressed at base; legs longer, the hind tarsi rather long, slender and filiform, with the basal joint subequal to the next two combined. Europe.....***Ischnopoda**

Form very slender, convex; mesosternal process extending rather beyond the middle of the acetabula and just attaining the acutely rounded tip of the narrow metasternal projection without intervening isthmus; prosternum short though rather strongly and posteriorly angulate before the coxae; head moderate, the antennae slender, the third palpal joint much longer than the second, the eyes well developed; neck about three-fifths as wide as the head; prothorax generally somewhat transverse, the elytra well developed, angulate externally at tip; abdomen very narrow, clavate, with the first three tergites very deeply impressed at base, the impressions coarsely sculptured and divided on the median line by a fine carina which joins the raised basal margin; legs long,

- slender, the hind tarsi moderate in length but slender, with the basal joint about as long as the next two combined; tarsal claws long, equal. Nearctic and Palaearctic regions.....**Tachyusa**
- 5 — Mesosternal process very finely pointed, free, long, extending rather beyond the middle of the acetabula and separated from the metasternal projection by a narrow unimpressed isthmus.....6
- Mesosternal process much more abbreviated and broader, not extending to the middle of the acetabula, free, separated from the metasternal projection by a short unimpressed isthmus, the middle coxae less approximate.....7
- Mesosternal process still shorter, the tip not at all free, broadly rounded or truncate and separated from the metasternal projection by a short but depressed isthmus, the coxae more or less widely separated.....8
- 6 — Body rather stout, the prosternum short but strongly and posteriorly angulate before the coxae; head large, truncate at base, the eyes small, the antennae much elongated, the third palpal joint but little longer than the second, both unusually elongated; neck rather narrow, about a third as wide as the head; prothorax obtrapezoidal, wider than long, broadly impressed along the middle, rather acutely but broadly impressed along the median line; elytra normal; abdomen broad, feebly punctured, the three basal tergites impressed at base, the first more broadly; legs moderately long, the basal joint of the hind tarsi longer than the next two combined; integuments finely, closely sculptured and dull. Europe.....***Xenusa**
- Body slender, parallel, very small in size, shining and sparsely punctulate; connecting isthmus between the intermediate coxae unusually long, the metasternal projection very short, truncate, the dividing suture fine; head well developed, truncate at base, the palpi rather short, normal, the eyes small, the antennae short and stout, the subapical joints transverse; neck scarcely half as wide as the head; prothorax wider than long, obtrapezoidal and evenly convex, transversely impressed before the scutellum; elytra nearly as in *Tachyusa*; abdomen parallel and very evidently narrower than the elytra, the first three tergites rather strongly, subequally impressed at base; legs slender, the hind tarsi rather long, the basal joint longer than the next two combined. Pacific Coast of America.
- Gnyptella**
- 7 — Form stouter, the size less minute, the integuments extremely minutely, sparsely punctulate and polished throughout; prosternum short though strongly and posteriorly angulate; head moderate, rounded behind the eyes, the latter well developed and generally prominent; antennae more or less long and slender; prothorax wider than long, obtrapezoidal, with the sides more angulate anteriorly and thence more sinuate to the base than in *Gnypteta*, but with the short transverse impression before the scutellum as in that genus; elytra well developed, convex; abdomen nearly as wide as the elytra as a rule, with the first three tergites subequally and narrowly though deeply impressed at base; legs rather long and

slender, the hind tarsi unusually short, with the basal joint much shorter than the next two combined. Sonoran fauna of America.

Euliusa

- 8 — Body nearly as in *Neolara* though less stout, minute in size; mesosternal process extremely short, extending but little beyond anterior fourth of the acetabula, its tip truncate and separated from the long, convex, laterally ill-defined metasternal projection by a short flat isthmus, which extends obliquely in plane from the depressed apex of the metasternum to the tip of the mesosternum; prosternum well developed before the coxae, extending about three-fourths the way to the mesosternum, its tip obtuse and subparabolic; head well developed, arcuato-truncate at base, the palpi slender; antennae rather long, incrassate toward tip; eyes somewhat small but prominent; neck less than a third as wide as the head; prothorax wider than long, obtrapezoidal, strongly and almost evenly convex, not impressed in the middle before the base; elytra not angulate externally at tip; abdomen rather broad, parallel, the first three tergites rather narrowly and not strongly impressed at base; legs slender, the hind tarsi very slender, filiform, with the basal joint much elongated and about equal to the next two combined. America and Mexico. [= *Merona* || Shp.].....**Meronera**

Body somewhat as in *Tachyusa* but stouter; middle coxae still more widely separated than in *Meronera*, the mesosternal process very broadly arcuato-truncate at tip, extending to about anterior two-fifths of the acetabula, separated from the broad, anteriorly and gradually depressed, parallel, transversely convex and laterally ill-defined metasternal projection by a short and very wide isthmus inclining upward from the tip of the latter to the mesosternum, the entire structure somewhat as in *Meronera*; prosternum moderate before the coxae, broadly rounded posteriorly; head well developed, rounded behind, the palpi long and herissate, the eyes large and prominent; antennae moderately long, slender, slightly incrassate distally; neck distinctly less than half as wide as the head; prothorax not transverse, obtrapezoidal, convex, broadly, obsolete impressed along the middle; elytra well developed, angulate externally at tip; abdomen much narrower than the elytra, subclaviform, the three basal tergites strongly and broadly impressed and coarsely sculptured at base as in *Tachyusa*, except that the impressions have no trace of medial carina; legs long, the hind tarsi very long, subequal in length to the tibiae, with the basal joint rather longer than the next two combined. South Africa.....***Amanota**

The apparent mutual affinities of the various genera are not very well brought out in the above table, and it is rather difficult to indicate this in the linear succession necessitated by a tabular arrangement. Their mutual relationships may be more readily appreciated by the following diagram, where the various groups are connected by lines

representing bonds of affinity; subgenera to be subsequently defined are in brackets: —

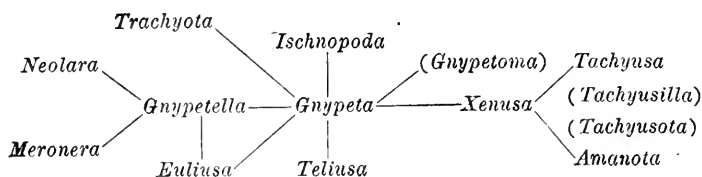

The European genera *Borboropora* Kr., and *Mataris* Fauv., are not represented in the material before me at present and it is therefore impossible to advance any useful suggestions as to their proper place in the series. The genus *Euliusa* may be rather closely allied to *Rechota* Shp., but is probably not the same, and it is possible that the *Gnypeta mexicana*, of Sharp, may be a *Euliusa*. The foreign genera indicated above may be referred to as follows: —

NEOLARA Shp. — This name was recently proposed by Dr. Sharp for a small species resembling *Meronera* somewhat in external features, but differing in having the middle coxae still more widely separated, their acetabula defined throughout by an extremely fine but continuous bead and in having the prosternum much more developed between the coxae, with its apex drawn out and extremely acute. The following species may be assigned provisionally to the genus.

Rather stout, subparallel, only moderately convex, shining, pale piceotestaceous in color, the abdomen more blackish, the antennae infusate toward tip; head much wider than long with the hind angles rounded, minutely, rather sparsely punctate; antennae slender, extending to the middle of the elytra, gradually, rather feebly incrassate toward tip, the basal joint much longer than the second or third, the latter both elongate; prothorax barely as wide as the head, about a fourth wider than long, the sides strongly rounded and subprominent at apical third, thence converging and nearly straight to the broadly arcuato-truncate base, the angles obtuse and rounded; surface strongly convex, narrowly and very obsoletely impressed along the median line behind the middle, the punctures fine but close-set; elytra transverse, one-half wider and a third longer than the prothorax, the punctures somewhat finer than those of the prothorax and less close-set, the surface paler toward the humeri and broadly along the entire apex; abdomen slightly narrower than the elytra, parallel and straight at the sides, very minutely and rather closely punctulate, the basal impressions wholly impunctate; pubescence throughout short and inconspicuous; sixth ventral

very broadly, evenly arcuato-truncate at tip in the unique type. Length 2.2 mm.; width 0.7 mm. Cuba (Bahia Honda),—H. F. Wickham.

cubana n. sp.

The hind tarsi are missing in my only representative, but they probably do not depart greatly from the prevailing type in *Meronera*.

ISCHNOPODA Thoms.—The general facies in this genus is almost wholly similar to that of *Gnyppeta*, but the middle coxae are very much more approximate and there are certain other differences, notably in the tarsi and palpi, which apparently indicate its validity. The diagnosis in the table was taken from the species described by Erichson under the specific name *umbratica*.

XENUSA Rey.—This is considered by the authorities of the most recent European catalogue to be a subgenus of *Myrmecopora* Sauley, but I have never studied that genus, and therefore can form no opinion at present; *Ilyusa*, however, seems to be slightly different from *Xenusa*. *Xenusa* is certainly an isolated type of the subtribe and the two examples of *wida* Er., before me, exhibit certain subspecific differences. One of them was collected in the south of France and the other in the Island of Corsica, the latter being rather less stout, with notably smaller head and prothorax and somewhat shorter antennae. These divergencies have been brought about in the insular form by reason of isolation undoubtedly, but the time through which this agency has been acting is of course unknown.

AMANOTA n. gen.—The type of this genus exhibits a remarkable combination of structural features characterizing other genera, but is, at the same time, an undoubtedly isolated species. The abdomen and elytra are strongly remindful of *Tachyusa*, and, the prothorax, of the genera allied to *Myrmecopora*, but the open middle acetabula, very widely separated coxae and long tarsi are characters quite unknown in those genera. The single species may be readily identified from the following description:—

Form rather stout, dark piceous-brown in color, the head and posterior parts of the abdomen blackish; legs and antennae paler, castaneous,

the abdomen toward base still paler and rufo-testaceous; head orbicular, rather shining, finely, somewhat closely punctured, feebly, impressed along the middle; antennae with the first three joints elongate and subequal in length; prothorax as long as wide, not quite as wide as the head, opaque, the punctures coarser than those of the head and closely crowded; sides at apical third prominently subangulate, thence moderately converging and feebly sinuate to the broadly arcuate base; disk very feebly impressed along the median line except toward apex; elytra large, wider than long, four-fifths wider and nearly a third longer than the prothorax, highly polished, submetallic in lustre, very minutely, evenly and not very closely punctulate; abdomen finely, rather sparsely punctulate, coarsely and densely punctured in the depressions, the surface posteriorly more closely and somewhat more strongly punctulate; sixth ventral feebly sinuato-truncate at tip in the male, rounded in the female. Length 2.8 mm.; width 0.72 mm. South Africa (Wellington).

capensis n. sp.

The abdomen, though as highly polished as the elytra, is less metallic in lustre; it is less elongate and stouter than in *Tachyusa* and only feebly narrowed toward base. The pubescence throughout is very short and inconspicuous.

Trachyota n. gen.

The type of this genus is a singularly isolated species described by LeConte under the name *Falagria cavipennis*. Its narrow head and prothorax, when contrasted with the hind body, long antennae, wide but very short, concave elytra, having peculiarly coarse rough punctures and elevated side margins, with the unusually full abdomen, are features imparting a facies wholly different from that of any other genus of the Tachyusae. Besides this type a second species was discovered several years ago by Mr. H. C. Fall, which it gives pleasure to make known at the present opportunity. The two species may be distinguished as follows: —

Form moderately slender, shining, subglabrous, the head and abdomen black; prothorax blackish-piceous, the elytra paler, piceo-testaceous; legs and antennae pale, the latter infusate toward tip; head and pronotum very finely, remotely and subasperately punctulate; elytra coarsely, not densely, evenly punctured, the punctures very strongly asperate; abdomen extremely finely and remotely punctu-

late, the impressions wholly impunctate; head as long as wide, the antennae fully three-fifths as long as the body, with all the joints elongate, the first and third subequal in length and longer than the second, the outer joints gradually slightly thicker and unusually narrowed from their apices to their bases; prothorax rather longer than wide, as wide as the head, the sides broadly rounded anteriorly, becoming gradually and feebly convergent thence to the base, which is arcuato-truncate; surface convex, very broadly and moderately concave along the middle except toward apex; elytra transverse, fully four-fifths wider than the prothorax but not quite as long, not angulate externally at tip, the latter broadly emarginate at the suture, the sides acutely elevated, the disk concave along the margin; abdomen large and elongate, parallel, with the sides somewhat arcuate, rather wider than the elytra; legs long and slender. Length 3.0 mm.; width 0.68 mm. California *cavipennis* Lec.

Form very slender, shining, subglabrous, pale rufo-testaceous throughout the body, legs and antennae, the abdomen with a large blackish subapical cloud; head very small, including the mandibles slightly elongate, the antennae very slender, nearly as in *cavipennis* but less enlarged toward tip; prothorax somewhat longer than wide, distinctly wider than the head, together with the latter very finely, sparsely and asperulately punctate, the sides strongly rounded anteriorly, thence distinctly converging to the truncate base, the angles obtusely rounded; surface narrowly and extremely obsoletely impressed along the median line except anteriorly, also transversely and arcuately impressed toward the middle before the basal margin; elytra small, transverse, much shorter than the prothorax and scarcely more than a third wider, the sides rounding toward base, the lateral margins strongly elevated, the adjoining surface concave, more broadly behind, the punctures very strongly asperate, moderately close-set, becoming feeble or subobsolete postero-externally; scutellum large, broad, prominently elevated though but slightly convex; abdomen at base as wide as the elytra, in the middle more than a fourth wider, the sides parallel and strongly arcuate, the surface minutely, very remotely punctulate throughout; legs slender. Length 2.8 mm.; width of abdomen 7.2 mm. California (Pomona) *lativentris* n. sp.

The male sexual characters in *cavipennis* consist of a strong tubercle at the centre of the first tergite and a posteriorly inclined spiniform tubercle near the extreme tip of the fifth, its apex projecting beyond the segmental apex; the sixth ventral is obscured in the only male before me. *Lativentris* is represented thus far in my collection by the female only. Each of the strongly asperate tuberculiform punctures of the elytra bears a short stiff inclined seta. It is probable that the species of *Trachyota* are associated in some way with ants, though I have no records from Mr. Fall on this subject.

Gnypeta Thoms.

The European fauna appears to include but three members of this genus, thus contrasting greatly with the American which is very rich, not only in species of *Gnypeta* but in several allied genera as well. In some more elongate and slender forms it seems to make a rather close approach to *Tachyusa*, to which genus a number of its species were originally assigned, but the resemblance is more apparent than real. The very narrow claviform abdomen and strongly angulate external tips of the elytra will readily distinguish the true *Tachyusa* from any *Gnypeta*, without referring at all to the very approximate coxae and acute mesosternal process, which, in *Gnypeta*, is always broader. In *Gnypeta* the apices of the elytra are never more than feebly oblique or moderately angulate at the sides externally, and, even when the basal impressions of the abdomen are strong, they are never medially carinate as they are in *Tachyusa*. The antennae are almost as diversified in length and thickness as in the genus *Aleochara*, enabling us to suggest a very convenient primary division among the numerous species. The general sculpture is fine but much less so as a rule than in the allied genus *Euliusa*, of the Sonoran fauna, and is usually much denser, frequently giving the integuments a duller appearance and the color is almost universally deep black, contrasting with the equally prevailing pale coloration of that genus. The twenty-two species represented in my cabinet can probably be identified through the following outline descriptions:—

- Antennae short, although generally somewhat longer than the head and prothorax together2
 Antennae longer, always very much longer than the head and prothorax; apex of the elytra moderately angulate posteriorly at the sides.....8
 2 — Antennae evidently longer than than the head and prothorax, the subapical joints never more than slightly wider than long; basal impressions of the abdomen more or less sparsely punctured or subimpunctate; species of the *carbonaria* type....3
 Antennae not longer than the head and prothorax, more compact and incassate distally, the subapical joints strongly transverse; basal impressions of the abdomen coarsely and densely punctured.....7

3 — Basal impressions of the abdomen more or less coarsely and distinctly punctured.....4

Basal impressions feebly and indistinctly punctured or apparently impunctate.....5

4 — Form stout, convex, parallel, shining, deep black throughout the body, antennae and legs, the latter rufo-piceous distally; pubescence fine, moderate in length, decumbent, rather sparse but dark gray and distinct; head well developed, wider than long, abruptly narrowed at base, finely, rather closely punctate, with a large and oval, median impunctate depression; antennae extending to about basal third of the elytra, the second and third joints elongate and equal, the tenth almost as long as wide; neck four-fifths as wide as the head; prothorax short, slightly wider than the head, more than a fourth wider than long, the sides moderately prominent at apical third, thence feebly converging to the base; surface broadly, evenly convex, minutely, not closely and inconspicuously punctulate, with two very approximate coarse punctures in a short transverse impression just before the base; elytra well developed, parallel, wider than long with well marked humeri, a third wider and one-half longer than the prothorax, broadly, feebly sinuate toward the sides at tip, minutely, not densely and inconspicuously punctulate; abdomen almost as wide as the elytra, parallel, the border thick but rapidly thinner on the fifth segment, the punctures minute and rather close-set but inconspicuous, the three basal impressions deep and coarsely but not densely punctate; hind tarsi short, the first three joints rapidly decreasing in length. Length 2.9 mm.; width 0.78 mm. Montana (Kalispell), — H. F. Wickham.....*helenae* n. sp.

Form nearly similar to the preceding, much smaller, shining, black, the elytra very dark, the entire legs paler, castaneous; antennae blackish-piceous; punctures minute and somewhat close-set throughout, the vestiture short and not very conspicuous; head and antennae nearly as in *helenae*, the second joint of the latter rather longer and thicker than the third; middle of the vertex with a smaller, deep, rounded and impunctate impression; prothorax nearly similar but relatively somewhat smaller, scarcely wider than the head, unimpressed, the two basal foveae similarly well marked; elytra more elongate, but slightly transverse, similarly impressed on the suture toward base and with widely exposed humeri, one-half wider and longer than the prothorax; abdomen parallel, narrower than the elytra, the punctures rather stronger than in *helenae* and equally close-set; legs rather short and stout, the hind tarsi fully three-fourths as long as the tibiae, with the first joint shorter than the next two combined, the bristling setae long. Length 2.3 mm.; width 0.68 mm. Arizona (Benson), — G. W. Dunn.

deserticola n. sp.

Form subparallel and rather stout, shining, finely, closely punctulate throughout but especially on the abdomen, the pubescence not conspicuous, black, the elytra feebly picescent, the legs piceous, gradually paler distally, the antennae blackish, scarcely paler toward base; head nearly as long as wide, broadly rounded behind at the sides, the eyes moderate, the vertex broadly, feebly and indefinitely impressed; antennae gradually and rather strongly incrassate distally, the second joint

obviously longer but scarcely thicker than the third, the two or three subapical joints evidently wider than long; prothorax fully a fifth wider than long, slightly wider than the head, the sides broadly rounded at apical third, thence moderately converging and straight to the basal angles, the surface with a small and feeble, transverse and obsolete bifoveolate impression before the scutellum; elytra distinctly transverse, two-fifths wider and longer than the prothorax, impressed on the suture just behind the scutellum, the humeri moderately exposed at base; abdomen parallel, distinctly narrower than the elytra, the punctures of the basal impressions rather well separated; basal joint of the hind tarsi slightly shorter than the next two combined. Length 2.2 mm.; width 0.61 mm. California (Pomona). — H. C. Fall.

punctulata n. sp.

Form less stout, more depressed and less shining, though colored as in *helenae*, the punctures throughout rather fine but deep and very close-set, on the abdomen scarcely smaller but much less approximate, the latter more shining; head moderate, slightly wider than long, flattened and scarcely visibly impressed toward the middle, the antennae somewhat less elongate than in *helenae*, with the second joint evidently longer and somewhat thicker than the third, the outer joints obtusopoidal, the tenth rather distinctly wider than long; prothorax evidently wider than the head, the outline nearly as in *helenae*, the surface very finely, feebly impressed along the median line except toward tip, with a short deep transverse impression before the scutellum; elytra large, slightly transverse, parallel, two-fifths wider and fully one-half longer than the prothorax; abdomen parallel, very distinctly narrower than the elytra, the basal impressions distinctly and somewhat coarsely but not very closely punctate; legs rather stout, the hind tarsi short, the basal joint almost as long as the next two combined. Length 2.3 mm.; width 0.65 mm. California (Monterey Co.). | *Tachyusa crebra* (Csy.).

crebrapunctata Csy.

5 — Abdomen broad, parallel with the sides arcuate, in the middle nearly as wide as the elytra. Body stout, polished, black, the elytra feebly piceous, the antennae piceous, the legs pale brownish-testaceous; punctures minute and only moderately close throughout, the pubescence dark ashy, short, the abdominal segments each with a perfect fringe of long cilia as usual; head with rather stronger punctures than elsewhere, feebly flattened, with a small deep impression at the middle, the median line broadly impunctate throughout; neck rather more than two-thirds as wide; second and third antennal joints equally elongate; prothorax as in *helenae* but smaller and less transverse, not wider than the head, feebly impressed along the middle basally and with a short transverse impression including two large foveae before the scutellum; elytra moderately transverse with widely exposed humeri, fully one-half wider and a third longer than the prothorax; abdominal impressions wholly impunctate and highly polished; legs slender, the hind tarsi two-thirds as long as the tibiae, the basal joint slightly shorter than the next two combined. Length 2.9 mm.; width 0.8 mm. Arizona. **ventralis** n. sp. Abdomen nearly as in *ventralis*. Body much smaller, moderately stout, polished, blackish piceous in color; legs pale, the antennae dark, paler

toward base; punctures minute and rather sparse throughout, the pubescence inconspicuous, longer on the abdomen; head as long as wide, very feebly impressed at the middle of the occiput, parallel at the sides, the basal angles broadly rounded, the eyes rather small; antennae slender toward base, somewhat rapidly incrassate distally, the subapical joints distinctly wider than long; prothorax equal in width to the head, a fifth or sixth wider than long, widest at about apical third, where the sides are rounded and moderately prominent, thence distinctly converging and somewhat sinuate to the basal angles, the surface with a small and feeble transverse impression before the scutellum; elytra transverse, two-fifths wider than the prothorax but only slightly longer, the humeri widely exposed at base, abdomen parallel with evenly arcuate sides, at the middle distinctly wider than the elytra, the three basal impressions equal, narrow, deep and wholly impunctate. Length 1.9 mm.; width 0.65 mm. Florida.....**floridana** n. sp.

Abdomen at every point distinctly narrower than the elytra, parallel, with the sides straight or nearly so..... 6

6 — Form rather stout, moderately convex, highly polished, deep black throughout, the antennae piceous-black, the legs paler, piceo-testaceous, punctures throughout extremely minute and not close set, the ventiture short, fine and inconspicuous; head moderate, finely, very feebly impressed along the median line, where the punctulation also becomes subobsolete; second and third antennal joints equally elongate, neck two-thirds as wide; prothorax barely perceptibly wider than the head transverse, nearly two-fifths wider than long, of the usual form, the hind angles obtuse but not in the least rounded, the surface broadly, evenly convex, only punctulate toward the middle and along the base, elsewhere impunctate, the two approximate impressed foveae before the scutellum distinct, otherwise wholly unimpressed, elytra somewhat, less than one-half wider and longer than the prothorax, impressed on the suture behind the scutellum as usual; abdomen sparsely punctulate, with thick border and convex tergites, the basal impressions wholly impunctate and polished, excepting a sparse series of extremely obsolete punctures along the basal elevations; legs moderately short, the hind tarsal fully two-thirds as long as the tibiae, the basal joints short, the first three decreasing uniformly in length. Length 2.4 mm.; width 0.7 mm. Missouri (St. Louis), — G. W. Bock.....**bockiana** n. sp.

Form moderately stout, somewhat depressed, alutaceous in lustre, the punctures minute and very close-set throughout, deep black throughout the body and antennae; legs blackish, the tarsi testaceous; pubescence very short, inconspicuous; head moderate, convex, very finely, feebly impressed along the median line only for a short distance at the middle of the vertex; antennae fully attaining basal third of the elytra, the second joint rather longer than the third and more cylindrical as usual; basal constriction abrupt, the neck nearly three-fourths as wide; prothorax unusually short, much wider than the head, nearly one-half wider than long, the sides nearly straight and subparallel, rounded anteriorly, the basal angles obtuse and not rounded, the base arcuate; surface broadly impressed along the middle in more than basal half, the transverse ante-basal impression feeble, with its two foveae dis-

tinct; elytra about two-fifths wider and nearly one-half longer than the prothorax, the sutural impression behind the scutellum broad and feeble; abdomen with the segments feebly convex, the border only moderately thick, the basal impressions more coarsely punctured but with the punctures extremely obsolete, so that they appear to be impunctate and polished; legs rather short but slender, the hind tarsi filiform, two-thirds as long as the tibiae, the basal joint not quite as long as the next two combined. *Male* with a small, extremely shallow, rounded sinus at the tip of the sixth ventral plate. Length 2.3 mm.; width 0.65 mm. Manitoba (Winnipeg).....**manitobae** n. sp.

7 — Form narrow, elongate, parallel, convex, moderately shining, castaneous, the abdomen blackish posteriorly, the antennae piceous, the legs testaceous; punctures anteriorly very fine, moderately close, of the elytra stronger, closer and asperulate, of the abdomen less close and feebly asperulate; pubescence rather inconspicuous; head small, with a very small faint impression at the middle of the vertex; antennae stout, the second and third joints much less elongate than usual, equal and each much shorter than the first; prothorax of the usual form, rather more than a third wider than long, much wider than the head, the sides converging and nearly straight from anterior third to the base, broadly rounded anteriorly; surface convex, not evidently impressed along the median line, the short transverse ante-basal impression confusedly foveolate; elytra about two-fifths wider and longer than the prothorax, the apical external angulation rather stronger than in the preceding species, the post-scutellar impression broad and feeble; abdomen slightly narrowed from apical third to the base but distinctly narrower than the elytra at every part, the first three tergites more convex, broadly and deeply impressed at base both dorsally and ventrally, with the impressions coarsely and closely punctured, the entire conformation recalling *Tachyusa*; legs rather long, the hind tarsi three-fourths as long as the tibiae, the first joint as long as the next two combined; sixth ventral evenly rounded at tip, broadly in the male. Length 2.4–2.8 mm.; width 0.6 mm. British Columbia. (Kamloops and Glenora), — H. F. Wickham.....**brevicornis** n. sp.

8 — Prothorax widest at about apical third as usual, the hind angles obtuse but distinct and not at all rounded; basal impressions of the abdomen always coarsely and distinctly punctured.....9

Prothorax widest only slightly before the middle, the hind angles narrowly rounded as well as obtuse; basal impressions of the abdomen virtually impunctate. [*Gnyptoma* n. subgen.].....19

9 — Species of the Atlantic Coast region.....10

Species of the Rocky Mountain regions.....11

Species of the Pacific Coast fauna.....12

10 — Form only moderately stout, convex, shining, deep black throughout, the antennae piceous-black, the legs dark piceo-testaceous; punctures very fine, rather close-set but inconspicuous, equally close but still finer on the abdomen; pubescence not conspicuous; head wider than long, strongly impressed along the median line at the middle of the vertex, where the surface becomes subimpunctate, more broadly anteriorly; eyes large; neck very wide; antennae nearly as long as

the ante-abdominal part of the body, feebly and gradually incrassate, the first three joints equal in length, much elongated, the tenth perceptibly longer than wide; prothorax slightly wider than the head, fully two-fifths wider than long, the sides broadly rounded anteriorly, thence unusually feebly converging to the base, the surface rather narrowly and distinctly impressed along the median line except apically and with a short and very feeble transverse impression before the base, also with four small rounded impressions forming a very large median quadrilateral — perhaps accidental in the type; elytra two-fifths wider and one-half longer than the prothorax, the humeri only moderately exposed and rounded, the post-scutellar impression rather small and feeble; abdomen parallel, much narrower than the elytra, the basal impressions of the first three tergites wholly impunctate toward the raised basal margin but with a transverse irregular series of somewhat close-set coarse punctures posteriorly, the fourth tergite also narrowly impressed and slightly more coarsely punctate along the basal margin; legs rather long and slender, the hind tarsi three-fourths as long as the tibiae, with the first three joints rapidly decreasing in length, the second and fifth equal. Length 2.8 mm.; width 0.68 mm. Pennsylvania. [= *Tachyusa nig.* Lec.]..... **nigrella** Lec.

Form more depressed, very highly polished, deep blue-black throughout, the legs nearly black with the tarsi paler, the antennae piceous-black; punctures very fine, rather close-set, inconspicuous, especially on the abdomen; pubescence very short and indistinct; head nearly as in *nigrella*, the eyes smaller and less prominent, the impression broader, the antennae stouter but less incrassate distally, extending to the middle of the elytra, the third joint slightly longer than the second and both much shorter than the stouter fusiform first joint, the tenth barely as long as wide; prothorax transverse, slightly wider than the head, the sides broadly subangulate anteriorly, thence moderately converging and broadly sinuate to the base, the surface unimpressed along the median line, but with an unusually large wide transverse impression before the base, the impression confusedly punctulate at each side of the middle; elytra relatively very large, one-half wider and two-thirds longer than the prothorax, the humeri widely exposed and rectangular, the post-scutellar impression large, broad and strong; abdomen very much narrower than the elytra, parallel and straight at the sides, the basal impressions coarsely but not very closely punctured and still less closely toward the basal margins; legs slender, the tarsi nearly as in *nigrella*; sixth ventral sharply angulate at tip in the female, the male not known. Length 2.6 mm.; width 0.75 mm. New York (Catskill Mts.)..... **atrolucens** Csy.

11 — Body sublinear but somewhat stout, convex, moderately shining, piceous-black in color, the antennae but little paler though paler toward base, the legs brown; punctures minute and very close-set throughout; pubescence very short but dense and distinct; head rather small, the sides converging and arcuate behind the eyes to the base, the vertex feebly flattened and broadly less punctate anteriorly, with a small feeble impression at the middle; antennae long, stout, strongly incrassate distally, the third joint much longer than the second and as

- long as the first but thinner, the tenth not quite as long as wide; prothorax unusually elongate, only slightly wider than long, the sides very obtusely subangulate anteriorly, thence distinctly converging and straight to the base, the surface strongly impressed along the middle from before the centre nearly to the base, becoming gradually slightly wider but without trace of a transverse ante-basal impression; elytra moderate, two-fifths wider and longer than the prothorax, the humeri only moderately exposed and somewhat rounded, the post-scutellar impression rather narrow and deep; abdomen very distinctly narrower than the elytra parallel and nearly straight at the sides, very closely punctulate, the deep basal impressions with moderately coarse, deep punctures, which are close-set throughout, but not at all crowded; legs long and not very slender, the hind tarsi pale, three-fourths as long as the tibiae, the first joint very nearly as long as the next two combined. *Male* with a small, broadly angular notch at the apex of the sixth ventral. Length 2.9-3.1; width 0.7 mm. Utah (Provo) and Montana (Kalispell),—H. F. Wickham.....*incrassata* n. sp.
- 12—Abdomen parallel and straight at the sides throughout or virtually so..... 13
- Abdomen distinctly narrowed from near the apex to the base..... 14
- 13—Head larger, nearly as wide as the prothorax, less narrowed at base, the neck broader. Form rather stout, strongly convex, shining, black, the legs and antennae rufo-piceous; punctures very minute and only moderately close-set; pubescence somewhat coarse and distinct; head with a deep rounded impression at the middle of the vertex; the eyes moderate; antennae thick but only feebly incrassate distally, the third joint slightly longer than the second, but not as long as the first and thinner as usual, the tenth not as long as wide; prothorax only slightly transverse, a fourth or fifth wider than long, the sides anteriorly broadly rounded, thence moderately converging and nearly straight or less arcuate to the base, the surface, broadly, feebly concave toward the median line, except anteriorly, but without a distinct ante-basal transverse impression; elytra well developed, nearly one-half wider and longer than the prothorax, the humeri moderately exposed and subrectangular, the post-scutellar impression small and somewhat feeble; abdomen very much narrower than the elytra, the deep basal impressions coarsely punctured, the punctures crowded as in *Tachyusa*; legs long, rather stout, the hind tarsi with the basal joint about as long as the next two combined. Length 2.6 mm.; width 0.68 mm. California (Ojai),—H. C. Fall.....*leviventris* n. sp.
- Head nearly as in the preceding species. Form rather stout, moderately convex, shining, finely, closely punctulate, the abdomen sparsely so toward base, black, the legs piceous, the antennae brownish-fuscous; head obviously wider than long, rather abruptly constricted at base with rounded angles, the eyes at much less than their own length from the base in the male, scarcely as large in the female, the vertex with a small, strong and rounded impression in the former, which becomes much larger in the latter sex, its bottom punctureless and polished; antennae extending rather beyond the middle of the elytra, slender, gradually and feebly incrassate distally, the second joint evi-

dently longer than the third, the subapical as long as wide in the male, rather more elongate in the female, the eleventh pointed and apparently impressed laterally at apex; prothorax scarcely visibly wider than the head in the male, distinctly so in the female, a fifth wider than long in the former and fully a fourth in the latter, widest and broadly rounded at the sides near apical third, the sides thence feebly converging and almost straight to the base; surface with a small, transverse and approximately bifoveate impression before the scutellum in both sexes, the median line finely impressed almost throughout, very obsolete in the female; elytra nearly one-half wider and longer than the prothorax, feebly impressed behind the scutellum, the humeri well exposed at base; abdomen parallel and straight at the sides, distinctly narrower than the elytra, the moderately coarse punctures of the basal impressions well separated. *Male* with the sixth ventral plate broadly, feebly sinuate in about median third. Length 3.0 mm.; width 0.8 mm. Oregon (Portland).—H. F. Wickham.

oregona n. sp.

Head distinctly narrower than the prothorax in the female, probably less obviously so in the male, the neck broad as in the two preceding species. Form moderately stout and convex, polished, the punctures fine and rather sparse throughout, closer toward the apex of the abdomen, piceous-black, the elytra somewhat paler; legs dark testaceous, the antennae blackish; head transverse, arcuately narrowed at base, the eyes rather large, the surface concavely impressed along the median line from near the front to the base of the occiput; antennae extending beyond the middle of the elytra, slender, feebly incrassate distally, the second joint distinctly longer than the third, the subapical scarcely as long as wide, the eleventh pointed and laterally impressed at tip; prothorax transverse, nearly a third wider than long, of the usual obtusoid form, the sides rounded at apical third, the disk having the usual feeble bifoveolate impression before the scutellum; elytra transverse, two-fifths wider and a third longer than the prothorax, narrowly and briefly impressed on the suture at base, the humeri moderately exposed and obliquely rounded; abdomen parallel, distinctly narrower than the elytra, the moderately coarse punctures of the basal impressions sparse, rather distinct in the first but virtually obsolete in the third. *Male* unknown. Length 2.1 mm.; width 0.63 mm. California (Yuma).....*impressiceps* n. sp.

Head smaller, much narrower than the prothorax, more strongly, arcuately narrowed to the base or more orbicular, the neck narrower, barely three-fifths as wide as the head. Form very slender, polished, black, the abdomen toward base dark, and the legs and antennae pale, rufopiceous; punctures rather close-set but minute throughout, the pubescence somewhat inconspicuous; head nearly as long as wide, with a rounded impression at the middle of the vertex; antennae distinctly incrassate distally; prothorax rather more than a fourth wider than long, the sides broadly rounded anteriorly, thence distinctly converging and straight to the obtuse but very conspicuous basal angles, the surface as a rule not impressed along the median line except deeply near the basal margin, but often broadly and irregularly concave — probably

accidentally,— without distinct transverse impresssion; elytra well developed, much wider and longer than the prothorax, the humeri widely exposed but somewhat rounded, the post-scutellar impression short but rather deep; abdomen slender, very much narrower than the elytra and about as wide as the prothorax, the basal impressions coarsely and densely punctured; legs slender, moderately long. *Male* with a very small angular sinus, not more than a fourth or fifth as wide as the segment at the apex of the sixth ventral. Length 3.0 mm.; width 0.63 mm. California (Mendocino to Pomona). [= *Tachyusa lin.* Csy.].

linearis Csy.

- 14—Elytra relatively broader, the humeri widely exposed at base though obtusely rounded; general form moderately convex.....15
- Elytra relatively narrower, the humeri only slightly exposed; form strongly convex.....18
- 15—Elytra large and well developed, the suture much longer than the prothorax as usual. Form parallel, stouter than in *linearis*, moderately shining, piceous-black, the under surface behind the third ventral blackish; legs pale testaceous, the antennae piceous; pubescence rather coarse and distinct, the punctures very minute and rather close-set but sparser on the abdomen; head moderate, obliquely narrowed behind, the neck rather more than two-thirds as wide, the vertex with a rather shallow and rounded median impression; antennae scarcely extending to basal two-fifths of the elytra, the first three joints subequal in length, the outer joints only feebly incrassate, the tenth not quite as long as wide; prothorax obviously, though not greatly, wider than the head, only very slightly wider than long, the sides very feebly and broadly subangulate at apical two-fifths, thence distinctly converging to the well-marked basal angles, the surface convex, scarcely visibly impressed along the middle posteriorly, with a short feeble transverse ante-basal impression; elytra but slightly transverse, very much wider and longer than the prothorax, the post-scutellar impression deep and slightly elongate; abdomen widest at the apex of the fourth segment, where it is distinctly narrower than the elytra, the sides thence feebly converging and straight to the base, the basal impressions very deep, coarsely and densely punctured, the fourth tergite also impressed and coarsely punctate at base; legs rather long, the first three joints of the hind tarsi rapidly decreasing in length. *Male* with the angular sinus of the sixth ventral larger and deeper than in *linearis*. Length 3.2 mm.; width 0.78 mm. California (Mendocino Co.). [= *Tachyusa exp.* Csy.].....**experta** Csy.
- Elytra much shorter and more strongly transverse, the suture never more than very slightly longer than the prothorax; form sublinear.....16
- 16—Prothorax not transverse, hexagonal, not wider than the head. Body slender, shining, black, the three basal ventrals somewhat paler; legs pale, the antennae piceous-black; punctures very fine, granuliform, close-set, the pubescence fine and inconspicuous; head rounded, fully as long as wide, the eyes rather small; neck but little more than half as wide; vertex with a very small rounded impression; antennae gradually and rather strongly incrassate, the second and third joints elongate, subequal, each somewhat longer than the first, the ninth and tenth

slightly transverse; prothorax not distinctly wider than long, the sides broadly, obtusely angulate at apical third, thence rather strongly converging and nearly straight to the base, the surface with a small transverse bifoveolate impression before the basal margin; elytra transverse, fully one-half wider but only about a fourth longer than the prothorax, the suture scarcely at all longer than the latter, impressed as usual behind the scutellum; abdomen broadly arcuate at the sides, as wide as the elytra posteriorly, the basal impressions deep, coarsely and densely punctured, the fourth tergite also impressed and more coarsely punctate along the basal margin; three basal joints of the hind tarsi uniformly and rapidly decreasing in length. *Male* with the apical margin of the sixth ventral ciliate and beveled throughout the width, also sinuate. Length 2.75 mm.; width 0.58 mm. California (Siskiyou Co.).

***curtipennis* n. sp.**

Prothorax transverse, rounded at the sides anteriorly, thence distinctly, rectilinearly narrowing to the base, very much wider than the head. 17
 17 — Body stouter, linear, dark piceous, the abdomen blackish, the three basal segments paler, moderately shining; legs pale, the antennae fuscous, rufous toward base; punctures very small, close-set, granuliform, the pubescence inconspicuous; head small, rounded, the eyes small, prominent, the impression of the vertex minute and feeble; antennae gradually and distinctly incrassate, the second joint much elongated and longer than the first or third, the outer joints slightly transverse; prothorax about a fourth wider than long, impressed along the middle from apex to base, the impression gradually increasing in width posteriorly; elytra about two-fifths wider and scarcely a third longer than the prothorax, the suture about a fourth longer than the latter, impressed behind the scutellum; abdomen nearly as in *curtipennis* but perceptibly narrower than the elytra even posteriorly, less closely punctulate than the anterior parts; legs slender, the three basal joints of the hind tarsi rapidly decreasing in length. *Male* with a small simple triangular sinuation at the apex of the sixth ventral plate nearly as in *curtipennis*, about a third as wide as the segment and three times as wide as deep. Length 2.9 mm.; width 0.63 mm. Oregon (Lane Co.). ***abducens* n. sp.**

Body more slender, smaller in size, shining, testaceous in color with a blackish cloud at the abdominal apex; legs and antennae pale, the latter fuscous toward tip; punctures minute, subgranuliform and only moderately close-set, the pubescence inconspicuous; head nearly as in *abducens*, the antennae notably longer, extending fully to the middle of the elytra, the three basal joints as in *abducens*, the subapical longer, scarcely wider than long; prothorax nearly similar but with the impression obsolete behind the apex; elytra not well developed, transverse, about a third wider but scarcely perceptibly longer than the prothorax, the suture about equal in length to the latter, the post-scutellar impression deep and distinct; abdomen narrower, very much narrower than the elytra at every point, the sides very feebly arcuate, the width only slightly greater posteriorly, the deep basal impressions densely and coarsely punctured; legs very slender, the hind tarsi almost four-fifths as long as the tibiae, with the four basal joints decreasing uniformly and rapidly in length, the second and fifth subequal; claws long and very slender as in the preceding; sixth ventral broadly rounded at apex

- in the unique female type, which may be somewhat immature. Length 2.4 mm.; width 0.52 mm. California (Siskiyou Co.)...**shastana** n. sp.
- 18— Form sublinear, strongly convex, somewhat alutaceous, black, the abdomen toward base dark, the legs paler, piceo-testaceous, the antennae piceous; punctures small, granuliform, very close-set, less so on the head and abdomen; pubescence short and not conspicuous; head small, rounded, finely, linearly impressed on the median line near the middle of the vertex, the eyes moderate, not prominent; antennae long and stout, gradually and rather strongly incrassate distally, the first three joints subequal, the second slightly the longest, the first stouter as usual, the tenth about as long as wide; prothorax large, convex, only very slightly wider than long, much wider than the head, the sides very broadly arcuate, becoming straight and convergent toward base, the surface broadly and strongly impressed along the middle except toward tip; elytra but little wider than long, about a fourth wider and a fifth longer than the prothorax, with a large and broadly impressed area behind the scutellum; abdomen posteriorly broadly arcuate at the sides and as wide as the elytra, narrowed only slightly toward base, the three basal depressions deep and coarsely, densely punctate; legs long and rather stout, the hind tarsi with the basal joints diminishing in length as usual. *Male* sexual characters feeble, the fifth ventral with a very feeble sinuation in median seventh or eighth, the sixth narrow, sinuato-truncate at tip. Length 2.8 mm.; width 0.65 mm. California (Sonoma Co.). [= *Tachyusa har.* Csy.].....**harfordi** Csy.

Subgenus **Gnyptoma** Csy.

- 19— Form sublinear, strongly convex, highly polished, blackish-piceous, the basal ventrals dark, the legs and antennae pale, testaceous; punctures extremely minute, only moderately close-set and asperulate on the pronotum and elytra, largely obsolete on the head, except toward the sides and base, and sparse on the abdomen; vestiture inconspicuous; head moderate, rounded, the eyes not prominent, the vertex scarcely impressed, the maxillary palpi long, glabrous but herissate with stiff suberect setae; antennae unusually developed, slender, gradually and strongly incrassate distally, the second and third joints much elongated, equal, each somewhat longer than the first, the tenth about as long as wide; prothorax only just visibly wider than long and but little wider than the head, unusually narrowed anteriorly, rounded at the sides, strongly convex, with a strong elongate-triangular depression before the basal margin; elytra two-fifths wider and a fourth longer than the prothorax, the humeri rather well exposed, the suture only obsoletely impressed at base; abdomen toward tip broadly arcuate at the sides and somewhat wider than the elytra, the sides distinctly converging toward base, where it is but slightly narrower than the elytra, the basal impressions of the first three tergites narrow, very deep, subequal and impunctate; legs rather long and slender, the hind tarsi very short, but little more than half as long as the tibiae, the basal joint subequal to the next two combined. *Male* with the sixth ventral broad, with a broad and feeble sinuation toward the middle at apex. Length 2.7 mm.; width 0.7 mm. New Jersey (Elizabeth). [= *Tachyusa balt.* Lec.].
baltifera Lec.

The material in my cabinet is not sufficiently extensive to enable me to make a thoroughly satisfactory investigation of the somewhat varied male sexual characters of this genus, which, not only in this respect but in general structure and habitus, is rather heterogeneous. Most of the species of the table resembling the typical *carbonaria*, are described from uniques and they all have the sixth ventral rounded at tip, but whether they are all females or whether the male in typical *Gnypeta* lacks the apical sinus of the elongate forms having more developed antennae and sometimes having the first four abdominal tergites impressed at base, is unknown to me at present. There are some special characters as well, for example the female of *atrolucens*, which is also aberrant in general appearance, has the sixth ventral plate sharply angulate at tip, this being the only instance known as yet. Some of the species strongly recall *Tachyusa* in general appearance and I have but little doubt that, when the very numerous species still to be discovered can be fully studied, the genus as above constituted will be divided into a number of generic or subgeneric groups. It seems scarcely worth while to point out more than one of these at present, but the characters of the species identified above as *baltifera* Lec., from description alone, seem to warrant the erection of a special subgenus because of the form of the prothorax and especially the rounded hind angles of the latter.

Teliusa n. gen.

The single type of this genus, while resembling a normal *Gnypeta* somewhat in general outline, differs very greatly in facies because of the fine dense sculpture and the dense vesture of very short fine pale hairs, clothing the entire body, legs and antennae, so that a satisfactory examination of the tarsal joints is a matter of some difficulty; it may be described as follows: —

Form rather stout and convex, pale rufo-testaceous in color, the head blackish, the elytra somewhat clouded except toward the apex and near the humeri; posterior segments of the abdomen black, the legs and antennae pale, the latter somewhat feebly infumate distally; entire body

extremely minutely and densely asperulato-punctate, the abdomen particularly densely so, dull in lustre, the head rather less densely sculptured and more shining; head fully as long as wide, the eyes large and rather convex, the tempora short behind them; surface very feebly impressed along the median line of the vertex; antennae very long and slender, extending rather beyond the tips of the elytra, very feebly incrassate distally, the joints elongate, the three penultimate as long as wide, the eleventh slender, as long as the two preceding combined; prothorax scarcely visibly wider than the head and very slightly wider than long, widest at apical third, where the sides are broadly rounded, thence feebly convergent and straight to the base, which is feebly arcuate; surface obsolete impressed along the median line almost throughout, not at all transversely impressed before the scutellum; elytra two-fifths wider and a third longer than the prothorax, the humeri somewhat exposed at base, rounded; abdomen not quite as wide as the elytra, parallel, with evenly and conspicuously arcuate sides, the tergites flat; legs long and slender. Length 2.0 mm.; width 0.6 mm. Texas (Brownsville),—H. F. Wickham.....*alutacea* n. sp.

The sixth ventral of the male appears to be very broadly and feebly bilobed at tip.

Tachyusa Erichs.

The approximation to this genus in general appearance made by certain forms of *Gnypeta*, especially the slender and sublinear species of the *abducens* type, has been alluded to above. The species here assigned to *Tachyusa* are perfectly homogeneous, however, and may be distinguished from any *Gnypeta*, even those in which the abdomen is posteriorly dilated, by the more approximate middle coxae and the more slender and generally very acutely pointed, though equally free, mesosternal process attaining the metasternal projection or virtually so, the intervening depressed isthmus of *Gnypeta* being obsolete or extremely short. They are also distinct from that genus in their more attenuate form and especially by the relatively more slender claviform abdomen, in which the deep basal impressions of the first three tergites are arcuate and not straight and are carinate in the middle, the carina joining the elevated basal margin through a posteriorly projecting cusp which I have never noticed in *Gnypeta*; the depressions are always very coarsely punctate and so densely so that the intervals are acutely elevated, forming short longi-

tudinal ridges. The medial carina is, however, obsolete in certain forms indicated below as subgenera of *Tachyusa* for present convenience. The eyes are well developed, the antennae long, gradually incrassate distally, the neck rather wide, the prothorax obtrapezoidal, wider than long, with the hind angles more than right but always very distinct and not in the least blunt. The elytra are well developed, each oblique at tip, the external sides strongly projecting posteriorly, forming a strong sublateral sinus and the legs are long and slender. The sexual characters are remarkable, the pronotum in the male being evenly convex or nearly so, while in the female it is generally broadly and strongly impressed along the middle, and, besides, is frequently more opaque, due to a minute reticulation which may not appear at all in the male; the latter sex has the sixth ventral plate minutely and angularly to feebly and broadly sinuate at tip as in *Gnyypeta*. The homogeneity of the genus renders a satisfactory tabular statement of the differential characters much more difficult than in *Gnyypeta*, but it is hoped that the following table may aid in the identification of the rather numerous species:—

- Abdomen highly polished, extremely remotely and rather less punctulate; mesosternal process wider than usual, truncate or rounded at tip but attaining the metasternum.....2
- Abdomen minutely and closely punctulate, alutaceous or pruinose; species smaller.....3
- 2 — Antennae very slender, only very feebly incrassate distally. Body stouter than usual, polished, piceous-black, the legs and antennae blackish, the tarsi paler, the basal ventrals somewhat rufescent; vestiture inconspicuous; head well developed, orbicular, minutely, sparsely punctate, the vertex broadly impunctate and feebly concave toward the middle; antennae extending to the tips of the elytra, the second and third joints much elongated, the latter rather longer than the first, the tenth distinctly elongate; prothorax only very slightly transverse and evidently wider than the head, scarcely a fifth wider than long, the sides narrowly rounded anteriorly, thence moderately converging and almost straight to the base, the surface finely, granularly and somewhat closely punctured, not reticulate, broadly concave along the median line in the female, very narrowly and obsoletely so in the male; elytra about two-fifths wider and longer than the prothorax, the humeri moderately exposed, the suture not impressed behind the scutellum, the punctures fine, not close-set and asperulate; abdomen highly polished; hind tarsi about two-thirds as long as the tibiae, the basal joint not as long as the next two combined; sixth ventral of the female broadly rounded, very feebly

- sinuato-truncate in the male. Length 2.7-3.2 mm.; width 0.65 mm. New York (Catskill Mts.), — H. H. Smith.....**smithi** n. sp.
- Antennae slender toward base but rather strongly incrassate toward tip. Form more elongate and slender than in *smithi*, shining, testaceous, the head piceous, the abdomen black posteriorly; legs testaceous, the antennae fuscous, paler basally; pubescence inconspicuous; head orbicular, minutely, sparsely punctulate, the vertex very broadly impunctate but scarcely impressed; antennae extending fully to the tips of the elytra or further, very slender but rather rapidly and strongly incrassate distally, the tenth joint not quite as long as wide; prothorax only very slightly wider than long, not wider than the head, the sides more broadly rounded anteriorly and less converging thence to the base than in *smithi*, the minute punctures granuliform and rather close-set basally, finer and sparser anteriorly, the surface broadly concave along the median line, a transversely arcuate series of larger punctures before the base generally distinct; elytra nearly as long as wide, two-fifths wider and longer than the prothorax, the sides parallel and broadly arcuate as usual; humeri rather well exposed, the punctures as in *smithi*, fine, asperulate and sparse, almost wanting toward apex; hind tarsi nearly as in *smithi* though still shorter; sixth ventral of the female broadly rounded behind, the male not at hand. Length 2.65 mm.; width 0.53 mm. Virginia.....**gracillima** Lec.
- 3 — Species of the Atlantic regions.....4
 Species of the Sonoran fauna.....11
 Species of the Pacific coast fauna.....12
- 4 — Vestiture abundant, more or less distinct and moderately pale but scarcely giving a pruinose effect on the abdomen, the latter rather strongly shining.....5
- Vestiture very dense, pale ashy, giving a strongly pruinose effect even on the abdomen; legs and basal joint of the antennae pale honey-yellow, the antennae fuscous, paler toward base.....10
- 5 — Legs piceous with the tarsi pale yellow, less minute in size, the pronotum of the female not concave along the middle. Very slender, convex, shining, blackish-piceous, the two basal ventrals paler and dark rufous, the antennae fusco-rufous; vestiture moderately distinct; head sub-orbicular, rather abruptly narrowed at base, finely closely punctulate, the front broadly, feebly concave and subimpunctate; antennae not quite extending to the tips of the elytra, rather slender, feebly incrassate distally, the second joint longer than the third, the tenth as long as wide in the male, longer in the female; prothorax very nearly as long as wide, distinctly wider than the head, the sides broadly rounded anteriorly, thence very distinctly converging and nearly straight to the base, the surface strongly convex, broadly, feebly flattened along the middle, finely but closely, granularly and equally punctulate throughout in the female, evenly convex but feebly, transversely impressed before the base, with the punctulation finer, less dense and only distinctly granulose toward base in the male, the intervals smooth in both sexes; elytra about two-fifths wider and a third longer than the prothorax, the sides parallel and arcuate, the punctures asperulate, minute and rather sparse, the humeri narrowly exposed at base; hind tarsi slender, the basal joint

about as long as the next two combined in the male, the first four evenly decreasing in the female; sixth ventral of the male feebly sinuotruncate, rounded in the female. Length 2.8 mm.; width 0.48 mm. New York (Ithaca and Catskill Mts.), Pennsylvania and Iowa.

americana n. sp.

Legs clear honey-yellow throughout, smaller species, the pronotum in the female generally distinctly impressed along the median line. 6

6 — Form very slender, more convex, the prothorax only very slightly wider than long, broadly rounded at the sides anteriorly and very distinctly narrowed thence to the base. Body blackish-piceous in color, the abdomen blacker, with the two basal segments rufous; antennae pale, fuscous toward tip. *Male* with the integuments polished and free from reticulation throughout; head finely punctulate throughout, not evidently impressed, rather abruptly constricted at the base, the antennae much shorter than usual, scarcely extending to basal third of the elytra, somewhat thick but only moderately incrassate distally, the second joint much longer than the third, the tenth barely as long as wide; prothorax very slightly wider than the head, convex, polished, minutely and closely punctulate, narrowly and very feebly, obsoletely impressed along the median line behind the middle; elytra nearly as long as wide, a third wider and two-fifths longer than the prothorax, finely, asperately and rather closely punctulate, with very narrowly exposed humeri; tarsi slender, the basal joint of the posterior as long as the next two combined; sixth ventral with a small angular emargination about twice as wide as deep. *Female* throughout proportioned nearly as in the male but with the surface of the head and pronotum very minutely, strongly reticulate and dull, the head somewhat deeply concave at the middle of the vertex, the pronotum very deeply and broadly concave along the median line throughout, the punctures of the impressed area very minute and only moderately close, those outside of the impression strongly asperate and dense; sixth ventral rounded at tip. Length 2.2 mm.; width 0.45 mm. North Carolina (Asheville). . . . **carolinae** n. sp.

Form less slender, the prothorax distinctly wider than long, broadly rounded at the sides anteriorly but only very slightly narrowed thence to the base, the sides just visibly converging. 7

7 — Head moderately developed, only slightly narrower than the prothorax. 8

Head small, much narrower than the prothorax. 9

8 — Color rufo-piceous, the abdomen black, the two basal segments rufous; antennae pale, slightly infusate apically; integuments in the male polished and free from micro-reticulation throughout; vestiture not very conspicuous; head minutely, sparsely punctulate, not impressed; antennae feebly developed, extending to about basal third of the elytra, only slightly incrassate distally, the second joint as long as the first and much longer than the third, the subapical joints not as long as wide; prothorax about a fourth wider than long, not impressed at any point, the punctulation very fine and only moderately close-set, the interstices polished, not reticulate; elytra about a third wider and fully two-fifths longer than the prothorax, the punctulation feebly asperate and not very close, paler in color at apex; basal joint of the hind tarsi not quite as

- long as the next two combined; sixth ventral with a very minute, rather shallow median sinus at tip; female not observed but having the pronotum deeply concave along the middle. Length 1.9 mm.; width 0.48 mm. Massachusetts.....*cavicollis* Lec.
- Color black, the elytra picescent but only feebly, indefinitely paler toward tip, the two basal ventrals rufescent; vestiture fine, close and rather distinct; head orbicular, not impressed, minutely punctulate and reticulate; antennae as in *cavicollis* but rather more incrassate distally, the subapical joints not as long as wide; prothorax barely a fifth wider than long, slightly though very evidently wider than the head as in *cavicollis*, minutely reticulate and dull, very minutely, closely punctulate, feebly so toward the middle, more coarsely and asperately toward the sides, the surface not impressed but only feebly flattened along the median line; elytra nearly as long as wide, a fourth wider and one-third longer than the prothorax, the humeri but slightly exposed, the surface polished, with less minute, sparser and more asperate punctures as usual, the suture minutely and feebly impressed behind the scutellum; tarsi very slender and filiform, the first joint of the posterior not quite as long as the next two combined; female with the sixth ventral rounded at tip; male not known. Length 1.9 mm.; width 0.42 mm. North Carolina (Asheville).....*obsoleta* n. sp.
- 9 — Lustre shining in the male, pale piceo-testaceous in color, the head and apical half of the abdomen black; antennae dusky toward tip; punctulation very minute, even, feebly granuliform and moderately close-set, asperulate and sparser on the elytra; pubescence not conspicuous; head rounded, scarcely impressed, the antennae rather short, slender, only slightly incrassate distally, barely as long as the head and prothorax, the second joint distinctly longer than the third, the tenth almost as long as wide; prothorax unusually large and transverse, about a third wider than long and a fourth wider than the head; apex not more than two-thirds as wide as the base, the surface barely perceptibly impressed along the middle from near the base to the centre of the disk; elytra nearly as long as wide, a fourth wider and nearly one-half longer than the prothorax, the humeri very narrowly exposed, the apex barely perceptibly paler in shade of color; tarsi very slender, the first joint of the posterior not quite as long as the next two together; sixth ventral with a very small but pronounced rounded sinus, about a fourth as wide as the segmental apex; female not at hand. Length 2.1 mm.; width 0.5 mm. Pennsylvania.....*parviceps* n. sp.
- Lustre of the head and pronotum dull in the female, elsewhere shining, piceous-black in color, the elytra less blackish, with a very narrow pale apical margin; two basal ventrals feebly rufescent; antennae red-brown, yellow toward base; punctures of the head and pronotum extremely minute, moderately close-set, of the elytra stronger and asperate; vestiture moderately distinct; head rounded, feebly impressed along the middle; antennae much longer than in *parviceps* or *cavicollis* and gradually, more distinctly incrassate distally, attaining basal third of the elytra, the second joint much elongated, slightly longer than the first or third, the tenth almost as long as wide; prothorax large but less transverse, about a fourth wider than long, finely reticulate and feebly

alutaceous, the punctures everywhere minute and feeble; disk very broadly, rather feebly impressed along the middle in almost median third; elytra not quite as long as wide, about a third wider and longer than the prothorax, the humeri very narrowly exposed, the sides arcuate, the suture distinctly impressed behind the scutellum; hind tarsi fully four-fifths as long as the tibiae, with the basal joint unusually elongate, longer than the next two combined; sixth ventral evenly rounded at tip; male unknown. Length 2.5 mm.; width 0.65 mm.; North Carolina (Asheville).....**subalntacea** n. sp.

Lustre rather dull, the punctures fine and close-set throughout, the interstices on the pronotum not reticulate in the apparent female, blackish-piceous, the abdomen rufescent, blackish posteriorly, the elytra castaneous, gradually flavescent toward the apical margin, the antennae fusco-flavate throughout; head slightly elongate, the sides behind the eyes only feebly converging and arcuate; antennae shorter than usual, distinctly incrassate distally, but little longer than the head and prothorax, the second joint slightly longer and thicker than the third, the three subapical distinctly wider than long, the eleventh as long as the two preceding combined and thicker, obtusely rounded at tip; prothorax large, convex, nearly a fifth wider than long, broadly, feebly rounded at the sides and but little narrowed toward base, the surface evenly convex except a small and very feeble, transversely arcuate impression before the scutellum; elytra only very slightly wider than the prothorax and about a third longer, the sides parallel and arcuate, the humeri scarcely at all exposed at base; abdomen much narrower than the elytra, the sides only feebly converging toward base; legs but moderately slender. Length 2.5 mm.; width 0.61 mm. Missouri.

missouriana n. sp.

10 — Form moderately stout, strongly convex, piceous-black, the elytra piceo-testaceous, blackish toward base, the two basal ventrals feebly rufescent. *Male* with the head slightly though distinctly narrower than the prothorax, scarcely impressed, rather abruptly narrowed at base, very obsoletely subreticulate and scarcely perceptibly punctulate; antennae about attaining basal third of the elytra, only slightly incrassate distally, the second joint but slightly longer than the third, the ninth and tenth somewhat transverse, the former distinctly the shorter of the two; prothorax only very slightly wider than long, the sides subparallel and feebly arcuate, the apex almost as wide as the base, the surface strongly convex, minutely, closely and subgranularly punctulate throughout, with smooth polished interspaces, the median line very finely and obsoletely impressed toward base; elytra fully two-fifths wider and longer than the prothorax, scarcely visibly and broadly impressed behind the scutellum, minutely, rather closely, asperulately punctulate, the humeri somewhat well exposed; abdomen exceedingly minutely, densely punctulate and finely, closely pubescent, the hairs closely decumbent; hind tarsi with the first joint almost as long as the next two combined; sixth ventral with a very small shallow subparabolic sinus, about four times as wide as deep. *Female* nearly similar in general form, the head notably smaller, feebly impressed along the middle; antennae and tarsi nearly similar; prothorax larger and much more

- transverse, a fourth wider than long, very much wider than the head, the surface duller because of a very minute close-set reticulation, similarly densely but less distinctly punctulate, very broadly flattened along the middle, with the median line less broadly and very feebly impressed; sixth ventral rounded behind. Length 2.6 mm.; width 0.58 mm. New York (Cat-kill Mts.),—H. H. Smith... **pruinosa** n. sp.
- Form nearly as in *pruinosa*, the coloration and lustre similar, except that the elytra are blacker throughout, with a wider, abruptly pale apical margin. *Female* with the head as in *pruinosa*, almost imperceptibly punctulate and scarcely impressed, the antennae extending to the middle of the elytra, very slender and extremely feebly incrassate distally, the second and third joints subequal in length, the latter much the narrower at base, ninth and tenth subequal in length, the former somewhat elongate, the latter fully as long as wide; prothorax less transverse than in the female of *pruinosa*, a fifth or sixth wider than long, distinctly wider than the head, alutaceous, minutely reticulate, also finely and closely, granularly punctulate throughout, more strongly than in *pruinosa*, almost evenly convex throughout, the median line very obsoletely and not broadly impressed; sides broadly rounded anteriorly, thence distinctly converging to the base, which is distinctly wider than the apex; elytra nearly as in *pruinosa*; hind tarsi very slender and filiform, fully four-fifths as long as the tibiae, with the basal joint much elongated but not as long as the next two combined; sixth ventral evenly rounded at tip; male not at hand. Length 2.6 mm.; width 0.6 mm. North Dakota (Williston),—H. F. Wickham... **dakotana** n. sp.
- Form very slender, linear, convex, pruinose, black, the elytra but slightly picescent, with a very fine abrupt pale apical margin. *Male* with the head small, orbicular, very convex, not at all impressed, almost imperceptibly and not densely punctulate; antennae extending almost to the middle of the elytra, very slender and only slightly incrassate distally, the second joint much longer than the third, the ninth and tenth not quite as long as wide, the former somewhat the shorter; prothorax about a fifth wider than long, much wider than the head, the sides even'y, circularly arcuate anteriorly and rounding to the apex, which is much narrower than the base, feebly converging and nearly straight from a little before the middle to the base; surface broadly, evenly convex, finely, asperulately, closely and evenly punctulate, with the interstices smooth and polished, the median parts not impressed; elytra fully two-fifths wider and longer than the prothorax, very obsoletely impressed on the suture behind the scutellum, finely, closely and asperulately punctulate, the humeri moderately exposed and rounded, the sides parallel and broadly arcuate; hind tarsi filiform but much shorter than the tibiae, with the basal joint about as long as the next two together; sixth ventral with a rather large triangular and acutely angulate notch nearly as deep as wide; female unknown. Length 2.5 mm.; width 0.42 mm. Missouri (St. Louis — Creve Coeur Lake),—G. W. Bock..... **illini** n. sp.
- 11 — Form moderately slender, rather depressed. *Male* shining throughout, not at all reticulate, the head and posterior half of the abdomen black, the prothorax and elytra piceous-brown, the latter with the

humeri and apex flavate; two basal ventrals bright red, the legs pale honey-yellow, the antennae fuscous, pale toward base; pubescence not conspicuous; head rounded, polished, scarcely perceptibly punctulate, not impressed; antennae nearly attaining the middle of the elytra, moderately incrassate distally, the second joint evidently longer than the third, the subapical joints not quite as long as wide; prothorax rather small, a fifth wider than long, very slightly wider than the head, the sides broadly, evenly rounded anteriorly to the apex, which is much narrower than the base, and feebly convergent and nearly straight from before the middle to the base; surface almost evenly convex, not impressed along the median line but with a very small and feeble rounded impression before the middle of the base; punctulation extremely minute and not very close; elytra about two-fifths wider and longer than the prothorax, finely but closely, asperately punctulate, the humeri rather well exposed; abdomen nearly parallel, much narrower than the elytra but unusually little narrowed from near the apex to the base; hind tarsi much shorter than the tibiae, the basal joint about as long as the next two together; sixth ventral with a small and rather shallow, subangulate emargination at tip. *Female* not at hand. Length 2.7 mm.; width 0.6 mm. Texas (Del Rio). — H. F. Wickham... *ornatella* n. sp.

Form slightly more slender, much more convex, the prothorax relatively much larger and the abdomen very much more strongly narrowed toward base, feebly shining; prothorax and two basal ventrals pale, the head and elytra throughout dark rufo-piceous, the remainder of the abdomen black; legs pale honey-yellow, the antennae fuscous, pale basally; punctures minute and very close-set throughout, subgranuliform on the head and pronotum, the interstices polished on the latter, asperate on the elytra, excessively minute throughout on the abdomen except in the basal depressions; pubescence very close, pale throughout, giving a pruinose effect. *Male* with the head moderate, obliquely and rapidly narrowed at base, convex, not impressed, the antennae short, feebly incrassate, but little longer than the head and prothorax, the three basal joints rapidly diminishing in length, the subapical scarcely as long as wide; prothorax about a fifth wider than long, distinctly wider than the head, the sides rounded anteriorly, thence just visibly converging and broadly, feebly sinuate to the base, convex, scarcely perceptibly and narrowly impressed along the median line posteriorly; elytra nearly as long as wide, convex, about a fourth wider and longer than the prothorax, narrowly impressed on the suture behind the scutellum, the humeri very narrowly exposed; legs very slender, the basal joint of the hind tarsi much elongated though scarcely as long as the next two combined; sixth ventral very broadly and feebly sinuate at tip. *Female* resembling the male in size, coloration, general form, sculpture and vestiture but with the head relatively slightly smaller and the prothorax somewhat shorter and more transverse, both finely reticulate in addition to the punctures and consequently slightly duller in lustre, the latter broadly and deeply impressed along the median line, except at apex and more briefly at base, the sixth ventral broadly rounded at tip. Length 2.4 mm.; width 0.52 mm. California (Yuma)..... *arida* n. sp.

13—Form rather slender, convex, linear, shining, black, the prothorax and first two ventrals dark piceo-rufous; legs and antennae piceous, the basal joint of the latter and the tarsi paler; punctures fine, asperate, only moderately close-set, on the anterior parts excessively minute, on the abdomen dense but less so on the first two tergites; pubescence fine and close but not conspicuous. *Female* with the head rather small, abruptly narrowed at base, the antennae extending to the middle of the elytra, gradually and strongly incrassate distally, the second and third joints much elongated and equal, the subapical joints not quite as long as wide; prothorax much wider than the head but only just visibly wider than long, the sides broadly rounded at apex, thence feebly converging and nearly straight to the base, convex, the punctular interstices polished, not reticulate, broadly, feebly impressed along the middle except at apex, the latter but little more than two-thirds as wide as the base; elytra distinctly wider than long, fully two-fifths wider but scarcely more than a third longer than the prothorax, with an oval sutural impression behind the scutellum, the humeri rather narrowly exposed, rounded; hind tarsi nearly four-fifths as long as the tibiae, the basal joint about as long as the next two combined; sixth ventral broadly rounded at tip; mesosternal process about attaining the metasternum but rather wider than usual, obtusely rounded at tip. *Male* not known. Length 2.4–2.7 mm.; width 0.52–0.6 mm. California (Siskiyou, Napa and Sta. Clara Cos.).....*faceta* Csy.

Form relatively rather broader and less convex than in *faceta*, smaller in size, the antennae, tarsi and mesosternal process similar, rather shining, somewhat pale piceo-rufous, the head and posterior part of the abdomen black; elytra with a fine pale apical margin, the legs and antennae toward base pale testaceous, the latter infuscate distally; pubescence and punctuation nearly as in *faceta*, the asperulate punctures of the pronotum stronger, the very minute punctuation of the abdomen less close-set. *Female* with the head smaller, orbicular, more gradually and arcuately narrowed toward base; prothorax shorter and more transverse, nearly a fourth wider than long and very much wider than the head, the sides rather more strongly rounded anteriorly and thence more strongly converging and nearly straight to the base, the surface moderately convex, very obsoletely and much more narrowly impressed along the median line, unimpressed in apical third; elytra nearly similar to those of *faceta*; sixth ventral rounded at tip. *Male* not at hand. Length 2.35 mm.; width 0.5 mm. California (Los Angeles Co.), — H. C. Fall.....*vespertina* n. sp.

In addition to the above species, which are wholly congeneric with such European types as *constricta*, *coarctata* and *ferealis*, of Erichson, and which may be regarded as representing the true *Tachyusa*, I have before me certain aberrant species forming subgeneric groups of the present genus; these, with the types upon which they are founded, may be briefly indicated as follows:—

General form as in *Tachyusa* but rather stouter, the middle coxae not so closely approximate and with the obtuse but free mesosternal process separated from the rounded projection of the metasternum by a transversely convex and undepressed connecting isthmus; three basal tergites equally deeply impressed at base and coarsely punctured, the punctures transversely crowded, forming fine longitudinal carinae as in *Tachyusa* but without trace of the medial carina of that genus; tarsal claws fully as long and slender but with those of the hind tarsi unequal in length, the inner claw the shorter. Europe. [Type *Tachyusa balteata* Er.]

Tachyusilla n. subgen.

General form and habitus as in *Tachyusa* but with the middle coxae rather less approximate than in the typical forms of that genus, the mesosternal process rather shorter, obtusely rounded at tip, free but nearly or practically attaining the metasternal projection, which is obtusely subtruncate, not flat in a longitudinal direction as in *Tachyusa* but longitudinally concave, the concavity extending as far as the posterior limits of the acetabula, the latter very feebly closed behind; three basal tergites impressed in base as in *Tachyusa* and even more broadly, the coarse punctures not forming longitudinal acute rugae but polygonally and irregularly crowded, without trace of the characteristic medial carina of *Tachyusa*; tarsal claws much shorter than in *Tachyusa* or *Tachyusilla*, those of the hind tarsi equal. South Africa. [Type *T. gemma** Csy.].....**Tachyusota** n. subgen.

There is considerable variety in the form of the mesosternal process in *Tachyusa*, as well as in *Euliusa* and other genera of

* This species may be described as follows from the male:—

Form slender, strongly convex, highly polished throughout, pale rufo-testaceous, the head and the abdomen toward tip black; legs testaceous, the antennae slightly infuscate distally; punctures very minute, asperulate, very sparse, except toward the middle of the pronotum basally and toward the scutellum on the elytra, where they are more close-set; abdomen subimpunctate, the fourth and fifth segments finely but not densely punctate throughout; pubescence not conspicuous; head small, orbicular; antennae rather short, barely attaining basal third of the elytra, rather distinctly incrassate distally, the second joint longer and thicker than the third; prothorax fully as long as wide, scarcely as wide as the head, the sides subangulate anteriorly, thence moderately converging and broadly sinuate to the base, not impressed; elytra large, quadrate, moderately produced posteriorly at the sides, fully four-fifths wider and about two-fifths longer than the prothorax, with a small sutural impression at base, convex, the sides arcuate, the humeri rather widely exposed but rounded; abdomen much narrowed toward base, clavate, very much narrower than the elytra, the first three segments constituting fully three-fourths of its length; legs slender, the basal joint of the hind tarsi as long as the next two combined; sixth ventral with a small, feeble, broadly rounded sinus at tip; female nearly similar to the male. Length 2.15 mm.; width 0.43 mm. South Africa (Wellington).....**gemma** n. sp.

this subtribe, and any statements concerning it are to be taken in a comprehensive sense; it is more constant in relative length and in the approximation of its tip to the apex of the metasternal projection than it is in width, most of the species having the tip acute, but in some, such as *smithi*, *gracillima*, *faceta* and *vespertina*, of America, it becomes wider and obtuse at tip, and, in the European *ferrealis* it is remarkably wide for *Tachyusa* and obtuse at tip, though fully attaining the metasternum without an intervening isthmus.

Gnypetella n. gen.

The very small frail species of this genus recall the more elongate linear forms of *Gnypeta* in general form, but have the middle coxae very approximate, with their acetabula open behind and not closed by a fine beaded edge, the mesosternal process finely acute, free and extending to the middle of the acetabula, where it is separated from the obtuse apex of the short metasternal projection by a very long, narrow, transversely convex isthmus, which is not at all depressed but separated from the metasternum by a subobliterated transverse suture, distinguishable principally by differences in sculpture, the isthmus being wholly punctureless and highly polished. The transverse, elevated, posteriorly rounded plate at the anterior limit of the mesosternum, generally so conspicuous in the Tachyusae and Falagriæ, is rather less developed here than usual. The eyes are unusually small, anterior and not prominent, the neck less than half as wide as the head, the elytra slightly angulate posteriorly at the sides and the hind tarsi much shorter than the tibiae, though with the basal joint unusually elongate and longer than the next two combined. The only two species known thus far may be described as follows: —

Form slender, parallel, moderately convex, polished, pale brownish-testaceous throughout, the abdomen blackish except toward base; punctures of the head and pronotum extremely minute, rather sparse, broadly wanting toward the middle of the former, the elytra more strongly, asperately but not very densely punctured, the abdomen finely, moderately sparsely, the basal impressions somewhat coarsely but not very

densely punctate; pubescence inconspicuous; head large, wider than long, broadly arcuato-truncate at base, the sides parallel, the angles narrowly rounded; antennae short, stout, scarcely longer than the head and prothorax, the first three joints rapidly diminishing in length, the outer joints compact and rather strongly transverse; prothorax about as wide as the head, slightly transverse, the sides broadly rounded anteriorly, thence feebly convergent and less arcuate to the base, the surface with a very small transverse impression before the middle of the base, the latter moderately arcuate; elytra slightly transverse, about two-fifths wider and longer than the prothorax, the suture feebly and broadly impressed in basal three-fifths; humeri somewhat well exposed, slightly rounded; abdomen parallel, distinctly narrower than the elytra but wider than the prothorax, the sides of the fifth ventral converging posteriorly; legs slender; sixth ventral of the female evenly rounded at tip, the male unknown. Length 1.9 mm.; width 0.42 mm. California (Monterey Co.). [= *Tachyusa lat.* Csy.].

laticeps Csy.

Form and coloration nearly similar, the anterior parts and legs rather darker, the abdomen black throughout, almost similarly sculptured, shining; head smaller, but slightly wider than long, similarly arcuato-truncate at base, the antennae nearly similar, but little longer than the head and prothorax, the outer joints still more strongly transverse, compact; prothorax rather more transverse, somewhat wider than the head, the sides much more narrowly rounded anteriorly, thence converging and straighter to the base, the short transverse impression before the scutellum similar; elytra similar in form, with the humeri equally exposed, the impression on the suture behind the scutellum very much shorter, oval; abdomen nearly similar but somewhat broader, the coarse punctuation of the short, deep, transversely linear basal impressions somewhat coarser and closer; sixth ventral of the female broadly, subparabolically rounded at tip, the male not at hand. Length 1.75 mm.; width 0.4 mm. California (Los Angeles Co.).

placidula n. sp.

These species are apparently rare and I have at present before me only a single example of each.

Euliusa n. gen.

In general form and facies this genus resembles *Gnypeta* and it is undoubtedly closely allied, the intermesocoxal structure being much the same, a short isthmus separating the rather short and in general obtusely truncate free tip of the mesosternal process from the metasternal projection, but, posteriorly, there is no trace of the circumambient beaded edge delimiting the acetabula, so well developed and constant in *Gnypeta*. The sculpture is always very feeble and there is

but little diversity in structural characters throughout the genus. The punctures are very minute as a rule and everywhere sparse, the surface highly lustrous, the vestiture rather inconspicuous, the head well developed, with the eyes moderately large in size and somewhat prominent, the antennae slender, with the first three joints elongate, the subapical about as long as wide and the second and third equal or subequal; the neck is from one-half to two-thirds as wide as the head. The prothorax is obtrapezoidal, wider than long, with the hind angles more than right but well marked and not in the least rounded; the elytra are well developed, with very broadly exposed humeri and are but slightly and obtusely produced posteriorly at the sides. The abdomen is broad and rather short, with the first three tergites narrowly but deeply, rectilinearly impressed at base, the impressions subimpunctate, having generally a very few widely and irregularly scattered coarser but feeble punctures. The legs are long and slender, the hind tarsi filiform, with the basal joint usually fully as long as the next two combined and longer than in typical *Gnypeta*. The male sexual characters are virtually uniform throughout and consist of a broadly rounded, very shallow sinuation at the tip of the sixth ventral plate. As in *Tachyusa*, the pronotum is generally impressed along the middle posteriorly in the female and evenly convex in the male, but, in both sexes, there is a short transverse and frequently bifoveate impression before the base, as is generally the case in *Gnypeta*. The genus appears to be local in distribution and confined as far as known to southern California, extending eastward into Arizona. The characters given above being so uniform, no further mention of them will be made, except in certain cases, in the descriptions of the following nine species: —

- Abdomen elliptical in form, widest in the middle and much narrowed at base and apex, the sides evenly arcuate.....2
 Abdomen parallel or very nearly so, the sides of the fifth segment moderately converging from base to apex.....3
 2 — Form rather stout, blackish-piceous in color, the head and entire abdomen black, the legs and antennae pale; head orbicular, rapidly and arcuately narrowed behind the eyes, the punctures larger and

denser than usual but feeble, the median line broadly impunctate; vertex with a deep rounded impression; antennae moderately incrassate distally; prothorax somewhat wider than the head, about a fourth wider than long, the sides obtusely angulate anteriorly, thence rather strongly converging and broadly sinuate to the base, the surface very minutely, sparsely punctulate, narrowly and very obsoletely impressed on the median line behind the centre, the transverse impression large and conspicuous, deeply bifoveate; elytra transverse, about two-thirds wider and a third longer than the prothorax, very sparsely punctulate and convex; abdomen, at the middle, scarcely as wide as the elytra, at base and apex very much narrower; male not at hand. Length 3.2 mm; width 0.78 mm. Arizona.....*majuscula* n. sp.

Form still stouter, piceous-black throughout, the legs and antennae testaceous; punctures very minute and sparse on the head and throughout as usual, those of the abdomen asperulate; pubescence very sparse but rather coarse and pale ashy in color; head somewhat wider than long, the sides behind the prominent eyes parallel for a short distance, then strongly rounded to the neck, the rounded impression of the vertex smaller and feebler than in the preceding species; antennae extending to apical third of the elytra, slender, only moderately incrassate distally, the subapical joints perceptibly shorter than wide; prothorax scarcely wider than the head, about a fifth wider than long, strongly convex, the sides broadly rounded anteriorly, thence moderately converging and straight to the base, the basal impression obscurely and irregularly bi-impressed, the median line impressed for a short distance anteriorly from the transverse impression; elytra strongly transverse, two-thirds wider and two-fifths longer than the prothorax, the humeri very widely exposed, the suture impressed behind the scutellum; abdomen less strongly elliptical than in *majuscula*, in the middle much narrower than the elytra; female not known. Length 2.75 mm.; width 0.75 mm. California (Los Angeles Co.),—H. C. Fall.....*sparsella* n. sp.

- 3—Prothorax distinctly transverse; body stout in form throughout.....4
 Prothorax barely perceptibly wider than long; form somewhat less stout..8
 4—Punctures of the head larger, more approximate and much more conspicuous though impressed and not very deep. Body black, with a slight piceous tinge throughout, the legs and antennae very slender, pale piceo-testaceous; vestiture pale in color; head wider than long, impunctate along the middle, the vertex with a large rounded impression; eyes small; antennae extending to the middle of the elytra, rather strongly incrassate distally, the ninth joint fully as long as wide, the tenth nearly so; prothorax just visibly wider than the head, nearly a fourth wider than long, the sides anteriorly narrowly rounded and prominent, thence rather strongly convergent and broadly sinuate to the base, the surface minutely and almost imperceptibly punctulate as usual, strongly impressed along the middle from apical third, the transverse impression small and feeble; elytra nearly as in *sparsella*, the humeri equally widely exposed, the punctulation almost invisible, the suture narrowly and deeply impressed behind the scutellum; abdomen broad though distinctly narrower than the elytra, the sides

- nearly straight and parallel, the punctulation extremely minute, sparse and not asperulate; male not at hand. Length 2.5 mm.; width 0.68 mm. California (Los Angeles Co.—Pasadena),—A. Fenyés. [= *Gnypta luc.* Bern.].....**lucens** Bernh.
- Punctures of the head and remainder of the body sparse and extremely minute as usual.....5
- 5—Color piceous-black, the abdomen feebly rufescent toward base, the legs and antennae testaceous, the latter infusate distally. Head but little wider than long, the sides subparallel for a short distance behind the eyes, then strongly and obliquely rounded to the neck, the impression of the vertex very small; antennae shorter than usual, extending scarcely to the middle of the elytra, rather incrassate distally, the joints seven to ten shorter than wide; prothorax barely perceptibly wider than the head, the outline and punctulation as in *lucens*, the surface not at all impressed along the middle, the subbasal impression small, with two unusually approximate foveae; elytra two-thirds wider and a third longer than the prothorax, the humeri widely exposed as usual, the suture strongly impressed behind the scutellum; abdomen parallel, the sides straight, converging at tip as usual, very minutely, sparsely punctulate toward base, less minutely, more closely and asperulately toward tip; female not known. Length 2.75 mm.; width 0.7 mm. California (Riverside Co.).....**elsinorica** n. sp.
- Color more or less pale piceo-testaceous, the head and apical parts of the abdomen darker testaceous to blackish; legs pale testaceous, the antennae sometimes infusate distally.....6
- 6—Form very stout. Head and about apical half of the abdomen blackish, the remainder dark piceo-testaceous; antennae pale, gradually infusate distally, extending to about basal third of the elytra, moderately incrassate distally, the ninth and tenth joints slightly shorter than wide; punctures throughout very minute and sparse, closer posterior to the three basal segments of the abdomen but not evidently asperulate; head moderate, the sides converging and almost evenly arcuate from the eyes to the neck; prothorax about a fifth wider than long, very slightly wider than the head, the sides subprominently rounded anteriorly, thence only feebly converging but rather deeply sinuate to the base, the median line not impressed, the subbasal impression moderately large, broadly impressed, not definitely bifoveate; elytra short and strongly transverse, about three-fifths wider and a third longer than the prothorax, with the humeri very widely exposed; abdomen nearly as wide as the elytra, the sides parallel; hind tarsi two-thirds as long as the tibiae; female unknown. Length 2.7 mm.; width 0.8 mm. California (Los Angeles Co.).....**transversa** n. sp.
- Form less stout, the abdomen always much narrower than the elytra....7
- 7—Head and elytra dark, the prothorax and basal half of the abdomen pale, piceo-testaceous, the remainder of the latter blackish; antennae pale, only slightly infumate distally; punctures throughout very minute and sparse, not asperate and moderately close toward tip of the abdomen; vestiture pale but inconspicuous; head rather large, wider than long, somewhat wider than the prothorax in the male, as wide as the latter in the female, the impression of the vertex very feeble; eyes

prominent, the sides behind them feebly converging for a short distance, then strongly rounded to the neck; antennae attaining basal two-fifths of the elytra, rather strongly incrassate distally, the subapical joints not quite as long as wide; prothorax about a fifth wider than long, the sides rather prominently rounded anteriorly, thence only feebly converging but broadly, somewhat strongly sinuate to the base, the subbasal impression rather large and deep, strongly and not very approximately bifoveate, the median line very narrowly and obsoletely subimpressed behind apical third in the male, more broadly and distinctly impressed in the female; elytra moderately transverse, three-fifths wider and two-fifths longer than the prothorax, somewhat less transverse in the female, the humeri broadly exposed; abdomen a third wider than the prothorax; male with the sixth ventral feebly sinuate at tip as usual. Length 2.5 mm.; width 0.7 mm. California (Sta. Clara Co.). [= *Falagria lat.* Csy.]..... **laticollis** Csy.

Head piceous, the prothorax pale, the elytra scarcely darker, piceo-testaceous, the abdomen pale, blackish toward tip; antennae scarcely infusate distally, unusually long, fully attaining apical third of the elytra, distinctly incrassate distally, the ninth joint as long as wide, the tenth very nearly so; punctures minute and sparse throughout, those of the abdomen slightly asperulate toward tip; head orbicular, parallel behind the eyes for a short distance, then obliquely arcuate to the neck, the vertex with a deep rounded medial impression; prothorax barely a sixth wider than long, equal in width to the head, the outline nearly as in *laticollis* but rather more broadly rounded at the sides anteriorly, the median line broadly and strongly impressed in basal three-fifths, the subbasal impression nearly obliterated, forming the basal part of the medial impression; elytra three-fourths wider and nearly one-half longer than the prothorax, the humeri very widely exposed as usual; abdomen unusually narrow, barely a fourth wider than the prothorax, parallel and straight at the sides, slightly narrowing toward tip; legs very slender, the hind tarsi fully three-fourths as long as the tibiae, the basal joint distinctly shorter than the next two combined; claws long slender and equal as usual; male not at hand. Length 2.3 mm.; width 0.7 mm. California (Los Angeles Co.)..... **mollis** n. sp.

Head and elytra rather dark, the prothorax and anterior half of the abdomen pale, brownish-testaceous, the remainder of the abdomen blackish; antennae slightly infumate distally, somewhat short, rather feebly incrassate distally, scarcely extending beyond basal third of the elytra, the four subapical joints slightly shorter than wide; head slightly wider than long, the sides subparallel behind the eyes for a short distance, then strongly, obliquely rounded to the neck, the vertex scarcely impressed in the male, feebly so in the female; prothorax equal in width to the head in the former, slightly wider in the latter, a fifth wider than long, the sides prominently rounded anteriorly, thence moderately converging and broadly sinuate to the base, nearly similar in the sexes and with a large, strongly impressed bifoveolate ante-basal impression which becomes angularly obsolete anteriorly; elytra transverse, much wider and longer than the prothorax, with broadly exposed humeri; abdomen parallel, narrowed slightly at tip, two-fifths or more wider than the prothorax in the male but only about a

- fifth wider than the latter in the female, the male larger as a rule and stouter throughout; mesosternal process somewhat narrower than usual but not acute. Length 2.3-3.0 mm.; width 0.68-0.7 mm. Arizona (Tucson and Riverside..... *pimalis* n. sp.
- 8 — Form only moderately stout, blackish-piceous in color, the prothorax slightly paler, the antennae infusate distally; punctures very minute and sparse throughout; head orbicular, convex, as long as wide, the sides strongly arcuate and converging behind the eyes, with a very small rounded impression at the middle of the vertex in the male which becomes much larger and deeper in the female; antennae extending to the middle of the elytra, distinctly incrassate distally, the two subapical joints slightly shorter than wide; prothorax not quite as wide as the head in either sex, scarcely visibly wider than long, the sides rounded anteriorly, thence rather distinctly converging and feebly sinuate to the base, the surface convex, wholly unimpressed except the distinct bilobate transverse impression before the scutellum in the male, somewhat deeply impressed along the median line from apical two-fifths to the transverse impression in the female; elytra two-thirds wider and a third longer than the prothorax; abdomen similar in the sexes, parallel, distinctly narrower than the elytra; basal joint of the hind tarsi rather longer than the next two combined. Length 2.6 mm.; width 0.65 mm. California (Los Angeles Co.)..... *citrina* n. sp.

A single specimen of *lucens* Bernh., was very kindly given me by Dr. Fenyes. The species is very readily distinguishable by the unusually large and more close-set punctures of the head, this also being a distinctive character in *majuscula*; the mesosternal process of the latter is more acute at tip than in any other species that I have observed but is approached in this respect to some extent by *pimalis*, which is a common form, widely distributed over the more arid parts of Arizona. The abdomen in *pimalis* appears to be notably narrower in the female than in the male, and the same peculiarity may affect *mollis*, which is now represented in my cabinet by a single female having a notably narrow abdomen, but I have not observed this rather remarkable character elsewhere in the genus and it is certainly not true of *laticollis*, although there, as generally in the genus, the male is a trifle stouter than the female. This seems to occur frequently in the Staphlinidae and may be a general rule.

Meronea Shp.

This genus resembles the preceding somewhat in outline

but is composed of very much more minute species, having strong and rather close-set punctures on the head and pronotum and the hind angles of the prothorax somewhat broadly rounded, differing in this way from any *Euliusa*, *Gnyppetella* or *Gnyypeta*, excepting the subgenus *Gnyppetoma*, which is really entitled to full generic rank in all probability. It more closely resembles the genus *Neolara* Shp., where the sculpture is in general similar, the basal angles of the prothorax very obtuse and blunt, but not so distinctly rounded and the intermesocoxal parts similar, but it differs wholly from *Neolara* in the structure of the prosternum before the coxae as stated in the table. The head is nearly as in *Gnyppetella*, broadly arcuato-truncate at base, with distinct rounded angles and the eyes are almost as small as in that genus but much more prominent. The neck is much narrower and the antennae are longer than in any of the allied genera, with all the joints elongate, the first much longer than the second or third, the latter being more or less appreciably longer than the second. The elytra are obliquely truncate at apex rounded but not at all produced at the sides of the apex, in the manner observed in *Tachyusa* and less evidently in *Gnyypeta*. The abdomen is wide, parallel and almost evenly arcuate at the sides, with the first three tergites narrowly, rectilinearly and more or less feebly impressed at base, the impressions impunctate. The short and broadly truncate mesosternal process is not at all free as it is in *Gnyypeta*, *Tachyusa* or *Euliusa*, but is attached by a declining isthmus to the somewhat depressed apex of the long metasternal projection, the structure being almost similar to that of *Neolara*. The legs are long and very slender, the hind tarsi very slender and filiform, about as long as the tibiae, with the basal joint a little longer than the next two combined. We have only the following three species so far as noted:—

- Elytra subparallel, longer than the prothorax.....2
 Elytra with the sides strongly diverging from base to apex, shorter than the prothorax.....3
 2— Form stout, subparallel, convex, shining, the head, and, to a less degree the elytra and the last two or three abdominal segments, piceous to blackish, the prothorax, basal parts of the abdomen, elytral base,

broadly toward the humeri, legs and basal parts of the antennae, more or less pale testaceous; punctures of the head and pronotum rounded, umbilicate, coarse and very close-set, those of the elytra not quite so coarse and less dense, of the abdomen fine, sparse and asperulate, the ground sculpture finely and feebly reticulate in subtransverse lines, of the elytra finely and obsoletely subreticulate, elsewhere smooth; vestiture fine, rather sparse and wholly inconspicuous, each abdominal segment with a transverse series of four coarse erect black setae; head wider than long, fully as wide as the prothorax, convex, unimpressed; antennae distinctly incrassate distally, extending rather beyond the elytral apex; prothorax obtrapezoidal, only very slightly wider than long, the sides prominently rounded at apical third, thence distinctly converging and sinuate to the base, the surface convex, unimpressed in either sex; elytra each with a black seta near the middle of the base, about one-half wider and but slightly longer than the prothorax, the humeri widely exposed; abdomen parallel, with the sides evidently and evenly arcuate, distinctly wider at the middle than the elytra in the male, much narrower than the elytra and with the sides straighter in the female; sixth ventral of the male with arcuately converging sides, the obtuse apex with a small and broadly, evenly rounded sinus about five or six times as wide as deep; female distinctly more slender than the male throughout the body. Length 1.65-1.8 mm.; width 0.4-0.45 mm. Rhode Island, New York and North Carolina (Asheville) to Iowa. [= *Falagria venus*. Er.]..... **venustula** Er.

Form nearly similar to *venustula*, polished, rufo-piceous, the prothorax somewhat paler, the abdomen black, the first two segments, elytral base and humeri, legs and basal parts of the antennae more or less pale flavate; femora piceous, paler toward base; antennae infuscate distally; punctures of the head and pronotum less coarse, more impressed and much less close-set than in *venustula*, those of the pronotum not umbilicate, the elytra not at all reticulate, having rather strong and moderately sparse punctures, somewhat smaller than those of the anterior parts, the abdomen finely, transversely reticulate, finely and sparsely punctulate; pubescence inconspicuous; prothorax similar to that of *venustula* but somewhat narrower than the head, especially in the male; elytra three-fifths wider and nearly a third longer than the prothorax, the humeri widely exposed; abdomen parallel, with feebly and evenly arcuate sides, fully as wide as the elytra in the male and nearly as wide in the female; sixth ventral of the male nearly as in the preceding, the broadly and circularly rounded sinus about six times as wide as deep; female but slightly more slender than the male, with the sixth ventral rather strongly and evenly rounded at tip. Length 1.8 mm.; width 0.48 mm. Texas (El Paso) to Utah (Provo.)..... **montana** n. sp.

3— Body rather slender, polished, similar in sculpture, punctuation and vestiture to *venustula*, the coloration similarly disposed throughout but paler in every part, perhaps from immaturity; prothorax fully as long as wide and as wide as the head, the sides angulate, more obliquely, arcuately rounded anteriorly from apical two-fifths to the neck, otherwise as in *venustula*, the median line narrowly and obsoletely impressed behind the middle, the impression not attaining the base; elytra strongly

transverse, distinctly shorter than the prothorax, the apices much more oblique than in *venustula*, the punctures less close-set; abdomen similarly parallel with arcuate sides, about as wide as the elytra in the male, the sixth ventral in that sex obtuse and feebly sinuate as in *venustula*, the sinus about a third as wide as the apex and very shallow. Length 2.0 mm.; width 0.43 mm. New York (Catskill Mts.), — H. H. Smith.

obliqua n. sp.

It will be noticed that the feeble and broadly rounded sinus of the sixth ventral is almost exactly similar to that of the genus *Euliusa*, and that the narrower form of the female and especially the narrower abdomen of the latter sex, is also a peculiarity noted in several species of that genus. *Obliqua* is represented by a single specimen, but it certainly differs very much from *venustula* in the form as well as in the abbreviation of the elytra, and very noticeably in the form of the prothorax. I have assumed *venustula* as the type of *Meronera*, as it was assigned to that genus by its founder, and was the first species described. It is abundant throughout the northern Atlantic regions.

Subtribe **Falagriae.**

The Falagriae differ from the Tachyusae in having the prosternum under the coxae corneous and not membranous. This chitinous lining is not a posterior extension of the ante-coxal part of the prosternum, but is composed of two plates that take their origin at the sides posteriorly, beginning as small plates surrounding the spiracles. These plates develop inwardly and finally meet on the median line. They are very variable in extent in the several genera, usually complete, meeting on the median line and extending to the ante-coxal part, in such cases wholly protecting the membrane so largely exposed in the Tachyusae, but, in other genera, they may not quite meet throughout on the median line, their rounded internal margins leaving a triangular piece of exposed membrane adjoining the ante-coxal part of the prosternum, and, in one genus, the plates are very small, leaving most of the membrane exposed. The Pacific coast fauna is very poor in representatives of the Falagriae, and it is remarkable that in the

only two genera that do occur there, the subcoxal plates are incomplete as well as imperfectly chitinized.

The Falagriæ are very small beetles as a rule, of slender and graceful form, with much narrower neck than in the Tachyusæ, long and generally slender legs with filiform tarsi, the posterior usually having a greatly elongate basal joint, and the pronotum is always narrowly and acutely impressed along the median line, sometimes broadly, deeply and conspicuously but in other genera very feebly or obsoletely. The singular sexual differences in the pronotal impression, and sometimes in sculpture as well, prevailing in some of the genera of the Tachyusæ, are apparently not observable in the Falagriæ, but there are some analogous though very feeble characters at the apex of the sixth ventral plate, so slight however that they will not be noticed in the descriptions of the species except in certain instances. The first three tergites are rectilinearly impressed at base, but there is never a trace of the carina so developed in *Tachyusa*, and the abdomen is always rather wide, parallel and never narrowed toward base as it is in some of the genera of the preceding subtribe; the elytra, also, are never more than very feebly produced or subangulate at the sides of the apex. The genera may be defined as follows: —

- Flanks of the pronotum broadly convex and strongly inflexed, narrowing the prosternum, the hypomera not delimited from the flanks; middle acetabula more or less well defined throughout by a beaded edge; prosternum wholly corneous under the coxæ..... 2
- Flanks feebly inflexed, the prosternum normally broad, the hypomera delimited at the sides, usually but not always by a beaded edge; middle acetabula always widely open behind, never having a trace of beaded edge; mesosternum never carinate..... 3
- 2 — Middle acetabula well separated, surrounded throughout by a fine strong beaded edge, deep, with abruptly steep walls throughout, the mesosternum elevated in median third, more strongly anteriorly, the surface perfectly flat and without trace of carina, the process very short, not extending much beyond anterior fourth of the acetabula, squarely truncate at tip, the latter not in the least free but joined to the longer and equally wide, flat and transversely truncate tip of the metasternal projection by a short flat isthmus on the same level as the apices; prosternum before the coxæ defined externally and internally by similar posteriorly cusped beaded edges; neck nearly a third as wide as the head, the latter arcuato-truncate at base with evident angles, the eyes

- rather small, the occiput impressed, the antennae moderate in length, thick; prothorax without ante-basal impression; scutellum flat, not modified; hind tarsi much shorter than the tibiae, the basal joint longer than the next three combined. Europe and America — by recent introduction..... **Cardiola**
- Middle acetabula equally well separated, but, posteriorly, merging by a long gentle slope into the metasternal surface, its limits there not at all well defined by a subobsolete beaded edge, the mesosternum not at all broadly elevated but with a narrow and strongly elevated carina, extending throughout the length to the truncate tip of the process, which extends nearly to the middle of the acetabula and there meets on the same level the truncate tip of the equally elongate metasternal projection; prosternum before the coxae moderate, its external posterior line very obtusely subangulate, the internal acutely cusped; head, eyes and antennae nearly as in *Cardiola*, the prothorax also of similar form, not transversely impressed before the base; scutellum elongate, coarsely, densely sculptured, transversely convex; hind tarsi much shorter than the tibiae, the basal joint not quite as long as the next three combined. Europe.....***Lophagria**
- 3 — Mesosternum on a superior plane, throughout its width, to the metasternum and connecting isthmus, its posterior line broadly cusped at the middle; prosternum wholly corneous under the coxae. Middle coxae widely separated, the mesosternum broad and wholly unmodified, the process projecting from the foot of the cliff forming its hind margin, more or less abbreviated and broad, entering between the coxae for a variable but generally short distance, its surface transversely elevated in the middle, its apex angularly protruding into the emarginate apex of the long broad metasternal projection, which is transversely convex; there is apparently a closely amalgamated connecting isthmus of varying form; prosternum before the coxae moderately long, its exposed part flat, with its hind margin strongly and acutely cusped in the middle; head arcuato-truncate, the neck very slender, the eyes moderate, the antennae very stout, with the last joint unusually short, much shorter than the two preceding combined; prothorax not transversely impressed before the base, the hypomera not delimited from the pronotum by an entire beaded edge, broadly constricted behind the coxae; scutellum granularly sculptured, sometimes channeled along the middle; legs long but unusually stout, the basal joint of the hind tarsi much shorter than the next three combined and decidedly thicker, the latter equal among themselves. Nearctic North America.....**Chitalia**
- Mesosternum not on a superior plane to the metasternum and wholly unmodified on its surface..... 4
- 4 — Corneous plates under the anterior coxae uniting on the median line. 5
- Corneous plates very small and rudimentary, covering only a small part of the exposed membrane around the spiracles.....11
- 5 — Hypomera sharply delimited from the pronotum by an entire beaded edge..... 6
- Hypomera not delimited by an entire beaded edge, though definable, as in *Chitalia*, by differences of sculpture.....10
- 6 — Hypomera but slightly dilated at the middle, long and narrow in outline.

- Middle coxae moderately separated, the mesosternal process projecting between them nearly to the middle, parallel-sided, rounded and more or less free at tip, separated from the mesosternal projection by a short and generally somewhat depressed isthmus; prosternum moderate before the coxae, the posterior acute edge of the exposed portion finely cusped at the middle, its surface more or less tumid at the middle near the cusp; head more or less rounded at base, the neck very narrow, the eyes moderate, prominent, the antennae very long, moderately stout, the last joint subequal in length to the two preceding combined; prothorax very strongly narrowed toward base, not transversely impressed before the latter; scutellum more or less densely sculptured, frequently finely carinate along the middle; legs rather slender, the hind tarsi filiform, much shorter than the tibiae, with the basal joint almost as long as the entire remainder. Nearctic North America **Lorinota**
- Hypomera shorter, relatively much more dilated at the middle..... 7
- 7 — Mesosternal process free, rather long, obtusely rounded and extending about to the middle of the coxae, where it is separated from the metasternal projection by a short depressed isthmus; middle coxae moderately separated. Body parallel; prosternum rather short before the coxae, flat, the posterior margin cusped at the middle; head arcuato-truncate at base, with evident rounded angles, the neck more than a fourth as wide as the head, the eyes rather small; antennae very thick, the outer joints strongly incrassate and compact, the last stout, ogival pointed, not as long as the two preceding combined; prothorax rather short, strongly narrowed toward base, deeply sulcate, the sulcus ending posteriorly in a small rounded simple enlargement; scutellum nearly flat, granularly sculptured; elytra well developed, with widely exposed humeri as usual; abdominal impressions narrow, deep, acutely impressed, somewhat coarsely but sparsely punctured; legs moderate in length, stout, the hind tarsi much shorter than the tibiae, with the basal joint as long as the next three combined, the latter equal among themselves. Europe.....***Falagrioma**
- Mesosternal process not free, its truncate apex joining the metasternal projection with or without a short and feebly defined isthmus, all on virtually the same level throughout.... 8
- 8 — Scutellum acutely and strongly bicarinate; body moderately small in size. Form somewhat stout and convex as a rule, middle coxae only moderately separated, the mesosternal process attaining the middle of the acetabula, rounded at tip and separated from the obtuse tip of the shorter metasternal projection by a distinct isthmus, which is delimited from the metasternum by a fine, frequently irregular suture; prosternum short before the coxae, with the median part of the exposed surface deflexed and very obtusely rounded posteriorly; head arcuato-truncate at base, with rounded angles, the neck very narrow, the eyes small, slightly prominent, the antennae moderate in length, rather stout, incrassate distally, the eleventh joint not as long as the two preceding together; prothorax very strongly narrowed toward base, deeply sulcate, the sulcus not enlarged basally, the disk with a fine arcuate and transverse impressed line before the base; elytra with widely exposed humeri; abdominal impressions with a single series of coarse punctures;

- legs rather short, moderately slender, the hind tarsi fliform, much shorter than the tibiae, with the basal joint somewhat longer than the next three together, the latter diminishing slightly and gradually in length. Nearctic and Palaearctic regions..... **Falagria**
 Scutellum without trace of carination, flat; body minute in size, moderately stout and convex.....9
- 9 — Middle coxae more widely separated than in *Falagria*, the process extending about to the middle of the acetabula, rectilinearly truncate and separated from the metasternal projection by a similar short isthmus joining the latter by a very fine suture; prosternum before the coxae nearly as in *Falagria* but more narrowly produced and less broadly rounded at the middle posteriorly; head truncate at base with very distinct and narrowly rounded angles, the neck wider than in *Falagria*, nearly a third as wide as the head, the eyes similarly small and prominent, the antennae rather short, rapidly incrassate distally, with the subapical joints strongly transverse, the eleventh large, as long as the two preceding combined, obtusely pointed; prothorax short, much more feebly narrowed behind, the surface very finely and obsoletely impressed along the median line but with a distinct short transverse impression before the base; scutellum with large, approximate and feebly elevated granulation, the elytra with widely exposed humeri; legs rather short and slender, the fliform hind tarsi slightly shorter than the tibiae, with the basal joint shorter than the next three combined, the latter equal among themselves. Europe.....***Melagria**
 Middle coxae still more widely separated, the mesosternal process wide, truncate at tip, extending to about the middle of the acetabula, where it meets the equally broad metasternal projection in a simple transverse suture, without intervening isthmus; prosternum moderate before the coxae, its hind margin with a broad cusp point at the middle, the cusp not at all rounded; head arcuato-truncate at base and with distinct rounded angles, the neck very narrow, barely a fourth as wide as the head, the eyes well developed, prominent; antennae moderately long, not very strongly incrassate distally, the tenth joint much longer than the ninth and but slightly wider than long, the eleventh shorter than the two preceding combined, ogival and acutely pointed; prothorax small as in *Melagria*, much less narrowed at base than in *Falagria*, acutely and deeply sulcate, the sulcus ending posteriorly in a small deep fovea scarcely wider than the sulcus; surface not impressed before the base; scutellum as in *Chitalia*, sparsely and acutely granulose, the granules sometimes parted along the middle; elytra with widely exposed humeri; abdominal impressions subimpunctate; legs rather short but slender, the hind tarsi very slender, fliform, much shorter than the tibiae, with the basal joint fully as long as the next three combined. Nearctic America.....**Leptagria**
 10 — Body very minute, parallel, rather strongly depressed, the middle coxae somewhat narrowly though distinctly separated, the mesosternal process extending about to the middle, arcuato-truncate at tip, meeting the transversely convex metasternal projection on the same plane at a rather fine suture and without intervening isthmus; prosternum before the coxae moderate, its hind margin broadly angulate, the angle

rounded; head large, quadrate, sinuato-truncate at base, the angles very distinct and narrowly rounded, the neck very slender, scarcely a fourth as wide as the head, the median line deeply impressed at and anteriorly to the middle, the eyes small, rather finely faceted; antennae moderate in length, the second joint very much longer as well as thicker than the third; prothorax small, only moderately narrowed at base, finely, feebly impressed along the median line throughout the length, the surface not transversely impressed before the base; side margins acute, marked by larger punctures bearing stiff setae but not beaded; scutellum feebly sculptured, flat; elytral humeri moderately exposed; abdominal impressions impunctate; legs rather short, slender, bristling throughout with sparse erect setae; hind tarsi filiform but very short, the basal joint not longer than the next two combined, two to four subequal, rather short; claws well developed, somewhat strongly arcuate. Florida..... **Aneurota**

Body only moderately small in size, much stouter, convex, not parallel, the anterior parts much narrower than the hind body; middle coxae moderately separated, the mesosternal process extending fully to the middle, its tip arcuate, slightly free and separated from the correspondingly sinuate apex of the shorter, transversely convex metasternal projection by a very short, scarcely depressed isthmus; prosternum moderate before the coxae, its hind margin broadly angulate, the angle slightly rounded, the corneous plates under the coxae thinner and paler than usual, their inner margins arcuate, attaining the median line posteriorly but leaving a small triangle of membrane exposed anteriorly; head rounded behind, convex, the median line not impressed, the neck very slender, scarcely more than a fifth as wide as the head; eyes rather small, but slightly prominent; antennae long, gradually and slightly incrassate distally, the second and third joints long, subequal, the subapical not transverse but compactly joined, the eleventh not quite as long as the two preceding combined, pointed; prothorax only moderately narrowed at base, convex, acutely sulcate along the median line except at apex, the sulcus ending posteriorly in a large deep fovea, which is sometimes transverse, the surface also sometimes transversely impressed near the basal margin; scutellum flat, acutely granulose; elytral humeri very widely exposed; abdominal impressions subimpunctate; legs long, very slender, the hind tarsi almost as long as the tibiae, the basal joint as long as the next three combined, the latter successively decreasing in length; claws slender, moderately arcuate. Pacific coast of America.

Lissagria

11 — Form much more slender than in *Lissagria*, convex, the middle coxae more or less narrowly separated, the mesosternal process extending to the middle, sometimes parallel-sided and very narrow but varying somewhat, the apex arcuate, free and separated from the short metasternal projection by a long, transversely and strongly convex, more or less distinctly depressed isthmus; prosternum before the coxae moderate in extent, its hind margin on the exposed surface broadly and obtusely angulate, the angle rounded; on the inner or subcoxal edge it is strongly and acutely cusped at the middle; head rounded at base, the neck about a fourth as wide, the eyes moderate, not at all prominent,

the surface very feebly and finely impressed along the median line toward base; antennae rather long but strongly and gradually incrassate distally, the first three joints subequal in length, the subapical slightly transverse, equal in length, the eleventh about as long as the two preceding combined, pointed; prothorax only moderately narrowed toward base, very finely and rather feebly impressed along the median line, not transversely impressed before the scutellum, the sulcus ending posteriorly in a very slight enlargement; hypomera as in *Falagria*, clearly delimited from the pronotum by an entire beaded edge; elytra large or small, the humeri more or less widely exposed; scutellum flat, granularly sculptured; abdominal impressions moderately and not densely punctured; legs slender, the hind tarsi long, slender and filiform, the basal joint much elongated, the next three rapidly decreasing in length. Pacific coast of America..... **Falagriota**

The succession of genera in the above table seems to be fairly in accordance with natural affinities. The first three genera and *Aneurota* are highly specialized types, without any close allies, *Cardiola* differing from any other genus of the subtribe in its deep mesocoxal cavities, which are very abruptly excavated on all sides; *Lophagria* is wholly peculiar in its strongly carinate mesosternum and *Chitalia* differs from any other in the uniform elevation of the entire mesosternum above the surfaces posterior thereto. *Aneurota* is wholly isolated in tarsal structure and in general habitus. The small subcoxal plates of *Falagriota*, which comes last in the series, may be either rudimentary or vestigial. I incline to the opinion that we have here a case of arrested development, due to some obscure environmental condition, basing this supposition upon the hypothesis that the archetypes of the present subtribe came into being somewhere within the nearctic regions and migrated to Europe by way of Greenland. Such of the original stock as found its way to the Pacific coast has, for some undiscoverable reason, lagged behind in development and has remained in an almost primitive condition as far as the subcoxal plates are concerned, constituting to-day the genus *Falagriota*. The genus *Lissagria*, also inhabiting the Pacific coast regions, has progressed materially further than *Falagriota* in the development of these singular protective plates, but is still somewhat behind the present standard of other faunal regions. The foreign genera indicated above are the following: —

LOPHAGRIA n. gen. — This genus belongs to the *Cardiola* type in general structure, particularly of the prothorax, but differs in the posteriorly open middle coxae, a character common to all the genera following in the table and is wholly isolated in the carinate mesosternum. In no other instance, either in the Falagriæ or Tachyusæ known to me, is there the slightest trace of the carinate median line of the mesosternum which is so strongly and completely developed in *Lophagria*. The genus is founded upon a species sent to me by Mr. Reitter under the name *Falagria subaenea* Epp., taken at Taschkend.

FALAGRIOMA n. gen. — The type of this genus and the only species at present assignable to it as far as known to the writer, is the common *Falagria thoracica* Curt., a specimen from the region of the Caucasus being now at hand. It is distinguishable at once from the true *Falagria* by the free mesosternal process, simple and flat scutellum and other characters as stated in the table. The antennæ and legs are unusually thick, the prothorax rather short and broad and somewhat strongly narrowed at base; the elytra are moderately developed, having close-set granuliform sculpture toward the scutellum, which is flat and covered with distinctly separated, abruptly elevated minute tubercles, the sculpture of these parts being almost exactly as in *Chitalia*. The impressions of the abdomen are deep and almost sculptureless, having only a few remotely and unevenly spaced, moderately coarse punctures.

MELAGRIA n. gen. — This genus is one of the allies of *Falagria*, having a nearly similar structure of the intermesocoxal parts, but is composed of more minute species, having the scutellum flat and wholly devoid of any trace of the two very prominent parallel carinae of that genus; it also has a smaller and more abbreviated prothorax, less narrowed at base and with obsolescent median sulcus, the impression before the base, wanting in *Falagria*, being large and deep. Its species are apparently rather numerous and those in my cabinet are identified for me by Mr. Reitter under the names *Falagria nigra* Grav., *laevigata* Epp., and *jonica* Reitt.

Cardiola Rey.

The occurrence of this genus in America is probably due to recent fortuitous importation and it is by no means certain that it has established itself. It is one of the more isolated of the Falagriæ, as may be readily conceived by a glance at the characters given in the table, and is not in any sense a subgenus of *Falagria*. In the present subtribe the bottom of the middle coxal cavities slopes gently upward posteriorly, merging gradually into the metasternal surface behind in all the genera except *Cardiola*, where the cavities are abruptly deep and with steep walls on all sides as before stated, and their edges are still more sharply defined throughout by a fine but strong bead, causing the metasternal projection to be abruptly limited at the sides, the latter condition not elsewhere observable except in *Lophagria*. The single species may be defined as follows: —

Form rather stout, convex, highly polished, dark rufo-testaceous, the head and abdomen behind the second segment blackish; legs and antennae pale; vestiture rather long and coarse, decumbent, yellowish in color and distinct but not conspicuous; punctures of the head, pronotum and elytra extremely minute, sparse and indistinct, the elytra not more strongly sculptured toward the scutellum, the latter minutely but acutely, not densely granulose; abdomen closely and more coarsely, asperately punctate, coarsely toward base, finely posteriorly, the impressions with more or less sparse and coarse punctures; head small, the very large, deep subbasal impression impunctate; antennae extending to the middle of the elytra, the subapical joints equal in length, moderately transverse, the second and third equally elongate; prothorax small, slightly wider than the head, somewhat wider than long, the sides arcuately and rather strongly converging to the base, the medial impression broad and shallow, obsolete at apex and in about basal two-fifths; elytra transverse, fully four-fifths wider and two-fifths longer than the prothorax, convex, the humeri very widely exposed, the sides slightly diverging from the humeri, broadly and distinctly arcuate; abdomen narrower than the elytra, the sides parallel and straight, the border thick. Length 2.6 mm.; width 0.65 mm. Pennsylvania (Mt. Airy); common in Europe.....**obscura** Grav.

The single American example before me is wholly identical in every way with the European, indicating that, like *Eulissus fulgidus* Fab., to be subsequently described, it is a recent

importation and not native. It may be put down as a truism beyond cavil, that every endemic American species of Coleoptera is distinct from any European species, however closely they may approximate in general form. The early representatives of American or European species, migrating through land connections by way of Alaska or Greenland, have all been modified in such degree as to be specifically distinct at the present day. The occurrence of recent importations is usually sporadic and in the neighborhood of ports of entry and very few recent importations to either continent from the other have become widely diffused, except some generally destructive species of unusual adaptability and a relatively limited number that are well known to be cosmopolitan and so continually subject to transportation throughout the world in commercial ships. A recognition of this truth, which can be easily demonstrated to any careful observer, would have saved many harmful and misleading errors in our recent faunistic catalogues, notably that of the late Dr. Hamilton on the Coleoptera common to Europe and America, which is in considerable part erroneous. In a conversation with Mr. S. H. Scudder, of Cambridge, Mass., I was informed that the facts stated above in regard to the Coleoptera were equally true even of the Macrolepidoptera.

Chitalia Shp.

This remarkable genus was founded by Dr. Sharp upon a few species belonging to the Sonoran province of the nearctic fauna of Mexico, but it proves to be one of the most widely disseminated types of North American Falagriæ. It is also completely isolated in its structural characters as previously stated. The small, clearly separated, acutely elevated granules of the scutellum are frequently parted along the middle, giving rise to the channel mentioned by LeConte in describing *Falagria scutellaris*, but there is seldom any trace of a true indentation of the scutellar plate, and the character is moreover rather inconstant, except in those species in which it is strongly developed; in *bilobata*, for example, a very narrow parting may

be observed in some individuals, which is barely traceable or obsolete in others; there is never any trace of the medial carinule of *Lorinota*. The middle coxae are more widely separated and the mesosternal process shorter than in any other genus of the subtribe; the coxae are, in fact, very remote in some species. The elevation of the entire mesosternum above the metasternum and intermesocoxal parts is entirely peculiar to *Chitalia*. The antennae are rather long and thick, the last joint notably short and stout, the subapical joints compactly joined but variable in form. The prothorax is not only strongly narrowed at base but broadly and sinusously constricted behind the widely inflated anterior part, and the surface sloping toward the profound median sulcus is frequently closely granulose, this peculiar sculpture appearing also, in very minute form, on the basal parts of the elytra toward the scutellum. The sculpture of the abdominal impressions varies a good deal and gives opportunity for a division of the species as follows: —

- Punctures of the abdominal impressions very coarse and closely, polygonally crowded..... 2
- Punctures of the impressions coarse but smaller, rounded and always clearly separated; species smaller in size, the prothorax relatively much smaller and less inflated at the sides anteriorly, the head more truncate at base..... 7
- 2 — Large punctures of the abdominal impressions shallow, with flat floors which are densely and minutely punctulate. Form rather stout, convex, shining, pale brownish-testaceous in color with feeble subaeneous reflection, the head slightly darker, the abdomen behind the third segment clouded with blackish; legs and antennae pale; vestiture inconspicuous; punctures of the head fine but distinct, sparse, those of the pronotum finer and sparse but becoming larger, closer and granose toward the sulcus except at apex, of the elytra very minute, sparse and inconspicuous, finely granulose and close toward the scutellum, of the abdomen sparse, fine and less sparse apically, strongly asperate toward base; head parallel at the sides with broadly rounded basal angles, the surface feebly impressed on the median line of the occiput; antennae thick, extending about to the end of the elytra, moderately incrassate, the subapical joints slightly wider than long, the tenth slightly longer than the ninth, the eleventh very short, stout and oval, the third much elongated, longer than the second, the latter as long as the first but thinner; prothorax fully as wide as long, somewhat wider than the head, the sides anteriorly strongly rounded, prominent, thence very strongly converging and strongly sinuate to the base, the sulcus deep, widely im-

pressed, acute at the bottom, not extending quite to the apex or base; elytra wider than long, two-fifths to two-thirds wider than the prothorax and about a third longer, convex, the suture finely and deeply impressed for a short distance behind the scutellum, the latter with a narrow entire canaliculiform parting of the granulation; humeri widely exposed, obliquely rounded; sides more arcuate posteriorly; abdomen distinctly narrower than the elytra, with parallel and feebly arcuate sides; legs long, moderately stout. Length 3.5 mm.; width 0.8-0.88 mm. New Mexico (Gallup).....*intricata* n. sp.

Large punctures of the impressions much deeper, with less extended and simple floors, or, never having more than a trace of minute punctulation..... 3

3—Scutellum distinctly and apparently constantly channeled along the middle..... 4

Scutellum transversely convex basally, evenly granulose throughout, or never with more than a very fine inconstant, incomplete or fugitive channeling..... 6

4—Color blackish, the apex of the abdomen and legs testaceous, the antennae fuscous. Form attenuate, the vestiture fine, subsericeous; prothorax ovate, very strongly narrowed behind, deeply canaliculate, longer than wide, densely punctulate; scutellum distinctly channeled; elytra convex, not at all punctulate; abdomen finely punctate. Length 3.5 mm. New York (Coney Island). [= *Falagria scut.* Lec.].

scutellaris Lec.

Color black or blackish throughout, the tip of the venter not paler; elytra very minutely but evidently punctulate..... 5

5—Form stout, convex, the surface polished, piceous-black throughout, the legs dark testaceous, the antennae blackish, paler at base; vestiture short, fine, sparse and inconspicuous; head convex, wider than long, arcuato-truncate at base with widely rounded angles, the sides parallel, the punctures fine, sparse but distinct; eyes rather large; occiput feebly impressed along the median line; antennae extending fully to the end of the elytra, thick though only feebly incrassate distally, all the joints elongate, the tenth distinctly elongate and two-thirds as long as the eleventh, somewhat longer than the ninth, the third much longer than the first or second; prothorax large, somewhat wider than long, rather distinctly wider than the head, the sides anteriorly circularly rounded to the neck, abruptly, strongly converging and sinuate thence to the base, the sulcus acute and deep, not attaining base or apex, the surface broadly flat and gently sloping toward the sulcus and densely and strongly granulose almost throughout; scutellum sparsely and strongly granose, with a strongly marked, somewhat impressed median channel; elytra transverse, fully three-fourths wider but scarcely more than a fourth longer than the prothorax, convex, the sides more arcuate posteriorly, the humeri widely exposed but somewhat oblique, the punctures very fine and sparse, close and granuliform toward the scutellum, rather distinct; abdomen narrower than the elytra, parallel, sparsely punctulate, the punctures coarser and more asperate basally; middle coxae very remotely separated, the mesosternal process projecting more than usually between the coxae, with the transverse suture

strongly sinuous. Length 3.1 mm.; width 0.85 mm. Mississippi (Vicksburg).....*granulosa* n. sp.

Form rather less stout, convex, polished throughout, similar in coloration to the preceding species, the prothorax and basal segments of the abdomen faintly rufo-piceous; vestiture very fine, sparse and inconspicuous; head and antennae nearly as in *granulosa*, the sparse punctulation finer and scarcely visible, the occiput not at all impressed at the middle, the third antennal joint but little longer than the second, the ninth and tenth similarly elongate; prothorax smaller, about as long as wide, equal in width to the head, the sides circularly rounded to the neck from just before the middle, thence less abruptly but equally strongly converging and sinuate to the base, the surface very finely, sparsely punctulate throughout, becoming granulose only near the posterior end of the equally deep and similar sulcus, the surface adjoining the latter not broadly flattened but strongly convex; scutellum sparsely granose, the granules more narrowly parted along the middle, forming a narrower channel which is not at all impressed; elytra less transverse, four-fifths wider than the prothorax and a third longer, otherwise similar in form and finely, deeply impressed on the suture for a short distance behind the scutellum, the punctulation much finer and everywhere sparse, the granulation toward the scutellum extremely fine, sparse and scarcely distinct even under high power of the hand lens; abdomen and intermesocoxal parts nearly similar, the hind tarsi scarcely two-thirds as long as the tibiae. Length 3.2 mm.; width 0.76 mm. Mississippi (Vicksburg).....*illustris* n. sp.

6 — Form stout, convex as usual, shining, piceous-brown in color, the head and abdomen slightly darker; legs and antennae pale throughout; vestiture rather coarse and distinct but short and decumbent; head wider than long, the basal angles very broadly rounded, the punctures fine and sparse, subasperate on the occiput, the latter not impressed; antennae extending fully to the end of the elytra, stout, feebly incrassate and compact, the subapical joints fully as long as wide and subequal, the third much longer than the second; prothorax about as wide as the head and as long as wide, the sides rounded and inflated anteriorly, strongly, abruptly converging and broadly sinuate thence to the base, the surface finely, sparsely punctulate, the punctures becoming close and granose throughout the length on the convex slopes of the sulcus, the surface at the sides near the base obliquely and linearly impressed; base sinuate, fitting over the scutellum, the latter densely granulose and opaque, paler in color, the granules finely parted along the middle, the channel inconstant and unimpressed; elytra wider than long, large, of the usual form, the punctures very fine, dense and granuliform toward the scutellum; abdomen as in *granulosa* but more densely punctulate posteriorly, the punctures similarly coarser, asperate and very sparse toward base. Length 3.1 mm.; width 0.8 mm. Ohio and Michigan. [= *Aleochara bil.* Say].....*bilobata* Say

Form much less stout, shining, dark rufo-piceous, the head and posterior parts of the abdomen darker, the first three segments of the latter and the legs pale testaceous; antennae blackish, paler toward base; pubescence very fine, inconspicuous; head rather larger than in *bilobata*,

slightly wider than the prothorax and less rounded at base, similarly punctate, the antennae shorter and thicker, extending to the middle of the elytra, more incrassate distally, the subapical joints evidently transverse, the tenth somewhat longer than the ninth, the third longer than the second as usual; prothorax of the usual form, fully as wide as long, medially sulcate and impressed at the sides of the base as in *bilobata* but with the surface at each side of the sulcus flatter, though similarly densely granulose throughout the length, the granules gradually smaller and feebler anteriorly; scutellum acutely and somewhat closely granose, the granules not parted along the middle but tending to form irregular longitudinal lines throughout; elytra smaller than in *bilobata* but similarly sculptured, about three-fourths wider and a third longer than the prothorax; abdomen nearly as in *bilobata*; intermesocoxal parts less punctate. Length 3.0-3.5 mm.; width 0.75 mm. Canada (Ottawa), — W. H. Harrington.....*canadensis* n. sp.

Form nearly similar to *canadensis*, polished piceous-black throughout, the legs pale red-brown, the antennae dusky, paler toward base; vestiture fine, not very conspicuous; head rather large and about as wide as the prothorax in the male, decidedly smaller and not as wide as the latter in the female, broadly arcuato-truncate at base, the angles broadly rounded, the punctures very minute and sparse; antennae longer and more slender than in *canadensis*, nearly as in *bilobata*, the subapical joints fully as long as wide to a little longer; prothorax as long as wide, of the usual form, the sides abruptly and strongly converging and sinuate posteriorly to the base, the sulcus deep as usual, the granules nearly as in *bilobata*, except that they grow rapidly finer and sparser exteriorly and apically; scutellum granulose, the granules not parted along the middle; elytra and abdomen as in the two preceding species. Length 2.8-3.1 mm.; width 0.7 mm. Iowa to New Jersey.

***nigrescens* n. sp.**

7—Body much smaller in size than in the preceding species, stout, moderately convex, polished, pale rufo-testaceous, the head and abdomen slightly darker, the legs and antennae pale throughout; pubescence inconspicuous; head large, wider than long, parallel and straight at the sides, rectilinearly truncate at base, the angles rather narrowly rounded; eyes moderate in size; surface not impressed, minutely, sparsely punctulate, the antennae shorter than in the preceding section, stout, extending to about basal third of the elytra, moderately incrassate distally, the subapical joints distinctly transverse, the second and third equal; prothorax fully as wide as long, much narrower than the head, the sides prominently rounded anteriorly, thence not abruptly but strongly convergent and straight to the base, not sinuate as in the preceding section; surface very minutely, sparsely punctulate, more strongly and closely on the convexity at each side of the deep median sulcus, having also a small fovea at each side near the base; scutellum flat, sparsely granose, the granules widely parted along the middle; elytra three-fourths wider and about a third longer than the prothorax, very sparsely, almost invisibly punctulate, more evidently and subgranularly toward the scutellum, the humeri widely and obliquely exposed, the suture impressed narrowly and deeply behind the scutellum, the sides more

arcuate posteriorly; abdomen parallel, arcuate at the sides, in the middle fully as wide as the elytra, minutely and very sparsely punctulate throughout, the impressions with numerous coarse and unevenly distributed punctures. Length 2.2 mm.; width 0.55 mm. Florida. [= *Falagria part.* Lec.].....**partita** Lec.

Body equally small but broader posteriorly, the head and prothorax relatively narrower, the elytral humeri more broadly exposed, polished, similar in coloration and vestiture throughout; head transverse, inflated toward the truncate base, the hind angles more broadly rounded, the punctures extremely minute and sparse; antennae stout, very strongly incrassate distally, but little longer than the head and prothorax, the subapical joints strongly transverse; prothorax small, as long as wide, very much narrower than the head, formed nearly as in *partita*, the sides somewhat sinuate and very strongly convergent toward base, the punctulation throughout excessively fine and sparse, scarcely at all closer or more distinct on the convex slopes of the deep median sulcus; scutellum closely granose, the granules parted along the middle as in the preceding; elytra fully four-fifths wider and about two-fifths longer than the prothorax, similarly sculptured and with the suture conspicuously impressed behind the scutellum; abdomen parallel with the sides feebly arcuate, at the middle fully as wide as the elytra, finely, sparsely punctulate, the impressions with few coarse punctures, the latter almost wholly wanting in the third impression; fourth tergite feebly concave and wholly sculptureless along the basal margin as in *partita*. Length 2.3 mm.; width 0.63 mm. Florida (southeast coast).
floridana n. sp.

The species are rather numerous and will require care in discrimination; they are divisible into two subgeneric groups as indicated above, the first comprising the larger species with more rounded base of the head, more abruptly sinuate sides of the prothorax from before the middle to the base, coarsely and densely punctate abdominal impressions, longer antennae and unimpressed intermesocoxal parts, with the median part of the short mesosternal process projecting into a corresponding sinus in the apex of the metasternum, which I regard as typical *Chitalia*, and the other composed of smaller species, with more truncate base of the head, shorter and more incrassate antennae and without granules on the pronotum, with sparsely punctate abdominal impressions, and, more particularly, a gradually concave intermesocoxal surface, with the mesosternal process rectilinearly truncate and almost completely amalgamated with the metasternum, the suture very fine. The former of these groups is purely

nearctic in range, excepting the Pacific coast, the second being apparently West Indian. The description of *scutellaris* given above, is drawn from the published statements of LeConte, as I have not examined the unique type. It is evidently related closely to *granulosa* but apparently has a narrower prothorax, although the expression "longer than wide" in the original description, as well as the statement that the elytra are devoid of punctuation, is probably erroneous. The elytral punctulation is quite distinct in *granulosa*, where the scutellar channel is well developed, but, in *illustris*, is excessively fine and subinvisible throughout, even toward the scutellum, but the pronotum, which is said to be "densely punctulate" in *scutellaris*, is almost smooth in *illustris*, contrasting very greatly with the flattened and densely granulose slopes of the median sulcus in *granulosa*. For these reasons I do not feel warranted in identifying any one of the species before me as the *scutellaris* of LeConte.

Lorinota n. gen.

This genus, which is also one of the characteristic types of nearctic North America, differs profoundly from the preceding in its less robust form of body, normal mesosternum, rather narrowly separated middle coxae, with the mesosternal process projecting between them as a narrow and parallel-sided, free, spatuliform process, separated from the short metasternal projection by a deeply depressed and clearly defined short isthmus, in its longer and more slender antennae, generally more rounded base of the head and longer prothorax, which is equally deeply sulcate but without the peculiar coarse granulation of *Chitalia*, although the punctures frequently become asperulate. The hypomera are well defined by a beaded edge, but are longer and narrower than usual and much more parallel-sided than in any of the succeeding genera. The scutellum is carinate, roughly sculptured, with its posterior part bent upward to the plane of the elytra and its basal part covered by the broadly arched base of the pronotum as in *Chitalia*, though here the pronotal base is trun-

cate or arcuate from a vertical point of view and the basal margin is coarsely and strongly beaded; the scutellar carina is usually incomplete and frequently very fine. The elytra and abdomen are much as in *Chitalia* and other genera of this subtribe, but, on the former, the fine punctulation does not become closer and granuliform toward the scutellum as it does in *Chitalia*, *Falagrioma*, *Lissagria* and perhaps some other genera. *Lorinota* further differs from *Chitalia* in having the impressions of the abdominal tergites gradually feebler from the first to the third, and even more variably sculptured, and in having the legs more slender, with the hind tarsi longer, more filiform, equally slender throughout, with the basal joint very much longer, sometimes almost as long as the entire remainder. The apex of the elytra externally is scarcely at all produced posteriorly and is either broadly angulate or rounded. This genus is without doubt closely related to the gigantic Mexican species, some 5 mm. or more in length, for which Dr. Sharp proposed the genus *Stenagria*, but, as the large extension of the prosternum before the coxae is particularly mentioned as one of the most prominent characters of *Stenagria*, I believe *Lorinota* will prove to be distinct, since the ante-coxal part of the prosternum is no more developed here than in *Chitalia* or any other related genus that follows in the table given above. The species are rather numerous and may be readily divided into two groups, which are confined to special faunal regions, as follows: —

- Species of the Sonoran fauna, larger in size, the scutellum coarsely and unevenly elevated along the median line for a short distance from the base, the elevation usually succeeded on the median line by a short smooth depression..... 2
- Species of the Atlantic nearctic fauna, smaller in size and frailer in structure, the scutellum with a very fine but even carina on the median line, usually much abbreviated and variably so within specific limits.. 5
- 2 — Abdomen very minutely and sparsely punctulate throughout..... 3
- Abdomen finely and closely punctulate..... 4
- 3 — Form rather stout, convex, black or piceous-black throughout, polished, the legs dark red-brown, the antennae fuscous, paler toward base and sometimes at apex; vestiture short and rather coarse but sparse and wholly inconspicuous; head large, wider than long, the sides behind the small and prominent eyes converging and slightly arcuate for a long distance, the base abruptly arcuato-truncate, the angles

more than right but very distinct, the surface minutely and sparsely punctulate, broadly concave in the male, somewhat flattened in the female; antennae rather stout, but feebly incrassate distally, extending fully to the middle of the elytra, the third joint much longer than the first or second, the subapical joints fully as long as wide; prothorax distinctly narrower than the head in both sexes, very slightly longer than wide, the sides evenly rounded anteriorly, thence very strongly converging and just visibly, broadly sinuate to the base, the surface, like that of the head, devoid of minute ground sculpture, very minutely and sparsely punctulate throughout, the sulcus very deep, impressed; scutellum minutely, densely rugulose; elytra four-fifths wider but scarcely a fourth longer than the prothorax, the humeri very widely exposed and oblique at base, the sides very feebly diverging from base to apex, arcuate, the surface convex, having a ground sculpture of minute lines forming rather coarse reticulations, also finely, sparsely and asperulately punctured throughout, the suture linearly impressed just behind the scutellum; abdomen very minutely, feebly reticulate in wavy transverse lines, the basal impressions wholly impunctate except the first, which has a few widely spaced coarse punctures, the sides parallel and distinctly arcuate, at the middle subequal in width to the elytra; legs long, moderately slender, the basal joint of the hind tarsi equal in length to the next three combined, the latter decreasing uniformly and slowly in length; claws rather short, slender. Length 3.2 mm.; width 0.75 mm. New Mexico (Las Vegas) and Arizona (Flagstaff).....*caviceps* n. sp.

Form somewhat less stout, convex, polished, dark rufo-piceous in color, the head and elytra slightly more blackish than the prothorax; legs piceo-testaceous, paler distally, the antennae fuscous, gradually pale basally; vestiture sparse and inconspicuous; head slightly wider than long, the sides at first feebly converging behind the eyes, then very broadly rounded into the less arcuate base, the angles obliterated; surface minutely, sparsely punctulate, broadly flattened or feebly concave, the anteunae moderately stout, scarcely visibly incrassate distally, long, extending fully to the end of the elytra, the second and third joints subequal, the outer joints fully as long as wide, the sparse erect bristles rather conspicuous throughout; prothorax nearly as in *caviceps* but narrower and distinctly more elongate with the strongly converging sides straight, slightly narrower than the head, similarly deeply sulcate and finely, sparsely punctulate; scutellum finely, densely rugulose; elytra nearly similar in form but with the surface perfectly smooth, like the anterior parts, and not micro-reticulate and with the very sparse punctulation not asperulate and scarcely perceptible, the post-scutellar impression small and deep; abdomen parallel with arcuate sides, everywhere distinctly narrower than the elytra, finely and feebly micro-reticulate, the first impression coarsely and densely punctured at the bottom, the second and third much narrower than the first and impunctate or very sparsely and obsoletely so; legs long and slender, the femora not as thick as in *caviceps*, the hind tarsi longer and more slender, three-fourths as long as the tibiae, the basal

joint almost as long as the entire remainder. Length 3.2 mm.; width 0.65 mm. Arizona (Pinal Mts.), — H. F. Wickham.....**pinalica** n. sp.

- 4 — Form moderately stout, convex, polished, pale rufo-piceous throughout, the abdomen slightly clouded apically, the antennae fuscous except basally, the legs pale; pubescence inconspicuous; integuments not at all micro-reticulate at any part; head large, slightly transverse, broadly, evenly arcuate at base, the sides parallel, the angles broadly rounded; eyes small, slightly prominent, the surface minutely, sparsely punctulate, broadly impunctate toward the middle, where the surface is evenly convex in the male or feebly, broadly impressed along the middle in the female; antennae very long, moderately slender, fully attaining the apex of the elytra, only very slightly incrassate distally, the third joint longer than the second, the subapical rather longer than wide; prothorax elongate, distinctly narrower than the head, especially in the male, the sides broadly, angularly prominent at apical two-fifths, rounded thence to the neck and strongly converging and very feebly sinuate to the base, the sulcus deep, the surface minutely, sparsely punctulate, asperately and less sparsely so very near the sulcus throughout but particularly toward base; scutellum acutely granose; elytra four-fifths wider but only very slightly longer than the prothorax, minutely, sparsely punctulate throughout, the humeri widely and obliquely exposed at base, the impression behind the scutellum large and deep; abdomen parallel with evenly arcuate sides, at the middle as wide as the elytra in the male, narrower in the female, very finely, moderately closely punctulate, the punctures asperate and coarser on the first segment, finer on the second and third and still finer posteriorly, the first impression broad, arcuate, coarsely and closely but not polygonally punctured, the second and third narrower and straighter, each with a single series of coarse and well spaced punctures in median half; legs long, the basal joint of the hind tarsi longer than the next three combined. Length 3.2-3.6 mm.; width 0.7 mm. Arizona....**arizonica** n. sp.

Form nearly similar, convex, polished, the integuments devoid of micro-reticulation throughout, dark piceo-castaneous throughout, the head blackish, the antennae sometimes slightly infumate except at base; pubescence inconspicuous; head moderate, nearly as long as wide, subparallel, the basal angles very broadly rounded and obliterated, the punctures very minute and sparse, slightly larger and asperate on the occiput, the vertex not impressed in the types; antennae much shorter than in the preceding, thicker and much more incrassate distally, extending to about the middle of the elytra, the second and third joints equal, the subapical obviously wider than long; prothorax elongate, nearly as in *arizonica* throughout, except that the fine punctulation is only very obsoletely asperate near the sulcus, distinctly narrower than the head; scutellum similar; elytra also similar except that the minute punctulation is more close-set and still closer, coarser and decidedly asperate very near the suture behind the scutellum, the impression much feebler and more diffuse; abdomen parallel, the sides strongly, evenly arcuate, at the middle but little narrower than the elytra, the surface finely, very closely punctulate throughout, somewhat less finely toward base, the first impression large, arcuate,

rather coarsely, very densely punctured, the second and third narrower and much less coarsely and more closely punctured than in *arizonica*, impunctate narrowly at the sides; hind tarsi very slender, the basal joint about as long as the entire remainder. Length 2.9-3.4 mm.; width 0.66-0.69 mm. Colorado (Colorado Springs), — H. F. Wickham.

fontinalis n. sp.

Form nearly similar, convex, polished, the sculpture similar but stronger, body piceous-black throughout, the elytra and basal ventrals somewhat paler, the antennae infusate, paler toward base; femora blackish, the tibiae piceous, the tarsi flavescent; vestiture wholly inconspicuous; head as in *fontinalis*, the basal angles very broadly rounded but having the surface very broadly, feebly impressed toward the median line, the latter very finely and feebly but acutely impressed by reflected light; antennae longer, extending to the end of the elytra, stout but rather less incrassate distally, the second and third joints equal, the ninth fully as long as wide and rather longer than the tenth, which is somewhat wider than long; prothorax formed as in the two preceding species, narrower than the head, the minute and sparse punctulation closer, coarser and rather strongly asperate on the convex slopes of the deep sulcus, especially at base; scutellum similar; elytra nearly similar, more transverse, fully four-fifths wider than the prothorax but not definitely longer, the punctulation unusually close and strongly asperate, especially near the inner basal angles, the sutural impression stronger than in *fontinalis*; abdomen similar in form and sculpture, not quite as wide as the elytra, the punctures of the first impression coarse and irregularly crowded, those of the second and third only slightly coarse but closely and irregularly crowded; basal joint of the hind tarsi almost as long as the entire remainder, the next three uniformly and rapidly decreasing in length. Length 3.1-3.4 mm.; width 0.66-0.72 mm. New Mexico (Cloudcroft), — W. Knaus.

acomana n. sp.

- 5 — Head strongly, almost evenly rounded at base. 6
 Head broadly arcuato-truncate at base, with much more distinct angles. . 7
 6 — Body moderately slender, convex, polished, the integuments not micro-reticulate at any part, pale rufo-castaneous, the abdomen blackish posteriorly, the elytra sometimes slightly paler at base; pubescence not very conspicuous; head orbicular, convex, not impressed, the eyes small, the antennae extending fully to the apex of the elytra, rather slender toward base but sensibly thick and incrassate distally though very gradually as usual, the subapical joints equal and slightly longer than wide, the second and third subequal; punctures very minute and sparse but becoming larger, closer and asperate on the occiput; prothorax distinctly narrower than the head, narrow and elongate, the sides evenly rounded anteriorly, thence strongly convergent and feebly sinuate for a long distance to the base, deeply sulcate, the punctures very minute and sparse but becoming closer, larger and asperate narrowly on the convex slopes of the sulcus; scutellum finely and rather sparsely granulose, very finely carinate, the carina sometimes extending to the extreme tip; elytra fully four-fifths wider but only very slightly longer than the prothorax, of the usual form in the preceding section

and having very widely exposed oblique humeri, impressed behind the scutellum, the punctures extremely minute, sparse and scarcely visible; abdomen parallel, with evenly arcuate sides, much narrower than the elytra throughout, minutely, rather closely but not distinctly punctulate, the first segment longer than in the preceding species, narrower at base and more dilated at tip, with its surface flat, the impression large and posteriorly arcuate but shallow, coarsely, closely punctured in median half, the second and third impressions narrow and having some coarse, moderately close-set punctures except at the sides; legs very slender, the hind tarsi almost as long as the tibiae, the basal joint as long as the entire remainder. Length 2.5-2.8 mm.; width 0.66 mm. Pennsylvania, Iowa and Wisconsin. [= *Falagria cing.* Lec.]

cingulata Lec.

Body nearly similar but notably more slender, polished, piceous-black in color, the sides of the elytral base slightly pale, the first two ventrals testaceous though blackish in the impressions; legs and antennae piceous-black, the latter toward base and the tarsi pale; vestiture not distinct; head orbicular, fully as long as wide, convex, minutely, very sparsely and scarcely visibly punctulate except at the base, where the punctures become close, strongly asperate and distinct; antennae long and very slender, scarcely perceptibly incrassate distally, extending rather beyond the elytra, the third joint distinctly longer than the second, the subapical equal and much longer than wide, the eleventh elongated and slender but not as long as the two preceding combined; prothorax in outline nearly as in *cingulata* but not evidently narrower than the head, the sulcus deep but somewhat more abruptly formed, the bordering surface almost similarly convex but with the minute sparse punctulation not evidently closer, coarser or more asperate; scutellum finely granulose, finely carinate but only toward base; elytra similar in form but notably narrower, with the sparse punctulation more asperate and rather more evident, the post-scutellar impression broad and evenly concave; abdomen throughout nearly as in *cingulata*, the fine punctulation rather less close-set but more asperulate; legs very slender, the extremely slender and filiform hind tarsi having the basal joint apparently even longer than the entire remainder. Length 2.5 mm.; width 0.6 mm. Ohio (Cincinnati) and Iowa.

tenuicornis n. sp.

- 7 — First impression of the abdomen coarsely, rather conspicuously punctured at least toward the middle..... 8
 Basal impression similar to the second and third, acutely impressed, polished and impunctate or nearly so..... 9
 8 — Form slender, convex, polished, dark piceous or blackish, the elytra at base and apex, the first ventral and apex of the second, tibiae, tarsi and antennae toward base, pale flavate, remainder of the latter and femora piceous; pubescence fine, inconspicuous; head convex, wider than long, transversely arcuate at base with rounded angles, the punctures very minute and sparse, not notably asperulate on the occiput; antennae rather stout, attaining the middle of the elytra, distinctly incrassate distally, the three subapical joints obviously transverse, the third slightly longer than the second; prothorax elongate, nearly as in the

two preceding species, the sulcus deep, the punctures extremely minute and sparse throughout, not more asperate near the sulcus except at base; scutellum finely granulose, with a very fine and subentire median carina; elytra very short and transverse, four-fifths wider than the prothorax but scarcely as long as the latter, the punctures very minute and sparse, the sutural impression at the scutellum distinct, the humeri very oblique at base and widely exposed; abdomen parallel with strongly, evenly arcuate sides, much narrower than the elytra, minutely but not very sparsely punctulate, less minutely and more sparsely toward base, the impressions decreasing rapidly in size and depth, the third narrow and feeble, the first deep, strongly arcuate and coarsely, closely punctate except at the sides, the second and third not more coarsely punctate, impunctate along the basal margin; legs very slender as usual. Length 2.4 mm.; width 0.53 mm. North Carolina (Tryon),—shaken from pines.....*gracilis* n. sp.

Form somewhat less slender, smaller in size, moderately convex, polished, rufo-testaceous throughout, the abdomen clouded with blackish except toward base, the head and elytra somewhat picescent, the latter flavescens at base and narrowly at apex; antennae and legs pale; head large, wider than long, parallel at the sides, the base very broadly arcuato-truncate, the angles well rounded, the surface unimpressed, finely, sparsely punctulate, the punctures larger and feebly asperate on the occiput; antennae attaining the middle of the elytra, feebly incrassate distally, the second and third joints much elongated, equal, the three subapical wider than long; prothorax only very slightly longer than wide, much narrower than the head, the sides prominent and angularly rounded at apical two-fifths, thence strongly converging and straight to the base, the sulcus and fine sparse punctulation as in *gracilis*; elytra nearly as in that species but not quite so short or transverse, very slightly longer than the prothorax and four-fifths wider, the sparse punctulation slightly asperate, the post-scutellar impression very deep; abdomen nearly as in *gracilis*, the first impression with only a few coarse punctures toward the middle, the second and third feebler and subimpunctate. Length 1.9 mm.; width 0.48 mm. Florida.

parva n. sp.

9—Rather slender, convex, polished throughout, pale testaceous, the elytra equally pale but subpiceous, paler at base and apex; abdomen less convex than usual, polished, black, the first two segments pale flavate except finely along their basal margins; antennae fuscous, pale at tip and toward base, the legs pale throughout; pubescence wholly inconspicuous; head well developed, broadly arcuato-truncate at base, subparallel at the sides, the eyes rather large and prominent, the basal angles rounded; punctures very minute and sparse, not noticeably larger or asperate on the occiput; antennae long, rather stout, very feebly incrassate distally, attaining the apex of the elytra, the second and third joints equal, the ninth as long as wide, the tenth very nearly so; prothorax distinctly elongate, much narrower than the head, the sides evenly rounded anteriorly, thence strongly convergent to the base, becoming evidently sinuate, the surface convex, the sulcus deep, the punctulation very sparse and almost obsolete; scutellum sparsely, minutely granu-

lose, the fine carina not quite entire; elytra transverse, of the usual form with very widely exposed oblique humeri, the outer sides scarcely as long as the prothorax, the punctulation fine and sparse, the post-scutellar impression broad and deep; abdomen much narrower than the elytra, parallel with arcuate sides, very sparsely, extremely minutely and almost obsoletely punctulate, the impressions subequal, narrow, rather deep, polished and impunctate, the basal with a few very obsolete and widely spaced punctures visible only under high power; legs very slender, the basal joint of the hind tarsi not quite as long as the remainder. Length 2.6 mm.; with 0.62 mm. Iowa.

bilimbata n. sp.

The above identification of *cingulata* Lec., satisfies all the published characters except sculpture of the abdomen and size of the body. The rather close-set punctulation of the abdomen is sufficiently evident, though very fine, but LeConte describes the surface as smooth. The size is given as 3–3.5 mm. in length, which, it seems to me, must be an error, as the species of that size in the present genus are confined to the Sonoran fauna, all the numerous eastern examples in my cabinet being much smaller and frailer insects. It is probable that the author described *cingulata* from a miscellaneous collection of specimens, including *cingulata* proper and other species, as well perhaps as some of the much larger representatives of the genus *Chitalia*, and inadvertently measured some of the larger specimens, making the observation concerning the smooth abdomen from *bilimbata*, or some allied species, where the abdomen is really almost smooth. It would be well, therefore, to consider the species above selected as the true *cingulata*, as it has the scutellar carina frequently entire and therefore liable to be observed with the optical means of research then in vogue and because all the other characters fully satisfy the original description.

Falagria Steph.

This genus is distinguishable at once from any other of the subtribe by the acutely bicarinate scutellum. The body is smaller in size than in either of the preceding genera, convex, generally black or dark in color, with the characters as stated in the table, the legs being rather short and stouter than usual in *dissecta* and allied species, with the basal joint of the

hind tarsi much shorter than the next three combined in the first group of the table, longer and equal to the succeeding three in the second with two to four subequal among themselves. The basal impressions of the first three tergites are moderate in width, rather deep, subequal and nearly always coarsely and conspicuously punctured in single line. The base of the pronotum is arched over the scutellum but is sinuate from a vertical viewpoint, more strongly so in the middle. Besides the six American species that follow, *Falagria* will include such European forms as *sulcata* Payk., and *sulcatula* Grav.:—

- Elytral punctures fine but asperate and distinct. Atlantic districts.....2
 Elytral punctures extremely minute, sparse, not at all asperate and scarcely visible; prothorax more elongate and more strongly constricted toward base. Sonoran faunal districts..... 4
 2 — Abdominal impressions closely punctured. Form moderately stout, black or piceous-black, the elytra generally somewhat paler; legs piceo-testaceous, the antennae piceous-black throughout; vestiture fine, short, sparse and inconspicuous; integuments polished, not at all micro-reticulate at any part; head wider than long, convex, somewhat inflated but with parallel arcuate sides behind the eyes, which are moderate and prominent; base broadly arcuato-truncate, the angles rounded, the surface minutely, sparsely punctulate, the median line flattened and impunctate except at base; antennae almost attaining the middle of the elytra, moderately slender, rather distinctly, very gradually incrassate distally, the second joint equal in length to the third but thicker, the subapical joints not quite as long as wide; prothorax distinctly wider than the head, somewhat wider than long, the sides inflated and strongly rounded anteriorly, thence strongly convergent and moderately sinuate to the base, which is three-fifths as wide as the disk, the sulcus deep, not attaining base or apex as usual, the surface convex, finely, sparsely, asperately and equally punctulate; scutellar carinae strong, acute and entire as usual; elytra moderate, about one-half wider and a fourth longer than the prothorax, convex, the sutural impression behind the scutellum very small and scarcely distinct, the punctures even, rather close-set, the humeri widely and obliquely exposed at base; abdomen parallel with the sides nearly straight, obviously narrower than the elytra, finely, closely punctured, the punctures attended by flattened and elongate asperities, those of the first and frequently of the second impression coarse and notably closely crowded, generally with carinate interspaces. Length 1.9–2.5 mm.; width 0.47–0.53 mm. Rhode Island and New York (Catskill Mts.) to Wisconsin (Bayfield) and Texas (Austin).....**dissecta** Er.
 Abdominal impressions not very closely punctate; punctulation throughout sparser, the size more minute.....3
 3 — Body slender, convex, blackish-piceous, the elytra piceo-testaceous,

the legs testaceous, the antennae dusky; head nearly as in *dissecta* but relatively larger, parallel and scarcely arcuate at the sides, broadly arcuato-truncate at base with well rounded angles, the sculpture very minute and obsolescent; antennae barely attaining the middle of the elytra, rather strongly incrassate distally, the subapical joints evidently shorter than wide, the tenth longer than the ninth, the second and third equal in length, the first three decreasing uniformly and rapidly in thickness; prothorax scarcely as wide as the head, somewhat wider than long, the sides broadly, evenly rounded in about apical half, then strongly convergent and feebly sinuate to the base, the latter fully two-thirds as wide as the disk, the sulcus deep; surface still more minutely and sparsely and less asperately punctulate than in *dissecta*; elytra one-half wider and fully a third longer than the prothorax, as in *dissecta* but more finely and sparsely punctulate and with the sutural post-scutellar impression long, narrow and deep; abdomen similarly parallel and narrower than the elytra, with close asperulate sculpture, less dense than in *dissecta*, the punctures of the impressions rather close-set but not sufficiently so to be crowded, always circular in form. Length 1.7 mm.; width 0.4 mm. Iowa (Cedar Rapids).....*iowana* n. sp.

Body slender, more convex, pale piceo-testaceous in color throughout, polished; head as in the preceding species, finely, sparsely punctulate, the median line broadly impunctate even basally; antennae about attaining basal third of the elytra, rather strongly incrassate distally, the second joint much longer than the third as well as thicker, six to ten strongly transverse, eight to ten increasing in length as well as thickness; prothorax small, not quite as wide as the head, strongly convex, in form and obsolete sparse punctulation nearly as in *iowana*; elytra broader and more transverse, four-fifths wider than the prothorax and about a third longer, similarly punctulate, the punctures minute and sparse, the suture with a very short feeble impression behind the scutellum; abdomen also wider than in *iowana* but parallel and straight at the sides, the sculpture moderately close-set and feebly asperulate, less finely and more sparsely toward base as usual, the basal impressions each with a series of moderately coarse circular, widely and irregularly separated punctures, only four to six in number in each impression, the type having but four punctures in the basal impression, two at each side of the middle, the latter broadly impunctate. Length 1.8 mm.; width 0.45 mm. New York (Ithaca),— H. H. Smith....*ithacana* n. sp.

4— Basal joint of the antennae stout, oval, with rounded sides. Form moderately stout, convex, polished, dark castaneous, the elytra feebly rufescent; legs piceo-testaceous, the antennae dusky, pale at base; vestiture indistinct; head wider than long, parallel, broadly arcuate at base with very broadly rounded angles, the surface almost evenly convex, minutely, sparsely punctulate; antennae extending to the middle of the elytra, distinctly incrassate distally, the joints eight to ten very slightly wider than long, subequal in length, the second a little longer than the third, the former visibly the thicker, both much less inflated than the first; prothorax fully as long as wide and distinctly wider than the head in the female, scarcely in the male, the sides strongly rounded anteriorly, thence abruptly, strongly convergent and broadly, strongly

sinuate to the base, which is barely three-fifths as wide as the disk; surface deeply sulcate, strongly convex, with a short transverse impression just before the base at each side of the middle, the punctulation very minute, not asperate, sparse and subobsolete; scutellum as in the preceding group; elytra three-fourths wider and barely a third longer than the prothorax, sparsely and extremely minutely punctulate, convex, the post-scutellar impression distinct; abdomen much narrower than the elytra, parallel and straight at the sides, arcuately narrowing near the tip, the sculpture not at all asperate but with very fine and moderately close-set, nearly simple punctulation, which becomes less minute, sparser and somewhat asperate toward base, the basal impressions with coarse, deep, crowded punctures, the interspaces being sublinear. Length 2.0 mm.; width 0.6 mm. Colorado (Cañon City) and New Mexico (Las Vegas).....*subsimilis* n. sp.

Basal joint of the antennae narrower, more cylindrical..... 5
 5 — Form, coloration and sculpture nearly as in *subsimilis*, polished, castaneous; head larger, wider than long, more broadly truncate and less arcuate at base than in *subsimilis*, parallel at the sides, with the angles much more narrowly rounded, sparsely, inconspicuously punctulate; antennae rather thick and distinctly incrassate distally, barely extending to basal third of the elytra, the second joint somewhat longer than the third, joints seven to ten very distinctly wider than long; prothorax fully as wide as long, equal in width to the head, the sides anteriorly very strongly rounded, more prominent than in *subsimilis*, thence strongly convergent, and broadly, strongly sinuate to the base, the deep sulcus and fine sparse punctulation nearly as in *subsimilis*; elytra and abdomen nearly similar, the latter somewhat broader and fully as wide as the elytra, parallel with slightly arcuate sides, arcuately narrowing toward tip, the fine punctulation rather more close-set, the impressions similarly sculptured. Length 2.2 mm.; width 0.62. Texas (Austin).

texana n. sp.

Form rather more elongate, larger, polished, piceous-black, the prothorax and basal parts of the abdomen very slightly paler, rufescent; legs pale, the antennae fuscous; pubescence scarcely noticeable; head nearly as in *texana*, the antennae similar in length, moderately incrassate distally, the second joint distinctly longer than the third but scarcely thicker, eighth to tenth wider than long; prothorax as long as wide, slightly wider than the head in the female but not obviously so in the male, the sides inflated and circularly rounded anteriorly from the neck to apical two-fifths, where they become abruptly and angularly, strongly convergent and sinuate to the base, which is barely three-fifths as wide as the disk; sulcus and fine, sparse punctulation as in the preceding species; elytra three-fourths wider and a third longer than the prothorax, sparsely and almost imperceptibly punctulate, the suture narrowly impressed behind the scutellum; abdomen parallel with feebly arcuate sides, widest at about two-thirds from the base, narrower than the elytra, finely, feebly and moderately closely asperate in sculpture, more coarsely and sparsely toward base, the impressions coarsely and closely punctured; basal joint of the hind tarsi fully as

long as the next three combined. Length 2.4 mm.; width 0.65 mm.; Utah (St. George),— H. F. Wickham.....*angulata* n. sp.

The very numerous examples of *dissecta* before me, from various parts of the country, are fairly homogeneous but, at the same time, there may be some subspecific forms among them. The Texan specimens, for example, are generally smaller in size, with rather paler legs and elytra and usually somewhat less dense abdominal sculpture than those from central New York, but the differences are slight and scarcely specific. The species of the first group of the table constitute a peculiarly American type, those of the second being similar in every way to the European *sulcata*. The palae-*arctic sulcatula* forms still another group of the genus, having smaller elytra, with the sides more diverging from the base and impressed throughout the length along the suture and with a rather more elongate scutellum. The abdomen in *angulata* is much more asperulate in sculpture than in *subsimilis* and *texana*, the latter being rather closely allied, the former being distinguishable from *texana* by the more broadly rounded basal angles of the head and narrower abdomen, as well as the thicker basal joint of the antennae; a third specimen, from Austin, is placed at present with the two types, although the prothorax is much more rounded and less oblique at the sides of the apex and the strong convergence and sinuation of the sides posteriorly begins only slightly before the middle; the form in fact appears to be strikingly different, but it may be sexual in origin.

Leptagria n. gen.

The species of this genus are among the more minute of the present subtribe, rather closely allied to *Falagria* in general structure but with the prothorax less constricted behind and having a finer, though very evident, sulcus. They differ from *Falagria* especially in having the scutellum flat, simply granulose, though with the granules tending to coalesce into short irregular longitudinal lines, and frequently parted along the middle in much the same manner as in

Chitalia. They also differ in the more widely separated middle coxae, with the broadly arcuato-truncate mesosternal process fitting closely against the metasternal projection, on the same level, without depression of any kind and without an intervening isthmus. The basal joint of the hind tarsi is very slender, fully as long as the next three combined, the latter decreasing slowly and regularly in length. In some features *Leptagria* recalls the European genus *Melagria*, but may be readily distinguished by the characters of the table. We know at present but two species which may be described as follows: —

Form slender, subparallel, moderately convex, polished, pale brownish-testaceous, the antennae distally, head and an apical abdominal cloud darker, piceous; pubescence inconspicuous; head wider than long, parallel, the base broadly arcuato-truncate with the angles rounded; eyes well developed, rather prominent, the punctures very minute and sparse; antennae extending nearly to the middle of the elytra, moderately incrassate distally, the second joint much longer than the third, seven to nine distinctly transverse, equal in length, the tenth decidedly longer but still obviously wider than long, the eleventh short, obtuse; prothorax small, somewhat wider than long, evidently narrower than the head, the sides evenly rounded anteriorly, thence strongly converging but scarcely at all sinuate to the base, which is nearly three-fourths as wide as the disk; sulcus ending abruptly near apex and base, the surface strongly convex, very minutely, sparsely and obsoletely punctulate; scutellar granules parted narrowly along the middle; elytra nearly four-fifths wider and more than a third longer than the prothorax, the sides evidently diverging from the base, rather strongly arcuate posteriorly, extremely minutely and somewhat sparsely punctulate throughout, not impressed on the suture basally; abdomen subparallel, rather wide, with nearly straight sides, posteriorly fully as wide as the elytra, very minutely, not very closely punctulate, the first impression with a few coarser but subobsolete punctures, the second and third gradually narrower and feebler, impunctate; legs very slender, the hind tarsi slightly shorter than the tibiae. Length 1.65 mm.; width 0.38 mm. Texas (Brownsville), — H. F. Wickham.

porexilis n. sp.

Form and coloration nearly similar throughout, slightly stouter, equally shining, the head nearly similar; antennae almost similar but rather stouter and more incrassate, the joints six to ten decidedly transverse, the tenth obviously longer than the ninth, the eleventh ogival, not as long as the two preceding together, second much longer than the third; prothorax larger, somewhat wider than long, the sides more angularly prominent before the middle, thence converging and broadly, feebly sinuate to the base, the surface less convex but similarly sculptured,

the sulcus distinct, narrow and rather abruptly formed as in *pexilis* and ending behind in the same small deep fovea which is not wider than the sulcus itself; scutellar granules not parted along the middle; elytra longer and much broader but otherwise nearly similar, broadly and obsoletely impressed behind the scutellum, the punctures very fine, only moderately sparse, becoming close-set, larger and more asperulate near the inner basal angles; abdomen distinctly narrower than the elytra, parallel with evidently arcuate sides, the sculpture close-set but fine and feebly asperulate, the first impression with very few obsolescent coarser punctures, the second and third impunctate; hind tarsi much shorter than the tibiae. Length 1.65 mm.; width 0.42 mm. New York (Catskill Mts.),—H. H. Smith. *hudsonica* n. sp.

Pexilis is one of the smallest falagrioid species known to me within our faunal limits, but is more than equaled in this respect by some of the forms of *Melagria* and greatly surpassed by the next genus; it was found in some abundance by Mr. Wickham. *Hudsonica* is represented at present by a single specimen.

Aneurota Csy.

In its short tarsi, with more abbreviated basal joint than in any other type of the Falagriæ now known to me, depressed and parallel form, large quadrate head, peculiarly impressed along the median line, short bristling hairs along the sides of the body and some other characters, this genus is wholly isolated in the present subtribe. That it belongs here, however, seems to be evident because of the very narrow neck, but I have been unable to break out the anterior coxæ in the unique type and am therefore not positive concerning the structure of the concealed part of the prosternum. From glimpses between the anterior parts of the coxæ in a strong light, with high magnifying power, it would seem that corneous plates exist under the latter and that they are slightly incomplete or rounded on the median line anteriorly, leaving a minute triangle of membrane exposed. A more detailed statement of its characters may be found under the original description—Ann. N. Y. Acad. Sci., VII, p. 347. The type may be described as follows:—

Form depressed, parallel, shining, dark piceous in color, the abdomen black, the legs pale testaceous; pubescence sparse; head large, parallel and

slightly arcuate at the sides, truncate and not at all arcuate at base, with narrowly rounded angles, the surface extremely sparsely and minutely, obsoletely punctulate, strongly impressed on the median line from the middle of the vertex to the front; antennae slightly longer than the head and prothorax, moderately thick, but feebly incrassate distally, the first three joints decreasing rapidly in length and thickness, the outer joints moderately transverse, the eleventh about as long as the two preceding together, pointed; prothorax very slightly longer than wide, somewhat shorter and very much narrower than the head, feebly convex, with a very fine and feeble impression along the median line almost from the apical margin to the base; sides anteriorly prominently rounded, thence moderately converging and straight to the base, which is fully three-fourths as wide as the disk; punctulation very minute and even but rather closer and more asperate than that of the head or elytra; scutellum flat, triangular, finely, sparsely, and evenly asperulate, with a wide flat and sculptureless border throughout; elytra quadrate, less than one-half wider and about two-fifths longer than the prothorax, about as long as wide, the sides very feebly diverging from base to apex and straight, the humeri scarcely rounded, angulate, moderately exposed at base; punctulation very minute, rather sparse and even throughout; abdomen much narrower than the elytra, widest at the apex of the fifth segment, feebly narrowed thence to the base, the sides straight, minutely, not very closely punctulate, the three impressions subequal, fine, rather deep and impunctate; legs short, rather slender. Length 1.35 mm.; width 0.3 mm. Florida.

sulcifrons Csy.

This extremely minute species is probably very local in distribution and of peculiar habits, possibly subcortical. My reference under the original description to a relationship with *Cardiola* is erroneous and was based solely upon the absence of an acute bead delimiting the hypomera.

Lissagria n. gen.

The very wide abdomen and elytra, in contrast with the comparatively narrow head and prothorax, gives to this genus a peculiar habitus which can be recognized at once. The detailed characters have been fully given in the table of genera and little can be added at present, except to draw attention to the marked homogeneity of the species, the general color, polished lustre and elytral sculpture, as well as the structure of the legs and antennae, varying scarcely at all throughout. The elytral sculpture consists of extremely minute, sparse and scarcely visible punctulation, which,

toward the scutellum, becomes finely granuliform and very close-set, giving an alutaceous lustre in that vicinity. The scutellum is flat and rather strongly, closely granulose, the granules never parted along the middle so far as observed. *Lissagria* seems to be confined to the fauna of middle and southern California, west of the Sierras, and those forms worthy of distinctive names, whether true species or local variants, may be indicated as follows: —

- Pronotal sulcus very deeply and conspicuously impressed, the surface along its sides very convex..... 2
 Pronotal sulcus fine, though distinct, more abruptly formed, the adjoining surface feebly convex..... 5
 2 — Head and prothorax equal in width or very nearly so..... 3
 Head relatively larger, very much wider than the prothorax..... 4
 3 — Form stout, rather convex, dark rufo-piceous with a very feeble sub-aeaneous lustre, the head and elytra somewhat darker, the legs and antennae pale, testaceous, the latter feebly infusate toward tip; vestiture anteriorly very short and indistinct, longer and coarser on the abdomen but very sparse; head orbicular, rounded at base, very minutely, sparsely punctulate, the front with a very feeble impressed transverse line between the antennae; eyes rather small, prominent; antennae long but not extending quite to the end of the elytra, moderately incrassate and compact distally; prothorax very slightly longer than wide, the sides rather broadly but prominently rounded anteriorly, thence moderately converging to the transversely truncate base, which is fully three-fourths as wide as the disk, the punctures fine but rather distinct, sparse posteriorly, closer anteriorly; transverse impression before the base rather fine, arcuate; elytra fully four-fifths wider and two-fifths longer than the prothorax, the coarse sutural beading slightly depressed behind the scutellum, the surface not impressed, the sides very feebly diverging from the well-marked humeri to the apex; abdomen parallel, feebly narrowed at tip, fully as wide as the elytra, finely, very sparsely punctulate, less sparsely toward apex, the three impressions subequal, narrow, rather deep, the first two with very few widely and unevenly spaced, coarse but feeble punctures, the third impunctate. Length 2.8 mm.; width 0.78 mm. California (Coast region to the south of San Francisco). [= *Falagria laev.* Lec.]

laeviuscula Lec.

Form and coloration nearly similar to the preceding; head and antennae nearly similar, the latter rather stouter distally, the transverse frontal groove broadly impressed; prothorax narrower, more distinctly elongate, the sides more broadly and less prominently rounded anteriorly, much less converging and straight to the base, which is broadly arcuate and four-fifths as wide as the disk, the punctures extremely fine and sparse throughout, much less distinct; elytra similar but more elongate, about twice as wide as the prothorax; abdomen parallel with slightly arcuate sides, similarly narrowed at tip, the sculpture

- similar, the third impression with a very few subobsolete coarse punctures. Length 2.9 mm.; width 0.8 mm. California (Giant Forest, Tulare Co.), — Chas. Fuchs.....**fissilis** n. sp.
- 4 — General form, coloration and structure as in the two preceding species, the head similar in form and in its sparse punctulation but with the transverse frontal impression deeper and more conspicuous, the antennae barely as stout and scarcely extending beyond the middle of the elytra; prothorax much smaller, longer than wide, the sides more broadly rounded than in *laeviuscula* and scarcely prominent, thence moderately converging and straight to the base, widest at apical two-fifths; sulcus very deep and wide, also broadening toward base, where it includes the entire transverse impression, the punctulation sparse throughout but unusually coarse, the punctures feebly impressed; elytra nearly twice as wide as the prothorax and two-fifths longer, the sides strongly diverging from base to apex, the punctulation as in the preceding species; abdomen fully as wide as the elytra, finely, sparsely punctulate, more asperate toward tip than usual, the impressions similarly subimpunctate. Length 2.5 mm.; width 0.7 mm. California (Sta. Cruz Mts.).....**impressifrons** n. sp.
- 5 — Body stout in form, convex, polished as usual, rather pale piceo-rufous, the head and most of the abdomen slightly darker, the legs and antennae pale testaceous, the latter very slightly infuscate distally; head as long as wide but rather fuller at the sides of the base than in *laeviuscula*, equally minutely, sparsely punctulate, the frontal impression very feeble; antennae nearly similar in form; prothorax but little longer than wide, slightly narrower than the head, the sides subangularly prominent at two-fifths from the apex, thence rather strongly converging and straight to the base, the surface very finely, sparsely and inconspicuously punctulate throughout, the transverse subbasal impression short but deep; elytra similar in form and sculpture to *laeviuscula*, four-fifths wider than the prothorax; abdomen similar in form and punctulation, the first impression with rather numerous coarser punctures, the second and third subimpunctate. Length 2.8 mm; width 0.8 mm. California (Sta. Cruz and Monterey Cos.).....**robusta** n. sp.
- Body stout, smaller and rather less stout than in *robusta* but of the same coloration and sculpture; head nearly similar, the antennae more slender, with the third joint evidently shorter than the second; prothorax nearly similar but smaller, narrower, not quite as wide as the head, rather less prominently rounded at the sides and widest at a point rather more apical, the impression more evidently broadening and deepening toward base, before which there is scarcely any transverse impression; elytra slightly narrower and less transverse, similarly sculptured, the abdomen nearly similar, equally sparsely but rather less distinctly punctulate. Length 2.3 mm; width 0.68 mm. California (Los Angeles Co.).....**minuscula** n. sp.
- Body more elongate and less stout than in *robusta* and differing somewhat in coloration, paler rufous, the head darker, the elytra, except toward base and the apical part of the abdomen blackish; legs and antennae pale testaceous, the latter slightly infumate toward tip; vestiture similarly inconspicuous; head smaller than in *robusta* and more evenly,

circularly rounded from eye to eye, minutely, almost invisibly punctulate, the frontal impression feeble; antennae somewhat longer, the apical parts rather more rapidly incrassate; prothorax narrower, distinctly more elongate, equal in width to the head, the sides less angular and less prominent anteriorly, the punctulation similarly very minute, sparse and inconspicuous, the subbasal impression rather finer and more shallow; elytra nearly twice as wide as the prothorax and fully two-fifths longer, the sides rather more strongly diverging from base to apex, the minute punctulation extremely sparse but abruptly unusually dense and granuliform near the scutellum; abdomen nearly as in *robusta* throughout but somewhat narrower. Length 2.5 mm.; width 0.75 mm. California (Lake Co.).....**longicollis** n. sp

The unique type of *impressifrons*, described above, has the elytra singularly crumpled in large feeble folds, which is probably a deformity caused in drying after emergence from the pupa, but it is rather remarkable that the folds and depressions should be so perfectly symmetric bilaterally, each depression and each of the two long oblique folds of one elytron being perfectly matched on the other; the species can be known by the small prothorax and relatively large head, in addition to the coarse impressed punctulation of the former. The considerable series of *robusta* collected by Koebele and Harford in the Sta. Cruz Mts., is very homogeneous, and the two specimens from Los Angeles which I have separated under the name *minuscula*, although resembling it rather closely in general form and sculpture, are notably smaller in size. The measurement of length given in the original description of *Falagria laeviuscula* is undoubtedly an error; it is highly probable that no example of *Lissagria* ever attained the length of 3.5 mm., which is the dimension given by LeConte.

Falagriota n. gen.

The species of this genus are smaller, much more slender and frailer insects than those of *Lissagria* and have the sides of the prothorax very moderately converging toward base, with the median sulcus, so well developed in that genus, reduced to a very fine, obsolescent and wholly inconspicuous impression. The antennae are shorter, slender toward base but more incrassate distally, the scutellum more finely but evenly

granulose and the elytra very minutely, rather sparsely punctulate throughout and not more closely or granularly so toward the scutellum. The abdomen is always more finely and closely punctulate. The remarkably small corneous plates of the prosternum have been previously referred to in sufficient detail, and this and other characters have been fully stated in the table of genera. Our seven species are readily separable into two distinct groups as follows:—

- Elytra larger and more transverse, very much wider and always distinctly longer than the prothorax, the humeri widely exposed at base and moderately oblique.....2
- Elytra much smaller and narrower, never longer and much less distinctly, though very obviously, wider than the prothorax, the humeri narrowly exposed at base and more oblique; sides of the elytra rather more divergent from base to apex.....5
- 2 — Prothorax widest and rather broadly rounded at the sides at or near apical two-fifths.....3
- Prothorax distinctly elongate, widest and strongly rounded at the sides much nearer the apex.....4
- 3 — Form moderately slender, convex, polished, rufo-testaceous in color, the elytra rather more brownish, the abdomen with a very faint darker cloud, especially posteriorly; legs and antennae pale; pubescence rather abundant throughout but fine, short and pale, somewhat distinct; head slightly wider than long, broadly rounded at base, the sides becoming parallel for a short distance behind the eyes, the surface very minutely, sparsely and scarcely visibly punctulate, not impressed except very obsoletely on the median line toward base; antennae extending to basal third of the elytra, strongly incrassate distally, the subapical joints evidently transverse, the first three equal in length, the first slightly thicker; prothorax equal in width to the head, very slightly narrower in the male, convex, very finely and evenly punctulate, the punctules more asperate and closer than those of the head; sides distinctly convergent and straight posteriorly, the base broadly arcuato-truncate, fully four-fifths as wide as the disk; elytra two-thirds to three-fourths wider and two-fifths longer than the prothorax, not evidently impressed on the suture behind the scutellum, finely, not very sparsely and obviously punctulate, very evenly so throughout, the sides slightly diverging from base to apex; abdomen parallel with the sides distinctly, almost evenly arcuate, not quite as wide as the elytra, minutely, closely punctulate, less minutely, more sparsely and asperulately toward base, the first impression with numerous coarser punctures not very close-set, the other two with but few such punctures. Length 2.4 mm.; width 0.58 mm. California (Sta. Clara and Monterey Cos.). [= *Falagria occ. Csy.*].....*occidua* Csy.
- Form nearly similar but more slender, similarly colored, the head relatively larger, excessively minutely, sparsely punctulate, the antennae some-

what less incrassate distally, the third joint slightly longer than the first; prothorax notably narrower and more elongate, very much narrower than the head, the sides broadly rounded anteriorly, similarly moderately converging and straight to the base, the punctulation still finer and sparser than in *occidua* and not evidently asperulate; elytra narrower though about four-fifths wider than the prothorax and much longer; abdomen similar but much more sparsely punctulate. Length 2.25 mm.; width 0.53 mm. California (Monterey Co.)....**lucida** n. sp.

Form more elongate and narrower than in *occidua*, the prothorax more elongate, rufo-piceous in color, the abdomen darker; legs pale, the antennae fuscous except at tip and toward base; vestiture short but close and rather distinct; head as in *occidua*, minutely and sparsely punctulate but having the punctures strongly asperate on the occiput; antennae nearly similar, the three penultimate joints decidedly transverse; prothorax very evidently elongate, not quite as wide as the head, the base four-fifths as wide as the disk, the sides rounded anteriorly; punctulation minute, rather sparse, very slightly asperulate; elytra but slightly transverse, four-fifths wider and two-fifths longer than the prothorax, the punctulation rather sparse and asperulate; abdomen distinctly narrower than the elytra, parallel with broadly arcuate sides, the sculpture close-set and distinctly asperulate, finely so posteriorly, coarsely and more sparsely toward base, the impressions differing from those of the allied species in having numerous somewhat coarser but feeble punctures, irregularly scattered and not in close contact. Length 2.5 mm.; width 0.55 mm. California (Los Angeles Co. — Pomona Mts.), — H. C. Fall.....**asperula** n. sp.

Form still more slender and darker in color, blackish-piceous, the legs testaceous, the femora in large part piceous; antennae fuscous, paler at tip and toward base; pubescence inconspicuous; head wider than long, parallel at the sides behind the eyes, thence broadly rounded through the base, unimpressed, obsoletely and remotely punctulate; antennae nearly attaining the middle of the elytra, normally incrassate distally, the second and third joints long, equal, the first somewhat shorter and stouter; prothorax only very slightly longer than wide, somewhat narrower than the head, nearly as in *occidua* but rather more depressed and more finely, sparsely and obsoletely punctulate; elytra about three-fifths wider and two-fifths longer than the prothorax, only slightly wider than long, sparsely and very minutely punctulate; abdomen parallel with arcuate sides, as wide as the elytra, the sculpture scarcely at all asperulate, very sparsely punctulate throughout, extremely minutely so posteriorly, somewhat asperulately toward base, the first impression with but few widely spaced coarse punctures, the second with still fewer, the third impunctate. Length 2.25 mm.; width 0.5 mm. California (Los Angeles Co. — Pomona Mts.), — H. C. Fall.....**picina** n. sp.

4 — Form slender, coloration as in *asperula*; head of the usual form, nearly as long as wide, broadly rounded at base, the sides becoming parallel for some distance behind the eyes; punctulation extremely fine, sparse, not much more distinct at base; antennae attaining the middle of the elytra, moderately incrassate distally, rather slender toward base, the two penultimate joints distinctly transverse, the first

joint somewhat shorter than the next two, which are equal as usual; prothorax distinctly longer than wide and evidently narrower than the head, the sides rather evenly rounded and subprominent apically, thence moderately converging and just visibly arcuate for a long distance to the base, the latter nearly four-fifths as wide as the disk, which is widest between apical third and fourth; punctulation extremely fine, sparse, scarcely at all asperulate, the sulcus all but obsolete; elytra nearly as in *occidua*, the punctulation sparse, extremely fine, not asperulate; abdomen parallel with broadly arcuate sides, not as wide as the elytra, sparsely, very finely punctulate throughout, scarcely at all asperulate, the basal impressions with but few coarser punctures, the third almost completely impunctate. Length 2.4 mm.; width 0.52 mm. California (Sonoma Co.).....*evanescens* n. sp.

- 5 — Body rather slender, strongly convex, polished, piceo-rufous, the abdomen and antennae slightly darker, the latter toward base and legs throughout pale testaceous; vestiture fine, subpruinose; head wider than long, broadly subtruncate at base with widely rounded angles, the sides parallel; punctulation sparse and obsolete, scarcely more visible at base; antennae nearly as in *occidua* but with the third joint slightly longer than the second, the three penultimate transverse; prothorax large, suboval, as wide as the head, longer than wide, widest at apical two-fifths, where the sides are broadly rounded and scarcely at all prominent, thence rather feebly converging and somewhat arcuate to the base, which is unusually arcuate and four-fifths as wide as the disk, the angles obtuse and slightly rounded; surface minutely, obsoletely and sparsely punctulate, the sulcus extremely fine and feeble; elytra relatively small, two-fifths wider and not at all longer than the prothorax, minutely, obsoletely punctulate; abdomen arcuate at the sides, widest somewhat behind the middle, where it is very obviously wider than the elytra, extremely minutely, somewhat closely punctulate and pubescent, the punctures very finely but abruptly asperulate throughout, the impressions with coarser but feeble punctures, some seven or eight in the first, the third impunctate. Length 2.7 mm.; width 0.67 mm. California (Humboldt Co.—Hoopa Valley).

collaris n. sp.

Body smaller and much more slender, rather less convex, similarly colored and pubescent; head nearly similar but smaller, more arcuate at base and broadly, obsoletely impressed along the median line basally, the punctulation similarly obsolete and sparse, becoming less sparse but asperulate on the occiput; antennae nearly similar, attaining the middle of the elytra; prothorax very slightly elongate, equal in width to the head, in outline as in *collaris*, the hind angles equally obtuse but scarcely rounded, the punctulation very fine, feebly asperulate and sparse, except rather broadly along the median line, where the surface becomes more broadly impressed than usual toward the very feeble sulcus and more closely and coarsely, asperately punctate; elytra very small, about a third wider than the prothorax and barely as long, the sides distinctly diverging from base to apex and very feebly arcuate, the punctures very fine, moderately close-set and somewhat distinctly asperulate; abdomen nearly as in *collaris*, with arcuate sides, much

wider than the elytra, minutely, more densely and much more asperately punctulate, the three basal impressions polished but with rather numerous larger, though obsolescent, scattered punctures. Length 2.4 mm.; width 0.58 mm. California (San Bernardino Mts.), — H. C. Fall.....**parvipennis** n. sp.

Of *occidua* I secured a large series, showing that the very pale coloration is a constant specific character; of *lucida* I have, however, only a single specimen; it is of equally pale color, but may be distinguished from the male of *occidua*, in which the prothorax is also very obviously narrower than the head, by the more elongate and narrower form of that part of the body, relatively much larger head and sparser abdominal sculpture. The species of this genus will doubtless prove to be numerous in California and perhaps also the coast districts to the northward.

There are two species described under the generic name *Falagria*, by LeConte, which I have not been able to place in the above revision; they may be described as follows from the published characters: —

Form elongate, subdepressed, densely punctulate, finely pubescent; head rectilinearly truncate at base, the neck obviously narrower than in *Tachyusa*; basal angles right and rounded; antennae fuscous, longer than the head and prothorax, slightly thickened externally but with the outer joints somewhat loose and not closely placed as they are in typical *Falagria*, the first three joints elongate as usual; prothorax slightly longer than wide, as wide as the head, obliquely truncate at each side of the apex, the sides converging slightly behind; base broadly rounded, the surface flattened, feebly but broadly channeled; elytra wider than the prothorax but not at all longer, the tip truncate, the outer angles acute; abdomen slightly narrowed at base, impressed as usual, the impressions impunctate, the surface smooth, paler toward base, the apex testaceous; legs testaceous, the basal joint of the hind tarsi not as long as the three following combined, the latter diminishing slightly in length. Length 3.5 mm. Lake Superior.....**vaga** Lec.

Form depressed, piceous-black, the abdomen piceous; legs and basal parts of the antennae testaceous; shining, finely pubescent; head large, parallel, the base broadly truncate with the angles rounded, sparsely punctulate, with an impressed frontal fovea, the occiput briefly canalliculate; antennae not longer than the head and prothorax and less slender than usual, but slightly thickened distally; prothorax trapezoidal, moderately narrowed behind, somewhat shorter than wide, punctulate, deeply can-

aliculate; scutellum punctulate, not at all canaliculate; elytra wider than the prothorax, closely punctulate, piceo-testaceous; abdomen very finely punctulate, broader and flatter than usual, and scarcely narrowed toward base, the first three tergites impressed as usual, the impressions impunctate; posterior tarsi two-thirds as long as the tibiae, with the first joint as long as the three following combined, the latter subequal. Length 3.5 mm. New York, found under a stone.

quadriceps Lec.

It is rather more than probable that each of these species will prove to be the type of a distinct genus, apparently different from any defined in the above tables. *Vaga* belongs, without much doubt, to the subtribe Tachyusae and may be attached provisionally to the genus *Gnyppeta*, some of the components of which have the neck rather strongly constricted. *Quadriceps*, on the other hand, is almost certainly a member of the subtribe Falagriæ, where it is wholly isolated; it may take the generic name **Orthagria** (n. gen.) and be placed just before the genus *Lissagria* in the table of genera. In each case the published length of the body is probably excessive. *Tachyusa pygmaea*, of Sachse, has been identified as the European *Mymecopora crassiuscula* Aub., by Mr. Fauvel; I have now no example of it, but, if this is true, it should be removed from our lists.

Tribe BOLITOCCHARINI.

In this tribe the tarsi are 4-4-5-jointed throughout, but, apart from this distinguishing character, there is great structural variety, some forms recalling correspondingly specialized groups in other tribes, as usual under the tarsal system of classification. There are numerous subtribes, such as the Autaliae, composed of the genus *Autalia* alone, recalling the Falagriæ of the Myrmedoniini and the Echidnoglossae of the Aleocharini, the Bolitocharæ, with rather numerous genera, represented by a multitude of fungus-loving species, the Homalotæ, consisting of the genera *Homalota* Mann.—(= *Epipeda* Rey) — and *Placusa*, the Gyrophaenæ, as described below, and the subtribe Phytosi, distinguished by its comparatively large number of highly specialized genera, there being a separate genus for almost every known species. The

American genera of Phytosi are *Bryobiota*, *Thinusa*, *Bryothinusa*, *Amblopusa*, *Diaulota* and *Liparocephalus*, the European being *Phytosus*, *Actocharis*, *Actosus* and *Arena*. They inhabit ocean beaches in various parts of the northern hemisphere, being especially abundant on the western coast of America, but extremely rare on the nearctic Atlantic coast, the single species described by Dr. Horn, under the name *Phytosus littoralis*, being unknown to me at present; it is possibly not a true *Phytosus*.

Subtribe **Bolitocharae**.

This is probably the largest subtribe of the Bolitocharini and is apparently more developed in the palaeartic than in the nearctic regions, owing to the very large number of minute obscure species of *Sipalia*, which genus is exceedingly rare in America, the somewhat aberrant *Sipalia frontalis* Csy., of California, being the only one described thus far. This deficiency is, however, made up largely by the greater number of American species allied to *Bolitochara*, although that genus itself does not occur here. There are two tolerably well defined groups of the subtribe Bolitocharae, the first characterized by a broader obtuse mesosternal process, narrower and more acute however in *Stictalia*, and more elongate basal joint of the hind tarsi, the second having an acute process and shorter basal joint, generally but little longer than the second, though as long as the next two combined in *Euryusa*, and comprising in addition thereto, the genera *Silusa*, *Leptusa*, *Sipalia* and others which will not be systematically discussed in the present paper. The antennae are variable in the first group but are always gradually thicker to the tip in the second. The Bolitocharae, as a group, have a readily recognized facies owing to their coarse asperate sculpture, and, as far as known to me, live exclusively in fungi of various species, frequently in enormous numbers.

The genera of the first group indicated above may be briefly defined as follows: —

Prothorax distinctly narrower than the elytra; antennae gradually thicker to the apex..... 2

- Prothorax** broader and more transverse, subequal in width to the base of the elytra; infra-lateral carinae of the head distinct and entire..... 4
- 2 — Infra-lateral carinae of the head wholly obsolete except for a short distance anteriorly; neck narrower than in any other genus of the subtribe, slightly less than half as wide as the head; mesosternal process moderately wide, obtuse, somewhat free and not attaining the metasternal projection; prosternum before the coxae and posterior part of the mesosternum finely and acutely carinate along the middle; basal joint of the hind tarsi about as long as the next two combined; pronotal punctures normal, coarser, not asperate. Europe.***Bolitochara**
 Infra-lateral carinae distinct and entire; neck wider, always more than half as wide as the head..... 3
- 3 — Head strongly narrowed behind the eyes, the neck about two-thirds as wide; hypomera shorter, coming far from attaining the anterior limits of the prothorax; mesosternal process only moderately narrow and more obtuse, almost attaining the metasternal projection; basal joint of the hind tarsi not as long as the next two combined; pronotal punctures simple and impressed, not asperate. Europe.....***Ditropalia**
 Head feebly narrowed behind the eyes, the neck very broad; hypomera more elongate, almost attaining the anterior limits of the prothorax; mesosternal process narrow, subacute and freer at tip, the latter separated from the metasternal projection by a much greater longitudinal discontinuity; basal joint of the hind tarsi much more elongate, sometimes subequal to the next three combined; pronotal punctures always very fine and granuliform or asperate; eyes similar, moderate in size and prominent. Nearctic Pacific coast regions.....**Stictalia**
- 4 — Antennae gradually thicker distally as in the preceding genera; head not materially narrowed behind the prominent eyes, the neck very wide; hypomera visible from the sides as in all the other genera of the subtribe, attaining the apex of the prothorax; sides of the latter feebly rounded and not at all sinuate toward base; antennae short, the outer joints strongly transverse; pronotal punctures minute and asperulate.....5
- Antennae not or scarcely thicker externally, the last seven or eight joints forming a loose parallel-sided club; head, hypomera and sculpture similar, the infra-lateral carinae unusually acute and very strongly elevated; sides of the prothorax very feebly sinuate toward base, the basal angles more distinct.....6
- 5 — Mesosternal process broad anteriorly, rapidly narrowed, its apex narrowly rounded or subacute, free and separated from the metasternal projection by a considerable longitudinal discontinuity; basal joint of the hind tarsi scarcely as long as the next two combined. Europe.
 * **Phymatura**
 Mesosternal process longer, narrow and more parallel, free and rounded at tip, virtually attaining the apex of the metasternal projection; basal joint of the hind tarsi fully as long as the next two combined. Nearctic Atlantic regions.....**Silusida**
- 6 — Fourth antennal joint small, about as wide as the preceding joints and very much smaller than those which follow; intermesocoxal parts nearly as in *Bolitochara*, the process varying from moderately wide to rather

narrow; hypomera long and well developed; head short and moderately narrowed behind the eyes, which are large and prominent; neck very broad; pronotal punctures fine and asperate; tarsi very slender, the basal joint of the posterior as long as the next two combined or longer.

Nearctic Atlantic regions..... **Venusa**

Fourth antennal joint large, wider than the preceding joints and subsimilar to those which follow; general form of the body as in *Venusa*, the pale maculation of the elytra usually more distinctly defined, the pronotal punctures less asperate and nearly simple; head, eyes, neck and hypomera nearly similar, the mesosternal process broader, very obtuse at tip, almost attaining the metasternum; tarsi rather less slender, the basal joint of the posterior barely as long as the next two combined. Nearctic Atlantic regions..... **Pleurotobia**

In addition to the two characters previously mentioned which distinguish these genera of the first group from *Silusa*, *Leptusa* and others of the second group, it should be said that the elytra here are always variegated with dark or black and pale tints, the humeri at least being invariably paler than the external apical parts, but, in the second group, the coloration of the elytra is uniform, any variegation being feebly developed and exceptional. The three exclusively foreign genera of the table may be remarked upon as follows: —

BOLITOCARA Mann. — This genus may be recognized at once by the obsolete infra-lateral carinae of the head, so universally developed elsewhere in the subtribe, except in certain very slender and almost blind species of *Sipalia*, such as *flava* Kr., *plicatella* Fauv. and *bituberculata* and *arida* Epp., which, because of the narrow subelongate head, frequently very minute subfacetless eyes and complete absence of the infra-lateral carinae should be generically separated from *Sipalia*, and for which I would propose the generic name **Typhlusida**. With this virtual absence of the carinae in *Bolitochara*, occurs the seemingly correlated narrow neck, which is wholly foreign to any of the American genera. *Bolitochara*, as here restricted, is represented by such European species as *lunulata* Payk., and *lucida* Grav.

DITROPALIA n. gen. — The complete infra-lateral carinae of the head is a perfectly constant and very important character, separating this genus from *Bolitochara*. The head behind the eyes is, however, more strongly narrowed and more elon-

gate than in any of the American genera, and the neck is correspondingly narrower, though much wider than in *Bolitochara*. The genus *Ditropalia* is founded upon the European *Bolitochara bella* Märk., *obliqua* Er., *mulstanti* Shp., and other allied species and appears to be confined to the palae-arctic fauna.

PHYMATURA J. Sahlb. — The single known representative of this genus appears to be a somewhat rare insect. It greatly resembles our *Silusida* and *Venusa* in its broad prothorax, but differs very much in its shorter and more triangular meso-sternal process, which is very broad at its base but acutely rounded at tip, differing from the corresponding part in *Bolitochara* also in the absence of any trace of carina. The type is *brevicollis* Kr.

Stictalia n. gen.

The species of this genus are numerous but rather closely allied among themselves, inhabiting various parts of the region immediately contiguous to the Pacific Ocean, from southern California to Alaska. They are smaller and much less conspicuous than the less numerous and, in all probability, individually less abundant species of the European genera *Bolitochara* and *Ditropalia*, and are intermediate in some characters between those genera and *Venusa* and the European *Phymatura*, having the gradually enlarged antennae of the former and the sculpture of the latter. The coloration of the abdomen seems to be constant, enabling us to separate the species into two unequal primary groups as follows:—

- Abdomen pale, with a large subapical black cloud, the dark coloration generally extending to the base of the abdomen along the median basal parts of the tergites 2
 Abdomen black throughout, the tergites toward base paler along their apical margins especially toward the sides 8
 2 — Pronotum impressed at each side of the median line toward base, the impressions transversely connected slightly before the basal margin.. 3
 Pronotum with a short transverse impression before the basal margin but not otherwise impressed..... 7
 3 — Fourth antennal joint only very slightly longer than wide..... 4
 Fourth antennal joint much elongated..... 6
 4 — Three basal tergites deeply impressed at base, the impressions notably

more coarsely and sparsely punctured than the remainder of the surface, which is not very closely or coarsely punctate; pronotal impressions only visible behind the middle and converging toward base. Body rather stout, convex, feebly shining, pale rufo-testaceous, the head piceous, the elytra blackish externally toward tip, the legs and antennae pale, the latter very slightly infusate distally except at tip; integuments minutely but strongly reticulate, feebly so on the elytra, the abdomen excessively minutely and feebly reticulate in subtransverse broken lines; head wider than long, the sides behind the eyes short, parallel for some distance, then strongly rounded to the neck, the punctures rather distinct, moderately close; antennae gradually stout distally, but little longer than the head and prothorax, the subapical joints rather strongly transverse, fully three-fourths wider than long; prothorax slightly wider than the head, nearly a third wider than long, parallel, the sides arcuate, becoming feebly sinuate before the obtuse but very distinct basal angles, the surface strongly, asperately and moderately closely punctured, the impressions distinct; elytra a third wider and nearly one-half longer than the prothorax, the truncate apex deeply sinuate externally as usual, the surface strongly, asperately and somewhat closely punctured, the pubescence short, somewhat sparse but coarse, pale and distinct. Length 3.3 mm.; width 0.82 mm. Alaska (Fort Wrangel). [= *Bolitochara* not. Mäkl.].....*notata* Mäkl.

Three basal tergites less deeply impressed and with punctuation which differs but little from that of the remainder of the tergites; pronotal impressions parallel..... 5

5 — Form more slender than in *notata* but similarly alutaceous in lustre anteriorly, with the integuments minutely reticulate, less so on the elytra, the abdomen very obsoletely so, testaceous, the head and prothorax slightly darker and more piceous than the elytra, the latter each with a large and irregular infumate spot externally in apical two-thirds, not attaining the apex; legs and antennae as in *notata*; head nearly similar, the punctures finer and less distinct; antennae longer and notably less stout, the subapical joints moderately transverse; prothorax more distinctly wider than the head, two-fifths wider than long, parallel and arcuate at the sides, becoming feebly sinuate before the basal angles as usual, the surface finely and very closely, asperately punctured, the two longitudinal impressions extending almost to the apex though very feebly and broadly impressed; elytra two-fifths wider and fully one-half longer than the prothorax, the asperate punctures much less coarse than in *notata* and very close-set; abdomen much narrower than the elytra as usual, the punctures rather sparse and unusually inconspicuous throughout. Length 3.1 mm.; width 0.76 mm. British Columbia.....*densicollis* n. sp.

Form nearly similar to the preceding but still less stout anteriorly, the coloration also similar, except that the head alone is slightly darker than the prothorax and elytra, the integuments much more shining, polished, the reticulation everywhere obsolete; head and antennae similar, the punctures less close-set; prothorax shorter and more transverse, slightly wider than the head, not quite one-half wider than long, equally finely but less closely punctured, the impressions only visible

behind the middle; elytra nearly as in *densicollis* but with the humeri slightly more exposed at base and the punctures coarser, more asperate and less close-set, more nearly as in *notata*; abdomen as in *densicollis* but with the punctures toward base notably coarser and conspicuously close throughout the extent of the tergites. Length 3.0-3.3 mm.; width 0.73-0.8 mm. California (Humboldt Co.). [= *Bolitochara calif.* Csy.].....**californica** Csy.

6 — Form rather stout, convex, shining, not at all reticulate, dark castaneous, the elytra pale testaceous, blackish externally toward tip; abdomen very dark rufous throughout except subapically; head longer than usual, about as long as wide, strongly and closely punctate; antennae rather slender, only moderately incrassate distally, extending to about basal third of the elytra, the subapical joints moderately transverse; prothorax unusually elongate, about a fourth wider than long, convex, distinctly wider than the head, broadly rounded at the sides just before the middle, finely, rather closely, asperately punctured, the impressions short, feebly converging, only visible behind the middle; elytra nearly one-half wider and longer than the prothorax, unusually, coarsely, very asperately and not very closely punctured, the humeri rather well exposed; abdomen narrower than the elytra, unusually tapering almost from the base to apex, the punctures unusually coarse, close-set and even, sparser and finer toward tip as usual. Length 2.7-3.0 mm.; width 0.78-0.83 mm. California (locality unrecorded)....**punctiventris** n. sp.

Form less stout, similarly polished and devoid of reticulation, paler, castaneous, the elytra rufous, blackish externally toward tip, the abdomen much paler than in *punctiventris*, with the usual black subapical cloud but with the segments thence to the base blackish at the middle, the legs very pale; head almost as in the preceding but more finely and sparsely punctate, the antennae shorter, much more rapidly and strongly incrassate distally, the subapical joints strongly transverse, the fourth less elongate; prothorax more transverse, a third wider than long, distinctly wider than the head, more feebly and less closely, asperately punctate, the impressions similarly only distinct near the transverse impression; elytra narrower, less transverse, almost as long as wide, almost as coarsely and asperately punctate, the punctures very slightly more numerous; abdomen more parallel, much narrower than the elytra, the punctures much finer and sparser, more distinct but still sparser in the basal impressions. Length 3.0 mm.; width 0.73 mm. California (Mendocino Co.).....**aspera** n. sp.

Form more slender and parallel than in *aspera*, the elytra relatively smaller than in any other species; coloration nearly similar, the pale basal parts of the abdomen without distinct medial blackish maculation; integuments not minutely reticulate, polished; head and antennae as in *aspera*, the punctures stronger and closer toward base; prothorax less transverse, about a fourth wider than long, only very slightly wider than the head, the punctures small but strongly asperate, moderately close-set; impressions very short and feeble; elytra about a third wider and two-fifths longer than the prothorax, rather more coarsely and asperately punctured than in any other species, the punctures well separated; abdomen subparallel, narrowed toward tip, less distinctly narrower than

the elytra than in *aspera*, punctured almost as in *punctiventris*, the punctures coarse and close-set throughout the extent of the tergites toward base. Length 2.75 mm.: width 0.7 mm. California (Sta. Cruz Mts.).....***rugipennis* n. sp.**

- 7 — Body moderately slender, subparallel, shining, black, the elytra each obliquely rufous from the humerus to the suture behind the middle; the abdomen rufescent toward base; integuments very obsoletely micro-reticulate anteriorly; head well developed, somewhat wider than long, the antennae short, but little longer than the head and prothorax, rapidly and distinctly incrassate and blackish distally, though less stout than in *rugipennis*, the apical joint not paler, the penultimate joints strongly transverse, the fourth distinctly elongate; prothorax but slightly wider than the head, about a third wider than long, convex, finely, asperately punctate, closely so along the middle, more sparsely laterally, the transverse subbasal impression narrow, straight and very feeble; elytra but slightly wider than long, two-fifths wider and fully one-half longer than the prothorax, the humeri moderately exposed at base, the punctures relatively rather small, feebly asperate and distinctly separated; abdomen parallel, almost as wide as the elytra, rather strongly and coarsely, evenly, moderately closely punctured toward base. Length 2.7 mm.; width 0.78 mm. California (Sta. Cruz Mts.).....***obsolescens* n. sp.**

Body smaller and somewhat stouter, parallel, shining, piceo-rufous, the elytra blackish, broadly flavate toward the humeri and narrowly along the suture posteriorly, the abdomen pale toward base, especially at the sides of the dorsal plates; legs pale, the antennae blackish except toward base, the apex not paler; head wider than long, well developed, parallel, abruptly constricted at base, finely, sparsely and obsoletely punctulate, the antennae short, strongly incrassate, the penultimate joints strongly transverse, the fourth scarcely longer than wide; prothorax notably transverse, rather more than one-half wider than long, slightly wider than the head, and, like the latter, minutely and feebly reticulate, finely, not closely and inconspicuously punctulate, the transverse subbasal impression unique in being long and anteriorly arcuate; elytra but slightly transverse, about a fourth wider and one-half longer than the prothorax, finely, rather closely and not very strongly punctured; abdomen but little wider than the prothorax, parallel, finely and only moderately closely punctate. Length 2.3 mm.; width 0.7 mm. British Columbia (Victoria).....***arcuata* n. sp.**

- 8 — Pronotum with two broad and very feeble longitudinal impressions transversely united before the base and obsolete anteriorly well before the middle. Body moderately stout, somewhat strongly convex, shining, black, the elytra rather bright red, blackish about the scutellum and broadly toward the sides except in basal third and along the apical margin; basal tergites slightly paler at apex; legs pale, the antennae fuscous, much paler toward base and slightly at the apex; head and pronotum very obsoletely micro-reticulate, the former only moderately large, transverse, with prominent eyes, the punctures rather strong and close-set toward base; antennae extending almost to the middle of the elytra, moderately incrassate distally, the penultimate

joints about one-half wider than long, the fourth as long as wide; prothorax much wider than the head, fully a third wider than long, finely, but strongly, asperately and closely punctate; elytra nearly quadrate, a third wider and a half longer than the prothorax, the punctures strongly asperate, moderately large and rather well separated; abdomen narrower than the elytra but broader than the prothorax, parallel, feebly narrowing toward apex, rather strongly and closely punctate toward base. Length 2.4-3.0 mm.; width 0.72-0.78 mm. California (mountains near Claremont, San Mateo, Pomona and Calaveras Co.),—Mr. C. F. Baker and others. **bakeri** n. sp.

Pronotum impressed as in *bakeri*. Body stout, moderately convex and shining, pale piceo-castaneous in color, the elytra each with a broad flavescens area from the region of the humerus to the suture in apical half or more, the apical margin also pale, especially toward the sides; abdomen blackish, pale at tip and nubilously so at the apices of the first two or three tergites; head large, as long as wide, strongly and closely punctured, finely and sparsely so on the front, the antennae blackish, piceous toward base, rather short and compact, but little longer than the head and prothorax, the fourth joint slightly elongate, the outer joints rapidly and strongly incrassate, the tenth almost twice as wide as long; eyes rather small; prothorax large, distinctly wider than the head, fully two-fifths wider than long, widest slightly before the middle, the sides moderately arcuate, the punctures strong, close-set and asperate, the interstices feebly micro-reticulate; elytra scarcely a third wider and nearly one-half longer than the prothorax, the humeri only very narrowly exposed at base, the punctures coarsely asperate and rather close-set; abdomen at base distinctly narrower than the elytra, thence sensibly attenuate to the apex, the punctures rather fine, asperate and sparse throughout; legs pale, moderately stout. Length 2.5 mm.; width 0.78 mm. California (locality unrecorded). **collaris** n. sp.

Pronotum with the usual short transverse subbasal impression, which is only very briefly or not at all extended anteriorly at its sides. 9

9 — Abdomen gradually and very distinctly tapering almost from the base to the apex, the antennae long. Body moderately stout and convex, black, the elytra obliquely red from the humeri to the posterior half of the suture; legs pale, the antennae blackish, slightly paler toward base but not at apex; head nearly as long as wide, suborbicular, somewhat narrowed behind the rather inconspicuous eyes, finely punctured, minutely reticulate, the antennae long, rather loose, almost attaining the middle of the elytra, moderately incrassate distally, the fourth joint much elongated, the sixth as wide as long, the tenth scarcely one-half wider than long; prothorax minutely and feebly reticulate, very much wider than the head, two-fifths wider than long, very minutely, not densely and inconspicuously asperate; elytra nearly as long as wide, about one-half wider and two-thirds longer than the prothorax, finely, closely, subasperately punctate; abdomen at base slightly narrower than the elytra but much wider than the prothorax, finely, not very closely punctate, the impressions feebly and sparsely so. Length 3.0 mm.; width 0.8 mm. California (Mokelumne Hill, Calaveras Co),—F. E. Blaisdell. **laxicornis** n. sp.

Abdomen subparallel, feebly narrowed toward tip; the antennae shorter. 10

10 — Form moderately stout, not very convex, shining, the head and pronotum minutely, feebly reticulate, black or piceous-black, the elytra pale at the humeri, narrowly at apex near the sides and narrowly along the suture posteriorly; legs pale, the antennae blackish, slightly paler toward base but not at apex; head transverse, slightly narrowed behind the eyes, finely, sparsely punctulate, more closely along the base and sides; antennae moderately incrassate distally, attaining basal third of the elytra, the fourth joint rather distinctly longer than wide, the fifth very nearly as long as wide, the outer joints distinctly but not strongly transverse; prothorax much wider than the head, a third wider than long, the sides strongly sinuate toward base, the angles but slightly more than right, the punctures minute, asperulate and not very close-set; elytra rather large, nearly one-half wider and three-fourths longer than the prothorax, somewhat depressed, finely, closely punctured and only feebly asperulate; abdomen much narrower than the elytra and but little wider than the prothorax, the apices of the first two tergites pale laterally, the punctures fine and moderately close, the impressions deep. Length 2.75 mm.; width 0.78 mm. California (Humboldt Co.). [= *Bolitochara nig.* Csy.].....**nigrina** Csy.

Form and sculpture nearly similar to the preceding, smaller, pale piceous, the elytra flavo-testaceous, broadly piceous-black toward the external apical angles, except at tip, and also about the scutellum; abdomen black, the first three tergites pale at the sides almost throughout their length; legs pale, the antennae dusky, paler toward base but not at tip; head nearly as in *nigrina* but relatively larger, minutely, sparsely punctulate, the antennae much shorter, more rapidly and strongly incrassate distally, but slightly longer than the head and prothorax, the fourth joint as long as wide, the fifth distinctly and the penultimate strongly transverse; prothorax but slightly wider than the head, nearly as in *nigrina* but less strongly sinuate at the sides toward base, the angles more obtuse; elytra nearly similar in form and in their fine close sculpture; abdomen nearly similar in form and sculpture. Length 2.4-2.6 mm.; width 0.68-0.7 mm. California (Humboldt Co.).

brevicornis n. sp.

Form similar, the size still smaller, similarly minutely reticulate anteriorly, shining, colored as in *brevicornis*, the basal tergites pale at the sides of their apices; head transverse, subparallel at the sides, abruptly constricted at base, finely, sparsely punctulate, the antennae rather short, rapidly and strongly incrassate distally, the fourth joint obviously longer than wide, the fifth nearly as long as wide, the tenth about three-fifths wider than long; prothorax nearly as in *brevicornis* but more distinctly wider than the head; elytra nearly similar in form but much more coarsely punctate, the punctures well separated; abdomen much more coarsely and rather more closely punctured, the impressions scarcely as deep. Length 2.0-2.2 mm.; width 0.67 mm. California (locality unrecorded).....**minor** n. sp.

The sexual characters in this genus are rather feeble but readily observable, the male having the ordinary sparse punc-

tures of the fifth and sixth tergites modified into coarse and elevated, subelongate asperities, usually with one more distinct at the centre, and in some cases as in *bakeri* and *laxicornis*, another at each side more apical on the fifth tergite, and the sixth sinuate at tip, with porrect asperities, each bearing a short stiff bristle, about the contour of the sinus, the female having the punctures throughout minute and but feebly asperulate, with the sixth tergite simple at the apical margin and sinuato-truncate. In *nigrina* the central tubercle of the fifth tergite is very small and slightly elongate, those more posterior being scarcely distinct and in *brevicornis* it is similar, but in the former the sinus of the sixth tergite is coarsely serrulate, while in the latter the serrulations are extremely minute and sparser. In *minor* the central tubercle is very minute and scarcely elongate. In *californica* the median tubercle is before the centre and scarcely larger than several of the others. There is but little diversity in these sexual characters, so that it is scarcely necessary to describe them in each instance.

Silusida n. gen.

This genus is represented thus far by two species, one at least very abundant in individuals, both small in size and of rather dull lustre. They resemble *Venusa* in general form, but may be distinguished at once by the short, strongly and gradually incrassate antennae and by the feebly rounded sides of the prothorax toward base, with less distinct basal angles; they may be described as follows:—

Form rather stout, somewhat depressed, parallel, feebly shining, the pubescence pale, very short but abundant and distinct, pale flavo-testaceous in color, the head, median parts of the prothorax, elytra toward the external apical angles, except along the apex, and abdomen from about basal third to the middle of the fifth segment, blackish; legs pale, the antennae slightly dusky; head and prothorax very minutely and obsoletely reticulate, the former small, transverse, with rather large prominent eyes, minutely, sparsely punctulate, the antennae scarcely longer than the head and prothorax, rapidly and strongly incrassate, the second joint much longer than the third, both slender and elongate, four to ten very strongly transverse, greatly increasing in width and perfoliate; prothorax fully three-fourths wider than long, very much wider

than the head, broadly arcuate at base, minutely, asperately and moderately closely punctate, broadly, feebly impressed in the middle before the base; elytra at base equal in width to the prothorax, at apex but little wider, one-half longer, slightly transverse, finely, feebly and closely punctate, each somewhat obliquely impressed behind the scutellum; abdomen much narrower than the elytra, gradually tapering almost from the base, finely, closely and almost evenly punctured, more sparsely posteriorly, the basal impressions rather narrow and feeble. Length 2.2-2.5 mm.; width 0.7-0.75 mm. New York (Catskill Mts.) and Pennsylvania (near Philadelphia). [= *Bolitochara marg.* Csy.].

marginella Csy.

Form slender, much smaller in size, dull in lustre and similarly sculptured, the punctuation throughout fine, asperulate and close-set, pale brownish flavate in color, the head piceous, the elytra scarcely at all darker at tip, the abdomen with a piceous cloud involving the fourth tergite; head convex, well developed, the antennae stout, fuscous, paler toward base, scarcely longer than the head and prothorax, strongly incrassate distally, the outer joints rather compactly joined and strongly transverse; prothorax about a third wider than the head and less than one-half wider than long, convex, not distinctly impressed, subparallel with the sides broadly arcuate, the base rounded; elytra slightly transverse, equal in basal width to the prothorax and about a third longer, the humeri not at all exposed, the suture slightly impressed behind the scutellum; abdomen obviously narrower than the elytra, subparallel, finely, very sparsely punctured, the vestiture much longer and coarser. Length 1.35 mm.; width 0.45 mm. Pennsylvania (near Philadelphia).

nanella n. sp.

The male of *marginella* has a very small rounded tubercle on the median line of the fifth tergite, at some distance from the apex, with the punctures not more conspicuously asperate than on the other tergites, the sixth having a similar but more elongate flattened discal tubercle and the apex broadly sinuate throughout the width, the edge having six or eight serrulations not continued onto the disk. In *nanella* the abdominal sculpture throughout is very much sparser than in *marginella* and the tubercle of the fifth tergite is rather larger, more elongate and nearer the apex, with the sparse punctures elongato-asperate, the sixth being narrower and sinuato-truncate at tip, with four rather strong rounded denticles continued forward onto the surface by convex longitudinal ridges, the surface anteriorly in great part covered by the fifth tergite in the unique type.

Venusa n. gen.

In the general form and sculpture, as well as coloration of the body, the species of *Venusa* closely resemble *Stictalia*, but they differ in three important features, the first relating to the structure of the antennae, which do not gradually increase in thickness to the tip but are slender at base, with the outer seven joints forming a long and loose, nearly parallel-sided club, the second being the much wider and more transverse prothorax, imparting a notably different facies to the anterior part of the body, the third concerning the sexual characters of the male, the punctures of the fifth and sixth tergites, as in *Silusida*, not being notably or more coarsely asperate and both having a large conspicuous, though unentire, obtusely rounded ridge along the median line; the sixth is, however, similarly sinuate or sinuato-truncate at tip and armed with porrect denticles throughout the width. The species are not very numerous, closely allied among themselves and swarm individually in great numbers in almost every mushroom that has passed its prime, resembling in this way the allied genus *Pleurotobia*; they may be described as follows: —

Antennae stouter, the penultimate joints much wider than long. Body stout, parallel, convex, shining, black or blackish, the basal margin of the prothorax pale, the elytra pale flavo-testaceous, slightly dark near the scutellum and broadly toward the external angles; abdomen bright red, the fifth tergite and basal half of the sixth black; legs pale, the antennae blackish, pale toward base; head wider than long, rapidly narrowed behind the eyes, which are well developed and finely faceted, the punctures fine, rather sparse; antennae attaining basal third of the elytra; prothorax three-fourths wider than long, slightly less than one-half wider than the head, rounded at the sides, the latter becoming subparallel toward base, the surface finely, asperately and closely punctate, with a large feeble binary impression at the middle before the base; elytra wider than long, very slightly wider and one-half longer than the prothorax, impressed at each side of the suture for about half the length behind the scutellum, rather finely, closely but asperately punctate, the humeri scarcely at all exposed at base; abdomen much narrower than the elytra, somewhat tapering from near the base to the apex, rather finely but strongly, closely and asperately punctate, the impressions rather narrow, moderately deep and somewhat more coarsely and sparsely punctate. Length 2.6 mm.; width 0.82 mm. New York (near the city) to Iowa.....*picta* n. sp. (Fvl. MS.).

Antennae slender, the penultimate joint very nearly as long as wide.....2
 2 — Antennae long, extending nearly to the middle of the elytra; form, coloration and sculpture nearly as in *pieta* but more slender, the head black, the prothorax piceous, paler along the basal margin, the elytra generally infumate everywhere except toward the humeri; head small; prothorax three-fourths wider than long, broadly rounded at the sides and narrowed anteriorly, the sides distinctly converging toward base, the latter broadly arcuate, becoming sinuate near the angles as usual, the subbasal impression fine, transverse and bisinuate, feebly, anteriorly bifurcate at the middle; elytra slightly wider and scarcely one-half longer than the prothorax, impressed and punctured nearly as in *pieta*, the humeri slightly more exposed at base; abdomen nearly similar but with each of the pale basal tergites more distinctly infumate at the middle of the base. Length 2.6-3.0 mm.; width 0.75-0.78 mm. New York (Catskill Mts.) to Iowa (Iowa City). [= *Bolitochara bl.* Csy.]

blanchardi Csy.

Antennae shorter and less developed, scarcely extending to basal third of the elytra; form, coloration and sculpture nearly as in *blanchardi* but smaller in size, and, in general, of darker color, the prothorax more blackish and scarcely at all paler along the base, the subbasal double impression larger and more distinct; elytra always black except broadly toward base, the dark color also involving the scutellum as a rule, the form and sculpture as in *blanchardi*; abdomen similar to the latter throughout. Length 2.7 mm.; width 0.77 mm. Missouri (St. Louis) and Iowa.....**laetula** n. sp.

These species are very closely allied among themselves, presenting difficulties in classification similar to those well known in *Sericoderus*, of the Corylophidae. In *blanchardi* the medial, transversely convex carina of the fifth tergite extends anteriorly but little beyond the middle of the plate, and, posteriorly, nearly to the apical margin, the sixth tergite being broad at tip and only very feebly sinuate, or more properly sinuato-truncate, with the edge finely serrulate as usual. The species are all very abundant as before remarked.

Pleurotobia n. gen.

In most of its characters, as well as general habitus and ornamentation, this genus agrees very well with *Venusia*, but it differs rather radically in the fact that; the third antennal joint, instead of being small and forming a part of the slender basal part, is here large, similar to the succeeding joints and similarly sculptured and pubescent; the basal joint of the hind tarsi, also, is notably less elongate. The species live in fungi

associated with *Venusia*, but are scarcely so numerous individually; the three in my cabinet at present may be readily known as follows: —

Predominating color black or blackish.....2
 Predominating color pale.....8

2 — Form stout, parallel, rather convex, polished, black, elytra testaceous near the humeri and very narrowly on the suture posteriorly, the abdomen feebly rufescent toward base; legs pale, the antennae black, with the first three and the eleventh joints paler; vestiture short, coarse and rather inconspicuous, not dense; head nearly as long as wide, arcuately narrowed behind the large but not very prominent eyes, the punctures extremely fine but much coarser and close toward the base and sides; antennae long, thick, cylindrical with obtrapezoidal joints, attaining the middle of the elytra, the second joint shorter than the third, both elongate, obconic and shorter than the first, the outer joints slightly wider than long; prothorax two-thirds wider than long and one-half wider than the head, the sides broadly rounded, feebly converging and scarcely visibly sinuate toward base, the angles distinct, the surface strongly convex, finely, not very closely and scarcely at all asperately punctate, with a large indentation in the middle before the scutellum, the base broadly, unevenly arcuate; elytra transverse, slightly wider and barely a third longer than the prothorax, the bead along the suture extremely fine, almost obsolete, the humeri narrowly rounded to the prothorax, the punctures slightly coarse, very close-set, deep and asperate; abdomen distinctly narrower than the elytra, parallel and nearly straight at the sides throughout, the fifth segment but little narrower, the punctures rather large, strong and moderately close-set toward base, becoming gradually very minute and sparse apically, the basal impressions wide and rather deep. Length 3.0 mm.; width 0.87 mm. Ohio (Cincinnati), — Chas. Dury.....*suturalis* n. sp.

Form similar, the size materially smaller, polished, black as in *suturalis* throughout, except that the elytra are black but obliquely pale from the humeri to the suture at the middle and thence broadly to apex, also narrowly throughout at the apical margin; punctuation throughout similar but finer, less conspicuous and rather less close-set; head relatively larger, distinctly though not very closely punctate toward the base and sides; antennae almost similar but somewhat shorter and thicker, the outer joints slightly more transverse; prothorax similar in general form but only about three-fifths wider than long and scarcely two-fifths wider than the head, the subbasal impression much feebler, shorter and broader; elytra and abdomen similar. Length 2.7 mm.; width 0.8 mm. Missouri (St. Louis).....*tristigma* n. sp.

3 — Form rather stouter than in *tristigma*, shining, pale testaceous in color, the head slightly piceous, the elytra blackish, pale at the humeri and narrowly on the suture posteriorly, the abdomen blackish posteriorly; legs pale, the antennae dusky, paler toward base and at tip; sculpture as in *tristigma* but still finer, feebler and sparser, the punctures of the elytra scarcely at all asperate; head similar, the antennae barely ex-

tending behind basal third of the elytra and still stouter, the outer joints rather strongly transverse; prothorax similar in form but with the sub-basal impression small and very feeble; elytra similar, the sutural bead very fine but distinct, the surface as usual not impressed behind the scutellum; abdomen parallel, slightly narrower than the elytra, the sides slightly arcuate. Length 2.7 mm.; width 0.85 mm. Texas, — H. F. Wickham.....*texana* n. sp.

The male sexual characters are very distinct and interesting, the elytra in *suturalis* being thrown up in a strong narrow ridge at each side of the suture from near basal third to the apex, the fifth tergite having two fine longitudinal carinae, approximate and posteriorly converging in somewhat more than apical half, with a shorter carina at each side much more distant from either of the median carinae than the latter are from each other. In *tristigma* the elytra are similarly but more feebly elevated along the suture in posterior half only and the four carinae of the fifth tergite are shorter, subequidistant and less unequal in length among themselves, the sixth broadly sinuate throughout the width at tip, the edge of the sinus with small porrect and widely spaced spinules, each bearing the small stiff seta peculiar to the present group of genera. *Texana* is at present represented by the female only. The *Homalota trimaculata*, of Erichson, is evidently a *Pleurotobia* allied to *tristigma*, but differing in having the sides of the prothorax piceous; the elytral spots are also smaller and more rounded, judging by the language of the description.

Subtribe Gyrophaenae.

This group is one of the most specialized of the Bolitocharini and is composed of a moderate number of genera and very numerous species, inhabiting stemmed fungi of many genera, but rather unequally diffused over the northern hemisphere, this distribution doubtless depending directly upon the relative abundance of the more highly organized fungi. In North America the subtribe is extremely abundant everywhere, except in the regions bordering upon the Pacific Ocean, where it is comparatively rare, and, although known at present by one or two species in the northern parts

and one in Lower California, I have never yet seen a specimen collected in California or Oregon. Dr. Sharp has described numerous species from Mexico, but the European representatives appear to be much less numerous than the American, though this may be due largely to lack of systematic study of the palaeartic species, as the known genera are about twice as numerous as those of North America. In the latter region the richness of the subtribe may be realized when it is considered that a collection made in the Catskill Mountains by H. H. Smith, now forming a part of my cabinet, contains fourteen species from that limited area alone.

The body in this subtribe is small to very minute in size, of more or less stout fusiform outline and compact, rather convex build, the integuments generally pale in color with darker marking and very thin and diaphanous as a rule, frequently becoming distorted in drying, though this applies more particularly to *Gyrophaena* and *Phanerota*, the exoskeleton being normally thick in the other genera. The hypomera are feebly inflexed and visible from the sides in all the genera except *Brachida* and *Encephalus*, where they are strongly inflexed and invisible from a lateral point of view, and the scutellum is well developed and flat, varying but little throughout. The antennae are variable within generic limits in *Gyrophaena* only, as here considered, seldom notably long and always bristle with coarse erect setae, the four basal joints being slender and usually forming a distinctly demarcated pedestal or stem for the stouter apical part, though in several genera and in one group, assumed for convenience to form a part of *Gyrophaena*, where the antennae are gradually incrassate distally, this is not so evident; the third joint is always distinctly longer than the fourth, which is generally much the smallest, but in *Diestota*, the fourth joint in size and vestiture belongs with the apical rather than the basal part. The maxillary palpi are rather short, sparsely setose, with the third joint more or less compressed and the fourth extremely slender and acicular. The legs are short or moderate, the four basal joints of the hind tarsi equal or with the first somewhat longer than the others; the claws are

very slender and but slightly arcuate. The middle coxae are always widely separated, the sterna between them forming a smooth subcontinuous surface, usually broken only by a more or less fine transverse suture, the mesosternal process never being free, thus contrasting greatly, in the structure of the intermesocoxal parts, with the preceding subtribe Bolitocharae. In the formation of the sternal processes, antennae and inflexion of the hypomera, the genera *Diestota* and *Encephalus* stand at opposite extremes of the series, the former being an annectant type. The genera represented in my cabinet at the present time may be readily identified by the following characters: —

Hypomera feebly inflexed, in great part visible from a lateral viewpoint.. 2

Hypomera strongly inflexed, wholly invisible from a direct side view.... 8

2 — Mesosternal process shorter, extending nearly to or somewhat beyond the middle of the acetabula, broadly truncate and abutting against the broad metasternal projection which extends for some distance anteriorly between the coxae..... 3

Mesosternal process extending throughout the length of the coxae, the metasternum not or only very slightly projecting anteriorly between them and truncate or rounded..... 7

3 — Antennae gradually thicker from the base of the third joint to the tip, the eleventh joint unusually developed and as long as the preceding three combined; head free, transverse, the eyes well developed, not very prominent, finely faceted and closely setulose; neck narrow, scarcely a third as wide as the head; prothorax obtrapezoidal, having an impression before the scutellum; mesonotum broadly angulate, separated from the elytra throughout the width by a distinct depression; elytra well developed; abdomen parallel, the first three tergites impressed at base, gradually less deeply; middle coxae moderately widely separated, the mesosternal process not extending quite to the middle of the acetabula, feebly carinate along the middle and squarely truncate at apex, where it meets the equally truncate tip of the long metasternal projection; legs rather short, the tarsi stouter than usual. Europe.

***Diestota**

Antennae less developed and with a smaller terminal joint as in *Gyrophaena Brachida* and *Phaenogyra*, more or less abruptly enlarged beyond the fourth joint, sometimes gradually thicker from the base of the latter to the tip; neck very wide, the head deeply set in the apex of the prothorax; mesonotum separated from the elytra by a feebler depression, generally obsolete along the scutellum; mesosternum without trace of carina, the coxae very widely separated..... 4

4 — Eyes moderate in size, finely faceted; first abdominal segment narrowly and feebly impressed at base, the second less distinctly and the third very obsolete; mesosternal process extending distinctly beyond the

- middle of the acetabula; elytra with asperate punctures throughout; body minute in size..... 5
- Eyes very large, occupying the entire sides of the head, very coarsely faceted, the tempora obsolete; mesosternal process extending scarcely to the middle of the acetabula; elytra with very feeble and sparse or irregular sculpture; body larger in size..... 6
- 5 — Metasternal projection truncate at tip, abutting against the mesosternum throughout its width; antennae gradually incrassate from the fourth joint to the tip; elytra very long; first two abdominal segments equal in length. Europe.....***Agaricochara**
- Metasternal projection rounded at tip, touching the mesosternum only at the middle; antennae shorter, abruptly dilated beyond the fourth joint, the last seven joints forming a loose parallel club; elytra short; basal segment of the abdomen much shorter than the second. Atlantic North America.....**Eumicrota**
- 6 — Mesosternal process broadly sinuate at tip, separated from the arcuato-truncate tip of the metasternal projection by a very short discontinuity on exactly the same level; antennae slender, gradually incrassate from the fourth joint to the tip; abdomen with the first segment as long as the succeeding, the first three tergites broadly, subequally and distinctly impressed at base, the fourth also feebly concave almost throughout its extent; elytra moderate in length, always longer than in *Eumicrota* but much shorter than in *Agaricochara*; integuments thin and translucent as in *Gyrophæna*. Atlantic regions of North America.
- Phanerota**
- 7 — Body nearly as in *Phanerota* but with the eyes moderate in size and finely faceted and the abdominal segments gradually decreasing in length toward base, the first two tergites rather narrowly, more abruptly and distinctly, though not strongly, impressed at base, the third and fourth broadly and feebly impressed and the fifth also usually somewhat concave in the median part of the disk; prothorax variable in form, the elytra moderately developed and feebly sculptured as a rule, as in *Phanerota*; antennae variable, either gradually incrassate from the fourth joint to the tip or with a long loose parallel club composed of the outer seven joints; metasternum broadly arcuate, the mesosternal process arcuato-truncate, with obliterated suture. Cosmopolitan.....**Gyrophæna**
- Body minute, nearly similar but with dense integuments, smaller and more elongate head and longer elytra, punctate as in *Agaricochara*; abdominal segments slightly decreasing in length toward base, the first three tergites rather narrowly and feebly though distinctly and equally impressed at base, the fourth and fifth scarcely at all impressed; antennae gradually incrassate from the fourth joint to the tip, slender; mesosternal process extending to the extreme tip of the acetabula, where it is transversely truncate, abutting against the truncate or scarcely arcuate metasternum. Europe.....***Phænogyra**
- 8 — Mesosternal process extending to the extreme tips of the coxæ, very broad and abutting closely against the metasternum, the suture distinct and transversely rectilinear; head as in *Gyrophæna*, the neck very broad, the eyes moderate and finely faceted; antennae slender,

gradually incrassate from the fourth joint to the tip, the last joint moderate; body very stout, convex, the prothorax transverse, the elytra short; abdominal segments decreasing only slightly in length toward base, the first three tergites feebly impressed basally; integuments dense.

Europe..... * **Brachida**
Mesosternal process extremely wide, nearly as in *Brachida*, extending to the posterior limits of the acetabula, where it is separated from the metasternum by a perfectly straight transverse suture; body very short, stout, convex, the head transverse, strongly deflexile, the eyes moderate, very prominent and finely faceted, the sides of the head rapidly converging behind them; antennae short, strongly incrassate distally from the small globular fourth joint; abdomen very short, rounded at the sides and constricted at base. Europe..... * **Encephalus**

The foreign genera indicated above may be further alluded to as follows: —

DIESTOTA Rey.—The outline characters of the table are taken from a specimen of the rare species noted in the catalogue of Heyden, Reitter and Weise under the name *mayeti* Rey, and kindly given me by Mr. Fauvel, who has also placed the name *testacea* Kr., on the same label, but I have been unable to find the latter name in the catalogue mentioned. *Diestota* is at once distinguished from any of the other genera of the subtribe by its narrow neck and disengaged head, and is in many respects a connecting bond between the *Gyrophænae* and *Bolitocharae*, though apparently more properly a member of the former subtribe; at the same time, it may more appropriately form the type of a separate subtribe as maintained by Rey. Dr. Sharp has referred a number of Mexican and South American species to this genus, but the accuracy of this identification is open to some doubt.

AGARICOCHARA Kr.—This genus is very far from being a subgenus of *Gyrophæna*, as stated in the catalogue referred to above, the structure of the intermesocoxal parts prohibiting any such close alliance. The species are minute, with dense punctured integuments and with more elongate elytra than in any other genus of the subtribe. In some characters it betrays a rather close affinity with *Eumicrota*, but may be readily distinguished by the characters of the table, which are taken from *A. laevicollis* Kr.

PHAENOGYRA Rey.—The small and more elongate head,

elongate elytra, dense integuments and character of the punctuation seem to indicate the validity of this genus also, though it is much more closely allied to *Gyrophæna* than is *Agaricochara*, as shown by the conformation of the intermesocoxal parts. The internal inclosure of the middle acetabula by the mesosternum alone, without trace of anterior advancement of the metasternum, is a singular and striking character, in which it differs completely from *Agaricochara* and *Eumicrota*, but which it shares with *Brachida*. The characters of the table are drawn from *P. strictula* Er. and *polita* Grav.; *boleti* L., which is placed under *Phænogyra* in the European catalogue, does not belong there but is an *Agaricochara*.

BRACHIDA Rey.—This is one of the most isolated genera of the subtribe, characterized by a stout, compact body, dense integuments, regular system of punctuation and very widely separated middle coxæ, with the broad mesosternal process extending throughout their length and abutting squarely against the broad truncate metasternum. It differs from any of the preceding genera in having strongly inflexed hypomera. The type is *Brachida exigua* Heer (= *notha* Er.), as stated in the European Catalogue of 1891.

ENCEPHALUS Westw. — The preceding remark, relating to the isolation of *Brachida*, applies with even more force to this genus, which is a highly specialized type, remarkably distinct from any other of the subtribe in the power of deflexing the head upon the sterna and in the rounded, basally constricted abdomen. The prothorax and elytra are extremely transverse and subequal in width in the species before me, assumed as the type and identified by Mr. Reitter as *Encephalus complicans* Westw.

The genus *Cyphea* Fauv., may belong in the present subtribe, but I have no representative example upon which to base an opinion.

Eumicrota n. gen.

The rather numerous species of this genus may be readily known by their denser, generally black or blackish integu-

ments, regular system of punctuation, short elytra and small size, some of them being so minute as to be comparable only with *Ptilium*, of the Trichopterygidae. The secondary male sexual characters are frequently complex, consisting of small spines or protuberances on the dorsal surface of the abdomen, but, in other forms, these secondary characters are very feeble. The species are moderately numerous, those before me at present being separable by the following characters:—

- Antennae pale in color.....2
 Antennae black or blackish beyond the fourth joint.....12
 2 — Species less minute, about 1.0 mm. or more in length.....3
 Species very minute, much under 1.0 mm. in length.....11
 3 — Small asperate punctures of the elytra very sparse; male with strongly marked secondary sexual characters. Form rather stout, subparallel, convex, shining, blackish-piceous in color, the elytra very slightly paler, uniform; abdomen black, especially behind; integuments rather coarsely micro-reticulate throughout, the pubescence very short, sparse and inconspicuous; head transverse, finely, sparsely punctate; prothorax twice as wide as long, a third or fourth wider than the head, widest near the base, the sides arcuate, the surface minutely, very sparsely punctate throughout, with a small rounded impression before the scutellum; elytra strongly transverse, slightly wider and longer than the prothorax; abdomen not quite as wide as the elytra, parallel; legs short, slender, pale. *Male* having a short erect spiniform process at the middle of the apex of the first tergite, flanked on each side by a very minute marginal angulation, the fourth tergite with two small, suberect, spiniform processes on the disk just before the apex, separated by about a seventh of the total width of the plate, the fifth with two small and more obtuse, obliquely cariniform processes, more approximate and at a greater distance from the apex; sixth angulate at tip, the angle reflexed. Length 1.0–1.5 mm.; width 0.35–0.45. mm. New York (Catskill Mts.), District of Columbia, Missouri (St. Louis) and Texas (Dallas). [= *Gyrophaena* corr. Er.].....**corruscula** Er.
 Small asperate punctures more close-set; male with feeble secondary sexual characters, chiefly affecting the emargination of the sixth tergite.....4
 4 — Elytra black, the humeri testaceous. Body stout, compact, polished, micro-reticulate throughout, the lines fine; color dark testaceous, the abdomen clouded with blackish except toward base; head large, sparsely punctate at each side of the median line; prothorax transverse but not quite twice as wide as long, only very slightly wider than the head, finely, sparsely, irregularly punctate at each side of the impunctate median line, not impressed before the scutellum, the base rather strongly arcuate; elytra strongly transverse, a fifth wider and fully a fourth longer than the prothorax, finely, not very closely, asperulately punctate; abdomen at base almost as wide as the elytra, narrowed and arcuate at the sides thence posteriorly; legs short, slender, pale flavate in color. *Male* with the sixth tergite broadly produced at apex, the

lobe semicircularly emarginate, the lateral projections moderately acute. Length 1.2 mm.; width 0.45 mm. Pennsylvania (near Philadelphia).

humeralis n. sp.

- Elytra uniform in coloration throughout or with the humeri almost imperceptibly paler.....5
 5 — Elytra very short, but slightly longer than the prothorax.....6
 Elytra very distinctly longer than the prothorax.....10
 6 — Abdomen black or blackish throughout when mature.....7
 Abdomen dark testaceous, clouded with black posteriorly.....9
 7 — Prothorax less transverse, evidently less than twice as wide as long.

Form only moderately stout, polished, reticulate, piceous in color, the abdomen blackish, the legs and antennae bright flavate; head nearly as in *humeralis*; prothorax slightly wider than the head, about three-fourths wider than long, finely, sparsely punctate, without distinct median impunctate line, very obsoletely impressed before the scutellum, the base strongly arcuate; elytra slightly wider than the prothorax, the suture equal in length to the median line of the latter, the punctures fine and not very close-set, nearly as in *humeralis*, the abdomen nearly similar. *Male* with the produced lobe of the sixth tergite deeply and parabolically emarginate throughout its width, the emargination wider than deep, the lateral projections very narrowly obtuse at tip. Length 1.0 mm.; width 0.38 mm. Texas (Dallas), — H. F. Wickham.

texanella n. sp.

- Prothorax extremely transverse, more than twice as wide as long..... 8
 8 — Form stout, compact, suboval, polished, blackish-piceous, the legs and antennae flavate; micro-reticulation distinct as usual; pubescence sparse, stiff and suberect; head as in *humeralis* but relatively smaller; prothorax very short, distinctly wider than the head, the sides strongly arcuate, the base broadly so, not impressed, very finely, sparsely and irregularly punctured except along a very ill-defined median line; elytra only very slightly wider than the prothorax, the suture very slightly longer than the median line of the latter, the punctures fine and rather more close-set than in the two preceding species; abdomen similar. *Male* with the emargination of the broad median lobe of the sixth tergite circular and shallow, nearly three times as wide as deep, the lateral projections broadly obtuse at tip. Length 0.95-1.2 mm.; width 0.38-0.4 mm. North Carolina (Asheville) to Texas. [= *Gyrophæna soc. Er.*].....*socia* Er.

Form nearly similar, polished, strongly micro-reticulate, the head and prothorax black with a feeble piceous tinge, the elytra slightly paler, piceous, with the humeri generally very slightly paler piceous; abdomen black throughout, the legs and antennae flavate; head as in *socia*, the prothorax nearly similar, being quite as distinctly wider than the head and more than twice as wide as long, but with the sparse punctures rather stronger and the impunctate median line more convex or bordered at each side by a feeble impression; elytra much more distinctly wider than the prothorax, the humeri rounded and somewhat exposed, the suture slightly longer than the median line of the prothorax, the punctures fine, asperulate and close-set; abdomen similar. *Male* with the lobe of the sixth tergite broader and more broadly emar-

ginate, the emargination extending from side to side of the apex, circularly rounded, shallow and between three and four times as wide as deep, with the adjoining surface feebly swollen at the middle, the lateral projections subrectangular, owing to the posteriorly diverging sides, and but slightly obtuse. Length 1.1-1.25 mm.; width 0.45-0.55 mm. Missouri (St. Louis).....*melania* n. sp.

- 9—Body only moderately stout, shining, strongly reticulate as usual, pale piceous, the head blackish, the elytra faintly more flavescent, uniform throughout; abdomen dark to pale testaceous, clouded with piceous-black before the apex, the legs and antennae bright flavate; head smaller than usual, distinctly but sparsely punctate at each side of the rather broad median impunctate line; prothorax twice as wide as long, very distinctly wider than the head, transversely and rectilinearly truncate throughout the width at apex, arcuate at base, the sides rounded, the surface rather strongly and unusually closely punctate, feebly and approximately blimpresed before the scutellum; elytra distinctly wider than the prothorax, the suture but little longer than the median line of the latter, the humeri slightly exposed, rounded, the punctures fine but strong and close-set; abdomen nearly as wide as the elytra, gradually and rather strongly narrowed from base to apex. *Male* with the emargination of the lobe of the sixth tergite nearly as in *melania*, but with the lateral projections broader and more obtusely rounded and the swelling of the surface, adjoining the sinus at the middle, feebler and more diffuse. Length 1.1-1.4 mm.; width 0.35-0.5 mm. New York (Catskill Mts.).....*pallidula* n. sp.

- 10—Form moderately stout, subparallel, dark castaneous, the abdomen blackish posteriorly, the legs and antennae flavate, the last joint of the latter dusky; integuments shining, with the usual micro-reticulation; head nearly as in *pallidula* but more obsoletely punctate; prothorax twice as wide as long, distinctly wider than the head, the sides rounded but shorter than usual, the base not so evenly rounded but oblique and straight toward the sides, the broad median part more evidently lobate; surface finely, sparsely punctulate, not distinctly impressed; elytra fully a fifth wider and nearly one-half longer than the prothorax, the humeri distinctly exposed, the punctures fine, asperate and close-set; abdomen obviously narrower than the elytra and but feebly narrowed from base to apex. *Male* with the lobe of the sixth tergite parallel, its apex with a shallow and broadly rounded sinus more than twice as wide as deep and not much more than half as wide as the lobe, the surface of which is perfectly flat throughout, the lateral projections broad and broadly rounded at tip. Length 1.3 mm.; width 0.55 mm. Arizona (Pinal Mts.),—H. F. Wickham.....*pinalica* n. sp.

Form stout, subparallel, polished, the usual micro-reticulation obsolete except on the elytra and abdomen, castaneous, the head blackish, the abdomen flavo-testaceous, black posteriorly; legs and antennae flavate, the last joint of the latter dusky; pubescence suberect, moderately short and stiff; head and prothorax very minutely, sparsely and indistinctly punctulate, the latter distinctly wider than the head, obviously more than twice as wide as long, with the sides parallel and strongly rounded, the base arcuate, the surface not impressed; elytra but just

- visibly wider than the prothorax but distinctly longer, though less elongate than in *pinalica*, finely, rather closely punctate, the humeri feebly exposed in the reëntrant angle between the prothorax and elytra; abdomen evidently narrower than the elytra, subparallel. *Male* with the lobe of the sixth tergite smaller than usual, parallel, broadly rounded at the sides of the apex, emarginate in median two-fifths, the notch parallel and straight at the sides and feebly sinuate at the bottom, deeper than wide; fifth tergite with two feeble cariniform tubercles on the disk and separated by one-half the total width of the plate. Length 1.0 mm.; width 0.4 mm. Mexico (Puebla).....*azteca* n. sp.
- 11 — Body moderately stout, convex, compact as usual, shining, dark piceo-castaneous throughout, the legs and antennae pale flavate; integuments micro-reticulate, the head and pronotum obsoletely so; head rather large, very minutely, sparsely punctulate; prothorax twice as wide as long, distinctly wider than the head, the sides strongly rounded, the base strongly arcuate, subtruncate at the middle, the surface minutely, sparsely punctulate throughout, not impressed; basal border strong at the middle; elytra slightly wider and distinctly longer than the prothorax, finely, asperately and closely punctate, the humeri but little exposed; abdomen distinctly and regularly narrowed from the base, where it is nearly as wide as the elytra, to the apex, the sides nearly straight. *Male* with two very small slender posteriorly inclined, setigerous and spiniform processes just behind the median transverse line of the fifth tergite, separated by about a fourth of the total width of the plate, the sixth tergite strongly angulate at the middle. Length 0.7 mm.; width 0.35 mm. Mississippi (Vicksburg)....*minutissima* n. sp.
- Body somewhat stouter, shining, dark castaneous, the abdomen dark testaceous, clouded gradually with blackish posteriorly; legs and antennae bright flavate; integuments distinctly micro-reticulate throughout; head smaller, minutely, sparsely punctulate; prothorax fully twice as wide as long, very much wider than the head, finely, sparsely punctulate, with a feebly defined impunctate median line; sides strongly rounded, the base arcuate, feebly subtruncate toward the middle; elytra only just visibly wider but evidently longer than the prothorax, finely, asperulately and not very closely punctate; abdomen nearly as wide as the elytra, subparallel, arcuately narrowed near the tip. *Male* having two slender feeble arcuate carinae on the disk of the fifth tergite, separated by about a fourth of the width of the plate and slightly oblique toward each other posteriorly, the concave sides of the carinae internal; sixth tergite largely concealed in the type, but apparently obtusely lobed and rounded at the middle. Length 0.7 mm.; width 0.38 mm. North Carolina (Asheville).....*atoma* n. sp.
- 12 — Form very stout, parallel, convex, compact, polished, deep black, the legs, base of the antennae, extreme tip of the abdomen and legs piceous, the minute humeral umbones slightly pale; integuments reticulate with the usual very fine incised lines enclosing somewhat coarse meshes; head moderate, transverse, with a few very fine punctures toward the sides; eyes as usual; prothorax very short, distinctly more than twice as wide as long and fully a third wider than the head, strongly rounded at the sides, broadly arcuate at base, the surface with a few widely

scattered and irregular setigerous punctures, not at all impressed before the scutellum; elytra only very slightly wider than the prothorax but nearly one-half longer, parallel and straight at the sides, the humeri scarcely exposed, the punctures fine, asperulate and sparse; abdomen more finely and much more strongly reticulate throughout, impunctate, parallel, feebly narrowed near the apex, about as wide as the elytra. *Male* having a short broad and rounded sublamellate process at the middle of the apical margin of the first tergite, the fourth tergite with a long erect and acutely pointed, very conspicuous spiniform process on the disk before the apex at each side at about one-eighth the width from the margin, the fifth plate with a broad subelevated flat apical edge, extending obliquely forward near each side, the sixth very acutely produced at the middle posteriorly, the lobe somewhat reflexed. Length 1.2-1.35 mm.; width 0.6-0.65 mm. Cuba (Cayamas), — C. F. Baker.

cornuta n. sp.

Corruscula is a rather common species but the males are very rare, there being only one among the sixteen specimens at hand; the contrary rule prevails, however, through the remainder of the genus, where the males greatly outnumber the females. *Cornuta* is a very remarkable species, having dorsal sexual marks on the tergum even more conspicuous than in *corruscula*, but these characters are very variable, one male before me having the long spines of the fourth plate reduced to small and very slender proportions; the broader thickened margin of the fifth tergite is scarcely at all developed in this example. *Azteca* is allied to *oblita* Shp., but apparently has the prothorax more nearly equal in width to the elytra and differs also in the paler basal parts of the abdomen and the closer elytral punctures. The genus *Eumicrota* will include in addition the South American *Gyrophæna punila* and *parvula*, of Sharp.

Phanerota n. gen.

The species of this genus are few in number but include some of the largest of the subtribe and appear to be peculiar to the North and South American continents. They may be known at once from *Gyrophæna* by the very large and coarsely faceted eyes, which occupy the entire sides of the head as in *Stenus*, but otherwise, and especially in coloration, in the diaphanous integuments and general facies, they greatly resemble that genus, with which they have been heretofore

confounded, except by Dr. Sharp, who suggests the propriety of their generic isolation. They are very decisively distinguished from *Gyrophæna* by the structure of the broad intermesocoxal parts, the metasternal projection advancing in *Phanerota* nearly to the middle of the acetabula, the mesosternal process being correspondingly abbreviated. The species vary to a remarkable degree in point of size, those in my cabinet being definable as follows:—

- Species inhabiting the Atlantic districts, including the Island of Cuba.... 2
 Species inhabiting the Peninsula of Lower California..... 7
 2—Eyes always separated on the front by distinctly more than twice their own width. Body stout, subparallel, moderately convex, highly polished, the integuments wholly devoid of trace of micro-reticulation, except the abdomen, which is finely and rather feebly reticulate; color pale flavate with distinct reddish tinge, the head, elytra in apical third or fourth, except at the suture, and fourth tergite, except at the lateral margins, black or piceous-black; head transverse with a number of rather coarse punctures toward the eyes; antennae slender, moderately incrassate distally, extending to about basal third of the elytra; prothorax not quite twice as wide as long, only very slightly wider than the head, parallel and rounded at the sides, arcuate at base, very remotely and obsoletely punctulate, the two punctures behind the middle, separated by about a fourth of the width, especially distinct; elytra well developed, about a fifth wider and one-half longer than the prothorax, finely, sparsely punctate, the humeri rather widely exposed; abdomen at base nearly as wide as the elytra, thence gradually narrower to the apex, very minutely, obsoletely punctulate toward the apices of the segments, sparsely, coarsely pubescent. *Male* with the outer apical angles of the elytra slightly swollen; sixth tergite with two short, widely separated porrect processes, rounded at tip and impressed on their outer sides posteriorly; between them the apex is produced in a short rounded lobe, very much shorter than the processes, the lobe being the apical outline of a broad smooth swelling of the surface; *female* with the elytral angles unmodified, the sixth tergite subconical with the apex truncate, the truncature sinuate throughout its width, the sinus about five times as wide as deep. Length 1.4–2.5 mm.; width 0.62–0.9 mm. Rhode Island and Pennsylvania. [= *Aleochara fasc.* Say (not preoccupied in *Phanerota*) and *vinula* Er.]..... **fasciata** Say
 Eyes more convex, separated on the front by not more than twice their own width 3
 3—Abdomen in great part pale, the blackish coloration involving the fourth tergite more or less, the apex always pale..... 4
 Abdomen in great part black, pale near the base and generally at the immediate apex..... 5
 Abdomen clearly bicolored, the anterior half pale, the posterior black, the line of demarcation abruptly defined and not nubilous or indefinite as it is in the two preceding groups, the apex not pale..... 6

4 — Form rather stout, shining, the head and pronotum very obsoletely micro-reticulate, the elytra rather strongly so, the abdomen distinctly; color pale flavate, the head piceous-black, the elytra broadly infumate toward the external apical angles; legs and antennae pale flavate as usual; head with scattered coarse punctures except broadly along the median line; prothorax very nearly twice as wide as long, distinctly wider than the head, which is relatively smaller than in *fasciata*, similar in outline and punctuation; elytra about a sixth wider and nearly one-half longer than the prothorax, with the humeri less exposed than in *fasciata*, the punctures similarly fine but not quite so sparse, especially toward the outer apical angles; abdomen nearly similar; antennae rather more incrassate distally. *Male* wanting; *female* with the sixth tergite nearly as in *fasciata*, the sinus at the apex rather more abruptly formed and more broadly transverse at the bottom but equally shallow. Length (much extended) 2.4–2.6 mm.; width 0.7–0.87 mm. New York (Catskill Mts.) *ocularis* n. sp.

Form as in *ocularis*, polished, pale flavate, the head and elytral apex — disappearing at the suture — black; head and pronotum without trace of micro-reticulation, the elytra and abdomen rather distinctly reticulate; head coarsely, sparsely punctate except along a broad median line, the antennae moderately incrassate distally; prothorax slightly, though distinctly, wider than the head, nearly twice as wide as long, rounded at the sides, broadly arcuate at base, with a few sparse punctures as in the preceding species; elytra slightly wider and one-half longer than the prothorax, the humeri only slightly exposed, the punctures unusually distinct and asperate but sparse; abdomen as in *ocularis*, the tergites punctulate only at the apices. *Male* with the two short apical processes of the sixth tergite nearly as in *fasciata*, the surface at the middle swollen, smooth and produced posteriorly in an acute lobe which nearly attains the line of apices of the processes; external apical angles of the elytra narrowly, distinctly and prominently swollen, the surface near them broadly concave. Length 2.2–2.4 mm.; width 0.8–0.85 mm. Texas (Dallas), — H. F. Wickham *angularis* n. sp.

Form less stout, smaller in size, polished, pale rufo-flavate, the head dark rufo-piceous, the elytra generally pale throughout, sometimes feebly infumate along the immediate apex externally; integuments of the anterior parts without trace of micro-reticulation, the elytra and abdomen very obsoletely reticulate; head nearly as in *angularis*; prothorax distinctly wider than the head, fully three-fourths wider than long, widest anteriorly with the sides rounded, more convergent thence to the base, the latter broadly arcuate, the surface with a few scattered punctures as in *fasciata*; elytra unusually short and transverse, slightly wider and about a third longer than the prothorax, finely, asperulately and very sparsely punctate; abdomen at base rather distinctly narrower than the elytra gradually tapering thence to the apex, the tergites finely punctulate except broadly toward base. *Male* with the short processes at the apex of the sixth tergite acutely angulate at tip, the median lobe advanced nearly to the line of their apices as in *angularis* but more broadly angulate, the surface more broadly and feebly swollen; external apical angles of the elytra only very feebly and broadly swol-

- len; *female* nearly as in *fasciata*. Length 1.4–2.3 mm.; width 0.7–0.76 mm. Florida (Palm Beach).....**floridana** n. sp.
- 5 — Body stout in form, polished, pale piceo-testaceous in color, the head and elytra, the latter broadly and gradually toward the external apical angles, black; legs and antennae flavate; head and pronotum finely, obsoletely micro-reticulate, the elytra and abdomen more coarsely and strongly so; head coarsely, sparsely punctate toward the sides, the prothorax rather distinctly wider than the head, nearly twice as wide as long, almost as in *fasciata* throughout; elytra slightly wider and one-half longer than the prothorax, the humeri only very narrowly exposed, rounded, the punctures very fine, asperulate and sparse; abdomen at base nearly as wide as the elytra, much narrower at apex, subimpunctate except sparsely along the apices of the tergites. *Male* with the two apical processes angulate at tip, the median lobe broadly angulate and advancing about half way to the line of their apices, the surface strongly swollen and smooth; external apical angles of the elytra only very narrowly and feebly, longitudinally swollen; *female* nearly as in *fasciata*, except that the emargination is rather broader and almost evenly circular in curvature between the angulate apices, the latter less dentiform. Length 1.3–2.3 mm.; width 0.65–0.85 mm. Missouri (St. Louis) and Indiana. [= *Gyrophaena diss.* Er.].
- dissimilis** Er.
- 6 — Form only moderately stout, subparallel, polished, smaller in size, pale rufo-flavate in color, the head and elytra black, the latter testaceous in anterior half at the sides, the pale color obsolete at the scutellum; head and pronotum finely and very obsoletely micro-reticulate, the elytra and abdomen somewhat strongly so; head with a few coarse sparse punctures except broadly along the median line; antennae moderate; prothorax distinctly wider than the head, almost twice as wide as long, nearly as in *fasciata* throughout; elytra slightly wider than the prothorax and but little more than a third longer, the humeri only slightly exposed, rounded, the punctures rather strong, asperate and sparse; abdomen at base subequal in width to the elytra, moderately tapering thence to the tip, sparsely punctulate along the apices of the dorsal plates as usual. *Male* with two short slender acute processes at the apex of the sixth tergite as usual, but with the bottom of the inclosed sinus only very feebly produced in the middle as a broadly rounded lobe; external apical angles of the elytra but very slightly and briefly swollen; *female* with the sixth tergite nearly as in *fasciata*. Length 1.3–1.8 mm.; width 0.65–0.78 mm. Cuba (Cayamas),—C. F. Baker.
- cubensis** n. sp.
- 7 — Body rather stout, suboval, polished, very pale luteo-flavate, the head piceous to black, the abdomen sometimes with a small infumate cloud at about the fourth tergite; legs and antennae very pale; head and pronotum not at all micro-reticulate, the elytra faintly and obsoletely, the abdomen very distinctly so; head with some scattered coarse punctures as usual, the eyes separated by scarcely twice their own width; antennae moderate; prothorax distinctly wider than the head, about twice as wide as long, widest rather distinctly before the middle, the sides more rounded anteriorly, the base arcuate, the surface nearly

as in *fasciata* and other species; elytra well developed, nearly a fourth wider and one-half longer than the prothorax, the humeri well exposed, the punctures fine and very sparse; abdomen at base nearly as wide as the elytra, rapidly tapering thence to the tip, subimpunctate as usual. *Male* with the elytra narrowly and feebly elevated for a short distance in front of the exterior apical angles, the sixth tergite concealed in specimens at hand; *female* with the sixth tergite emarginate nearly as in *fasciata*, the apices bounding the sinus obtusely rounded. Length 1.4-1.9 mm.; width 0.75-0.88 mm. Lower California (San Jose del Cabo and Sierra El Taste), — Chas. Fuchs..... *peninsularis* n. sp.

That form of *dissimilis* which is alluded to by Erichson as having densely and finely granulated elytra, is probably a wholly different species, and the large puncture at each side of the front, near the eyes, is not visible in any of my specimens and may be a deformity in the types described; otherwise the species which I have assumed to be *dissimilis* agrees well with the original description. In South America, *Phanerota* is represented at present by *Gyrophaena boops* and *debilis*, of Sharp.

Gyrophaena Mann.

This genus is composed of very numerous species, having considerable variety in facies and in the form and structure of the antennae and prothorax, but agreeing throughout in the conformation of the intermesocoxal parts, the mesosternal process being very broad and extending virtually throughout the length of the acetabula, where it meets the rounded and very short metasternal projection. The secondary sexual characters of the male are also very distinct as a rule and considerably diversified, and, as the males are usually as abundant as the females, we fortunately have here a very ready means for the estimation of specific values. The sixth tergite in the female is usually rounded and without special modification, but in a few species, such as *sculptipennis*, there is a broad shallow sinus at the apex of this plate, analogous to the sinus of the sixth tergite of the female so constant throughout the genus *Phanerota*. The punctuation of the elytra is generally, and perhaps to some degree universally, dual in nature, there being some scattered asperulate punctures, especially visible toward the external apical angles,

which bear the short, stiff, suberect hairs and others, irregular in size and disposition, which seem to be simply minute nude indentations of the surface of obscure origin; this sculpture is especially developed in such forms as *sculptipennis* and *subpunctata*. The tergites have each an apical or subapical series of small asperate setiferous punctures, the disk generally having in addition some very minute, sparsely scattered punctures except toward base, these latter bearing very short, decumbent and peculiarly arcuate hairs, only visible under high power. On the pronotum the two setigerous punctures, moderately close-set at basal third or fourth and another, at each side more posterior and near the margin, appear to be constant throughout the genus, and the other very sparse and smaller punctures are generally more closely aggregated in two irregular parallel longitudinal series, and, to some extent, remotely and irregularly scattered toward the sides. The thirty-two species in my cabinet may be conveniently classified as follows:—

- Antennae gradually incrassate from the fourth or fifth joint to the apex..... 2
 Antennae with the joints beyond the fourth abruptly wider, forming a long loose parallel or subparallel club..... 5
 2 — Prothorax but slightly narrower than the base of the elytra. Form stout, rather depressed, polished, pale flavate, the head dark rufopiceous, the elytra more whitish in color, with the outer apical part narrowly and faintly nublous with piceous, a faintly piceous cloud also occupying most of the fourth tergite; prothorax slightly darkened along the middle, sometimes inclosing an elongate pale spot in basal half; head, pronotum and elytra wholly devoid of trace of microreticulation, the abdomen very obsoletely reticulate; head transverse, with a few coarse punctures at each side, the antennae attaining basal third of the elytra, the fourth joint elongate, as long as the fifth, the tenth as long as wide; prothorax much wider than the head, three-fourths wider than long, rounded at the sides anteriorly, thence feebly narrowed to the broadly rounded basal angles, the base broadly rounded, distinctly reflexed throughout the width, the surface with two transverse pairs of submedial punctures, strongly impressed before and behind the middle of the length; elytra about a fifth wider and nearly one-half longer than the prothorax, the humeri well exposed, the setigerous punctures sparse and asperate at the sides and toward the external angles, elsewhere with very fine, sparse, nude and irregularly distributed punctules; abdomen at base slightly narrower than the elytra, at apex distinctly narrower. *Male* with two short acute processes at the apex of the sixth tergite, separated by more than two-fifths

- of the basal width, the bottom of the inclosed sinus feebly and broadly lobed, the apex of the lobe with two small acute and approximate cusps, the adjoining surface feebly and obliquely bitumorose; *female* with the sixth tergite broadly arcuato-truncate at tip. Length 1.9–3.0 mm.; width 0.68–0.88 mm. New York (Catskill Mts.) and Pennsylvania Westmoreland Co.).....***vitrina* n. sp.**
- Prothorax much narrower than the base of the elytra, generally distinctly obtrapezoidal in form..... 3
- 3 — Fourth antennal joint elongate; antennae pale. Body stout in form, rather convex, shining, dark in color, the head black, the prothorax and entire abdomen, except feebly toward base, blackish-piceous, the latter flavescens at tip, varying to entirely pale with a narrow fascia; elytra flavo-testaceous, blackish at the external apical angles; legs and antennae flavate; head strongly, the pronotum and abdomen more feebly though obviously micro-reticulate, the elytra very obsolete so; head as in *vitrina*, but with more numerous and smaller sparse punctures toward the sides; prothorax slightly, though evidently, wider than the head, one-half wider than long, rounded at the sides anteriorly, thence strongly narrowed toward base, the latter broadly, evenly arcuate and finely reflexed, the surface with two medial longitudinal series of punctures, also feebly impressed before the scutellum, the impressions with some fine nude punctules; elytra a third wider and longer than the prothorax, the humeri rather widely exposed, rounded, the punctures very fine and sparse, nearly as in *vitrina*; abdomen wide, narrowed slightly toward tip. *Male* with the sixth tergite broadly arcuato-truncate at tip, the apex having a very shallow, circularly rounded, abruptly formed sinus about a fourth as wide as the segment, the sinus with two very small tuberculous asperities almost equally trisecting its width, or more approximate, the ends of the sinus each marked by a small oblique compressed tubercle, generally not projecting posteriorly behind the edge, the surface before the sinus with two more distinct and rather widely separated and numerous smaller setigerous tubercles; *female* with the sixth tergite arcuato-truncate throughout the width. Length 2.0–2.6 mm.; width 0.66–0.8 mm. New York (Catskill Mts. to Lake Superior).....***flavicornis* n. sp.**
- Fourth antennal joint not all elongate, rounded or feebly obtrapezoidal; antennae dark; smaller species..... 4
- 4 — Form moderately stout and shining, dark in color, the entire surface strongly micro-reticulate, the abdomen rather more finely; head and antennae black, the three basal joints of the latter flavate; prothorax blackish, the elytra flavo-testaceous, black at the outer apical angles, the abdomen rufo-testaceous, with the fourth and most of the adjoining tergites black; legs flavate; head finely, sparsely punctate laterally, the antennae rather stout distally, but little longer than the head and prothorax, the latter strongly transverse, about three-fourths wider than long, slightly but distinctly wider than the head, feebly obtrapezoidal, rounded at the sides anteriorly, the apical and post-median pairs of punctures most distinct; elytra a third wider and one-half longer than the prothorax, the humeri well exposed, rounded, the punctures fine, distinct externally toward tip, obsolete toward the scutellum; abdomen somewhat arcu-

ately narrowed from base to apex, nearly as wide as the elytra. *Male* with four or six subequal, subequidistant, and elongate asperities near the apex of the fifth tergite in almost median half, the sixth with two long, slender and aciculate porrect processes at tip, separated by half the width, the processes gradually and feebly curved inwardly and to some extent upwardly toward apex, the inclosed sinus feebly curved, with an extremely feeble obtuse cusp at the middle; fine and dense asperities of the seventh tergite parted along the median line by a feebly impressed glabrous channel; *female* not at hand. Length 1.4 mm.; width 0.65 mm. Utah (Provo),—H. F. Wickham.....*uteana* n. sp.

Form nearly similar but more parallel, with wider head and relatively narrower hind body; coloration dark, the head blackish, the prothorax but slightly less dark, the antennae blackish-piceous, flavate toward base; elytra dark flavo-testaceous, infumate toward the apical angles externally, the abdomen black, with the tip not very obviously paler, gradually paler and dark though clear rufo-testaceous in about basal half, the legs pale; upper surface distinctly micro-reticulate throughout, the elytra most coarsely and feebly so; head feebly and sparsely punctulate laterally, the antennae rather strongly incrassate distally, with the outer joints distinctly transverse; prothorax scarcely visibly wider than the head, less transverse than in *uteana*, about one-half wider than long, the sides parallel and not obviously converging posteriorly, feebly rounded, more strongly at apex, the base arcuate, the angles rather distinct but rounded, the four post-median punctures alone distinct; elytra two-fifths wider and one-half longer than the prothorax, less transverse than in *uteana*, finely punctate externally and apically, subimpunctate elsewhere, the fine punctules very sparse but aggregated into a narrow irregular series parallel and very close to each sutural bead; abdomen subparallel, slightly narrower than the elytra. *Male* unknown; *female* with the sixth tergite rounded behind. Length 1.5 mm.; width 0.68 mm. Wisconsin (Bayfield),—H. F. Wickham.....*gaudens* n. sp.

Form stouter and less parallel, nearly as in *uteana*, convex; color dark, nearly as in *uteana* throughout, the entire upper surface almost similarly reticulate; head deep black, with a very few sparsely scattered coarse punctures at each side of the front; antennae short, strongly incrassate near the tip, the outer joints distinctly transverse, the tenth much longer as well as wider than the ninth and less transverse, the eleventh fully as long as the preceding two combined; prothorax two-fifths wider than long, distinctly wider than the head, the sides broadly rounded anteriorly, thence just visibly converging and straighter to the base, the base arcuate and narrowly reflexed as usual, the four post-median punctures strong; elytra two-fifths wider and one-half longer than the prothorax, punctured nearly as in *gaudens*, the humeri widely exposed at base; abdomen at base distinctly narrower than the elytra, thence arcuately tapering to the tip. *Male* with two small oblique elliptical and smoothly rounded, though slightly elevated tubercles, near the apex of the fifth tergite and narrowly separated, with two more elongate and feeble asperities external thereto, the sixth with two acutely pointed, rather long porrect processes at tip, gradually curved slightly inward, finely carinate externally and separated by half the total width, the in-

closed sinus feebly lobed toward the middle, the lobe bearing two fine, aciculate and very approximate processes extending posteriorly half way to the line of the apices of the principal processes, the adjoining surface with two oblique smooth elliptical tumors, similar to those of the fifth tergite, and, between each of these and the base of the large processes, a small setigerous asperity; *female* with the sixth tergite broadly rounded. Length 1.3-1.6 mm.; width 0.63-0.78 mm. Colorado (Boulder Co.)..... *monticola* n. sp.

Form more slender and parallel, distinctly depressed, the elytra flat; entire surface micro-reticulate, the abdomen very feebly so toward base, the elytra strongly; head darker, the prothorax rather pale, rufo-piceous, the antennae dark flavate toward base, more slender than in *monticola* and with the ninth and tenth joints similar and slightly transverse like the preceding joints; elytra very pale flavate, the outer apical angles rather abruptly piceous-black; abdomen pale and slightly more rufo-flavate, the fourth tergite black and the two adjoining piceous; legs pale flavate; head moderate, with some coarse scattered punctures at each side of the front; prothorax but very slightly wider than the head, nearly three-fourths wider than long, the sides subparallel and strongly arcuate, the base arcuate and finely reflexed as usual, punctured as in the preceding species; elytra two-fifths wider and longer than the prothorax, transverse, the humeri somewhat well exposed, rounded, the punctures very fine and sparse, disposed as usual; abdomen but slightly narrower than the elytra, parallel and straight at the sides, narrowed only slightly at apex. *Male* with four small, subequal and equidistant asperities near the tip of the fifth tergite in median third, the sixth with two long, very slender, acutely pointed and feebly arcuate porrect processes, widely separated and slightly curved inward, much more slender than in *monticola*, the bottom of the inclosed sinus just concealed in the only males at hand, but evidently without porrect processes of any decided prominence. Length 1.5 mm.; width 0.63 mm. British Columbia (Kamloops and Glenora). — H. F. Wickham..... *pacifica* n. sp.

5 — Antennal joints five to ten as long as wide or nearly so, sometimes slightly elongate

Antennal joints five to ten always distinctly transverse, forming a usually stouter and more compact club; species always very small in size.... 13

6 — Prothorax strongly transverse, almost as wide as the base of the elytra. Body stout, fusiform, moderately convex, polished, the head and pronotum very obsoletely micro-reticulate, the latter almost completely smooth; head blackish-piceous, the antennae and legs pale; prothorax pale luteous, broadly infumate toward the middle; elytra whitish-flavate, not distinctly darker at the outer apical angles; abdomen pale flavate, the median part of the fourth tergite black, the neighboring surface infumate; head with very few coarse punctures toward the eyes, the antennae rather stout, with joints five to ten slightly wider than long, and just visibly increasing in width but virtually forming the parallel club of the remaining species, the fourth joint shorter than wide; eyes small; prothorax much wider than the head, fully three-fourths wider than long, the sides subparallel, broadly rounded, the base rather strongly arcuate, the post-median pair of punctures strong;

- elytra scarcely a fourth wider and two-fifths longer than the prothorax, the humeri broadly rounding to the prothorax, feebly and sparsely punctate except toward the scutellum; abdomen arcuately and feebly tapering from base to apex. *Male* with a small, narrow, somewhat elongate tubercle on the median line of the fifth tergite near the hind margin; sixth produced in the middle in a short and broadly, evenly rounded lobe, a third as wide as the segment, the lobe very feebly and broadly biimpressed; *female* wanting. Length 2.2 mm.; width 0.83 mm. New York (Catskill Mts.).....**lobata** n. sp.
- Prothorax generally obtrapezoidal, much narrower than the base of the elytra..... 7
- 7—Elytra very minutely, sparsely and inconspicuously punctured as usual, smooth toward the inner basal angles..... 8
- Elytra distinctly punctured.....12
- 8—Fifth antennal joint distinctly wider than long. Body rather stout, polished, feebly micro-reticulate throughout, the head piceous-black, the antennae dusky, flavate toward base; prothorax rufo-flavate, the elytra pale but less rufous, not darker at the apical angles, the abdomen flavate, with a feeble cloud on the fourth tergite, the legs pale; head impressed and strongly, sparsely punctate at each side of the front, the eyes small, very prominent; antennae rather short, extending to about basal third of the elytra, with joints five to ten stout, slightly transverse, just visibly increasing in width, forming virtually a subparallel club; prothorax two-thirds wider than long, slightly wider than the head, the sides parallel and somewhat strongly, evenly arcuate, slightly biimpressed before the middle of the base, the sparse punctures as usual; elytra fully two-fifths wider and about one-half longer than the prothorax, the humeri widely exposed at base, rounded; abdomen nearly as wide as the elytra, gradually and feebly tapering from base to apex. *Male* with eight elongate, subequidistant asperities on the fifth tergite near the apex, the two median rather less elongate and more acutely pointed posteriorly; sixth with two long compressed and inwardly arcuate processes at tip in median two-fifths, the processes obtusely rounded at tip, oblique in plane and rather carinate externally, the inclosed sinus subequally trisected by two straight cylindric porrect processes which are slightly bulbous at tip and about attaining the line of the apices of the lateral processes, the surface longitudinally tumid in prolongation of each of the medial processes; *female* unknown. Length 2.3 mm.; width 0.85 mm. New York (Catskill Mts.).....**involuta** n. sp.
- Fifth antennal joint at least as long as wide and generally longer..... 9
- 9—General form more elongate and subparallel.....10
- General form stouter and more fusiform, the abdomen more rapidly and strongly narrowed from base to apex.....11
- 10—Form moderately stout, polished, feebly micro-reticulate throughout, pale flavate throughout, the head irregularly clouded with rufo-piceous, the abdomen with a very faint cloud involving the fourth tergite and the elytra more silvery; head not very transverse, sparsely punctate laterally, the antennae more developed than in any other species, pale flavate throughout, extending about to the middle of the

elytra, the outer seven joints forming a long loose stout and parallel club, joints five to eight distinctly longer than wide, the next two fully as long as wide, the eleventh much shorter than the two preceding combined; prothorax only slightly wider than the head, one-half wider than long, feebly obtapezoidal, the sides more rounded anteriorly, the base broadly arcuate, the sparse punctures all feeble; elytra well developed, two-fifths wider and fully one-half longer than the prothorax, the humeri well exposed and rounded; abdomen at base distinctly narrower than the elytra, thence moderately tapering to the tip. *Male* having a small, feebly elevated semicircle in about median tenth or less and near the apex of the fifth tergite, the opening of the arc anterior; sixth with two short and strongly inflexed processes in median third of the apex, the inclosed sinus transverse at the bottom, with the edges feebly undulated and bearing about five very small setae, the surface scarcely modified, smooth and polished; *female* with the sixth tergite truncate, otherwise unmodified. Length 2.2 mm.; width 0.78 mm. New York (Catskill Mts.). **antennalis** n. sp.

Form moderately stout, polished, feebly micro-reticulate throughout, the head black, the remainder rufo-flavate, the elytra flavate, blackish at apex except toward the suture, the abdomen with a blackish cloud involving the fourth and half of the fifth tergite; legs and antennae pale, the latter gradually somewhat infumate distally, extending nearly to the middle of the elytra, moderately stout, the fifth and sixth joints elongate, the next two as long as wide, the ninth and tenth very slightly wider than long, the eleventh distinctly shorter than the two preceding together; head with rather numerous sparse punctures toward the sides; prothorax very distinctly wider than the head, and, like the latter, relatively larger than in *antennalis* but otherwise nearly similar, except that the sides are virtually parallel; elytra nearly similar, except in the blackish apex; abdomen but little narrowed behind, distinctly narrower than the elytra. *Male* with sexual characters nearly like those of *antennalis*, the arcuate tumidity at the middle of the fifth tergite near but at some distance from the apex, much larger and occupying about an eighth of the total width, the short strong and inwardly projecting apical processes of the sixth, separated by a third of the width, nearly similar, the transverse bottom of the inclosed sinus with three undulations, each bearing a short seta; *female* with the sixth tergite broadly, evenly arcuate at tip. Length 2.3 mm.; width 0.78 mm. Lake Superior (Isle Royale).....**insolens** n. sp.

Form slender, polished, the head and abdomen distinctly, the elytra very obsoletely, micro-reticulate, the pronotum without trace of reticulation; head black, the prothorax piceous-black, the elytra pale silvery-flavate, without distinct darker marking, the abdomen more rufous, with the usual blackish cloud at the fourth tergite; head rather small, with very few fine punctures at each side, the antennae clear flavate throughout, rather slender, extending to about the middle of the elytra, the fifth joint elongate, six to ten as long as wide; prothorax nearly three-fifths wider than long, distinctly wider than the head, strongly obtapezoidal, the sides rounded anteriorly, thence strongly converging to the broadly arcuate base, the usual punctures distinct; elytra shorter

than in the two preceding species, strongly transverse, a fourth wider and one-third longer than the prothorax, the humeri moderately exposed at base, narrowly rounded; abdomen narrow, feebly tapering, very evidently narrower than the elytra. *Male* with a small, posteriorly rounded, low tubercle near the hind margin of the fifth tergite, the tubercle abruptly elevated posteriorly, its surface gradually sloping, expanding and gradually disappearing anteriorly, the sixth with two short stout and inwardly curved processes in median two-fifths of the apex, the bottom of the inclosed sinus with about three undulations, each bearing a very minute setose process, the adjacent surface becoming smooth and punctureless near the sinus; *female* with the sixth tergite evenly and broadly arcuate at tip. Length 1.7–2.0 mm.; width 0.66–0.76 mm. New York (Catskill Mts.).....**fuscicollis** n. sp.

Form slender, polished, the entire upper surface very feebly micro-reticulate, the elytra scarcely visibly so, pale flavate in color, the head blackish but paler toward the middle of the front, the elytra more silvery, without dark maculation, the cloud of the abdomen very diffuse, pale and barely visible; pronotum somewhat mottled with clouded areas; antennae flavate, extending to the middle of the elytra, rather stout, fifth to seventh joints slightly elongate, eighth to tenth as long as wide to slightly transverse, the eleventh much shorter than the two preceding combined; prothorax only very slightly wider than the head, three-fifths wider than long, distinctly obtusely trapezoidal, nearly as in *fuscicollis*; elytra much longer, only slightly transverse, two-fifths wider and three-fifths longer than the prothorax, the humeri widely exposed at base; abdomen much narrower than the elytra, feebly tapering throughout. *Male* with the fifth tergite wholly unmodified, the sixth without trace of apical processes but with the apex broadly emarginate in median third, the sinus broadly, transversely subrectilinear and unmodified at the bottom and about five times as wide as deep, its sides marked by distinct obtuse angles, the surface of each being feebly swollen; *female* wanting. Length 1.9 mm.; width 0.66 mm. New York (Catskill Mts.).
modesta n. sp.

11 — Form stouter than in *modesta*, with smaller head and more transverse elytra and with shorter antennae, smaller head and slightly less developed antennae than in *antennalis*, the integuments denser than in either, shining. micro-reticulate throughout, flavate, the prothorax bright and immaculate, paler than the elytra, which are more luteo-flavate, the head piceous, the cloud of the abdomen small and very feeble; head small, with a few sparse and distinct punctures at each side, the antennae flavate, rather stout, extending to basal third of the elytra, of the same type as in the four preceding species; prothorax fully two-thirds wider than long, much wider than the head, the sides subparallel and broadly arcuate, the usual punctures distinct but small; elytra strongly transverse, two-fifths wider and longer than the prothorax, the humeri rather widely exposed, rounded; abdomen slightly narrower than the elytra, gradually and somewhat strongly tapering from base to apex, with feebly arcuate sides. *Male* unknown; *female* with the sixth tergite broadly, evenly rounded at apex. Length 1.75 mm.; width 0.7 mm. New York (Catskill Mts.).....**gilvicollis** n. sp.

Form stout, fusiform, allied closely to *insolens* and almost similar in coloration and in the general nature of the male sexual characters, but smaller, with more rapidly tapering abdomen and much more strongly converging sides of the prothorax basally, polished, micro-reticulate throughout; the head black; prothorax pale, clouded along the middle, the elytra pale, blackish on the flanks except at the humeri, broadly along the apex and narrowly along the suture to the base; abdomen pale rufous, clouded at and near the fourth tergite; head with a few sparse punctures as usual; antennae stout, flavate, gradually infumate distally, the fifth joint elongate, the others to the tenth gradually shorter, the latter perceptibly wider than long; prothorax much wider than the head, one-half wider than long, strongly obtrapezoidal, punctured as usual; elytra two-fifths wider and one-half longer than the prothorax, the humeri well exposed, the suture somewhat impressed, the punctures rather more distinct than usual; abdomen at base narrower than the elytra, at apex very much narrower. *Male* with a feebly tumid arc tangent posteriorly to the apex of the fifth tergite and occupying about an eighth or ninth of its entire width; sixth with two short and strong, inwardly directed processes in median third of the apex, the inclosed sinus with about three feeble undulations, each bearing a minute setose process; *female* with the asperate punctulation of the abdomen distinct and close-set posteriorly toward the sides, the sixth tergite rounded. Length 1.6–1.8 mm.; width 0.72–0.8 mm. Colorado (Boulder Co.).....*laurana* n. sp.

Form rather stout, polished, feebly micro-reticulate throughout, flavate, the head black, the elytra blackish on the flanks posteriorly and broadly along the apex nearly to the suture, the black cloud on the fourth tergite small; head well developed, with a few rather coarse punctures; antennae flavate, extending nearly to the middle of the elytra, rather stout, loose as usual in this group, the fifth joint slightly elongate, the tenth about as long as wide, the eleventh very nearly as long as the two preceding combined; prothorax rather large, slightly wider than the head, one-half wider than long, the sides rounded in nearly apical half, thence distinctly converging and straighter to the base, the latter arcuate, the punctures as usual; elytra a third wider and two-fifths longer than the prothorax, the humeri rounded and moderately exposed, the punctures minute; abdomen at base nearly as wide as the elytra, rapidly narrowed thence to the tip, the sides almost straight except near the apex, the surface smooth, almost wholly devoid of minute asperate punctures posteriorly in the female. *Male* unknown. Length 1.5–1.8 mm.; width 0.7 mm. Missouri (St. Louis).
coniciventris n. sp.

Form nearly similar but smaller and with a relatively smaller prothorax, polished, feebly micro-reticulate throughout, flavate, the head black, the elytra less reddish, barely at all infumate near the external apical angles, the abdominal cloud small and feeble; head as usual; antennae fully attaining basal third of the elytra, rather less stout than in *coniciventris* and sensibly infumate distally, the fifth joint as long as wide, the tenth rather wider than long, the eleventh almost as long as the two preceding combined; prothorax much wider than the head, in out-

line and punctuation nearly as in *coniciventrif*; elytra nearly similar but less transverse, the humeri more widely exposed; abdomen nearly similar but with the surface finely, closely and asperately punctulate posteriorly, the sixth tergite similarly rounded at tip in the female. *Male* unknown. Length 1.4 mm.; width 0.67 mm. Missouri (St. Louis.).

genitiva n. sp.

- 12 — Body rather stout, somewhat convex, polished, very obsoletely micro-reticulate throughout, more distinctly on the abdomen, pale flavate, the abdomen reddish, with a very small nubilous darker cloud in the usual position; elytra blackish at the external apical angles; head rufo-piceous, impressed and coarsely punctured at each side, the antennae stout, extending to basal third of the elytra, infusate, flavate toward base, the joints five to ten somewhat wider than long, the eleventh almost as long as the two preceding combined; prothorax much wider than the head, two-fifths wider than long, the sides parallel and broadly, almost evenly arcuate, the base arcuate, the surface unusually convex, punctured in the usual manner, with a transverse punctulate impression before the scutellum; elytra transverse, a third wider and two-fifths longer than the prothorax, feebly convex, slightly impressed along the suture, strongly, closely and irregularly punctate throughout, more roughly scabrous externally toward apex, the humeri well exposed, rounded; abdomen strongly tapering from base to apex. *Male* with six small subequidistant asperities near the apex of the fifth tergite throughout the width, the two median rounded and acutely tuberculiform, the others elongate and cariniform; sixth trapezoidal, the apex fully half as wide as the base and with two incurved apical processes, obliquely compressed, the intervening sinus with three equidistant, straight, cylindrical and porrect processes projecting more than half way to the line of the apices of the lateral processes, the general surface coarsely and strongly asperate throughout; *female* with the tubercles of the fifth tergite almost as in the male, the two medial more widely separated; sixth as in the male, except that the apex is emarginate throughout the width in a simple smooth sinus about five times as wide as deep, defined at the sides by simple prominent angles. Length 2.25 mm.; width 0.82 mm. Wisconsin (Bayfield) and New York (Catskill Mts.).

sculptipennis n. sp.

- Body smaller and more slender, more depressed and subparallel, polished, evidently micro-reticulate throughout, pale flavate, the elytra less rufous, not at all maculate, the abdominal cloud black, involving most of the fourth and fifth tergites; head piceous-black, paler apically, the antennae fully attaining the middle of the elytra, feebly infumate except toward base, the fifth joint longer than wide, the tenth somewhat wider than long, the eleventh much shorter than the two preceding combined; prothorax short and strongly transverse, distinctly wider than the head and fully four-fifths wider than long, the sides parallel and rather strongly arcuate; base broadly arcuate, the punctures as usual, the surface somewhat longitudinally impressed at each side of the broad median line, especially toward apex and base; elytra transverse, barely a third wider and nearly one-half longer than the prothorax, the humeri rather broadly rounding to the prothorax, the surface with sparsely scattered

coarse indented pseudo-punctures almost throughout; abdomen moderately tapering from base to apex, the sixth tergite rounded in the female. *Male* unknown. Length 1.7 mm.; width 0.65 mm. New York (Catskill Mts.).....*subpunctata* n. sp.

Body smaller and stouter, more fusiform and convex, with rather dense integuments, which are distinctly micro-reticulate throughout, testaceous in color, the elytra rather more yellowish and without distinct darker maculation, the abdominal cloud rather large, black or paler and indefinitely limited, the head piceous-black or paler, sparsely punctate laterally; antennae nearly attaining the middle of the elytra, moderately slender, somewhat infuscate distally, the fifth joint slightly elongate, the tenth very feebly transverse, the eleventh much shorter than the two preceding combined, more obtuse at apex than usual; prothorax one-half wider than long, distinctly wider than the head, obtrapezoidal, rounded at the sides anteriorly, the latter feebly converging and less arcuate thence to the base, the surface with the usual punctures distinct, convex; elytra as in *subpunctata* but less transverse and with the indented punctures smaller and sparser, particularly toward the external apical angles; abdomen strongly conoidal. *Male* with a low polished rounded and slightly transverse tubercle near the apex of the fifth tergite, the sixth with two long and slender, arcuate, incurved and pointed apical processes in median third of the total width, the bottom of the inclosed space transversely subsinuate and almost perfectly even, the adjoining surface transversely swollen and polished; *female* with the sixth tergite broadly arcuato-truncate at apex. Length 1.25-1.4 mm.; width 0.65 mm. Canada (Grimsby), Iowa and Wisconsin (Bayfield).....*lacustris* n. sp.

Var. A — Form nearly similar but still smaller and more slender, the micro-reticulation of the head and pronotum almost wholly obsolete as are also the large indented punctures of the elytra, these being replaced by the usual very fine sparse and inconspicuous punctures. *Male* with almost identical sexual characters, the flat tubercle of the fifth tergite being smaller, rounded and not transverse, the processes and sinus of the sixth similar. Length 1.1 mm.; width 0.58 mm. Pennsylvania (near Philadelphia).....*inconspicua* n. var.

- 13 — Prothorax distinctly or strongly transverse, as a rule, as usual.....14
 Prothorax but slightly wider than long; body more slender and sub-parallel.....19
 14 — Prothorax moderately transverse, generally very distinctly narrower than the base of the elytra.....15
 Prothorax very strongly transverse, very nearly twice as wide as long....18
 15 — General color pale.....16
 General color dark.....17
 16 — Form rather stout, moderately convex, polished, feebly micro-reticulate throughout, the head blackish, the elytra feebly infumate at the outer apical angles, the abdominal cloud black, well developed on and near the fourth tergite; head with sparse coarse punctures laterally, the antennae short, slightly longer than the head and prothorax, rather stout, joints five to ten distinctly transverse, those beyond the third or fourth pale brownish-fuscous in color; prothorax slightly, though

obviously, wider than the head, two-thirds wider than long, convex, the sides parallel and broadly, evenly arcuate, the base arcuate, the usual sparse punctures small and inconspicuous; elytra a third wider and nearly one-half longer than the prothorax, the humeri only moderately exposed, rounded, the punctures minute, sparse and indistinct; abdomen broad, parallel, narrowed toward tip. *Male* with four fine feeble oblique and subequidistant cariniform asperities near the tip of the fifth tergite in more than median third, the two median but slightly more widely separated than those of the outer pairs, the sixth with two short and sharply angulate projections in median third, the intervening edge nearly straight but with two very minute, posteriorly and feebly projecting points at the middle; *female* with the sixth tergite evenly subtruncate at tip. Length 1.3-1.5 mm.; width 0.58-0.6 mm. New York (Catskill Mts.) and Pennsylvania (near Philadelphia).

***laetula* n. sp.**

Form nearly as in *laetula* but not so stout and smaller in size, similarly sculptured and colored, except that the antennae from the fourth joint are rather darker or more blackish in tint, the joints fully as transverse; integuments highly polished; prothorax and elytra almost similar. *Male* having four small asperities near the apex of the fifth tergite in rather more than median third, the two inner having the form of very slightly elongate flattened tubercles, very much more widely separated than either from the outer asperities, which have the form of fine elongate carinules; sixth tergite with two very small pointed processes at tip, separated by about a third of the width, the intervening edge rectilinear, continuing the general contour of the apex and apparently not modified in any manner; *female* unknown. Length 1.25 mm.; width 0.51 mm. Rhode Island (Boston Neck)..... ***rhodeana* n. sp.**

Form nearly similar but stouter than in either of the two preceding species, polished, similarly feebly micro-reticulate and similarly colored, the head and prothorax relatively rather larger but similar in form and sculpture; antennae stout, the outer joints transverse, blackish, flavate toward base; elytra a fourth wider and two-fifths longer than the prothorax, the humeri moderately exposed; abdomen broad, subparallel, rapidly and arcuately narrowed at tip. *Male* with four small elongate and subcariniform asperities in more than median third of the fifth tergite and near the apical margin, the asperities mutually almost similar, oblique toward the median line, the two median more abbreviated and slightly more widely separated than either from the two outer; sixth with two small porrect and flattened processes in median third of the apex, the processes rather broad, with their apices rounded, the intermediate space with two very minute approximate acute and porrect processes; *female* unknown. Length 1.4 mm.; width 0.62 mm. New York (Peekskill)..... ***fastifer* n. sp.**

Form larger and stouter than in the three preceding, the prothorax much smaller and less transverse, the humeri much more widely exposed, shining, micro-reticulate throughout, pale flavate, the elytra less rufous, not maculate, the abdominal cloud very small, confined to the median part of the fourth tergite; head blackish, paler apically, the antennae stout, extending to about basal third of the elytra, the second

joint fully as long as the next two combined, five to ten strongly transverse, blackish, the eleventh dark, nearly as long as the two preceding combined; punctures coarse and rather numerous at each side of the median line; prothorax about equal in width to the head, scarcely more than two-fifths wider than long, the sides rounded, rather more converging and less arcuate toward base, the surface with rather numerous, irregularly disposed, remotely scattered punctures, the usual four in subtransverse line distinct; elytra strongly transverse, fully two-fifths wider and a third longer than the prothorax, the punctures fine and sparse but rather distinct; abdomen broad, subparallel, arcuately narrowing posteriorly, the sixth tergite broadly rounded at apex in the female. *Male* unknown. Length 1.65 mm.; width 0.68 mm. New York (Catskill Mts.).....*centralis* n. sp.

- 17 — Body stout, highly polished, the head and elytra without, and the pronotum with barely a trace of micro-reticulation; head black, with numerous coarse punctures except along the middle, the antennae stout, fuscous, slender and flavate at base, extending to basal third of the elytra, the outer joints strongly transverse; prothorax slightly wider than the head, three-fifths wider than long, convex, blackish, the sides long and subparallel, broadly, evenly arcuate, the surface with very few remotely scattered punctures; elytra dark flavo-testaceous, blackish externally toward tip, a third wider and nearly two-fifths longer than the prothorax, the humeri only moderately exposed, rounded, the punctures fine but numerous and rather distinct; abdomen stout, gradually and arcuately tapering from base to apex, rufous, the fourth tergite and most of the fifth black. *Male* with four fine cariniform asperities in median third of the fifth tergite and near the apical margin, also, generally, one feebler exterior to these at each side, the median pair of asperities shorter and more narrowly separated than either from those adjacent exteriorly; sixth with two very acute and slightly incurvate processes in median two-fifths, the inclosed sinus lobed in the middle, the lobe bearing two small approximate and slender processes, extending posteriorly to the line of the apices of the principal processes and feebly diverging from the base; *female* with the sixth tergite broadly and evenly rounded. Length 1.4–1.6 mm.; width 0.7 mm. Wisconsin (Bayfield),—H. F. Wickham.....*perpolita* n. sp.

Body nearly similar to the preceding but stouter, polished, the head with traces of micro-reticulation toward base, the pronotum obsolete reticulate; coloration nearly similar, the head and prothorax black, the elytra dark piceo-flavate, gradually black externally toward tip, the abdomen in great part black, slightly paler toward base and at tip; head with rather numerous coarse punctures, the antennae blackish and stout except toward base, the outer joints transverse, the second not as long as the next two combined; prothorax much wider than the head, three-fourths wider than long, rounded at the sides anteriorly, thence narrowed to the base, the four punctures behind the middle of the length large and deep, the others very few and feeble; elytra two-fifths wider and one-half longer than the prothorax, the humeri widely exposed, without reticulation, the punctures fine, irregular and close-set, becoming scabrous externally toward tip; abdomen broad, feebly tapering.

Male with secondary characters nearly as in *perpolita*, the carinules near the apex of the fifth tergite generally more subequal among themselves and subequidistant, the two processes from the bottom of the sinus of the sixth tergite parallel, not diverging from the base and usually not quite so approximate; *female* with the sixth tergite very broadly, evenly arcuate at tip. Length 1.4–1.7 mm.; width 0.66–0.75 mm. Colorado (Boulder Co. and Buena Vista).....**tenebrosa** n. sp.

Body stout, moderately convex, not very highly polished, the entire surface strongly micro-reticulate, uniform dark red-brown in color, the entire abdomen black except at base and apex, the latter slightly paler; head small, feebly punctate, the antennae dark testaceous, the outer joints stout and transverse; prothorax smaller than usual but distinctly wider than the head, three-fifths wider than long, the sides subparallel and broadly arcuate, the base arcuate, broadly margined; surface very remotely and indistinctly punctate, the median line narrowly and slightly elevated throughout the length; elytra two-fifths wider and nearly one-half longer than the prothorax, finely, sparsely and inconspicuously punctured, the humeri well exposed at base; abdomen broad, nearly as wide as the elytra, subparallel, only slightly narrowed at apex; sixth tergite rounded in the female. *Male* unknown. Length 1.4 mm.; width 0.64 mm. Ontario (Sudbury), — H. F. Wickham.....**subnitens** n. sp.

18 — Form rather stout, subparallel, convex, polished, micro-reticulate throughout, dark rufo-testaceous in color, the head scarcely darker; elytra dark piceo-flavate, the abdomen with a large blackish cloud at the fourth and fifth tergites; head rather small, convex, feebly, sparsely punctate, the antennae pale throughout, the club loose and stout, the joints transverse; prothorax much wider than the head, nearly twice as wide as long, the sides sensibly converging and broadly arcuate from near the base to the apex, the former broadly arcuate, the punctures remote and small; elytra slightly wider and about a third longer than the prothorax, strongly transverse, finely, sparsely and asperately punctate throughout, each puncture with a coarse erect yellow hair; abdomen at base nearly as wide as the elytra, the sides thence straight and but slightly converging to the apex. *Male* with two posteriorly inclined acute and conspicuous processes, separated by about a sixth of the entire width and midway between base and apex of the fifth tergite, the sixth with two small acute processes in median third at apex, more than median two-thirds of the intermediate space occupied by a large and apically rounded, flat, polished and sculptureless lobe, extending posteriorly beyond the line of apices of the lateral processes, with its edges finely reflexed and extending forward onto the surface of the segment in two fine cariniform lines; *female* with the sixth tergite very broadly, evenly rounded. Length 1.2–1.4 mm.; width 0.52–0.58 mm. Rhode Island (Boston Neck) and Missouri (St. Louis).**compacta** n. sp.

Form very stout, convex, polished, feebly micro-reticulate, the elytra and abdomen more strongly, black, the prothorax with a very faint piceous tinge, the elytra almost equally feebly rufescent; head relatively rather small, finely, sparsely punctate, the antennae moderately stout distally, with the joints transverse, five to ten black or blackish in color; prothorax much wider than the head, nearly twice as wide as long, the

sides somewhat converging from near the apex to the base, the latter broadly arcuate, the remote punctures small; elytra slightly wider and two-fifths longer than the prothorax, with fine and sparse asperate punctures and rather short darkish hairs throughout; abdomen at base as wide as the elytra, the sides rapidly tapering thence to the tip; sixth tergite rounded in the female. *Male* unknown. Length 1.2 mm.; width 0.62 mm. Pennsylvania (Westmoreland Co.).....**obesula** n. sp.

Form less stout, subparallel, polished, very obsolete micro-reticulate, the abdomen more finely and distinctly, black, the prothorax slightly piceous, the elytra piceo-flavate, darker externally and apically, the abdomen dark rufous, with the fourth tergite and most of the fifth black; head rather well developed, with sparse and distinct punctures laterally, the antennae stout distally, the outer joints transverse, black beyond the fourth, five to eleven gradually very slightly thicker but producing the general impression of a loose parallel club; prothorax relatively smaller than in the two preceding species, nearly twice as wide as long, only slightly wider than the head, the sides subparallel and rather strongly arcuate, the remotely scattered punctures somewhat distinct; elytra transverse, a fourth or fifth wider and two-fifths longer than the prothorax, the humeri perceptibly exposed, the punctures minute, obsolete toward the scutellum, fine, closer and more distinct near the external apical angles; abdomen arcuately and moderately tapering from base to apex, not quite as wide as the elytra, the sixth tergite rounded in the female. *Male* unknown. Length 1.15 mm.; width 0.51 mm. Mississippi (Vicksburg).....**micans** n. sp.

19 — Form elongate, rather slender, subparallel, polished, not distinctly micro-reticulate except on the abdomen, dusky-testaceous, the elytra dark piceo-flavate, the abdomen paler flavate, with a very small medial cloud near the apex; head rather well developed, with a few scattered punctures toward the sides; antennae pale, only moderately stout, the outer joints not very strongly transverse and gradually very slightly infumate toward tip; prothorax not distinctly wider than the head, a fourth or fifth wider than long, the sides long, subparallel and moderately arcuate, the base broadly rounded, the angles rounded though obvious, the surface with rather numerous small punctures scattered along the medial regions from base to apex; elytra only moderately transverse, two-fifths wider and longer than the prothorax, the humeri somewhat distinctly exposed, rounded, the punctures fine, sparse and indistinct; abdomen subequal in width to the elytra, but little narrowed at tip; sixth tergite rounded or subtruncate in the female. *Male* unknown. Length 1.1 mm.; width 0.45 mm, Pennsylvania (near Philadelphia) and Rhode Island (Boston Neck).....**egena** n. sp.

Form slender, subparallel, polished, not evidently micro-reticulate, pale flavate, the head but little darker, the elytra infumate posteriorly, the abdomen scarcely maculate; head with a few sparse punctures, feebly impressed at each side of the middle, the impressions connected by a feeble transverse impression behind the frontal margin; antennae flavate, the outer joints moderately transverse; prothorax subequal in width to the head, about a fourth wider than long, rounded at the sides, the latter more converging toward apex from near the middle

than toward base, the surface with a few sparse punctures; elytra two-fifths wider and longer than the prothorax, with a few sparse punctures, especially evident toward base, the humeri distinctly exposed; abdomen slightly narrower than the elytra, parallel and straight at the sides, moderately narrowed posteriorly only near the apex; female with the sixth tergite broadly rounded. *Male* characters obscured in the type but apparently feeble. Length 1.25-1.35 mm.; width 0.42-0.51 mm. Ontario (Toronto).....*exilis* n. sp.

The above is only the first rude attempt to bring order out of chaos and may not represent the most natural succession of the species in this hitherto neglected genus. There are, for example, several transitions between the species having the antennae decidedly increasing in thickness from the fifth joint to the tip and those having joints five to eleven parallel, and I do not believe that this is an altogether natural subdivision. These transitional forms are mentioned, however, in the above descriptions and will probably not give rise to much uncertainty in identification. The principal object at the present time is to bring forward such characters as may be easily recognized, in order that the species may be identified and further study and collecting encouraged. The next revision, with fuller material, may enable the reviewer to give a more natural classification, perhaps based primarily upon the very pronounced secondary sexual modifications of the male.

The species identified above as *flavicornis* Mels., varies in color more than any other that I have observed, the usual coloration being dark but varying from this to almost wholly flavate. *Inconspicua* has very nearly the same secondary sexual characters as *lacustris*, except that the tubercle of the fifth tergite is rather smaller and more circular and it is therefore very closely related, although lacking the peculiarly pitted elytra characterizing the three species of that immediate group. For the present, therefore, I have regarded it as a subspecies of *lacustris*. In the Henshaw list a species "*affinis* Fauv.," is inscribed; *affinis* Sahlb., is undoubtedly intended, but there is no American species before me corresponding in sexual characters to the examples of that species forwarded by Mr. Reitter and taken in the Caucasus. I have

also been unable to identify the *rufa*, of Melsheimer, doubtfully referred to *Gyrophæna*.

Additional Miscellaneous Aleocharinae.

While the present paper was waiting for the press I took occasion to draw up descriptions of some more especially interesting species, which may be advantageously published at the present time as follows:—

ALEOCHARINI.

Ocalea Er.

Form rather stout, convex, strongly shining, dark testaceous, the elytra shaded somewhat darker externally toward apex and narrowly along the suture, the head and abdomen piceous-black; legs pale, the antennae blackish, gradually paler toward base; surface only very obsoletely micro-reticulate, the elytra more distinctly, the abdomen excessively minutely strigilate in transverse wavy lines; head parallel at the sides, obliquely constricted at base, feebly and rather sparsely punctate, the antennae long, gradually and moderately incrassate distally, the tenth joint not quite as long as wide, the eleventh scarcely as long as the two preceding combined; prothorax large, fully one-half wider than the head and a third wider than long, the sides broadly subangulate at about the middle, thence strongly converging to the apex, which is much narrower than the base; surface evenly convex, finely, sparsely punctate, with a small transverse discal impression before the scutellum; elytra large, only just visibly wider and nearly one-half longer than the prothorax, finely, closely and asperulately punctured; abdomen at base somewhat narrower than the elytra, gradually tapering thence to the apex, finely, sparsely punctate throughout, the vestiture rather long but sparse, elsewhere short; mesosternal process extending to apical fourth of the coxae, extremely acute at tip and free, the metasternum scarcely at all entering between the coxae, obtusely angulate, the long intermediate isthmus narrowly convex transversely. Length 3.4 mm.; width 0.88 mm. California (Siskiyou Co.).....*grandicollis* n. sp.

Form and coloration nearly as in the preceding, the elytra scarcely perceptibly shaded darker externally but more distinctly in the region of the scutellum, quite as convex and polished, the micro-reticulation almost wholly obsolete, even on the elytra, the strigilation of the abdomen coarser but very nearly obsolete; vestiture sparse and inconspicuous; head larger but similar in form, finely, sparsely punctate, the antennae rather shorter, extending barely to the middle of the elytra but otherwise nearly similar, the eleventh joint more pointed and as long as the two preceding combined; prothorax relatively smaller, not subangulate at the sides, the latter subparallel and broadly, evenly arcuate, the basal angles more obtusely rounded and less distinct, only about a

third wider than the head and equally transverse, the apex but little narrower than the base; surface finely, sparsely punctate, with a small transverse impression before the scutellum; elytra nearly a fourth wider and one-half longer than the prothorax, less finely and not so closely punctate; abdomen subparallel, narrower than the elytra, narrowed slightly posteriorly only near the apex, similarly finely and sparsely punctate throughout and with the first three tergites narrowly and deeply impressed at base; middle coxae contiguous, the mesosternal process acutely angulate but only extending to the middle, the metasternum still more obtusely abbreviated. Length 3.2 mm.; width 0.82 mm. California (Sta. Cruz Mts.).....*franciscana* n. sp.

These species both have the prothorax much more developed than in the more northern *vancouveri* Csy., and agree nearly with European species of the *picata* type.

Chilopora Kr.

Form slender, subparallel, strongly convex, shining, dark red-brown in color, the head and abdomen behind the third segment blackish; legs pale brownish-flavate, the antennae infumate, gradually pale basally; pubescence short, inconspicuous, fine, moderately dense but scarcely sericeous on the abdomen; head fully as long as wide, parallel, abruptly and obliquely constricted at base, the eyes slightly prominent, the punctures fine and sparse, the surface polished; antennae long, extending to about the tips of the elytra, slender toward base but gradually rather strongly incrassate distally, the tenth joint longer than wide, the eleventh obtusely pointed and as long as the two preceding combined; prothorax but little wider than the head, distinctly longer than wide, widest at about apical two-fifths, the sides broadly rounded, feebly converging and straight toward base, the latter much wider than the apex; surface finely, sparsely and subgranularly punctate with polished interspaces, except rather narrowly along the middle, where the punctures are dense and the surface feebly impressed toward base behind the middle; elytra about a third wider and a fourth longer than the prothorax, finely, closely punctate; abdomen parallel, slightly narrower than the elytra, extremely minutely and rather closely punctulate; middle coxae contiguous, the mesosternal process very acutely angulate, extending to about the middle, the metasternum short but rather acutely angulate, the long isthmus acutely compressed. Length 3.8 mm.; width 0.7 mm. New York (Peekskill).....*americana* n. sp.

Form slender, convex, blackish-castaneous in color, the head and posterior part of the abdomen black; legs slender, pale flavate, the antennae black, becoming piceo-testaceous toward base; integuments opaque, extremely minutely, subgranularly and densely punctate, the abdomen still more minutely but simply and very closely punctulate, less minutely and closely in the three basal depressions, the pubescence short, very close, especially on the abdomen; head as long as wide, rounded at the sides of the base, the eyes not at all prominent; antennae

not quite extending to the tips of the elytra, gradually and rather strongly incrassate distally, the tenth joint not quite as long as wide; prothorax distinctly wider than the head, fully as long as wide, widest at anterior two-fifths, where the sides are rather strongly arcuate, thence rounding to the apex and feebly converging and somewhat sinuate toward base; surface narrowly and very feebly impressed along the median line throughout, with a somewhat more pronounced impression before the scutellum; elytra two-fifths wider and a third longer than the prothorax, the crowded punctures less minute and more evident than on the latter; abdomen parallel, distinctly narrower than the elytra, the first three tergites strongly and rather narrowly impressed at base; mesosternal process extending, somewhat more posteriorly than in *americana*. Length 3.4 mm.; width 0.65 mm. North Carolina (Asheville) and Pennsylvania (Philadelphia).....*fuliginosa* n. sp.

The first of the above species is closely allied to the European *rubicunda* Er., but has a broader neck, the latter having the neck about two-thirds as wide as the head, while in *americana* it is about three-fourths as wide; there are also several other minor differences. The second species more nearly resembles *longitarsis*, but is more slender and with relatively much smaller elytra.

Pachycerota n. gen.

It is probable that this genus, though very isolated, will prove to be more closely related to *Ilyobates* than to any other at present described. The body is rather stout, moderately convex, densely sculptured, the mesosternal process moderately narrow, flat, extending to apical third or fourth of the coxae, with its arcuato-truncate apex slightly free and not quite attaining the narrowly rounded tip of the elongate metasternal projection. The mentum is transverse, coriaceous at tip, the processes of the ligula long, slender and contiguous, the palpi moderate and setose, the eyes moderately developed, anterior and somewhat finely faceted, the antennae short, compact and very stout, the neck rather abruptly and deeply constricted and about two-thirds as wide as the head and the first three abdominal segments somewhat broadly and subequally impressed at base. The legs are moderate in length, the tarsi somewhat short, the posterior slender and two-thirds as long as the tibiae, with the basal

joint distinctly longer than the next two combined. The type may be described as follows: —

Body moderately stout and convex, dull in lustre, the elytra more shining and the abdomen still more so, densely and rather coarsely micro-reticulate, the reticulation very strong, obscuring the punctuation, rugulose on the head, larger and feebler on the elytra and very feeble on the abdomen; color black or blackish when mature, the elytra slightly paler, rufescent, the tip of the abdomen pale; legs pale testaceous, the antennae black, paler toward base; pubescence moderately long and coarse, subdecumbent; head slightly elongate, parallel and nearly straight at the sides, the eyes before the middle and prominent, the basal angles broadly rounded; surface with a shining and less sculptured median line expanding in front; antennae scarcely as long as the head and prothorax, very thick, the outer joints very transverse and compactly joined, the second joint elongate and slightly longer than the third, fourth transverse, four to eleven gradually wider, the latter as long as the two preceding and very obtusely rounded at tip; prothorax very nearly as long as wide, almost a third wider than the head, the sides parallel and nearly straight, rounding and converging anteriorly to the apex, the basal angles obtuse; base strongly arcuate, the surface not impressed; elytra a third wider than the prothorax and equal to the latter in length, the sides feebly arcuate, slightly diverging from the humeri, which are but very slightly exposed at base; external apical angles and scutellar region black; abdomen slightly narrower than the elytra, parallel, finely, not very densely punctate, closely and more coarsely so in the basal impressions. Length 3.0 mm.; width 0.8 mm. Massachusetts to Iowa.....**duryi** n. sp.

This species does not appear to be rare and generally occurs with ants of large size and black color. I have received it from Messrs. Chas. Dury, of Cincinnati, and H. F. Wickham, and from the late P. Jerome Schmitt, of Westmoreland Co., Penn.

Gennadota n. gen.

The species described by the writer under the name *Calli-cerus puberulus* (Ann. N. Y. Acad. Sci., VII, p. 310), has the anterior tarsi five-jointed and therefore constitutes a genus allied to *Ocalea* and more especially to *Chilopora*, having a structure of the intermesocoxal parts nearly similar to the latter, but differing in having the first four tergites impressed at base, as well as in its coarser, sparser sculpture, coarse pubescence, shorter, thicker tarsi and general facies.

From *Ilyobates*, which has a somewhat similar abdomen, it differs in its more slender and acutely aciculate mesosternal process and pointed antennae. Assuming *Callicerus obscurus* Grav., to be the type of *Callicerus*, there can be no doubt of its four-jointed anterior tarsi and that its proper place is among the Myrmedoniini, where it is wholly isolated by its remarkable antennae. Besides the type of *Gennadota*, a second species has recently been discovered, which may be briefly described as follows: —

Stout, parallel, convex, polished, not micro-reticulate except very obsoletely on the elytra, the abdomen extremely finely but obsoletely strigilate in wavy transverse lines, castaneous, the head rather more piceous and the elytra pale brownish-rufous throughout; legs pale, the antennae fuscous, with the first joint testaceous; pubescence rather long, coarse, moderately sparse and distinct; head fully as long as wide, parallel, abruptly and obliquely constricted at base, finely and sparsely punctate, the eyes slightly prominent; antennae not quite attaining the middle of the elytra, moderately thick, but little enlarged distally beyond the fifth joint, the subapical joints slightly wider than long, the eleventh ogivally pointed, as long as the two preceding combined; prothorax about two-fifths wider than long and two-fifths wider than the head, the sides subparallel and broadly, evenly arcuate throughout, more converging apically, the apex very distinctly narrower than the base; surface finely, rather sparsely punctate and evenly convex, except a small transverse ante-scutellar impression; elytra large, nearly a third wider and one-half longer than the prothorax, strongly impressed on the suture behind the scutellum, very distinctly, somewhat closely and asperulately punctured; abdomen parallel, evidently narrower than the elytra, finely, sparsely punctate, the four subequal strong basal impressions rather coarsely but not more densely punctate. Length 3.8 mm.; width 1.0 mm. Canada.

canadensis n. sp.

This species differs conspicuously from *puberula* in its more transverse, more finely and sparsely punctate prothorax, not narrowed toward base and not broadly impressed on the median line behind the middle and also in its smaller head, among other characters. The European species previously referred to by me as *Callicerus rigidicornis*, will form a new genus allied to *Ilyobates*.

Phloeopora Er.

Form stouter, parallel, somewhat depressed, piceous-black, the elytra rufous behind basal third at the suture, to apical third at the sides; legs pale

brown throughout, the antennae dark, paler toward base; surface dull, the head and prothorax strongly micro-reticulate, each of the minute and rather close-set punctures at the centre of a somewhat larger polygon, the elytra more shining, feebly reticulate, closely, somewhat asperately and more distinctly punctate, the abdomen only reticulate toward tip, finely, rather closely punctate; pubescence short, not conspicuous; head and antennae as in *reptans*, the former smaller in size, the eyes rather less prominent; prothorax about a fourth wider than long and nearly a third wider than the head, the sides subparallel, broadly arcuate anteriorly, very feebly converging and straight toward base, the basal angles slightly obtuse and narrowly rounded; surface very obsoletely, transversely impressed before the scutellum; elytra about a fifth or sixth wider and a third longer than the prothorax, the humeri very slightly exposed at base; abdomen parallel, much narrower than the elytra, the first four tergites subequally impressed at base. Length 2.6 mm.; width 0.62 mm. Oregon (The Dalles),—H. F. Wickham.

oregona n. sp.

Form very slender, parallel, convex, shining, blackish-piceous, the elytra gradually rufous posteriorly, the abdomen wholly black; legs brown, the antennae fuscous, slightly paler basally; integuments very obsoletely micro-reticulate, the elytra not at all so, the abdomen only reticulate toward tip; head large, fully as long as wide, abruptly constricted at base, the eyes well developed and rather prominent; antennae moderately incrassate distally, but little longer than the head and prothorax, the outer joints transverse; prothorax scarcely as wide as the head, as long as wide, parallel, the sides broadly rounded anteriorly, thence very feebly converging and nearly straight to the distinct basal angles, the punctures, like those of the head, fine and sparse, the surface not at all impressed at any point; elytra fully a third wider and a fourth longer than the prothorax, the humeri well exposed at base, the punctures moderately fine but very distinct, somewhat close-set; abdomen perfectly parallel to the tip of the fifth segment, with straight sides, distinctly narrower than the elytra, finely, moderately closely punctate, the first three tergites strongly, the fourth more narrowly and less deeply impressed at base. Length 1.85 mm.; width 0.42 mm. Iowa and North Carolina.....*sublaevis* n. sp.

The genus *Phloeopora*, as generally recognized, is somewhat composite. The general facies, for example, of *reptans* or the allied *oregona*, on the one hand, and *sublaevis* or the nearly allied European *corticalis* on the other, being quite different and the last has only the first three tergites impressed at base. *Ferruginea* differs much in general appearance, because of the more strongly converging sides of the prothorax toward base, but is evidently more closely allied to the *reptans* than to the *corticalis* group of the genus. *Sublaevis* was formerly identified by me as *latens* Er., but as this

species is given in the catalogue of Heyden, Reitter and Weise as European, with several European synonyms appended, and, as it is apparently a smaller species than that indicated by Erichson in his description, I have concluded to regard it as distinct.

Nasirema Csy.

This genus is allied rather closely to *Phloeopora* but differs in its much larger and thicker antennae, with more obtuse terminal joint, among other characters. The following species is very distinct in general appearance:—

Slender, parallel, strongly convex, polished, dark rufo-castaneous, the elytra slightly paler rufous, the legs brownish-flavate, the antennae fuscous, paler toward base; integuments very faintly micro-reticulate throughout; pubescence fine, rather sparse, decumbent; head fully as long as wide, finely, sparsely punctulate, the eyes rather small; antennae longer than the head and prothorax, very thick distally, the outer joints closely joined and strongly transverse, the last but little longer than wide, very obtusely rounded at tip; prothorax distinctly wider than the head, only slightly wider than long, parallel, the sides evenly arcuate almost throughout, the surface even, not impressed at any point, finely, sparsely punctulate; elytra about a fifth wider and a fourth longer than the prothorax, finely and closely but more distinctly punctate, the humeri scarcely at all exposed at base, parallel, the sides evenly arcuate; abdomen distinctly narrower than the elytra, parallel and straight at the sides, very minutely, rather sparsely punctulate, the first three tergites strongly and equally impressed and somewhat more coarsely punctate at base, the fourth wholly without trace of basal impression. Length 2.25 mm.; width 0.48 mm. Iowa (Iowa City),—H. F. Wickham.

inquilina n. sp.

Differs greatly from *humilis* and *parviceps* in its polished and sparsely punctulate integuments, but apparently congeneric; it occurs in the nests of a rather large brown ant.

Oxypoda Mann.

The following species are additional to those previously published by the writer (Ann. N. Y. Acad. Sci., VII, pp. 290-300).

Last antennal joint moderate in size, not longer than the two preceding combined..... 2

- Last joint much elongated, distinctly longer than the two preceding.....15
- 2 — Prothorax subparallel and arcuate at the sides, the apex not very much narrower than the base..... 3
- Prothorax subconical or with the apex strikingly narrower than the base. 8
- 3 — Prothorax strongly transverse..... 4
- Prothorax nearly as long as wide..... 7
- 4 — Base of the prothorax fully as wide as the base of the elytra..... 5
- Base of the prothorax narrower than the base of the elytra..... 6
- 5 — Body moderately slender and convex, subparallel, slightly shining, dark brownish-testaceous, the head black, the abdomen piceous-black, the elytra slightly clouded externally and broadly near the scutellum; legs and antennae pale, the latter slightly infumate distally; punctures very fine and close-set throughout; head wider than long, inflated behind the well developed eyes, which are not at all prominent; antennae very short, feebly incrassate distally, but little longer than the head and prothorax, the outer joints close-set and transverse, the second much longer than the third; prothorax two-thirds wider than the head and three-fifths wider than long, evenly convex throughout; elytra equal in width to the prothorax throughout and a third longer; abdomen at base slightly narrower than the elytra, only feebly tapering thence to the apex, the second and third impressions extremely feeble; metasternal intercoxal angle very short and obtusely rounded, more than three times as wide as long. Length 2.6 mm.; width 0.65 mm. Virginia (Norfolk)..... *mimetica* n. sp.
- Body slightly stouter and more fusoid, quite as convex, slightly shining, very minutely, moderately closely punctured, pale brownish-testaceous, the head and abdomen blackish, the latter pale at tip; legs pale, the antennae fuscous except toward base; pubescence longer than usual and more shaggy; head only slightly wider than long, not at all inflated behind the eyes, which are well developed and slightly convex; antennae extending to basal third of the elytra, the outer joints distinctly wider than long, the second longer than the third; prothorax evenly convex, three-fourths wider than the head and three-fourths wider than long, the sides strongly arcuate; elytra at base equal in width to the prothorax, at tip slightly wider, about two-fifths longer; abdomen at base much narrower than the elytra, strongly tapering thence to the tip, the sides straight, the second and third impressions rather feeble. Length 2.2 mm.; width 0.68 mm. Iowa (Iowa City), — H. F. Wickham. *amica* n. sp.
- 6 — Form very elongate, rather slender, more depressed than usual, shining anteriorly, the abdomen dull, testaceous, the head piceous-black, the abdomen with a feeble cloud involving the fourth tergite and most of the fifth; legs and antennae pale, the latter slightly fuscous apically; punctures fine, sparse on the head, closer on the prothorax and elytra, very much more minute and excessively dense on the abdomen; pubescence somewhat long and shaggy anteriorly, very short and decumbent on the abdomen; head rather longer than wide, just visibly inflated behind the moderately convex eyes; antennae extending to the middle of the elytra, very slender toward base, gradually and distinctly incrassate distally, the subapical joints slightly wider than long, the eleventh fully

as long as the two preceding or somewhat longer, the second and third very long and slender, the former somewhat the shorter; prothorax one-half wider than the head and two-fifths wider than long, the sides strongly, evenly arcuate; elytra a fifth wider and two-fifths longer than the prothorax; abdomen slightly narrower than the elytra, parallel toward base, feebly tapering in apical half, the three basal impressions rather strong; metasternal angle pronounced, right. Length 3.2 mm.; width 0.8 mm. Maine (Rangeley Lake).....*sylvia* n. sp.

- 7 — Moderately stout, convex, shining, deep black, the legs and the basal joint of the antennae pale piceo-testaceous; pubescence short, subdecumbent and not very conspicuous; punctures fine and only moderately close-set even on the abdomen, slightly larger, denser and asperulate on the elytra; head small, as long as wide, arcuately narrowed behind the somewhat prominent eyes; antennae long, attaining apical third of the elytra, gradually and moderately incrassate distally, the subapical joints somewhat longer than wide, the second shorter than the third; prothorax fully four-fifths wider than the head, barely a third wider than long, the sides evenly and strongly arcuate, the surface strongly convex, very feebly, subtransversely impressed before the scutellum; elytra throughout equal in width to the prothorax, about a third longer, almost as long as wide; abdomen at base barely narrower than the elytra, only very feebly tapering thence to the tip, the three basal impressions distinct; metasternal angle very short, obtusely rounded, about four times as wide as long. Length 3.0 mm.; width 0.8 mm. Missouri (St. Louis).....*lucidula* n. sp.
- 8 — Body moderately slender, the abdomen tapering posteriorly at least from the middle..... 9
Body excessively slender, linear, small in size, the abdomen straight and parallel at the sides or at the sides of the dorsal plates..... 14
- 9 — Prothorax widest at some distance before the base, less transverse than usual; antennae thick and long. Body nearly as in *lucidula*, the prothorax smaller and much more narrowed toward apex, deep black, the elytra somewhat piceous, the legs and basal joint of the antennae pale piceous-brown; pubescence fine, subdecumbent, not very conspicuous, the surface rather shining, finely, moderately closely punctate, more strongly and densely so on the elytra, more minutely and much more closely on the abdomen than in *lucidula*; head wider than long, arcuately constricted behind the eyes, which are large but not prominent; antennae thick, moderately slender toward base, extending almost to the tips of the elytra, the subapical joints slightly elongate, the eleventh pointed, lobed in apical third as in *lucidula*, the second and third subequal; prothorax fully three-fourths wider than the head, a third wider than long, the sides strongly rounded toward base, becoming strongly convergent and straighter anteriorly to the apex; surface very feebly impressed before the scutellum; elytra sensibly wider than the prothorax and barely a third longer; abdomen slightly narrower than the elytra, tapering very feebly behind the middle, the three impressions distinct; metasternal angle nearly as in *lucidula*. Length 2.8 mm.; width 0.85 mm. New York (near the city.).....*stygica* n. sp.

- Prothorax widest at or near the base, more transverse; antennae small and slender.....10
- 10—Species occurring west of the Rocky Mountains. Form moderately stout and convex, rather dull, minutely, densely punctate, with short, dense, fine and decumbent vestiture, dark piceo-rufous in color, the head slightly darker, the abdomen blackish, the segments all nubilosly rufescent toward tip; legs very pale, the antennae infusate distally; head wider than long, the eyes large but not prominent; antennae feebly incrassate distally, about as long as the head and prothorax, the subapical joints transverse, the second distinctly longer than the third; prothorax strongly conical, four-fifths wider than the head, two-fifths wider than long, widest at base, the sides thence strongly converging, evenly but only very feebly arcuate to the apex, the surface not impressed; elytra equal in width to the prothorax, parallel, only about a fourth longer; abdomen at base evidently narrower than the elytra, the sides thence distinctly converging to the apex, the second and third impressions very feeble. Length 2.75 mm.; width 0.8 mm. Nevada (Reno).....*renoica* n. sp.
- Species of the Atlantic faunal regions to the eastern base of the Rocky Mountains.....11
- 11—Metasternal angle pronounced, projecting between the coxae as far as the free and aciculate tip of the mesosternal process.....12
- Metasternal angle very short and obtuse, scarcely entering the inter-mesocoxal space.....13
- 12—Form stout and strongly convex, slightly shining, the elytra and abdomen dull, the punctures being very dense, less dense anteriorly, very fine throughout, the vestiture short and dense; color blackish-piceous, the elytra uniform and paler, the abdomen blackish, the segmental apices slightly and nubilosly paler; legs and the antennae gradually toward base testaceous, the remainder of the latter black; head sub-orbicular, convex, somewhat transverse, the eyes well developed but not prominent; antennae slender, feebly incrassate distally, attaining basal third of the elytra, the subapical joints slightly transverse, the second somewhat shorter than the third, both considerably elongated; prothorax large, strongly convex, unimpressed, scarcely two-fifths wider than long, four-fifths wider than the head, the sides rather strongly converging, evenly and distinctly arcuate from base to apex; elytra at base scarcely as wide as the prothorax, but, at apex, distinctly wider, scarcely visibly longer; abdomen at base but little narrower than the elytra, strongly tapering thence to the apex, the second and third impressions very feeble. Length 3.1 mm.; width 0.92 mm. Iowa (Iowa City),—H. F. Wickham.....*lowensis* n. sp.
- Form rather stout, very small in size, convex, alutaceous, black, the apices of the ventrals narrowly pale, the fifth more broadly and the sixth entirely; legs and the antennae toward base piceo-testaceous; punctures minute and dense throughout; vestiture fine, short, rather indistinct; head orbicular, not much inflated basally, the eyes moderate, feebly convex; antennae attaining basal third of the elytra, slender basally, rather strongly incrassate toward tip, the subapical joints transverse, the second much longer than the third; prothorax four-

fifths wider than the head, nearly two-thirds wider than long, the sides rather strongly converging from base to apex, evenly and somewhat strongly arcuate, the surface not impressed; elytra fully as wide as the prothorax and a third longer; abdomen at base much narrower than the elytra, strongly and evenly tapering thence to the apex, with the sides straight, the first two impressions distinct, subequal, the third obsolete. Length 1.7 mm.; width 0.55 mm. Colorado (Boulder Co.).....*ancilla* n. sp.

Form much less stout and convex, more linear, small in size, shining, pale testaceous, the head slightly darker, the abdomen feebly infumate posteriorly except at apex; legs and the antennae gradually toward base pale testaceous; punctures very minute but somewhat sparse, slightly less minute and closer on the elytra, moderately close-set on the abdomen; pubescence short, rather inconspicuous; head wider than long, inflated at base, the eyes unusually small, not at all prominent; antennae scarcely longer than the head and prothorax, the subapical joints transverse, the second very much longer than the third; prothorax about two-thirds wider than the head and one-half wider than long, the sides becoming distinctly convergent and less arcuate toward apex, the surface not impressed; elytra transverse, at base slightly narrower than the prothorax, at apex about equal in width, about equal in length, rather depressed; abdomen at base almost as wide as the elytra, parallel to the middle, then slightly tapering to the tip, the three basal impressions distinct. Length 2.0 mm.; width 0.51 mm. Missouri (St. Louis).....*simulans* n. sp.

13—Form moderately slender, convex, alutaceous, very finely, closely punctate, the punctures of the elytra and abdomen unusually asperate; pubescence very short and somewhat inconspicuous throughout; color pale rufo-testaceous, the head and entire abdomen black; legs and antennae pale, the latter infusate and feebly incrassate apically, extending to basal third of the elytra, the subapical joints transverse, the second much longer than the first or third; head more shining, orbicular, convex, about as long as wide, the eyes well developed, slightly convex; prothorax about one-half wider than the head, barely one-half wider than long, the sides feebly and evenly arcuate but only moderately converging from base to apex and much less so than in the two following species, the surface with a small rounded discal impression before the scutellum; elytra at base slightly narrower than the prothorax but at apex fully as wide, between a fourth and a third longer; abdomen at base evidently narrower than the elytra, feebly tapering posteriorly only behind the middle, the second and third impressions very feeble. Length 2.4 mm.; width 0.62 mm. Missouri (St. Louis).....*truncatella* n. sp.

Form less slender, feebly shining, piceous-black, the abdomen black, nubilously pale at the apices of the fifth and sixth dorsals; legs and antennae pale, the latter infusate distally; punctures very fine, close-set, those of the elytra equally dense but larger and more asperate, the asperities of the abdomen elongate; pubescence fine, very short, rather dark, sericeous; head slightly transverse, distinctly inflated at base, the eyes rather small, not prominent; antennae about as long as the head

and prothorax, feebly incrassate distally, the subapical joints only slightly transverse, the second very much longer than the third; prothorax two-thirds wider than the head and nearly two-thirds wider than long, the sides strongly converging and broadly, feebly arcuate from very near the base to the apex, the surface wholly unimpressed; elytra at apex as wide as the prothorax, at base very slightly narrower, about a fourth longer; abdomen at base very slightly narrower than the elytra, feebly, almost evenly tapering thence to the apex, the second and third impressions almost obsolete. Length 2.75 mm.; width 0.7 mm.

Virginia (Fort Monroe).....*virginica* n. sp.

Form distinctly more slender than in *virginica*, convex, rather shining, castaneous, the head and abdomen black, the apices of the fifth and sixth ventrals nubilously paler, the elytra each with a nubilously rufous oblique line from the humerus to the suture at apex; legs pale, the antennae fuscous, pale basally; punctures anteriorly very fine and close-set, of the elytra and abdomen distinctly though narrowly separated and asperulate; vestiture pale, fine and decumbent, scarcely sericeous; head less transverse and less inflated at base than in *virginica*, with larger eyes, the antennae nearly similar; prothorax three-fifths wider than long, nearly as in *virginica* but with a small and very feeble rounded impression on the disk before the scutellum; elytra equal in width to the prothorax and barely a fifth longer; abdomen in form, taper and relationship with the elytra nearly as in *virginica* but narrower and much less closely and less asperately punctate, the second and third impressions feeble but more distinct. Length 2.7 mm.; width 0.67 mm. Virginia (Norfolk).....*obliqua* n. sp.

14 — Body linear, convex, alutaceous in lustre, pale testaceous, the head piceous, the abdomen infumate from the base of the third dorsal, the apices feebly paler; legs and antennae pallid; punctures very fine and close-set, those of the elytra and abdomen more asperulate, the abdominal sculpture becoming feebly imbricate toward base; pubescence very short and close-set; head suborbicular, the eyes small; antennae about as long as the head and prothorax, distinctly incrassate distally, the subapical joints moderately transverse, the second much longer than the third; prothorax barely one-half wider than the head, two-fifths wider than long, the sides feebly arcuate and only moderately converging from base to apex, the surface unimpressed; elytra small, distinctly narrower than the prothorax throughout and evidently shorter; abdomen obviously narrower than the elytra, the second and third impressions narrow but distinct; metasternal projection finely angulate, extending to the free aciculate tip of the mesosternum. Length 2.1 mm.; width 0.45 mm. Missouri (St. Louis) and Mississippi (Vicksburg).....*perexilis* n. sp.

15 — Prothorax narrowed gradually from base to apex, with the sides evenly and strongly arcuate throughout.....16

Prothorax widest behind the middle, the sides thence feebly converging to the base and more strongly and less arcuate to the apex.....17

16 — Body moderately slender, convex, alutaceous, deep black throughout, the abdomen slightly paler at tip; antennae blackish to the base, the legs piceo-testaceous; punctures extremely minute and close-set

throughout, especially on the abdomen, least close on the elytra, which are also micro-reticulate; pubescence fine, plumbeous and inconspicuous; head inflated toward base, the eyes moderate, not prominent; antennae attaining basal third of the elytra, gradually and distinctly incrassate distally, the subapical joints transverse, the eleventh obtusely pointed, not quite as long as the three preceding combined, the second almost as long as the next two together; prothorax twice as wide as the head and nearly three-fifths wider than long, the sides strongly converging from base to apex, the basal angles distinct and but little rounded, the surface unimpressed; elytra equal in width to the prothorax and very slightly longer; abdomen at base evidently narrower than the elytra, moderately tapering thence to the tip, the second impression nearly as deep as the first, the third feeble. Length 2.7 mm.; width 0.67 mm. Ontario (Trenton).....*lacustris* n. sp.

Body rather stouter and less convex, dull, the abdomen shining, dark castaneous, the abdomen and antennae, except the basal joint of the latter, blackish, the legs pale red-brown; punctures very fine and dense, granulliform on the elytra, asperulate and much less close-set on the abdomen; pubescence fine, dense, pale and conspicuous, longer and less evident on the abdomen; head transverse, the eyes large but not at all prominent; antennae almost attaining basal third of the elytra, gradually and strongly incrassate distally, the subapical joints moderately transverse, the eleventh evidently longer than the two preceding combined, the second but slightly longer than the third; prothorax only feebly narrowed from base to apex, four-fifths wider than the head, fully two-fifths wider than long, the basal angles broadly rounded, the surface wholly unimpressed; elytra parallel with slightly arcuate sides, everywhere obviously narrower than the prothorax and only slightly longer; abdomen at base very distinctly narrower than the elytra, moderately and evenly tapering thence to the tip, the sides straight, the three basal impressions rather wide and distinct, the third less deep. Length 2.75 mm.; width 0.7 mm. Nevada (Reno)...*nevadensis* n. sp.

17 — Form rather stout, moderately convex, narrowed anteriorly and posteriorly, dull in lustre, black or piceous-black throughout, the elytra very slightly paler and more rufous, the punctures throughout excessively minute and dense, not at all asperulate even on the abdomen; pubescence very short, dense, slightly fuscous and moderately distinct; head wider than long, not inflated at base, the eyes large but not prominent; antennae thick, extending to the middle of the elytra, the subapical joints evidently though not strongly transverse, the eleventh not as long as the preceding three combined, the first three equal in length and elongate, the first slightly the thickest; prothorax one half wider than the head and about two-fifths wider than long, the surface convex, very feebly impressed along the median line throughout, with a deeper rounded impression of the same width before the middle of the base; elytra large, at base equal in width to the prothorax, at apex very distinctly wider, two-fifths longer; abdomen at base broad but narrower than the elytra, strongly tapering thence to the tip, with the sides feebly and evenly arcuate, the first impression alone distinct, the second and third obsolete; metasternal projection angulate, advancing between

the coxae. Length 2.4 mm.; width 0.78 mm. California (Pomona Mts.), — H. C. Fall.....**fusiformis** n. sp.

The various genera that have been made at the expense of *Oxypoda* are not discussed at present, but, from cursory observation, they seem to be less well defined than those allied to *Aleochara*. *Amica*, of the above table, was sent to me gummed with a very large ant, having a rufous head, piceous abdomen and dark brown intermediate parts, but it is probably merely incidentally inquilinous. *Perexilis* is not rare in the Mississippi Valley but is solitary, like most of the *Oxypodae*, which fact accounts largely for the paucity of individuals representing the very numerous species at present in collections; a specimen before me from New York also represents *perexilis*, in all probability, differing only in a few very insignificant points. *Fusiformis* is allied to *gatosensis*, of Bernhauer, a specimen of which was very kindly given me by Dr. Fenyés, but it is stouter and more fusiform, with larger and more transverse elytra, more transverse subapical and less elongate eleventh joints of the antennae, with several other differential characters; in *gatosensis* the last antennal joint is as long as the preceding three combined; these two species constitute a peculiar and rather isolated geographic group of the genus.

Dasyglossa Kr.

The species which I described several years ago under the name *Oxypoda congruens* (Ann. N. Y. Acad. Sci., VII, p. 292), is evidently the one recently identified as the European *Dasyglossa prospera* Er. It is abundant in the northern Rocky Mountain regions, extending eastward as far as Lake Superior and may be cosmopolitan, or at least widely distributed in the northern hemisphere.

Hylota n. gen.

This genus differs greatly from *Dasyglossa* in having the metasternal projection advanced between the coxae until it meets the mesosternal process, which is however free, and it

differs from both *Oxypoda* and *Dasyglossa* in that the mesosternal process is narrowly truncate at tip. The tarsi are 5-5-5-jointed, the general form as in *Oxypoda* but with much coarser and sparser sculpture, especially of the abdomen. The hypomera are visible from the sides, the tarsi rather short, the basal joint of the posterior about as long as the next two combined. Additional characters may be derived from the following diagnosis of the only species known to me thus far:—

Body stout, convex, opaque and micro-reticulate, the abdomen more shining and with feebly imbricate sculpture; pale ochreous-yellow in color, the abdomen with a very faint cloud involving the fourth tergite; legs and antennae pale; punctures moderately fine and and rather close-set, less close on the abdomen; pubescence pale, rather long and shaggy; head orbicular, rapidly narrowed behind the eyes to the base, the eyes large, somewhat prominent; antennae about as long as the head and prothorax, rather thick and incrassate distally, the subapical joints transverse, the eleventh somewhat longer than the two preceding combined, the second slightly shorter than the third, both shorter than the first; prothorax three-fourths wider than the head, more than one-half wider than long, the sides distinctly converging from base to apex and somewhat strongly, evenly arcuate, the basal angles obtusely rounded, the surface feebly flattened along the middle in basal half; elytra equal in width to the prothorax and only very slightly longer; abdomen at base very nearly as wide as the elytra, almost evenly but just visibly tapering thence to the tip, the border rather thick, the first two tergites distinctly, the third very obsoletely impressed at base. Length 1.9 mm.; width 0.75 mm. New York (near the city).....ochracea n. sp.

There is but one specimen before me and this exhibits no sexual marks.

Baryodma Thoms.

Rather slender, parallel, convex, polished, deep black, each elytron with a large rufous spot in apical three-fifths near the suture; legs piceous-black, the antennae black; head longer than wide, with a few fine scattered punctures; antennae moderately incrassate distally, scarcely as long as the head and prothorax, the subapical joints transverse, the second rather longer than the third; prothorax evidently less than twice as wide as the head, subparallel, about one-half wider than long, the apex broad and but little narrower than the base, the sides feebly, evenly arcuate, the surface with a scarcely at all impressed double series of irregularly disposed punctures and some fine punctures sparsely scattered toward the sides; elytra transverse, the sides as long as the sides of the prothorax, the suture three-fourths as long as the

median line, the punctures rather strong and well separated; abdomen subequal in width to the elytra, parallel, finely, not densely punctate, the three basal impressions decreasing slightly in depth, more sparsely and not at all more coarsely punctured than the remainder of the surface. Length 2.7 mm.; width 0.9 mm. South Africa (Cape Town).

bisolata n. sp.

Allied to *nitida* and *verna*, having the same structure of the intermesocoxal parts, but differing from the former in its less transverse prothorax and elytra, and, from *verna*, in its more slender and parallel form; from both it differs in having the sides of the prothorax much less converging from base to apex.

MYRMEDONIINI.

Tinotus Shp.

Tinotus is the Myrmedoniid representative of *Baryodma* and is so similar in facies as to be readily confounded with that genus at first sight. The intermesocoxal parts are broad, the mesosternal process slightly overlapping the metasternum and carinate along the middle as in *Baryodma*; these parts seem to be normally constituted in the following species, which is remarkable in not having a medial excavation on the head or pronotum and in the singular basal impressions of the latter: —

Form moderately stout, convex and shining; antennae toward base and legs more or less pale piceo-rufous; integuments feebly micro-reticulate, minutely, not densely punctate, rather more distinctly and asperately on the elytra, each of the very minute abdominal punctures at the anterior convergence of two long fine straight lines; pubescence sparse and short but extremely coarse, suberect and setiform, pale in color; head unimpressed, as long as wide, the eyes moderate; antennae short, barely as long as the head and prothorax, gradually and rather strongly incrassate distally, the subapical joints distinctly transverse, the second and third subequal; prothorax transverse, three-fourths wider than long, not quite twice as wide as the head, the sides parallel and rounded, becoming strongly convergent at apex, the base broadly arcuate, the surface wholly unimpressed except at the basal margin, where there are two short straight oblique impressions almost equally trisecting the basal margin and diverging anteriorly; elytra equal in width to the prothorax and but little longer; abdomen at base nearly as wide as the elytra, gradually and moderately tapering thence to the tip, with the sides feebly arcuate, the side margins rather thick.

Length 1.5 mm.; width 0.6 mm. Idaho (Coeur d'Alene), — H. F. Wickham..... *trisetus* n. sp.

The single type is probably a small specimen, as all the species vary greatly in size individually.

Drusillota n. gen.

This genus is allied to *Drusilla* and *Falagonia*, the structure of the intermesocoxal parts being identical, but differs in having a strong infra-lateral carina, extending from the buccal fissure to and around the base of the head. The Mexican *Falagonia*, of Sharp, is very closely allied to *Drusilla* but has short infra-lateral carinae at base and much smaller postero-lateral extensions of the buccal opening. Of *Drusillota* I have seen only the following type species: —

Form rather stout, moderately convex, highly polished, black throughout the body and antennae, the elytra feebly picescent; legs pale piceotestaceous; integuments completely devoid of micro-reticulation, the anterior parts strongly and rather sparsely punctured, the abdomen wholly without punctuation, except a few setigerous punctures principally along the apices of the segments; vestiture moderately long, sparse and inconspicuous; head rather longer than wide, the sides obliquely arcuate behind the eyes to the neck, which is three-fourths as wide as the head; eyes moderate, but slightly prominent; punctures broadly wanting along the median line; palpi long, sparsely setose; ligula with two long slender contiguous median processes; antennae almost attaining the tips of the elytra, slender basally, gradually and strongly incrassate distally, finely, sparsely pubescent, also bristling with long setae, the subapical joints distinctly transverse, the eleventh not large, as long as the two preceding combined, second and third elongate, the former somewhat the longer; prothorax slightly wider than the head, about as long as wide, widest at apical third, where the sides are broadly rounded, thence feebly converging and slightly sinuate to the base, the angles obtuse but not rounded, the base arcuate; surface feebly impressed in nearly median third of basal two-thirds; elytra nearly one-half wider than the prothorax but barely as long, the humeri distinctly exposed at base, the sides feebly diverging, the tip broadly emarginate at the suture; abdomen nearly as wide as the elytra, subparallel, the first tergite alone distinctly impressed at base; legs long, slender, the hind tarsi long, with the first joint shorter than the next two combined. Length 4.3 mm.; width 1.0 mm. South Africa (Wellington)..... *polita* n. sp.

But one specimen was taken by the author; it is of undetermined sex.

Drusilla Leh.

Moderately stout and convex, feebly, the head and abdomen more strongly, shining, dark red-brown, the head darker, the abdomen black subapically; antennae dark brown, the basal parts and legs testaceous; punctures rather coarse, strong, very dense, obviously separated on the head, sparse on the abdomen, which is very finely punctulate, more closely toward base, very remotely behind the second tergite; vestiture fine, inconspicuous, more distinct on the abdomen; head as long as wide, broadly arcuato-truncate at base, with distinct though obtuse hind angles; eyes moderate, rather prominent; antennae extending to the tips of the elytra, gradually and strongly incrassate distally, the subapical joints slightly transverse, the second much shorter than the third; prothorax nearly as in *canaliculata* but much less narrowed posteriorly, subparallel, with a nearly similar excavation in the male; elytra larger, with less diverging sides, transverse, much wider and shorter than the prothorax; abdomen broader than in *canaliculata*, behind the middle rather wider than the elytra. Length 4.8 mm.; width 1.0 mm. Alaska.....*cavicollis* n. sp.

The single male type represents a species of the *canaliculata* type but with much less rounded base of the head, stouter form and other differences as noted in the description.

Nototaphra Csy.

In his recent general work on myrmecophilous and termitophilous Coleoptera, Dr. Wasmann has redescribed *N. lauta* Csy., under the name *Myrmoecia picta*; he however denies that the fault is his, implying that I was wrong in assigning *lauta* to a genus different from *Myrmoecia*, which he of course overlooked and so fell into a trap and described the species under another name. The species of *Myrmoecia* appear to be rare and it is only recently that, through the kindness of MM. Fauvel and Reitter, I have been able to secure typical specimens. On comparing these with *Nototaphra lauta*, I am convinced that *Nototaphra* is a valid genus, the differences between *Myrmedonia*, as represented by *funesta* Grav, *Myrmoecia confragosa* and *plicata* and *Nototaphra lauta* being expressible as follows:—

Middle coxae narrowly separated, the mesosternal process broadly angulate, the connecting isthmus longer and very narrow; integuments polished,

distinctly punctured; hind tarsi stout, the basal joint not longer than the next two combined; male abdomen with dorsal tuberosities.

Myrmoecia

Middle coxae widely separated, the mesosternal process being very broadly arcuato-truncate at tip; integuments very finely sculptured, sometimes opaque..... 2

2—Hind tarsi long and very slender, the first joint longer than the next two combined; male without dorsal abdominal tuberosities.

Myrmedonia

Hind tarsi slender but shorter, the basal joint much shorter than the next two combined, the first three decreasing uniformly and rapidly in length; male abdomen with tuberosities nearly as in *Myrmoecia*.

Nototaphra

In general facies the three genera differ very greatly, owing to sculpture, form of the head and prothorax and other features.

Apalonia n. gen.

The very small type of this genus resembles *Myrmedonia* in many respects but differs in its narrower neck, rather small but prominent and somewhat coarsely faceted eyes, impunctate integuments, strongly setose antennae and other characters. The structure of the intermesocoxal parts is much as in *Myrmedonia*, the coxae being almost as widely separated and the sternal structure apparently similar. The tarsi are very slender and filiform, the basal joint of the posterior somewhat longer than the next two combined. The type may be defined as follows:—

Body minute, parallel, strongly convex, highly polished, not at all micro-reticulate, impunctate, the pubescence fine, rather short and extremely sparse, each tergite with four long strong setae at apex and one on the side margin; color pale rufo-testaceous throughout, the antennae dusky distally and the fourth tergite black; head large, nearly as long as wide, sinuato-truncate at base, the eyes abruptly prominent at the middle of the sides; antennae attaining the tips of the elytra or longer, slender basally, gradually and moderately incrassate distally, sparsely pubescent but bristling with long setae, the subapical joints moderately transverse, the eleventh pointed, slightly longer than the two preceding, the second and third equal in length; prothorax scarcely as wide as the head, but little wider than long, widest and broadly rounded at the sides anteriorly, thence feebly narrowed to the obtuse and slightly rounded basal angles, the base broadly arcuate, the surface strongly and evenly convex, not at all impressed; elytra transverse, slightly wider than the prothorax and not quite as long, the

sides evidently diverging from the humeri, which are distinctly exposed at base; abdomen parallel with feebly arcuate sides, at the middle obviously wider than the elytra, the tergites subequal in length throughout, the first rather broadly and feebly impressed at base; sides and apex sparsely bristling with long black setae. Length 1.25 mm.; width 0.42 mm. Florida.....**seticornis** n. sp.

No sexual marks can be discovered in the unique type. In this genus the coriaceous hind margin of the fifth tergite is excessively fine, all but extinct, in marked contrast to its unusual development in *Chlorotusa*.

Chlorotusa n. gen.

This remarkable genus is evidently allied to *Myrmedonia*, and yet has many structural features extremely like those of *Phanerota*, of the Gyrophaenae. The middle coxae are very widely separated, the mesosternum entering scarcely at all between them and broadly truncate, separated from the very long and broad metasternal projection by a short and apparently wholly unimpressed isthmus. The legs are very long and slender, the tarsi long and filiform, with the basal joint of the anterior and middle much shorter, that of the posterior longer, than the second. The eyes are very large, prominent and coarsely faceted. The neck is less than half as wide as the head. Other characters may be drawn from the following description of the unique type: —

Stout, fusiform, rather convex, highly polished, without trace of micro-reticulation, the punctures extremely minute and sparse, asperate on the elytra, wholly wanting on the abdomen, which has some setigerous punctures along the apices of the tergites, these punctures becoming strongly asperate posteriorly; pubescence sparse, inconspicuous; color pale rufo-testaceous throughout the body, legs and antennae, the head deep black, arcuato-truncate at base, wider than long, with the eyes very large and convex, occupying virtually the entire sides and separated by twice their own width, the facets very coarse, convex, the tempora extremely short; antennae very long, extending well behind the elytra, gradually and moderately incrassate distally, setose, the sub-apical joints longer than wide, the eleventh abruptly and obtusely pointed, much shorter than the two preceding combined, second and third equal in length, much shorter than the first; prothorax equal in width to the head, not quite a third wider than long, widest near the apex, the sides thence distinctly converging and nearly straight to the

obtuse and somewhat rounded basal angles, the base broadly rounded, margined, the surface convex, even, not at all impressed; elytra large with strongly diverging sides, four-fifths wider than the prothorax and about a third longer, transverse, the humeri broadly exposed, the suture not impressed, the inner apical angles rounded; abdomen broad with arcuate sides, at about basal third as wide as the elytra, narrower at base and strongly narrowed toward the tip, the border thin, inclined and very deep, the first tergite alone impressed at base, the others flat; flanks bristling with long black setae. Length 3.0 mm.; width 0.95 mm. Texas.....**megalops** n. sp.

The single male before me has a longitudinal carina on the fifth tergite, gradually disappearing anteriorly and not quite attaining the tip, the sixth broadly rounded. The singular coriaceous fringe at the apex of the fifth tergite, characterizing all the Staphylinidae, is especially developed here. There is never a trace of this form of apical margin on the first four tergites or on the sixth, and its anatomical significance is wholly unknown to me.

Xesturida n. gen.

This genus is allied to *Trichiusa*, having the middle coxae fully as widely separated, but differs in its more finely faceted eyes, broader metasternal parapleurae, longer and more slender tarsi, with more elongate basal joint of the posterior, this being equal to the next two combined, in its subglabrous integuments and wholly impunctate abdomen. The neck is broad, the antennae more slender than in *Trichiusa*, and the basal impression of the third tergite, distinct in *Trichiusa*, is obsolete or very nearly so. The single species may be described as follows:—

Form rather stout, the anterior parts narrow, rather convex, highly polished, not at all reticulate, very minutely, evenly but sparsely and asperulately punctulate, except the abdomen, which is wholly without trace of any form of sculpture, the four apical setae of each tergite small and inconspicuous; color pale piceo-testaceous, the abdomen slightly and indefinitely clouded posteriorly except at tip, the antennae dusky except basally; pubescence sparse and pale, rather inconspicuous; head wider than long, parallel, abruptly and feebly constricted at base, the eyes rather large, moderately prominent; antennae attaining the middle of the elytra, the first six joints equally thick, the second and third elongate and subequal, the next three subequal and as long as wide, seven to

the tip rapidly incrassate, the subapical joints transverse, the eleventh as long as the preceding three combined, the bristling setae throughout distinct; prothorax a fourth wider than the head and a third wider than long, parallel and feebly arcuate at the sides, slightly and arcuately narrowed at the apex, the basal angles rounded, the surface convex, wholly unimpressed; elytra transverse, three-fifths wider but only slightly longer than the prothorax, the humeri distinctly exposed at base; abdomen broad, fully as wide as the elytra, the sides arcuate, narrowed rather conspicuously toward tip; legs slender, moderately long. Length 1.65 mm.; width 0.68 mm. Mississippi (Vicksburg).

laevis n. sp.

The type is probably a female, or at least there are no evident male sexual characters visible externally.

Trichiusa Csy.

A considerable number of new forms have recently come to light and the known species may be provisionally classified as follows:—

- Elytra compositely sculptured, having coarser nude punctures intermingled with smaller asperulate punctures bearing the conspicuous pubescence, the interstices polished, not or only very feebly and coarsely reticulate; antennae very stout distally, the second and third joints elongate and frequently subequal 2
- Elytra with a single set of minute and obsolete asperulate punctures bearing the pubescence, the interstices less shining and distinctly micro-reticulate; species smaller in size; basal angles of the prothorax always somewhat obtuse and rounded, never prominent..... 6
- 2 — Hind angles of the prothorax distinct, usually somewhat prominent and not at all rounded; body larger and stout..... 3
- Hind angles obtuse and very narrowly rounded; nude punctures of the elytra smaller and but little larger than the pubiferous punctures; body less stout..... 5
- 3 — Elytra black and concolorous with the head and prothorax. Body stout, polished, minutely and feebly micro-reticulate, except the elytra, which are non-reticulate and with the coarse punctures sparse; pubiferous punctures throughout minute and sparse, the pubescence long, shaggy and erect but not very close; legs pale; head wider than long, scarcely impressed, the eyes small, prominent; antennae very stout distally, sparsely pubescent and with long bristling setae, extending to the middle of the elytra, dusky but gradually rufous in basal half, the subapical joints moderately transverse, the eleventh obtusely pointed, longer than the two preceding combined, the second and third elongate, the former very slightly the longer; prothorax much wider than the head, fully one-half wider than long, widest near apical third, where the sides are broadly and feebly rounded, thence very slightly converging to the basal angles, which are not rounded but not prominent; sur-

face narrowly impressed along the median line behind the middle almost to the base, the fine sparse punctures more distinct near the base; elytra transverse, a third wider and slightly longer than the prothorax, the humeri well exposed at base, the sides subparallel, feebly arcuate. Length 1.8 mm.; width 0.78 mm. District of Columbia.

polita n. sp.

Elytra always pale, castaneous or reddish-brown.....4

4 — Form stout, parallel, convex, compact, shining, pale castaneous, the head and a subapical cloud on the abdomen black; legs pale, the antennae dusky rufous, paler basally; pubiferous punctures fine but evident throughout, rather close, the larger elytral punctures more numerous than in *polita* but less distinct; pubescence moderately long, erect and abundant; head well developed, wider than long, parallel, the eyes well developed; antennae very thick, gradually incrassate to the tip, extending nearly to the middle of the elytra, the third joint constricted at base, but slightly elongate and much shorter than the second, the subapical joints strongly transverse; the eleventh obtuse and not quite as long as the preceding two; prothorax strongly transverse, a third wider than the head, fully two-thirds wider than long, widest at apical third, the sides thence strongly convergent and becoming feebly sinuate to the rather prominent basal angles, the surface feebly, indefinitely and subtransversely impressed before the middle of the base; elytra barely a fifth wider but fully a third longer than the prothorax, subparallel, the humeri evidently exposed at base; abdomen parallel with arcuate sides, as wide as the elytra, the three basal impressions distinct and subequal as usual, the punctures fine but evident, not very close-set, the surface polished. Length 1.9 mm.; width 0.75 mm. Ohio (Cincinnati),— Chas. Dury..... *transversa* n. sp.

Form and coloration nearly as in the preceding, the size larger, the prothorax more blackish and less transverse, the head and antennae nearly similar, the tenth joint of the latter more evidently longer than the ninth; elytra less transverse but proportioned and punctured nearly as in *transversa*. Length 2.1 mm.; width 0.78 mm. District of Columbia..... *compacta* Csy.

Form stout, rather convex, polished, not micro-reticulate at any point, pale rufo-castaneous, the head black, the abdomen darker, with a large and very indefinite subapical black cloud; legs pale, the antennae black, testaceous toward base and at tip; pubiferous punctures minute and moderately close-set, intermingled with coarse nude punctures on the head, along the entire base of the pronotum and throughout the elytra; pubescence pale, shaggy and conspicuous; head small, nearly as long as wide, arcuately narrowed behind the small and prominent anterior eyes, the vertex with a small impression; antennae extending nearly to the middle of the elytra, gradually becoming very stout distally, the second and third joints both elongate, the latter not constricted at base and but slightly shorter than the second, the subapical joints strongly transverse, the tenth not noticeably longer than the ninth, the eleventh pale, large, obtusely pointed and nearly as long as the preceding three combined; prothorax nearly one-half wider than the head and about two-fifths wider than long, subparallel and broadly rounded at the sides, slightly

narrowed toward base, the angles minutely subprominent, the surface not impressed at any point; elytra a third wider and longer than the prothorax, subparallel, the humeri well exposed at base; abdomen parallel with feebly arcuate sides, at the middle slightly wider than the elytra, the punctures distinct and moderately close-set. Length 1.9 mm.; width 0.8 mm. Ohio (Cincinnati),—Chas. Dury.

parviceps n. sp.

- 5 — Body black, shining, the antennae black, pale basally, the legs pale; integuments feebly micro-reticulate throughout except the elytra; pubiferous punctures fine and normal anteriorly but more asperate and stronger than usual on the elytra and abdomen, the nude punctures on the former very few in number and indistinct; antennae gradually but much less strongly incrassate than in the four preceding species, the second and third joints elongate and subequal in length, the eleventh small, slightly pointed and barely as long as the two preceding combined; prothorax moderately transverse, very feebly and narrowly impressed along the median line behind the middle; elytra wider and longer than the prothorax, the humeri but slightly exposed at base; abdomen obviously wider than the elytra. Length 1.65 mm.; width 0.66 mm. New Jersey..... **setigera** Csy.
- 6 — Antennae short, gradually and more or less strongly incrassate distally, the second joint very much longer than the third, which is constricted at base and but slightly elongate..... 7
- Antennae longer and more slender, but feebly incrassate distally, the third joint elongate, more evenly obconical and but slightly shorter than the second..... 15
- 7 — Prothorax at most only very slightly narrower than the base of the elytra, the elytral humeri not noticeably or but very slightly exposed at base..... 8
- Prothorax very distinctly narrower than any part of the elytra, the humeri generally well exposed at base..... 9
- 8 — Moderately stout and convex, shining, black throughout, the last five antennal joints black, the basal part gradually paler, the legs pale; punctures fine, not close-set, the pubescence only moderately long and rather sparse; integuments finely, not very strongly micro-reticulate, more coarsely on the elytra; head small, nearly as long as wide, parallel, abruptly and obliquely constricted at base, the vertex impressed in the middle; antennae but little longer than the head and prothorax, strongly incrassate distally, the third joint very strongly constricted or pedunculate at base; prothorax nearly one-half wider than the head and two-thirds wider than long, the sides subparallel, arcuately narrowed near the apex only, the surface feebly, transversely impressed before the middle of the base; elytra about a fourth wider and fully a third longer than the prothorax, the sides feebly arcuate, the humeri very narrowly exposed at base; abdomen parallel, equal in width to the elytra, shining, not conspicuously punctate. Length 1.6 mm.; width 0.61 mm. Idaho (Coeur d'Alene),—H. F. Wickham.

monticola n. sp.

Moderately stout and convex, shining, piceous, the prothorax paler, rufous, the head and abdomen blackish, the latter testaceous toward base; an-

tennae infusate distally, the legs pale; surface finely, feebly micro-reticulate, the punctures not close-set, invisible except on the elytra and abdomen, where they are asperulate; pubescence not very long or close, pale; head with a deep rounded impression at the middle of the vertex, somewhat narrowed behind the small subprominent eyes; antennae nearly as in *monticola*, the third joint strongly constricted and pedunculate at base; prothorax two-fifths wider than the head and two-fifths wider than long, the sides distinctly converging and broadly arcuate from base to apex; base strongly arcuate, the surface transversely impressed before the middle of the base, the impression punctate; elytra slightly wider and a third longer than the prothorax, the sides evidently diverging from the humeri, which are scarcely at all exposed at base; abdomen barely as wide as the elytra, parallel, slightly constricted at base. Length 1.6 mm.; width 0.6 mm. Texas (Galveston). **convergens** n. sp.

- 9 — Form very stout, convex, hirsute, the antennae unusually stout. Shining, black, the elytra castaneous; antennae black, rufescent toward base, the legs pale; micro-reticulation almost obsolete throughout; punctures fine, numerous, more visible on the elytra and abdomen; pubescence long, abundant, erect and very conspicuous; head well developed, with an isolated rounded median impression on the vertex, the sides converging behind the eyes; antennae evidently longer than the head and prothorax, very stout, incrassate, the last joint very short, obtusely pointed, much shorter than the two preceding combined, the third strongly obconical and narrowed at base but not abruptly constricted; prothorax about two-fifths wider than long and a third wider than the head, parallel and nearly straight at the sides, abruptly and arcuately narrowed only very near the apex, the basal angles more distinct than usual in this section, the surface with two small punctate impressions before the middle of the base arranged transversely; elytra two-fifths wider and longer than the prothorax, the humeri rather widely exposed at base; abdomen not quite as wide as the elytra, narrowed posteriorly only near the tip. Length 1.7 mm.; width 0.68 mm. Virginia (Fort Monroe). **hirsuta** n. sp.

Form less obese and less hirsute, the antennae only moderately stout. . . . 10

- 10 — Sides of the head evidently converging from the eyes to the basal angles. Moderately shining, black, the elytra and basal parts of the abdomen slightly piceous; pubescence erect, rather abundant and distinct; head small, the vertex impressed, the impression extending narrowly along the median line to the base of the occiput; antennae pale, infusate near the apex; prothorax rather large, transverse, the sides feebly converging and rather strongly arcuate from base to apex, the surface finely, not distinctly impressed transversely before the scutellum; elytra with the humeri less exposed at base than in others of this section, distinctly wider and longer than the prothorax; abdomen as wide as the elytra. Length 1.4–1.45 mm.; width 0.5–0.58 mm. Rhode Island (Boston Neck). **pilosa** Csy.

- Sides of the head parallel or subparallel behind the eyes. 11
11 — Body deep black throughout, the legs pale, the antennae fusco-testaceous, gradually blackish distally. Micro-reticulation feeble, the surface

rather strongly shining, the punctures minute and rather sparse, more distinct and closer on the elytra; pubescence erect but rather sparse and not conspicuous; head strongly impressed at the middle of the vertex, the median line posteriorly finely, distinctly impressed to the base; eyes only moderately convex; antennae as usual slightly longer than the head and prothorax, the latter two-fifths wider than the head, short, fully one-half wider than long, the sides nearly parallel and subevenly, distinctly arcuate throughout, the surface finely, feebly, transversely impressed before the middle of the base, the impression more distinct at its extremities; elytra fully two-fifths wider and longer than the prothorax, the humeri broadly exposed at base; abdomen parallel, as wide as the elytra, with the sides slightly arcuate, strongly shining. Length 1.5 mm.; width 0.56 mm. Kansas (McPherson), — W. Knaus.

aira n. sp.

Body deep black, except the apex of the abdomen, which is rufo-testaceous, the elytra and basal part of the abdomen perhaps just visibly picescent; legs and antennae pale, the latter infusate distally. Reticulation very fine and rather feeble, the surface distinctly shining; pubescence erect but rather sparse and not conspicuous, the punctures very minute, not obvious even on the elytra; head with a large elongate impression on the vertex which is continued narrowly and feebly to the base of the occiput; eyes distinctly prominent; antennae extending to basal third of the elytra; prothorax barely a third wider than the head, about two-fifths wider than long, the sides parallel and nearly straight in basal half, becoming strongly arcuate and converging in about apical half to the apex, the surface distinctly impressed transversely before the middle of the base; elytra rather more than a third wider and longer than the prothorax, the humeri distinctly exposed at base; abdomen about as wide as the elytra. Length 1.35 mm.; width 0.45 mm. Canada (Ottawa), — W. H. Harrington.....**postica n. sp.**

Body varicolored, never in great part deep black.....12

12 — Pronotal punctures fine and normally close-set but strongly asperulate and distinct, the interspaces smooth, alutaceous and extremely minutely and obscurely sculptured, not distinctly micro-reticulate. Form rather slender, convex, alutaceous, the prothorax piceo-rufous, the head, elytra and abdomen, except toward base, black, the legs and antennae pale, the latter black distally; pubescence rather short, stiff and inclined, not conspicuous; head with a small deep rounded impression at the middle of the vertex, the eyes distinctly prominent; antennae scarcely longer than the head and prothorax, very moderately incrassate distally; prothorax two-fifths wider than the head and two-fifths wider than long, the sides evenly arcuate, converging apically, subparallel basally, the surface rather strongly, transversely impressed near the base at the middle; elytra about a fourth wider and a third longer than the prothorax, the humeri evidently but not broadly exposed at base, narrowly so for the present section, the sides slightly diverging; abdomen parallel with feebly arcuate sides, as wide as the elytra, feebly narrowed toward tip. Length 1.6 mm.; width 0.5 mm. Virginia (Fort Monroe).....**virginica n. sp.**

Pronotal punctures very fine and indistinct, not strongly asperulate, the

- interspaces with the usual fine but evident regular micro-reticulation.....13
- 13 — Prothorax large, the sides parallel, arcuate, becoming strongly convergent anteriorly only near the apex. Body stout, convex, rather shining, piceous-black, the pronotum and basal parts of the abdomen slightly but not very distinctly paler; head with a small deep impression continued to the base by a fine feeble impressed line; prothorax fully three-fifths wider than long, distinctly, transversely impressed near the base; elytra much wider and longer than the prothorax, the humeri distinctly exposed at base; abdomen rather wider than the elytra. Length 1.45 mm.; width 0.58 mm. Iowa (Cedar Rapids).

robustula Csy.

- Prothorax notably small in size, the sides evidently converging from base to apex, more arcuately and strongly so toward the latter.....14
- 14 — Form rather slender, moderately convex, strongly shining, piceous-black, the prothorax very slightly paler, blackish-piceous to pale rufous; basal parts of the abdomen dark to pale rufous; legs pale, the antennae black, testaceous toward base; pubescence not very long, reclined or partially erect, longer and erect on the abdomen posteriorly; punctures extremely fine throughout; head with the usual rounded vertexal impression, narrowly continued to the base by a subobsolete impressed line, the eyes small, anterior and rather prominent; antennae slender, strongly incrassate distally, attaining basal third of the elytra; prothorax about a third wider than the head and one-half wider than long, with a short transverse impression before the middle of the base; elytra at tip nearly one-half wider than the prothorax, almost one-half longer, the sides distinctly diverging from the humeri, which are well exposed basally, the suture impressed for some distance behind the scutellum; abdomen parallel with nearly straight sides, not quite as wide as the elytra in the male, fully as wide as the latter in the female. Length 1.6 mm.; width 0.5 mm. Mississippi (Vicksburg) and Texas (Galveston).....**rigida** n. sp.

Form slightly stouter, moderately convex and shining; coloration throughout nearly as in *rigida*, the pubescence rather longer, paler and more distinct; punctuation very fine throughout as usual; head with the usual small deep rounded impression at the middle of the vertex, continued to the base by a rather distinctly impressed median line; eyes very prominent, rather small in size; antennae slightly longer than the head and prothorax, nearly as in *rigida* and many other species; prothorax small, the sides strongly converging anteriorly from the narrowly rounded basal angles, nearly as in *rigida* throughout; elytra rather larger, the sides less diverging from the humeri, which are distinctly and broadly exposed at base, the suture only obsoletely and very narrowly impressed behind the scutellum, three-fifths wider and fully one-half longer than the prothorax; abdomen parallel with feebly arcuate sides, almost as wide as the elytra. Length 1.75 mm.; width 0.6 mm. Idaho (Coeur d'Alene), — H. F. Wickham.....**discreta** n. sp.

Form rather stouter, smaller in size, normally convex, sublutaceous, piceous, the head and abdomen blackish, the prothorax and basal parts of the abdomen testaceous; legs and antennae pale flavo-testaceous, the

latter somewhat infuscate distally; pubescence rather long, suberect, pale and distinct; punctuation very fine; head strongly impressed along the middle in apical half, more deeply toward the middle of the vertex, also impressed at the middle of the occiput; eyes rather well developed, not very prominent; antennae evidently longer than the head and prothorax, strongly incrassate distally; prothorax nearly one-half wider than the head and two-fifths wider than long, the sides at first only feebly though evidently convergent anteriorly from the base, more abruptly and strongly arcuate and converging anteriorly than in the two preceding species, the transverse subbasal impression distinct; elytra transverse, two-fifths wider but only about a third longer than the prothorax, the sides strongly diverging from the humeri, which are moderately exposed at base; abdomen scarcely as wide as the elytra. Length 1.35 mm.; width 0.67 mm. Virginia (Fort Monroe).

varicolor n. sp.

- 15—Body rather stout, convex, shining, very obsoletely but regularly micro-reticulate, pale rufo-testaceous in color, the fourth tergite black toward the middle, the legs and antennae pale, the latter slender, but feebly incrassate distally and fully attaining the middle of the elytra; pubescence long, erect, rather abundant and conspicuous; head impressed at the middle of the vertex as usual and feebly along the median line thence to the base, the eyes prominent; prothorax moderately transverse, about a fourth wider than the head, the surface with a very feeble, somewhat rounded impression before the middle of the base; elytra much wider and longer than the prothorax, the humeri widely exposed at base, the suture feebly impressed behind the scutellum; abdomen broad as usual. Length 1.68 mm.; width 0.65 mm. Delaware.....**parvicollis** Csy.

Trichiusa appears to be a genus peculiar to the nearctic regions, excepting the true Pacific coast fauna, and differs greatly in general facies from any of the European types as far as known to me; it is evidently very rich in species and probably less than half have been discovered as yet. *Rigida*, of the above table, occurs in typical form at Vicksburg and the Galveston specimens are somewhat heterogeneous, some having the normally blackish-piceous prothorax, while others have this part bright testaceous; these differences may be sexual, at least in some degree. There is a good deal of structural diversity in the genus.

The following genera are based upon some of our more conspicuous Athetoid species and are compared with European species identified for me by Mr. Reitter under the names *Liogluta vicina* Steph., *L. nitidula* Kr., *L. subplana* J. Sahl., *L. sexnotata* Thoms., *Atheta* (*Homalota* Rey) *castanoptera* Mann., *Atheta trinotata* Kr., and *A. crassicornis* Fab. These

seven species form five genera or subgenera, the first three species having a rather broad, arcuately truncate to triangular mesosternal process, very short and basal infra-lateral carinae of the head and long and slender, barely incrassated antennae, the first four joints of the hind tarsi being rather short and subequal among themselves; they are the true *Liogluta* Thoms. The above assumed *L. sexnotata*, however, differs in having the mesosternal process acutely aciculate, the antennae much longer and gradually and conspicuously incrassate and the elytra much shorter and more transverse when compared with the prothorax, constituting the second genus. *Atheta castanoptera* resembles *sexnotata* in the acutely aciculate mesosternum, but has the infra-lateral carinae much longer, almost attaining the buccal cavity, the antennae and elytra being proportioned as in *Liogluta*. Assuming *Atheta trinotata* as the type of *Atheta*, this genus is distinguished by an acutely aciculate and longer mesosternal process, basal and rudimentary infra-lateral carinae, with the prothorax and elytra proportioned as in *Liogluta* but having the antennae notably short, the subapical joints transverse. Finally *Atheta crassicornis* constitutes a genus having characters nearly similar to *Atheta*, but with the infra-lateral carinae entire and the antennae more developed. The basal joint of the hind tarsi is decidedly shorter than the second in all these five genera, excepting the true *Liogluta*. The subject is a difficult one and is only touched upon at the present time for the reason that I have already published *Anepsiota* (Ann. N. Y. Acad., VII, p. 329), and desire to fix its position in the series more definitely. The generic or subgeneric groups defined below are all allies of *Liogluta* and *Homalota* Rey, (nec Mann., fide Heyden, Reitter and Weise) and not of *Atheta*:—

Infra-lateral carinae of the head abbreviated, not attaining the buccal opening.....	2
Infra-lateral carinae entire.....	12
2 — Hind tarsi short.....	3
Hind tarsi long, sometimes nearly as long as the tibiae, with the two basal joints relatively much more elongate and equal or subequal in length.....	11
— First two joints of the hind tarsi equal in length; abdominal impressions more or less narrow.....	4

- First joint distinctly shorter than the second; impressions as in the preceding group.....9
- First joint longer than the second; abdominal impressions very broadly concave10
- 4 — Mesosternal process more or less broad, frequently obtusely arcuate-truncate at apex.....5
- Mesosternal process very acute at tip.....6
- 5 — Infra-lateral carinae extending less than half way to the buccal opening; antennae rather thin, the last joint of moderate length, about as long as the preceding two combined. Europe. Type *L. vicina* Steph.
- Liogluta**
- Infra-lateral carinae extending almost to the buccal opening, fine; antennae thick, the last joint unusually elongate, as long as the preceding three combined or nearly so. Nearctic Atlantic regions. Type *M. alutacea* Csy. (n. sp.).....**Macroterma**
- 6 — Infra-lateral carinae long, extending more than half way to the buccal opening. Nearctic Pacific coast fauna..... 7
- Infra-lateral carinae extremely short, basal; prothorax small, narrowed toward base. Nearctic Atlantic fauna..... 8
- 7 — Abdomen with four segments impressed at base; elytra granose; antennae long, loose, rather slender, the apical joint normal; prothorax narrower than the elytra. Type *Homalota granulata* Mann...**Elytrusa**
- Abdomen with but three segments impressed at base; elytra not granose; antennae long but thicker, more incrassate and more compact, the last joint pointed at tip and about as long as the two preceding combined; prothorax large. Type *Oxyptoda insignis* Csy.....**Athetota**
- 8 — Abdomen with three segments deeply and subequally impressed at base; integuments densely micro-reticulate and dull; pubescence rather short, subdecumbent; antennae less than half as long as the body. Type *T. brunneipes* Csy. (n. sp.).....**Terasota**
- Abdomen with four segments deeply impressed at base; integuments wholly devoid of micro-reticulation and highly polished; pubescence long, suberect and bristling; antennae more than half as long as the body, very slender. Type *E. lucida* Csy. (n. sp.).....**Euromota**
- 9 — Infra-lateral carinae extending almost to the buccal opening; hind tarsi shorter; antennae nearly as in *Liogluta*. Europe. Type *Homalota castanoptera* Mann.....**Homalota**
- Infra-lateral carinae very short, basal; hind tarsi noticeably less abbreviated; antennae longer, thicker and more incrassate; eyes less developed. Europe. Type *Liogluta sexnotata* Thoms., as identified by Reitter in a specimen collected in the Caucasus.....
- 10 — Infra-lateral carinae very short, obsolescent and basal; prothorax small, with the sides converging toward base; integuments densely micro-reticulate; pubescence short, subdecumbent; antennae nearly as in *Liogluta*; first three abdominal segments broadly and strongly impressed, the fourth narrowly and less strongly though distinctly. Nearctic Atlantic regions. Type *T. ventralis* Csy. (n. sp.)...**Taphrodota**
- 11 — Eyes small, the antennae long, thick, infra-lateral carinae very short, wholly basal; body thick, the prothorax large; first three tergites nar-

- rowly and very moderately impressed at base. Nearctic Pacific coast.
 Type *A. quadricollis* Csy. **Anepsiota**
 12 — Middle coxae contiguous; mesosternal process very short but acute, the metasternum broadly obtuse, not entering the intercoxal space, the longitudinal discontinuity longer than in any allied genus; hind tarsi only moderately short, the first two joints as in *Liogluta*; antennae nearly as in that genus but more elongate; prothorax moderately large, generally parallel; elytra well developed; impressions of the first two tergites large and deeply concave, that of the third much narrower and feeble. Nearctic western mountain regions. Type *H. helenica* Csy. (n. sp.) **Homalotusa**

The *Homalota* of this table is given in the sense understood by Rey. There is some reason to believe that the almost uniformly colored and dark testaceous species identified above as *Liogluta sexnotata* Thoms., is wrongly determined and I therefore hesitate to found a genus upon it, simply indicating its salient characters in the table.

Macroterma n. gen.

Of this genus there are at least two species now known; they may be described as follows: —

Form stout, subparallel, moderately convex, alutaceous, distinctly and evenly micro-reticulate throughout except the abdomen, which is more finely and feebly strigilate in broken transverse lines; punctures everywhere extremely fine, not dense, sparse on the abdomen; pubescence short, decumbent and inconspicuous, pale; color black, the prothorax slightly piceous, the elytra pale brownish-flavate; legs pale, the antennae blackish throughout; head as long as wide, arcuately narrowed behind the large and moderately prominent eyes; antennae attaining the middle of the elytra, stout, the three basal joints elongate, the second shorter than the third, four to ten distinctly transverse, the eleventh gradually pointed, as long as the preceding three combined; prothorax nearly a third wider than the head, a fourth wider than long, parallel and broadly, evenly arcuate at the sides, arcuate at base, the angles obtuse; surface not at all impressed at any point; elytra fully two-fifths wider and a third longer than the prothorax, the sides evidently diverging from the humeri, which are distinctly exposed at base; abdomen parallel, narrowed slightly at tip, narrower than the elytra; tibiae and tarsi slender, moderately long. Length 3.5 mm.; width 0.9 mm. New York (Ithaca), — H. H. Smith. **alutacea n. sp.**

Form nearly similar, feebly, minutely and sparsely punctate, more shining, the micro-reticulation and abdominal strigilation very feeble, black, the elytra and legs pale brownish-testaceous, the antennae blackish throughout; pubescence rather longer but sparser and inconspicuous;

head somewhat more developed, rather longer than wide, the sides parallel and nearly straight behind the eyes, which are smaller and less prominent; nuchal constriction feeble but more abrupt than in *alutacea*, the neck notably broader; antennae nearly similar but more slender toward base, the second joint about equal to the third, the fourth smaller, as long as wide, five to ten transverse, the eleventh not quite as long as the three preceding combined, acutely pointed; prothorax about a third wider than the head and a third wider than long, the sides parallel, evenly arcuate, more strongly so than in *alutacea*, the surface with a very fine and feeble impressed median line except toward tip and a very fine, short and faint transverse line before the base; elytra nearly as in *alutacea* but less transverse, the abdomen much narrower than the elytra, parallel, broader at tip than in *alutacea* but having similarly three narrow and subequal basal impressions. Length 3.2 mm.; width 0.85 mm. New Hampshire (White Mts.).

borealis n. sp.

I can identify neither of these rather conspicuous species with any previously described by Erichson or Say.

Elytrusa (n. gen.), of the above table, is founded upon a species described by Mannerheim, from Unalaska Island, under the name *Homalota granulata*. I have before me a species collected by Mr. Wickham at Fort Wrangel, Alaska, which satisfies the abbreviated original diagnosis very well but is larger; there may therefore be several species of *Elytrusa*. The singular granulation of the elytra is produced by strong asperities attending the fine punctuation.

Athetota n. gen.

Besides *Oxyypoda insignis* Csy., afterwards referred to *Anepsiota* and *Anepsiota wickhami* Csy., (Annals N. Y. Acad., VII, p. 331), this genus will include the following species: —

Moderately stout, parallel, convex, shining, very obsoletely micro-reticulate, the elytra rather more distinctly, the abdomen very faintly so and toward apex only; head and abdomen black, the prothorax rufo-piceous, the elytra paler, brownish; legs paler, testaceous; punctures very fine, sparse, somewhat areolate, closer on the elytra; pubescence short, decumbent, pale and rather distinct, erect but very sparse on the abdomen; head rather longer than wide, the sides feebly swollen behind the eyes, parallel, rounding feebly to the base; eyes moderately large, not prominent; antennae extending almost to the tips of the elytra, slender basally, gradually and strongly incrassate distally, the

second and third joints subequal, outer joints almost as long as wide, obtapezoidal, the eleventh pointed, as long as the two preceding combined; prothorax two-fifths wider than the head and a third wider than long, parallel, the sides evenly and distinctly arcuate, the base rounded; angles obtuse, the surface even, except a short, extremely fine and feeble impression along the median line very near the base; elytra only very slightly wider than the prothorax, nearly a third longer, subparallel; abdomen parallel, subequal in width to the elytra. Length 2.8 mm.; width 0.8 mm. Vancouver Island (Victoria),—H. F. Wickham.....**atriventris** n. sp.

This species differs from *wickhami* in its smaller size, and, from both that and *insignis*, in its relatively more incrassate antennae distally; the elytra resemble those of *insignis* and are relatively less transverse than in *wickhami*.

Terasota n. gen.

The unique type of this genus differs conspicuously in general appearance from *Macroterma* and *Athetota* in its more slender form and small prothorax; it may be described as follows:—

Moderately stout and convex, alutaceous, distinctly micro-reticulate, more obsoletely and coarsely on the abdomen, which is more shining; punctures very fine, indistinct, not very dense, more distinct on the abdomen though sparser apically; pubescence fine, short, inconspicuous; color blackish-piceous, the elytra scarcely at all paler, the abdomen slightly rufescent except toward tip; legs pale brown, the antennae blackish, the first joint piceous; head slightly elongate, the sides arcuately and feebly converging behind the notably large and rather prominent eyes, the neck three-fourths as wide; antennae extending nearly to the middle of the elytra, slender, gradually and moderately incrassate distally, the elongate second and third joints equal, the fourth and fifth elongate, fifth to tenth as long as wide to slightly transverse, the eleventh scarcely as long as the two preceding combined, pointed; prothorax only just visibly wider than the head, a fifth wider than long, widest anteriorly, where the sides are broadly rounded, thence feebly converging and straighter to the base, the angles obtuse but not distinctly rounded; surface feebly impressed along the median line from before the middle nearly to the base; elytra large, one-half wider and longer than the prothorax, the sides feebly diverging from the humeri, which are well exposed at base; abdomen but little narrower than the elytra, parallel, with rather arcuate sides, the three basal impressions strong, somewhat broad and equal. Length 3.25 mm.; width 0.78 mm. New York (Ithaca),—H. H. Smith.....**brunneipes** n. sp.

No characters indicating sex are observable; the sixth tergite is narrowly subtruncate at tip in the type.

Euromota n. gen.

This genus is also represented by a single species, very distinct in facies; it may be briefly described as follows:—

Form moderately stout, rather strongly convex, highly polished, wholly devoid of minute sculpture, very finely and sparsely punctate throughout anteriorly, still more sparsely on the abdomen, the pubescence rather long, erect and sparse but pale and distinct, less obvious on the abdomen; color dark rufo-piceous, the abdomen black or blackish; legs pale testaceous, the antennae fuscous, paler basally; head rather longer than wide, the sides behind the somewhat small but very prominent eyes subparallel and feebly arcuate, thence moderately rounding and converging to the neck, which is four-fifths as wide; antennae very slender, moderately incrassate distally, extending fully to the tips of the elytra, the second and third joints elongate, subequal but shorter than the first, four to nine longer than wide, tenth as long as wide, the eleventh not quite as long as the two preceding combined, pointed; prothorax slightly though obviously wider than the head, only very slightly wider than long, widest near apical third, where the sides are broadly arcuate, thence distinctly converging and straight to the obtuse and well rounded basal angles, the base rather feebly arcuate, the surface narrowly and very feebly impressed along the median line from the middle nearly to the base; elytra two-fifths wider and a third longer than the prothorax, subparallel, broadly impressed on the suture behind the scutellum, the humeri well exposed at base; abdomen parallel, distinctly narrower than the elytra, the tergites convex behind the impressions; legs rather long and slender, the tarsi short. Length 2.6–3.3 mm.; width 0.68–0.8 mm. Virginia (Fort Monroe) and New Jersey **Lucida n. sp.**

No positive indications of sexual identity are discernible among the five specimens at hand. The genus *Euromota* may possibly have some affinity with *Gnyppeta*, but is well distinguished by the short basal joints of the hind tarsi.

Taphrodota n. gen.

The type and only known species of this genus may be described as follows:—

Body rather stout, moderately convex, dull in lustre, strongly micro-reticulate throughout, the reticulae of the abdomen larger and more transverse in form; punctures very fine, indistinct except on the elytra, where they are dense, sparser on the abdomen, which is shining; pubescence short, decumbent, inconspicuous; color blackish-piceous, the abdomen

black throughout, the legs pale brown; antennae blackish, paler toward base, slender, feebly incrassate distally, attaining the middle of the elytra, the elongate second and third joints equal, fourth and fifth elongate, sixth to tenth from as long as wide to very nearly so, the eleventh sharply pointed, as long as the two preceding joints combined; head as long as wide, convex, briefly and linearly impressed at the middle of the vertex; sides arcuately converging behind the moderately large and somewhat prominent eyes to the neck, which is barely two-thirds as wide as the head; prothorax a fourth wider than the head and a fifth wider than long, widest before the middle, the sides broadly arcuate, more converging near the apex, feebly converging and straight toward base, the angles obtuse but scarcely rounded, the surface broadly concave in median third from near the apex to just before the basal margin; elytra three-fifths wider and one-half longer than the prothorax, subparallel, the humeri broadly exposed at base, the angle rounded; abdomen not quite as wide as the elytra, parallel, narrowed near the tip; legs short, moderately slender. Length 3.8 mm.; width 0.93 mm. New York (Ithaca),— H. H. Smith.....*ventralls* n. sp.

In the male the fifth tergite has a very stout and obtusely rounded medial ridge, almost throughout the length, more elevated posteriorly, where it is slightly excavated at each side of the summit, the apical margin of the fourth tergite having a feeble median sinuation; sixth plate feebly sinuate throughout the width and with four small tuberculiform swellings of the edge bounding the sinus.

Anepsiota Casey.

Besides *quadricollis*, the type of the genus, *Anepsiota* may receive provisionally the following species, agreeing in general facies but departing materially in antennal structure and in its shorter tarsi, although the two basal joints of the posterior are each unusually elongated:—

Form more slender than in *quadricollis*, rather convex, pale and uniform rufo-testaceous throughout the body, legs and antennae, somewhat shining though feebly micro-reticulate throughout, the punctures very fine, not distinct, more evident but not dense on the elytra, sparse on the abdomen; pubescence pale but subdecumbent and inconspicuous; head somewhat elongate, parallel, rather abruptly, obliquely and arcuately narrowed at base, the eyes notably small, slightly convex; occiput feebly impressed along the middle; antennae extending somewhat beyond the tips of the elytra, gradually and rather strongly incrassate distally, the second and third joints elongate, the former the shorter,

the next two or three joints perceptibly elongate, thence distinctly transverse to the tenth, the eleventh large, ogivally pointed at tip, longer than the two preceding combined and evidently stouter; prothorax nearly a third wider than the head and a fifth wider than long, widest near apical third, the sides feebly converging thence basally and broadly arcuate to the apex, the surface with a large oval concavity in basal half and median third; elytra transverse, slightly wider and evidently shorter than the prothorax, subparallel, the humeri slightly exposed at base; abdomen parallel, rather wider than the elytra; legs long, the hind tarsi about three-fourths as long as the tibiae. Length 2.9 mm.; width 0.8 mm. British Columbia (Glenora), — H. F. Wickham.

terminalis n. sp.

The sex of the single specimen before me is not determinable with certainty, although probably male, as the sixth ventral plate seems to be minutely and feebly emarginate at the middle.

Homalotusa n. gen.

This genus resembles the European *Homalota* Mann., as interpreted by Rey, but its members are usually materially stouter. It appears to be a local type, though rather abundant both specifically and individually. The four species before me are the following: —

Form moderately stout, rather strongly convex, parallel, somewhat shining, feebly micro-reticulate, the elytra more strongly and duller, the abdomen very minutely strigilate in broken transverse lines; punctures fine, inconspicuous, rather more distinct and dense on the elytra, moderately close-set throughout on the abdomen; pubescence somewhat long, pale and distinct, subdecumbent; color rather pale piceous, the abdomen darker, pale at apex, the legs pale; antenna infusate, paler basally, slender, moderately incrassate distally, attaining the tips of the elytra, the second and third joints much elongated, the former very slightly the longer, succeeding two longer than wide, six to ten nearly as long as wide, the eleventh pointed, barely as long as the two preceding combined; head orbicular, as long as wide, arcuate and narrowed behind the eyes, the neck four-fifths as wide, the eyes moderate, not very convex, the surface evenly convex; prothorax about a fifth wider than the head and a fifth wider than long, parallel, evenly arcuate at the sides, the apex and base subequal in width, the surface even, with a very small feeble rounded impression before the scutellum; elytra but slightly transverse, about a fifth wider and a third longer than the prothorax, narrowly impressed on the suture behind the scutellum, the humeri but very slightly exposed at base; abdomen parallel, slightly narrower than the elytra. Length 3.9 mm.; width 0.85 mm. Montana (Helena), — H. F. Wickham..... **helenica** n. sp.

Form nearly similar, equally shining and similarly sculptured, the pubescence rather shorter, black, the abdominal apex rufescent, the elytra dark piceo-testaceous; legs pale brown, the antennae blackish, paler basally, nearly as in *helenica* but somewhat shorter, not quite extending to the tip of the elytra, the second joint more distinctly longer than the third; head nearly similar but more abruptly constricted at base; prothorax rather shorter and more transverse, nearly a fourth wider than long and a fourth wider than the head, the sides parallel and similarly feebly arcuate, the small impression at the base also similar; elytra shorter and more transverse, slightly wider than the prothorax and a fourth longer; abdomen parallel and straight at the sides, evidently narrower than the elytra. Length 4.2 mm.; width 0.85 mm. California (Lake Tahoe).....*tahoensis* n. sp.

Form much shorter and less convex, less shining, more strongly micro-reticulate, the elytra very dull; punctures very close-set throughout; pubescence short and rather inconspicuous; color blackish, the elytra castaneous, the abdomen pale at tip, the legs pale brown; antennae nearly similar, blackish, the first joint testaceous, not quite extending to the tips of the elytra, the distal joints obtrapezoidal, the second but slightly longer than the third, four to seven longer than wide, eight to ten as long as wide, the eleventh not as long as the two preceding combined; head nearly as in *tahoensis* but having a small impression at the middle of the vertex; prothorax relatively smaller, more than a fourth wider than the head, a fifth wider than long, parallel and broadly, feebly arcuate at the sides, the basal angles similarly obtusely rounded, the surface with a much larger and more conspicuous rounded impression before the scutellum; elytra large, a third wider and two-fifths longer than the prothorax, only slightly wider than long, not very evidently impressed behind the scutellum, the humeri more exposed at base; abdomen parallel, narrower than the elytra, more shining than the anterior parts, the punctures sparse toward tip, close-set elsewhere. Length 3.8 mm.; width 0.93 mm. Idaho (Coeur d'Alene), — H. F. Wickham.....*fuscula* n. sp.

Form stout and rather feebly convex as in *fuscula*, similarly dull and strongly micro-reticulate, the abdomen less finely sculptured and reticulate rather than strigilate, somewhat less shining; punctures similarly very fine, dense on the elytra; color pale yellowish-brown throughout, the head more piceous, the abdomen with a large picescent cloud before the apex; antennae fuscous, the basal joint pale, more slender, extending almost to the tips of the elytra, the second joint but slightly longer than the third, joints four to eight very distinctly, nine and ten slightly, longer than wide, the eleventh sharply pointed, not as long as the two preceding combined; head as wide as long, the sides arcuate and converging behind the eyes, which are more prominent, the vertex with a feeble median impression; prothorax much larger than in *fuscula*, about a fifth wider than the head and a fourth wider than long, widest at apical two-fifths, the sides feebly arcuate, becoming very slightly convergent and straighter toward base, the ante-scutellar impression very small and feeble as in *helenica*; elytra large, about a third wider and nearly one-half longer than the prothorax, the humeri somewhat ex-

posed; abdomen parallel, but little narrower than the elytra. Length .5 mm.; width 0.9 mm. Idaho (Cœur d'Alene)..... *pallida* n. sp.

No indication of sex is observable in any of the specimens at hand.

Valenusa n. gen.

A species of very distinct facies forms the type of this genus, allied to *Atheta* but differing in its elongate slender form, pyriform head with small and anterior eyes, much shorter mesosternal process, which is very acute, and in the extremely extended longitudinal discontinuity in the form of a narrow, acutely rounded ridge, the metasternum being broadly arcuate and not entering the intercoxal space; the coxae are closely contiguous. The infra-lateral ridges of the head extend forward more than half way to the buccal opening and the hind tarsi are short, with the basal joint very much shorter than the second. The type may be described as follows:—

Form very slender, parallel, moderately convex, alutaceous, distinctly micro-reticulate, the abdomen polished and minutely strigilate in transverse wavy lines; pubescence short, decumbent, inconspicuous, the punctures very fine, rather close-set but indistinct, sparse on the abdomen posteriorly; color pale testaceous, the head but little darker, the abdomen feebly infusate except at the apices of the segments; legs pale, the antennae infusate, the first joint pale, rather stout, distinctly incrassate distally, extending to about basal third of the elytra, the second joint distinctly longer than the third, fourth slightly longer than wide, fifth to tenth progressing from as long as wide to distinctly transverse, the eleventh obtusely pointed, about as long as the two preceding combined; head inflated toward base with rounded sides, slightly elongate, abruptly but feebly constricted at base, the neck wide; eyes small, only slightly convex; prothorax but slightly though evidently wider than the head, a fifth or sixth wider than long, subparallel, widest before the middle, the sides feebly arcuate, becoming straighter and just visibly convergent posteriorly to the obtusely rounded basal angles, the surface very finely and feebly impressed along the median line almost from apex to base, becoming gradually slightly less feebly so basally; elytra but very slightly wider and only just visibly longer than the prothorax, the sides feebly diverging from the humeri, which are very slightly exposed at base; abdomen nearly as wide as the elytra, parallel, elongate, the first three tergites strongly and equally impressed at base. Length 3.4 mm.; width 0.65 mm. California (Pomona, Los Angeles Co.),—H. C. Fall.

parallela n. sp.

There are no external indications of sex in the single type specimen in my cabinet.

Eurynotida n. gen.

In general facies this genus differs wholly from any other of the present tribe, shorter and even broader than any form of *Hoplandria*, the middle coxae are closely contiguous, with the mesosternal process extremely short and cuspidiform, the metasternum arcuato-truncate and not at all projected between them; the infra-lateral carinae of the head are strong and entire, the maxillary palpi very slender, setose, the antennae slender, subfiliform, the hypomera invisible from the sides and the hind tarsi rather long, slender, with the basal joint as long as the next three combined. We have at present two species as follows:—

Form very stout, rather convex, shining, not reticulate, minutely, not very closely and indistinctly punctulate, testaceous in color, the head and elytra darker, piceous-brown, the latter nubiliously paler about the scutellum and each testaceous at the outer apical angle, the inner outline of the pale spot oblique and straight; abdomen with a large nubilious piceous cloud before the tip; legs and antennae pale flavate throughout; pubescence rather long, pale, prostrate but inconspicuous except on the abdomen, where it is longer and intermixed with sparse erect tactile setae; head transverse, small, rapidly and arcuately narrowed behind the moderate and somewhat prominent eyes, convex, unimpressed, the neck only moderately broad; antennae slender, extending almost to the tips of the elytra, the second joint rather longer than the third, both much elongated, four to ten more or less distinctly longer than wide and only just visibly increasing in thickness, the eleventh very slender, pointed, almost as long as the three preceding combined; prothorax about twice as wide as long, almost four-fifths wider than the head, parallel and evenly arcuate at the sides, broadly rounded at base, the basal angles well rounded, the surface wholly unimpressed; elytra short, transverse, the base not quite as wide as the prothorax, the suture about as long as the median line of the latter, the sides feebly diverging; abdomen not quite as wide as the elytra, parallel, narrowed slightly at tip, the basal tergites not very obviously impressed at base. Length 2.2 mm.; width 0.87 mm. Texas (Del Rio),—H. F. Wickham.

ornata n. sp.

Form, sculpture and pubescence nearly similar, slightly shorter, testaceous, the head blackish, the elytra piceous-brown with the sutural region and external apical angles pale testaceous as in *ornata*, the abdomen with a similar piceous cloud; head larger, the eyes moderate and similarly somewhat coarsely faceted; antennae with the joints two to four elongate, uniformly decreasing in length, the second more evidently longer than the third; prothorax more than twice as wide as long, the

sides not parallel but evidently converging from the rounded basal angles to the apex, barely three-fourths wider than the head, similarly wholly unimpressed; elytra nearly similar but more transverse, evidently shorter and narrower than the prothorax; abdomen at base as wide as the elytra, thence strongly and arcuately narrowed to the apex, which is relatively much narrower than in *ornata*. Length 1.7 mm.; width 0.8 mm. Arizona (Phoenix).....*arizonica* n. sp.

No distinct sexual modifications are apparent, the sixth tergite being broadly bilobed at tip in each of the single types at hand.

BOLITOCCHARINI.

Silusa Er.

Besides the two species described below, this genus will include the American species *californica* Bern., and *vesperis* Csy., these having the peculiar oral structures of *Silusa*; but the form that I have identified as *gracilis* Sachse, does not seem to be a true *Silusa*, having more the facies of *Lep-tusa*, and *Silusa nanula* Csy., belongs evidently to a different genus: —

Form parallel, not very stout, convex, shining, the integuments wholly devoid of minute sculpture, blackish, the elytra, abdominal apex and apices of all the segments paler, castaneous; legs pale, the antennae fuscous, pale at tip and toward base; pubescence not dense, moderate in length; punctures fine, not close, impressed and simple, those of the elytra larger, close-set and asperate, sparse and fine throughout on the abdomen; head wider than long, the eyes moderate; antennae extending to basal third of the elytra, stout and gradually incrassate distally, the elongate second and third joints equal, the subapical moderately transverse, the eleventh pointed and as long as the two preceding; prothorax two-fifths wider than long and fully one-half wider than the head, the sides broadly arcuate, more converging toward apex, the basal angles obtuse but not rounded, the surface with a feeble transverse impression before the scutellum; elytra only just visibly wider but two-fifths longer than the prothorax, strongly and broadly impressed behind the scutellum, the impression paralleling the sutural margin posteriorly; abdomen narrower than the elytra, parallel, the first three tergites strongly and broadly impressed at base, the fourth more narrowly and feebly; hind tarsi short, the first four joints short and subequal. Length 3.8 mm.; width 0.88 mm. New York (Catskill Mts.), — H. H. Smith.

valens n. sp.

Form much stouter, moderately convex, shining, pale flavo-testaceous, the head and a large ante-apical abdominal cloud blackish, the elytra very faintly shaded with piceous toward the external apical angles; punc-

tures very fine, not very close-set, those of the elytra more visible, asperulate and close, those of the abdomen somewhat sparse though closer than in *valens*; head nearly as long as wide, the eyes well developed; antennae attaining the middle of the elytra, joints five to ten rather stout, subequal in width and rather strongly transverse, the eleventh conoidal and rather longer than the two preceding; prothorax strongly transverse, fully one-half wider than the head and nearly three-fourths wider than long, the sides broadly arcuate, slightly converging toward apex, the basal angles obtuse and somewhat blunt, the surface with a very feeble transverse impression before the scutellum; elytra only very slightly wider than the prothorax but two-thirds longer, somewhat narrowly impressed for some distance behind the scutellum; abdomen much narrower than the elytra, parallel, the basal impressions rather narrow and not very deep, the third tergite scarcely and the fourth not at all impressed. *Male* with a minute rounded tubercle on the fifth tergite at some distance from the apical margin. Length 2.7 mm.; width 0.83 mm. California (Licking Fork of the Mokelumne River — 3,000 feet), — F. E. Blaisdell.....*decolorata* n. sp.

The single type of *valens* is evidently a female. *Decolorata* differs from *californica* Bern., in its paler coloration and in its shorter and relatively broader prothorax, shorter elytra and subparallel and not gradually incrassate antennae.

Eucryptusa n. gen.

This name is proposed for the species described by the writer (Annals N. Y., VII., p. 352) under the name *Silusa nanula*. It differs from *Silusa* in its smaller, unemarginate mentum, less elongate labial palpi and stouter and shorter paraglossae, as well as in its still shorter first four subequal joints of the hind tarsi and in its system of sculpture.

Pancota n. gen.

This genus is also allied to *Silusa*, differing in the very small size of the body, smaller and medially sinuate mentum and less elongate palpi, but, more particularly, in the extremely slender and filiform tarsi, the posterior being somewhat more elongate but with the first four joints subequal as usual in this group. The single known type is the following: —

Body slender, moderately convex, shining, without minute ground sculpture of any kind, pale brownish-flavate in color, the head and posterior

half of the abdomen nubilously piceous, the legs and antennae pale; punctures relatively rather large, impressed, somewhat close-set, those of the elytra dense and more asperate but scarcely larger, of the abdomen very fine toward base but larger, longitudinally asperate and somewhat sparser toward tip; head wider than long, the eyes moderate; antennae short and very slender, only very slightly but gradually incrassate distally, about as long as the head and prothorax, the second joint somewhat longer than the third, the subapical joints evidently transverse, the last pointed and about as long as the preceding two; prothorax strongly transverse, about three-fourths wider than long and fully two-fifths wider than the head, the sides subparallel, evenly and strongly arcuate, the basal angles obtuse and slightly rounded, the surface with the merest trace of a fine short linear and transverse impression before the scutellum; elytra parallel, transverse, obviously narrower than the prothorax and of equal length, with a very minute post-scutellar impression; abdomen parallel, nearly as wide as the elytra, the first three tergites narrowly, rather feebly and decreasingly impressed at base, the fourth wholly unimpressed. Length 1.8 mm.; width 0.43 mm. New York (Catskill Mts.), — H. H. Smith.....*collaris* n. sp.

The single type is evidently a female.

Dianusa n. gen.

The body in this genus is very small, rather stout, the middle coxae very narrowly separated, the mesosternal process extending two-thirds their length, attenuate at tip and nearly attaining the angular prolongation of the metasternum, the infra-lateral carinae of the head complete, the eyes moderate, not very finely faceted, the neck slender, less than half as wide as the head and the hind tarsi short, with the first four joints short and equal. The mentum is transverse and truncate and the labial palpi shorter and stouter than in *Silusa*. The single type may be known by the following characters:—

Body parallel, moderately convex, alutaceous, micro-reticulate throughout, the reticulae of the abdomen larger and faint; color testaceous, the head and the abdomen, except at apex and toward base, blackish; legs and antennae pale; punctures very minute, not dense, subgranuliform, more distinct on the elytra, the pubescence moderate; head transversely elliptical, convex, rather small, the antennae short, not longer than the head and prothorax, feebly and gradually incrassate distally, the second joint longer and thicker than the third, the subapical joints transverse; prothorax short, two-fifths wider than the head and

three-fourths wider than long, the sides parallel and evenly arcuate, the basal angles obtuse and slightly rounded, the surface extremely faintly, transversely impressed before the scutellum; elytra well developed, equal in width to the prothorax and nearly one-half longer, parallel, with a small sutural depression behind the scutellum; abdomen distinctly narrower than the elytra, parallel, shining, sparsely punctured toward tip, the first three tergites narrowly and equally impressed at base. Length 1.7 mm.; width 0.42 mm. California (Pasadena), — *A. Fenyès*..... **pasadenæ** n. sp.

The male has some irregularly scattered granules toward apex of the fifth and sixth tergites throughout the width, the sixth truncate, with about eight rather large serrulations throughout the width, the median interval rather wider than the others.

Ulitusa n. gen.

This genus resembles *Silusa* but differs in the minute size and in the truncate mentum, not prolonged anteriorly at the sides and laterally impressed on the surface; the labial palpi are long but much stouter, three-jointed, the infra-lateral carinae of the head strong and entire, the middle coxae and adjacent parts as in the preceding genus, but with the acute mesosternal process freer; the hind tarsi are moderately stout, nearly three-fourths as long as the tibiae, with the first four joints short and subequal; the eyes are rather small, prominent, the sides of the head behind them somewhat strongly convergent and evenly arcuate to the neck. The sculpture is coarse and conspicuous. We know at present two species as follows: —

Body rather slender, moderately convex, the surface without minute ground sculpture, except a feeble reticulation toward the abdominal apex, shining, coarsely and closely but not densely punctate throughout, except on the abdomen, which is finely and sparsely punctate; pubescence inconspicuous; color dark testaceous, with the elytra blackish, paler at the humeri and also along the apical margin, the abdomen with a blackish or ficeous subapical cloud, the legs pale, the antennae black, pale at apex and gradually paler toward base; head nearly as long as wide, strongly, closely punctate, the antennae stout, gradually incrassate distally, the second and third joints elongate, the former somewhat the longer, the subapical joints transverse, the pale eleventh joint stout and conoidal; prothorax short, a third wider than the head and fully two-thirds wider than long, widest before the mid-

dle, the sides converging and sinuate basally, the angles acute, not at all rounded and slightly prominent, the surface not obviously impressed; elytra not wider than the prothorax and nearly one-half longer, feebly impressed behind the scutellum, the humeri evidently exposed at base; abdomen slightly narrower than the elytra, parallel, the first three tergites strongly and equally impressed at base, with their surfaces thence notably convex to tip, the remaining plates nearly flat. Length 1.9 mm.; width 0.44 mm. Ohio (Cincinnati), — Chas. Dury.....*cribratula* n. sp.

Body nearly similar but smaller, convex, rather shining, rufo-testaceous throughout, except the head and a subapical abdominal cloud which are blackish; legs pale, the antennae black, gradually paler toward base but not at apex; head and elytra coarsely, not densely punctate, the pronotum notably less coarsely so, the abdomen strongly and rather closely but sparsely toward tip; pubescence rather coarse, pale in color; head wider than long, convex, the antennae longer than the head and prothorax, less stout than in the preceding species, gradually incrassate distally, the subapical joints transverse, the second much longer than the third; prothorax less transverse, fully a third wider than the head and one-half wider than long, widest before the middle, the sides thence moderately converging to the basal angles, which are not so distinct or prominent as in *cribratula*, the surface not evidently impressed; elytra somewhat wider than the prothorax and a third longer, impressed along the suture for a long distance behind the scutellum, the humeri but slightly exposed; abdomen narrower than the elytra, nearly as in *cribratula*, the legs similarly rather short and slender. Length 1.65 mm.; width 0.4 mm. Ohio (Cincinnati), — Chas. Dury....*pusio* n. sp.

The type of *cribratula* is a female; in *pusio*, however, the male has a rather narrow, acutely elevated carina in almost apical half of the fifth tergite, not quite attaining the apical margin, the sixth concealed in the type.

Goniusa n. gen.

I would propose this name for a genus represented at present by a single species, described by LeConte many years ago under the name *Euryusa obtusa*. It resembles *Euryusa* somewhat in general form, but differs conspicuously in the structure of the hind tarsi, the basal joint of the latter being about as long as the next two combined in that genus, while in *Goniusa* it is about as long as the succeeding joint, the first four subequal in length and rather elongate, the entire tarsus being about two-thirds as long as the tibia. The intermesocoxal parts are nearly as in *Euryusa* and many other genera of the subtribe, but the body is much broader, the

abdomen wider and with the impression of the third tergite feeble, becoming wholly obsolete toward the sides of the plate.

Amenusa n. gen.

In its subdepressed, parallel form and dense dull integuments, the general aspect of this distinct genus is not unlike *Placusa*, but it differs in having the middle coxae rather widely separated, the mesosternal process very short, truncate and virtually abutting against the very long broad metasternal projection. The infra-lateral carinae of the head seem to be entire but are extremely feeble or obsolescent anteriorly and the hind tarsi are short, with the first four joints short and subequal, the fifth long, almost equaling the four basal together; the claws are long, slender and feebly arcuate. The single known species may be thus briefly described: —

Form rather slender, parallel, feebly convex, alutaceous, black or blackish, the elytra paler, piceous; legs pale, the antennae blackish, gradually paler toward base; integuments densely micro-reticulate, the abdomen minutely, faintly strigilate in transverse wavy lines; punctures very fine, close-set but indistinct except on the elytra, very fine on the abdomen and sparse, the latter more shining; pubescence short and inconspicuous; head wider than long, the eyes rather well developed, prominent, the sides strongly converging and broadly arcuate behind them to the neck; antennae fully attaining basal third of the elytra, gradually and moderately incrassate distally, the elongate second and third joints subequal, the subapical joints transverse, the eleventh subpyriform; prothorax transverse, a fourth wider than the head and one-half wider than long, widest at apical third, the sides broadly arcuate, feebly converging and straight toward base, the angles obtuse but not at all rounded, the surface not distinctly impressed; elytra only just visibly wider but one-half longer than the prothorax, parallel, very feebly impressed behind the scutellum, the humeri somewhat exposed at base; abdomen obviously narrower than the elytra, the first three tergites narrowly and subequally impressed at base. Length 2.7 mm.; width 0.57 mm. California (Pomona, — Los Angeles Co.), — H. C. Fall.....**angustula** n. sp.

The male has no discal marks on the apical tergites but the sixth is broadly truncate at tip, the edge throughout closely pectinate, the teeth triangular, the extreme lateral tooth on each side more isolated, longer and more slender.

Sibiota n. gen.

This genus is perhaps most closely allied to *Sipalia*, though evidently isolated. The body is slender, with the elytra abbreviated and the infra-lateral carinae of the head wholly obsolete, the eyes small and anterior and the middle coxae approximate. The hind tarsi are rather short, the basal joint evidently longer than the second though not as long as the next two combined. The type may be described as follows:—

Form slender, subparallel, moderately depressed, sublutaceous, the integuments feebly micro-reticulate throughout, pale rufo-testaceous, the abdomen black, slightly paler at tip, the legs pale, the antennae infuscate distally; punctures very fine, moderately close-set but indistinct, sparse on the abdomen; pubescence pale, subdecumbent, rather long and distinct; head pyriform, swollen toward base with arcuate sides, rather longer than wide, the neck somewhat narrow; antennae extending to the middle of the elytra, gradually and moderately incrassate distally, the subapical joints transverse, the second evidently longer than the third; prothorax quadrate, distinctly wider than the head, very slightly wider than long, just visibly wider near apical third than at base, the sides feebly arcuate, rounding anteriorly to the apex, less arcuate basally, the basal angles somewhat broadly rounded, the surface broadly, feebly concave along median third from base nearly to the apex, the concavity gradually disappearing; elytra equal in width to the prothorax and rather less than three-fourths as long, the sides somewhat diverging from the base; abdomen as wide as the elytra, the sides parallel, the first three tergites narrowly and feebly impressed at base; legs moderately long and slender. Length 2.35 mm.; width 0.5 mm. Oregon (Portland),—H. F. Wickham.

impressula n. sp.

The type appears to be a female. *Sibiota* differs from *Sipalia* in the obsolete infra-lateral carinae of the head, and, from *Typhlusida* (ante, p. 263;—type *flava* Kr.), it differs in its longer basal joint of the hind tarsi.

Leptusa Kr.

The genus *Leptusa*, like *Oxypoda*, is composite as organized at present in American literature, but the time is not yet ripe to study it in detail and it must suffice for the present to

announce that *brevicollis* will constitute one group, *seminitens* and *opaca* another, *americana* Bern., a third, and the species described below two more. The species selected for description at the present time are the following:—

Form rather slender, parallel, convex, the anterior parts feebly reticulate, the head and pronotum not very finely but closely and feebly punctate and dull, the elytra closely, more deeply and asperately punctured and more shining, the abdomen devoid of minute ground sculpture except a feeble reticulation at the extreme apex, not very finely, closely punctured and somewhat shining; color dark and uniform piceous-brown, the abdomen pale rufo-testaceous, with a black cloud involving the fourth tergite and basal half of the fifth; legs pale, the antennae black, pale at apex and toward base; pubescence pale, subdecumbent; head wider than long, narrowed behind the moderate and prominent eyes, the antennae almost attaining the middle of the elytra, stout, gradually incrassate, the second and third joints much elongated and subequal, the subapical joints transverse; prothorax almost a third wider than the head and fully two-fifths wider than long, widest at apical two-fifths, where the sides are rather prominently rounded, thence converging and feebly sinuate to the base, the basal angles rather prominent, not evidently blunt, the surface not obviously impressed; elytra only just visibly wider than the prothorax and barely two-fifths longer, parallel, the humeri somewhat exposed at base; abdomen long, parallel, evidently narrower than the elytra, the first three tergites strongly and equally impressed at base. Length 2.4–3.2 mm.; width 0.6–0.65 mm. Iowa (Iowa City) and Ohio (Cincinnati)..... *tricolor* n. sp.

Form, coloration and lustre nearly as in *tricolor*, the apical joint of the antennae not so completely pale; punctures of the anterior parts rather large and very close-set, those of the head very shallow and variolate, of the pronotum deeper and somewhat asperulate, of the elytra still stronger and asperate, of the abdomen fine but strong, close but notably less so than in *tricolor* and becoming rather sparse toward tip; head nearly as in *tricolor* but more shining, the antennae shorter and notably less strongly incrassate distally, attaining about basal third of the elytra, the second and third joints subequal, the subapical transverse; prothorax distinctly wider than the head, about two-fifths wider than long, nearly as in *tricolor* but with the basal angles rather more obtuse and less prominent though very distinct, the surface with the merest trace of transverse impression before the scutellum; elytra relatively much larger, fully a fourth wider than the prothorax and nearly one-half longer, the humeri well exposed; abdomen narrower, much narrower than the elytra, parallel, similarly impressed. Male with a very short and feeble carinule behind the centre of the fifth and sixth tergites, the latter broadly sinuato-truncate and minutely, closely serrulate at tip. Length 2.4 mm.; width 0.63 mm. Mississippi (Vicksburg)..... *canonica* n. sp.

Form more slender, parallel, convex, alutaceous, the abdomen more shin-

ing; punctures of the head and pronotum extremely fine, feeble and indistinct, close-set, of the elytra only somewhat less fine but more obvious, dense and feebly asperulate, of the abdomen very fine and close-set throughout; color pale rufo-testaceous, the entire abdomen black, the legs and antennae pale, the latter infusate distally, the apex not paler; pubescence pale and close but short and not very conspicuous; head wider than long, subparallel at the sides, abruptly constricted at base, the eyes rather large, convex; antennae short, only slightly longer than the head and prothorax, gradually but feebly incrassate distally, second and third joints only moderately elongate and subequal, the subapical transverse, the eleventh deeply excavated near the apex; prothorax fully a fourth wider than the head but only a fourth or fifth wider than long, subparallel, widest before the middle, the sides broadly arcuate, rather straighter toward base, the angles obtuse and slightly rounded, the surface scarcely visibly transversely impressed before the scutellum; elytra about a fifth wider and nearly a third longer than the prothorax, the humeri slightly exposed; abdomen distinctly narrower than the elytra, long, parallel, the first three tergites only very narrowly and feebly impressed at base, their surface flat and not convex as in the two preceding species; basal joint of the hind tarsi as long as the next two combined; sexual characters not evident. Length 2.1-2.5 mm.; width 0.55-0.61 mm. North Carolina (Tryon) and Ohio (Cincinnati).

semirufa n. sp.

Tricolor, and possibly the allied *canonica* also, sometimes occurs in the company of a rather small piceous ant with paler brown legs.

Phaenogyra Rey.

The indication, on page 278 of the present paper, that *Phaenogyra* is an exclusively European genus, can fortunately be corrected now by the chance discovery of a representative among some unclassified material in my cabinet. This circumstance is interesting, not only in proving *Phaenogyra* to be American as well as European, but in being the only evidence known to me of the occurrence of the subtribe Gyrophaenae in California. It may be described as follows: —

Rather stout, moderately convex and shining, blackish-piceous in color throughout, the legs and antennae pale, the latter feebly infusate distally; integuments coarsely and strongly micro-reticulate, the abdomen more feebly so; pubescence short, stiff and sparse; head transverse, with fine scattered punctures except broadly along the median line, the eyes moderate, prominent; antennae barely as long as the head and prothorax, slender basally, abruptly stout from the fifth joint, the latter to the tenth loose, feebly incrassate and strongly transverse, the

eleventh oval, pointed, not quite as long as the two preceding combined, fourth joint small and transverse; prothorax small, wider than the head, one-half wider than long, the sides converging and feebly arcuate from the broadly rounded basal angles to the apex, the base strongly, subcircularly rounded and finely reflexed, the punctures minute, sparse and irregularly distributed; elytra large, more strongly, asperately and uniformly punctured, rather closely so, about a third wider than long, nearly two-fifths wider and one-half longer than the prothorax, the humeri well exposed and rounded, the suture impressed almost throughout the length; abdomen at base as wide as the elytra, feebly tapering and with slightly arcuate sides thence to the tip, minutely, rather sparsely punctured throughout. Length 1.4 mm.; width 0.63 mm. California (Ojai), — H. C. Fall. *californica* n. sp.

The abdomen in the single specimen at hand is retracted at apex, so that the sex cannot be determined.

Thinusa Csy.

The first of the following species is the largest Phytosid known to me: —

Form stout, parallel, rather convex, brownish-testaceous, the prothorax clearer, the abdomen black; legs pale, the antennae infusate distally; integuments dull, minutely and densely granulato-reticulate, the punctures very minute and not distinct even on the elytra, the abdomen finely, evenly and rather closely punctulate; pubescence pale, rather long and conspicuous, directed outwardly from the median line on the pronotum; head longer than wide, the eyes well developed and somewhat coarsely faceted but not prominent; antennae moderately incrassate distally, one-half longer than the head, the second joint nearly as long as the next two combined, the subapical transverse, the eleventh very short, conoidal; prothorax slightly wider than the head and somewhat wider than long, widest at apical two-fifths, where the sides are broadly arcuate, thence rather distinctly converging and somewhat sinuate to the arcuato-truncate base, the angles very slightly rounded, the surface with a very fine, feebly impressed and nearly entire median line; elytra scarcely as wide as the prothorax and scarcely more than two-thirds as long; abdomen parallel, very long, as wide as the prothorax, the first three tergites strongly and the fourth feebly impressed at base; hind tarsi longer than in *maritima*, with the first four joints somewhat elongate and equal; claws much longer, compressed and somewhat distorted. Length 2.6 mm.; width 0.68 mm. Queen Charlotte Island (Massett), — J. H. Keen. *fletcheri* n. sp. (Fvl. MS).

Form very slender, minute, blackish-castaneous, the abdomen black, the legs and antennae pale, opaque, densely and minutely granulato-reticulate, the abdomen less strongly so; pubescence short and inconspicuous; punctures very minute, obscure, distinct but fine and close-set on

the abdomen; head longer than wide, the eyes well developed and slightly prominent; antennae as long as the head and prothorax, distinctly and gradually incrassate distally, the second joint as long as the next two combined, the subapical transverse; prothorax very slightly wider than the head and almost as long as wide, widest anteriorly, where the sides are rounded, thence rather strongly converging and straighter to the obviously rounded basal angles, the surface rather broadly but feebly impressed along the median line almost to the apex; elytra not quite as wide as the prothorax and three-fourths as long, angularly emarginate toward the suture at tip, the sides feebly diverging from the humeri, which are gradually rounded to the prothorax and not exposed at base; abdomen but little longer than the remainder of the body, parallel, as wide as the elytra, the first three tergites very narrowly and extremely feebly impressed at base; hind tarsel shorter than in *fletcheri* and with the basal joint distinctly longer than the second — not shorter as in *maritima*, the claws minute. Length 1.3 mm.: width 0.3 mm. California (Sta. Barbara)..... *obscura* n. sp.

The basal impressions of the abdomen are much larger and deeper in *fletcheri* than in *maritima* or *obscura* and the last may be distinguished from *maritima* by its smaller size, relatively narrower prothorax, darker color, longer basal joint of the hind tarsi and closer abdominal punctuation.

Amblopusa Csy.

The chief points of distinction between this genus and *Bryobiota* Csy., are the very broad subvertical hypomera and short third antennal joint of the former. In the latter genus the hypomera, although only feebly inflexed, are narrow, as usual, and the third antennal joint is distinctly elongate, in fact almost as long as the second; the eyes, also, although small and coarsely faceted, are better developed. The following species departs radically from *brevipes* in its larger size, very much longer tarsal claws and more developed eyes: —

Form slender, parallel, dull, very minutely and densely sculptured, the punctures very fine, close-set and indistinct, somewhat more visible on the elytra, extremely minute, close-set but evident on the abdomen, which is only very obsoletely reticulate and rather shining; color pale rufotestaceous, the abdomen black, feebly paler at tip, the legs pale; pubescence rather long, pale and conspicuous except on the abdomen; head large, scarcely longer than wide, feebly inflated at base, subdepressed, feebly impressed on the median line toward base, the eyes small, evenly oval, consisting of about twenty coarse facets, the pos-

terior facets less convex than the anterior; antennae missing in the type; prothorax slightly narrower than the head, not quite as long as wide, widest near the apex, the sides rather strongly converging and almost straight to the base, the angles obtuse but scarcely at all blunt, the surface broadly, feebly impressed along the middle almost throughout; elytra evidently narrower than the prothorax and but little wider than the base of the latter, parallel, two-thirds as long; abdomen one-half longer than the remainder of the body, subparallel, fully as wide as the head, the first five segments very narrowly, feebly and subequally impressed at base; hind tarsi but little more than half as long as the tibiae, stout, the first four joints very short and subequal, the claws very long, slender and evenly arcuate. Length 2.5 mm.; width 0.46 mm. Queen Charlotte Island (Massett), — J. H. Keen. *borealis* n. sp.

I have before me but a single specimen of undetermined sex and it has unfortunately lost all but the basal joint of the antennae.

HYGRONOMINI.

Bamona Shp.

The following species belong to *Bamona* proper and not to *Gyronycha*, and the first is interesting in proving its extended distribution, paralleling that of *Gyronycha*: —

Form slender, rather convex, polished, black or blackish throughout, the legs pale piceous, the antennae black, gradually paler basally; integuments devoid of any trace of minute ground sculpture, very finely, not densely punctured throughout; pubescence fine, short, ashy and rather distinct on the elytra, elsewhere inconspicuous; head nearly as wide as long, the sides very broadly rounded and converging behind the moderate eyes to the neck, which is fully three-fifths as wide; antennae thick, not quite attaining the middle of the elytra, gradually incrassate distally, the joints close-set, obtrapezoidal distally, opaque, densely clothed with a mixture of short stiff silvery, and longer fine and dark, hairs, the second longer than the third, both elongate, the subapical moderately transverse, the eleventh somewhat thicker, oval, rather longer than the two preceding; prothorax slightly narrower than the head, somewhat longer than wide, widest near apical third, where the sides are subprominently rounded, thence feebly converging and subsinuate to the base, the surface wholly unimpressed; elytra large, four-fifths wider and two-fifths longer than the prothorax, the humeri well exposed at base; abdomen much narrower than the elytra, parallel, the first three tergites strongly but narrowly impressed at base; hind tarsi slender, with the basal joint about as long as the next two combined, the fifth gradually thickened toward tip. Length 1.7 mm.; width 0.4 mm. North Carolina (Asheville) *carolinae* n. sp.

Form very slender, rather convex, highly polished, minutely, rather closely

but indistinctly punctured, sparsely toward the tip of the abdomen as usual, the pubescence inconspicuous; color blackish, the prothorax, abdomen, except a subapical darker region, legs and the antennae toward base, pale; head smaller than in *falliana*, with very much more broadly rounded basal angles, the antennae nearly similar but scarcely so stout, fully attaining the middle of the elytra; neck barely half as wide as the head; prothorax much narrower than the head and distinctly elongate, subprominently rounded at the sides at apical third, thence feebly, subsinuately narrowed to the base, the surface wholly unimpressed; elytra more than four-fifths wider but less than a third longer than the prothorax; abdomen much narrower than the elytra, the three basal impressions very narrow and only moderately deep, polished and smooth as usual; hind tarsi slender, almost three-fourths as long as the tibiae, the basal joint somewhat longer than the next two combined. Length 2.1 mm.; width 0.35 mm. California (Mokelumne Hill, Calaveras Co.),—F. E. Blaisdell.....*tenuissima* n. sp.

Carolinae is almost exactly similar in size and general form to the Californian *falliana*, but differs in the deeper and more uniform blackish coloration and in having the basal angles of the head very much more broadly rounded. *Tenuissima* is decidedly more slender, with the basal angles of the head also more broadly rounded than in *falliana*, but rather less so and with a narrower neck than in *carolinae*.

SUBFAMILY STAPHYLININAE.

Tribe XANTHOLININI.

The chief peculiarities of this Staphylinid tribe reside in the formation of the antennae and front, the relatively approximate insertion of the former and in the singular modification of the elytral suture characterizing most of the genera. The antennae are strongly geniculate at the tip of the more or less elongate basal joint, the latter, as well as the two or three following joints, being subglabrous and sparsely setulose, while those which follow to the tip are usually compactly joined, transverse to a greater or less degree, minutely and densely pubescent and finely, closely sculptured, in addition, to the sparse erect tactile setae; they are never very widely separated at the extreme frontal apex and the apical margin between them is more or less closely and deeply bisinuate, the intermediate narrow lobe or epistoma being generally

truncate and bearing at tip the small transverse, usually finely emarginate or deeply, narrowly cleft labrum. In the *Metoponci* the epistoma is singularly prominent dorsally and canaliculate, and, in the *Diochi*, the labrum is entire and even finely denticulate at the middle. The mandibles are moderate in size, dentate within and variously modified on the exterior surface, which is either entire as in *Eulissus*, grooved as in the majority of the *Xantholini* or with a sinuous stria as in *Metoponcus*, with rounded external edge, as a rule, or with an acute edge as in *Diochus*. The maxillary palpi vary greatly, having the third joint long or short and the fourth correspondingly short or elongate, finely aciculate and very slender to conical and gradually pointed; they are always coarsely setulose and glabrous, except in *Diochus*, where they become finely and closely pubescent as well as setulose. The labial palpi are usually simple, with slender third joint, but in the neotropical *Araeocnemis* have the third joint, singularly enlarged. The mentum is usually transverse, becoming especially modified only in the very remarkable genus *Platyprosopus*.

The elytral suture is abnormal in the *Xantholini*, and, to a much less marked degree, in the *Araeocnemis* and *Metoponci*, the inner edge of each elytron being widely and gradually beveled, so that in closing, one slips upon the other to a slight extent, leaving the summits of the beveled edges as two separate broadly arcuate lines, a formation which enables one to identify a *Xantholinid* at a glance, even without noticing the aberrant antennae. A number of subtribes have the elytral suture normal, however, such as the *Othii*, *Diochi* and those which follow in the table below. The neck is usually rather thick, and, although sometimes narrow, never becomes so extremely slender as in *Stilicus* and some other genera of the *Paederini* for example. The anterior and middle coxae are remarkably large and prominent as a rule, but the posterior have the exposed inner parts small and contiguous as usual. In many forms, such as the *Hyptiomae*, the middle coxae become flat on their exposed surface when in repose; they frequently extend from the median line to the sides of the

body. The prosternum is short and not much produced in the middle under the coxae; its anterior margin is broadly and distinctly sinuate, except in *Platyprosopus* and *Hyptioma*, where it becomes truncate. The membrane thus exposed in the sinuation is partially covered by a complex arrangement of extruded corneous plates, the central large and broadly arcuate at tip, the lateral small and more extensile. These plates are undoubtedly connected in some way with the unusual flexibility of the head; they appear to be wanting in the Paederini, where the exposed piece, when present at all, is much shorter and membranous or coriaceous in texture. The tarsi are remarkably uniform in structure and present nothing unusual; the anterior are undilated as a rule but become strongly dilated and densely pubescent beneath in certain genera, notably *Platyprosopus*, where they are also eccentric as in *Pinophilus*, in *Leptolinus* and *Notolinus* and one or two others of the Xantholini, in *Diachus* and the Othii.

The sexual characters at the ventral apex are singularly inconspicuous when we compare the tribe with many others, such as the Paederini, and the most notable sexual characters generally apply to the female and not the male. In the male of *Nematolinus* and *Hesperolinus*, for example, the sixth ventral is broadly rounded at tip, but in the female is either acutely angulate or produced in a slender spine, which, in *parvus* and one or two other species, extends well behind the extreme tip of the abdomen. The female characters of *Lep-tacinus* are also peculiar as noted below. In the Othii, however, the male frequently has the sixth segment more or less evidently sinuate at tip, and it is an invariable rule that the apex of the sixth ventral is less arcuate or less produced in the male than in the female, even when the actual difference of curvature is very slight, as in *Nudobius* and *Xantholinus*.

It is convenient to divide the tribe, as represented by the material that happens to be in my cabinet, into seven subtribal groups distinguished by the following characters:—

Prosternum emarginate anteriorly, the emargination partially filled by an
apparently extrusive rounded corneous plate..... 2
Prosternum transversely truncate anteriorly, without extrusive corneous

- plate; elytral suture fine, straight and normal; middle coxae contiguous; antennae less approximate on the front than in the Xantholini, nearly as in Othii and Diochi..... 8
- 2 — Antennae finely and densely pubescent from the fourth joint, not notably compressed..... 3
- Antennae subglabrous, strongly compressed, approximate as in Xantholini 7
- 3 — Maxillary palpi glabrous, excepting a few sparse tactile bristles..... 4
- Maxillary palpi minutely pubescent; antennae less approximate..... 6
- 4 — Labial palpi normal, the last joint more or less slender 5
- Labial palpi with the last joint large and securiform; antennae approximate; neck slender; middle coxae very remotely separated, much smaller than usual; inner edge of the elytra usually less broadly beveled than in the Xantholini. Neotropical regions.....***Araeocnemes**
- 5 — Antennae approximate on the frontal margin, the latter more or less feebly but abruptly advanced between them in the middle, forming a distinct epistoma; elytral suture always broadly beveled and abnormal; middle coxae distinctly separated as a rule.....**Xantholini**
- Antennae more widely separated, the frontal margin nearly truncate between them; elytral suture normal; middle coxae contiguous....**Othii**
- 6 — Elytral suture normal; middle coxae contiguous; head much less developed than in any other subtribe, the antennae relatively distant at base**Diochi**
- 7 — Antennae very approximate as in the Xantholini, the narrow epistoma between them much more produced, dorsally elevated and bilobed; elytral suture but slightly beveled, almost normal, the middle coxae contiguous.....***Metoponci**
- 8 — Mentum normal, short and transverse; antennae as usual; body depressed, small in size.....***Hyptiomae**
- Mentum with its coriaceous continuation triangular; antennae somewhat abnormal, the joints elongate and compressed; body moderately convex, very large in size.....***Platyprospici**

The subtribes foreign to America, as indicated by the asterisks, may be remarked upon as follows: —

Araeocnemes. — A few genera, composed of large and showy neotropical species, alone constitute this tribe. The principal genus has long been known under the name *Sterculia* Lap., but, as an important genus of plants has been designated for a still longer time by the same name, it seems advisable to change the zoological name, especially as we can do so without coining a new word, the *Araeocnemis*, of Nordmann, being synonymical with *Sterculia*.*

* It would be ambiguous, for instance, if not altogether absurd, to speak of a *Sterculia lauta* being found under dead leaves in the shade of a *Sterculia americana*. Another example of the same kind is the well known Pselaphid genus *Reichenbachia*, and I would propose that this be changed to **Reichenbachius** to distinguish it from the *Reichenbachia* of the botanists.

The characters of the table have been drawn from a species of *Araeocnemis* of moderate size, which may be described as follows: —

Rather stout, with slender, elongate prothorax, brilliant blue-green in color with purplish reflection on the elytra and pronotum, which are polished and with rather coarse, sparse, impressed and evenly but irregularly distributed punctures, each of which bears a conspicuous stiff black hair; head oblong-elongate, relatively rather small though wider than the prothorax, parallel, with rounded basal angles, the upper surface throughout with coarse and very dense, longitudinally anastomosing punctures, the sides subinferiorly behind the eyes with a broad parallel-sided longitudinal line, which is acutely limited above and below, broadly, feebly concave and in great part impunctate, the punctures of the under surface coarse and conspicuous posteriorly but almost wanting anteriorly; antennae with the first three joints subglabrous, the next two coarsely punctate and setulose, the last six, and especially the last four, very minutely, densely pubescent, the penultimate slightly transverse and a little longer than the preceding joint; mandibles arcuate and convex externally, becoming narrowly grooved toward base only; they are broadly decussate in repose and much shorter than the head; prothorax narrow, anteriorly pointed from near the middle and impressed at each side toward base; elytra large, quadrate, nearly twice as wide as the prothorax, with the inner edge only very narrowly beveled, the line marking the summit of the bevel being, on each elytron, strongly elevated and cariniform. Length 18.0 mm.; width 4.5 mm. Panama.....*laufa* n. sp.

This species cannot be identified with any of those described in the *Biologia* under the name *Sterculia*, and *Agrodes* Nord., and *Plochionocerus* Shp., are very different in facies though apparently belonging to the same subtribe.

Metoponci. — The genus *Metoponcus*, of Kraatz, is one of the most isolated of the tribe and is undoubtedly of full subtribal importance; I know of no associates for it at present. The genus appears to be peculiar to the more southern of the palaeartic faunal provinces, whence I have examples from Greece and Lenkoran. The body in *Metoponcus* is moderately slender, parallel and convex, nearly as in the genus *Gyrohypnus* of the Xantholini, but the head is remarkably elongate, parallel and rectilinear at the sides, the flanks behind the eyes not having two obtuse lines with a flattened area between them, as is generally the case in that tribe, but, on the under surface parallel and close to the sides, there is a re-

markable deep groove, with which perhaps the lateral line of *Leptacinus* is homologous, and outside of which the lateral line of the head is acute and prominent inferiorly; above this line the surface is evenly convex through the flanks to the dorsal surface and without further irregularity. The gular sutures are single from the small triangle behind the mentum to the base, the neck scarcely a third as wide as the head, the third palpal joint elongate, obconical, the fourth small, slender and oblique and the mandibles are rather small, arcuate, each strongly unidentate within, convex externally, with a fine impressed longitudinal groove. The antennae are shorter than the head, broadly flattened, glabrous but with herissate setae and are wholly unique in the tribe. The prothorax and prosternum are nearly as in *Gyrohypnus*, but the bevel of the inner edges of the elytra is convex, rather narrow and not marked by a carina or elevated beading at its upper part. The tarsi are remarkably long and slender, with the basal joint much shorter than the second; the middle tarsi are notably longer than the tibiae.

A considerable number of neotropical species have been placed in *Metoponcus*, chiefly by Dr. Sharp, but they probably constitute several distinct genera, no one of which is exactly congeneric with the European *Metoponcus*, although *longiceps* Shp., may possibly form a genus of the subtribe Metoponci as here considered, on account of the peculiar form of the interantennal epistoma. The remarkable antennal structure of *Metoponcus*, which constitutes one of the most distinctive features of the present subtribe, has been unaccountably overlooked in describing these neotropical forms, some of which may enter *Oligolinus*, defined below to receive the *Metoponcus floridanus*, of LeConte, the antennae of which are certainly not Metoponcid.

Ægyptiomae. — This subtribe is founded upon a single very small slender and strongly depressed parallel species, occurring in the Island of Cuba, which may be described as follows: —

Strongly depressed, parallel, pale testaceous in color, the legs and antennae also pale, the head blackish, moderately shining. Head sub-

quadrate, behind the antennae somewhat wider than long, the sides parallel and nearly straight, the angles right, narrowly rounded; base transversely truncate; neck not quite half as wide as the head; antennae separated at base by fully two-fifths of the maximum width, rather slender, only slightly longer than the head, the basal joint scarcely longer than the next two combined, the second barely as long but rather thicker than the third, the latter more strongly narrowed at base and much shorter than the next two combined; epistoma very short, truncate; labrum transverse, bilobed, the lobes evenly rounded, the notch evenly and deeply sinuate; mandibles small, not grooved externally but with an acute subinferior external edge; maxillary palpi moderate, glabrous, sparsely setose, the third joint somewhat notably elongate, the fourth very small, aciculate and extremely oblique; mentum small, transverse; gular sutures very fine, straight and rapidly converging posteriorly to apical third, thence single to the base; flanks of the head evenly and strongly convex, unmodified; eyes well developed; punctures rather strongly impressed and distinct, somewhat sparse throughout, with a narrow impunctate dorsal line which seems to bifurcate anteriorly; frontal grooves wanting. Prothorax short, obtrapezoidal, scarcely as long as wide, obviously shorter and narrower than the head, the sides feebly arcuate, the angles obtuse but rather distinct; surface rather finely but deeply, closely and confusedly punctate, with a wide impunctate median line, which is well defined by close-set series and notably narrower toward base; side margin finely acute, extending to the apex though gradually deflexed anteriorly before the middle; below this a second fine carinal line, nearly parallel to and more abbreviated than the lower edge; prosternum well developed before the coxae, the latter somewhat narrower than usual, the posterior acute angulation approaching the mesosternum much closer than in any other genus, the emargination of the mesosternum very small, rounded, the anterior coxal cavities partially closed externally and posteriorly by a corneous piece not visible elsewhere in the tribe. Elytra longer than wide, one-half longer and nearly a third wider than the prothorax, minutely but deeply, very closely, evenly but irregularly punctured throughout, rather dull; suture very fine, simple. Abdomen slender, parallel, distinctly narrower than the elytra and similarly, though still more finely and less closely punctulate, more shining. Middle coxae more rounded and less elongate than usual, contiguous, extending to the sides of the body, flat inferiorly, with a large discal concavity in each. Legs short, the tarsi very short, stout and extremely compact, tapering from base to apex, the anterior not dilated. Male not known, the sixth ventral of the female evenly and subparabolically rounded from the sides near the base around the apex. Length 4.0 mm.; width 0.55 mm. Cuba (Havana), — C. F. Baker.

Hyptioma (n. gen.) *cubensis* n. sp.

There can be but little doubt that this very singular Xantholinid lives under bark, though I have no notes as to its habits from Mr. Baker. Its structural characters, and par-

ticularly its entire facies, indicate subtribal isolation at least.

Platyprosopi. — The very remarkable genus *Platyprosopus*, of the southern parts of the palaeartic province, is the only representative of this subtribe at present known. Its species are of large size, parallel and convex form, with the neck extremely wide and only feebly delimited from the head by shallow lateral impression of the occiput. The head behind the antennae is shorter than wide, rounded at the sides, which are not longitudinally modified behind the eyes; the latter are well developed in point of size and rather convex, but apparently unique, perhaps in the entire Staphylinidae, in having the facets wholly obsolete except in very limited number around the anterior part, the rest of the surface being densely opaque, evenly convex and with fine scattered punctules like those of the other parts of the cephalic surface. The antennae are more slender, elongate, loose and filiform than usual in the Xantholinini and have the outer joints elongate, obconical and compressed, the basal joint about as long as the next two combined. The labrum is short, transversely truncate, apparently with a feebly projecting median lobe, the mandibles large, arcuate, convex externally, with an acute edge toward base, the palpi short and thick, the three outer joints of the maxillary subequal in length, the last cylindrical, obtuse at tip; gular sutures short, converging posteriorly but still narrowly separated where they attain a median tumorescence at the base of the head. The prothorax is wider than long, rather wider than the head, wider apically than basally, the sides evenly arcuate, the basal angles broadly rounded, the apical not rounded, the surface not strigilate but having very minute and irregularly scattered nude punctules throughout, the lateral edges more strongly beaded than in any other genus; hypomera rapidly descending; middle coxae contiguous, large, extending to the sides of the body. The legs are long and rather thick, the tarsi elongate, with the basal joint of the posterior longer than the next two combined, the anterior strongly dilated and twisted. The elytra have the suture fine and normal, without contiguous beading, and, at

base, each is hollowed into a concave helicoidal polished surface, permitting of the easy motion of the broad prothorax upon them; externally this helicoidal surface is vertically and prominently carinate, this also being a unique feature. The punctuation of the elytra and abdomen is minute and very close-set, the pubescence short but conspicuous.

The species serving for this diagnosis is one sent me recently from Egypt by Mr. Reitter, under the name *beduinus* Nord. In spite of its conspicuous eyes it is probably virtually blind. It is evident, on considering the strongly and eccentrically dilated anterior tarsi and general facies, that *Platyprosopus* is a very aberrant member of the present tribe, forming one of its bonds with *Pinophilus*.

Subtribe Xantholini.

This subtribe of almost mundane distribution embraces by far the greater part of the tribe. From such evidence as is available its numerous genera appear to be clearly delimited and in no way opinionative, which suggests a comparatively great antiquity for the subtribe as a whole. It possesses this character in common with the Paederini and Pinophilini, in contrast with the Stenini and some other groups, which seem to be in a more decidedly mutative state at the present time. One of the most striking features of the subtribe under consideration and one by which its genera can always be recognized at a glance, is the very remarkable and almost unique form of the elytral suture, the double beveling giving the effect of gemination as explained in the table of subtribes. This character is found elsewhere only in the Araeocnemes and Metoponci, but to a much less developed degree. The middle coxae are more or less widely separated as a rule, sometimes very remotely so as in *Leptolinus*, but in *Idiolinus* they become contiguous, so that the contiguity of the coxae, which prompted LeConte to place the minute *floridanus* in *Metoponcus*, is therefore not necessarily a bar to its reception within the subtribe Xantholini. Those genera having a smooth pronotum, devoid of the medial dorsal series charac-

terizing the majority, seem to be characteristic of the warmer parts of North and South America, and it is therefore rather surprising to find the European fauna possessed of a genus of this particular group, composed of several species wholly foreign to the new world, excepting one — the *Eulissus fulgidus*, of Fabricius, — which has been artificially introduced. The following twenty-four genera are differentiated and characterized principally by structure of the maxillary palpi, form of the side margin of the prothorax and of the gular sutures, structure of the basal part of the antennal funicle, degree of separation of the middle coxae and form of the anterior tarsi, the hind tarsi varying but slightly throughout. They may be briefly outlined as follows: —

- Fourth joint of the maxillary palpi long, never very much shorter than the third; anterior tarsi always slender, subglabrous beneath.....2
- Fourth joint small, much shorter than the third, and, at base, conspicuously narrower, conical and acuminate or aciculate and usually more oblique.....19
- 2— Fourth joint stouter at base and less conspicuously narrower than the third.....3
- Fourth joint more slender, its base much narrower than the tip of the third joint; side margin of the prothorax as in *Xantholinus*.....16
- 3— Pronotum without dorsal punctures; middle coxae always distinctly separated; gular sutures united..... 4
- Pronotum with dorsal punctures which are always sparse and for the most part arranged in a few series.....10
- 4 — Second antennal joint much shorter than the third; side margin of the prothorax deflexed anteriorly from the middle or posterior thereto; species usually large in size.....5
- Second and third antennal joints equal, each slightly elongate but not as long as the next two combined, nearly as in *Xantholinus*, the thoracic side margin only feebly deflexed toward tip as in that genus.....9
- 5 — Neck nearly half as wide as the head.....6
- Neck narrow, about a fourth as wide as the head.....8
- 6 — Antennae very small, with the basal joint relatively much elongated and fully two-thirds as long as the remainder; middle coxae rather small, narrow, very widely separated; body large, subimpunctate, generally metallic blue or green in color, the elytra with very few punctures, the abdomen distinctly though sparsely punctured; epistoma subcoriaceous and testaceous in color, separated from the front by a feeble transversely arcuate depression; labrum small, deeply sinuate at the middle; mandibles not impressed externally; maxillary palpi moderate, the fourth joint scarcely longer than the third, obliquely and obtusely acuminate only toward apex; under surface of the head flattened, the lateral margins but feebly prominent beneath, the sides

convex, not impressed, the basal angles rounded; median frontal grooves represented by feeble punctiform impressions at some distance behind the epistoma, the lateral oblique or ocular grooves short but more distinct; prosternum very short before the coxae; thoracic side margin gradually and evenly deflexed anteriorly from behind the middle, remaining rather distant from the lower margin even at apex; hind tarsi short and rather slender, with the first four joints regularly decreasing in length. Neotropical regions.....***Dinolinus**

Antennae normal, as long as the head or longer, the basal joint much less than half as long as the remainder; middle coxae larger and less remotely separated; body much smaller in size and of more slender form, the side margin of the prothorax strongly deflexed anteriorly from behind the middle, becoming very narrowly separated from the lower margin toward apex; fourth joint of the maxillary palpi spindle-form, distinctly longer than the third, obtusely narrowed only toward tip; mandibles unimpressed externally..... 7

7 — Epistoma rather large, parallel-sided, with its apex truncate and its upper surface impressed; middle pair of frontal grooves short, double; punctures of the head moderately coarse, normal, not forming grooves, the sides evenly convex from the upper to the lower surface, the basal angles evenly rounded; elytra not punctured in definite series. Mexico.

***Saurohypnus**

Epistoma small, gradually enlarged from base to the truncate apex, the two duplex grooves of the front long and conspicuous, the oblique ocular grooves short but deep; punctures of the head extremely coarse and deep, subcoalescing into longitudinal grooves toward and on the flanks, the latter otherwise evenly convex from the upper to the under surface, the basal angles, however, not evenly rounded but obtusely subprominent; elytra each with a distinct medial series of punctures. Europe, — also occurring in America by accidental introduction.

Eulissus

8 — Body much more depressed, polished, subimpunctate, the head truncate at base with the angles not rounded, though scarcely at all prominent, the mandibles not grooved externally, the epistoma very short, broadly truncate at tip, the median pair of frontal grooves long, deep, strongly converging posteriorly, the median line thence deeply grooved almost to the base, the short subsidiary grooves outside of the median pair at apex fine and diverging as in the two preceding genera; ocular grooves very coarse, deep, longitudinal, extending almost half way to the base, impressed; sides of the head obliquely flattened and with fine punctuation, the under surface flat, with coarse impressed lateral grooves which are bounded externally by a tumid line; last joint of the maxillary palpi scarcely as long as the third, spindle-form, rather narrower than usual, parallel, becoming obtusely acuminate only toward tip; elytra not distinctly punctured; side margins of the prothorax rather abruptly deflexed anteriorly from somewhat before the middle, coming very close to the lower margin at apex. Central America.

***Homalolinus**

9 — Body rather stout, parallel and convex, much smaller in size, the head broadly, feebly arcuate at base with the angles narrowly rounded, im-

punctate, the sides somewhat flattened, with a large setigerous fovea posteriorly just before the basal angles, the flattened part bounded beneath by a feebly prominent longitudinal ridge; epistoma small, short, truncate; inner frontal grooves long but fine, parallel, the oblique ocular grooves coarse, deep and well developed; mandibles not grooved externally; fourth palpal joint much longer than the third, rather strongly acuminate in apical half; elytra subserially and distinctly punctured. Central America.....***Xanthohypnus**

10 — Side margin of the prothorax rapidly deflexed anteriorly from near the middle and united with the lower margin somewhat before the middle; sides of the head not modified behind the eyes, the basal angles rounded; gular sutures united; maxillary palpi with the fourth joint about equal in length to the third, rather obtusely acuminate toward tip; mandibles narrowly and deeply grooved externally; antennae with the second and third joints equal or subequal, each but slightly elongate and somewhat rounded; median pair of frontal grooves long and strong, feebly converging, the oblique ocular grooves short and feeble; punctures normal; neck two-fifths as wide as the head; middle coxæ well separated; basal joint of the hind tarsi shorter than the second; body rather large in size. Europe and North America.....**Nudobius**

Side margin of the prothorax gradually and only feebly deflexed anteriorly, remaining distant from the lower margin to the apex; basal angles of the head rounded as a rule; mandibles grooved externally.....11

11 — Middle coxæ distinctly separated as usual; neck two-fifths as wide as the head.....12

Middle coxæ contiguous; neck very slightly narrower; third antennal joint abnormal.....15

12 — Second and third antennal joints equal in length or nearly so, each rather distinctly elongate but shorter than the fourth and fifth combined.....13

Second antennal joint slightly elongated, much shorter than the third, the latter evenly obconical and about equal in length to the next two combined.....14

13 — Maxillary palpi of the usual form, elongate, the fourth joint spindle-form, acuminate only toward tip, as long as the third joint or nearly so; gular sutures united; epistoma minute, truncate at tip; median frontal grooves strong, slightly converging, the ocular feeble; punctures coarse, normal; basal joint of the hind tarsi as long as the second or nearly so; species rather large. Europe and Pacific coast of America..**Xantholinus**

Maxillary palpi normally slender but with the third joint shorter than in *Xantholinus*, the fourth very much longer than the third and acutely conical; second and third antennal joints relatively smaller, the former frequently slightly the larger of the two and more rounded than in *Xantholinus*; epistoma very small, truncate; median frontal grooves moderate, parallel, the oblique ocular rather distinct; punctures normal but less coarse than in *Xantholinus*; gular sutures arcuately converging, becoming extremely approximate only behind the middle; first four joints of the hind tarsi decreasing very gradually in length; body generally smaller and more slender than in *Xantholinus*. Palaearctic and Nearctic regions.....**Gyrophypnus**

- Maxillary palpi shorter and stouter, compressed, the very short, obtusely conical fourth joint evidently shorter than the third; antennae nearly as in *Xantholinus*, the epistoma shorter but much broader, truncate; median frontal grooves strong, parallel, the ocular subobsolete; gular sutures arcuately converging, fine, becoming very approximate behind the middle; head rounded at base; punctures extremely fine and sparse throughout, the integuments highly polished; hind tarsi with the two basal joints equal. North America (Sonoran regions).... **Xestolinus**
- 14—Body moderately large, the head well developed, nearly as in *Xantholinus* and larger than in *Gyrohypnus*, the gular sutures united from well before the middle to the base; epistoma small, truncate; maxillary palpi with the third joint shorter than in *Xantholinus*, the fourth much longer, stouter than in *Gyrohypnus* and acuminate only in apical half; median frontal grooves well developed, parallel, the ocular grooves obsolete and represented by feeble depressions near the eyes; punctures normal, rather coarse; hind tarsi with the first two joints equal. Subtropical Atlantic North America..... **Lissohypnus**
- 15 — Body moderately stout and rather smaller, the elytra less developed than usual, the head broadly rounded basally, the eyes rather small; antennae unusually stout, the third joint as long as the next two combined, constricted toward base and strongly dilated apically, pedunculate and much longer than the second; maxillary palpi with the third and fourth joints elongate, the latter unusually slender for the present group and gradually narrowed to the obtuse apex almost throughout, somewhat shorter than the third; gular sutures fine, arcuately converging, becoming very approximate toward base; median frontal and oblique ocular grooves fine, subequal in length and visibility; punctures fine and sparse, the integuments polished; hind tarsi more slender and elongate than usual, the first joint scarcely as long as the second. Europe..... ***Idiolinus**
- 16 — Pronotal punctures as in the preceding genera, very sparse and disposed in a few more or less irregular series..... 17
Pronotal punctures confused in arrangement and usually much more numerous..... 18
- 17 — Frontal grooves very long, deep and conspicuous, the oblique ocular grooves as long and conspicuous as the median; fourth palpal joint subcylindric, very slender, usually quite distinctly shorter than the third and only moderately oblique in insertion; mandibles grooved externally as usual; gular sutures uniting just behind the middle and thence coarse and single to the base; under surface of the head longitudinally impressed near the sides, the impression bounded externally by an obtusely rounded ridge; second antennal joint longer and thicker than the third, the outer joints only moderately thick as in *Xantholinus*; tarsi obviously thickened toward base; punctures of the head and pronotum very few in number but remarkably coarse. Palearctic and Nearctic regions..... **Leptacinus**
- Frontal grooves shorter and finer, the oblique ocular shorter and much fainter than the median; antennae similar; fourth palpal joint equally slender but more conical, slightly shorter to somewhat longer than the third and strongly oblique in insertion; gular sutures finer, arcuate,

becoming very approximate but generally not quite united at base; under surface without a longitudinal impression at the sides, the latter obtusely subprominent inferiorly due simply to the flattening of the general under surface; tarsi more slender and filiform; punctures of the head and pronotum much less coarse, the latter more numerous in the series. Palaearctic and Nearctic regions.....**Leptacnodes**

- 18 — Antennae nearly as in *Leptacinus*, the second joint visibly longer but scarcely thicker than the third, both slightly elongate; fourth palpal joint long, slender, somewhat longer than the third as a rule but conical and gradually, acutely pointed; gular sutures fine, arcuate, uniting near the base; sides of the head not modified; frontal grooves rather short, moderately distinct, subparallel, the ocular grooves wholly obsolete; punctures only moderately coarse but very numerous on the head and pronotum; species rather small, similar in size and form to *Leptacnodes* and rather smaller as a rule than in *Leptacinus*. Nearctic regions.....**Stictolinus**

Antennae well developed, the second joint much elongated, nearly equaling the next three combined, the third about equally slender, slightly elongate, the outer joints stouter than in *Leptacinus* and more compactly joined; fourth palpal joint very slender, aciculate and oblique, as long as the preceding or nearly so; gular sutures very fine, arcuate, most approximate at base, where they are still distinctly separated; sides of the head broadly convex, unmodified, the basal angles broadly rounded; neck slightly more than a third as wide as the head, nearly as in *Stictolinus*; median pair of frontal grooves short and almost completely obsolete, the ocular grooves very oblique, deep and conspicuous, departing from the general rule; punctures of the head and pronotum fine and rather sparse, very inconspicuous; body very small, slender, convex and parallel, the abdomen convex and more strongly sculptured than usual; legs slender, the tarsi filiform. Pacific coast of America

Habrolinus

- 19 — Anterior tarsi slender and undilated, glabrous beneath or with a few sparse bristles; side margin of the prothorax and hypomera as in *Xantholinus*.....**20**

Anterior tarsi broadly dilated, especially in the male, densely clothed beneath with white papillose pubescence; side margins of the prothorax distinct throughout, these and the hypomera as in *Gyrohypnus* and related genera; pronotum with dorsal series, the surface thence anterolaterally with irregularly scattered and very sparse punctures; middle coxae more or less narrowly separated; body polished, with distinct sparse punctures, the head above and beneath and pronotum minutely strigilate in transverse wavy lines or with some modification of this sculpture; gular sutures feebly arcuate, becoming confluent at or slightly behind the middle; sides of the head scarcely at all modified, almost evenly convex, the punctures generally sparser along the middle of the convexity; antennae moderate, only slightly thickened distally, the third joint generally a little longer than the second; neck about two-fifths as wide as the head; tibiae spinulose as usual.....**25**

Anterior tarsi broadly dilated in both sexes and clothed densely beneath

- with spongy pubescence; lateral bead of the prothorax only visible toward base, wholly obliterated anteriorly.....26
- 20—Prosternum shorter and less developed before the coxae, its posterior margin broadly angulate as usual, the angulation cuspidiform; head never more than feebly modified at the sides, the basal angles rounded.....21
- Prosternum larger before the coxae, arcuato-truncate behind under the latter, its surface evenly and feebly convex throughout and wholly devoid of carina at any part, the hypomera not inwardly dilated anteriorly; head with an obtusely rounded, polished and impunctate longitudinal line from the eyes posteriorly as in *Hesperolinus*.....24
- 21—Prosternum not carinate, somewhat narrowed anteriorly by the inwardly dilated hypomera; basal joint of the hind tarsi longer than the second; antennae stouter than usual and more compact toward tip, with the basal joint relatively much longer, the punctuation fine.....22
- Prosternum carinate along the middle, not narrowed anteriorly by an inward development of the hypomera; basal joint of the hind tarsi about equal in length to the second; antennae never more than moderately stout.....23
- 22—Anterior angles of the prothorax obsolete nearly as in *Habrolinus*, broadly rounded, the sides subparallel; body smaller and extremely slender; antennae somewhat as in *Habrolinus*, the second joint slender and unusually elongate, longer than the next two combined, the third obtrapezoidal and slightly longer than wide, the outer joints very compact and much thickened, the tenth two and one-half times as wide as long; palpi nearly as in *Lithocharodes*, the very oblique fourth joint extremely slender, aciculate and two-thirds as long as the third; inner pair of frontal grooves short, broadly and feebly impressed, parallel and very indistinct, the ocular obsolete and represented by a small rounded punctiform depression at the inner margin of the eyes; gular sutures very fine, feebly, evenly arcuate, gradually and feebly converging throughout to the base, where they are most approximate but still distinctly separated; legs slender. Nearctic Atlantic regions.

Nematolinus

- Anterior angles of the prothorax rather distinct, the sides converging thence to the base; second antennal joint but little longer than the third, both distinctly elongated, the third equaling the fourth and fifth combined; third palpal joint only moderately elongate, the fourth small, slender, acutely conical, oblique and rather more than half as long as the third; gular sutures fine, approaching each other to the middle or before the latter, and thence parallel and extremely approximate to the base; eyes moderate; median pair of frontal grooves fine, rather short and parallel, the oblique ocular subobsolete; neck but little more than a fourth as wide as the head; body only moderately slender. Tropical and Subtropical Atlantic North and South America.....**Lithocharodes**
- 23—Body larger as a rule than in the two preceding genera, the head well developed, the third joint of the maxillary palpi elongate, enlarged distally, the fourth small, generally about one-half as long as the third, slender, conical and oblique; gular sutures arcuate, becoming extremely approximate from rather before the middle to the base; sculp-

ture stronger than in *Leiolinus*; antennae moderately thick, the outer joints moderately transverse and somewhat compactly joined, the second and third more or less distinctly elongate and equal or nearly so, each notably narrower and longer than the fourth; median frontal grooves short, feeble, subparallel and not very conspicuous, the oblique ocular grooves subobsolete or very feeble. Nearctic Pacific coast.

Hesperolinus

24 — Body still larger than in *Hesperolinus*; hind tarsi with the first two joints equal in length; punctuation of the head and pronotum very fine and somewhat sparse, the former with the basal angles broadly rounded; eyes small; frontal grooves short but broadly impressed and distinct, arcuately converging, the oblique ocular grooves shorter, straight and rather distinctly impressed; antennae longer than usual and loose, but little enlarged apically, the second and third joints equal, more or less elongate and generally narrower though perceptibly longer than the fourth; third palpal joint much elongated, the fourth very short, only slightly oblique, rather slender but obtusely subconical; gular sutures very fine, arcuate, becoming extremely approximate but not united from before the middle; tarsi very slender, filiform. Sonoran regions of America..... **Leiolinus**

25 — Frontal grooves long and deeply impressed; fourth joint of the maxillary palpi slender, aciculate, about three-fourths as long as the third; labrum deeply emarginate; dorsal series of the pronotum always regular and composed of about six punctures; hind tarsi with the first four joints subequal, each but little longer than wide, the fifth about as long as the three preceding combined. South Africa..... ***Notolinus**

Frontal grooves always very feeble and usually much shorter; fourth joint of the maxillary palpi shorter, strongly conical, generally but little more than half as long as the third; labrum less emarginate; dorsal series of the pronotum irregular and composed of a greater number of punctures; hind tarsi slightly more elongate, the first two or three joints much longer than wide and decreasing uniformly in length. South Africa..... ***Notolinopsis**

26 — Body moderately convex and slender, parallel, not very coarsely but densely punctured, the punctures of the elytra arranged without order; head oblong, rather depressed, not modified at the sides, the basal angles rounded; median frontal grooves obsolete, represented by feeble cariniform converging lines, the ocular grooves wholly obsolete; eyes small; antennae well developed, the basal joint distinctly more than half as long as the remainder, the outer joints only moderately thickened, the second and third equal in length, much elongated, each somewhat longer than the fourth and fifth combined; maxillary palpi unusually elongate, the fourth joint small, oblique, slender and aciculate; gular sutures uniting at a short distance behind the oral cavity and thence continuing as a very fine single line to the base; neck unusually slender, about a fifth as wide as the head; prosternum long and well developed before the coxae, the surface almost evenly and feebly convex, the hind margin cusped at the middle as usual; hind tarsi moderately slender, the basal joint slightly longer than the second; middle

coxae more widely separated than usual. Palaearctic and Nearctic Atlantic regions.....**Leptolinus**

The two following genera are attached provisionally to the Xantholini. They are founded upon the original and wholly inadequate descriptions of Le Conte and consequently may be greatly out of place. My only excuse for publishing them at this time is because their type species cannot be assigned satisfactorily to any of the other genera thus far proposed: —

Body very minute, the palpi, antennae and front tarsi as in *Leptolinus*; head rather convex, the base truncate with the angles narrowly rounded; punctures of the head and pronotum small in size, sparsely scattered; middle coxae not examined. Nearctic Atlantic regions. [= *Leptolinus* Lec. nec Kr.].....**Microlinus**

Body minute, subcylindric; head convex, narrowed in front, the base truncate, the surface distinctly but not densely punctate toward the sides; antennae somewhat longer than the head, with the outer joints gradually much thickened; maxillary palpi with the fourth joint very small, acicular; middle coxae contiguous; front tarsi not dilated; prothorax distinctly though not densely punctured, with a broad smooth dorsal line; sutural "stria" of the elytra obsolete. Florida. [= *Metoponcus* Lec. nec Kr.].....**Oligolinus**

It will be noted that the genera of the above table from *Dinolinus* to *Xanthohypnus*, have the pronotum smooth and wholly devoid of the dorsal series of punctures, that those from *Nudobius* to *Leptacinodes* have some sparse dorsal punctures arranged for the greater part in a few more or less irregular series, and those from *Stictolinus* to *Leptolinus* have the pronotal punctures confused throughout the surface, except along a rather wide smooth median line and more close-set as a rule, except in the South African *Notolinus* and *Notolinopsis*. The significance of this pronotal sculpture is shown in many ways, as for example in the mandibles, those genera without dorsal punctures having the mandibles convex and unmodified externally, while those with dorsal punctuation, embracing all the other genera of the table, have them deeply grooved. The importance of this mandibular character, which is thus correlated with the absence of dorsal punctuation, will be recognized at once. The foreign genera indicated by asterisks in the table may be referred to as follows: —

DINOLINUS n. gen. — This genus is founded upon the large and brilliant blue-green polished species described by Erichson under the name *Xantholinus chalybeus*. The Mexican examples before me do not depart enough from Erichson's description of the Brazilian type to warrant separation without actual comparison, although there are probably divergencies of at least a varietal nature in a species of such wide distribution. The genus *Dinolinus* will apparently include also the *Xantholinus rutilus* of Perty.

SAUROHYPNUS Shp. — Although closely allied to *Eulissus*, differing principally in the formation of the labrum and epistoma, rather more widely separated antennae and system of cephalic and elytral sculpture, it seems apparent that these distinctive characters constitute a necessity for generic separation. *Saurohypnus* is apparently confined to the elevated regions of northern and central Mexico and is composed of moderately large, slender and convex species. It is greatly out of place in the systematic arrangement adopted in the *Biologia*. The only species actually known to me in nature may be described as follows: —

Parallel, rather strongly convex, polished, black, the palpi, entire elytra, apical half of the fifth and entire sixth ventrals, rufous, the legs and antennae piceous-black with the tarsi pale; head large, oblong, behind the antennae but little longer than wide, parallel and nearly straight at the sides, the basal angles broadly rounded; punctures rather coarse and close-set throughout the upper surface, without an impunctate median line and having a very large puncture above each eye; sides wholly unmodified and evenly convex; under surface rather coarsely, moderately closely punctate throughout, the punctures — like those of the upper surface — mingled with smaller punctures and somewhat elongate in form; antennae but little longer than the head, the penultimate joint one-half wider than long; mandibles moderately thick, arcuate, convex and wholly devoid of groove externally; prothorax two-fifths longer than wide, four-fifths as wide as the head, the apical angles scarcely at all rounded, the sides distinctly converging posteriorly throughout, feebly sinuate behind the middle; disk having numerous punctures toward the extreme lateral margins, a group of three large punctures near each apical angle, from which several smaller ones stream posteriorly in a short longitudinal line, and others scattered along the oblique apical margins; elytra longer than wide, parallel, as long as the prothorax and distinctly wider but not quite as wide as the head, the punctures distinct, rather close-set and only feebly sublinal in arrangement throughout, with the usual smooth polished line along

the summit of the deflexed flanks; abdomen parallel, narrower than the elytra, distinctly and rather sparsely punctured throughout. Length 11.0 mm.; width 1.4 mm. Mexico (Guanajuato),— Dr. Duges. **dugesi** n. sp.

This species, sent me many years ago, appears to differ from *scutellaris*, the type of the genus, in having the tip of the abdomen red and in its somewhat smaller size. The scutellum has five or six coarse close-set punctures as in *scutellaris*.

HOMALOLINUS Shp. — This genus comprises a number of neotropical species of very depressed form and rather large size, living under the bark of dead trees. The species serving as the type of the description given in the table may be described as follows: —

Elongate, depressed, parallel, polished, deep black throughout, the entire fifth and sixth abdominal segments rufous, the legs black, with the tarsi rufous though becoming blackish toward base, the antennae black or blackish, with the pubescence cinereous; head behind the antennae but little longer than wide, impunctate, except a transverse line of punctures at the extreme base, with a median canaliculation bifurcating anteriorly and a short deep groove at each side; sides nearly straight, parallel, the basal angles but slightly more than right and not at all rounded; flanks behind the eyes rather finely and densely punctate, this punctured area not at all definitely limited above or below; under surface impunctate, except near the deep lateral longitudinal grooves; prothorax much shorter than the head and three-fourths as wide, the apical angles rounded, the sides converging posteriorly throughout, sinuate just behind the apical angles; elytra longer than wide, with diverging sides, about as long as the prothorax, toward apex distinctly wider, impunctate; abdomen evidently narrower than the elytra, parallel, sparsely punctate toward the sides. Length 14.8 mm.; width 2.0 mm. Guatemala, — G. W. Bock.....**atronitens** n. sp.

Resembles the Colombian *canaliculatus* Er., the type of the genus, but larger, with the entire fifth ventral rufous and differing in several other characters.

XANTHOPYPNUS n. gen. — The type of this genus is the very isolated species described by Dr. Sharp (Biol. Cent. Amer., Vol. 1, Pt. 2, p. 476), under the name *Xantholinus strigiceps*. It is deep black in color and of singularly compact, parallel and convex form. The short longitudinal scratches toward the sides of the head, which become still

more distinct and close-set throughout the entire under surface, seem to be peculiar to this particular generic type and I know of no other species which can be associated with it at present. The original description states that the prothorax has three punctures at each side near the "posterior" angles;— anterior angles was the expression evidently intended by the author.

IDIOLINUS n. gen. — That the true generic status of the *Xantholinus crassicornis*, of Hochhuth, should have been overlooked thus far by European observers, seems rather unaccountable, for it constitutes one of the most isolated genera among the allies of *Xantholinus*, as shown by the contiguous middle coxae and abnormal antennae. I am unable to state at present whether other described European species can enter the genus or not, the diagnosis of the table having been taken from two specimens of *crassicornis*, recently sent to me by Mr. Reitter.

NOTOLINUS n. gen. — This genus and the following constitute the most abundant type of South African Staphylinidae and are both represented by very numerous species, the nine that I collected in a few weeks within seventy-five miles of Cape Town in 1882, being probably only a small proportion of those occurring there. The two genera resemble each other somewhat strongly in outward habitus, which differs marvelously little from that of some common *Gyrohypni*, such as *hamatus*, though on closer examination the palpi and widely dilated tarsi, in connection with type of sculpture, prove them to be wholly isolated and a peculiar type developed in the southern regions of Africa. The four species before me may be described as follows: —

- Head less elongate, coarsely, very sparsely punctured, distinctly enlarged basally, with broadly rounded basal angles; species of larger size.... 2
 Head narrower and more elongate, parallel at the sides, with rather less broadly rounded basal angles and smaller, though moderately coarse and equally sparse punctures; body usually much smaller in size and more slender in form..... 3
 2 — Stout, parallel, rather convex, polished, black, the anterior parts with feeble bronze reflection, the abdomen slightly picescent; legs and antennae blackish-piceous, the tarsi paler; elytra slightly paler along the apical margin; head behind the antennae barely as long as wide; frontal

grooves slightly converging, the ocular represented in great part by a large puncture above each eye; vertex broadly impunctate along the middle; prothorax only about a fifth longer than wide, narrower than the head, the anterior angles rounded; sides only very slightly converging, feebly sinuate toward the middle, the base unusually broad, rounded, only slightly narrower than the base of the elytra, the serial punctures coarse; elytra but little longer than wide, a little longer than the prothorax, wider than the latter and somewhat wider than the head, subparallel; punctures rather strong and sparse, irregular, with two partial series externally and a smooth line along the summit of the flanks and thence moderately closely, irregularly punctured to the lower margin; abdomen only slightly narrower than the elytra, very minutely strigilate, finely, sparsely punctulate, with a narrow median impunctate area. Length 7.5 mm.; width 1.18 mm. Cape Town.

grossulus n. sp.

Stout but less so than the preceding, similar in coloration, except that the black is not bronzed and the elytra are pale luteo-flavate, becoming gradually and increasingly infumate with blackish-piceous from about apical third or fourth to the base; head convex, behind the antennae as long as wide, the frontal grooves converging as in *grossulus* and similar otherwise; prothorax a little narrower, more elongate and more strongly narrowed from the rounded apical angles to the base, which is rounded and very distinctly narrower than the base of the elytra, the sides nearly straight, the serial punctures strong; elytra slightly elongate, subparallel, distinctly wider than the prothorax, as long as the latter in the female but slightly shorter in the male, much wider than the head in the former but not so obviously in the latter sex, the punctuation nearly similar to that of *grossulus*, though perhaps sparser as a whole and rather more condensed along the suture; abdomen narrower, distinctly narrower than the elytra, similarly punctured. Length 6.5-7.25 mm.; width 0.9-1.0 mm. Wellington.....**fumipennis n. sp.**

8 — Body more slender than in the two preceding species, black, shining, the elytra generally black, sometimes paler; the legs and antennae blackish-piceous, the tarsi paler; head behind the antennae as long as wide in the male, smaller and somewhat more elongate in the female, distinctly though not so coarsely, very remotely punctate, with the usual broad smooth area along the middle, the under surface more finely, very sparsely punctate; prothorax elongate, one-third to two-fifths longer than wide, fully as wide as the head in the female, and nearly as wide in the male, the apical angles broadly rounded, the sides only very feebly converging and nearly straight thence to the base; punctures of the dorsal series strong; elytra quadrate in the male, somewhat elongate in the female, more distinctly wider than the prothorax in the latter, where the two are equal in length, the elytra relatively shorter in the male; punctures rather numerous and coarse, forming two irregular series externally except toward tip; abdomen rather distinctly narrower than the elytra, finely, sparsely punctulate, except along the middle as usual. Length 5.8-6.2 mm.; width 0.78-0.85 mm. Cape Town and Wellington.....**hottentotus** Sachse

Body equally slender and still smaller, dark piceous to blackish in color,

the elytra always somewhat paler and piceo-rufous; legs and antennae blackish-piceous, the tarsi paler; head behind the antennae quadrate, very sparsely and rather finely punctured toward the sides, the eyes moderately developed and slightly convex as usual; under surface finely, sparsely punctate; prothorax as wide as the head to a little wider, much less elongate than in the preceding and with the sides more strongly converging from the broadly rounded apical angles and nearly straight, about a fourth longer than wide, the serial punctures moderately coarse; elytra equal in length to the prothorax to distinctly longer, slightly wider than the latter and much wider than the head, punctured nearly as in *hottentotus* but still more sparsely; abdomen slightly narrower than the elytra, sparsely punctulate as usual. Length 4.3-4.8 mm.; width 0.65-0.7 mm. Cape Town and Wellington.....**parvus** n. sp.

Of *hottentotus* I have a female from Cape Town and a male from Wellington, the former satisfying the original description in being black throughout, but the latter, while differing in its stouter form, broader head, shorter elytra and other characters due to sex, has the elytra decidedly pale piceo-rufous and more strongly punctate. There may be two closely allied species involved but the material before me is too limited to permit of decision on this point at present. I have been unable to recognize the *Xantholinus fallax*, of Sachse, this species being black, polished, with the prothorax almost parallel and subequal in length to the elytra.

NOTOLINOPSIS n. gen. — The resemblance between this genus and the last is very noticeable and the similarity is augmented by some of the principal structural peculiarities of *Notolinus*, such as general minute surface sculpture, widely dilated anterior tarsi and other characters, but the form of the fourth palpal joint and frontal grooves differs so greatly as to leave but little doubt of the generic difference, especially in conjunction with certain constant differences in the punctation, the series of the pronotum, for example, never being regular as they are in *Notolinus*, but always composed of more numerous punctures, which are irregularly disposed in a longitudinal direction throughout the length in the position occupied by the regular series of *Notolinus*, and the punctures of the elytra are more numerous and evenly, though irregularly, scattered throughout, without sublateral series. In addition, the surface of the head beneath is flatter in *Notolinus* and rather more abruptly limited at the sides, and the labrum

appears to differ, being less deeply emarginate or less strongly bilobed in *Notolinopsis*. The species in my cabinet number five at present and they may be defined as follows: —

Frontal grooves long, though feebly impressed extending well behind the transverse line limiting the eyes anteriorly. Body larger, moderately slender and convex, shining, black, the abdomen slightly picescent, the elytra not paler; legs and antennae blackish-piceous, the tarsi pale; head of the female behind the antennae somewhat longer than wide, the eyes rather small, the punctures coarse and very remotely scattered toward the sides; prothorax a fourth longer than wide, scarcely narrower than the head, the anterior angles narrowly rounded, the sides very distinctly converging and nearly straight thence to the base; dorsal punctures strong, very sparsely disposed antero-laterally; elytra ample, rather longer than wide, as long as the prothorax and distinctly wider, slightly wider than the head, the sides diverging from the base; punctures sparse but strong, evenly distributed; abdomen parallel, narrower than the elytra, finely, sparsely punctulate except along the middle. Length 7.0 mm; width 1.05 mm. Wellington.... *incultus* n. sp.

Frontal grooves very short as well as feeble; species smaller in size.....2

2 — Elytra ample, as long as the prothorax, or, in the male, but little shorter, the sides diverging from the base.....3

Elytra much shorter than the prothorax in both sexes, the sides sensibly diverging from the base.....4

3 — Body larger and stouter, polished, rufo-piceous in color, the elytra somewhat paler, the antennae fuscous, the legs pale rufo-piceous; head behind the antennae about as long as wide, dilated toward base in the male, smaller and parallel in the female, the eyes relatively smaller in the former, the punctures coarse and sparse toward the sides; third antennal joint but slightly longer than the second, the under surface finely and sparsely punctate toward the sides, impunctate toward the median line and base; prothorax large, especially in the male, as wide as the head in both sexes, a third to two-fifths longer than wide, the apical angles very distinct and narrowly rounded, the sides thence strongly converging to the base and almost straight, the puncture very sparse as usual and only moderately coarse; elytra rather longer than wide much wider than the head in the female and slightly so in the male, a little shorter than the prothorax in the latter but equal in the female, the punctures rather close-set throughout; abdomen finely, sparsely punctulate as usual. Length 5.8 mm; width 0.9 mm. Wellington.

latitarsis n. sp.

Body very slender, black, the elytra dark rufo-piceous, the antennae fuscous, the legs blackish-piceous, with the tarsi pale; head narrower, behind the antennae longer than wide, parallel and straight at the sides, the punctures rather small and widely scattered toward the sides, the under surface finely, sparsely punctate throughout except toward base; antennae as in *latitarsis* though more slender; prothorax scarcely as wide as the head, two-fifths longer than wide, the anterior angles rather broadly rounded, the sides thence distinctly converging and broadly, medially

sinuate to the base; punctures sparse, fine and rather feeble; elytra longer than wide, as long as the prothorax and slightly wider, the punctures rather fine but close-set throughout, except along the upper part of the deflexed flanks, where there is the usual polished impunctate line; abdomen nearly as wide as the elytra, inconspicuously punctulate as usual. Length 5.0 mm.; width 0.73 mm. Wellington.

languidus n. sp.

- 4 — Form stout, parallel, shining, dark rufo-piceous throughout, the legs and antennae pale; head in the male large, gradually dilated toward base, with the eyes small, in the female a little narrower, parallel, with the eyes larger, the basal angles unusually broadly rounded in both sexes, the punctures very fine, remotely scattered toward the sides; third antennal joint notably longer than the second; prothorax large in the male, much smaller and shorter in the female, scarcely narrower than the head in the former, distinctly so in the latter, a fourth to nearly two-fifths longer than wide, the sides strongly converging and the apical angles rather broadly rounded, the punctures rather fine and sparse but distinct; elytra scarcely as long as wide, much shorter and slightly wider than the prothorax, the punctures rather fine but strong and close-set throughout; abdomen broader than usual, about equal in width to the elytra, finely, sparsely punctulate. Length 5.9 mm.; width 0.9 mm. Cape Town.....*capensis* n. sp.

Form moderately stout, parallel, shining, smaller in size, rufo-piceous throughout, the legs and antennae paler; head behind the antennae rather longer than wide, parallel, the basal angles moderately rounded; punctures fine and somewhat close-set laterally, wanting almost throughout the width anteriorly, the antennae nearly as in the preceding species; prothorax two-fifths longer than wide, equal in width to the head, the apex subtruncate, the apical angles very distinct and only narrowly rounded, the sides rather strongly converging; base subcircularly rounded, the punctures fine and sparse; elytra and abdomen nearly as in *capensis*. Length 5.6 mm.; width 0.8 mm. Cape Town.

diligens n. sp.

The more sharply angulate basal angles of the head and apical angles of the prothorax and general form of the head serve to distinguish *diligens* from *capensis*, the type of the former being apparently a male.

Eulissus Mann.

The genus *Eulissus* appears to be the only one devoid of dorsal pronotal series of punctures known thus far to the palaeartic fauna. These structural types are numerous in the warmer parts of North and South America and *Eulissus* is approached most closely perhaps by the genus *Saurohypnus*, of Sharp. The pronotum is not wholly sculptureless in

Eulissus, there being a deep arcuate punctured groove near each side, a coarse setigerous puncture anteriorly at lateral fourth and another near each basal angle. The extremely coarse, deep and sparse punctures of the head, aggregated into punctured grooves laterally, seems to be a character peculiar to *Eulissus*. The elytra have each a medial series of distinct punctures and are otherwise wholly sculptureless, except in a broad line along the elytral suture and on the deflexed flanks, where the punctures are irregularly arranged. Dr. Sharp was greatly in error in uniting *Eulissus* with *Xantholinus*, as the two genera are only related in the characters of the subtribe. This may be appreciated at once on observing the structure of the mandibles in the two genera. Our single species may be briefly described as follows: —

Moderately stout and convex, parallel, highly polished, deep black, the elytra throughout pale rufous, the scutellum black; antennae ferruginous, with the first three joints black, the legs piceous-black, the tarsi paler; head rather longer than wide, parallel and very feebly arcuate at the sides, the base broadly arcuate, with the angles obtuse though scarcely rounded; antennae but little longer than the head; prothorax somewhat shorter and distinctly narrower than the head, elongate, the anterior angles distinct, the sides converging thence to the base, becoming broadly and feebly sinuate posteriorly; elytra slightly shorter and wider than the prothorax but not quite as wide as the head; abdomen finely, rather sparsely punctured, less distinctly in a broad area along the middle. Length 9.5 mm.; width 1.4 mm. Rhode Island and New Jersey.
fulgidus Fab.

There is no perceptible difference of any kind between the American examples, which are rather rare, and the European, indicating that the species is a recent introduction to our fauna through commercial intercourse.

Nudobius Thoms.

This genus is far more developed in temperate North America than in Europe and probably originated on this continent. The species are rather more slender than those of *Eulissus* and are usually black with pale elytra, but in the European *collaris*, the prothorax is testaceous and the elytra black, this being a very exceptional form. In many charac-

ters *Nudobius* is somewhat intermediate between *Eulissus* and allied genera and *Xantholinus*, but in the rapid medial deflection of the side margins of the prothorax, which unite with the lower margin and do not continue separate therefrom to the apex, it is wholly isolated. The integuments are highly polished throughout, but the surface of the head and pronotum has, besides the normal punctures, a system of very minute sparse punctules, evenly distributed throughout, and these surfaces have besides a very feeble and frequently obsolescent minute transverse wavy strigilation. The species in my cabinet may be described as follows: —

- Head behind the line of the antennae about as long as wide.....2
 Head behind the antennae longer than wide.....8
 2— Species of the Atlantic regions. Body small in size, rather slender, moderately depressed, black, the pale elytra clouded with piceous-black posteriorly and externally; legs pale rufous, the antennae piceous, rufous toward base; head rather coarsely, very sparsely punctured even toward the sides; antennae much longer than the head; prothorax slightly narrower than the head, a fourth longer than wide, the sides strongly converging posteriorly from a short distance behind the anterior angles to the base, the punctures very fine as usual; elytra distinctly longer than wide, a little wider than the prothorax, and, on the suture, about as long, narrower than the head, sparsely punctured, the punctures feebly sublineate on parts of the disk but wholly wanting in a polished convex line at the summit of the deflexed flanks as usual; abdomen minutely, very remotely punctate. Length 6.5 mm.; width 0.9 mm. Massachusetts and Virginia to Lake Superior; Ohio (Cincinnati). [= *assimilis* Kirby, *consentaneus* and *flavipennis* Nordm., *kiesenwetteri* Sachse and *pallidatus* Mels.].....**cephalus** Say
 Species of the Sonoran regions.....3
 Species of the true Pacific coast fauna.....5
 3— Elytra large, much longer as well as wider than the prothorax. Body much stouter than in *cephalus*, black as usual, the elytra piceous-black, obliquely pale in nearly basal half; legs dark ferruginous, the antennae piceous-black, becoming rufo-piceous toward base, stouter distally than in *cephalus*; head rather coarsely, very sparsely punctate, the punctures less sparse toward the eyes, the front with a small impression between the posterior ends of the frontal grooves; prothorax much narrower than the head, a fifth longer than wide, smaller than usual in the genus, the sides as strongly convergent as in *cephalus*; elytra longer than wide, a fourth longer and wider than the prothorax but not quite as wide as the head, sparsely and rather confusedly punctured; abdomen very sparsely punctulate. Length 7.2 mm.; width 1.1 mm. Utah (south-western).....**nubipennis** n. sp.
 Elytra relatively smaller, equal in length to the prothorax and only slightly wider, the body black throughout, with rufous legs and piceous-black

- antennae, the latter becoming slightly paler toward base, the elytra clear and bright testaceous throughout; head coarsely and moderately sparsely punctured toward the sides.....4
- 4 — Form stouter and more parallel, the prothorax only slightly narrower than the head and less strongly narrowed behind from near the apex, about a fifth longer than wide; elytra only slightly longer than wide, subequal in width to the head, the punctures sparse and subserial at the middle, closer and broadly, irregularly aggregated toward the suture; abdomen sparsely punctulate as usual. Length 8.0 mm.; width 1.2 mm. Arizona (Phoenix).....**phoenicis** n. sp.
- Form more slender, the prothorax much narrower than the head, nearly two-fifths longer than wide and strongly narrowed behind from near the apex; elytra distinctly elongate, obviously narrower than the head, sparsely punctate, with a somewhat well accentuated series of very slightly larger punctures along the middle, the punctures fine, not noticeably aggregated along the suture, except a single line along the summit of the sutural bevel; last joint of the antennae slightly narrower than the tenth, longer than wide and conoidally pointed. Length 8.0 mm.; width 1.1 mm. Arizona (Williams) and New Mexico (Las Vegas).....**arizonicus** n. sp.
- 5 — Second antennal joint a little shorter than the third, the latter being more strongly obconical in form, body large in size, strongly punctured.....6
- Second antennal joint rather longer and stouter than the the third, the latter less strongly obconical.....7
- 6 — Front distinctly though finely punctured between the frontal grooves; elytral punctures moderately sparse and strong, the elytra clear rufous throughout, the legs pale testaceous; head large and well developed, very coarsely, rather closely punctate toward the sides, the punctures elongate, strong, more rounded and close-set beneath, becoming less distinct and sparser toward base; mandibles with a fine groove on the flat under surface in addition to the deep external groove; prothorax much narrower than the head, longer than wide, strongly narrowed posteriorly from near the apex; elytra as long as the prothorax and wider, longer than wide and narrower than the head; punctures of the medial series stronger than the others as usual, the punctures exterior to the series much finer than those toward the suture, the summit of the deflexed flanks narrowly impunctate as usual. Length 7.7-9.2 mm.; width 1.25-1.4 mm. Washington State and Oregon (The Dalles).....**pugetanus** n. sp.
- Front almost impunctate between the grooves; elytral punctures coarser and very sparse, the elytra pale testaceous, with the basal, apical and lateral margins blackish; head well developed, the punctures rather less coarse and not quite so close-set toward the sides as in *pugetanus*, the under surface less strongly and more sparsely punctured; prothorax longer than wide, slightly narrower than the head, moderately narrowed behind; elytra elongate, slightly longer and obviously wider than the prothorax and fully as wide as the head, the punctures coarse and strongly impressed throughout, obscurely serial at the middle. Length

9.6 mm.; width 1.35 mm. California (Truckee — elevation 5800 feet),
— H. F. Wickham *limbalis* n. sp.

- 7 — Body larger and much stouter, black, the abdomen somewhat picescent; elytra flavo-testaceous, with the apical margin feebly and very narrowly infumate, the legs testaceous, the antennae dark red-brown throughout; head well developed, coarsely and somewhat closely punctured except broadly toward the middle, the under surface also strongly punctured; prothorax longer than wide, much narrower than the head, strongly narrowed posteriorly; elytra large, longer than wide, equal in length to the prothorax and distinctly wider, almost as wide as the head, the punctures much less coarse than in the preceding two species and more numerous, gradually rather close-set toward the suture, the medial series of coarser punctures distinct except toward tip; abdomen minutely, feebly and sparsely punctulate, polished as usual. Length 6.5–8.5 mm.; width 1.2–1.4 mm. California (Sta. Clara and Sta. Cruz, — under pine bark in February) *corticalis* n. sp.

Body small and slender, black, the legs and elytra pale testaceous, the latter feebly infumate at the apex, the antennae piceo-testaceous; head less developed, the punctures coarse and deep but unusually sparse even toward the sides, strong but rather sparse on the under surface; antennae more noticeably longer than the head than in the preceding species; prothorax elongate, longer than the head and only very slightly narrower, moderately narrowed posteriorly; elytra rather smaller than usual, longer than wide, not quite as long as the prothorax and obviously wider, about as wide as the head, the punctures only moderately coarse, rather sparse throughout, lineate at the middle as usual. Length 6.2 mm.; width 0.88 mm. California (Siskiyou Co.).

debilis n. sp.

8. — Body moderately large and slender, black, the abdomen somewhat picescent, the legs and elytra clear and bright rufous, the latter somewhat infumate at base, the antennae dark rufo-piceous; head well developed, elongate, parallel, the sides nearly straight, the base truncate, with the angles rather narrowly rounded; second and third antennal joints equal in length, the former somewhat the thicker as usual; surface only moderately coarsely and very remotely punctate even laterally, the punctures sparse on the convex flanks, becoming strong but only moderately coarse and less sparse over the flattened under surface; prothorax of the usual form, narrower than the head, elongate, narrowed posteriorly; elytra notably elongate, as long as the prothorax and distinctly wider, not as wide as the head, the punctures only moderately coarse, sparse and confused in arrangement, with the usual close-set medial series indistinct. Length 7.7 mm.; width 1.1 mm. Texas (Houston), Alabama (Citronelle) and West Virginia.

luridipennis n. sp.

Body smaller and very slender, black, the abdomen rufo-piceous but clouded darker toward tip, the elytra pale and bright luteo-flavate, with the base — more broadly — and the flanks, abruptly black; legs pale flavate, the antennae dark rufous throughout, rather thick and nearly as in *luridipennis*; head elongate, parallel, remotely and only moderately coarsely punctate, the convex flanks still more remotely, the under

surface less sparsely and distinctly; prothorax elongate, narrower than the head, of the usual form, with the sides nearly straight and distinctly converging posteriorly throughout; elytra longer than wide, not quite as long as the prothorax but distinctly wider, and, behind, fully as wide as the head, the sides diverging from the base; punctures small and very sparsely scattered throughout, with very indistinct linear arrangement near the smooth polished upper part of the flanks; abdomen parallel, narrower than the elytra, distinctly, sparsely punctate, with a smooth median line. Length 6.7 mm.; width 0.9 mm. West Virginia, — A. D. Hopkins.....*elegantulus* n. sp.

The punctures of the pronotum are notably fine, feeble, very sparse and inconspicuous throughout the genus *Nudobius* and are arranged in the usual two discal series, each containing some 5-7 punctures and an arcuate submarginal line, at each side, of nearly the same number; there are, in addition, some isolated punctures near the apical and anterolateral margins. The sexual characters are very feeble, the male having the sixth ventral arcuato-truncate at tip, the female having the latter more strongly and evenly, though still broadly, rounded. There are but few striking divergencies of structure and the species are remarkably homogeneous throughout, though *luridipennis* and *elegantulus* are unusually distinct because of the peculiar form and punctuation of the head.

Xantholinus Serv.

The European species of this genus are numerous and include some of the largest palaeartic members of the tribe, but in America I have been unable to find more than one, and this a rather small and aberrant form, widely distributed over the Pacific coast regions. The body is larger and stouter than in *Gyrohypnus*, with a much larger head, having the gular sutures united from well before the middle, forming a coarse deep groove to the base. In typical species, such as *glabratus* and *relucens*, the pronotal punctures are rather coarsely impressed, few in number and disposed in two dorsal series of about five and a sublateral series at each side of 5-6, with a few between the latter and the edge and some smaller punctures near the apical angles; in such forms as *rufipennis* Er., the series are placed

similarly but the punctures become fine and more numerous, being rather close-set in the series. Our *picipennis* constitutes still another group, with the dorsal punctures coarsely impressed and few in number, nearly as in the *glabratus* group, though the dorsal series terminate at a greater distance before the base; the sublateral series are similar, and, at some distance within each anterior angle, there is a cluster of three or four punctures, also others along the lateral and apical margins. The elytral punctuation of the European species is nearly as in *Nudobius*, and the feeble sexual characters throughout resemble those prevailing in that genus. Our single representative may be described as follows: —

Body rather stout, parallel, moderately convex, polished, deep black, the elytra and legs piceo-testaceous throughout, the antennae dusky; head behind the antennae quadrate, parallel and nearly straight at the sides, the basal angles rounded; sides behind the eyes flattened, this surface more inferior than dorsal in position, confusedly, closely and strongly punctured, its upper and lower bounding edges polished, subprominently rounded and impunctate; upper surface convex, coarsely and closely punctured, with a very broad and somewhat abruptly defined median impunctate area, the punctures of the under surface strongly, though not so closely impressed; neck rather more than two-fifths as wide as the head; antennae obviously longer than the head, with the outer part subparallel and only moderately stout, the second and third joints equal and each distinctly elongate; prothorax but little longer than wide, slightly narrower than the head, the sides rather feebly converging and varying from straight to feebly arcuate from the apical to the basal angles, both of which are rounded; elytra well developed, rather longer than wide, as long as the prothorax to a little longer and distinctly wider, not very coarsely but deeply, evenly, confusedly and somewhat sparsely punctate, the upper line of the deflexed flanks subimpunctate; abdomen finely, sparsely punctulate; hind tarsi with the first four joints decreasing very gradually in length. Length 6.2-7.5 mm.; width 1.2-1.4 mm. California (Monterey) to British Columbia.

picipennis Lec.

This is the most abundant Xantholinid of the Pacific coast and is subject to comparatively little variability, the head in some specimens — presumably male — being larger than in others, but not differing otherwise. One specimen, from British Columbia, has the elytra piceous-black but probably from accidental causes.

Gyrohypnus Steph.

In this genus the third palpal joint is actually shorter and the fourth relatively much longer and more acutely and gradually pointed than in *Xantholinus*, and this character, in conjunction with the different form of the gular sutures, as stated in the table, seems to prove that *Gyrohypnus* should not be regarded as a subgenus of *Xantholinus*. The species are smaller and more slender as a rule than in that genus, and the head is less developed, but, in a similar manner, *Gyrohypnus* is made up of a number of groups distinguished by peculiarities of pronotal sculpture and general facies, one or two of which approach some of the more aberrant groups of *Xantholinus* rather closely in appearance; this remark applies particularly to our *obsidianus* group, which strikingly recalls the American *picipennis* group of that genus, especially in the sculpture of the head and pronotum. In geographical distribution *Gyrohypnus* differs greatly from *Xantholinus*, the former being poorly represented in palaeartic regions but remarkably developed in the nearctic provinces, the reverse being the case in *Xantholinus*. Our species can be readily assigned to the following four subgeneric groups, defined principally by pronotal sculpture: —

- | | |
|--|-----------|
| Frontal grooves very long and conspicuous; gular sutures distinct..... | 2 |
| Frontal grooves short; gular sutures effaced..... | 5 |
| 2 — Sides of the head with a broad, parallel-sided, flattened and punctured line, involving the lower part of the eyes and extending to the arcuation of the basal angles. Nearctic regions throughout..... | 3 |
| Sides of the head almost evenly convex, the flattened area obsolescent; surface more convex throughout, generally very feebly sculptured.... | 4 |
| 3 — Pronotal punctures coarse, 4-6 in number in the dorsal series... Group I | |
| Pronotal sculpture finer as a rule, the punctures much more close-set in the dorsal series and 7-14 in number..... | Group II |
| 4 — Punctures of the head and pronotum very sparse, those of the dorsal thoracic series 10-12 in number; surface always highly polished and devoid of minute strigilation anteriorly. Nearctic Atlantic regions. | |
| | Group III |
| 5 — Dorsal series of the pronotum composed of 10-12 punctures; under surface of the head without minute strigilation. Sonoran regions of the Pacific coast | Group IV |

Groups I and II correspond satisfactorily with palaeartic species of the *punctulatus* and *angustatus* type, but the last two groups are probably peculiar to America. The rather numerous species may be defined as follows: —

Group I.

Color black or piceous-black, the elytra generally paler in part.....2
 Color testaceous or piceo-testaceous, the head black or blackish.....5

2 — Elytra black throughout. Body stout, narrowed anteriorly, moderately convex, deep black throughout, the antennae black, the legs dark piceo-testaceous; lustre shining; head small, rather longer than wide, parallel and straight at the sides, truncate at base, the angles narrowly rounded, the median parts smooth, the punctures coarse, deep and notably close-set toward the sides; flattened line behind the eyes densely, rather coarsely punctate, concave posteriorly, the edges becoming acute and very distinct; under surface elevated along the gular sutures, rather coarsely, closely punctate; prothorax obviously wider than the head, but slightly longer than wide, the angles broadly rounded; sides moderately converging and somewhat arcuate; serial punctures coarsely impressed, the dorsal series ending at basal third, with its 4-5 punctures very evenly spaced; sublateral series of 5-6 punctures and some scattered punctures near the anterior angles distinct; elytra quadrate, as long as the prothorax and much wider, coarsely punctate, each with two medial close-set series, unevenly punctured toward the suture; abdomen finely, rather sparsely punctulate. Length 6.7 mm.; width 1.2 mm. New York, Canada, Iowa, Lake Superior, Manitoba, Nevada (Reno) and Oregon (Albany). [= *americanus* Dej., i. litt.].

obsidianus Mels.

Elytra piceous, with the sides and tip piceo-testaceous. Body more slender than in *obsidianus*, piceous, the legs and antennae piceo-testaceous; head moderately convex, smooth, sparsely and coarsely punctured at the sides, the under surface very sparsely punctured, the sides with a broad shallow longitudinal groove which is distinctly margined and marked with a few shallow punctures; prothorax with the dorsal series 4-5 punctured, the lateral series punctured, with a large puncture nearer the margin as usual; elytra sparsely and coarsely punctate, the punctures arranged in nearly regular rows. Length 4.7 mm. Florida (Cedar Keys). [= *floridæ* Duviv.].....

Elytra pale testaceous or yellowish, more or less gradually darker in about basal half..... 3

3 — Sublateral series of the pronotum 7-9 punctured. Body more slender than *Xantholinus pictipennis*, piceous-black, the antennae and legs dark ferruginous, the elytra ferruginous, blackish in about anterior half; head moderately convex, rather elongate, the hind angles rounded; upper surface smooth at the middle, sparsely and coarsely punctured at the sides; frontal grooves as usual; under surface very sparsely and

coarsely punctured, the lateral edge obtuse, much less defined than in *X. picipennis*; prothorax oblong with rounded angles, distinctly longer than wide, slightly narrowed behind, the dorsal series 3-4 punctured, the lateral series curved as usual; elytra rather finely and indistinctly punctate, with a submedial series of fine but regular punctures; abdomen smooth, piceous, the hind margins of the segments paler, the ventral segments more broadly margined with pale piceous. Length 5.6 mm.

California (San Bernardino and Mojave Desert).....**dimidiatus** Lec.

Sublateral series 4-6 punctured; hind angles of the head obtuse but scarcely rounded 4

4 — Head very coarsely, sparsely punctured, the basal angles very obtuse, the base strongly arcuate throughout the width, the surface broadly smooth along the middle as usual; body only moderately slender and convex, polished, deep black almost throughout, the elytra and abdominal tip pale, the former very gradually infumate with blackish from near the middle to the base; legs pale, the antennae dark testaceous; head behind the antennae just visibly longer than wide, the sides parallel and very feebly arcuate, the flattened line at the sides well defined, in great part rather coarsely and closely punctate; under surface coarsely and sparsely punctured; prothorax a third longer than wide, not quite as wide as the head, the sides moderately converging and nearly straight, the angles not very broadly but evenly rounded; dorsal punctures coarsely impressed, unevenly spaced; elytra about as long as wide, the sides straight and feebly diverging from the base, about equal in length to the prothorax and wider than the head, in large part impunctate dorsally but rather broadly and confusedly so toward the suture, the isolated medial series composed of very small, widely spaced punctures and another more oblique series external to this is observable in apical half; abdomen very finely, sparsely punctulate, the segments not obviously paler at their apices. Length 5.8 mm.; width 0.93 mm. California (Pasadena),— A. Fenyès....**infumatus** n. sp.

Head very coarsely and unusually closely punctured toward the sides, the base feebly arcuate-truncate, the basal angles only slightly more than right and not at all rounded; body similar in form to the preceding and almost similar in coloration, except that the elytra are much more abruptly and deeply black in basal half and the legs darker testaceous; head behind the antennae rather longer than wide, the sides parallel and straight, the post-ocular line flat, coarsely and very closely punctured, the part along its upper margin impunctate as usual; under surface flat throughout, the punctures very coarse and sparser, unevenly distributed, forming one or two longitudinal series near the sides and irregularly scattered near the sutural lines, which are relatively rather fine; prothorax fully two-fifths longer than wide, equal in width to the head, the sides feebly converging and nearly straight, the angles well rounded; dorsal punctures rather coarsely impressed, very uneven in size and spacing; elytra quadrate, distinctly shorter and wider than the prothorax, the punctures small, rather feeble and sparse, disposed nearly as in *infumatus*. Length 6.5 mm.; width 1.1 mm. Arizona.

bipartitus n. sp.

- 5 — Under surface of the head minutely strigilate in close-set wavy lines 6
- Under surface of the head highly polished and smooth, not strigilate.... 9
- 6 — Dorsal series of the pronotum continuing barely to basal third as in all the preceding species..... 7
- Dorsal series of the pronotum continuing to basal fourth or less; body smaller and more slender, with the cephalic punctures smaller and more close-set and the flattened post-ocular line sometimes less defined at the edges..... 8
- 7 — Body larger, pale rufo-testaceous, the elytra more flavate, the abdomen darker and blackish-piceous, the head deep black, the legs and antennae ferruginous; head behind the antennae rather longer than wide, parallel, the sides feebly arcuate; base truncate, the angles broadly rounded; punctures coarse but smaller than in the preceding species and remarkably sparse even toward the sides, the post-ocular line perfectly fiat throughout, well defined, strongly but not very closely punctate; under surface shining, strongly and sparsely punctate; prothorax scarcely a third longer than wide, distinctly narrower than the head, the sides strongly converging and straight, the angles moderately rounded; surface with scarcely a puncture except the dorsal and sub-lateral series, each of 4-5 punctures, and about two others, isolated and rather larger, well within the apical angles; elytra subquadrate, not quite as long as the prothorax and but little wider, the punctures small but distinct, confused near the suture, elsewhere wanting on the dorsal surface, except a distinct medial series and another exterior and parallel in apical half only and composed of finer punctures; abdomen minutely, sparsely punctulate. Length 6.5 mm.; width 1.0 mm. New York, Virginia, Ohio (Cincinnati) and Louisiana. [= *sanguinolentus* Mels.]..... **emmesus** Grav.
- Body smaller but larger and stouter than in *fusciceps*, pale rufo-testaceous in color, the elytra rather more flavate; head black, the abdomen pale red-brown throughout; head behind the antennae distinctly elongate, otherwise similar to that of *emmesus*, except that the punctures toward the sides are much more close-set; prothorax narrower and relatively more elongate, much narrower than the head, similar in sculpture; elytra elongate, only very slightly wider than the prothorax and much narrower than the head, the punctures coarser and more numerous than in *emmesus*, similarly lineate on the disk; abdomen distinctly narrower than the elytra, parallel, finely but very conspicuously and asperately punctate, more strongly so than in *emmesus*. Length 5.8 mm.; width 0.85 mm. Louisiana (Ponchatoula), — G. W. Bock... **luteiventris** n. sp.
- 8 — Antennae scarcely at all enlarged toward tip, the second and third joints equal, both elongate. Body larger, pale brownish-testaceous, the legs concolorous, the antennae dark red-brown; head piceous-black, longer than wide, the sides almost parallel and very feebly arcuate; basal angles broadly rounded; flattened line behind the eyes rather closely punctured, the punctures of the upper surface deep but only moderately coarse, separated by about twice their own widths toward the sides, those of the under surface fine but strong and sparse; prothorax elongate, rather wider than the head, with two series of

about five punctures each at each side and a few others isolated toward the sides and apex as usual, the sides distinctly converging; elytra rather longer than wide, not quite as long as the prothorax and scarcely at all wider, the medial series close-set and strong; exteriorly there is another nearly entire parallel series of very fine, widely spaced punctures, the latter irregularly aggregated near the suture as usual; abdomen finely but unusually distinctly and not very sparsely punctulate toward the sides. Length 5.5 mm.; width 0.75 mm. New York to Iowa. [= *fusciceps* Fvl., i. litt.].....**fusciceps** Lec.

- Antennae shorter and more compact, distinctly and gradually thicker distally to the apex, the subapical joints much more strongly transverse, the third very small, globular, much shorter than the slightly elongate second joint; body very small in size, slender, colored like the preceding, except that the prothorax is paler testaceous than the parts posterior thereto; head piceous-black, nearly similar in form, the hind angles much less broadly rounded, the punctures toward the sides small but distinct and less close-set, the post-ocular line narrower and less punctate, the under surface strongly, sparsely punctate; prothorax elongate, slightly wider than the head, the sides strongly converging throughout and nearly straight, the surface punctured nearly as in *fusciceps*; elytra elongate, subequal in width to the prothorax and a little shorter, similarly though more finely punctate; abdomen more finely punctulate, rather more broadly and abruptly impunctate along the middle. Length 3.5 mm.; width 0.6 mm. New Jersey and Virginia (Fort Monroe); — rare on sea-beaches.....**fuscus** Csy.
- 9 — Body rather slender and convex, almost perfectly parallel, pale rufotestaceous, with the legs concolorous, the abdomen piceous and the head black; antennae dusky testaceous, brighter toward base; head behind the antennae distinctly elongate, varying from subparallel to distinctly inflated basally, the sides nearly straight, the angles at base well rounded; punctures not very coarse but deep, elongate, separated by fully twice their own widths toward the sides; post-ocular line flat with obtusely rounded edges, very deeply and more closely punctate, the punctures of the under surface strong, perforate, moderately close-set over the entire surface; prothorax elongate, not quite as wide as the head, with the sides only moderately converging throughout and almost straight, the apical angles narrowly rounded, the punctures of the dorsal series only extending to basal third; sublateral series of about five punctures, and there is externally and anteriorly a small group of punctures; elytra subquadrate, unusually small, much shorter than the prothorax and equal thereto in width, strongly and moderately coarsely punctured, the punctures of the two equal parallel discal series similar, fine and irregular; narrowly along the suture, and, between these and the first discal series, are a few sparse punctures tending to linear arrangement; abdomen rather closely and distinctly punctulate toward the sides. Length 6.0 mm.; width 0.85 mm. New York (Long Island) and Virginia to Kansas and Colorado (Greeley).....**melanops**

Group II.

- Head polished beneath and strigilate with very fine wavy lines2
 Head less shining beneath, where the surface is minutely but strongly reticulate11
2 — Prothorax never paler in color than the elytra.....**3**
 Prothorax paler than the elytra, the latter relatively smaller and distinctly shorter than the prothorax.....10
3 — Body black or piceous-black in color, the elytra never more than slightly paler**4**
 Body black or blackish, the elytra always conspicuously pale.....8
4 — Elytra each with two isolated, parallel and subentire series of dorsal punctures, the punctures toward the suture more or less broadly or completely confused in arrangement; body moderately large in size..5
 Elytra each with three more or less complete isolated series of dorsal punctures, the latter more narrowly confused along the suture; body very small in size.....**7**
5 — Body moderately slender and convex, polished, deep black, the prothorax very dark rufo-piceous, the elytra somewhat less dark than the prothorax; legs dark rufous, the antennae dusky; head oblong, parallel, distinctly longer than wide behind the antennae, the basal angles broadly rounded, the punctures deep but only moderately coarse or close-set; flattened post-ocular line well defined, strongly and closely punctate; punctures of the under surface distinct though not very coarse, rather sparse, still sparser toward the sutures; prothorax somewhat narrower than the head, evidently though not strongly narrowed posteriorly throughout, a third longer than wide, the angles rather narrowly rounded; serial punctures close-set and strong, 8-11 in number in the dorsal series and about as numerous in the sublateral, both series ending anteriorly in confused clusters of smaller punctures, a larger puncture near the side and apical third is also obvious; elytra not quite as long as the prothorax but much wider and distinctly wider than the head, longer than wide; abdomen slightly narrower than the elytra but wider than the head; finely punctulate laterally as usual. Length 4.8-6.6 mm.; width 0.8-1.08 mm. Rhode Island and Ontario to northern New Mexico, Colorado, Nevada, Idaho and Manitoba. [= *obscurus* Er.].

hamatus Say

- Body deep black throughout, the elytra scarcely perceptibly paler, the antennae black and the legs dark rufo-piceous in color; elytral punctures less broadly aggregated along the suture.....6
 — Form rather stouter, the size larger, as in *hamatus*; head as in that species, with the punctures similar but less close-set, being separated toward the sides by three times their own widths but becoming smaller and closely aggregated in a broad line along the upper margin of the post-ocular flattened line, the latter strongly, somewhat closely punctured; under surface rather finely but distinctly, sparsely punctate, the punctures obsolete toward base; prothorax as in *hamatus*, slightly narrower than the head but with the sides less obviously converging; elytra nearly similar but less distinctly wider than the prothorax and

- much less broadly, confusedly punctured toward the suture, the impunctate space thence to the first medial series wider. Length 6.3 mm.; width 0.98 mm. Oregon (Portland),—H. F. Wickham. **oregonus** n. sp.
- Form very slender, rather smaller in size, polished, convex; head moderate, parallel, behind the antennae much longer than wide, the sides nearly straight; basal angles broadly rounded, the punctures throughout nearly as in *hamatus*; prothorax notably narrow and elongate, two-fifths longer than wide, the sides moderately converging, becoming somewhat sinuate posteriorly, the apical angles rather narrowly rounded, punctured nearly as in *hamatus*; elytra elongate, somewhat shorter than the prothorax and much wider, distinctly wider than the head; abdomen slightly wider than the head, punctulate as in the preceding species. Length 6.0 mm.; width 0.8 mm. Wisconsin (Bayfield),—H. F. Wickham. [= *corvinus* Dej., i. litt.].....**protractus** n. sp.
- 7 — Body slender, convex, polished, black, the elytra and antennae blackish-piceous, the legs paler, dark testaceous; head well developed, the sides straight and parallel or feebly diverging to the moderately rounded basal angles; punctures nearly as in *hamatus*, those of the flattened post-ocular line obsolescent posteriorly and those of the under surface sparse and inclined to serial arrangement laterally, broadly subobsolete toward the middle; antennae rather thicker distally, the second joint obviously longer and thicker than the third; prothorax slightly narrower than the head, elongate, distinctly narrowed posteriorly, with the sides somewhat arcuate, the angles broadly rounded; punctures of the dorsal series strong, close-set, 10-12 in number, the sublateral short and irregular, of 5-6 punctures; toward the sides throughout the length there are many other punctures tending to serial arrangement; elytra elongate, slightly longer and much wider than the prothorax; abdomen but slightly narrower than the elytra, minutely, sparsely punctulate. Length 4.5 mm.; width 0.7 mm. California (Elsinore, — Riverside Co.).....**mollinus** n. sp.
- 8 — Second and third antennal joints equal in length as usual; strigilation of the under surface of the head subobsolete, the punctures deep and close-set between the gular sutures anteriorly, elsewhere strong but sparse, becoming obsolete toward base; body larger, stouter, polished, black, the abdomen rather distinctly, and the prothorax just visibly, piceous; entire elytra clear and bright rufous in color, the legs pale, the antennae very dark testaceous; head well developed, behind the antennae distinctly elongate, parallel, the sides nearly straight, the basal angles well rounded; antennae parallel through the outer seven joints, moderately thick as usual; punctures coarse, deep and close-set toward the sides, the post-ocular flattened line also deeply and rather closely though less coarsely punctured; prothorax distinctly elongate, narrower than the head, the sides parallel and straight for nearly two-fifths from the apex, then very feebly converging to the base, the angles only slightly rounded; punctures strong, arranged nearly as in *hamatus*; elytra ample, longer than wide, much wider than the prothorax and fully as long, wider than the head, rather strongly punctured almost as in *hamatus*, the two medial series, however, only distinct to a little behind the middle; abdomen rather closely and strongly punctulate toward the sides.

- Length 5.7–7.0 mm.; width 0.95–1.0 mm. Sea beaches of New Jersey [= *lecontei* Duviv.].....**sanguinipennis** Lec.
- 8—Second antennal joint obviously longer and thicker than the third; body much smaller and more slender, the elytra in great part pale flavate in color.....9
- 9—Strigilation of the under surface of the head obsolescent, the surface smooth and polished, with a few deep punctures between the gular sutures anteriorly, dark piceous to nearly black, the head deep black, the elytra pale flavate, clouded with piceous on the flanks and in nearly apical half; legs pale, the antennae dark rufous; head rather short, behind the antennae not or but slightly longer than wide, the sides straight and feebly converging, — in opposition to the general rule — from the eyes to the rounded basal angles; punctures moderately coarse, deep, sparse toward the sides but closer near the eyes, the post-ocular flattened line much narrower than usual, distinctly punctured; punctures of the under surface fine but strong, sparsely and uniformly scattered though narrowly obsolete along the sutures; prothorax elongate and evidently narrower than the head, the sides feebly diverging from the obtuse and slightly rounded apical angles for a third of the length, then moderately converging and feebly sinuate to the base; punctures of the dorsal and sublateral series rather feeble and only about seven in number; a few coarse punctures along the edge at the apical angles are also visible, the entire surface, as well as that of the head, having very minute, sparsely but evenly distributed punctules as in the genus *Nudobius*, the surface feebly tumid in the middle at base; elytra elongate, much wider than the prothorax and not quite as long, wider than the head, the punctures strong though sparse, the two close-set medial series only distinct in basal half; abdomen very minutely and sparsely punctulate. Length 5.8 mm.; width 0.7 mm. New York (Hudson Valley).....**gilvipennis** n. sp.
- Strigilation distinct, the space between the gular sutures anteriorly finely and roughly sculptured but scarcely punctured, blackish-piceous in color, the elytra thinner and more diaphanous than usual, pale flavous, feebly infumate at base and thence gradually more narrowly along the suture to behind the middle; legs pale, the antennae very dark testaceous; surface polished without fine scattered punctules; head moderate, behind the antennae but little longer than wide, more or less distinctly inflated toward base, the angles broadly rounded; punctures rather coarse, deep and close-set toward the sides, the under surface, post-ocular flattened line and pronotal sculpture nearly as in *hamatus*, the latter, however, with fewer extra-serial punctures anteriorly; prothorax elongate, very slightly narrower than the head, the sides distinctly converging from near the apex to the base and virtually straight; elytra somewhat elongate, a little longer than the prothorax and much wider, finely but distinctly, somewhat sparsely punctured nearly as in *hamatus*, the two medial series traceable almost to the apex; abdomen finely, sparsely punctulate toward the sides. Length 3.6–5.3 mm.; width 0.6–0.8 mm. Virginia to Lake Superior and Texas (Austin and Brownsville), Arizona (Riverside and Tucson) and Mexico (Guansjuato.).....**pusillus** Schse.
- 10—Body very slender, small in size, parallel, shining, the elytra and

abdomen very dark or blackish-piceous, the prothorax much paler, testaceous, somewhat clouded with pale piceous, the head black; legs pale, the antennae piceo-rufous; head in form and punctuation and the pronotal sculpture nearly as in *hamatus*; prothorax obviously narrower than the head, elongate, with the sides rather feebly converging from near the apex to the base; elytra somewhat longer than wide, rather distinctly wider than the prothorax but only just visibly wider than the head, the sculpture as in *hamatus*; abdomen finely and inconspicuously punctulate. Length 5.0 mm.; width 0.78 mm. Nevada (Reno), Wyoming (Laramie) and Manitoba. *macilentus* n. sp.

- 11 — Form slender, parallel, only moderately convex, very pale piceo-testaceous in color, the head darker and the elytra much paler and more flavate; legs pale, the antennae darker and with the second joint slightly longer and thicker than the third; head moderate, the sides subparallel and the angles well rounded, distinctly elongated behind the antennae, the punctures not very coarse but deep and close-set toward the sides, the post-ocular line normal, rather finely, closely punctured, the punctures of the under surface rather fine and sparse and rendered still less distinct because of the ground sculpture; prothorax elongate, distinctly narrower than the head, the sides moderately converging from near apical third to the base; medial series composed of 12-14 very close-set punctures, the sublateral series also with many close-set punctures and there are numerous others scattered toward the apical angles; elytra elongate, fully as long as the prothorax and much wider, distinctly wider than the head, the punctures moderate in size and rather feebly impressed, somewhat close-set, the arrangement nearly as in *hamatus*; abdomen minutely and inconspicuously punctulate toward the sides. Length 4.2 mm.; width 0.62 mm. Montana to Arizona and New Mexico. *fragilis* n. sp.

Group III.

Hypnogyra n. subg.

- Punctures of the head and pronotum very fine and sparse, the head more strongly convex than in the preceding groups and without the flattened post-ocular line. 2
- Punctures of the head coarse as well as sparse. 3
- 2 — Body rather stout, parallel, convex, very highly polished, black, the elytra and legs bright rufous throughout, the abdomen blackish-piceous throughout above, the apices of the segments paler beneath, the antennae dusky rufous; head behind the antennae but little longer than wide, just visibly inflated toward base, the angles broadly rounded; sides very feebly arcuate, the punctures extremely small and remotely separated, not closer at the sides or beneath, the median impunctate area unusually wide; oblique ocular grooves distinct; flanks behind the eyes evenly convex; antennae unusually thick, about as long as the entire head, the subapical joints closely joined and rather strongly transverse, the second joint noticeably longer and thicker than the third; prothorax but little longer than wide, somewhat wider than the head, the angles

well rounded, the sides but feebly converging and slightly arcuate throughout; dorsal and sublateral series almost even, composed of very small and widely spaced punctures, the former about ten, the latter about five in number; there are also some rather close-set punctures along the antero-lateral margin; elytra slightly elongate, somewhat longer and but little wider than the prothorax, the punctures very small, rather sparse, arranged as in *hamatus*, the outer of the two medial series less distinct; abdomen but little narrower than the elytra, convex, finely but very distinctly and only moderately sparsely punctulate, still more distinctly beneath. Length 6.7-7.3 mm.; width 1. mm Iowa (Iowa City), — H. F. Wickham.....*vernigatus* n. sp.

Body nearly similar to the preceding but much smaller, with less developed head and less minute punctuation, the coloration and lustre similar throughout, the prothorax rather less intensely black, the antennae similar in color and structure; head rather small, similar to that of *vernigatus*, the punctures a little larger and somewhat less remotely separated but still very sparse, very minute on the flanks and under surface and rather sparser; prothorax slightly elongate, distinctly wider than the head, similar to that of *vernigatus* but narrower and more elongate and with the dorsal and sublateral series much less regular, with the punctures stronger and more close-set, with numerous outlying punctures anteriorly and more scattered toward the anterior angles; elytra but little longer than wide, somewhat shorter than the prothorax and only just visibly wider, the punctures sparse but stronger than in the preceding, more narrowly aggregated along the suture and usually arranged in three series along the middle; abdomen almost similar. Length 5.0-5.8 mm.; width 0.8-0.85 mm. Ohio (Cincinnati), — Chas. Dury.....*micans* n. sp.

8 — Form slender, black, the antennae, legs and elytra dark red, the abdomen dark piceous, with the tip rufo-piceous; head convex, elongate, suboval, rounded behind, very sparsely punctured at the sides, the punctures coarse; oblique ocular grooves short; under surface with a few scattered coarse punctures, nearly smooth behind; prothorax elongate-oblong, with much rounded angles; dorsal series of 9-10 strongly marked punctures, the sublateral series curved, well defined, of 9-10 punctures; between the two and near the front margin there is a group of four punctures, also some near the front angles; elytra distinctly and sparsely but not deeply punctured almost in rows, Length 7.5 mm. Michigan (Detroit).....*gularis* Lec.

Group IV.

Closely resembles "*Xantholinus hamatus*," differing by the shorter frontal groove, by the gular sutures being effaced and the under surface of the head smooth between the punctures, instead of finely strigose; there are also some large punctures between the dorsal and sublateral series of the prothorax, which cause the latter series to appear irregular; the elytra are more strongly punctured and the punctures are not arranged in series; the body is testaceous-brown in color, with the head darker

and the dorsal series of the pronotum have 10-12 punctures. Length 4.0 mm. California (San Diego).....**nanus** Lec.

Some of the species vary greatly in size and are of unusually wide distribution; the measurements of length refer to individuals with moderate protrusion of the abdomen; in the case of more constant species, these measurements refer to an average example. The short reference to *fusciceps*, given by LeConte (Trans. Am. Ent. Soc., 1880, p. 172), will presumably have to be regarded as a description and the species is therefore attributed to that author, although its true status was wholly overlooked; it is by no means a variety of *emmesus* but a very distinct species; *fucosus* is allied to *fusciceps* but is also distinct and could not be confounded with it by any careful observer; it is the smallest species of the genus. The commonest and most widely diffused species are *obsidianus*, *hamatus* and *pusillus*; *oregonus* may be a recently evolved derivative of *hamatus*, to which it is evidently very closely allied and more specimens are much to be desired, in order to arrive at a more definite conclusion. *Gilvipennis* is an aberrant form, although satisfying all the generic characters of *Gyrohypnus*. The four species *temporalis*, *dimidiatus*, *gularis* and *nanus* are unknown to me in nature, and the above descriptions are derived from the published statements of LeConte. I formerly regarded *vernucatus* as the true *gularis*, but, as the cephalic and pronotal punctures of that form are by far the finest observable in the genus, constituting its most striking character, it would appear to be specifically different, since LeConte states that the punctures of *gularis* are coarse; there can be little doubt, however, that they belong to the same group, which, because of the absence of the post-ocular flattened line, so constant in all the other species, should be held to have subgeneric rank. It is probable also that *nanus* will constitute another subgenus, but I have no means of asserting this at present.

Duvivier (Cat. 1883), gave the name *floridæ* to *temporalis* Lec., because antedated by *temporalis* Shp., of Ega, South America; as however, *temporalis* Shp., has no discal pronotal series, it belongs to a genus unquestionably different from

Xantholinus or *Gyrohypnus*. The same author replaces *sanguinipennis*, of LeConte, by *lecontei*, because of *sanguinipennis* Kolen., of the Island of Crete, but, as the latter is a *Eulissus* and *sanguinipennis*, of LeConte, is a *Gyrohypnus*, the change of name is unnecessary.

Xestolinus n. gen.

In the formation of the sides of the head behind the eyes, fine arcuate gular sutures subuniting behind the middle of the post-oral surface and extremely minute, remotely scattered punctuation of the head, this genus approaches the third group of *Gyrohypnus*, as defined above, but it differs from any member of *Gyrohypnus* in its short, stout and rather compressed maxillary palpi, with the last joint obviously shorter than the preceding and very obtusely conical; also in its well developed, stout and compact antennae, with the second and third joints equal and elongate-obconic in form. The abdomen is very greatly developed, being nearly as wide as the elytra and conspicuously wider than the head and prothorax, giving the species a peculiar appearance, and the elytra are differently sculptured from those of the preceding genera. At present we have only discovered two species as defined below:—

Stout in form, moderately convex, polished throughout, the under surface of the head without trace of minute strigilation; prothorax, elytra and legs pale rufo-testaceous throughout, the second more flavate than the first; antennae rather more dusky, the head darker piceo-testaceous, clouded with blackish above, the abdomen piceous-black, not paler at tip; head oblong, distinctly elongate behind the antennae, the sides for some distance behind the eyes parallel and straight, then very broadly rounding into the base, the frontal grooves moderately long and deep, the oblique ocular fine and short; punctures minute and very widely dispersed, a narrow indefinite post-ocular longitudinal line, punctured more closely in two series, with a larger puncture behind the middle, the under surface finely, very sparsely punctate; prothorax fully two-fifths longer than wide, obviously narrower than the head, the sides distinctly converging from the well rounded apical angles, the apex arcuate; dorsal punctures very fine, 7-8 in number, the sublateral series much shorter, more close-set, arcuate, composed of about seven equally minute punctures; there are some also sparsely scattered toward the sides anteriorly; elytra rather elongate, fully as long as the prothorax

and very much wider, the punctures fine, impressed, very sparse throughout and sublinear in arrangement; abdomen finely, sparsely punctulate, more distinctly beneath. Length 8.0 mm.; width 1.3 mm. Arizona (Walnut),—H. F. Wickham.....**abdominalis** n. sp.

Similar in form to the last and similar in coloration, the integuments very highly polished; head oval in form behind the antennae, the frontal grooves distinct, the ocular terminating inwardly in a rather large punctiform pit, the punctures extremely minute and sparse, rather larger but quite as remotely separated beneath, the flanks evenly convex and without trace of the feebly flattened post-ocular streak of *abdominalis*; sides arcuate, merging gradually into the very broadly rounded basal angles; prothorax not so elongate and more broadly and feebly arcuato-truncate anteriorly, a third longer than wide and distinctly narrower than the head, the punctures rather more distinct, the dorsal series of 8-9, the arcuate sublateral of about seven, both series indistinct in apical third and fourth, the dorsal extending to basal fifth or sixth; there are some scattered punctures anteriorly and along the side margins as usual, and two large apical punctures and one at each basal angle bear each a very long tactile seta as in the preceding; elytra a little longer and very much wider than the prothorax, the punctures still more minute and indistinct than in *abdominalis*, very sparse throughout and faintly subserial in arrangement; abdomen very minutely, sparsely and feebly punctulate, only slightly more visibly so beneath. Length 8.9 mm.; width 1.28 mm. Utah (southwestern),—Weidt..**oviceps** n. sp.

These species without much doubt constitute a specialized type, confined to the arid regions of the Sonoran province; they have a peculiar facies which will render them easy to identify.

Lissohypnus n. gen.

The elongate third antennal joint is the chief character distinguishing this genus from the three preceding, and, in this respect, there is a reversion to *Eulissus* and related genera. In the united gular sutures, well developed head and form of the fourth palpal joint, *Lissohypnus* resembles *Xantholinus*. In the short third palpal joint, with much longer fourth joint, type of sculpture throughout and flattened post-ocular line, it resembles *Gyrophypnus*, but in antennal structure it differs very strikingly from either of those genera. The single species in my cabinet may be readily known by the following outline description:—

Stout, parallel, moderately convex, highly polished, black, the last two abdominal segments pale testaceous in color, the entire elytra and legs

pale and bright rufous, the antennae dusky rufous, paler toward base; head behind the antennae longer than wide, the sides parallel and straight, the angles broadly rounded and beginning at two lengths of the eye behind the latter; punctures coarse, deep and moderately close-set toward the sides, nearly as coarse but not quite so close-set beneath throughout, the interspaces not at all strigilate, the flattened post-ocular line distinctly defined, coarsely and closely punctured; antennae rather longer than the head, stout and compact distally, the tenth joint about three-fifths wider than long; prothorax about a third longer than wide, very little narrower than the head, the sides very feebly converging and somewhat uneven, the angles rounded; punctures strong, moderately coarse, the dorsal series of about ten, the sublateral of 7-9, both rather uneven and with numerous other strong punctures toward the apical angles; elytra barely as long as wide, about equal in length to the prothorax and only slightly wider, the punctures strong but rather sparse, arranged nearly as in *Gyrohypnus hamatus*; abdomen minutely, sparsely punctate, more distinctly beneath as usual, very slightly wider than the head. Length 8.0 mm.; width 1.38 mm. **Texas** (Austin).....**texanus** n. sp.

This is one of the larger and more conspicuous of our Xantholini, but is unfortunately represented by a single specimen thus far.

Leptacinus Erichs.

The type of this genus is assumed to be the European *parumpunctatus* Gyll., representing a radical departure from the preceding genera of the subtribe Xantholini in having the fourth palpal joint very slender and aciculate; it differs also in having the oblique ocular, as well as the frontal grooves, long and greatly developed and in type of elytral sculpture, the punctures being confusedly aggregated along the suture, but, from the medial series to the extreme lower margin of the flanks, having a linear arrangement. In the preceding genera the elytral punctures are apparently always confused throughout on the deflexed flanks. The pronotal punctures are peculiarly coarse, deeply impressed and always few in number. The flattened longitudinal line behind the lower part of the eyes is nearly as in *Gyrohypnus* and several other genera, though narrower, but here its lower margin is rendered apparently more prominent by reason of a feebly punctured eroded longitudinal groove at each side of the under surface, and the upper margin is more obtuse and less definite. We

have but two rather rare species which may be described as follows:—

Body rather stout, subparallel, convex, very highly polished, no strigulation or reticulation being observed at any part of the upper surface, or on the lower surface of the head and abdomen, piceous-black in color, the head rather darker, the elytra very pale, becoming gradually infumate in basal half, the legs and antennae pale; head not longer than wide behind the antennae, suboval, broadening basally, with the sides arcuate, the angles rather narrowly rounded; punctures very coarse, deep and rather close-set toward the sides, broadly wanting along the middle, the post-ocular flat line strongly and closely punctate in a double line along its middle only, the under surface with a few coarse elongate punctures, impunctate toward base; sutures arcuate, gradually becoming contiguous behind the middle, the space between them finely, very roughly sculptured and almost lustreless; antennae longer than the head, rather slender; prothorax but slightly elongate, about as wide as the head, the sides moderately converging and obviously arcuate throughout, the anterior angles very broadly rounded; dorsal series of about five, the sublateral of about four, very coarse, irregular and widely spaced punctures; between the latter series and the sides anteriorly there is a very large setigerous puncture; elytra ample, longer and much wider than the prothorax, the punctures of the medial series larger and more close-set than those of the lateral series and separated from the sutural punctures by a wide sculptureless space; abdomen finely, sparsely punctulate. Length 4.9 mm.; width 0.9 mm. New York (Hudson Valley).....**cephalicus** Lec.

Body stout, parallel, convex, nearly similar in sculpture to the preceding, black in color, the prothorax bright rufous, the elytra pale flavo-testaceous, somewhat diaphanous, clouded with black toward the suture, narrowly at apex, gradually more broadly basally and involving the entire width at base; legs pale, the antennae slightly darker, testaceous; head behind the antennae but slightly longer than wide, feebly inflated basally, the sides arcuate, the angles rounded, very broadly impunctate toward the middle, the punctures very coarse and distinctly close-set laterally, the flattened post-ocular line narrow, closely, confusedly and strongly punctate, becoming smooth near the edges; under surface coarsely, less closely punctate, the lateral grooves as in *cephalicus*; prothorax larger, nearly a third longer than wide, only very slightly narrower than the head, the converging sides nearly straight, the apical angles broadly rounded; dorsal series of about six punctures, rather smaller than in *cephalicus*, extending to basal fifth or less, the sublateral series short, of about four punctures; there is also a single isolated puncture between the anterior limit of the latter series and the side margin; elytra rather longer than wide, with slightly diverging straight sides, slightly wider than the prothorax, the suture evidently shorter than the latter, punctured nearly as in *cephalicus*; abdomen parallel, somewhat narrower than the elytra, punctured nearly as in the preceding. Length 5.0 mm.; width 0.9 mm. Kentucky and Missouri (St. Louis).....**rubricollis** n. sp.

The sexual characters in this genus are unusually pronounced, the male of *rubricollis* having the sixth ventral broader and evenly, rectilinearly truncate throughout its width at apex, the female having this segment rather narrower and more trapezoidal and broadly, feebly and angularly lobed at tip, the lobe not porrect but bent downward, with an attendant transversely lunate impression of the surface before it. In the female of *cephalicus*, which is the only sex at hand, the lobe of the sixth ventral is similarly very strongly bent downward, but it is here truncate and there is no impression of the segmental surface. In the female of *parumpunctatus* the lobe is nearly as in *cephalicus*, truncate at tip and bent down vertically, but it has a posterior median impression, which causes it to appear broadly bilobed in a line of sight from below perpendicular to the axial line of the body. *Cephalicus* is very closely allied to *parumpunctatus* but differs in its shorter, broader and more ovoidal prothorax; it is probably the species that has been mistaken for the latter by certain European observers.

Leptacinodes n. gen.

This genus, founded upon the European *Leptacinus batychrus* Gyll., and related species, differs from *Leptacinus* in the rather more conical form or relatively thicker base of the fourth palpal joint, less developed oblique ocular grooves, wholly obsolete lateral grooves of the under surface of the head, smaller and much more numerous punctures of the dorsal pronotal series and in its generally rather smaller and more fragile species, which seem to be more numerous and diversified. The prevalence of fine wavy strigilation on the head, pronotum and abdomen is also a distinguishing feature. The gular sutures are arcuate, gradually approaching each other posteriorly and become extremely approximate but scarcely coalescent behind the middle. The American species may be thus defined: —

- Under surface of the head finely strigilate in wavy lines; prothorax dark in color..... 2
 Under surface of the head smooth and polished, without strigilation; prothorax pale..... 3
 2 — Body larger and less slender, convex, polished, black, the abdomen

not paler at tip, the legs pale, the antennae dusky testaceous, the elytra translucent, pale flavate, gradually blackish toward base; head but slightly elongate, gradually broader to the rather narrowly rounded basal angles, the sides just visibly arcuate, the punctures not very coarse but deep, moderately close-set, wanting along the middle as usual; post-ocular flattened line distinct, closely and confusedly punctate, the punctures of the under surface small but strong, sparsely distributed, obsolescent basally; prothorax elongate, slightly narrower than the head, the dorsal series of 10-12 moderate, rather close-set punctures, the sublateral long and of nearly as many, with some others externally and anteriorly; sides distinctly converging and straight, the angles not very broadly rounded; elytra elongate, barely as long as the prothorax but evidently wider, the punctures numerous, broadly confused toward the suture, more or less lineate thence to the lower margin of the flanks, the first series deepest and most regular; abdomen at base much narrower than the elytra, gradually broadening behind, finely, sparsely punctulate. Length 4.7-5.0 mm.; width 0.75-0.8 mm. New York (Long Island), New Jersey and Iowa. [= *seriatus* Lec.] **flavipes** Lec.

Body small, slender, convex, polished, deep black throughout, the elytra scarcely visibly picescent; legs very dark rufous, the antennae blackish; head formed nearly as in *flavipes* but smaller and with rather more broadly rounded basal angles, the punctures strong and deep, though only moderately coarse and somewhat sparse toward the sides, almost equally strong beneath, tending to form two longitudinal series at each side, very inconspicuous medially and basally, the post-ocular flattened line biserially and rather strongly punctate; prothorax slightly elongate, fully as wide as the head, with the apical angles very broadly rounded, the sides thence moderately converging and nearly straight posteriorly; punctures of the dorsal series 8-10 in number, not very coarse but distinct, rather less numerous in the sublateral series, with a few isolated near the apical angles as usual; elytra elongate, longer and much wider than the prothorax, the punctures rather fine but distinct, forming equidistant and subeven series throughout the width, except very near the suture, the series on the upper convexity of the flanks usually most close-set; abdomen slightly narrower than the elytra, parallel, sparsely and feebly punctulate. Length 3.6-3.9 mm.; width 0.65-0.68 mm. Iowa, Wisconsin (Bayfield) and California (San Francisco).

nigritulus Lec.

♂—Form rather more slender than in *flavipes*, the size almost similar, highly polished throughout, the head black; abdomen very dark, the entire elytra paler, piceous, the prothorax and legs pale testaceous, the antennae darker, rufous; head well developed, slightly elongate, gradually and moderately broadening toward base, with the sides straight and the angles broadly rounded; punctures coarse and deep, somewhat close laterally, smaller but distinct and sparsely scattered on the under surface, which becomes impunctate toward the suture posteriorly and throughout the width in basal two-fifths, the post-ocular flat line distinct, confusedly and strongly, somewhat closely punctate throughout; prothorax distinctly elongate, obviously narrower than the head, the apical angles obtuse but not much rounded, the sides parallel and

straight thence to apical two-fifths, then distinctly converging to the base; punctures rather coarse, deep and approximate in the series, the dorsal of 11-12, the sublateral of 7-8, both unusually regular; there is also a coarse isolated puncture near the sides anteriorly; elytra elongate, longer and much wider than the prothorax, strongly punctured in even series throughout, except rather broadly and gradually more densely toward the suture; abdomen as in *nigritulus*. Length 5.2 mm.; width 0.76 mm. Colorado (Denver).— H. F. Wickham.

lustrans n. sp.

Testaceous, shining, the head and abdomen darker; head convex, elongate, slightly wider behind, coarsely and sparsely punctured toward each side, the frontal grooves long and deep; antennae not longer than the head; prothorax a third longer than wide, slightly narrowed behind, the base and apex rounded; dorsal series of six punctures, also with a curved sublateral row as usual; elytra distinctly punctured in series; abdomen sparsely and feebly punctulate. Length 2.2 mm. California (Fort Yuma).....**pallidulus** Lec.

I am unable to distinguish between the specimens in my cabinet, which were carefully compared with the original types of *flavipes* and *seriatus* and believe that they represent but one species. This is undoubtedly the form which has been identified as the European *batychnus*, but it is not the same, being much larger in size and of heavier build; it is however very closely allied to *batychnus*.* The species described by

* Under the name *batychnus*, I have lately received two distinct species from Mr. Reitter, one of which seems to be undescribed; it may be outlined as follows:—

Form very slender, only moderately convex, parallel, shining, the head deep black, the prothorax black anteriorly but gradually shading into a blackish-piceous posteriorly, the abdomen piceous and the elytra pale, diaphanous, flavate, shaded blackish toward base and narrowly toward the suture nearly to the tip; legs pale, the antennae dusky testaceous; head narrow, decidedly elongate, the sides very feebly diverging behind the eyes and straight for a long distance to the rounded basal angles; punctures small but deep, close-set toward the sides, the under surface finely strigilate, finely and sparsely punctate, the post-ocular line finely, closely and confusedly punctate, impunctate near its upper margin; prothorax narrow, much elongated, not quite as wide as the head, with dorsal and sublateral series of many small but distinct, close-set punctures, with a patch of confused punctures externally toward apex; elytra elongate, as long as the prothorax and evidently wider, punctured in even series except toward the suture; abdomen narrow, parallel, feebly punctulate. Length 3.8 mm.; width 0.58 mm. Europe (Caucasus).....**perexillis** n. sp.

Differs from *batychnus* in its much more slender form, narrower and more elongate head and prothorax and more linearly punctate elytra.

LeConte under the name *Leptacinus pallidulus* may or may not belong to this genus, as I have not been able to study it carefully; the very small size of the species renders the generic reference somewhat doubtful. The single specimen of *nigritulus* which was taken by the writer in the environs of San Francisco, is probably a fortuitous importation from the eastern part of the country, and whether or not it has since established itself in California is unknown to me at present.

Stictolinus n. gen.

We arrive here at a succession of genera differing rather conspicuously from any of those previously described, in having the pronotal punctures confused toward the sides, and, accompanying this peculiarity, there is a general loss of the flattened longitudinal line behind the eyes, although a vestige of it may be traced occasionally, as in the genus *Hesperolinus*, where its upper margin exists as a polished convex impunctate edge from the eyes to the basal angles. In the present genus there is scarcely a trace of the flattened line and the flanks of the head are convex from the upper to the under surface and continuously and evenly punctured. *Stictolinus* has the punctures more numerous and close-set than most of those that follow, with a narrower impunctate line along the middle of the head. The fourth palpal joint is usually a little longer than the third, very finely and gradually pointed but thicker at base or more conical than in *Leptacinus* and more like that of *Leptacinodes*; it is also rather strongly oblique as in that genus. The genus is peculiar in having no trace of the usual oblique ocular frontal grooves, but the median pair are impressed and distinct though rather short. The elytral punctures are confused in arrangement over the entire surface, except one regular series of more close-set punctures along the upper margin of the deflexed flanks, which series is bordered internally by an even, highly polished, impunctate line throughout the length; the punctures are generally somewhat more closely aggregated toward the suture and sparser on the median

parts, where there is sometimes a feeble suggestion of serial arrangement toward base. There is no trace of strigilation on the polished surfaces of the anterior parts and the gular sutures are as in *Leptacinus* and *Leptacinodes*. We have at least four species, which may be readily separated as follows: —

- Last joint of the maxillary palpi as long as the third or longer.....2
 Last joint distinctly shorter than the third; size larger.....4
 2 — Head large, the prothorax relatively smaller, very conspicuously narrower than the head; body slender, moderately convex, polished, black, the abdomen not paler at tip, the elytra rather distinctly, the prothorax more feebly, picescent; legs pale, the antennae blackish; head large, behind the antennae distinctly elongate, the sides parallel and nearly straight, the basal angles broadly rounded, the punctures strong and very close-set throughout, the median smooth line very narrow, subobliterated toward base, the under surface rather less strongly and less densely punctate; prothorax small, elongate, with the sides rather feebly converging posteriorly throughout and straight or feebly arcuate, the angles obtusely but not very broadly rounded; punctures similar to those of the head but somewhat less close-set, the broad median smooth line clearly and evenly delimited; elytra longer than wide, somewhat shorter than the prothorax but distinctly wider though not quite as wide as the head, the punctures fine but deep, rather close-set, the punctuation broadly confused toward apex and suture; abdomen parallel, minutely, rather inconspicuously punctulate. Length 4.5 mm.; width 0.78 mm. California (coast regions north of San Francisco).

grandiceps Lec.

- Head moderately developed, never more than slightly broader than the prothorax, the latter relatively larger, similar in coloration to *grandiceps* but with the prothorax and elytra about equally, and both feebly, piceous, the former sometimes rather paler.....3
 3 — Elytra only slightly shorter than the prothorax; body parallel, similar in form and sculpture to *grandiceps* but with the head rather more elongate behind the antennae, the prothorax similar in form but less closely punctate, particularly toward base; elytra and abdomen relatively stouter, similarly sculptured. Length 4.5-5.0 mm.; width 0.75-0.8 mm. California (Truckee and Siskiyou Co.).....*aequalis* n. sp.
 Elytra much shorter than the prothorax; body very slender, parallel, black, the elytra and prothorax more or less distinctly piceous in color, the legs pale as usual; head moderate in size, distinctly elongate behind the antennae, the sides parallel and very feebly arcuate, the basal angles well rounded; punctures strong and dense, giving an opaque appearance, the median smooth line very narrow; prothorax well developed, narrower and more elongate than in *aequalis* but otherwise similar, still less obviously narrower than the head, the punctures strong and usually close-set but uneven in distribution; elytra and abdomen much more slender than in *aequalis*, the former somewhat longer than wide but

only just visibly wider than the prothorax, distinctly and rather closely punctured as usual. Length 3.8-4.5 mm.; width 0.55-0.65 mm. Massachusetts, New York and Pennsylvania to Iowa and Wisconsin (Bayfield).....*scolopacea* n. sp.

- 4 — Body much stouter than in the preceding species, black, the elytra feebly piceous, the prothorax scarcely visibly less than black; legs pale, the antennae blackish; head well developed, evidently elongate behind the antennae, the latter distinctly longer than the head; sides subparallel and nearly straight, the basal angles rounded; punctures rather fine but deep, only moderately dense, separated by about their own diameters; prothorax less elongate, with the sides rather strongly converging, distinctly narrower than the head, the punctures fine but deep and less close-set than usual; elytra large, longer than wide, fully as long as the prothorax and much wider, obviously wider than the head, the punctures small but deep, close-set and confused almost throughout; abdomen parallel, finely and inconspicuously punctulate. Length 5.4 mm.; width 0.9 mm. California (Lake Co.), — Chas. Fuchs.

franciscanus n. sp.

The rather small and monotonous members of this genus may prove to be rather numerous in the colder parts of the Pacific coast faunal province, largely replacing the genus *Hesperolinus*, which is somewhat more developed in the southern coast region. The eastern *scolopacea* is abundant and widely diffused but appears to have been overlooked by the older authors.

Habrolinus n. gen.

The single very small and slender species constituting this genus bears considerable superficial resemblance to the eastern *Nematolinus longicollis*, especially in its strongly incrassate antennae, with very transverse and compactly joined distal joints and elongate second joint, but, besides the distinguishing character of the maxillary palpi, the present genus differs in having the prosternum before the coxae as in all the preceding genera of this subtribe and not narrowed by the intrusion of the somewhat dilated anterior part of the hypomera, characterizing, if not peculiar to, *Nematolinus* and *Lithocharodes*. It seems necessary therefore to propose a separate genus for this obscure though interesting form. The virtually obsolete median frontal grooves and correspondingly distinct and conspicuous oblique ocular grooves, constitutes a very remarkable feature. The prosternum is gradu-

ally strongly tumescent toward the median line. The type may be described as follows: —

Body very slender, convex, shining, absolutely parallel, all the segments being equal in width, the head perhaps just visibly wider, pale and almost uniform testaceous throughout, the legs and antennae concolorous; head longer than wide, the sides parallel, the basal angles very broadly rounded; flanks evenly convex, without trace of flattening behind the eyes, the latter well developed as usual; punctures minute, sparse and inconspicuous, rather stronger but still sparser beneath, the under surface very obsoletely strigilate, the space between the sutures polished and sculptureless; antennae one-half longer than the head, the basal joint three-fifths as long as the remainder; prothorax elongate, with the sides almost parallel and very feebly arcuate, gradually rounding anteriorly to the apex, the angles almost obliterated; base arcuately subtruncate, with the angles much less rounded; side margins strongly acute to the apex; punctures coarser than those of the head but still sparser; elytra small, fully as long as wide, very much shorter than the prothorax but of equal width, the punctures fine but strong, evenly and rather sparsely distributed throughout, without trace of lineal arrangement; abdomen at base as wide as the elytra, gradually very slightly wider thence to the fifth segment, which is unusually elongate, almost equalling the two preceding combined, the surface unusually convex throughout and duller than the rest of the upper surface, being minutely but strongly reticulate, also finely but asperulately and sparsely punctate. Length 3.7 mm; width 0.6 mm. California (Lake Tahoe).

tahoensis n. sp.

It is possible that this species may occur under pine bark, though I made no notes relating to its capture.

Nematolinus n. gen.

This genus and the next constitute a rather isolated group, having the prosternum narrower between the anterior parts of the hypomera and strongly incrassate and compact antennae; in the latter, however, as well as in the form of the maxillary palpi, they both agree with the preceding genus, which might with propriety be placed in the same group. In the present genus the frontal grooves are all but completely obsolete and the oblique ocular lines, unlike those of *Habrolinus*, are wholly obsolete. The gular sutures are peculiar, being feebly arcuate, widely separated anteriorly and gradually approaching each other, not becoming very approximate except just before the base, the intermediate surface polished

and impunctate. The sculpture of the head also seems to be confined to the genus, there being on the interspaces of the under surface a system of close-set but unevenly distributed exceedingly minute nude punctules, visible toward the sutures only and sometimes almost obsolete; on the upper surface these densely aggregated punctules, which are entirely distinct from the ordinary punctures, form two very large subopaque patches involving the entire anterior half and separated by a smooth polished line. The antennae are very similar to those of *Habrolinus* and the maxillary palpi are of the same type as in that genus and the one following, except that here and in *Lithocharodes* the third joint is more developed, the oblique fourth joint being relatively much shorter. The abdomen in *Nematolinus* is not minutely reticulate but is unusually punctate. The head is completely unmodified and evenly convex behind the eyes throughout, in which character it differs somewhat from *Lithocharodes*. *Nematolinus* is evidently closely allied to *Somoleptus* Shp., of the neotropics, but appears to differ in the system of cephalic and elytral sculpture, and, as the rather numerous species of *Somoleptus* described by Dr. Sharp will ultimately prove, in all probability, to be assignable to several genera, I leave *longicollis* Lec., in the special genus here proposed for it. The tibiae in *Nematolinus* are certainly spinulose to some extent, whereas in *Somoleptus* the legs are said to be slender and destitute of spinules. Our single species is of wide northern range, apparently not occurring in the subtropical parts of the country and may be characterized as follows:—

Very slender, moderately convex, parallel, polished, pale piceous, the head somewhat darker, the legs and antennae pale; head elongate, subparallel or feebly enlarged toward base, with the angles very broadly rounded, the punctures fine but strong and rather close-set; antennae much longer than the head, the basal joint evidently more than half as long as the remainder; prothorax one-half to three-fifths longer than wide, just visibly narrower than the head, the sides almost evenly arcuate from the neck to behind the middle, then very feebly converging and straight to the moderately rounded basal angles, the punctures fine but deeply impressed and close-set; elytra slightly longer than wide, much shorter but evidently wider than the prothorax, minutely, evenly and somewhat closely punctate, the punctures arranged without order;

abdomen subparallel, slightly narrower than the elytra, finely but strongly, asperately and closely punctured throughout, the fifth segment subequal to the two preceding combined. Length 3.2-4.2 mm.; width 0.6-0.68 mm. Rhode Island and Pennsylvania to Iowa and Missouri.

longicollis Lec.

There may be some subspecies of the type form represented among the numerous specimens before me, but I have been unable to definitely limit them. Some examples have virtually no minute ground sculpture on the under surface of the head, while in two specimens from Missouri this sculpture is very conspicuous. LeConte states that the species is usually found in ants' nests, but it is apparently not a true inquiline.

Lithocharodes Shp.

In most of its characters, including palpal structure, this genus is allied closely to the two preceding as before intimated, but there are several features which strongly differentiate it from either of them. The antennae, though compact and strongly incrassate distally, have the third joint unusually elongate as well as the second, a departure in the direction of *Leptolinus*, and, behind the lower part of the eyes, there is a longitudinal area which is unmistakably flattened as in *Gyrohypnus* and allies, although here the area is not so distinctly defined; again, the acute lateral margin of the prothorax is strong and distinct to the apex in *Nematolinus* but here it gradually becomes very feeble anteriorly though not obliterated as is the case in *Leptolinus*. The gular sutures differ greatly from those of the two preceding genera in rapidly approaching each other and becoming parallel and very approximate from a point before the middle to the base. The integuments are highly polished, without minute ground sculpture to any noticeable extent, the third palpal joint of the same general form as in the two preceding genera, but the fourth joint is relatively shorter, oblique and acutely pointed though evidently conical and not extremely slender and aciculate, and the anterior angles of the prothorax are not obliterated. The median frontal grooves are moderately de-

veloped and much more distinct than in either of the preceding, and, in this as well as the more conical fourth palpal joint, it leads gradually to the two following genera; the oblique ocular grooves are obsolete as in *Stictolinus*. *Lithocharodes* is widely distributed in the tropical and subtropical regions of North America, from southern Louisiana to South America. From Nicaragua it is represented in my cabinet by a species closely allied to *ruficollis* but with much sparser punctuation, named *fuscipennis* by Sharp, — (Tr. Ent. Soc. Lond., 1876, p. 205). It was described originally from the Amazons, but is widely distributed and the type of the genus.

Dr. Sharp seems to have mistaken the female sexual characters in this genus for male, in remarks in the *Biologia* under such Central American species as *spinigera* and *armata*. The more acute abdominal apex characterizes the female, the more obtuse the male. The species are numerous but only three have thus far occurred within our extreme southern limits; these may be distinguished as follows: —

Elytra and abdomen more or less pale piceous in color, the prothorax and legs paler and the head and antennae dark, rufo-testaceous; body larger and rather stouter, subparallel, somewhat convex, polished throughout; head large and elongate, very gradually dilated toward base, with the sides feebly arcuate, the angles broadly rounded; punctures not very large but deep and close-set, with a narrow median smooth line, rather coarser and less close-set but conspicuous on the under surface, which is not reticulate or strigilate; antennae somewhat longer than the head, with the basal joint almost three-fourths as long as the remainder; prothorax one-half longer than wide, very much narrower than the head, the sides from the rounded anterior angles to the base very strongly converging and nearly straight; punctures rather small but deep and distinct, somewhat close-set; elytra elongate, evidently shorter but wider than the prothorax, narrower than the head, the punctures fine, uniformly but nonserially, rather closely distributed throughout; abdomen narrower than the elytra, parallel, polished, minutely and rather closely but inconspicuously punctured throughout, the fifth segment much shorter than the two preceding combined as usual. Length 5.8 mm.; width 0.8 mm. Texas (Austin).

pallidus n. sp.

Elytra and abdomen black to piceous-black, the head and prothorax paler though dark piceo-rufous; legs very pale, the antennae more dusky, rufous; body rather smaller and notably more slender than in *pallidus*; head narrower, relatively more elongate behind the antennae, somewhat

more coarsely and closely punctured, with a narrow impunctate median line; antennae stout distally, the third joint elongate but evidently shorter than the second; prothorax narrower, much elongated, the sides quite as strongly converging posteriorly but more parallel anteriorly, distinctly narrower than the head as well as the elytra, similarly punctured; elytra elongate, shorter but distinctly wider than the prothorax, equal in width to the head; abdomen at base narrower than the elytra, the sides straight, gradually diverging to the fifth segment which is as wide as the elytra or head, finely, rather sparsely punctulate. Length 5.0 mm.; width 0.68 mm. Louisiana.....**nigripennis** Lec.

Elytra and abdomen piceous-black to black, the hind margin of the former pale testaceous for a fifth or sixth of the length, the prothorax and legs very pale, the head and antennae dark, testaceous; head less developed, elongate, gradually broader toward base, the angles broadly rounded; punctures rather fine but deep and very close-set; prothorax nearly as in *pallidus*, but rather less elongate and less evidently narrower than the head, the sides equally strongly converging posteriorly, the angles equally rounded, the punctures very fine and notably sparser; elytra elongate, evidently shorter and much wider than the prothorax, the punctures very fine and sparse, not at all serial; abdomen nearly as in *nigripennis*. Length 3.7-4.5 mm.; width 0.63-0.7 mm. Texas (Galveston) and Louisiana.....**ruficollis** Lec.

None of my examples of *pallidus* have the elytra darker than a rather pale piceo-testaceous tint and similar in color to the abdomen, and the species differs in this way from *nigripennis*, as well as by its larger size, rather stouter form and larger and broader head.

Hesperolinus n. gen.

The third joint of the maxillary palpi resumes here its usual form, being slightly thickened apically and narrowed basally, less compressed than in the three preceding genera and more elongate, the slender though evidently conical fourth joint being about one-half as long as the third, and strongly oblique in insertion. As in the preceding genus there is a suggestion of the flattened longitudinal line behind the eyes, which is here tolerably well defined above by the convex polished post-ocular line but very indefinitely so along its lower margin. The prosternum also resumes its usual wide unstricted form, the hypomera being normally narrow anteriorly and the lateral edge of the pronotum is fine but distinctly acute to the tip. The antennae are nearly of the

type prevailing in *Gyrohyppus* and *Xantholinus*, the gular sutures as in the former of those genera and the medial and ocular frontal grooves are all evident, although the median pair are much shorter and feebler than in *Gyrohyppus*. The neck is notably narrower than in that genus, being but little more than a fourth as wide as the head. The punctures are usually small but distinct and rather close-set on the head, those of the elytra being fine and evenly spaced, though irregularly arranged throughout. The remarkable sexual characters of the female have been alluded to by the writer (Bull. Cal. Acad. Sci., 1886, p. 261 and plate), that sex having the sixth ventral prolonged into a very slender spine curving upward beyond the tip of the abdomen in at least two species alluded to below, and, leading up to this peculiar formation, it may be stated that in the genus *Nematolinus*, described above, as well as in *Hesperolinus piceus*, the female has the tip of the sixth ventral strongly and acutely angulate, it being broadly rounded or parabolic in the male, as is also the case in the present genus as a rule. The females seem to be much less abundant than the males. The species of *Hesperolinus* are rather numerous on the Pacific coast, those at hand being separable by the following characters: —

- Second antennal joint subequal in length to the third, both distinctly elongated; female usually with the sixth ventral prolonged into a slender spine.....2
- Second antennal joint evidently longer than the third, elongate, the latter sometimes much abbreviated; female having the sixth ventral slightly prolonged and acutely angulate at the middle, at least in *piceus*..... 6
- 2 — Male having the apex of the sixth ventral broadly subangulate, with the angle broadly rounded and not noticeably produced..... 3
- Male having the apex of the sixth ventral more or less narrowly and strongly lobed in the middle, the lobe evenly rounded at tip..... 5
- 3 — Prothorax dark in color, black or blackish, always darker than the elytra. Body rather stout, subparallel, blackish-piceous in color, the head black and the elytra generally slightly paler, piceous; antennae dusky, the legs paler, rufous; integuments shining; head well developed, much longer than wide behind the antennae, the sides parallel and nearly straight or feebly diverging basally, the angles broadly rounded; punctures not very coarse but deep, close-set and conspicuous, still denser toward the eyes, rather narrowly wanting along the middle, smaller but close-set on the under surface and flanks, the convex longitudinal post-ocular line distinct; antennae but little longer

than the head, stout, the subapical joints transverse; prothorax narrow, fully one-half longer than wide, very much narrower than the head, the sides rather strongly converging, the angles distinct but rounded, the punctures fine and rather sparse; elytra somewhat elongate, barely as long as the prothorax but much wider, rather wider than the head, finely, evenly, rather sparsely and irregularly punctate; abdomen but little narrower than the elytra, much wider than the prothorax, minutely, sparsely punctulate toward the sides. *Female* with the sixth ventral medially prolonged into a very slender spine curving upward behind the abdomen, with its tip very fine and not at all expanded. Length 6.4 mm.; width 0.92 mm. California (Sonoma to Monterey). [= *brunnescens* Lec.].....**parvus** Lec.

Prothorax pale in color, either partially or wholly..... 4

4 — Body smaller and more slender, moderately convex as usual, the head and abdomen deep black, the latter not paler at tip, the elytra rather pale and uniform piceous-brown throughout, the prothorax pale testaceous, clouded with a blackish oblique streak from the centre to each apical angle and more narrowly along the median line posteriorly for a short distance; legs pale, the antennae dark, rufous; head moderate in size, parallel, the sides feebly arcuate, the angles broadly rounded; surface behind the antennae but little longer than wide, deeply and perforately, not very coarsely but closely punctate, the median impunctate line rather wide, the under surface similarly but less closely punctured; post-ocular polished line distinct; antennae only moderately thick; prothorax scarcely a third longer than wide, much narrower than the head, the sides straight and only feebly converging, the apical angles distinct and but narrowly rounded; punctures small but very strong and distinct, more or less sparse and irregular in distribution, sometimes unevenly lineate in arrangement, especially toward base; elytra much elongated obviously longer and much wider than the prothorax, wider than the head, finely but unusually strongly, rather sparsely and unevenly punctured; abdomen but little narrower than the elytra, inconspicuously and sparsely punctulate. *Female* unknown. Length, 5.5 mm.; width 0.82 mm. California (southern), — H. C. Fall.

bicolor n. sp.

Body much larger and stouter, subparallel, convex, shining, pale testaceous in color throughout, the legs concolorous, the antennae slightly darker, the abdomen sometimes slightly piceous and the head occasionally with an indefinite blackish vertexal cloud; head well developed, subparallel or feebly dilated basally, with the angles well rounded as usual; antennae thick; punctures not very coarse but perforate, close-set and conspicuous, the median impunctate line decidedly narrow; under surface strongly but rather sparsely punctured, the basal half impunctate; obtuse polished line behind the eyes distinct and normal; prothorax nearly one-half longer than wide, much narrower than the head, the sides distinctly converging throughout and nearly straight, with the apical angles obtuse but distinct and slightly rounded; punctures fine but rather strong, unevenly distributed, irregular, sparse basally, denser apically; elytra about as long as wide, much shorter but somewhat distinctly wider than the prothorax, equal in width to the head, finely but strong-

- ly, rather closely and unevenly punctate; abdomen almost as wide as the elytra, finely, rather sparsely punctulate. *Female* unknown. Length 6.8 mm.; width 1.0 mm. Nevada (Reno).....**alticola** n. sp.
- 5 — Moderately large and stout, piceous-brown, the elytra notably paler, the head black; legs very pale piceous, the antennae fusco-testaceous; head slightly dilated toward base with the sides broadly arcuate, much longer than wide behind the antennae, the basal angles broadly rounded; neck fully one-third as wide; antennae and punctuation nearly as in *parvus*, the latter rather less close-set; prothorax two-fifths to one-half longer than wide, much narrower than the head, the punctures strong and rather close-set, somewhat sparser posteriorly; sides rather strongly converging and almost straight, the angles obtuse and well rounded; elytra elongate, as long as the prothorax but much wider, somewhat wider than the head, the punctures fine but strong, rather sparsely and evenly distributed without order throughout; abdomen gradually slightly wider from base to apex, the former much narrower than the elytra, the punctulation fine and inconspicuous, the surface polished as usual; apices of the segments beneath nubilously paler. *Female* with a long and very slender spine projecting from the middle of the sixth ventral and curving upward behind the end of the abdomen as in *parvus*, except that here the tip of the spine is minutely expanded, with the apex of the enlargement truncate, and not acuminate as it is in that species. Length 6.0 mm.; width 0.85-0.88 mm. British Columbia (Victoria),— H. F. Wickham.....**borealis** n. sp.
- Much smaller and more slender, parallel, polished throughout, the head paler, the abdomen darker, piceous, the later almost black and not paler at tip, the prothorax, elytra and legs pale rufous, the antennae dusky testaceous; head behind the antennae distinctly elongate, parallel with the sides nearly straight, the angles well rounded as usual; punctures moderately coarse, perforate, close-set laterally, gradually sparser medially, the impunctate line rather broad, smaller but deep and sparser beneath and wanting toward base, the tamescent polished line behind the eyes distinct as in the preceding species; antennae only moderately stout and distally incrassate, much longer than the head; prothorax one-half longer than wide, much narrower than the head, the sides moderately converging and nearly straight, the angles obtuse and rounded; punctures distinct but sparse, very irregularly distributed; elytra small, longer than wide but obviously shorter than the prothorax and slightly wider, not quite as wide as the head, the punctures unusually strong and only moderately sparse; abdomen fully as wide as the elytra, feebly and sparsely punctulate. *Female* wanting, the lobe of the sixth ventral in the male much more narrowly rounded than in *borealis*. Length 4.7 mm.; width 0.68 mm. California (Los Angeles Co.), — H. C. Fall.....**pomona**e n. sp.
- 6 — Sixth ventral of the male produced at the middle in a rather narrowly rounded lobe; pronotal punctures rather coarse and conspicuous though very sparse and almost wholly wanting near the sides toward base. Body very slender, parallel, shining, rufo-piceous in color, the head and most of the pronotum, as well as the abdomen, frequently blackish, the elytra always paler; legs pale, the antennae dusky; head

moderate in size and elongation, subparallel, the sides feebly arcuate, the angles rounded; antennae much less developed than in *piceus* and less thickened, the third joint obconical and less conspicuously shorter than the second; punctures rather small and unusually sparse above and beneath, the polished punctureless post-ocular line well developed; prothorax scarcely two-fifths longer than wide, noticeably narrower than the head, the sides strongly converging and nearly straight throughout, the apical angles obtuse but very distinct and only slightly rounded; punctures somewhat larger than those of the head; elytra but little longer than wide, obviously shorter than the prothorax but distinctly wider, scarcely visibly wider than the head, the punctures strong like those of the prothorax and rather sparse; abdomen about as wide as the elytra, inconspicuously and very sparsely punctulate. *Female* unknown. Length 4.6–5.1 mm.; width 0.68 mm. California (San Diego Co.,— Coronado).....*angustus* n. sp.

Sixth ventral of the male broadly and feebly angulate at tip, the angle broadly and obtusely rounded; pronotal punctures very fine, sparse and inconspicuous. Body very slender, subparallel, shining, dark rufopiceous throughout, the head black; legs pale, the antennae dark, rufous; head distinctly elongate, very feebly inflated toward base with the sides somewhat arcuate, the angles very broadly rounded; punctures strong and very close-set laterally, wanting along the middle, the post-ocular polished line distinct; under surface strongly, rather closely punctured, subimpunctate basally; antennae notably thick, much longer than the head in the male, less conspicuously so in the female, the third joint of the former not quite as long as wide, obtrapezoidal with rounded sides, about as long as wide in the latter sex; prothorax small, much narrower than the head, elongate, the sides feebly converging posteriorly, the apical angles very broadly rounded and almost completely obliterated; elytra small, quadrate, a little shorter but much wider than the prothorax, rather distinctly wider than the head, finely, sparsely and inconspicuously punctate; abdomen toward tip as wide as the elytra, a little narrower toward base, very finely, sparsely punctulate. *Female* with the apex of the sixth ventral produced and very acutely angulate at the middle, the surface at the angle bearing a small dense tuft of recumbent pale hairs. Length 4.6–5.2 mm.; width 0.75 mm. California (Siskiyou Co.)...*piceus* n. sp.

In the male of *piceus* the third joint of the maxillary palpi becomes somewhat shorter and more strongly thickened apically than usual, with the fourth joint normal in form but correspondingly elongate, being about three-fourths as long as the third; this, coupled with the almost obsolete apical angles of the prothorax, notably short third antennal joint and pointed, rather than spinose, sixth ventral of the female, seems to indicate a subgeneric departure in the direction of *Habrolinus*, but, at the same time, the female of *piceus*

seems to have almost normal maxillary palpi, which may prove that these organs are malformed in the single male before me, for it does not seem possible to assume any specific difference between the assumed male and female described above. I cannot distinguish *parvus* Lec., from the subsequently described *brunnescens*, and have therefore placed the latter in synonymy.

Leiolinus n. gen.

While agreeing closely with *Hesperolinus* in general structure of the head, antennae and palpi, and especially in possessing the same polished and impunctate convex longitudinal line behind each eye, this genus departs in so many characters and particularly in its much larger but even prosternum, wholly devoid of any trace of the medial carina so conspicuous in *Hesperolinus*, that there can be but little doubt of its real generic isolation. The third and fourth palpal joints, in regard to their relative lengths, are nearly as in the preceding genus, but here the fourth joint is inserted more axially and appears to be only feebly oblique; the frontal and ocular grooves of the head are nearly similar but the antennae are longer, looser and more slender, and the sculpture throughout is very minute and feeble, in marked contrast to *Hesperolinus*. The head above and beneath is very minutely strigilate in wavy lines, which are partially disintegrated into fine reticulations; the pronotum is less finely but usually more feebly strigilate in more entire wavy lines, the elytra smooth and polished between the punctures, which are small but strong, evenly though unsystematically distributed and rather close-set and the abdomen is minutely but rather strongly and very closely strigilate in wavy transverse lines, the punctures being very minute, sparse, feeble, evenly distributed and transversely sublineate in form. The gular sutures are arcuate, widely separated anteriorly, but, well before the middle, become extremely approximate and parallel to the base; they are excessively fine and feeble. In the form of the posterior margin of the prosternum beneath the coxae, *Leiolinus* stands alone in the tribe as far as I have

been able to observe. There are two species represented in the material before me, readily separable as follows: —

Form stouter; antennae with the second and third joints relatively more slender and much more elongate, equal in length, the third much longer than wide, very strongly obconic and only half as wide at base as at apex; body piceous-black, the head deep black, the elytra paler piceous and the legs somewhat paler, the tarsi pale; antennae dusky rufous, much longer than the head, scarcely at all incrassate distally, with the basal joint about as long as the next three combined, the tenth but slightly transverse; head well developed, much elongated behind the antennae, only moderately convex, very feebly dilated toward base with the sides nearly straight, the angles broadly rounded and the eyes small; neck but little more than a fourth as wide as the head; punctures very fine and well separated, wanting along the median line as usual, still finer, sparser and very inconspicuous on the under surface; polished convex edge behind the eyes rather prominent; prothorax fully one-half longer than wide, distinctly narrower than the head, the sides rather strongly converging and nearly straight throughout, the apical angles distinct and narrowly rounded; punctures fine but distinctly impressed, sparse, uneven in distribution; elytra scarcely visibly longer than wide, somewhat shorter than the prothorax but much wider and evidently wider than the head; abdomen parallel, but little narrower than the elytra. Length 8.0 mm.; width 1.15 mm. Utah (southwestern), — Weidt..... *uteanus* n. sp.

Form more slender and parallel, polished, almost uniform piceous-brown throughout, the legs but little paler with the tarsi pale yellow, the antennae dark piceo-rufous, shorter and thicker than in *uteanus* though still evidently longer than the head, the second and third joints less elongate and relatively much thicker, equal in length, the third but very slightly longer than wide and much less strongly and evenly obconic than in the preceding, the basal joint shorter and thicker but, in like manner, equal in length to the succeeding three combined; head relatively broader and not so evidently elongated behind the antennae, just visibly dilated basally, the angles more broadly rounded than in *uteanus*, the punctuation almost similar but sparser, almost effaced on the under surface; prothorax shorter and broader, the sides and punctures almost similar, distinctly narrower than the head, with the apical angles more broadly rounded; elytra much narrower than in *uteanus*, distinctly elongate, nearly as long as the prothorax but only slightly wider and barely as wide as the head; abdomen parallel, about as wide as the elytra. Length 7.8 mm.; width 1.6 mm. Nevada (Elko), — H. F. Wickham..... *tarsalis* n. sp.

In both of the unique types of the above species the sixth ventral is very broadly and obtusely, parabolically rounded at tip and they are in all probability males. The acute side margin of the prothorax continues to the apex but becomes

very feeble anteriorly, in this character leading onward to the next genus, where the side margin differs from that of any of the preceding genera in becoming wholly obliterated anteriorly.

Leptolinus Kr.

This genus differs greatly from any of those which precede in having the anterior tarsi very strongly dilated and clothed beneath with a dense whitish pubescence, and it may be distinguished also by the density of the sculpture, particularly of the head, where even the polished impunctate median area of the other genera disappears; the abdomen is rendered alutaceous by the close-set minute punctulation. The prosternum is long in front of the coxae as in *Leiolinus* and is not carinate, though feebly tumid at the middle posteriorly, and is somewhat narrowed by the hypomera anteriorly reminding us of *Lithocharodes*. The female differs but little from the male in general appearance, though usually rather smaller and with the elytra relatively somewhat more elongate, but the third antennal joint is slightly shorter than the second and about as long as the next two combined and the sixth ventral is rather strongly but evenly parabolic at tip; in the male that segment is transversely truncate, and, as usual in most of the preceding genera, the male is much more abundant than the female. The very narrow interstices between the punctures of the under surface of the head are rendered somewhat dull by a very minute reticulation, which, on the upper surface as well as on the pronotum, assumes the form of very fine and obsolescent wavy longitudinal strigilation; the abdomen is minutely, closely and more strongly strigilate in wavy lines which have the usual transverse direction. Our single species may be described as follows: —

Form subparallel, only moderately convex, black, the abdomen piceous along the side margins; elytra bright red, black along the basal margin throughout the width; legs very pale, the antennae only slightly less pale, rufous throughout; head large, oblong, much elongated behind the antennae, the sides parallel and very slightly arcuate, the surface dull and very strongly, densely punctate, the punctures elongate and somewhat interlacing above, almost equally dense but more even be-

neath; antennae much longer than the entire head, the basal joint alone exceeding half that length, the outer joints incrassate and compactly joined, the tenth almost twice as wide as long; prothorax nearly three-fourths longer than wide, very much narrower than the head, the sides only feebly converging, the apical angles broadly rounded, the punctures small but deep, circular, close-set but evidently separated, the interspaces polished, the impunctate median line moderate in width and well defined; elytra elongate, equal in length to the prothorax though much wider, but not quite as wide as the head, finely but strongly, unusually closely punctate; abdomen parallel or very nearly so, slightly narrower than the elytra. Length 5.3-6.0 mm.; width 0.8-0.85 mm. Ohio (Cincinnati), Iowa and Texas (Galveston).

rubripennis Lec.

Differs from the European *nothus* Er., in its larger size and somewhat stouter form, larger and more elongate, red elytra, which in that species are much shorter than the prothorax and piceous-black throughout, in its more strongly incrassate antennae with still more elongate basal joint and in the male sexual characters, the tip of the sixth ventral being broadly sinuate toward the middle and not rectilinearly truncate. The apex of the abdomen is rufous in *rubripennis* but not noticeably paler in *nothus*.

Microlinus n. gen.

But little can be said of this genus at the present time, as the original type is a unique in very fragile condition. The description given by Dr. LeConte is as follows: —

Very small, slender, pale yellow, shining; head rather convex, nearly twice as long as its width, smooth, with a few small scattered punctures each side; sides nearly parallel, the base truncate; hind angles narrowly rounded; under surface very sparsely punctured; prothorax not longer or narrower than the head, with a few scattered punctures each side; elytra sparsely, finely punctured, the sutural stria very fine; abdomen sparsely punctured and pubescent. Length less than 2 mm. South Carolina (Columbia), — Dr. Zimmermann.....**pasio** Lec.

The remarks under this description state that the palpi, antennae and front tarsi are just as in *Leptolinus rubripennis*, but that whether the middle coxae are separate or contiguous cannot be determined on account of the condition of the type. That the genus is different from *Leptolinus* admits

of no doubt, although it is possible that the geographical locality may be erroneous.

Oligolinus n. gen.

The same remark applies to this genus as to *Microlinus*, as stated above, and nothing is known of the unique type beyond that already published by LeConte. The original description is as follows: —

Subcylindrical, brown, shining, slightly hairy; head twice as long as wide, convex, narrower in front, the base truncate, the hind angles strongly rounded; upper surface distinctly but not densely punctured, with a broad smooth frontal stripe; under surface sparsely, coarsely punctured; antennae paler, a little longer than the head, the outer joints gradually much wider; prothorax as long as the head but not narrower, distinctly but not densely punctured, with a broad smooth dorsal stripe; elytra sparsely punctured, the sutural stria obsolete; abdomen finely, not densely punctulate, the tip and legs paler. Length 2.4 mm. Florida (Enterprise).....**floridanus** Lec.

Mr. Schwarz, who captured the original type, states that the only specimen of what Dr. LeConte described as *Metoponcus floridanus*, was found by him in the galleries of a *Tomicus* (*Ips*) in the bark of yellow pine in 1875. It was sent to LeConte as a new species of *Leptacinus*, but has never been found again as far as known. All that he can say from recollection is that the species may not be a true *Metoponcus*.

Subtribe **Othii**.

The normal elytral suture, more widely separated antennae and broad and subobsolete epistoma, are the only really important characters distinguishing the Othii from the Xantholini, but here the middle coxae are contiguous and the anterior tarsi dilated as a rule, while in the Xantholini these characters are the marked exception; in addition to this, the sides of the head behind the eyes are never modified as they frequently are in the Xantholini. The sides of the prothorax are nearly as in *Xantholinus* throughout, but the gular sutures are more separated and more deeply impressed as a rule, feebly arcuate and gradually converging to the base of the

head, where they are most approximate, though nearly always clearly separated. The anterior tarsi are dilated in all the genera, but to a very variable degree, even within the same genus, and the basal joint of the usually slender hind tarsi is somewhat longer than the second as a rule. The mandibles are grooved externally, short and arcuate in *Othius* and *Othiellus* and straight with arcuate tip in *Baptolinus* and *Parothius*. In the latter two genera the middle coxae seem to be less completely contiguous than in *Othius*, being separated by a thicker longitudinal ridge. The body is parallel and moderately convex in form, with the head well developed in all except *Othiellus*, where it is notably small; the neck is wide throughout, varying from two-thirds the width of the head in *Othiellus* to one-half in *Parothius*. The antennae are generally less densely clothed with fine pubescence beyond the fourth or fifth joint than in the Xantholini, but have longer sparse tactile setae and the basal joint is somewhat shorter, rarely being more than a third as long as the remainder. The frontal grooves are much less developed than in the preceding subtribe and frequently more widely separated, when not obsolete, and the eyes are about equally developed throughout. All the genera have the basal angles of the head rounded and the sides of the prothorax either parallel or much less converging from apex to base than in the Xantholini. The four genera before me may be distinguished by the following characters: —

- Fourth joint of the maxillary palpi shorter than the third and evidently narrower at base, acutely conical in form and more or less compressed; mandibles short, thick and arcuate.....2
- Fourth joint not shorter than the third and generally much longer but of nearly similar form, thick at base and gradually acutely conical; mandibles longer, straight externally, finely pointed, arcuate and decussate at apex.....3
- 2 — Body parallel, large in size, the frontal grooves obsolete; antennae thick, with the second joint much shorter than the third, both conical, the anterior tarsi very strongly dilated and densely clothed with white pubescence beneath; labrum truncate, deeply and narrowly cleft at the middle; head very sparsely punctured toward the sides as a rule, with the upper surface, as well as the pronotum and abdomen, very minutely and closely strigilate in transverse wavy lines; prothorax broad, narrowed but little toward base and with two discal punctures obliquely

- arranged at each side anteriorly and another at basal two-fifths and lateral fifth, also a few scattered along the lateral and apical margins; elytra somewhat shorter than the prothorax, generally sparsely and irregularly punctured, with the ground sculpture between the punctures consisting of very minute close-set nude punctules; middle coxae very large, closely contiguous. Palaearctic regions.....***Othius**
- Body very much smaller in size and fusoid, narrowing anteriorly from the elytra, the head much smaller, the frontal grooves short but strongly and broadly impressed, parallel, only moderately separated and distinct, the ocular grooves of the Xantholini represented by a rounded puncture at the upper margin of the eyes; antennae much more slender and relatively longer but with the second and third joints nearly as in *Othius*; anterior tarsi less strongly dilated, similarly clothed beneath; labrum similar; integuments smooth and polished, without minute ground sculpture of any kind, the three setigerous discal punctures at each side of the pronotum as in *Othius*; elytra more developed, being generally much longer and wider than the prothorax, the latter narrower and having the sides parallel and arcuate throughout the length; middle coxae somewhat narrower and not quite so closely contiguous. Palaearctic regions.....***Othiellus**
- 3 — **Maxillary palpi** shorter, the third joint relatively more thickened toward tip, the fourth joint equal in length to the third, acutely conical; pronotum with two entire dorsal series of about five widely spaced punctures and also a cluster of about three distinct punctures at apical third and lateral fifth; body less stout than in *Baptolinus*, moderately convex, the head and pronotum minutely and transversely strigilate, the elytra without minute ground sculpture, the abdomen very obsoletely and indistinctly strigilate; front broadly impressed at the middle and with two very remotely separated parallel grooves; antennae rather thick, the second and third joints equal in length; neck one-half as wide as the head; prothorax elongate, with distinct though somewhat rounded angles; elytra well developed, each with a deep gutter along the sutural bead; gular sutures deeply impressed, becoming virtually contiguous at base; anterior tarsi broadly dilated and densely spongy-pubescent beneath. Nearctic Pacific coast...**Parothius**
- Maxillary palpi** longer and more slender, the third joint less swollen toward tip and the fourth much longer than the third, gradually and acutely pointed toward tip; pronotum with a single puncture at each side of the centre of the disk and another at apical fifth or sixth and lateral fifth; body stouter, moderately convex, the head and pronotum with excessively minute or subobsolete transverse wavy strigilation, feebler and finer as a rule than in *Parothius*, the elytra similarly without ground sculpture; front similarly impressed, the parallel frontal grooves nearly similar but feebler or obsolescent; antennae longer, relatively more slender toward base and incrassate toward tip, the second and third joints equal; neck wider, rather more than half as wide as the head; prothorax less elongate as a rule, with more broadly rounded angles; elytra well developed, almost as strongly impressed along the sutural bead; gular sutures similarly strongly impressed but usually rather

less approximate at base; anterior tarsi broadly to moderately dilated, more strongly in the male. Palearctic and Nearctic regions.

Baptolinus

The foreign genera described in the table may be briefly discussed as follows:—

OTHUS Steph. — The assumed type of this genus is recorded under the name *fulvipennis* Fab., in the European lists and *grandis* Hochh., and *paralleliceps* Qued., can also be included in all probability. Its species are among the larger and more conspicuous components of the tribe and do not occur outside of the palaeartic provinces as far as known. The shorter and more arcuate mandibles seem to be correlated with the relatively more elongate third joint of the antennae and more abbreviated fourth palpal joint, constituting of *Othius* and *Othiellus* a group not very closely related to *Baptolinus* and *Paroethius*. The peculiar ground sculpture of the elytra, consisting of extremely minute, close-set punctules, only visible under rather high power, constitute a really important character in distinguishing *Othius* from *Othiellus*.

OTHIELLUS n. gen. — This name is proposed for certain very small species, hitherto forming part of the genus *Othius* but differing in numerous more or less important structural features, as may be inferred from the table above. A notable point of resemblance between the two genera is the sculpture of the pronotum, which in both consists of three setigerous punctures at each side disposed in perfectly similar manner, as mentioned above, but, as a rather radical divergence, attention may be called to the distinct frontal grooves of the present genus, which become obsolete and replaced by a transverse post-apical impression in *Othius*; the tarsi also, are relatively more elongate in *Othiellus*. The genus is founded upon such species as *laeviusculus* Steph., and *melanocephalus* Grav.

Paroethius n. gen.

This genus is rather closely allied to *Baptolinus* but differs in the important character relating to the number and disposition of the setigerous punctures of the pronotum, stated

above, in the more abbreviated palpi, especially noticeable in the form of the fourth joint, in its narrower form, less rounded angles of the head and pronotum, thicker basal parts of the antennae, narrower neck and, as may be inferred, notably different facies. It is also very restricted in geographical range, being confined to the northern Pacific coast regions and is at present represented by a single rather rare species, which may be defined as follows: —

Slender, subparallel, shining, black or with a slight piceous tinge, the prothorax nubilously paler at base and the elytra sometimes faintly paler at base; tip of the abdomen rufous; legs pale, the antennae dusky, rufous; head moderate, subquadrate, scarcely as long as wide behind the antennae, the sides subparallel and nearly straight behind the slightly prominent eyes to the unusually narrowly rounded basal angles; antennae slightly longer than the head, very moderately incrassate distally; eyes moderate, surrounded by a fine deep groove throughout, the groove slightly dilated at the posterior margin; punctures small, impressed and widely scattered; prothorax fully a fourth longer than wide, evidently narrower than the head, the sides nearly straight and feebly, though obviously, converging throughout; elytra somewhat longer than wide, as long as the prothorax and much wider, scarcely visibly wider than the head, very finely, feebly, sparsely and irregularly punctate; abdomen parallel, distinctly narrower than the elytra, finely, sparsely punctulate. Length 5.8 mm.; width 0.8 mm. California (Humboldt Co.).....**californicus** Mann.

This very interesting species has been borne upon our lists under the generic name *Othius*, but it is really much more closely related to *Baptolinus*, differing however, not only from that genus but any other type of the subtribe known to me, by the dorsal series of pronotal punctures, which resemble somewhat those of *Nudobius*, of the Xantholini. The male sexual characters are feeble, consisting of a narrow, transversely rectilinear truncature of the sixth abdominal segment and the possibly more widely dilated anterior tarsi. The first ventral is carinate in basal half and the prosternum is carinate posteriorly. I have before me only a single male example.

Baptolinus Kr.

The body in this very widely distributed holarctic genus is stouter and more evenly parallel than in the preceding, with more broadly rounded angles of the head and prothorax, the latter being less elongate and, in all but one instance, bearing

two setigerous punctures on the medial transverse line, separated by one-half the entire width to somewhat less. There is invariably a large setigerous discal puncture anteriorly at about lateral fifth, and, adjoining the acute lateral edge almost in transverse line with the latter, another equally large and conspicuous. The antennae are rather distinctly longer than the head, somewhat slender toward base and strongly though gradually incrassate distally, with the sparse tactile setae rather conspicuous. The eyes are moderately large and feebly convex, the surrounding groove very fine or sub-obsolete. The frontal grooves when present, as in the European *affinis*, are widely separated, short and parallel, but they are generally represented by one or two setigerous punctures. The anterior tarsi are strongly dilated in the male but much more narrowly so and more parallel in the female, the latter sex having the narrowed abdominal apex evenly rounded; in the male it is sometimes rounded though frequently transversely sinuato-truncate. The middle coxae are narrower than usual, so that they are not quite contiguous, being separated by the thick cariniform dividing ridge of the mesosternum. The neck is rather more than half as wide as the head as a rule and is obliquely carinate beneath at each side and impressed in the middle, the oblique ridges fitting into corresponding recesses adjoining the membranous and corneous pieces filling the anterior situation of the proster-num; the latter is carinate posteriorly and the first ventral is as in *Parothius*. The elytral punctures are not of the usual type but, as in *Parothius*, are extremely minute and sparsely, irregularly scattered, the ground sculpture being obsolete but with the general surface feebly undulato-rugose in several species; the abdominal punctures are sparsely scattered and are fine, though more strongly asperate than usual, and bear rather long stiff reclining hairs. The elytra are glabrous, with a row of small setae near the sutural bead, another on the summit of the flanks and, generally, a medial row of very few in all the species known to me, except the European *longiceps*, where they are sparsely setulose throughout as in *Parothius*. Our species may be differentiated by the following characters: —

Head large, evidently wider than the elytra, the latter large and obviously longer as well as wider than the prothorax. Body stout, parallel, only moderately convex, shining, blackish-piceous throughout, the elytra nubilously rufescent in nearly basal half; legs pale, the antennae darker, rufous; head behind the antennae wider than long, parallel at the sides, the angles broadly rounded as usual; front broadly impressed at the middle and with a few setigerous punctures, with others also sparsely scattered along the base and toward the sides; antennae with the second joint obviously shorter than the third, the latter obconical and as long as the next two combined; prothorax but slightly longer than wide, much narrower than the head, with the sides very feebly converging posteriorly; elytra somewhat longer than wide, rather strongly rugulose; abdomen behind the middle as wide as the elytra, finely, sparsely punctulate toward the sides only, the median parts impunctate. *Male* with the sixth ventral broadly, feebly and evenly arcuate at tip, the female smaller in size and rather more slender, with the sixth ventral narrower and more strongly though evenly rounded at tip. Length 6.0-7.0 mm.; width 0.9-1.05 mm. New Hampshire (White Mts.), British Columbia (Stickine River), Queen Charlotte and Prince of Wales Islands.....*macrocephalus* Nord.

Head less developed, never wider than the elytra.....2

2 — Elytra equal in length to the prothorax. Body smaller in size than the preceding and more convex, blackish-piceous when mature, with the abdomen paler and rufous, gradually clouded posteriorly with faintly darker piceous, the elytra nubilously pale at the basal margin and sometimes narrowly along the suture; legs and antennae pale rufous; head behind the antennae scarcely as long as wide, parallel at the sides, almost punctureless, except a few large setigerous punctures scattered along the base, a few at the sides and a very large setigerous puncture in the usual position above each eye; front broadly, feebly impressed; antennae with the third joint only slightly longer than the second and nearly as long as the next two combined; neck about three-fifths as wide as the head in the male, not quite so wide in the female; prothorax but little longer than wide and only very slightly narrower than the head in the male, rather more distinctly narrower in the female, the sides subparallel and broadly arcuate; elytra quadrate, slightly wider than the prothorax, polished, almost completely impunctate, feebly undulato-rugulose; abdomen almost as wide as the elytra, rather finely but asperately, conspicuously and sparsely punctate, more sparsely and obsoletely so toward the middle. *Male* with the body noticeably stouter, the sixth ventral broadly and evenly rounded behind, the female having the same segment almost similar, being but slightly more narrowly and strongly rounded. Length 5.6 mm.; width 0.85-0.95 mm. Lake Superior.....*americanus* n. sp.

Elytra distinctly shorter than the prothorax; basal angles of the head broadly rounded as usual.....3

3 — Body perfectly parallel, the head, prothorax and elytra equal in width. Rather slender in form, convex, shining, evenly ferruginous in color throughout the body, legs and antennae, the elytra not at all darker at any point; head rather well developed, fully as wide as the elytra in the male, rather narrower in the female, slightly wider than long behind the

antennae in the former, as long as wide in the latter, parallel at the sides; antennae with the second and third joints about equal in length and thickness in both sexes and each somewhat shorter than the fourth and fifth combined; surface almost impunctate but with the usual setigerous punctures, a few along the base, a larger one at the sides behind and another above each eye, also one or two behind the point of antennal insertion, and, on the front, in transverse line just behind the large feeble frontal impression, there are two smaller punctures separated by about a fifth of the interocular width; prothorax as wide as the head in the male, just visibly wider in the female, between a fifth and sixth longer than wide, parallel and feebly arcuate at the sides with broadly rounded angles, the surface with the usual punctures and very minute wavy strigilation; elytra unusually small, quadrate, equal in width to the prothorax but much shorter, subimpunctate and only very feebly rugulose, shining; abdomen as wide as the elytra, finely, sparsely punctate, obsoletely so toward the middle. *Male* with the sixth ventral narrow, transversely and rectilinearly truncate at tip, the female with the apex of the same segment broadly, evenly rounded. Length 5.8 mm.; width 0.78 mm. Idaho (Coeur d' Alene), — H. F. Wickham.

quadripennis n. sp.

Body not parallel, the head small in both sexes and the elytra relatively larger.....4

4 — Form rather stout in the male, less so in the female, shining, the head and abdomen pale piceo-rufous, the prothorax clear and pale rufous, the elytra black, with the basal margin and sutural bead nubilously pale; legs and antennae pale ferruginous; head behind the antennae very slightly transverse in the male, about as long as wide in the female, parallel, with the usual setigerous punctures as in *quadripennis*; prothorax much wider than the head in both sexes, with parallel and feebly arcuate sides and broadly rounded angles, only just visibly longer than wide in the male, narrower and fully a sixth longer than wide in the female, the usual dorsal punctures well developed in the latter sex, the transverse median pair wholly obsolete in the male; elytra rather large, quadrate, evidently shorter and wider than the prothorax in both sexes, shining and but feebly rugulose, with some very fine and sparsely scattered nude punctules; abdomen parallel, nearly as wide as the elytra, the fine asperate punctures strong and conspicuous, only moderately sparse and but slightly less developed along the median parts. *Male* with the fifth ventral feebly sinuato-truncate, the sixth much narrower, with a feeble rounded apical sinus half as wide as the entire segment and about six times as wide as deep, the second antennal joint evidently shorter than the third and of about equal thickness, the latter as long as the fourth and fifth combined; *female* with the sixth ventral broadly, evenly rounded at tip, the second antennal joint fully as long as the third and thicker, the latter not as long as the next two combined. Length 4.8–5.4 mm.; width 0.83–0.9 mm. California (Lake Tahoe).....*punctiventris* Fall

Form more slender, the size smaller, equally convex and shining, pale and almost uniform testaceous throughout the body, legs and antennae, the elytra nubilously and gradually shaded with blackish or piceous behind basal two-fifths or thereabouts; head about as long as wide behind the

antennae in both sexes, parallel, with the usual broad and feeble frontal impression and setigerous punctures; prothorax nearly similar in the sexes and more elongate than in the preceding species, about a sixth longer than wide and just visibly wider than the head in both; sides parallel and feebly arcuate, with the angles broadly rounded, the usual discal punctures, including the transverse median pair, distinct in both sexes; elytra quadrate, evidently shorter than the prothorax but only just visibly wider, smaller than in *punctiventris* but otherwise nearly similar; abdomen as wide as the elytra, punctured nearly as in the preceding species but more closely. *Male* with sexual characters nearly as in *punctiventris*, the shallow sinuation of the sixth ventral even wider and more feeble, being about eight or nine times as wide as deep, the second and third antennal joints equal in length and thickness, and each distinctly shorter than the fourth and fifth combined; *female* with the sixth ventral broadly and evenly rounded, the second antennal joint evidently longer and thicker than the third, the latter relatively still smaller than in the male, the body slightly smaller and more slender as usual. Length 4.3-4.8 mm.; width 0.75-0.78 mm. California (Siskiyou Co.).....**fraternus** n. sp.

The species described above under the name *americanus* is the one that has long figured in our lists as the European *pilicornis* Payk., but a carefully identified example of the latter species sent me by Mr. Reitter, shows that there is not even a close resemblance between them, the prothorax of *pilicornis* being much shorter and narrower than the elytra, the latter being even more largely developed. In addition, the coloration is different and the head notably larger, more transverse and with numerous large dorsal punctures, of which there is not a trace in the American species. Of *punctiventris* I have before me three examples, two females and one male. The females have the transverse medial pair of pronotal punctures well developed, but the male has no vestige of them and is the only specimen in my cabinet, of either American or European species, in which these setigerous punctures are not distinctly evident and very regular in formation. It is almost impossible to believe that their absence in this single male is not a malformation, although in such cases, concerning characters of such persistence, there is usually a trace of one or both at least on one side, but here they are completely wanting, without even a vestige on either side. If by further examination this be found to be a male sexual peculiarity of *punctiventris*, it will constitute an addi-

tional and very singular specific character. The *ongiceps*, of Fauvel, which by some mistake has found its way to our lists, does not occur here; it is an aberrant species in having the elytra sparsely setulose throughout, as above remarked, and I know of no American form to which it is at all closely related.

Subtribe **Diochi**.

The chief characters distinguishing this subtribe are the slender maxillary palpi, with the third joint elongate and but feebly enlarged from base to apex and densely clothed with minute recumbent pubescence in addition to the longer tactile setae, the fourth joint being extremely small and slender, aciculate and very oblique, the normal elytral suture and the smaller, less transverse mentum. The antennae are of the Xantholinid type, densely clothed with fine pubescence except toward base, but are more slender than usual and are more widely separated at base as in the *Othii*, with the epistoma short, broad and trapezoidal between them. A character which appears to be widely divergent from anything known in the two preceding tribes, is the larger, less transverse, broadly rounded and entire labrum, with a very minute median denticle at the apical margin and the mandibles in *Diochus* are arcuate, not grooved externally but with the outer edge acute. The fine close-set punctures of the abdomen are also different from anything occurring elsewhere in the tribe, so that, as a whole, *Diochus* is sufficiently isolated to demand without doubt subtribal distinction. The single known genus may be described as follows: —

Body very small in size and slender, pointed before and behind or fusoid in outline, the head very small, elongate, without frontal grooves or impressions, evenly convex and unmodified on the flanks behind the rather well developed and somewhat coarsely faceted eyes, the latter not surrounded by a groove or impression; basal angles very broadly rounded; gular sutures strong, straight, widely separated anteriorly, gradually converging and becoming contiguous or nearly so at the extreme base only; prothorax elongate, comparatively large, narrowed from the base to the subcircularly rounded apex, the side margins acute to the apex; neck narrow, about a fourth as wide as the head; prosternum tumid in the middle posteriorly, the surface turned slightly upward anteriorly;

elytra impunctate except three or four rows of widely spaced setigerous punctures, glabrous except along the lower part of the inflexed flanks, where there is some sparse reclining pubescence; abdomen finely, closely punctulate and pubescent throughout; middle coxae very large, contiguous, extending from the middle virtually to the sides of the body, with the exposed surface flat, the anterior coxae very large and prominent as usual; legs moderately stout, the anterior tarsi strongly dilated, rather less strongly so in the female, the posterior slender, filiform, closely clothed throughout with very short inclined setulose pubescence, the basal joint much longer than the second, the first four joints rapidly decreasing in length. Probably cosmopolitan.....**Diochus**

I have had no opportunity to compare the European species with our own, but presume there is no generic difference of any kind; the above description is drawn throughout from the American representatives.

Diochus Erichs.

The general habitus of this genus is unique in the present tribe, the remarkably small elongate head being proportionally less developed than in any other Staphylinid type that I can recall at present; this, with the anteriorly and not posteriorly narrowed prothorax, fusoid outline and fine close pubescence of the abdomen, adds to the disparity. The prothorax has a broadly and evenly arcuate base, quite as evenly but more strongly rounded apex, with very broadly rounded angles, and the dorsal surface has four small setigerous punctures near the middle, forming an elongate parallelogram, and, more anteriorly and nearer each side, there is a larger setigerous puncture; further still toward each side there is an arcuate longitudinal series of about four punctures, also a few scattered along the edges throughout the periphery. The head has a number of setigerous punctures sparsely scattered toward the sides but otherwise is impunctate. The pronotum has no trace of wavy strigilation or other minute ground sculpture so usual in the Xantholini and Othii; the surface is highly polished throughout, the abdomen being dullish because of the dense fine vestiture. The species are apparently more numerous in America than in Europe; they are very active, running with greater velocity when disturbed than is usually the case in the

preceding subtribes. The descriptions given below are derived from the male, except that of *pallidiceps*, which is taken from the female:—

- Head black or blackish, the abdomen black to piceous. 2
 Head pale piceous-brown, the abdomen black, with the tip paler. 5
 2—Elytra distinctly shorter than wide; head narrower, more rounded at base 3
 Elytra longer, nearly as long as wide; head wider, more truncate at base. 4
 3— Moderately slender, piceous, the prothorax paler and more flavate, the elytra blackish in maturity, with the apical margin pale, the head piceous-black; legs pale, the antennae dusky, paler toward base; head very narrow and elongate, the eyes small but rather prominent, the sides behind them subparallel and feebly arcuate; prothorax large, elongate, one-half wider than the head, widest near the base as usual; elytra not very much shorter than wide, three-fourths as long as the prothorax, the sides feebly diverging, almost continuous in direction with those of the prothorax; abdomen large, fully as wide as the elytra, about half as long as the body, gradually tapering behind, the sixth segment narrowly trapezoidal. *Male* with the fifth ventral broadly truncate, becoming visibly though feebly sinuate toward the middle, the sixth segment with a feeble, rounded, indefinitely limited sinus, about a third as wide as the apex and five or six times as wide as deep, the antennae one-half longer than the head, slender, feebly incrassate distally, the second and third joints equal and elongate, each nearly as long as the next two combined; *female* with the prothorax relatively smaller, narrower and more narrowed anteriorly, the antennae nearly similar but somewhat shorter, the sixth ventral broadly and very evenly rounded behind. Length 3.8-4.0 mm.; width 0.65 mm. Rhode Island, North Carolina (Asheville), Missouri and Texas (Galveston).

schaumi Kr.

Nearly similar throughout to the preceding but distinctly more slender, dark piceous-brown, the head more blackish, the prothorax paler and more flavate; legs and antennae similar; head as in *schaumi*, the eyes rather less prominent; prothorax narrower and slightly more elongate, rather more narrowed anteriorly and not quite one-half wider than the head; elytra notably shorter, very much shorter than wide and about three-fifths as long as the prothorax, the sides feebly diverging from the base in the direction of the sides of the prothorax; abdomen similar to that of *schaumi* but acutely pointed behind, each dorsal with a median transverse series of widely spaced setigerous punctures as usual. *Male* with the apex of the fifth ventral similarly sinuate toward the middle, the sixth with a rather larger but otherwise similar sinus at tip, nearly half as wide as the apex and about five times as wide as deep; *female* with the sixth ventral broadly, feebly and very evenly arcuate at tip, the form of the body and prothorax not differing appreciably from the male. Length 3.2-3.7 mm.; width 0.6 mm. Virginia, North Carolina (Asheville) and Missouri *brevipennis* n. sp.

4— Body much stouter, the head and abdomen black or blackish, the

prothorax pale, the antennae darker, rufous, the elytra piceo-rufous to piceous-black throughout; head rather wider than in *schaumi* and more broadly rounded at base, elongate as usual; prothorax very large, only about a fifth longer than wide, fully one-half wider than the head, with all the angles broadly rounded as usual and with the feebly arcuate sides converging anteriorly between the basal and apical angles; discal punctures as usual; elytra well developed, slightly wider than the prothorax and from four-fifths to five-sixths as long, the sides moderately diverging from the basal angles; abdomen fully as wide as the elytra, tapering toward tip as usual.

Male with sexual characters nearly as in the preceding, the fifth ventral very feebly sinuate in median third, the sixth with a rather strong apical sinus, occupying almost half the width and about five times as wide as deep but rather larger, deeper and more angular or less broadly rounded at the bottom than in *schaumi*, the antennae similar to those of the preceding species. Length 3.7 mm.; width 0.72 mm. New York (Long Island)

- 5 — Body less fusiform than in *thoracicus* and much stouter than in *schaumi*, the head and elytra rufo-piceous, the prothorax paler, the abdomen blackish with the apex pale; legs and three basal joints of the antennae pale testaceous, the remainder of the latter blackish; head elongate, relatively larger than in *schaumi*, arcuato-truncate at base with the sides parallel, the basal angles and antennae almost similar, the eyes notably larger and equally prominent; prothorax much narrower and more elongate, with less converging sides than in the female of *schaumi* but otherwise similar, scarcely more than a third wider than the head; elytra well developed, scarcely visibly shorter than wide, but little shorter than the prothorax and nearly a third wider, the sides diverging nearly in the direction of those of the prothorax as usual, the humeri more laterally exposed at base than in *schaumi*; abdomen nearly similar to that of the three preceding species, at base fully as wide as the elytra, tapering posteriorly, the tip narrow. *Female* with the fifth ventral evenly and rectilinearly truncate, the sixth more elongate and tapering than in the male as usual, the apex broadly, feebly and evenly arcuate. Length 3.8 mm.; width 0.68 mm. Texas (Austin).

pallidiceps n. sp.

Brevipennis is very closely allied to *schaumi* and inhabits almost identically the same geographical regions; it may therefore prove to be nothing more than a subspecies or dimorphic stage. It can only be said at present that there is no trouble whatever in separating the two forms, *brevipennis* having noticeably shorter elytra in both sexes and differing further in its slightly smaller size and still more slender outline. *Thoracicus* is distinct in a number of striking features of form, structure and coloration, and it is doubtless a fully differentiated species; the elytra, when black, do not have

the pale apical margin noticeable in the corresponding examples of *Schaumi*.*

* The following sp occurs in South Africa in the neighborhood of the Cape: —

Slender, piceous-black, shining, the elytra sometimes pale along the suture and at apex; le, the antennae blackish; head small, parallel, elongate, with rounded basal angles, the surface convex and with fine scattered punctures along the base of the occiput, on the flanks and on the under surface, elsewhere impunctate, except a setigerous puncture at the middle of the upper margin of the eye, and, at each side of the middle in apical half, a longitudinal series of some four or five similar punctures; surface minutely strigilate, very feebly behind but more finely, strongly and subreticularly anteriorly; eyes rather prominent; prothorax much wider than the head, oblong, scarcely visibly narrowed anteriorly, the apex and base subequal and broadly rounded, nearly a third longer than wide, with the sides feebly arcuate, the angles rounded; disk convex, with an oblong quadrilateral of four punctures at the centre, one more anterior and slightly more lateral, and an arcuate sublateral series of three or four punctures anteriorly at each side; also others disposed along the lateral and anterior margins; elytra much wider but distinctly shorter than the prothorax, fully as long as wide, each with three series of setigerous punctures, otherwise punctureless; abdomen at base as wide as the elytra, finely, moderately closely, asperately punctulate and with fine decumbent pubescence in addition to the tactile setae bristling from the sides, present also at the sides of the head, prothorax and elytra. Length 3.0 mm.; width 0.48 mm. Wellington.....astutus n. sp.

The sixth ventral of the male is scarcely more than half as wide as the fifth, with its apex sinuato-truncate; the anterior tarsi of the same sex are broadly dilated.

ADDENDUM.

During the course of the present work the following exotic genera and species, or those occurring beyond the limits of the nearctic fauna, have been described as new: —

NAME.	NATIVE COUNTRY.	PAGE.
Ctenochara.....	.Europe.....	128, 134
Notiochara.....	.South Africa.....	129, 134
N. subaspera.....	“	134
N. stibiosa.....	“	135
Polystomota.....	...Europe.....132, 136

NAME.	NATIVE COUNTRY.	PAGE.
Baryodna composita.....	Mexico.....	164
B. bisolata.....	South Africa.....	319
Neolara cubana.....	Cuba.....	188
Amanota.....	South Africa.....	187, 189
A. capensis.....	“.....	189
Tachyusilla.....	Europe.....	213
Tachyusota.....	South Africa.....	213
T. gemma.....	“.....	213
Lophagria.....	Europe.....	225, 230
Falagrioma.....	“.....	226, 230
Melagria.....	“.....	227, 230
Ditropalia.....	“.....	262, 263
Typhlusida.....	“.....	263
Eumicrota azteca.....	Mexico.....	284
E. cornuta.....	Cuba.....	284
Phanerota cubensis.....	“.....	288
Drusillota polita.....	South Africa.....	321
Araeocnemis lauta.....	Panama.....	360
Hyptioma.....	Cuba.....	361
H. cubensis.....	“.....	361
Dinolinus.....	Neotropics.....	366, 373
Xanthohypnus.....	Central America.....	367, 374
Idiolinus.....	Europe.....	368, 375
Notolinus.....	South Africa.....	371, 375
N. grossulus.....	“.....	376
N. fumipennis.....	“.....	376
N. parvus.....	“.....	376
Notolinopsis.....	“.....	371, 377
N. incultus.....	“.....	378
N. latitarsis.....	“.....	378
N. languidus.....	“.....	378
N. capensis.....	“.....	379
N. diligens.....	“.....	379
Saurohypnus dugesi.....	Mexico.....	378
Homalolinus atronitens.....	Guatemala.....	374
Leptacinodes perexilis.....	Europe.....	403
Othiellus.....	“.....	422, 423
Diochus astutus.....	South Africa.....	433

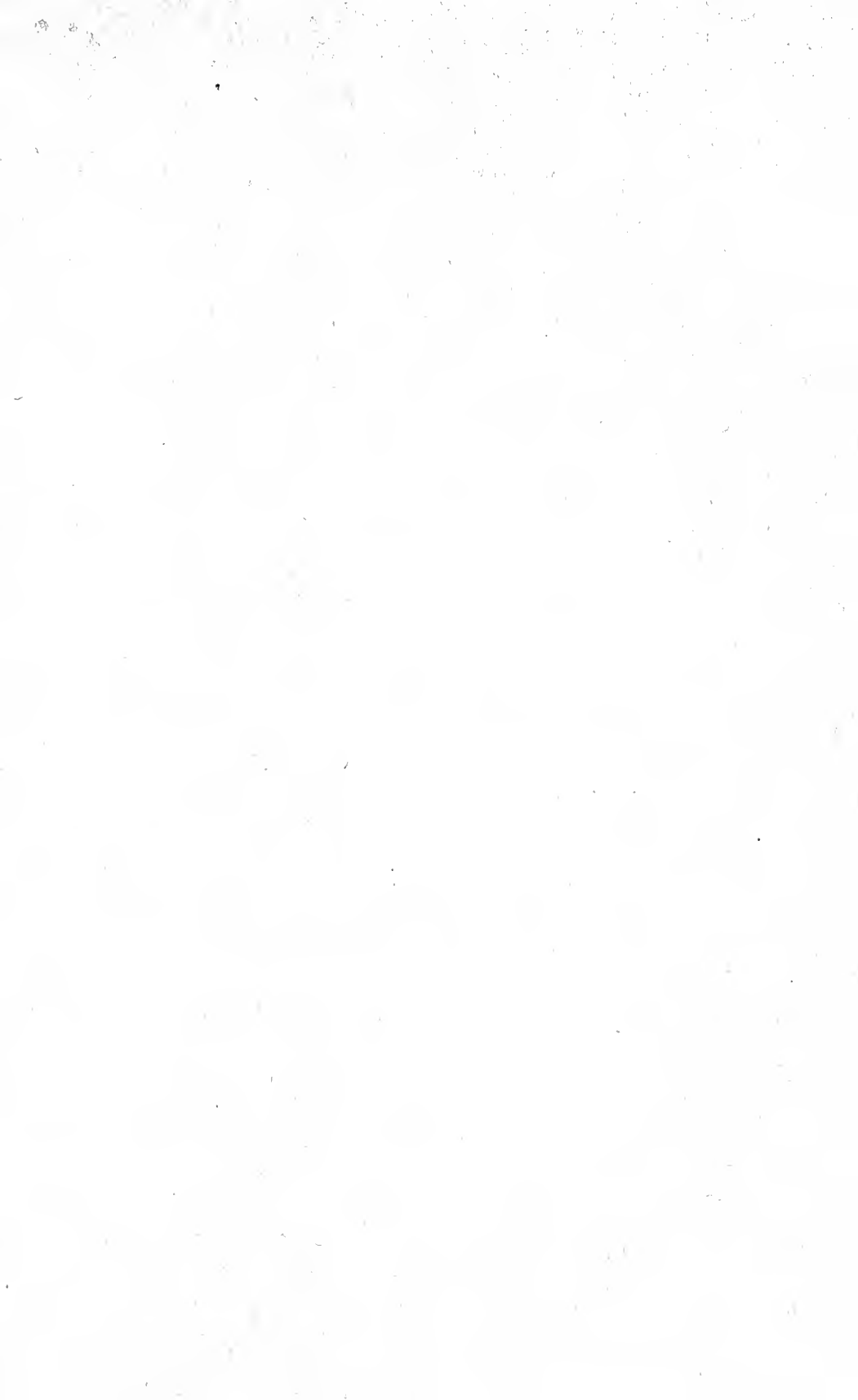

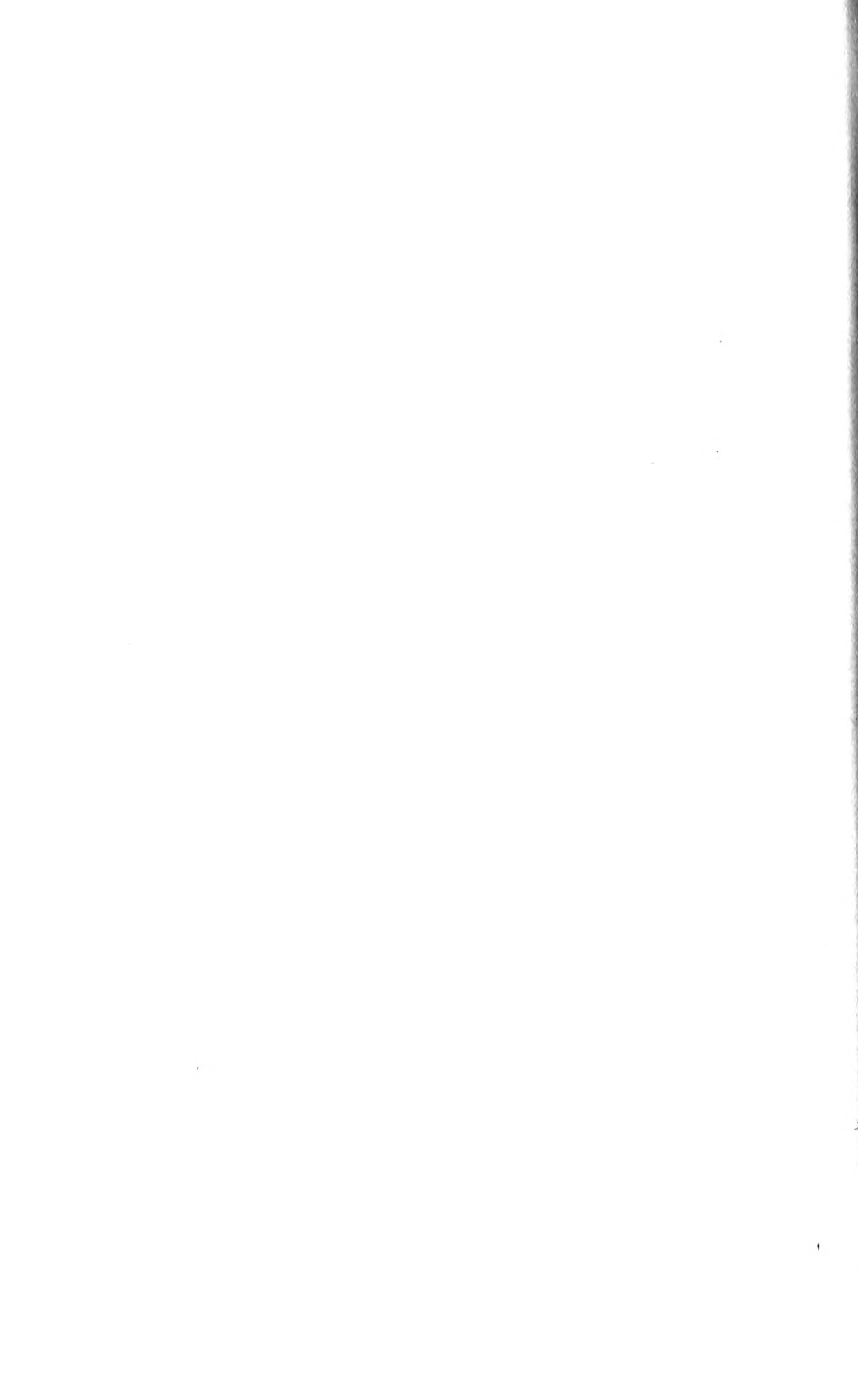

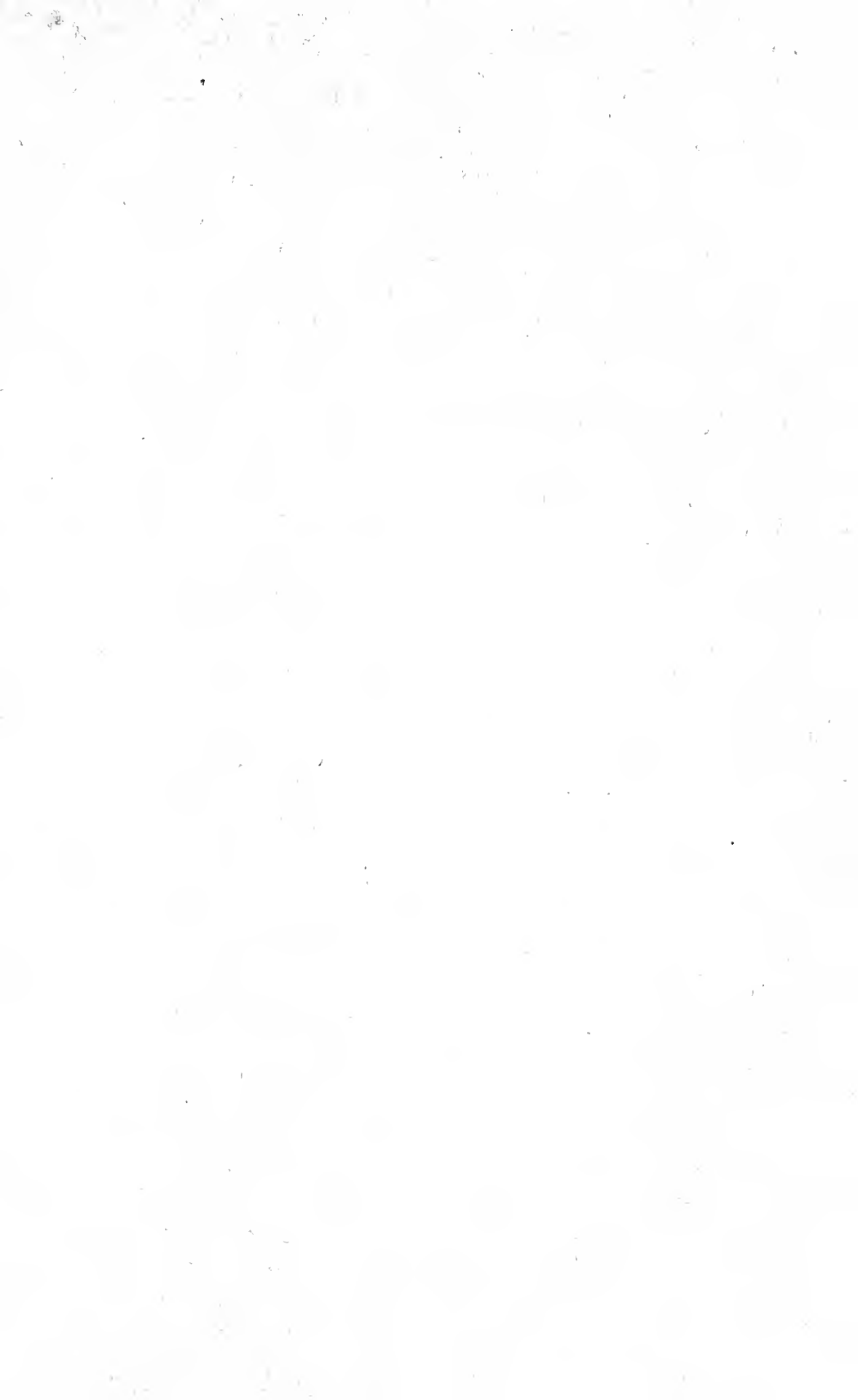

PUBLICATIONS.

The following publications of the Academy are offered for sale at the net prices indicated. Applications should be addressed to The Librarian, The Academy of Science of St. Louis, 3317 Olive St., St. Louis, Mo.

TRANSACTIONS (in octavo).

Vol.	Number.	Price per number.	Price per vol.	Price in set.
1	1*	\$7.50 (Nos. 2-4 only.)	\$7.00 (Nos. 2-4 only.)
	2†	\$4.00		
	3, 4	2.00 each.		
2	1 to 3	2.00 each.	5.50	5.00
3	1 to 4	2.00 each.	7.50	7.00
4	1 to 4	2.00 each.	7.50	7.00
5	1-2, 3-4 }	4.00 each. (double numbers)	7.50	7.00
		1, 2, 6, 8, 10, 11, 16, 17 } 25 cts. each.		
6†	4, 5, 7, 18, 14, 15, 18 } 50 cts. each.	8, 9 } 75 cts. each.	7.50	7.00
		12 } \$1.00		
		2, 3, 4, 6, 7, 8, 13, 15, 16, 18, 19 } 25 cts. each.		
		5, 9 to 12, 14, 20 } 50 cts. each.		
7†	17 } 75 cts.	\$1.00	7.50	7.00
		1 } \$1.00		
		1, 3 to 6 } 25 cts. each.		
8†	8, 10, 12 } 25 cts. each.	2, 7, 9, 11 } 50 cts. each.	3.75	3.50
		1, 3, 4, 7, 9 } 25 cts. each.		
9†	2, 5, 8 } 50 cts. each.	6 } \$1.25	3.75	3.50
		9 } 10 cts.		
10†	2, 4, 5, 10 } 25 cts. each.	1 } 40 cts.	3.75	3.50
		3, 6, 7, 8, 11 } 50 cts. each.		
		2, 3 } 15 cts. each.		
		5-8, 10, 11 } 25 cts. each.		
11†	1 } 45 cts.	4 } 75 cts.	3.75	3.50
		9 } 1.00		
		1, 9, 10 } 25 cts. each.		
		5 } 35 cts.		
12†	3, 8 } 45 cts. each.	2, 4, 6, 7 } 50 cts. each.	3.75	3.50
		2, 3, 5-9 } 25 cts. each.		
		4 } 75 cts.		
13†	1 } 1.50	2, 3, 6, 7 } 25 cts. each.	3.75	3.50
		4, 8 } 50 cts.		
14†	5 } 75 cts.	1 } \$1.00	3.75	3.50
		1, 3, } 25 cts. each.		
		4, 5, 6 } 50 cts. each.		
		2 } \$1.50		
15†	1, 3, } 25 cts. each.	4, 5, 6 } 50 cts. each.	3.50	3.25

MEMOIRS (in quarto).

Contributions to the archaeology of Missouri, by the Archaeological Section. Part I. Pottery. 1880. \$2.00.

The total eclipse of the sun, January 1, 1889. A report of the observations made by the Washington University Eclipse Party, at Norman, California. 1891. \$2.00.

* Supply exhausted.

† Can be sold only to purchasers of the entire volume,—so far as this can be supplied.

‡ Each number is a brochure containing one complete paper (or rarely two).

149

Transactions of The Academy of Science of St. Louis.

VOL. XVI. No. 7.

KINDERHOOK FAUNAL STUDIES.

IV. THE FAUNA OF THE GLEN PARK LIMESTONE.

STUART WELLER.

† Issued December 11, 1906.

KINDERHOOK FAUNAL STUDIES. IV. THE FAUNA OF THE GLEN PARK LIMESTONE.*

STUART WELLER.

INTRODUCTION.

The attention of the writer was first directed to the exceedingly interesting fauna described in the present paper, by Mr. E. O. Ulrich of the United States Geological Survey, and two trips were made to the locality in the Autumn of 1904 for the purpose of securing a quantity of the material for study. Two barrels of the abundantly fossiliferous limestone were secured, and enough of this material has been broken up to supply a good representation of the fauna.

The locality where the fauna occurs is at Goetz's lime quarry, just below Glen Park station on the St. Louis, Iron Mountain and Southern Railroad, about twenty-five miles south of St. Louis, in Jefferson County, Missouri. In order to give a proper understanding of the stratigraphic relations of the bed bearing the fauna it will be necessary to describe briefly the entire section at this locality. Starting from the bottom, the following section is well exposed in the quarry, and in the railroad cut and the slope above, at the eastern side of the same hill. The lower layers are best exposed in the quarry side of the hill, while the higher beds are only to be seen above the railroad cut.

1. The quarry rock. A light colored highly crystalline limestone with many fossils. The fossils occur conspicuously in several bands, and consist of bryozoa, brachiopods, pelecypods, gastropods, trilobites, etc., many of them finely preserved. The fauna indicates the Trenton age of the limestone, but it is quite different from the fauna of the Trenton limestone of the east. This limestone is well exposed at many

* Presented by title to The Academy of Sciences of St. Louis, June 5, 1905.

localities in the river bluffs in northern Jefferson County, and is called by Mr. Ulrich the Kimmswick limestone.*

Thickness from the bottom of the quarry, 55 feet.

2. Harder, darker colored, brownish or bluish limestone, apparently somewhat siliceous. Fossils abundant, especially the brachiopod *Rhynchotrema capax*, which indicates the Richmond age of the bed. This stratum is apparently conformable upon the limestone below, but the fossils indicate a much younger age, and when a series of sections are examined some distance apart, it is seen to rest upon different beds of the Kimmswick limestone at different localities. The unconformity of bed No. 2 upon bed No. 1 is therefore demonstrated both by paleontologic and stratigraphic evidence.†

Thickness, 1 foot, 6 inches.

3. Shaly layer of varying characteristics. On the quarry side of the hill this bed is generally yellow in color and is sparingly fossiliferous, the only fossils observed being small pelecypods of upper Ordovician age, specifically identical with forms occurring in the Maquoketa shales in Iowa. In its upper portion this bed has been reworked by the sea in which the superjacent beds were deposited, disturbing its stratification and occasionally introducing a fossil of the younger beds. In the upper reworked portion of this bed phosphatic nodules occur in greater or less abundance. The Ordovician age of this shale is established, however, by the presence of the Maquoketa pelecypods in the undisturbed portion of the bed. On the opposite face of the hill above the railroad cut, this same interval is occupied by a more uniform, brownish, thin bedded, fissile shale, which weathers gray on the outside, and in which no fossils have been seen.

Thickness, 4 feet.

4. Light colored, oolitic, fossiliferous limestone, containing the fauna described in the present paper. On the quarry side

* Mo. Bureau Geol. and Mines. Vol. 2, 2nd series, p. 111.

† The recognition of the relations of these two beds of Ordovician limestone, and also of the Maquoketa fauna of the shale bed No. 3, is entirely due to the observations of Mr. Ulrich, although all the points have been confirmed by the writer.

of the hill this bed is discontinuous, appearing as lenticular limestone masses in the shale. The upper surfaces of these masses occupy a similar horizon but their lower surfaces are irregular. On the opposite side of the hill above the railroad cut, this layer is a continuous limestone band, more evenly bedded and with innumerable fossils in a better state of preservation. The age of this limestone is shown by the fauna to be early Mississippian, so demonstrating the fact of a long interval between the time of its desposition and that of the subjacent shale. Ulrich has given the name Glen Park Limestone to this formation.* Another exposure of the bed, containing the same species of fossils, is seen at a lower level by the side of the railroad, just north of Sulphur Spring station, and it doubtless occurs elsewhere in the neighborhood.

Thickness, 1 foot, 3 inches.

5. Sandy shale layer. Above the railroad cut this is a continuous bed of similar texture, but on the quarry side of the hill, where the oolitic limestone is not a continuous bed, this layer apparently rests immediately upon the shaly bed No. 3 between the lenticular limestone masses, so that these limestone masses appear to be imbedded in and entirely surrounded with a common shaly formation.

Thickness, \pm 4 inches.

6. Yellow, fine grained sandstone, becoming brown upon the weathered surface, to which Ulrich has given the name Bushberg sandstone.† No fossils have been observed. The full thickness is exposed only above the railroad cut.

Thickness, 14 feet.

7. Hard, somewhat crystalline, yellow or gray limestone. Fossils present but not abundant, the genera *Spirifer*, *Productus*, *Athyris* and *Platyceras* being recognized. The fauna is hardly sufficient for diagnosis, but considering the fauna of the beds above, it can be definitely referred to the Kinderhook.

Thickness, 4 feet.

* Loc. cit., p. 110.

† Loc. cit., p. 110.

8. Unexposed, probably a softer, red calcareous shale covered with talus.

Thickness, 6 feet.

9. Red limestone with greenish blotches, the green color becoming somewhat more marked towards the top, capped by a conspicuous chert band six to eight inches in thickness. In the midst of this bed, besides some scattered chert masses, are two conspicuous, continuous chert bands, each four inches in thickness, one three feet and the other six feet from the base of the bed. Fossils are abundant, the fauna being typically Kinderhook with *Spirifer vernonensis*, *Athyris lamellosa*, *Leptaena rhomboidalis*, *Productus*, *Evactinopora radiata*, *Cyathaxonia*, etc. This red, more or less argillaceous limestone formation has a rather wide geographic distribution, and always contains its own characteristic fauna. In the railroad cut between Sulphur Springs and Kimmswick, two miles north of Glen Park, this bed is much better exposed and more highly fossiliferous than in the Goetz quarry section. It is again exposed near Fern Glen station on the Missouri Pacific Railroad, on the Meramec river, twenty miles west of St. Louis. A small collection of its characteristic fossils, in the same reddish matrix, has been examined from Jersey County, Illinois, and the formation undoubtedly extends as far north as that. Because of its good exposure at Fern Glen, the formation may be called the Fern Glen formation. In the Goetz quarry section the formation undoubtedly includes also the unexposed bed No. 8.

Thickness, 8 feet, 6 inches.

10. More or less crystalline, greenish gray limestone, with three continuous chert bands. This bed does not differ essentially from the subjacent layer except in color, and even this bed is slightly red below, the change from the dominantly red to the dominantly gray or green being a gradual and not an abrupt transition. Fossils are less abundant than in the bed below.

Thickness, 7 feet.

11. Limestone similar to that below, but entirely lacking the red color. Much chert present, usually in more or less

continuous bands a few inches in thickness. Many crinoid stems shown upon the weathered surfaces, with *Spirifer grimesi* and other large brachiopods. This bed and those overlying it may be correlated with the Burlington limestone. The line separating the Burlington from beds of Kinderhook age in this section is not entirely clear, but it should probably be drawn at the top of the red bed.

Thickness, 18 feet.

From the above section it will be seen that the Glen Park limestone occupies a position immediately above a great unconformity. This unconformity is not local but is the same great break in sedimentation which is recognized widely throughout the Mississippi valley. The beds below the unconformity at the locality under discussion, are of upper Ordovician age, but in many places they are much older; the beds above the same unconformity are everywhere in the Mississippi valley, of late Devonian or early Mississippian age. The determination of the exact age of the Glen Park limestone is wholly dependant upon its faunal characteristics, and will be discussed later, but from the line of unconformity upward, the sedimentation was apparently continuous without a break, and very soon passes into beds which are unquestionably of lower Mississippian age.

DESCRIPTION OF SPECIES.

COELENTERATA.

ACTINOZOA.

ZAPHRENTIS sp. undet.

Plate 1, fig. 1.

A few specimens of a small, straight, horn-shaped coral have been observed, but the material is insufficient for its more exact determination.

ECHINODERMATA.

CRINOIDEA.

ACTINOCRINUS? sp. undet.

Plate 1, figs. 2-3.

Numerous detached crinoid plates, nodose in the center and

ornamented with radiating ridges, are present in the Glen Park limestone. In only a few instances are there more than single plates preserved together, but in one specimen five plates are preserved in their natural position. None of the basals are present but there is one radial supporting a costal with an interbrachial on each side. The fifth plate is in the same line with the radial, but is not truncated above for the support of a costal and therefore must be the anal plate. This anal plate, being pointed above for the support of two interbrachials, indicates the family *Actinocrinidae* with certainty, and the specimens are referred provisionally to the genus *Actinocrinus*, although better material is necessary for a more certain determination.

AGARICOCRINUS? sp. undet.

Plate 1, fig. 4.

An incomplete crinoid, preserving only an hexagonal base of three equal plates, and four plates of the radial-anal row, is preserved in the collection from Glen Park. The specimen is too incomplete to determine whether the posterior interbrachial area possesses the characters of the *Batocrinidae* or of the *Actinocrinidae*, but the horizontal position of the basal and radial plates present is strongly suggestive of the genus *Agaricocrinus* and there can be but little doubt of the correctness of this generic identification.

MOLLUSCOIDEA.

BRACHIOPODA.

ORTHOHETES CHEMUNGENSIS (Con.).

Plate 1, figs. 5-6.

One of the common species in the Glen Park fauna is a member of the genus *Orthothes*, which is indistinguishable from the common *O. chemungensis* of the eastern middle and upper Devonian faunas. The Glen Park specimens are all imperfect, for the most part being broken valves. Their average size is less than that of the eastern representatives of the species, but this fact is in keeping with the general char-

acter of the fauna, nearly all of the species recognized being smaller than their close allies in the Hamilton faunas.

CHONETES GLENPARKENSIS, n. sp.

Plate 1, fig. 7.

Description. Shell rather small, pedicle valve inflated, with small, depressed auriculations towards the cardinal extremities. Surface marked by 28 to 30 rounded costae at the margin, many of which bifurcate at about the middle of the valve. The minute surface markings consist of fine concentric costae which are strongest upon the tops of the ribs. Number and character of the cardinal spines not determined.

The dimensions of a pedicle valve are: length, 6.5 mm.; width, 8 mm.; convexity, 3.5 mm.

Remarks. This species is closely allied to *C. logani* of the Kinderhook faunas. It has the same sort of fine concentric markings, but it may be distinguished by its much coarser radiating costae, and by its somewhat greater inflation.

Besides the species of *Chonetes* just described, there are two other members of the genus in the Glen Park fauna represented by material too imperfect for identification or description. The first of these (plate 1, fig. 8-12), is the commonest of the three species. All the specimens which have been observed were more or less waterworn before being fossilized. The dimensions of an average specimen are: length, 7 mm.; width, 9 mm.; and convexity, 2 mm. The surface is marked by 45 to 50 rounded costae, but the finer surface markings have been destroyed on all the specimens examined. In all the specimens in their present condition, the hinge line is a little shorter than the greatest width of the shell, the cardinal extremities being rounded, but this may be due to their worn condition since the lines of growth meet the hinge-line at nearly right angles. The spines have usually been entirely destroyed, but their eroded bases may occasionally be detected, although it is not possible to determine their number or their direction. These specimens have something of the aspect of *C. logani*, but this species cannot be certainly recognized without the fine surface markings.

The third species of *Chonetes* in the fauna is represented by a single specimen. It is smaller and proportionally narrower than the last one, the length and breadth being nearly equal, 6.5 mm., and it is more strongly convex with rounded radiating costae. The finer surface markings cannot be determined.

CAMAROTOECHIA sp. undet.

Several incomplete specimens of a rhynchonelloid shell having the aspect of members of the genus *Camarotoechia*, occur in the Glen Park fauna. Except for a few very immature individuals, all the specimens observed are separate valves, all of which are more or less imperfect so that they cannot be certainly identified. One of the larger specimens has a length and width each of 10 mm.

EUNELLA COMPRESSA n. sp.

Plate 1, figs 13-16.

Description. Shell small, lenticular, compressed, the two valves subequally convex, subovate to subcircular in outline, longer than wide or sometimes wider than long, the greatest width at or posterior to the mid-length of the shell. Pedicle valve with an acute, erect beak; foramen circular or somewhat oval; pseudodeltidium well developed; the surface flattened along the median line from the beak to the anterior margin and somewhat compressed on either side, giving to most specimens the appearance of having two indistinct elevations, one on either side of the flattened region, extending from the beak to the front margin. Brachial valve usually slightly more convex than the pedicle valve, most prominent posteriorly, flattened along the median line to correspond with the flattened region of the opposite valve; brachidium not clearly made out, but its length is about one-half the length of the shell. Surface of both valves smooth, shell structure finely punctate.

The dimensions of one specimen are: length 6 mm., width 5 mm., thickness 2 mm.; of another broader specimen: length 6 mm., width 6.5 mm., thickness 2.8 mm.

Remarks. This is one of the common species of the fauna and frequently occurs as complete specimens. In the erect

beak of its pedicle valve and the well developed pseudodeltidium, it differs notably from the terebratuloid shells of the genus *Dielasma* commonly present in the Mississippian faunas, and it has much more the aspect of certain Devonian shells. In the characters of the beak as well as in the length of the brachidium, the shells agree with the definition of the genus *Eunella*. The complete form of the brachidium has not been determined in the Glen Park specimens, only the primary lamellae having been observed, but these determine the length of the loop, and in the genus *Eunella* the recurved connecting lamella is always feebly developed and has usually been destroyed.

The species may be compared with *E. lincklaeni* Hall, from the eastern Hamilton fauna, but the shell is smaller and much more compressed and may be easily distinguished by its conspicuous median flattened region on each valve.

CRYPTONELLA? sp. undet.

Several specimens of a terebratuloid shell have been observed, the larger of which are several times the size of members of the species last described. These specimens are all separated valves, but they indicate species not only larger but also much thicker than the last. The beak of the pedicle valve is erect so that the pseudodeltidium is well developed, and the foramen rather large. The aspect of the shell is much more that of the Devonian species referred to the genus *Cryptonella* or some of its near allies, than to the Mississippian members of the genus *Dielasma*, with their more strongly incurved beaks. The form of the brachidium has not been observed, so that the true generic position of the shells cannot be certainly determined.

ATRYPA SPINOSA Hall.

Plate 1, fig. 17.

A single small specimen of this species has been detected in the Glen Park fauna. Its length and breadth are equal, both being 7 mm., and its thickness is 3 mm. Its markings consist of rather coarse, radiating plications with lamellose, concentric lines of growth, which are more produced upon the tops

of the ribs. This specimen agrees closely with typical Hamilton individuals of the species of the same size, or with the corresponding portion of the shell in larger individuals.

SPIRIFER JEFFERSONENSIS n. sp.

Plate I, figs. 18-22.

Description. Shell of medium size, wider than long, the cardinal extremities rounded, the hinge-line a little shorter than the greatest width. Pedicle valve strongly convex, the beak incurved; cardinal area high, concave, the cardinal margins rounding into the lateral slopes of the shell, the delthyrium broadly triangular; sinus moderately shallow, rounded in the bottom, well defined at its sides, usually marked by two more or less indistinct, sometimes nearly obsolete plications; lateral slopes slightly concave or convex from the umbo to the cardinal extremities, convex antero-laterally. Brachial valve moderately convex; the fold sharply defined, but little elevated above the general surface of the valve in the posterior half, sometimes becoming more strongly elevated towards the front, indistinctly marked by three or four low, rounded plications which are often apparently obsolete; lateral slopes convex from the umbo to the antero-lateral margins, curving more abruptly to the cardinal margin. Each valve marked by from eight to twelve, usually nine or ten, simple rounded plications upon each of its lateral slopes; the entire surface also marked by fine concentric lines of growth.

The dimensions of a nearly perfect pedicle valve are: width 22.5 mm., length from beak to anterior margin 18 mm., height of area 7 mm., width of delthyrium at hinge-line 7 mm. The dimensions of a brachial valve are: width 22 mm., length 15 mm., convexity 6 mm.

Remarks. At first sight this *Spirifer*, with its elevated cardinal area and the inconspicuous plications of the fold and sinus, suggests the genus *Syringothyris*, but it lacks the punctate shell structure of that genus and also the characteristic syrinx. The condition of the plications of the fold and sinus is a variable character, in a few of the specimens examined they are perfectly evident, in others they are nearly obsolete and in a few brachial valves they seem to be entirely

lacking. The elevation of the fold of the brachial valve is another variable character, in some individuals it being quite strongly elevated at the anterior margin of the shell while in others it is not conspicuously elevated.

The species is quite distinct from any of the recognized species of the Kinderhook faunas, neither is it closely allied to any of the later Devonian forms.

DELTHYRIS MISSOURIENSIS n. sp.

Plate 1; figs. 23-26.

Description. Shell small, wider than long, the hinge-line usually a little shorter than the greatest width. Pedicle valve strongly convex, with a medium septum internally, the umbo prominent, beak a little incurved; the cardinal area of moderate height, concave, delthyrium narrowly triangular; lateral slopes convex antero-laterally, the slopes from the umbo to the cardinal extremities sometimes slightly concave, the cardinal margins angular; sinus well defined to the beak, rather shallow, rounded or somewhat flattened in the bottom. Brachial valve regularly convex except towards the cardinal extremities where it is more or less compressed; fold sharply defined, not greatly elevated above the general surface of the valve. Each valve marked by three or four strong, rounded plications upon each lateral slope, becoming successively smaller in passing towards the cardinal extremities; surface of each valve also marked by strong crowded lamellose lines of growth.

The dimensions of a large pedicle valve are: length from beak to front margin 10 mm., width 12.5 mm., convexity at umbo 5 mm.; the dimensions of a large brachial valve are: length 8.5 mm., width 13 mm., convexity 3.7 mm.

Remarks. Most of the specimens of this species are considerably smaller than the dimensions given above, the width of a large number of individuals being less than 5 mm. The brachial valves are much more commonly preserved than the pedicle valves.

These shells have the general aspect of several species from the lower Mississippian faunas commonly referred to the

genus *Spiriferina*, but none of the specimens show the punctate shell structure of that genus although the medium septum and the strongly lamellose concentric surface markings are well developed. In the absence of the punctate shell, this species agrees in all its generic characters with that group of septate, lamellose, Spirifers which Schuchert has included under the generic name *Delthyris* in a restricted sense.

The Glen Park specimens resemble *Spiriferina clarksvillensis* of the Louisiana limestone, but are narrower, with a smaller number of plications, and with more strongly convex valves. They also resemble the Kinderhook species *S. solidirostris*, but as well as being narrower with fewer plications, they lack the depression in the median line of the fold of the brachial valve and the corresponding elevation in the sinus of the pedicle valve of that species. Both of these species agree with the Glen Park specimens in the lack of the punctate shell, and the proper generic reference of all three species is probably *Delthyris* rather than *Spiriferina*, and they might be compared with the Hamilton species *D. sculptilis*, although all are very distinct from that species.

DELTHYRIS SUBORBICULARIS n. sp.

Plate 1, figs. 27-28.

Description. Shell small, subelliptical in outline, wider than long, the hinge-line shorter than the greatest width of the shell. Pedicle valve moderately convex, with a strong medium septum internally, the beak obtuse and not incurved; cardinal area rather small, slightly concave, sloping backward and forming an angle of about 130° with the plane of the valves; sinus rather shallow, concave in the bottom; lateral slopes convex, each marked by five or six simple, rounded plications, the cardinal margin rounding into the cardinal area. Surface marked by strong concentric, lamellose lines of growth. Brachial valve not seen.

The dimensions of the type specimen, a pedicle valve, are: length 10.5 mm., width 11.5 mm., convexity 3 mm.

Remarks. This species is far less abundant in the Glen

Park fauna than the last, only two specimens, both of them pedicle valves, having been observed. The species may at once be distinguished from *D. missouriensis* by its less convexity, its more obtuse and less incurved beak, its flatter cardinal area, its rounded cardinal margins and in the larger number of plications. In these same characters, except the number of plications, the species differs from the allied lamellose, non-punctate, septate Spirifers of the lower Mississippian faunas.

NUCLEOSPIRA MINIMA n. sp.

Plate 1, figs. 29-30.

Description. Shell small, subcircular in outline, lenticular, the two valves subequally convex. Pedicle valve with a narrow, shallow median sinus, a little more gibbous on the umbo than the brachial valve. Brachial valve flattened along the median line and sometimes slightly depressed, but without the narrow sinus of the pedicle wave. Surface of both valves marked only by fine concentric lines of growth.

The dimensions of a pedicle valve of average size are: length 4 mm., width 4.5 mm., convexity 1.5 mm. The largest specimen observed has a length of 5 mm.

Remarks. This species is a close ally of *N. concinna* Hall, from the Hamilton fauna of the east, but besides being always much smaller than that species, it has the two valves more nearly equally convex. In none of the Glen Park specimens are there any of the fine spines of *N. concinna* shown, but their absence may be due to the state of preservation of the shells.

SEMINULA sp. undet.

A small athyroid shell of the type of *Seminula* occurs in the Glen Park fauna, but all the specimens observed are too imperfectly preserved for identification or description. The specimens vary from 5 to 13 mm. in length, the pedicle valves are usually longer than wide while the brachial valves are more nearly subcircular.

MOLLUSCA.

PELECYPODA.

NUCULA GLENPARKENSIS n. sp.

Plate 2, figs. 1-3.

Description. Shell small, triangular-subovate in outline, width about five-sixths the length, beaks of the two valves closely approximate or in contact above the hinge-line and situated one-fourth the length of the shell from the anterior extremity. The cardinal margins sloping away from the beaks anteriorly and posteriorly with an angle of about 105 degrees; posterior margin sharply rounded or subangular, ventral margin convex and curving regularly into the rounded anterior margin. Valves strongly convex, gibbous in the umbonal region, umbonal ridge not defined. Surface marked with fine concentric lines which are frequently nearly obsolete so that the shells appear to be smooth until examined with a magnifying glass.

The dimensions of two complete specimens are: length 6.5 and 6 mm., width 5.5 and 5 mm.; thickness through both valves 4 and 3.5 mm. The dimensions of one of the largest specimens observed, a left valve, are: length 9 mm., width 7.5 mm., convexity 3 mm.

Remarks. This species resembles *N. corbuliformis* Hall, but is smaller, with the beaks situated farther forward and with less conspicuous concentric markings. Of the Mississippian species of the genus it is perhaps more closely allied to *N. shumardana* of the Spergen Hill fauna, but the beaks of that species are much more anterior in position.

NUCULANA DIVERSOIDES n. sp.

Plate 2, figs. 4-5.

Description. Shell small, elongate-subovate in outline, sub-cuneate behind, the width a little more than one-half the length. Beaks prominent, incurved above the hinge-line, situated about one-third the length of the shell from the anterior extremity. Cardinal margin slightly convex from the beak anteriorly, and concave posteriorly to the posterior

margin which is very short and sharply rounded; ventral margin slightly convex posteriorly, becoming gradually more curved anteriorly where it passes into the regularly rounded anterior margin. Valves rather strongly convex anteriorly, the umbo prominent, becoming gradually more depressed posteriorly, the umbonal ridge subangular, following the postero-cardinal margin of the shell, the cardinal slope from the ridge nearly vertical, in larger specimens even undercut so that in a direct view of the valve the slope cannot be seen. Surface marked with very fine, regular, concentric lines, about five or six occupying the space of one millimeter.

The dimensions of two specimens, one right and one left valve, are: length 16 and 10.5 mm., width 9 and 6.2 mm., convexity 3.75 and 3 mm.

Remarks. This little shell is a close ally of *N. diversa* Hall, from the Hamilton fauna of New York, but it may be distinguished from that species by the more abrupt cardinal slope from the umbonal ridge, in the Hamilton shell the surface of the slope being clearly visible in a direct view of the valve, while in the Glen Park species it can only be seen in a cardinal view. In the Glen Park species also, the posterior extremity of the shell is less angular than in the Hamilton species. This species is an exception to most of those in the Glen Park fauna with close relatives in the Hamilton fauna, in that it is larger than its Hamilton ally, 11 mm. being the longest specimen of *N. diversa* recorded by Hall, while the Glen Park species attains a length of at least 16 mm., although about 10 mm. is the usual length.

Several species similar to *N. diversoides* have been described by Herriek from the Waverly formations of Ohio. Of these *N. spatulata* has a more sharply angular posterior extremity than *N. diversoides*, and *N. similis* has a much more strongly curved ventral margin. The same author has identified other similar shells with *N. diversa* Hall. *N. saecata* (Win.), is another closely related species originally described from the higher "yellow sandstone" at Burlington, Iowa, and later identified by Herriek in the Waverly; this species seems to be more elongate than the Glen Park speci-

mens and is more acuminate posteriorly. This whole group of species are intimately related one to another and they need further study to determine their true relationships. This can only be accomplished with the aid of much more extensive collections than are at present available, but when it is done it is possible that some of the species mentioned will prove to be synonyms.

MACRODON SULCATUS n. sp.

Plate 2, figs. 6-9.

Description. Shell equivalved, of medium size, subovate to subelliptical in outline, widest posteriorly, width one-half or a little more than one-half the length, beaks situated anteriorly but not terminal, prominent, elevated above the hinge-line; hinge-line three-fifths to three-fourths the total length of the shell. Dorsal margin straight along the hinge-line, obtusely subangular at each end where it joins the anterior and posterior margins; posterior margin broadly rounded, sometimes obliquely subtruncate above, the greatest posterior extension of the shell below the middle; ventral margin usually straight through the greater portion of its length, curving upward in front and behind, sometimes slightly convex throughout; anterior margin short, regularly rounded. Valves gibbous in the umbonal region, the umbonal ridge merging into the general convexity of the valve posteriorly; the cardinal slope from the umbonal ridge concave, very abrupt near the beak, becoming more gentle, posteriorly; the ventral slope longer and more gentle than the dorsal, with a broad flattened area or a broad, shallow sinus extending obliquely from the umbo to the middle of the ventral margin. Surface marked by regular, concentric lines separated along the posterior half of the umbonal ridge by intervals of one-half to one millimeter, or occasionally by wider intervals, and towards the beak by smaller intervals; also marked in unworn specimens, upon the posterior half of the shell and especially on the cardinal slope, with very fine, radiating, costae which are interrupted at the concentric lines. Hinge straight, with two or three small oblique teeth anterior to the beak, and one or two posterior teeth subpar-

allel to the hinge-line; ligament external, attached to a narrow, elongate, flattened area which is longitudinally striate.

The dimensions of three specimens are: length, 16, 13 and 11.3 mm.; width, 8, 7.5 and 6 mm.; length of hinge-line, 11, 7.5 and 8 mm.; convexity, 4.5, 3.5 and 3 mm.

Remarks. This is one of the common species in the Glen Park fauna. It is closely allied to *M. hamiltoniae* from the New York Hamilton fauna, but seems to be sufficiently distinct by reason of the much finer radiating markings of the shell, which can only be detected with a magnifying glass upon the best preserved specimens, while upon the Hamilton shells they appear to be much more conspicuous, judging from the illustrations alone. The Glen Park shells also differ from *M. hamiltoniae* in the flattened area or broad shallow sinus which extends obliquely across the ventral slope from the beak to the ventral margin; the importance of this sinus in the surface contour of the shells varies considerably, but it is rarely absent altogether and is sometimes a very conspicuous feature; in *M. hamiltoniae*, on the other hand, it is usually absent altogether, and in the illustrations of that species is only shown on the larger individuals. The difference in size is also a distinction between the two species, the Glen Park specimens never attaining the large size of *M. hamiltoniae*.

Another species with which *M. sulcatus* may be compared is *Elymella missouriensis* M. & G., from the Chouteau limestone of Central Missouri. The type of this species has not been available for examination but a specimen so identified from the Northview sandstone of Webster County, Missouri,* has much more regular and stronger concentric markings. A further cleaning of this specimen, however, has exhibited a long posterior tooth parallel with the hinge line, and the species should doubtless be referred to the genus *Macrodon*, not far removed from *M. hamiltoniae* and *M. sulcatus*. Another specimen in the collections of Walker Museum, labelled *Elymella missouriensis* from Chouteau Springs, Missouri, has

* Traus. St. Louis Acad. Sci., vol. 9, p. 34, pl. 3, fig. 9.

even more nearly the aspect of *M. hamiltonae* than specimens of *M. sulcatus* from Glen Park.

SCHIZODUS APPRESSUS (Con.).

Plate 2, figs. 10-11.

Nuculites appressa Con., Jour. Acad. Nat. Sci. Phil., vol. 8, p. 248, pl. 15, fig. 4, (1842); *Schizodus appressus* Hall, Prelim. Notice Lamell., 2, p. 95, (1870); *Schizodus Cayuga* Hall., Prelim. Notice Lamell., 2, p. 95, (1870); *Cytherodon appressus* Hall, 23rd Rep. N. Y. St. Mus. Nat. Hist., expl. pl. 14, fig. 20, (1872); *Cytherodon (Schizodus) appressus* Hall, Pal. N. Y., vol. 5, pt. 1, plates and explan., pl. 75, figs. 3-9, (1883); *Schizodus appressus* Hall, Pal. N. Y., vol. 5, pt. 1, p. 449, pl. 75, figs. 3-9, (1885).

This is one of the less common species of pelecypods in the Glen Park fauna. A careful comparison of the specimens with Halls illustrations of *S. appressus* fails to reveal characters sufficiently marked to allow it to be separated from that species of the Hamilton fauna in New York State. The Glen Park specimens, perhaps, have the beak slightly more anterior in position with the anterior marginal slope from the beak a little more abrupt, and none of the Glen Park specimens attain so large a size as the larger ones of the New York specimens.

Another allied species is *S. chemungensis* (Con.), of the New York Chemung fauna,* which is probably genetically related to *S. appressus* of the preceding Hamilton fauna. The Glen Park specimens, however, resemble the Hamilton shell much more closely than they do the Chemung species. Herrick has described another closely related species from the Ohio Waverly, under the name *S. prolongatus*.†

MODIOMORPHA LAMELLOSA n. sp.

Plate 2, figs. 12-13.

Description. Shell equivalved, rather small for the genus, obliquely subovate in outline, widest posteriorly, width one-half or a little more than one-half the length, beaks small, subangular, flattened, directed forward, nearly terminal. Dorsal margin arcuate, curving into the posterior margin

* Pal. N. Y., vol. 5, pt. 453, pl. 75, figs. 37-40, 45.

† Bull. Sci. Lab. Den. Univ., vol. 4, p. 36, pl. 6, fig. 1.

which is convex above and rather abruptly rounded below into the nearly straight or slightly concave ventral margin, the anterior margin short and abruptly rounded, produced somewhat beyond the beaks in the younger specimens but nearly equal with the beaks in older individuals. Valves depressed convex, with an arcuate, more or less subangular umbonal ridge extending from the beak to the postero-ventral margin, becoming less well defined posteriorly; a flattened area or slight sinus extends from the beak obliquely backward across the ventral slope to about the middle of the ventral margin. Surface marked with strong, crowded, concentric lines of growth which become sublamellose toward the margin of the valves.

The dimensions of three specimens are: length 24, 22, 18 mm., width 13.5, 12, 9 mm., convexity 5, 4, 3 mm.

Remarks. This species has its closest relative in *Mollinomorpha concentrica* (Con.), of the Hamilton fauna in New York State. It differs from that species in being more arcuate, in having less regular and more lamellose concentric markings, and in the more anterior position of the beaks.

MODIOLA MISSOURIENSIS n. sp.

Plate 2, figs. 14-17.

Description. Shell equivalved, of medium size, obliquely subovate in outline, widest posteriorly, width about two-thirds the length, beaks nearly terminal, small, incurved. Dorsal margin arcuate, curving regularly into the broadly rounded posterior margin, ventral margin slightly convex posteriorly with a shallow byssal sinus anteriorly, in front of which it curves up rather abruptly into the short, subtruncate anterior margin. Valves strongly convex, umbonal ridge well defined towards the beak, merging into the general convexity of the shell posteriorly; the surface sloping abruptly from the umbonal ridge to the dorsal margin, much more gently to the ventral margin; an indistinct flattening or slight sinus, sometimes nearly or quite obsolete, extends from near the beak obliquely backward across the ventral slope to the ventral margin just back of the byssal sinus. Surface marked with concentric lines of growth which are more frequent towards

the margin of the shell and which usually become stronger and more or less irregular above the shallow byssal sinus. Hinge arcuate with a blunt, tooth-like callosity beneath the beake in the right valve.

The dimensions of a large right valve are: length 22 mm., width 15.5 mm., convexity 7 mm.; those of a smaller left valve are: length 17 mm., width 11.5 mm., convexity 5 mm.

Remarks. This species has its nearest relative in the little shell described as *Modiomorpha northviewensis* Weller, from the Northview sandstone of southwestern Missouri.* The two shells are certainly cogenetic, and it is possible that if more perfect material from the Northview sandstone could be had, they would prove to be the same species. The Northview species, of which a single specimen has been observed, is less strongly convex and is proportionally somewhat wider posteriorly than the shells from Glen Park, and for the present the two species will be considered as distinct. The reference of the species to the genus *Modiola* must be considered as tentative; it agrees more closely with this genus than with any other, but should possibly be considered as distinct on account of its hinge structure.

CYPRICARDINIA SUBCUNEATA n. sp.

Plate 2, figs. 18-19.

Description. Shell small, subovate to subelliptical in outline, length about twice the width, beaks nearly terminal. Dorsal margin nearly straight or slightly arcuate from opposite the beak to the posterior extremity of the hinge-line, posterior margin meeting the dorsal margin in an obtusely rounded angle, sloping obliquely backward and downward with a slightly convex curve to the sharply rounded, subcuneate postero-ventral margin, ventral margin subparallel with the dorsal, slightly sinuate near the middle and curving rather abruptly upward in front into the short, sharply rounded anterior margin. Valves strongly convex, umbonal ridge arcuate, well defined, extending from the beak to the postero-ventral margin; the surface sloping abruptly from the um-

* Trans. Acad. Sci. St. Louis, vol. 9, p. 28, pl. 4, fig. 19.

bonal ridge to the dorsal margin, the ventral slope much broader and more gentle, with a shallow sinus extending from the beak obliquely backward to the sinuosity in the ventral margin. Surface marked with more or less regular sublamellose, subimbricating, concentric undulations, which are less than one-half millimeter apart upon the umbonal ridge where they are most distant.

The dimensions of three specimens are: length, 9, 10.5 and 12 mm.; width 4.5, 5 and 6 mm.; convexity, 2, 2, and 3.5 mm.

Remarks. This species is one of the most abundant forms in the Glen Park fauna, innumerable individuals being present throughout the limestone. It resembles *C. indenta* (Con.) from the Onondago and Hamilton faunas of New York, but differs from that species in the character of its surface markings, none of the fine radiating lines of *C. indenta* having been observed; it is also a proportionately narrower shell than that, and never grows so large as the larger individuals of the Hamilton species. Other species cogeneric with this species occur in the Waverly faunas of Ohio, in the Kinderhook at Burlington, Iowa, as well as in the Spergen Hill fauna of Indiana and in the Coal Measures, but the Glen Park species is clearly distinct from all of these.

GASTROPODA.

PTYCHOMPHALUS MISSOURIENSIS n. sp.

Plate 2, figs. 25-26.

Description. Shell small, imperforate, with about four volutions, apical angle 70° - 80° , the suture impressed, the volutions rounded on the periphery, the aperture subcircular in outline; slit-band narrow, bounded by slightly elevated costae between which the surface is slightly convex, the elevation of the center of the band being about even with the tops of the bounding costae. Surface of the shell above the band, marked by transverse costae somewhat stronger toward the suture, which curve backward as they approach the peripheral band, about four or five occupying the space or one millimeter, this same surface is marked also by somewhat finer

revolving costae about ten in number, the first two or three above the peripheral band being finer than the others, these two sets of markings give to the upper surface of the volutions a reticulate ornamentation; the peripheral band marked by transverse costae concave outward, about equal in size or a little coarser than the transverse costae above the band and as about twice as numerous, giving to the band a crenulate appearance; below the peripheral band the surface is marked by numerous fine, revolving costae and by fine transverse costae, both sets of markings being much finer than those upon the upper surface of the volutions.

The dimensions of a nearly perfect specimen of average size are: height, 6 mm.; maximum diameter, 6 mm.; height of aperture, 3.3 mm.; width of aperture, 3.3 mm. largest specimen observed, an imperfect one, has a maximum diameter of 8 mm.

BELLEROPHON ULRICHI n. sp.

Plate 2, figs. 20-23.

Description. Shell of medium size, umbilicate, with about three volutions in the adult; outer volution ventricose, increasing in size regularly to near the aperture where it is more or less abruptly expanded, cross-section of the volutions subelliptical. Aperture subelliptical, the outer lip thin and sometimes somewhat produced with a shallow dorsal notch one millimeter or less in depth, the inner lip extended over the volution and much thickened laterally around the umbilicus. Surface marked with a dorsal band extending from the shallow dorsal slit, which is usually somewhat smoother than the lateral surfaces, it is even with the general surface of the shell or sometimes slightly depressed, until it approaches the aperture when it is gradually elevated, becoming conspicuously elevated upon the abruptly expanding portion of the shell at the aperture. The lateral surfaces of the shell marked with fine, more or less regular, transverse lines of growth which are often inconspicuous except towards the aperture where they become more irregular and more or less crowded, as they approach the dorsal band they bend backwards around the dorsal notch.

The dimensions of a small specimen are: width of shell at aperture 14 mm., extreme length of shell 12 mm., height of shell from plane of aperture 7.5 mm. The dimensions of one of the largest specimens are: width of aperture 17 mm., length of shell 16.5 mm.

Remarks. This species is quite distinct from any of the Devonian or Mississippian species heretofore described, and unlike so many species in the fauna, it seems to have no close ally in the Hamilton faunas of New York. In form and proportions it approaches *B. bilabiatum* W. & W., from the Chonopectus fauna of the Kinderhook at Burlington, Iowa, but the dorsal slit is very much shallower than in that species and the elevated portion of the dorsal band is much shorter and much less sharply carinate. The species occurs in abundance in the Glen Park fauna, and exhibits considerable variation although the variation is for the most part in the adult or very old shells and is largely restricted to the more abruptly expanded portion of these shells near the aperture.

The species is named in honor of Mr. E. O. Ulrich of the U. S. Geological Survey, who first called the writer's attention to this interesting fauna.

BELLEROPHON JEFFERSONENSIS n. sp.

Plate 2, fig. 24.

Description. Shell small, umbilicate, the outer volution flattened on the dorsum, increasing regularly in size, moderately expanded near the aperture. Aperture subelliptical in outline, with a very shallow dorsal notch. Surface marked with a flat or slightly depressed dorsal band which is crossed by very fine lines of growth following the direction of the dorsal slit; the sides of the shell marked by regular transverse costae much coarser than the lines of growth across the dorsal band.

The dimensions of a large specimen are: width of aperture 10 mm., length of shell 10.6 mm., height of shell above plane of aperture 7 mm.

Remarks. This is one of the rarer species in the Glen Park fauna, and at first it was thought to be a variation of the last species. The two species are evidently related, but *B.*

jeffersonensis may be distinguished by its smaller size, its less flaring aperture, its more flattened dorsum and its much more regular transverse costae.

TROPIDODISCUS CYRTOLITES (Hall).

Plate 2, fig. 29.

Bellerophon cyrtolites Hall., 13th Rep. N. Y. St. Cab. Nat. Hist., p. 107, (1860); *Bellerophon cyrtolites* Win., Proc. Acad. Nat. Sci. Phil., p. 426, (1862); *Bellerophon cyrtolites* Win., Proc. Acad. Nat. Sci. Phil., p. 18, (1863); *Bellerophon cyrtolites* Win., Proc. Acad. Nat. Sci. Phil., p. 131, (1865); *Bellerophon cyrtolites* M. & W., Geol. Surv. Ill., vol. 2, p. 160, pl. 14, figs. 8a-b, (1866); *Bellerophon cyrtolites* Win., Proc. Am. Phil. Soc., vol. 11, p. 257, (1870); *Bellerophon cyrtolites* Herrick, Bull. Sci. Lab. Den. Univ., vol. 3, p. 88, pl. 2, figs. 27, 29, pl. 8, figs. 20, 21, pl. 9, figs. 29, 31, (1888); *Tropidodiscus cyrtolites* Weller, Trans. Acad. Sci., St. Louis, vol. 9, p. 89, pl. 5, figs. 8-9, (1899).

This species is one of the rarest members of the Glen Park fauna, but the specimens observed are indistinguishable from those occurring elsewhere in the Kinderhook formations. The species was first described from the Kinderhook goniatite bed at Rockford, Indiana, but it has been recognized in the Waverly beds of Ohio, in the Marshall beds of Michigan, and the "yellow sandstone" at Burlington, Iowa. In the collections of Walker Museum the species is represented by specimens from the Northview sandstone of Webster County, Missouri, and from the Chouteau limestone of Pettis County, Missouri. Wherever the species has been observed by the writer it is rare, yet it is one of the forms having a wide geographic distribution. The species has no known near relative in the Hamilton faunas of the east, but it is cogenetic with *Bellerophon curvilineatus* Con., of the eastern Onondaga fauna.

NATICOPSIS PAUCIVOLUTUS n. sp.

Plate 2, figs. 27-28.

Description. Shell small, ventricose, imperforate, with two and one-half or three volutions which increase rapidly in size. Spire low, apical angle 80°-85°, the suture strongly impressed and regularly increasing in depth towards the aperture, outer volution very much larger than those within, its height nearly three-fourths the entire height of the shell.

Aperture subcircular, the outer lip thin, the inner lip thickened by a flat callosity upon the columella. Surface marked by very fine transverse lines of growth.

The dimensions of an average individual are: height 7.25 mm., maximum diameter 7.25 mm., width of aperture 5 mm., height of aperture 5.5 mm.

Remarks. This is a common species in the fauna and may be easily distinguished from other members of the genus by reason of its small size, the small number of volutions, and the ventricosity of the outer volution.

PLATYCERAS ERECTOIDES n. sp.

Plate 2, figs. 34-35.

Description. Spire close coiled at the apex for about one and one-half volutions, beyond which the body volution is free; somewhat rapidly expanding, often more or less spreading near the aperture. Aperture subcircular, subovate or subelliptical in outline, usually more or less sinuate. Dorsum rounded or subangular, the two sides of the shell usually nearly equal. Surface marked by fine, closely arranged, undulating lines of growth which are not conspicuously lamellose.

The dimensions of an average specimen are; height 15 mm., length of aperture 14 mm., width of aperture 13 mm.

Remarks. This species is sufficiently distinct from all the Kinderhook and other Mississippian members of the genus, but it closely resembles *P. erectum* Hall, of the New York Hamilton fauna. The Glen Park specimens seem to agree exactly with this Hamilton species in general form and proportions, although it seems never to grow so large as that species. The only difference between the two shells which seems to be of specific value, is the lack of conspicuously lamellose lines of growth in the Missouri shell. This character seems to be a good one as the shells apparently have not been water worn or eroded.

PLATYCERAS EVOLUTUS n. sp.

Plate 2, figs. 32-33.

Description. Shell small, arcuate, the apex oblique and

incurved nearly in the plane of the right side of the shell, with the first volution or volution and one-half close coiled; gradually expanding from apex to aperture; dorsum sharply rounded or subangular, the free portion of the shell obliquely compressed. Aperture narrowly subelliptical in outline, more or less sinuous. Surface marked with more or less irregular non-lamellose lines of growth.

The dimensions of a nearly complete specimen are: height 8 mm., maximum diameter of aperture 6 mm., minimum diameter of aperture 4 mm.

Remarks. This species is quite distinct from any of those members of the genus which have been described from the Kinderhook faunas, but it is closely allied to the Hamilton species *P. thetis* Hall. The Glen Park specimens are smaller than those of the Hamilton fauna and lack the conspicuous lines of growth. The most notable difference, however, is in the oblique compression of the free portion of the shell and the consequent narrowly elliptical outline of the aperture, the aperture of *P. thetis* being "nearly round or subquadrangular."

PLATYCERAS GLENPARKENSIS n. sp.

Plate 2, figs. 30-31.

Description. Shell below medium size, strongly compressed, rapidly expanding from apex to aperture; the apex incurved, lying nearly in the plane of the right side of the shell, the first one or one and one-half volutions closely coiled, the dorsum sharply rounded or subangular; the aperture narrowly subelliptical in outline, more or less sinuous. Surface marked by irregular, nonlamellose lines of growth, sometimes forming wrinkle-like constrictions of the shell.

The dimensions of a large individual are: height 9 mm., maximum diameter of aperture 10 mm., minimum diameter of aperture 5.5 mm.

Remarks. This shell has somewhat the aspect of the species that has been described as *Strophostylus broadheadi* S. A. M., from the Chouteau limestone of central Missouri,

but that species does not have the outer volution free and is apparently a true *Strophostylus*.

ORTHONYCHIA JEFFERSONENSIS n. sp.

Plate 2, figs. 38-39.

Description. Shell subpyramidal in form, slightly oblique, higher than wide, subsemicircular in cross-section, the sides of the shell slightly convex from the apex to the margin of the aperture except at the side towards which the obliquity of the shell is directed which is nearly straight or slightly concave. The surface marked by vertical plications and by rather fine, more or less irregular lines of growth which follow the sinuosities of the aperture.

The dimensions of a typical specimen are: height 22 mm., diameter of aperture 16.5 mm.

Remarks. This species does not closely resemble any of the Hamilton species of the genus nor any of those present in the Kinderhook or other Mississippian faunas.

ORTHONYCHIA UNGULA n. sp.

Plate 2, figs. 36-37.

Description. Shell arcuate and slightly twisted, compressed, entirely uncoiled, expanding gradually from apex to aperture, the aperture subelliptical in outline. Surface marked by more or less coarse and irregular lines of growth, giving to the shell, sometimes, a very rough appearance.

The dimensions of the type specimen are: height 26 mm., maximum diameter of aperture 10 mm., minimum diameter of aperture 6.5 mm.

Remarks. This species is entirely unlike any of those recognized in either the Mississippian or the higher Devonian faunas. It may be easily recognized by its peculiar claw-shaped form. One of the specimens referred to the species is more curved, more rapidly expanding and smoother than the type specimen, and it should possibly be considered as a distinct species.

VERTEBRATA.

PISCES.

PTYCTODUS EASTMANI n. sp.

Plate 1, figs. 31-32.

Occasional abraded tritors of a species of *Ptyctodus* occur in the Glen Park limestone, and one nearly perfect specimen of a complete dental plate has been observed. The abraded specimens are indistinguishable from similar specimens of *P. calceolus* N. & W., found in the Devonian at many localities in the Mississippi valley, but the complete specimen preserves characters which distinguish it from that species as it has been illustrated by Eastman.* The most notable characteristic of the Glen Park species as distinguished from *P. calceolus*, is in the lower margin of the tooth, this margin describing a continuous slightly concave curve from the posterior to the anterior extremities, while in *P. calceolus* this margin is convex from the posterior extremity to a conspicuous sinus below the anterior extremity of the tritor, and then convex again nearly to the anterior extremity of the symphyseal beak where there is a conspicuous downward extension of the tooth. The upper surface also differs from *P. calceolus* in having a less conspicuous differentiation between the tritorial and the symphyseal regions.

The Glen Park species is named in honor of Dr. C. R. Eastman, who has done so much valuable work upon the Paleozoic fishes.

CONCLUSION.

A critical analysis of the Glen Park fauna brings out several features of great interest. A study of its relationships to other faunas shows it to be allied in two directions, on the one hand to the faunas of the Hamilton formation of the east, giving it a strong Devonian aspect, and on the other hand with the Kinderhook faunas of the Chouteau limestone and associated formations in Missouri and elsewhere. Although most of the species appear to be distinct from their Hamilton

* Iowa Geol. Surv., vol. 7, p. 115; Am. Nat., vol. 32, p. 477.

relatives, this relationship must be considered as genetic. The following list of species with their Hamilton analogues are present in the fauna: —

GLEN PARK.	HAMILTON.
<i>Orthothetes chemungensis</i> (Con.)	<i>Orthothetes chemungensis</i> (Con.).
<i>Eunella compressa</i> n. sp.	<i>Eunella lincklaeni</i> (Hall).
<i>Atrypa spinosa</i> Hall.	<i>Atrypa spinosa</i> Hall.
<i>Nucleospira minina</i> n. sp.	<i>Nucleospira concinna</i> Hall.
<i>Nucula glenparkensis</i> n. sp.	<i>Nucula corbuliformis</i> Hall.
<i>Nuculana diversoides</i> n. sp.	<i>Nuculana diversa</i> Hall.
<i>Macrodon sulcatus</i> n. sp.	<i>Macrodon hamiltoniae</i> Hall.
<i>Schizodus appressus</i> (Con.)	<i>Schizodus appressus</i> (Con.).
<i>Modiomorpha lamellosa</i> n. sp.	<i>Modiomorpha concentrica</i> (Con.).
<i>Cypricardinia subcuneata</i> n. sp.	<i>Cypricardinia indenta</i> (Con.).
<i>Platyceras erectoides</i> n. sp.	<i>Platyceras erectum</i> Hall.
<i>Platyceras evolutus</i> n. sp.	<i>Platyceras thetis</i> Hall.

The presence of the species of the genus *Ptyctodus* is another characteristic of the fauna strongly suggestive of its Devonian age; although this genus has never been recognized in the Hamilton faunas of New York, it is not an uncommon member of the later Devonian faunas of the Mississippi valley, and has never been recorded from any fauna of unquestioned Mississippian age. The entire absence from the fauna of all members of the genus *Productus* is another notable characteristic which suggests its Devonian age.

Notwithstanding this unquestioned strong Devonian aspect of the Glen Park fauna, there are several species which point to a relationship with the Kinderhook fauna of Southern and Central Missouri, the fauna which has its typical expression in the Chouteau limestone and in other contemporaneous formations. This Chouteau element in the fauna is not so large as the Devonian element, and consists of the following species with their analogues: —

GLEN PARK.	CHOUTEAU.
<i>Orthothetes chemungensis</i> (Con.)	<i>Orthothetes chemungensis</i> (Con.).
<i>Chonetes glenparkensis</i> n. sp.	<i>Chonetes logani</i> N. & P.
<i>Delthyris missouriensis</i> n. sp.	<i>Delthyris solidirostris</i> (White).
<i>Macrodon sulcatus</i> n. sp.	<i>Macrodon missouriensis</i> (M. & G.).
<i>Modiola missouriensis</i> n. sp.	<i>Modiola northviowensis</i> Weller.
<i>Tropidodiscus cyrtolites</i> (Hall).	<i>Tropidodiscus cyrtolites</i> (Hall).

Aside from these species, the presence of the crinoid genera *Agaricocrinus* and *Actinocrinus*, if these identifications be

correct, are strong indications of the lower Mississippian age of the fauna, and offset the presence of such Devonian forms as *Ptyctodus* and *Atrypa spinosa*. In balancing these two elements in the fauna, especial attention should be given to the presence of the younger element, this being more significant than the presence of the forms which are hold-overs from an earlier fauna, especially since these hold-over forms are so much modified as to be specifically distinct from their earlier representatives in almost every instance.

The true time relations of the Glen Park fauna are best shown by making comparison with a similar fauna from an oolite bed at Hamburg, Calhoun County, Illinois, which is the only fauna so far known containing any considerable number of Glen Park species. The lowermost Mississippian beds at Hamburg lie unconformably upon a formation bearing a middle Devonian fauna of the Iowan type, and two sections through the beds at that locality clearly show the stratigraphic relations of the faunas of Kinderhook age. Section A is along the creek at the south edge of the village of Hamburg, starting from the bridge and running up the creek. Section B is along the bank of the Mississippi river from the mouth of the creek just south of the village to a point about one mile north. These two sections will be described in parallel columns, beginning with the lowermost beds.*

SECTION A.

1. Massive light colored limestone with a few inches of clay shale near the base. Fossils not abundant, mostly a species of *Atrypa*.

Thickness, 18 feet.

2. Arenaceous shaly flags passing into limestone above, with a middle Devonian fauna of Iowan type.

Thickness, 3-4 feet.

SECTION B.

1. Massive light colored limestone as in section A.

2. Same as in section A.

* These sections were made by Mr. R. S. Bassler of the United States National Museum, and have been generously furnished to the writer by Mr. E. O. Ulrich of the United States Geological Survey. The writer is also indebted to Mr. Ulrich for the opportunity of studying the fauna of these Hamburg oolites.

3. Soft green shale. Thickness, 1 foot.
4. Much fractured, fine-grained, gray limestone with lithologic characters identical with the typical Louisiana limestone of Missouri, and containing the characteristic fauna of that formation. Thickness, 4 feet.
5. Brown sandy shales with hard flaggy layers. Thickness, 8 feet.
6. Blue shales; somewhat fissile and without flaggy layers. Thickness, 12 feet.
7. Fossiliferous oolite limestone. Thickness, $\frac{1}{2}$ -2 inches.
8. Blue shales apparently without fossils. Thickness not estimated.
9. Covered space with slabs of "Vermicular" sandstone.
10. Burlington limestone to top of hill.
3. Probably shale, not exposed.
4. Same as in section A. The fossils most abundant at the top. Thickness, 5 feet.
5. Same as in section A. Thickness, 1-2 feet.
- 6-7. White to yellow or flesh colored oolitic limestone with interbedded layers of sandy shales. Oolite full of fossils. Thickness, \pm 15 feet.
- 8-9. Covered space with evidences of "Vermicular" sandstone.
10. Burlington limestone.

In this Hamburg section the oolite bed No. 7 in section A, with a thickness of two inches or less, increases to 15 feet in section B, and apparently replaces the blue shales, bed No. 6, of section A, and possibly also the upper portion of bed No. 5. These oolites are abundantly fossiliferous and have furnished the following species, those marked with an asterisk being also recognized in the Glen Park fauna.

- **Orthothetes chemungensis* (Con.).
- **Chonetes* sp.
- Camarophoria?* sp.
- Camarotoechia?* sp.
- Centronella?* sp.
- **Eunella compressa* n. sp.
- Cryptonella?* sp.
- Delthyris* sp.
- **Nucula glenparkensis* n. sp.
- **Nuculana diversoides* n. sp.
- **Macrodon sulcatus* n. sp.
- **Schizodus appressus* (Con.).
- Lithophaga?* sp.
- Ptychonphalus* sp.

An examination of this Hamburg fauna shows that 50 per

cent of the species recognized occur also in the Glen Park fauna, none of the remaining forms being identified specifically. Several of the unidentified forms are certainly undescribed species, some are members of genera represented in the Glen Park fauna by undetermined species, and in a few instances may prove to be identical with Glen Park species, in which case the percentage of identical species in the two faunas will be increased. Notwithstanding the strong similarity between the Hamburg and Glen Park faunas, the dominant species in the two localities are quite different, the most common members of the Glen Park fauna being absent from Hamburg, and the most common Hamburg species being absent from Glen Park. Furthermore the species common to the two localities are usually represented by larger individuals at Hamburg than at Glen Park.

The presence of this fauna at Glen Park and Hamburg may not have been strictly contemporaneous, but its occurrence at the two localities is without doubt associated with the same wave of migration and the fauna at the two localities may be considered to be synchronous within comparatively narrow limits.

The stratigraphic position of the fauna at Hamburg in relation to the Louisiana limestone fauna is of prime importance in determining the true relations of all the Kinderhook beds of south-eastern Missouri. In its typical expression in Pike County, Missouri, the Louisiana limestone attains a thickness of from fifty to sixty feet, the known fauna being restricted to a few feet at the base of the formation. At Hamburg the same formation in its typical expression is only four or five feet in thickness, the fauna being essentially identical in all respects with that of the lower few feet of the formation at Louisiana, Missouri. Beds No. 8 and No. 9 of the Hamburg section are apparently a continuation of the Hannibal shales and sandstones of the Louisiana section, so that beds 5, 6 and 7 of the Hamburg section may be included with bed 4, as the essential time equivalent of the whole Louisiana limestone.

If this interpretation is correct, the time during which the

oolite with its peculiar fauna was deposited at Hamburg was essentially contemporaneous with the deposition of the uppermost beds of the Louisiana limestone in the Pike County, Missouri, section. The time of deposition of the Glen Park limestone may have been slightly earlier than that of the Hamburg oolite, but it may be safely considered to be contemporaneous with the deposition of some portion of the typical expression of the Louisiana limestone, and doubtless with some portion of the upper half of the formation.

One of the most striking features of the Glen Park fauna is that its Devonian relationships are more close with the Hamilton fauna than with the Chemung, the latter of which is supposedly a younger fauna than the Hamilton, and one whose position in the standard time scale is placed between the Hamilton and the base of the Mississippian. The explanation of this doubtless lies in certain facts connected with the history and migrations of the Hamilton fauna not yet sufficiently well understood.

On comparing the Glen Park fauna with the older Kinderhook fauna present in the section at Burlington, Iowa, the fauna characterized by the genus *Chonopectus*, a notable difference is recognizable. There is not a single species common to the two faunas, and while both exhibit close Devonian relationships, the alliance of the *Chonopectus* fauna is with the Chemung faunas of the New York section, while the alliance of the Glen Park fauna is with the Hamilton as has already been pointed out. Furthermore, the Glen Park fauna also exhibits, as has been shown, close relationships with the general Kinderhook fauna of central and southern Missouri, the Chouteau fauna, a fauna which appears in the Burlington section only in the higher beds of Kinderhook age at that locality, in beds No. 5 and No. 6 of Weller's section.* The lower Kinderhook fauna of Burlington, the *Chonopectus* fauna, does not occur anywhere in the more southern region occupied by Kinderhook faunas.

A detailed study of the Kinderhook faunas of the entire Mississippi valley region, shows clearly the dual nature of

* Trans. Acad. Sci. St. Louis, vol. 10, p. 61.

the fauna as a whole, each one of the two factors in the fauna having a geographic distribution different from the other. Such a study further shows that in early Kinderhook time there were two distinct faunal province within the present Mississippi valley region, a northern province and a southern province, separated by an east and west line at a point near the mouth of the present Illinois river. Whether this line of separation was actually a land barrier has not yet been shown, but such was probably the case.

The history of events in the northern Kinderhook province is most completely shown in the section at Burlington, Iowa. In this section there are approximately 115 feet of strata exposed, and in this thickness the lower 100 feet are essentially characterized by one general fauna, the *Chonopectus* fauna, although there are some faunule variations in the succession of beds exposed. This is the characteristic fauna of the northern Kinderhook province. Besides its occurrence at Burlington, it is known 60 miles northwest of that locality near Wellman, in Washington County, Iowa, where it occurs in its typical expression in the English River grit, at Maples' mill. It probably occurs, also, still further northwest, 120 miles from Burlington, in Tama and Marshall counties, in the arenaceous beds beneath the Kinderhook limestones of that region, but the fact of such occurrence has not yet been actually confirmed by the writer. South of Burlington the same fauna, somewhat modified but still containing its characteristic elements, occurs in the Kinderhook sandstone at Kinderhook village in Pike county, Illinois, and at this locality there are present in the fauna certain elements that connect it closely with the fauna of the Louisiana limestone. This relationship of the *Chonopectus* fauna as it is exhibited at Kinderhook, Illinois, is of a nature to show without doubt, that the Louisiana limestone fauna is but one facies of the general fauna of the northern Kinderhook province. The Louisiana facies of the fauna, in its typical expression, has been recognized as far south as northern Calhoun county, Illinois, where it occurs at Hamburg on the Mississippi river.

One of the most characteristic elements in the northern

Kinderhook faunas, is the large, finely striated rhynchonelloid shells typically represented by the species originally described as *Rhynchonella striatocostata*, for which the generic name *Paraphorhynchus* has recently been proposed. In the Mississippi valley the genus is known only in the faunas of the northern Kinderhook province, the genus being, indeed, a more characteristic member of the fauna than is *Chonopectus* which has such a remarkable local development at Burlington. Outside of the northern Kinderhook faunas the genus *Paraphorhynchus* occurs in beds referred to the Waverly group, near Warren, Pennsylvania, two species being described by Simpson* from that locality as *Rhynchonella medialis* and *R. striata*, an occurrence which suggests looking for the relationships of the northern Kinderhook faunas in that direction.

The geographic distribution of the southern Kinderhook fauna is very different from its more northern neighbor, although the two faunas were doubtless in existence contemporaneously. This fauna has its most typical expression in the Chouteau limestone of central and southwestern Missouri.† The fauna is present in all the beds of Kinderhook age in Arkansas, and occurs with a slightly different expression in the Kinderhook beds of the Mississippi river section south of St. Louis, extending northward to Jersey county and southern Calhoun county, Illinois. It is also the fauna of the Rockford, Indiana, goniatite beds, and has been recognized southward in Kentucky.

In the latter part of Kinderhook time communication between the southern and northern provinces was established, and the southern fauna migrated northward into the northern

* Trans. Am. Phil. Soc., vol. 15, p. 444.

† In a paper entitled "Correlation of the Kinderhook formations of southwestern Missouri," Jour. Geol., vol. 9, pp. 130-148), the author misinterpreted the Sac limestone described by E. M. Shepard. The fauna given on pages 136-137 of the paper is really the fauna of the southern extension of the typical Chouteau limestone which overlies the Phelps sandstone with its *Ptyctodus* fauna. The confusion of this limestone with the Sac limestone was caused by Shepard's failure to sufficiently differentiate it from his "Hannibal" shale and sandstone, although the bed is a conspicuous one over a wide territory in Green and adjacent counties in Missouri.

province, where it occurs in the Hannibal sandstone of north-eastern Missouri and in beds No. 5 and No. 6, comprising the upper ten or twelve feet of the true Kinderhook of the Burlington section. The earliest expression of this migration from the southern into the northern province is probably shown in the fauna of the Hamburg oolite. The southern fauna also occurs in the limestone above the English River grit of Washington County, Iowa, and the Kinderhook limestone of Marshall and Tama Counties, Iowa, contains a fauna allied to that of the southern province, although another element is present which is foreign to either of the two faunas under discussion.

As has already been indicated, the Devonian relationship of the northern Kinderhook fauna is with the Chemung fauna of the east, while the Devonian relationship of the southern fauna is through the Glen Park fauna with the Hamilton of the east. In explanation of these relationships a tentative suggestion may be made, it being recognized that this suggestion is based upon evidence as yet insufficiently investigated. In the eastern interior sea of later Devonian times, what we call the Chemung fauna, or at least one element in the fauna, is known to have been the invader, it being preceded by the invading "cuboides" and "intumescens" faunas. It is recognized that the resident Hamilton fauna persisted much longer in central and eastern New York than in the western part of the State, the persistent Hamilton fauna of the Ithaca formation being younger than the invading "cuboides" fauna of the Tulley limestone and contemporaneous with the "intumescens" fauna of the western Portage formation. It seems not unreasonable to assume as a working hypothesis, that the Hamilton fauna persisted somewhere in the eastern interior sea, or in the Atlantic basin, probably in the south, until the close of Devonian time, it being in its later stages contemporaneous with the Chemung fauna further north. The Glen Park fauna and one element of the southern Kinderhook fauna may then be considered to have their origin from this persistent Hamilton fauna, at a time contemporaneous with or even somewhat later than the

origin of the northern Kinderhook fauna from the Chemung, although the main portion of the Chouteau fauna is believed to have originated or at least to have migrated from the far west.

EXPLANATION OF PLATES.

Plate I. — 1, *Zaphrentis* sp. undet. — 2-3, *Actinocrinus* ? sp. undet. 4, *Agaricocrinus* ? sp. undet. — 5-6, *Orthotheses chemungensis* (Con.), Two pedicle valves. — 7, *Chonetes glenparkensis* n. sp. — 8-12, *Chonetes* sp. undet. — 13-16, *Eunella compressa* n. sp., Brachial views of four individuals. — 17, *Atrypa spinosa* Hall, Brachial view of the only specimen observed. — 18-22, *Spirifer jeffersonensis* n. sp., two views of one pedicle valve and views of three brachial valves. — 23-26, *Delthyris missouriensis* n. sp., two views of one pedicle valve and views of two brachial valves. — 27-28, *Delthyris suborbicularis* n. sp., two views of a pedicle valve. — 29-30, *Nucleospira minima* n. sp., views of a pedicle and a brachial valve. — 31-32, *Ptyctodus eastmani* n. sp., two lateral views of a nearly perfect tooth.

Plate II. — 1-3, *Nucula glenparkensis* n. sp., left lateral views of three complete specimens. — 4-5, *Nuculana diversoides* n. sp., lateral views of a right and a left valve. — 6-9, *Macrodon sulcatus* n. sp., views of two left and two right valves. — 10-11, *Schizodus appressus* (Con.), lateral views of two right valves. — 12-13, *Modiomorpha lamellosa* n. sp., lateral views of two left valves. — 14-17, *Modiola missouriensis* n. sp., lateral views of three right valves and one left valve. — 18-19, *Cypricardinia subcuneata* n. sp., lateral views of two right valves. — 20-23, *Bellerophon ulrichi* n. sp., dorsal views of three individuals and a view of the aperture of a fourth. — 24, *Bellerophon jeffersonensis* n. sp., dorsal view of a typical specimen. — 25-26, *Ptychomphalus missouriensis* n. sp., lateral view of a nearly complete individual, and an apical view of another less complete one. — 27-28, *Naticopsis paucivolutus* n. sp., lateral views of two specimens, one of them showing the aperture. — 29, *Tropidodiscus cyrtolites* (Hall), lateral view of the most perfect individual observed. — 30-31, *Platyceras glenparkensis* n. sp., right lateral views of two individuals. — 32-33, *Platyceras evolutus* n. sp., right lateral views of two individuals. — 34-35, *Platyceras erectoides* n. sp., right and left lateral views of one specimen. — 36-37, *Orthonychia ungula* n. sp., right lateral views of two individuals, the larger and straighter one being the type of the species. — 38-39, *Orthonychia jeffersonensis* n. sp., lateral views of two individuals.

Issued, December 11, 1906.

PUBLICATIONS.

The following publications of the Academy are offered for sale at the net prices indicated. Applications should be addressed to The Librarian, The Academy of Science of St. Louis, 3817 Olive St., St. Louis, Mo.

TRANSACTIONS (in octavo).

Vol.	Number.	Price per number.	Price per vol.	Price in set.
1	1*		
	2†	\$4.00	\$7.50	\$7.00
	3, 4	2.00 each.	(Nos. 2-4 only.)	(Nos. 2-4 only.)
2	1 to 3	2.00 each.	5.50	5.00
3	1 to 4	2.00 each.	7.50	7.00
4	1 to 4	2.00 each.	7.50	7.00
5	1-2, 3-4	4.00 each. (double numbers)	7.50	7.00
6†	1, 2, 6, 8, 10, 11, 16, 17 4, 5, 7, 13, 14, 15, 18 3, 9 12	25 cts. each.	7.50	7.00
		50 cts. each.		
		75 cts. each.		
		\$1.00		
7†	2, 3, 4, 6, 7, 8; 13, 15, 16, 18, 19 5, 9 to 12, 14, 20 17 1	25 cts. each.	7.50	7.00
		50 cts. each.		
		75 cts.		
		\$1.00		
8†	1, 3 to 6 8, 10, 12 2, 7, 9, 11	25 cts. each.	3.75	3.50
		50 cts. each.		
9†	1, 3, 4, 7, 9 2, 5, 8 6	25 cts. each.	3.75	3.50
		50 cts. each. \$1.25		
10†	9 2, 4, 5, 10 1 3, 6, 7, 8, 11	10 cts.	3.75	3.50
		25 cts. each.		
		40 cts. 50 cts. each.		
11†	2, 3 5-8, 10, 11 1 4 9	15 cts. each.	3.75	3.50
		25 cts. each.		
		45 cts.		
		75 cts. 1.00		
12†	1, 9, 10 5 3, 8 2, 4, 6, 7	25 cts. each.	3.75	3.50
		35 cts.		
		45 cts. each. 50 cts. each.		
13†	2, 3, 5-9 4 1	25 cts. each.	3.75	3.50
		75 cts. 1.50		
14†	2, 3, 6, 7 4, 8 5 1	25 cts. each.	3.75	3.50
		50 cts.		
		75 cts.		
		\$1.00		
15†	1, 3, 4, 5, 6 2	25 cts. each.	3.50	3.25
		50 cts. each.		
		\$1.50		

MEMOIRS (in quarto).

Contributions to the archaeology of Missouri, by the Archaeological Section. Part I. Pottery. 1880. \$2.00.

The total eclipse of the sun, January 1, 1889. A report of the observations made by the Washington University Eclipse Party, at Norman, California. 1891. \$2.00.

* Supply exhausted.

† Can be sold only to purchasers of the entire volume,—so far as this can be supplied.

‡ Each number is a brochure containing one complete paper (or rarely two).

149

Transactions of The Academy of Science of St. Louis

VOL. XVI. NO. 8.

**THE RELATION OF CERTAIN MARINE ALGAE TO
VARIOUS SALT SOLUTIONS.**

B. M. DUGGAR.

Issued December 21, 1906.



THE RELATION OF CERTAIN MARINE ALGAE TO
VARIOUS SALT SOLUTIONS.* †

B. M. DUGGAR.

PLASMOLYTIC STUDIES.‡ — Upon beginning some work on the relations of certain marine algae to solutions I attempted, in March, 1900, to make some measurements of the osmotic pressures in the cells of certain marine algae common at Naples. Solutions of dry potassium nitrate, sodium chloride and cane sugar were prepared in distilled water and in sea water. In the latter solvent the stock solutions were made up as gram equivalent (N) solutions, and with the former solvent they were made up as double normal solutions. Preliminary experiments with each alga used were then made in order to ascertain approximately the strength of the solutions required to give plasmolysis. After these approximations had been obtained, careful dilutions were prepared, each higher concentration differing from the next lower by .01 N. The algae used were carefully examined, and only those which seemed perfectly healthy and normal were employed. In every case the surplus sea water was quickly absorbed by means of filter paper from the bits of algae used, and the algae were then momentarily washed in a solution of the same strength of salt as that used in the particular experiment under way. A portion

* Presented by title to The Academy of Science of St. Louis, November 5, 1906.

† Contributions No. 14 from the Botanical Department of the University of Missouri.

‡ This work was begun while occupying the table of the Smithsonian Institution at the Marine Biological Laboratory, Naples, during March, 1900; and further experiments were made at the Marine Biological Laboratory, Woods Hole, in July, 1901. Final experiments upon which this preliminary report is based, were made at the Zoological Station of the University of Montpellier, at Cette, during a short stay in the winter of 1906. The writer is indebted to many members of the scientific staffs of these institutions and to Prof. Chas. Flahault of the Botanical Institute, University of Montpellier, for the necessary facilities.

of the algal material was then placed on a cavity slide in the solution to be tested and the remainder in some of the same solution in glass cylinders. The slide preparations were observed for several minutes under the microscope; and these observations, as a rule, were sufficient. Nevertheless, the material in the cylinders was mounted and examined after from five minutes to half an hour, in order to determine if plasmolysis might be delayed. The results of these experiments are tabulated below, the concentrations (representing the lowest at which any very evident plasmolysis was observed), are given in decimals of a normal solution, which, in these instances, is the same as a molecular solution.

TABLE I.

Alga	In Sea Water			In Distilled Water		
	Sugar	NaCl	KNO ₃	Sugar	NaCl	KNO ₃
I. <i>Bornetia secundiflora</i>	.37	.26	.28	1.04	.85	1.08
II. <i>Chaetomorpha linum</i>	.46	.32	.38	1.26	.93	1.40
III. <i>Griffithsia Schousheri</i>	.38	.30	.34	1.12	.92	1.20
IV. <i>Pleonosporium coccinium</i>	.58	.40	.42	1.30	1.00	1.44

In analyzing these results it should first be stated that the isotonic value of Naples sea water is calculated to be approximately equivalent to .6 normal KNO₃. Very nearly the same value was also obtained for sea water by the plasmolytic test with a delicate species of *Spirogyra*. It is to be regretted that freezing point determinations were not made.

The above table shows several points of interest. (I). Bearing in mind the isotonic relationship it is seen that the plasmolyzing concentrations for NaCl and KNO₃ are relatively higher, in every case, than those for sugar. This is true whether the calculation of the isotonic values is based on the De Vries coefficients* or adduced from the formulae taking

* De Vries, H.—Eine Methode zur Analyse der Turgorkraft. Jahrb. f. wiss. Bot. 14: 429-601.

into consideration electrolytic dissociation.* † (II). In each case a stronger solution of KNO_3 is required than of NaCl . In strong solutions, such as are here employed, the degree of dissociation might be about six per cent greater in the NaCl than in an equivalent KNO_3 solution in distilled water. On the other hand, in sea water there is already present a considerable amount of NaCl and of other chlorides, all of which would diminish the dissociation of the NaCl added, and consequently tend to balance up the ionic relationship. The conditions, are, however, complex in such mixed solutions, and other factors may be important. (III). If now the isotonic value of sea water, .6 N KNO_3 , as assumed, be added in the columns giving the results of these solutions in sea water, an interesting comparison is found between these computed values and the experimental values in distilled water, as compared below.

TABLE II.

Algae as in Tab. I	NaCl			KNO ₃		
	Computed Value	Expt. Value	Differ- ence	Computed Value	Expt. Value	Differ- ence
I.	.26+.60=.86	.85	-.01	.28+.60=.88	1.08	+.20
II.	.32+.60=.92	.93	+.01	.38+.60=.98	1.40	+.42
III.	.30+.60=.90	.92	+.02	.34+.60=.94	1.20	+.26
IV.	.40+.60=1.00	1.0042+.60=1.02	1.44	+.42

Practically the same osmotic pressures are found for the algal cell whether the determination is made in pure NaCl solution or in NaCl in sea water. When the case is KNO_3 in sea water the point of plasmolysis is determined as beginning at a concentration from 2-6 per cent higher than in the corresponding test with NaCl ; and the point of plasmolysis in pure KNO_3 solution is at a strength from 20-42 per cent above that of KNO_3 in sea water. In the case of sugar, the

* Von Ryssleberghe, Fr.—Réaction osmotique des Cellules Végétales à la concentration du Milieu. Extrait, Mémoires couronnés et autres Mém. publ. par l'Académie royale de Belgique. T. 58. 1899. p. 104.

† Livingstone, B. E.—The Rôle of Diffusion and Osmotic Pressure in Plants. Chicago, 1903.

computation cannot be made so accurately, since the isotonic value of sea water in terms of sugar was not experimentally determined with *Spirogyra*. This value is probably close to 9 N cane sugar, and with this relative value a provisional computation may be readily adduced from the table. Under any circumstances, the results are unique in that the computed strengths of the pure sugar solution required are nearly 25 to 50 per cent too high, that is, the concentrations giving plasmolysis experimentally are low. We have, therefore, for each of the four algae a comparable series of these three solutions, in which the plasmolyzing concentrations differ considerably between sugar, the one extreme, and KNO_3 the other.

Attention should be called to the fact that the figures for KNO_3 given in the above table, are not in close agreement with the results of Janse,* who found that a solution of .14 N potassium nitrate is osmotically equivalent to the cell sap of *Chaetomorpha aerea*. He gives, however, very brief results; and aside from having employed a different species of alga, his methods of treating the algae, as well as an allowance for the personal equation in determining what is the first evidence of plasmolysis, may be sufficient to account for the disagreement.† Some of the marine algae quickly accommodate themselves to plasmolyzing strengths, or readily recover from the plasmolytic effects, doubtless due to the penetration of the solute. This did not, however, enter as a special factor which would account for the difference in the results, as my observations were made from the moment of immersion of the algae, and these furnish the higher values.

There is considerable variation in the turgor between cells in different filaments, even between cells in the same filaments, and such irregularities were also noted by Janse. In

* Janse, J. M. Plasmolytische Versuche an Algen. Bot. Centrbl. **32**: 21-26. 1887.

† In discussing these results with Mr. H. S. Reed, he brought to my attention a considerable series of unpublished osmotic determinations which he made at the Woods Hole Marine Biolog. Lab. in the summer of 1901. He employed six marine algae and a variety of salts, the solutions being made only in distilled water. His results, as shown by the table appended, are interesting, and while showing considerable variation with different algae, the averages are especially instructive. With his consent I give

the case of potassium nitrate in distilled water, however, such these, referring at this time, however, only to the averages obtained with NaCl KNO₃ and Cane Sugar in distilled water, which are .80, 1.10, and .84 N. respectively. There is a relation, but not a close general agreement between these results and those of corresponding solutions referred to in Table I. The peculiar results with the bivalent metals will not be discussed at this time.

Alga	Percentage of Gram (qv. (N) sol. in dist. water causing plasmolysis										
	NaCl	KCl	NH ₄ Cl	C ₃ Cl ₂	N ₂ NO ₃	KNO ₃	Ca(NO ₃) ₂	K ₂ O ₄	MgSO ₄	C ₃ H ₈ O ₃	C ₁₂ H ₂₂ O ₁₁
Cladophora	.7	1.0	.8	.4	.9	.6	.5	No plasmoly- sis at 1.0	1.25	.75	.8
Chaetomorpha	.9	1.0	1.0	.5	1.0	1.25	.6	1.1	.9
Griffithsia	.8	.8	.8	.4	.8	1.0	.6	1.1	.75
Grunnelia	.8	.8	.9	.5	1.0	.75	.69
Polysiphonia	.6	.77	.9	1.07
Porphyra	1.1	1.5	.7	1.6	2.0	1.0
Average	.8	.86	1.0	.5	1.0	1.1	.66	1.99	.98	.84

irregularities are regrettably large, so that it is difficult to compute an average. In fact, from a microscopic study of the effect of such a solution on Pleonosporium, it was found that if the concentration were very gradually increased with this particular alga plasmolysis was a very evanescent phenomenon. It would often happen that on approaching the critical concentration the observation would show only temporary plasmolysis in a few of the many cells under observation. The point of plasmolysis in such cases was soon passed, and death of the cell quickly resulted, as shown by the diffusion of color.

The results obtained by the tests above outlined made it seem desirable that studies should be directed toward a comprehensive knowledge of the possibly toxic action on marine algae of certain of the constituent salts of sea water when added to sea water. (A further study also, of the permeability of the protoplasmic membranes to diverse solutions was evidently important, but the latter has not yet received further consideration.)

A series of experiments was accordingly set up. At that time practically no experiments bearing upon this general matter had been reported, so far as could be ascertained. More recently some data from the plant side as well as the animal side have accumulated. A further study also of the permeability of the protoplasmic membrane to diverse solutions is important.

TOXIC STUDIES.

Materials and Methods. — After considerable experimentation, in order to get desirable forms for the determination of the toxic relations, *Dasya elegans*, *Grinnellia Americana* and *Cladophora gracilis* were employed in the work at Woods Hole. At Cette the season was unfavorable for any great selection and favorable algae which could be secured in best condition were used, these being *Bryopsis plumosa* *Callithamnion roseum*, *Ceramium* sp., and *Nitophyllum punctatum*. Many algae are not suitable for studies of this nature. In

any case, algae selected should be such as would lend themselves to easy observation under the low power of the microscope. Moreover, among red forms it is well to select those which, on being injured or killed, are from their own coloring matter stained diffusely yellowish, pinkish or purplish. The latter phenomenon greatly facilitates observation, although it may lead to error if used as the only indicator where salts of the heavy metals are employed. Algae with long cells are in most cases to be preferred.

In both laboratories the same general method of arranging the experiments was adopted. The solutions employed were placed in glass cylinder bottles each from 25–40cc. capacity; the cylinders were arranged serially in granite iron crates; and the latter were set in a shallow aquarium with running sea water (the water being almost to the level of the liquid in the tubes). By such means a uniform temperature was maintained, which condition is of the first importance. The experiments were all conducted in diffuse light.

The algae used were obtained in the best condition possible — in a few cases collected always from the same locality — and these were kept in the laboratory aquaria twenty-four hours before being used. Numerous control experiments accompanied every series, and in any case where the plants in the control experiments became unhealthy, the entire series was discarded. Owing to the size of the vessels which it seemed desirable to employ, *Grinnellia* and *Nitophyllum*, the two membranaceous algae, were cut into fragments about two sq. c. m. in length; while in the cases of the others only the terminal portions of the thallus branches were employed. Nevertheless, under the best of conditions some injuries will occasionally result to the parts of the plants used, and these injuries may not be detected in time, so that slight discrepancies in the results are not to be wholly obviated.

The concentrations employed for each alga were governed largely by a preliminary test. There were commonly from six to eight dilutions of each salt in the final test. These did not prove sufficient in all cases to include on the one hand a

death concentration, and on the other, one in which the health of the alga remained practically uninfluenced.

The reagents used were the best that could be obtained. Guaranteed reagents could not be had in every instance and "c. p." substances were then employed. The conditions under which the work was conducted rendered it next to impossible to use solutions standardized by titration or by gravimetric methods. The solutions were made therefore by careful weighings of the dried salts or the pure crystals, special precaution being observed with those salts losing water of crystallization upon desiccation. Stock solutions were made up in sea water as .2, .3, or .4 normal (gram equivalent), depending upon the strengths supposedly required, as demonstrated by the preliminary experiments. From the above stock solutions the necessary dilutions were prepared as required. The experiments were arranged in only three extensive series, so that as many experiments as possible would be conducted under practically similar conditions. The limits of the dilutions used with the substances here reported were .4 and .001, gram equivalent. With some salts .2 or .3 N was the highest concentration tested. Numerous control experiments with bits of the algae under precisely similar conditions, with the exception of the chemical substances tested, were constantly run as parallel series.

Experimental Results. In Table III the first considerable series of results obtained, those at Woods Hole, are given. These results are expressed in decimals of a normal solution. The series includes all of the toxic agents used at the time with the exception of a few acids and salts of heavy metals, which have been reserved for a later report. The concentrations given in the table are those which practically represent, under the conditions of the experiment, the mean health concentration of the algae used during (in this case) three days. Tabulations were first made for each of the four algae used, giving the highest concentration at which the alga remained healthy, or, at most, was only slightly injured, and then the averages of these concentrations have been taken for the gen-

eral table given below. In every case the control algae remained healthy.

In Table IV there will be found a tabulation similar to the preceding, for the work done at Cette. In both tables given, the substances are arranged in groups of the metal radical, and it will be seen at a glance that there is more or less irregularity in the toxic strengths indicated, from the

TABLE III.

Substance	% N (permitting health)
NH ₄ Cl.....	.0058
NH ₄ NO ₃0059
(NH ₄) ₂ SO ₄005
CH(NH ₃)O.....	-.01
<hr/>	
KBr.....	.037
KCl.....	.093
KNO ₃073
K ₂ SO ₄08
CHKO ₂	-.017
<hr/>	
NaBr.....	.133
NaCl.....	.13
NaN ₃093
CHNaO ₂047
<hr/>	
CaCl ₂13
Ca(NO ₃) ₂12
<hr/>	
MgBr ₂193
MgCl ₂24
Mg(NO ₃) ₂27
MgS ₄37

TABLE IV.

Substance	% N (permitting health)
NH ₄ Br.....	.001
NH ₄ Cl.....	.0025
NH ₄ NO ₃0025
<hr/>	
KI.....	.02
KBr.....	.056
KCl.....	.081
KNO ₃087
K ₂ SO ₄10(—)
<hr/>	
NaI.....	.03
NaBr.....	.104
NaCl.....	+.275
NaN ₃205
Na ₂ SO ₄2875
<hr/>	
CaI ₂11
CaBr ₂25
CaCl ₂25-.30
Ca(NO ₃) ₂19
<hr/>	
MgI ₂008
MgBr ₂	+.30
MgCl ₂34
Mg(NO ₃) ₂225
MgSO ₄40

iodide or the bromide of the particular metal to the sulphate. Between the different metals there is great diversity of effect, ammonium compounds, for instance, being strongly toxic, whereas the magnesium compounds are almost inert in this regard. When nutrient salts alone are considered, there is, moreover, no great difference between the strengths, as a rule, of compounds of the same metal, yet further results may in-

dicates a series for the acids, some of the factors being more closely related.

While the above arrangement of the results should be presented, it is evident from a glance at the tables that an arrangement whereby the acid portion of the molecules might be more readily comparable would be of greater interest; and this arrangement is shown in Tables V and VI. In these the

TABLE V.

Substances	Algae			
	Dasya	Grinnellia	Cladophora	Ave.
KBr	.06	.01	.04	.037
NaBr	.20	.10	.10	.133
MgBr ₂	.40	.02	.16	.193
NH ₄ Cl	.01	.0025	.005	.0058
KCl	.10	.10	.08	.093
NaCl	.20	.08	.10	.13
CaCl ₂	.20	.12	.06	.13
MgCl ₂	.40	.20	.15	.24
NH ₄ NO ₃	.02	.0025	.001	.0059
KNO ₃	.08	.08	.06	.073
NaNO ₃	.10	.08	.10	.093
Ca(NO ₃) ₂	.20	.08	.08	.12
Mg(NO ₃) ₂	.40	.20	.20	.27
(NH ₄) ₂ SO ₄	— .005	— .005	— .005	— .005
K ₂ SO ₄	.08	.08	.08	.08
MgSO ₄	.50	.40	.20	.37
CHNH ₃ O ₂	.02	— .005	— .005	— .01
CHKO ₂	.04	— .005	— .005	— .017
CHNaO ₂	.10	.02	.02	.047

data are furnished for each alga, and the averages are also given. The results are now strikingly evident. In each case where an ammonium compound of the acid is employed it shows the highest toxic value, and, in general, it is a toxic value which approaches that of acids, or salts of the heavy metals, although this latter point is not demonstrated in the

tables.* Moreover, the metals then arrange themselves in the order of NH₄, K, Na, Ca, Mg. Indeed, when the tables are carefully studied, it will be seen that in the results obtained at Woods Hole, there are no exceptions to this order in the averages, although in the case of the chlorides, K, Na, and Ca are almost equal in toxic value. In the work done at

TABLE VI.

Substance	Algae				
	Calli-thamnion	Bryopsis	Ceramium	Nitophyllum	Ave.
KI	.025	.015	.015	.025	.02
NaI	.03	.05	.01	.03	.03
CaI ₂	.10	.10	.10	.15	.11
MgI ₂	.01	.01	.01	.0025	.008
NH ₄ Br	.001	.001	.001	.001	.001
KBr	.05	.10	.025	.05	.056
NaBr	.015	.15	.15	.10	.104
CaBr ₂	.25	.25	.25	.25	.25
MgBr ₂	+.30	+.30	+.30	+.30	.30
NH ₄ Cl	.0025	.0025	.0025	.0025	.0025
KCl	.05	.10	.10	.075	.081
NaCl	.30	.30	.25	.25	.275
CaCl ₂	.25-.30	.25	.25-.30	.30	.25 to .30
MgCl ₂	.30	.40	.30	.35	.34
NH ₄ NO ₃	.0025	.0025	.0025	.0025	.0025
KNO ₃	.10	.05 to .10	.05 to .10	.10	.0875
NaNO ₃	.20-.25	.20	.20	.20	.205
Ca(NO ₃) ₂	.30	.20	.10	.15	.19
Mg(NO ₃) ₂	.30	.25	.15	.20	.225
K ₂ SO ₄	.05	.05	.20	.10	.10
Na ₂ SO ₄	.30	.25	.30	.30	.2875
MgSO ₄	.40	.40	.40	.40	.40

Cette, Table VI, the only exception is that Na and Ca change places in the case of the nitrates. In this case, however, the difference is not great, and, furthermore, the toxic value of

* No acid reaction was shown after the preparation of the solutions. Acidity tests were not subsequently made.

the calcium compound for the different algae used vary very greatly from .3 to .1 N. In this consideration I have purposely neglected the results obtained with magnesium iodide, which might be omitted from the tables on account of the fact that it was ascertained very soon after the experiments were made that the magnesium iodide was wholly unstable under the conditions, and the formation of hydroiodic acid in the solutions made the results more nearly that for this acid than for the nutrient salt with which the experiment began. In this same table the chlorides of sodium and calcium are not far apart, though there is every probability that the value of the calcium compound was nearer .30 than .25, hence this would be in keeping with the other results.

The very low toxic effect of the neutral magnesium salts upon the marine algae makes it evident that these plants are very notable exceptions to the rule which Loew* † and others ‡ § have found to hold in the nutrient relations of a few fresh water algae and many phanerogams. Loew found the magnesium salts especially injurious to *Spirogyra*, and his general conclusions indicate that he would exclude from plants readily injured by the magnesium salts only certain lower algae and the fungi. The marine algae which have been used in my experiments represent undoubtedly what he would class as higher algae, and their special relation to magnesium salts could only, from his standpoint, perhaps, be explained as a special case, due to the peculiar conditions of their normal environment. It should be borne in mind, however, that it would mean from the standpoint of his theory, an absence of the hypothetical calcium protein compound in

* Loew, O. The Physiological Role of Mineral Nutrients in Plants. Bul. 18. Div. Veg. Plant Physiology and Pathology, U. S. Dept. Agr., Washington. 1899. Bul. 45. Bureau of Plant Industry. 1903.

† Loew, O. and May, D. W. The Relation of Lime and Magnesia to Plant Growth. Bul. No. 1. Bureau of Plant Industry, U. S. Dept. Agr. 1901.

‡ Kearney, T. H., and Cameron, F. K. Some mutual Relations between Alkaline Soils and Vegetation. Rept. No. 71. U. S. Dept. Agr. 1902.

§ Loeb, J. Toxic and Antitoxic Effect of Ions, etc. Chap. 35. Studies in General Physiology. Part II. 1905. Chicago.

these plants. It is not desirable to discuss in detail the matter of the magnesium-calcium relationship at this time, but a brief comparison of the effects of some common salts on phanerogams may be included. The following table from Kearney and Cameron shows the limits of concentration permitting roots of white lupine to retain their vitality for twenty-four hours.

Substances	Parts in 100,000	% of normal solution.
Magnesium sulphate	7	.00125
Magnesium chloride	12	.0025
Sodium carbonate	26	.005
Sodium chloride	53	.0075
Sodium sulphate	116	.02
Sodium bicarbonate	167	.02
Calcium chloride	1377	.25

Of these same substances, however, the concentrations which absolutely prevent growth arrange themselves in a different manner, thus: —

Substances	Parts in 100,000	% of normal solution.
Sodium carbonate	260	.05
Sodium bicarbonate	417	.05
Magnesium chloride	960	.2
Sodium chloride	1160	.2
Sodium sulphate	1410	.2
Calcium chloride	1652	.3
Magnesium sulphate	1680	.3

In my own studies, the arrangement of the salts according to their killing action remains practically the same as that where the line of health is indicated, as is clearly shown in the following table.

This variation in the resistance of marine algae to nutrient salts added to sea water is not proportional to the relative amounts of these salts already present in sea water. This may readily be seen by a glance at the composition of sea water in the vicinity of Naples. An early analysis by Roth*

* Roth, — Chem., Geol. I. p. 524.

was the only one available at either of the points at which the work was done: —

NaCl	3.03%
MgCl ₂	.32 “
MgSO ₄	.26 “
CaSO ₄	.16 “
KCl	.08 “

(Residue — Si, P, CaCO₃, etc.)

From the above table it will be seen that sea water contains

Substances	Algae				
	Callithamion	Bryopsis	Ceramium	Nitophyllum	Ave.
KI	.05	.025	.025	.05	.038
NaI	.15	.15	.05	.10	.113
CaI ₂	.15	.15	.15	.20	.163
NH ₄ Br	.005	.0025	.01	.0025	.005
KBr	.10	.15	.05	.15	.113
NaBr	.25	.20 (ap. px.)	.15	.15	.19
CaBr ₂	.30	.30	.30	.30	.30
MgBr ₂	+.30	+.30	+.30	+.30	+.30
NH ₄ Cl	.005	.005	.005	.005	.005
KCl	.15	.15	.10	.15	.14
NaCl	+.30	+.30	+.30	.30	+.30
CaCl ₂	Not determined	Not determined	Not determined	Not determined	Not determined
MgCl ₂	.40	+.40	+.40	.40	+.40
NH ₄ NO ₃	.005	.005	.005	.005	.005
KNO ₃	.15	.20	.15	.15	.163
NaNO ₃	.25	.25	.25	.25	.25
Ca(NO ₃) ₂	+.30	.25	.25	.25	.263
Mg(NO ₃) ₂	.30	.30	.20	.25	.263
K ₂ SO ₄	.10	.15	.30	+.15	.175
Na ₂ SO ₄	+.30	+.30	+.30	.30	+.30
MgSO ₄	+.40	+.40	+.40	+.40	+.40

about 3.86 per cent of the various salts. Sodium chloride is ten times as abundant as the magnesium chloride, and this in turn four times as abundant as potassium chloride, whereas the toxic value of the latter is considerably higher than either of the former. With the exception of the magnesium sul-

phate, the other substances used are present in such small quantity in sea water that they scarcely need consideration. It is of interest, however, to note that although chlorides are present to such a great extent in normal sea water, the addition of a chloride is, generally speaking, more injurious than the addition of a sulphate; yet the sulphates represent less than one-tenth the concentration of the chlorides in sea water, and nitrates are present only as a trace, yet they are, as a rule, toxic at about the same strengths as the chlorides.

There seems to be no easy explanation of the relative toxic values of NH_4 , K, Na, Ca and Mg, as indicated by the results given. By considering the factor of electrolytic dissociation there seems to be nothing of special interest; for if we take the concentrations at which the ammonium salts are toxic as the points of comparison, we find that the dissociation of practically all the salts used is very nearly the same. At greater concentrations there would be, of course, marked differences in the amount of dissociation in the various salts. However, the fact remains that mere differences in the degree of dissociation may not be invoked to explain these relations. Otherwise magnesium chloride, which is at .0025 N dissociated to an extent practically equal to that of ammonium chloride at the same concentration, should have a health concentration at approximately .0025 rather than at .24 N.

Arber,* in a paper published since the completion of my first series of experiments, reports that solutions of ammonium nitrate equivalent to 1 per cent and 5 per cent potassium nitrate caused the death of *Ulva latissima* in a few days. He also found that the nitrates of potassium, sodium and magnesium are inhibitory to starch formation in the order named. The same author† found in earlier experiments that in the absence of other salts, sodium chloride favored carbon assimilation in this same alga, while the absence of these salts was

* Arber, E. A. N. On the effect of Nitrates on the Carbon Assimilation of Marine Algae. *Ann. Bot.* **15**: 669-681. 1901.

† Arber, E. A. N. On the effect of Salts on the Assimilation of Carbon Dioxide in *Ulva latissima*, L. *Ann. Bot.* **15**: 39-69. 1901.

directly inhibitory to starch formation. Sodium chloride in tap-water, at a concentration of 7.5 per cent was not reported as particularly injurious to this species. Since in all of my experiments, sodium chloride is nearly or quite as toxic as the nitrates, it might be inferred that the threshold of toxic action may not be modified on account of any special stimulating effect which this salt may have upon any particular function, even though this stimulating effect may be manifested at a concentration approaching the lethal dose.

Parallel with my experiments already reported, tests were made in which .35, .30, .25 N, cane sugar, was used in sea water. In such solutions there was no indication of injury throughout the period of the experiments. At a higher temperature there is injury in a few days, doubtless due to bacterial action. At the same time, a concentrated sea water was prepared by evaporation. The strength of this varied from one and one-half to double strength. In such solutions there was no injury, neither throughout the period of the experiments proper, nor for a week or two afterwards. In fact, the algae seemed to be in excellent condition as long as the solutions were kept. A solution stronger than double strength sea water was not employed, unfortunately, although it is quite possible that at a strength greater than this some crystallization would result in the low temperature at which the experiments were conducted. In the double strength sea water it is evident that the concentration of sodium chloride is greater than in the solution which caused injury when sodium chloride alone was added to sea water. This was particularly true with reference to *Grinnellia* and *Ceramium*, for these algae (each in its series) were somewhat more sensitive to sodium chloride than the other species employed. It is therefore probable that the concentration of the other salts in the double strength sea water acted as an antidote (Loew), or antitoxic (Loeb) agent, for the excess of sodium chloride. Such relationships of solutes, or the mollification of toxic action in mixed solutions requires much further study. Special attention seems to have been called to this matter in

the first instance by Loew.* These facts have subsequently been much extended by the work of Loew,† Loeb, Loew and May, Kearney and Cameron, and many others.‡

While the toxic studies afford facts of interest in themselves, they do not throw any great amount of light upon the preliminary osmotic experiments which have been outlined. It is probable that a number of other factors, especially that of penetration of solutes, must be more carefully studied before the divergent osmotic results can be systematically explained. Preliminary experiments indicate that the marine algae are very sensitive to acids and acid salts, but the results thus far obtained in this direction will be reserved for subsequent report.

(Botanical Department, University of Missouri.)

Issued December 21, 1906.

* Loew, O. Ueber die physiologischen Functionen der Calcium und Magnesiumsalze in Pflanzenorganismus. *Flora*. 1892.

† l. c.

‡ There has appeared since the above was written the interesting paper by Osterhout (On the Importance of Physiologically balanced Solutions for Plants. *Bot. Gaz.* 42 : 127-134), which is of special importance in this connection.

PUBLICATIONS.

The following publications of the Academy are offered for sale at the net prices indicated. Applications should be addressed to The Librarian, The Academy of Science of St. Louis, 3817 Olive St., St. Louis, Mo.

TRANSACTIONS (in octavo).

Vol.	Number.	Price per number.	Price per vol.	Price in set.
1	1*	\$7.50 (Nos. 2-4 only.)	\$7.00 (Nos. 2-4 only.)
	2†	\$4.00		
	3, 4	2.00 each.		
2	1 to 3	2.00 each.	5.50	5.00
3	1 to 4	2.00 each.	7.50	7.00
4	1 to 4	2.00 each.	7.50	7.00
5	1-2, 3-4 {	4.00 each. (double numbers)	7.50	7.00
6†	1, 2, 6, 8,	} 25 cts. each. 50 cts. each. 75 cts. each. \$1.00	7.50	7.00
	10, 11, 16, 17			
	4, 5, 7, 13,			
	14, 15, 18			
	3, 9 12			
7†	2, 3, 4, 6, 7, 8,	} 25 cts. each. 50 cts. each. 75 cts. \$1.00	7.50	7.00
	10, 15, 16,			
	18, 19			
	5, 9 to 12,			
	14, 20 17 1			
8†	1, 3 to 6	} 25 cts. each. 50 cts. each.	3.75	3.50
	8, 10, 12			
	2, 7, 9, 11			
9†	1, 3, 4, 7, 9	25 cts. each. 50 cts. each. \$1.25	3.75	3.50
	2, 5, 8			
	6			
10†	9	10 cts. 25 cts. each. 40 cts. 50 cts. each.	3.75	3.50
	2, 4, 5, 10			
	1			
	3, 6, 7, 8, 11			
11†	2, 3	15 cts. each. 25 cts. each. 45 cts. 75 cts. 1.00	3.75	3.50
	5-8, 10, 11			
	1			
	4			
	9			
12†	1, 9, 10	25 cts. each. 35 cts. 45 cts. each. 50 cts. each.	3.75	3.50
	5			
	3, 8			
	2, 4, 6, 7			
13†	2, 3, 5-9	25 cts. each. 75 cts. 1.50	3.75	3.50
	4			
	1			
14†	2, 3, 6, 7	25 cts. each. 50 cts. 75 cts. \$1.00	3.75	3.50
	4, 8			
	5			
	1			
15†	1, 3,	25 cts. each. 50 cts. each. \$1.50	3.50	3.25
	4, 5, 6			
	2			

MEMOIRS (in quarto).

Contributions to the archaeology of Missouri, by the Archaeological Section. Part I. Pottery. 1880. \$2.00.

The total eclipse of the sun, January 1, 1889. A report of the observations made by the Washington University Eclipse Party, at Norman, California. 1891. \$2.00.

* Supply exhausted.
† Can be sold only to purchasers of the entire volume, — so far as this can be supplied.
‡ Each number is a brochure containing one complete paper (or rarely two).

149

Transactions of The Academy of Science of St. Louis.

VOL. XVI. NO. 9.

TITLE-PAGE, PREFATORY MATTER AND INDEX
RECORD FROM JAN. 1 TO DEC. 31, 1906.

Issued February 28, 1907.

PUBLICATIONS.

The following publications of the Academy are offered for sale at the net prices indicated. Applications should be addressed to The Librarian, The Academy of Science of St. Louis, 3817 Olive St., St. Louis, Mo.

TRANSACTIONS (in octavo).

Vol.	Number.	Price per number.	Price per vol.	Price in set.
1	1*	\$7.50 (Nos. 2-4 only.)	\$7.00 (Nos. 2-4 only.)
	2† 3, 4	\$4.00 2.00 each.		
2	1 to 3	2.00 each.	5.50	5.00
3	1 to 4	2.00 each.	7.50	7.00
4	1 to 4	2.00 each.	7.50	7.00
5	1-2, 3-4	4.00 each. (double numbers)	7.50	7.00
6†	1, 2, 3, 8, 10, 11, 13, 17	} 25 cts. each.	7.50	7.00
	4, 5, 7, 13, 14, 15, 18	} 50 cts. each.		
	3, 9	} 75 cts. each.		
	12	} \$1.00		
7†	2, 3, 4, 6, 7, 8, 10, 15, 13, 16, 19	} 25 cts. each.	7.50	7.00
	5, 9 to 12, 14, 20	} 50 cts. each.		
	17	} 75 cts.		
	1	} \$1.00		
8†	1, 3 to 6 8, 10, 12	} 25 cts. each.	3.75	3.50
	2, 7, 9, 11	} 50 cts. each.		
9†	1, 2, 4, 7, 9	25 cts. each.	3.75	3.50
	2, 5, 8 6	50 cts. each. \$1.25		

Continued on page 3 of Cover.

LIST OF AUTHORS.

- Abbott, J. F. cxv
Alt, Adolf xxxix, xlviii
Andrews, Launcelot W. cxxiii
- Bagby, Julian cxviii
Baker, Frank Collins, 1
Birge, E. A. xlviii
Bowie, Edward H. cxxii
Buckley, E. R. lxxvii
- Cammon, E. A. cxxiii
Casey, Thomas L., 125.
Chamberlin, T. C. lvii
Chaplin, W. S. xcii.
Coulter, S. M. xc
- Duggar, B. M. 473
- Evers, Edward cxxi
- Farrington, Oliver C. lxix
- Glatfelter, N. M. cxvi, cxxiii 33.
Goldstein, M. A. cxxiv
Green, John xlv
- Hambach, G. xxxiii, cxvi
Hunicke, H. August xci
Hurter, Julius xc, cxvii, cxx, cxxi
- Layman, W. A. lxxxvi
Life, Andrew C. cxvii
Lochhead, William lxvii
Long, J. H. lxii
- McGee, WJ lxxiv
McMillan, Conway lxxxii
- Nipher, Francis E. 17, xli, xlv, xlviii, lvi, lvii, lxii,
lxvii, lxix. lxxii, lxxiii, lxxvii, lxxviii, lxxix, lxxxI,
lxxxiv, xciii, cxvi, cxxi

Pammel, L. H. lxxii.

Reardon, James A. lxxxvii.

Sampson, F. A. xci.

Sander, Enno. xxx, cxvi

Schrenk, Hermann von lxxviii.

Schwarz, Frank cxvi, cxx

Terry, John H. xei.

Terry, Robert J. cxv 95.

Thompson. C. H. lxxxv.

Trelease, William lxxix, cxx

Weller, Stuart 435.

Whelpley, H. M. xx, lxxxiv, cxv, cxx

Widmann, Otto cxviii

Woodward, C. M. cxvi

GENERAL INDEX

- Active Members** v, ci, cx
Address of President cxxiv
Addresses at Semi-Centennial xv
Alternation of generation cxvii
Amendments cxiii, cix
Amphibia cxvii
Authority cxix

Beetles 125
Birds of Missouri cxviii
Boltzmann, death of Dr Ludwig cxx
Brachipoda cxxiii, 435 [cxx
By-Laws cv

Cave in Crawford county, Mo. cxxi
 Stone county, Mo. cxxi
 Sullivan county, Mo. cxx

Centipedes cxvi
Charter cx
Constitution ci
Corresponding members ci, cx
 secretary cvi
Council cii, cvi
Curators cii
 report of cxxviii
Cyclones cxxii

Dendrites cxx
Donations Library cxxvi
 Museum cxxviii
Dues cviii

Elections cii, cvi, cvii
Exchanges cxlii
Expulsions cviii

Fossils, Brachiopods cxxiii
 Kinderhook 435
Fungi, Mexico cxx
 St. Louis cxxlii, 33

Glen Park Limestone 435
Ground hog cx

History cx
Honorary members v, ci, cviii, cx

Indian clubs cxvii, cxx
Initiation cviii

Japanese language cxv

Kinderhook fauna 435

Librarian cvi
 report of cxxvi
Library cxiii, cxxvi

Management cxii
Marine algae and salt solutions 473
Meetings cxiii, cv, cxlii
Members v, ci, cvii, cviii, cx
Meteorology cxvii
Missouri birds cxviii
 caves cxx, cxxi,
 scorpions cxvi
 tarantulas cxvi
Mollusks from Michigan 1
Museum cxiii, cxxviii
Mushrooms cxvi, cxxiii

Nasal skeleton cxv
Nominating Committee cvi

Officers cii, cvi, cxii
Order of business cv
Oto-Projectoscope cxvii
Ozarks, springs in the cxviii

Patrons v, cii, cviii, cx
Phonetics cxliii
President, address of cxxv
Pressure measurements cxvii
Publications cviii, cxlii

Quorum cv

Real Estate cix
Reports of Curators cxxviii
 Librarian cxxvi
 President cxxv
 Treasurer cxxv
Reptiles cxvii
Resignation cvii

Resolutions on the death of Dr. Ludwig Boltzmann cxx, cxxi	Staphylinidi 125
Salt solutions and marine algae 473	Tarantulas in Missouri cxvi
Scorpions cxvi	Treasurer cvi report cxxv
Secretary cv, cxii	Vacancies cvii
Sections ciii	Wind pressure, measurement of [cxvi]
Semi-Centennial xv	
Spri gs in the Ozarks cxviii	

INDEX TO GENERA.

- Actinocrinus 439, 440, 463
 Actocharis 261
 Actosus 261
 Agaricochara 278-280
 Agaricocrinus 440, 463
 Agaricus 40, 56
 Agrodus 360
 Aidochara n. gen. 128, 145, 149
 Alasmidouta 3
 Aleochara 128, 129, 133, 134, 136,
 144-148, 150, 152, 166, 168, 179,
 192, 235, 286, 318
 Alytes cxvii
 Amanita 34-36
 Amanitopsis 37
 Amanota n. gen. 187-189, 434
 Amblopusa 261, 354
 Amblystoma 95
 Amenusia n. gen. 349
 Amnicola 1, 4
 Amphiuma 117
 Anepsiota 333, 335, 336, 339
 Aneurota 228, 229, 251
 Anodonta 3
 Apalonia n. gen. 323
 Aplexa 5
 Arachnion 88
 Araeocnemis 357, 359, 360, 434
 Arcyria 90
 Arena 261
 Armillaria 41
 Aspis cxviii
 Atheta 332, 333, 342
 Athetota n. gen. 334, 336, 337
 Athyris 437, 438
 Atrypa 443, 463, 464
 Autalia 260

 Bamona 355
 Baptolinus 422-424
 Baryodma 130, 145-147, 149-151,
 165, 179, 180, 319, 320, 434
 Bellerophon 456-458
 Bjerkandera 80
 Bolbitius 33, 51
 Boletinus 72
 Boletus 33, 73-75, 94
 Bolitochara 261-266, 269, 271, 273
 Borboropora 188
 Bornetia 474
 Bos xxxvi, xxxviii
 Bovistella 88
 Brachida 276, 277, 279, 280
 Brachyusa 183
 Bryobiota 261, 354
 Bryopsis 478, 483, 486
 Bryothinusa 261
 Bulgaria 93

 Callicerus 308, 309
 Callithamuion 478, 483, 486
 Calochara n. gen. 129, 149
 Calvatia 87, 88
 Camarophorea 465
 Camarotoechia 442, 465
 Campeloma 4
 Cantharellus 69
 Cardiola 225, 229-231, 252
 Centronella 465
 Ceramium 478, 483, 486
 Ceranota 131, 134, 135
 Chaetomorpha 474, 476, 477
 Chelone cxvii
 Chilopora 306, 308
 Chitalia 225, 227, 229, 230, 232, 233,
 237-239, 245, 250
 Chlorotusa n. gen. 324
 Chonetes 441, 463, 465
 Chonopectus 467, 469
 Cladophora 477, 478, 482
 Claudopus 51
 Clavaria 84, 85
 Clitopilus 33, 50, 51
 Clytocybe 42-44, 56

- Collybia 34, 45, 46
 Comatricha 91
 Conularia cxvi
 Coprinus 62, 63
 Cortinarius 34, 63, 64
 Craterellus 83
 Crepidotus 56
 Crucibulum 89
 Cryptonella 443, 465
 Ctenochara n. gen. 128, 134, 433
 Cyathaxonia 438
 Cyathus 89
 Cyphea 280
 Cypricardinia 454, 455, 463
 Cytherodon 452

 Daedalea 81
 Daldinia 94
 Da-ya 478, 482
 Dasyglossa 318, 319
 Deconica 61
 Delthyris 445-447, 463, 465
 Dianusa n. gen. 346
 Diatrybe 94
 Dialota 261
 Dictyophora 85
 Dielasma 443
 Diestota 276, 277, 279
 Dinolinus n. gen. 366, 372, 373, 434
 Diochus 357-359, 429, 430, 434
 Ditropalia n. gen. 262-264, 434
 Draco cxvii
 Drusilla 321, 322
 Drusillota n. gen. 321, 434

 Ecclia 52
 Echidnoglossa 183
 Echochara n. gen. 132, 176
 Elfvingia 80
 Elymella 451
 Elytrusa n. gen. 334, 336
 Emplenota 131, 132, 134, 136, 172,
 173, 176, 177
 Encephalus 276, 277, 279, 280
 Entoloma 33, 50
 Epipeda 260
 Eucharina n. gen. 130, 149, 165,
 173
 Euconulus 14
 Eucryptusa n. gen. 345

 Eullissus 231, 357, 365, 366, 373,
 379, 380, 397, 398
 Euliusa n. gen. 187, 188, 192, 213,
 215, 221, 223
 Eumicrota n. gen. 278-280, 285, 434
 Eunella 442, 443, 463, 465
 Euromota n. gen. 334, 338
 Eurynotida n. gen. 343
 Eurystomus cxxi
 Euryusa 261, 348
 Evactinopora 438
 Exidia 85

 Falagon a 321
 Falagria 125, 133, 190, 219, 222,
 227, 229-232, 234-237, 243, 245,
 246, 249, 253, 256, 259
 Falagrioma n. gen. 226, 230, 239,
 434
 Falagriota n. gen. 229, 255
 Favolus 81
 Flammula 33, 53, 54, 56
 Fomes 78-80
 Fuligo 90

 Galera 57
 Ganoderma 79
 Geaster 86
 Gennadota n. gen. 308, 309
 Geopyxis 93
 Gloeoporus 80
 Gnypeta 183-186, 188, 189, 192,
 203-205, 214-216, 218, 221, 338
 Gnypetella n. gen. 186, 188, 214, 221
 Gnypetoma 196, 202, 221
 Gomphidius 56
 Goniobasis 1, 4
 Goniusa n. gen. 348
 Griffithsia 474, 477
 Grinnellia 477, 478, 482
 Guelpinia 85
 Gyrohypnus 360, 361, 367, 368, 375,
 384, 386, 396 399, 409, 412
 Gyromitra 91
 Gyronycha 355
 Gyrophaena 276-282, 285, 286, 288,
 289, 305

 Habrolinus n. gen. 369, 370, 406-
 408
 Hebeloma 54

- Helvella* 91, 92
Hemiarcyria 90
Hemitrichia 90, 91
Hesperolinus n. gen. 358, 370, 371, 404, 406, 411, 412, 416
Hirn-ola 85
Homalolinus 366, 374, 434
Homalota 260, 275, 332, 336, 340
Homalotusa n. gen. 335, 340
Hoplandria 343
Hydnei 82
Hygrophorus 64
Hylota n. gen. 318
Hymenochaete 84
Hypholoma 59, 60
Hypnogra n. gen. 394
Hypomyces 35, 94
Hypoxylon 94
Hyptoma n. gen. 358, 362, 434

Idiolinus n. gen. 364, 368, 375, 434
Ilyobates 307, 309
Ilyusa 189
Inocybe 33, 54-56
Inonotus 79
Ips 420
Irpex 82, 83
Isaria 94
Ischnopoda 183, 185, 188, 189

Lachnea 93
Lactarius 33, 64-66, 94
Lampsilis 3
Lelolinus n. gen. 371, 416, 418
Lentinus 33, 71, 72
Lenzites 72, 81
Lepiota cxx 33, 34, 36-40
Leptacinodes n. gen. 369, 372, 401, 404, 405, 434
Leptacinus 358, 361, 368, 369, 399, 401, 404, 405, 420
Leptaena 438
Leptagria n. gen. 227, 249, 250
Leptolinus 358, 364, 372, 409, 418, 419
Leptusa 261, 263, 344, 350
Llogluta 332-335
Liparocephalus 261
Lisagria n. gen. 228, 229, 239, 252, 253, 255, 260.
Lissohypnus n. gen. 368, 398

Lithocharodes 370, 406, 408-410, 418
Lithophaga 465
Lophagria n. gen. 225, 229-231, 434
Lorinota, n. gen. 226, 233, 238, 239
Lycogola 90
Lycoperdon 86, 87
Lymnaea 1, 5, 10-13

Macrodon, 450-452, 463, 465
Macroterma n. gen. 334, 335, 337
Marasmius 34, 69-71
Mazeochara 130-132, 134, 137, 144, 168, 172, 173, 176, 177
Mastodon xxiv, xxxiv
Mataris 188
Megalobatrachus cxvii
Melagria n. gen. 227, 230, 250, 251, 434
Menobranchnus 117
Menopoma 117
Meroa 187
Meropera 184, 187-189, 220, 223
Merulius 81
Metoponcus 357, 360, 361, 364, 372, 420
Microlinus n. gen. 372, 419, 420
Modiola 453, 454, 463
Modiomorpha 452-454, 463
Moloch cxviii
Morchella 91
Mutinus 85
Mycena 33, 46, 47
Myrmecopora 189, 260
Myrmedonia 322-324
Myrmoecia 322, 323

Naja cxviii
Nasirema 311
Naticopsis 458
Naucoria 56
Necturus 115, 116, 119
Nematolinus n. gen. 358, 370, 406-409, 412
Neolara 184, 187, 188, 221, 434
Nitophyllum 478, 483, 486
Nolanea 51
Notiochara n. gen. 129, 134, 433
Notolinopsis n. gen. 371, 372, 377, 378, 434

- Notolinus n. gen. 358, 371, 372, 375,
 377, 434
 Nototaphra 322, 323
 Nucleospira 447, 463
 Nucula 448, 463, 465
 Nukulana 448, 449, 463, 465
 Nuculites 452
 Nudobius 358, 367, 372, 380, 381,
 384, 385, 424

 Ocalea 305, 308
 Oligolinus n. gen. 361, 372, 420
 Omphalia 33, 48
 Oreochara n. gen. 129, 148
 Orthagria n. gen. 260
 Orthonychia 461
 Orthothetes 440, 463, 465
 Othiellus n. gen. 421-423, 434
 Othius 421-424
 Oxy-poda 311, 318, 319, 334, 336,
 350
 Ozonium 94

 Pachycerota n. gen. 307
 Panaeolus 61, 62
 Pancota n. gen. 345
 Panus 33, 71, 72
 Paraphorhynchus 469
 Parothius n. gen. 421-423, 425
 Paxillus 56
 Peziza 35, 92
 Phaenogyra 277-280, 352
 Phallogaster 89
 Phanerota n. gen. 276, 278, 285,
 286, 289, 324, 434
 Phloeopora 309-311
 Pholiota 52, 53
 Phylloporus 56
 Phymatura 262, 264
 Physa 1, 5-8
 Physarum 90
 Phytosus 261
 Pilosace 58
 Pinalochara n. gen. 131, 132, 173,
 177
 Pinophilus 358, 364
 Pipa cxvii
 Placusa 260, 349
 Planorbis 9, 10
 Platyceras 437, 459, 460, 463

 Platyprosopus 357, 358, 363, 364
 Pleonosporium 474
 Pleurotobia n. gen. 263, 272, 273,
 275
 Pleurotus 44, 45, 51
 Plochionocerus 360
 Pluteolus 57
 Pluteus 49, 50
 Polygyra 14
 Polyporus 76-79
 Polysaccum 89
 Polysiphonia 477
 Polystictus 76
 Polystoma 131, 134, 136, 172, 176
 Polystomota n. gen. 132, 136, 3
 Porphyra 477
 Productus 437, 438, 463
 Proteus 115, 117, 119
 Psalliota 58
 Psathyra 33
 Psathyrella 63
 Psilocybe 61
 Ptilium 281
 Ptychomphalus 455, 465
 Ptyctodus 462-464, 469
 Pyramidula 15
 Pyropolyporus 79

 Quereus 79

 Rana 112, 114-118, 120
 Rechota 188
 Reichenbachia 359
 Rheobioma n. gen. 133, 176, 180,
 181
 Rheochara 133-136, 173, 176-182
 Rheocharella n. gen. 133, 176, 181
 Rhizomorpha 94
 Rhynchonella 469
 Rhynchotrema 436
 Robinia 79
 Russula 33, 34, 66-69

 Sarcoscypha 92
 Saurohypnus 366, 373, 379, 434
 Schizodus 462, 463, 465
 Schizophyllum 72
 Scleroderma 88
 Secotium 88
 Segmentina 9

- Seminula 447
 Semivelutina 172
 Sepidonium 94
 Sericoderus 273
 Sibiotia n. gen. 350
 Sillusa 263, 344-347
 Silusida n. gen. 262, 264, 270, 272
 Sipalia 261, 263, 350
 Somoleptus 408
 Sphaerium 3, 4
 Sphenophorus 151
 Spirifer 437-439, 444
 Spiriferina 446
 Staphylinus 144
 Stemonitis 90
 Stenagria 239
 Stenus 285
 Sterculia 359, 360
 Stereum 84
 Stictalia n. gen. 261, 262, 264, 272
 Stictolinus n. gen. 369, 372, 404, 410
 Stillcus 357
 Strobilomyces 76
 Stropharia 58, 59
 Strophitus 3
 Strophostylus 460, 461
 Succinea 14
 Syringothyris 444
- Tachyusa 183, 185-190, 192, 194,
 196-198, 200, 202-205, 212-216,
 221, 224, 260
 Tachyusilla n. gen. 213, 434
 Tachyusota n. gen. 213, 434
 Taphrodota n. gen. 334, 338
 Teliusa n. gen. 185, 188, 203
 Terasota n. gen. 334, 337
 Thelephora 83
 Thinonoma 183
 Thinusa 261, 353
 Tilmadoche 89, 90
 Tinotus 320
- Tithanis 130, 172
 Titanotherium xxxvi, xxxviii
 Tomicus 420
 Trachyota n. gen. 184, 185, 188,
 190, 191
 Trametes 80, 81
 Tremelodon 82
 Trichia 91
 Trichiusa 325, 326, 332
 Tricholoma 33, 41, 42
 Triton 113, 120
 Tropicodiscus 453, 463
 Tubaria 57
 Typhlomolge cxvii
 Typhlusida n. gen. 263, 350, 434
- Ullitusa n. gen. 347
 Ulva 487
 Urnula 93
 Ustulina 94
- Valenusa n. gen. 342
 Valvata 4
 Venusa n. gen. 263, 264, 270, 272,
 274
 Volvaria 48, 49
- Xanthohypnus n. gen. 367, 372, 374,
 434
 Xantholinus 358, 367-369, 373-375,
 377, 380, 381, 384, 386-388, 395,
 397, 398, 412, 420
 Xenochara 128, 129, 134, 146, 147,
 182
 Xenusa 183, 186, 188, 189
 Xestolinus n. gen. 363, 397
 Xesturida n. gen. 325
 Xylariia 93, 94
- Zaphrentis 439
 Zeuglodon xxiv, xxxiv
 Zonitoides 15

PUBLICATIONS—Continued.

Vol.	Number.	Price per number.	Price per vol.	Price in set.
10†	9	10 cts.	3.75	3.50
	2, 4, 5, 10	25 cts. each.		
	1	40 cts.		
	3, 6, 7, 8, 11	50 cts. each.		
11†	2, 3	15 cts. each.	3.75	3.50
	5-8, 10, 11	25 cts. each.		
	1	45 cts.		
	4	75 cts.		
	9	\$1.20		
12†	1, 9, 10	25 cts. each.	3.75	3.50
	5	35 cts.		
	3, 8	45 cts. each.		
	2, 4, 6, 7	50 cts. each.		
13†	2, 3, 5-9	25 cts. each.	3.75	3.50
	4	75 cts.		
	1	\$1.50		
14†	2, 3, 6, 7	25 cts. each.	3.75	3.50
	4, 8	50 cts.		
	5	75 cts.		
	1	\$1.00		
15†	1, 3,	25 cts. each.	3.50	3.25
	4, 5, 6	50 cts. each.		
	2	\$1.50		
16†	2, 3, 5, 7-9	25 cts. each.	3.75	3.50
	1, 4	50 cts. each.		
	6	\$1.50		

MEMOIRS (in quarto).

Contributions to the archaeology of Missouri, by the Archaeological Section. Part I. Pottery. 1880. \$2.00.

The total eclipse of the sun, January 1, 1899. A report of the observations made by the Washington University Eclipse Party, at Norman, California. 1891. \$2.00.

* Supply exhausted.

† Can be sold only to purchasers of the entire volume,—so far as this can be supplied.

‡ Each number is a Brochure containing one complete paper (or rarely two).



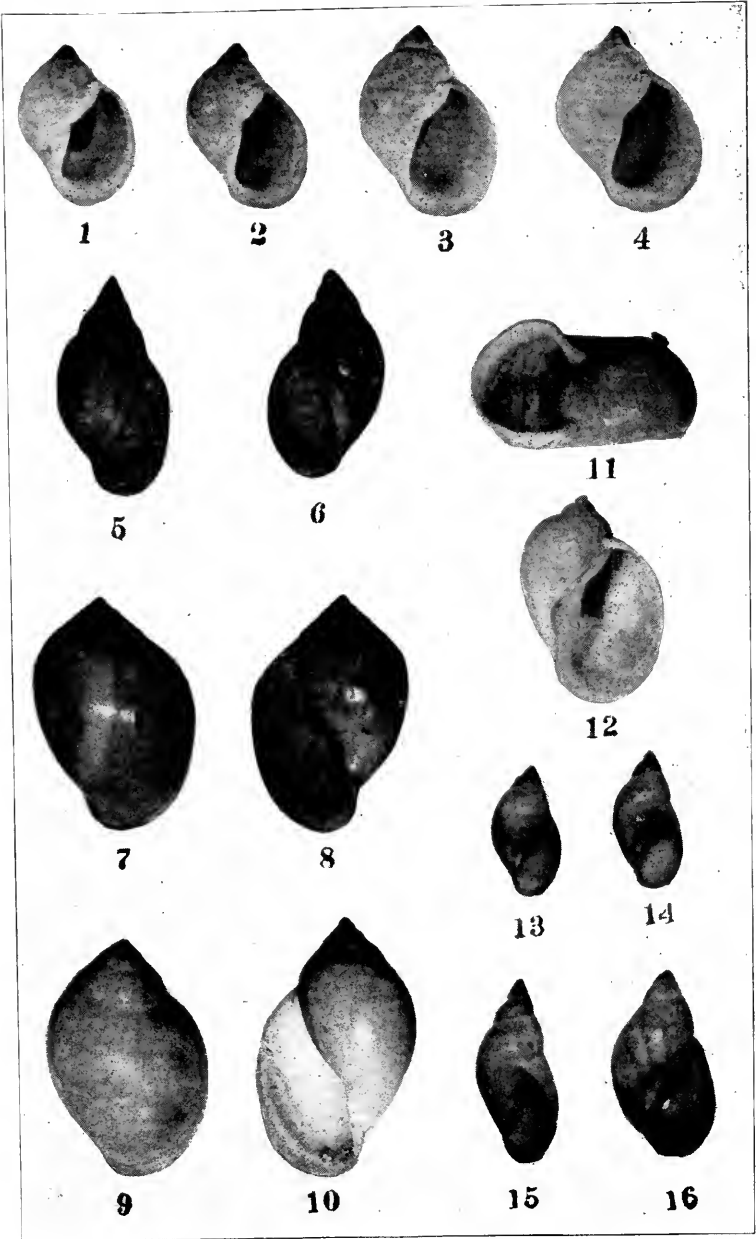

MOLLUSKS FROM THE VICINITY OF ALPENA, MICHIGAN.

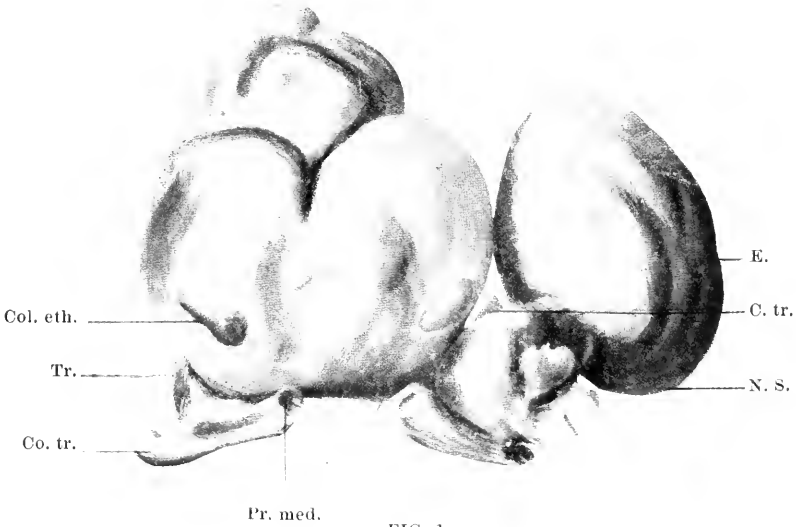

FIG. 1.

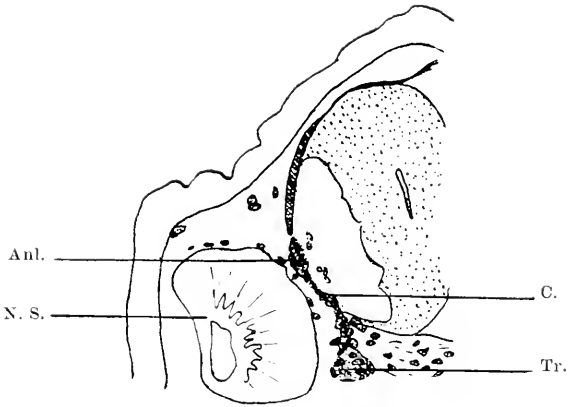

FIG. 5.

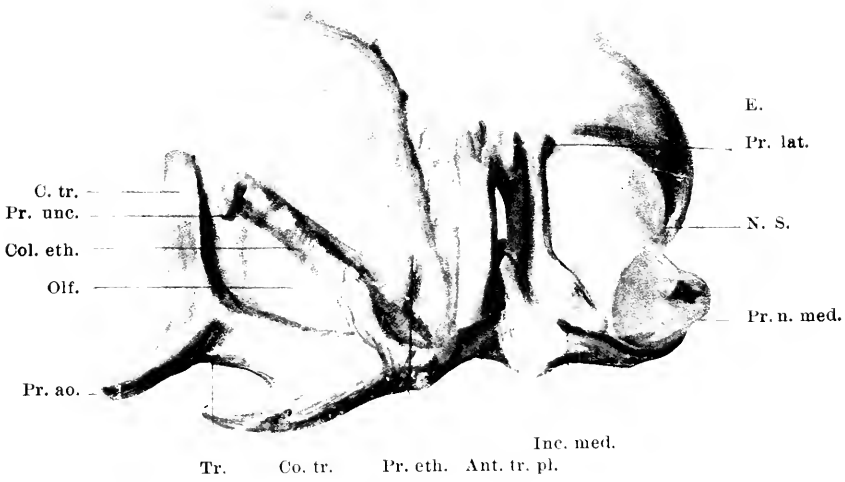

FIG. 2.

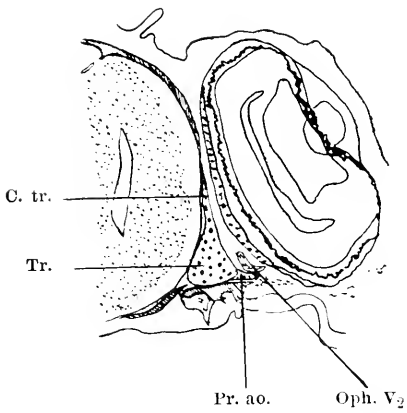

FIG. 6.

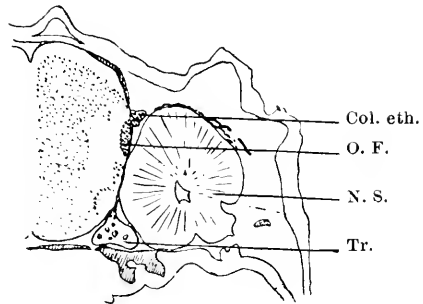

FIG. 7.



FIG. 3.

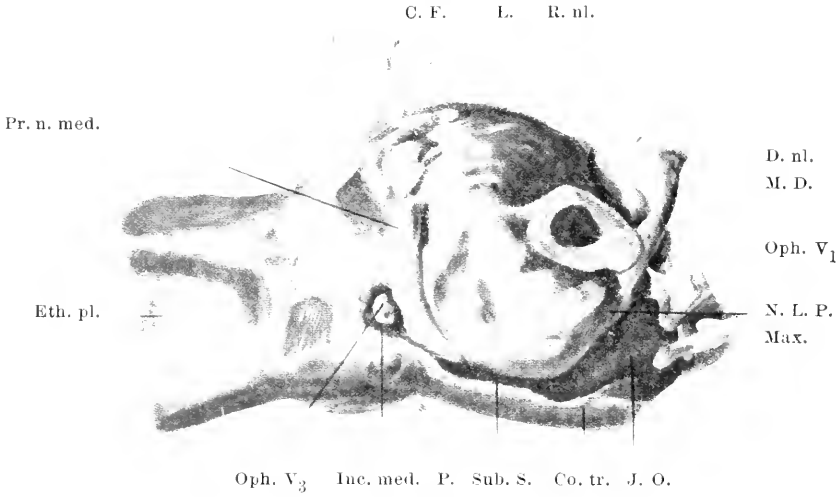

FIG. 4.

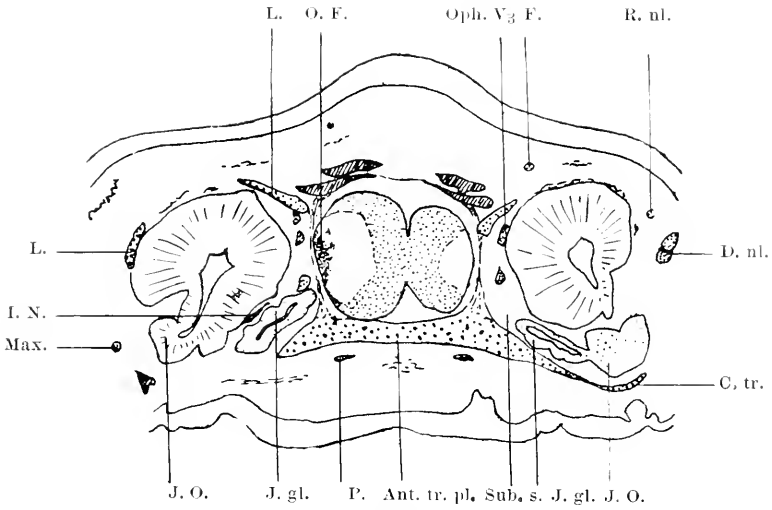
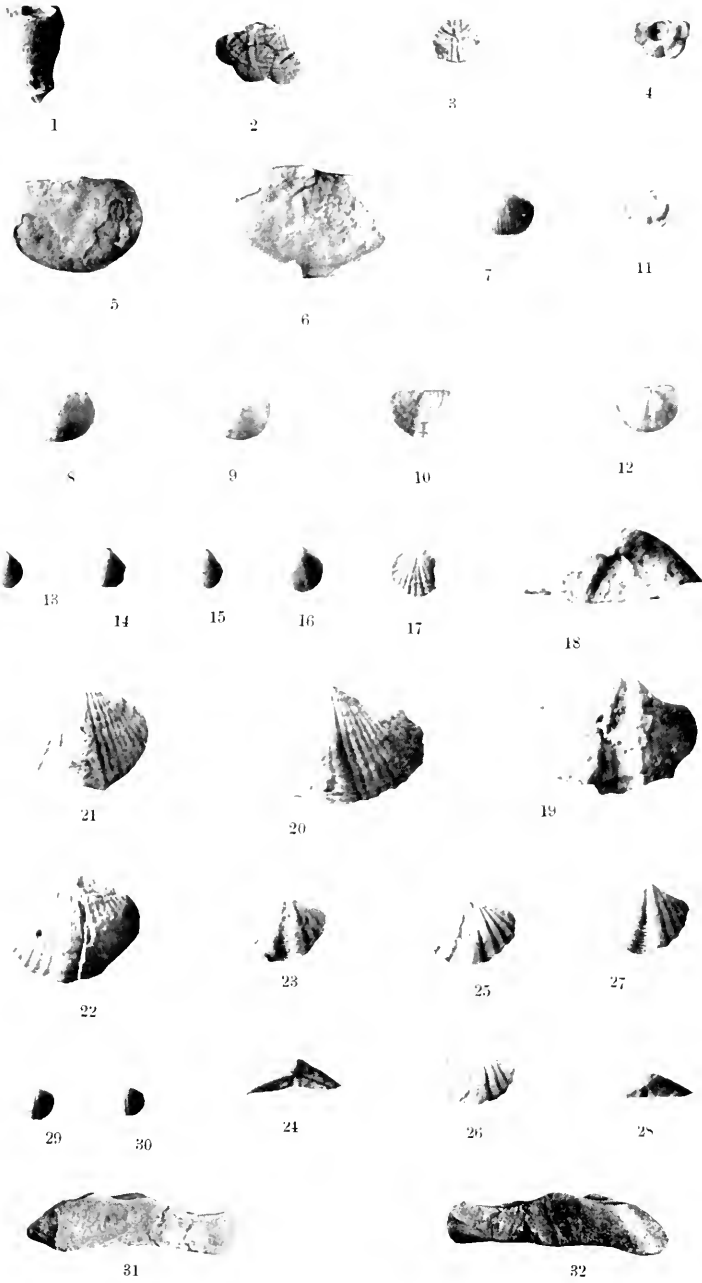
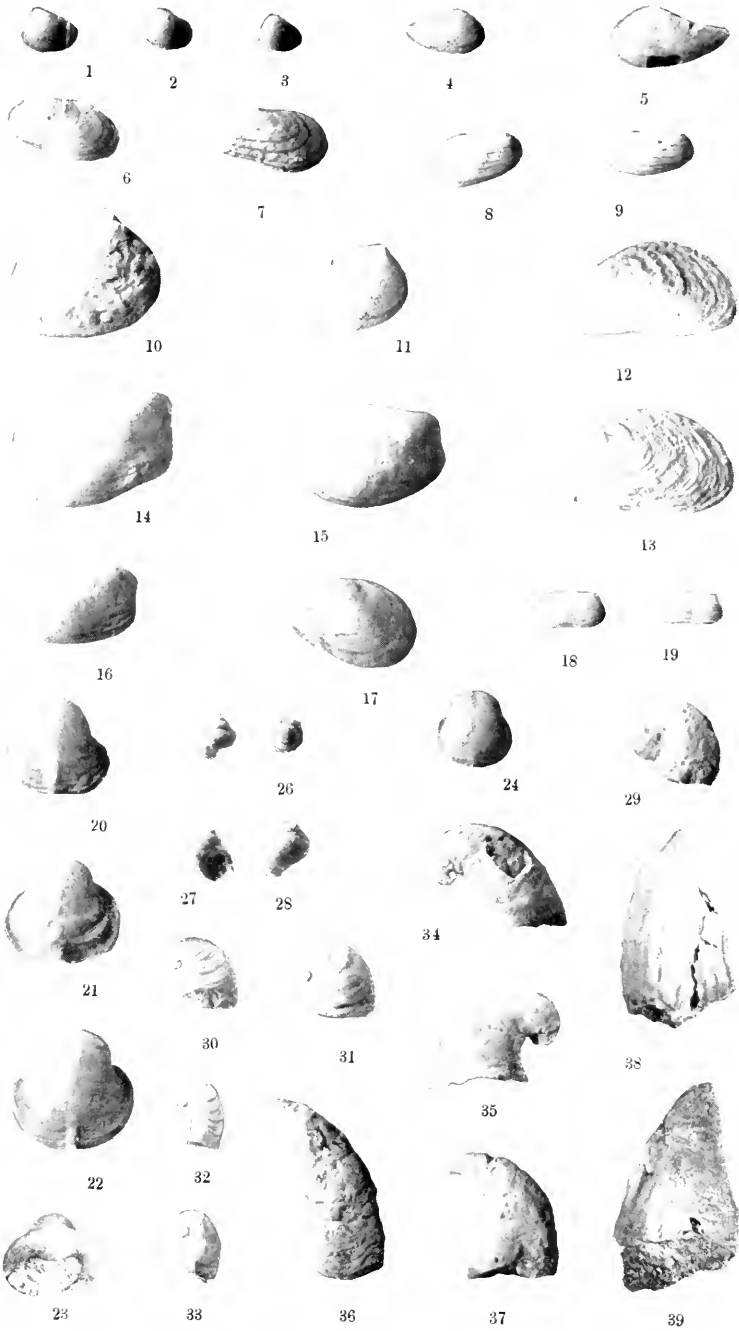

FIG. 5.







3 2044 093 291 300

