

54

C 11

TRANSACTIONS
OF THE
ROYAL SOCIETY
OF
EDINBURGH.

VOL. XI.

EDINBURGH,
PUBLISHED BY CHARLES TAIT, AND BELL & BRADFUTE;
AND T. CADELL, LONDON.

MDCCCXXXI.



PRINTED BY NEILL & CO.
Old Fishmarket, Edinburgh.

CONTENTS

OF

VOLUME ELEVENTH.

PART FIRST.

	Page
I. <i>Description of STERNBERGITE, a New Mineral Species.</i> By W. HAIDINGER, Esq. F. R. S. Ed. - - -	1
II. <i>A Description of some Remarkable Effects of UNEQUAL REFRACTION, observed at Bridlington Quay in the summer of 1826.</i> By the Reverend WILLIAM SCORESBY, F. R. SS. Lond. & Edin., M. W. S., and Corresponding Member of the Institute of France, - - -	8
III. <i>On a New Combustible Gas.</i> By THOMAS THOMSON, M. D., F. R. SS. Lond. & Edin., Professor of Chemistry in the University of Glasgow, - - -	15
IV. <i>Some Experiments on Gold.</i> By THOMAS THOMSON, M. D., F. R. SS. Lond. & Edin., Professor of Chemistry in the University of Glasgow, - - -	23
V. <i>On the Construction of Polyxonal Lenses, and their Combination with Plain Mirrors, for the purposes of Illumination in Lighthouses.</i> By DAVID BREWSTER, LL.D. F. R. SS. Lond. & Edin. - - -	33

c. Dec. 1828
recd by Soc. Lond.
Jan. 28. 18

	Page
VI. <i>On the Parasitic Formation of Mineral Species, depending upon Gradual Changes which take place in the Interior of Minerals, while their External Form remains the same.</i> By WILLIAM HAIDINGER, Esq. F. R. S. Ed.	73
VII. <i>On the Influence of the Air in determining the Crystallization of Saline Solutions.</i> By THOMAS GRAHAM, Esq. A. M.	114
VIII. <i>Mineralogical Account of the Ores of Manganese.</i> By WILLIAM HAIDINGER, Esq. F. R. S. Ed.	119
IX. <i>Chemical Examination of the Oxides of Manganese.</i> By EDWARD TURNER, M. D., F. R. S. Ed., Professor of Chemistry in the University of London, Fellow of the Royal College of Physicians of Edinburgh,	143
X. <i>An Account of the Formation of ALCOATES, Definite Compounds of Salts and Alcohol, analogous to the Hydrates.</i> By THOMAS GRAHAM, Esq. A. M.	175
XI. <i>An Account of the Tracks and Footmarks of Animals found impressed on Sandstone in the Quarry of Corncockle Muir in Dumfriesshire.</i> By the Rev. HENRY DUNCAN, D. D. Minister of Ruthwell,	194
XII. <i>On the Combination of Chlorine with the Prussiate of Potash, and the presence of such a compound as an impurity in Prussian Blue.</i> By JAMES F. W. JOHNSTON, A. M.	210
XIII. <i>On a Mass of Native Iron from the Desert of Atacama in Peru.</i> By THOMAS ALLAN, Esq. F. R. S. Ed.	223
XIV. <i>Observations on the Structure of the Fruit in the Order of Cucurbitaceæ.</i> By FRANCIS HAMILTON, M. D., F. R. S. & F. A. S. Lond. & Ed.	229

PART SECOND.

c. Aug. 1831

	Page
XV. <i>Some Experiments on the Milk of the Cow-Tree.</i> By THOMAS THOMSON, M. D., F. R. SS. Lond. & Edin., Professor of Chemistry in the University of Glasgow, -	235
XVI. <i>Account of the Constituents of various Minerals.</i> By THOMAS THOMSON, M. D., F. R. SS. Lond. & Edin., Professor of Chemistry in the University of Glasgow, -	244
XVII. <i>Account of a remarkable peculiarity in the Structure of Glauberite, which has one Axis of Double Refraction for Violet, and two Axes for Red Light.</i> By DAVID BREWSTER, LL.D., F. R. SS. Lond. & Edin. - -	273
XVIII. <i>Experimental Inquiries concerning the Laws of Magnetic Forces.</i> By WILLIAM SNOW HARRIS, Esq. -	277
XIX. <i>On certain new Phenomena of Colour in Labrador Felspar, with Observations on the nature and cause of its Changeable Tints.</i> By DAVID BREWSTER, LL. D., F. R. SS. Lond. & Edin. - - - - -	322
XX. <i>On the Composition of Blende.</i> By THOMAS THOMSON, M. D., F. R. SS. Lond. & Edin., Professor of Chemistry, Glasgow, - - - - -	332
XXI. <i>Notice regarding a Time-Keeper in the Hall of the Royal Society of Edinburgh.</i> By JOHN ROBISON, Esq. Sec. R. S. Ed. - - - - -	345
XXII. <i>On Asbestos, Chlorite, and Talc.</i> By THOMAS THOMSON, M. D., F. R. SS. Lond. & Edin. &c., Regius Professor of Chemistry in the University of Glasgow, - -	352
XXIII. <i>Observations to determine the Dentition of the Dugong; to which are added Observations illustrating the Anatomical Structure and Natural History of certain of</i>	

	Page
<i>the Cetacea.</i> By ROBERT KNOX, M. D., F. R. S. Ed., and Lecturer on Anatomy, - - - - -	389
XXIV. <i>Remarks explanatory, and Tabular Results of a Meteorological Journal kept at Carlisle by the late Mr WILLIAM PITT during twenty-four years.</i> By THOMAS BARNES, M. D., Physician to the Fever Hospital and Public Dispensary at Carlisle, &c. - - - - -	418
XXV. <i>On Mudarine, the Active Principle of the Bark of the Root of the Calotropis Mudarii, Buch.; and the singular influence of Temperature upon its solubility in Water.</i> By ANDREW DUNCAN, M. D., F. R. S. Ed., Professor of Materia Medica in the University of Edinburgh, - - - - -	433
XXVI. <i>Description and Analysis of some Minerals.</i> By THOMAS THOMSON, M. D., F. R. SS. Lond. & Edin., Professor of Chemistry in the University of Glasgow, - - - - -	441
XXVII. <i>Observations on the Structure of the Stomach of the Peruvian Lama; to which are prefixed Remarks on the Analogical Reasoning of Anatomists, in the Determination à priori of Unknown Species and Unknown Structures.</i> By ROBERT KNOX, M. D., F. R. S. Ed., and Lecturer on Anatomy, - - - - -	479
 <i>Proceedings of the Extraordinary General Meetings, and List of Members elected at Ordinary Meetings, since May 1. 1826,</i> - - - - -	 499
<i>List of the present Ordinary Members in the order of their election,</i> - - - - -	521
<i>List of Deceased Members, and of Members Resigned, from 1826 to 1830,</i> - - - - -	533
<i>List of Presents, continued from Vol. X. p. 483.</i> - - - - -	535

I. *Description of STERNBERGITE, a New Mineral Species.* By
W. HAIDINGER, Esq. F. R. S. E.

(Read December 4. 1826.)

THE mines of Joachimsthal in Bohemia, have long been celebrated for their riches. They were successfully worked at an early period, and though their produce has been exceedingly fluctuating, yet the mining district, in which they occur, continues one of the most important of that country. They seem to have been particularly lucrative and important while they belonged to the house of the Counts SCHLICK, and when, in the beginning of the sixteenth century, a larger kind of silver coin was introduced into Germany, it took the name of *Joachimsthaler*, from the place of its coinage, a name which was afterwards changed into *thaler*, *talaro*, and *dollar* *.

These mines are not less remarkable for the variety of the species, and for the beauty of the specimens which they have produced. The ancient collections of minerals at Vienna, the Imperial cabinet, that of VON DER NÜLL, that of VON MORGENBESSER, and others, contain magnificent suites of sulphuret of silver, of red silver, &c. chiefly crystallised. The finest specimens, however, of the red silver, and perhaps the finest that ever were

* These Thalers bear the head and the name of the then reigning Count SCHLICK, and the earliest of them the date of 1517. There are some coins, however, of the same value, with the head of the Emperor MAXIMILIAN I., as far back as 1493. They used to be called *Klupplinge*, an antiquated German word, which means something ponderous, giving a sound when struck against a hard body.

known in the species, were dug up so late as 1817 and 1822. The National Museum at Prague possesses one of them, consisting of a group of crystals several inches long, without having any rock attached to it, and weighing about twelve marks, or upwards of six pounds Avoirdupois, the value of the silver of which is more than L. 16 Sterling.

It was in the same collection that I first observed a variety of the species of Sternbergite, which it is the object of the present paper to describe. Professor ZIPPE, the keeper of the museum of natural history, directed my attention towards it, as being something he could not bring under any of the species already known; and as it appeared an interesting mineral, I requested his permission to take it with me to Edinburgh, in order to examine its forms, and other properties, a request which was readily granted. Gubernialrath NEUMANN of Prague, late Professor of Chemistry there, was not less liberal in allowing me to take with me the only specimen of it contained in his collection, where it had been designated by Mr ZIPPE as a *pinchbeck-brown problematical fossil, crystallised in six-sided tables*. The crystals in this specimen are very distinct; they are aggregated along with crystals of red silver in drusy cavities in quartz, which protected their edges from being rounded off by rubbing, like the specimen from the collection of the National Museum. Here, too, the Sternbergite is associated with red silver, and with brittle silver, making the whole highly valuable as an ore of silver. It is likely that most of the specimens have long ago been melted down; perhaps some of them may yet be discovered in the Imperial cabinet in Vienna, which contains a great number of specimens from Joachimsthal. Professor ZIPPE informs me, that he has found another specimen of the substance in the Museum at Prague, since I had the pleasure of inspecting it in his company.



STERNBERGITE

Fig. 1.

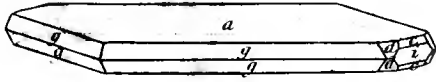

Fig. 2.

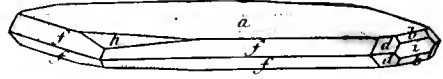

Fig. 3.

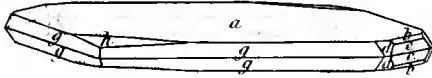

Fig. 4.

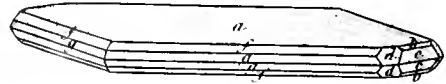

Fig. 5.

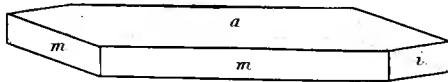

Fig. 6.

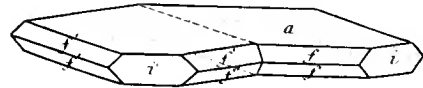

Fig. 7.

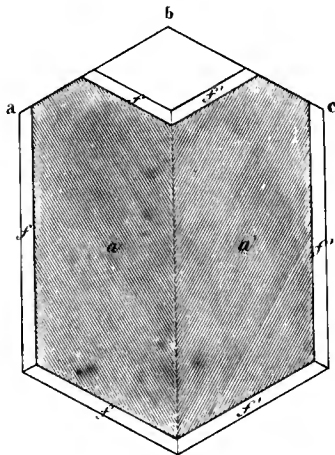
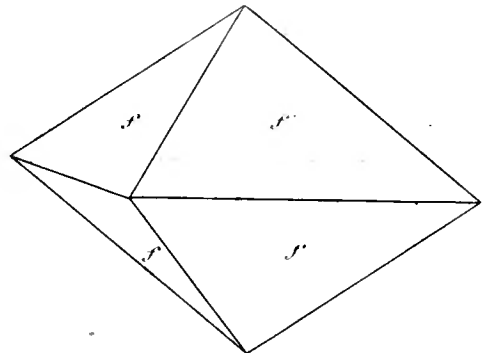

Fig. 8.



The following account contains the characters ascertained in the two specimens.

The forms of Sternbergite belong to the prismatic system. Its fundamental form (Plate I. Fig 8.) is a scalene four-sided pyramid, having edges of $128^{\circ} 49'$, $84^{\circ} 28'$, and $118^{\circ} 0'$. The ratio of its axis and diagonals $a : b : c$, is $= 1 : \sqrt{1.422} : \sqrt{0.484}$.

The specimens contained the following secondary forms, $P - \infty (a)$; $P (f)$; $P + 1 (g) = 122^{\circ} 17'$, $68^{\circ} 22'$, $146^{\circ} 34'$; $(P_r^{\circ})^3 (d) = 92^{\circ} 28'$, $107^{\circ} 17'$, $131^{\circ} 17'$; $P_r^{\circ} + 1 (b) = 61^{\circ} 35'$; $\frac{5}{4} P_r^{\circ} + 3 (c) = 13^{\circ} 36'$; $P_r^{\circ} + \infty (i)$; $\frac{4}{3} P_r^{-} - 3 (h) = 153^{\circ} 2'$.

The combinations observed are,

1. $P - \infty . (P_r^{\circ})^3 . P + 1 . \frac{5}{4} P_r^{\circ} + 3 . P_r^{\circ} + \infty .$ Fig. 1.
2. $P - \infty . \frac{4}{3} P_r^{-} - 3 . P . (P_r^{\circ})^3 . P_r^{\circ} + 1 . P_r^{\circ} + \infty .$ Fig. 2.

There were traces of planes taking off the edges between d and d' , which I could measure. The measurement gave for the base of the pyramid d , by approximation $81^{\circ} 12'$.

3. $P - \infty . \frac{4}{3} P_r^{-} - 3 . P_r^{\circ} + 1 . (P_r^{\circ})^3 . P + 1 . \frac{5}{4} P_r^{\circ} + 3 .$ Fig. 3.

The edges between b and two adjacent faces of d are parallel.

4. $P - \infty . P . P_r^{\circ} + 1 . (P_r^{\circ})^3 . P + 1 . \frac{5}{4} P_r^{\circ} + 3 .$ Fig. 4.

The crystals are very much compressed between a and a . They assume the aspect of Fig. 5., or of a six-sided table with two angles of $119\frac{1}{2}^{\circ}$, and four of $120\frac{1}{4}^{\circ}$. The faces i are usually smaller than those marked m , which in fact are nothing but a succession of planes, having the inclination of f and g .

Cleavage is highly perfect, and easily obtained, parallel to the face a ; in other directions the laminae may be torn asunder, like

thin sheet-lead, but they do not present any traces of cleavage.

The broad faces *a* are delicately streaked parallel to the edges of combination with *h*, or in the direction of the long diagonals of the rhombic plates. They possess high degrees of lustre. The lustre upon the other faces is not so bright, and they are streaked parallel to their intersections with *a*; the faces *d* less than the rest. A difference of tarnish is likewise often observable. The faces *a* retain their original colour, while all the rest assume a superficial violet-blue tint.

The lustre is metallic; colour dark pinchbeck-brown, nearly resembling the colour of magnetic pyrites, only it inclines more to black.

It affords a black streak. It is very sectile. The laminae are perfectly flexible, and after having been bent, they may be smoothed down again with the nail, like tin-foil or platina leaf.

The hardness is = 1.0 . . . 1.5, little superior to talc. On account of this low degree of hardness, the mineral leaves traces on paper like black lead, which may be removed by a piece of caoutchouc. The specific gravity of several fragments, amounting to 598 milligrammes, I found = 4.215.

Two individuals often join in a regular composition, and produce a twin-crystal; the axis of revolution being perpendicular, the face of composition parallel, to a face of $P + \infty$. Fig. 6.

Fig. 7. shews a projection of such a twin upon a plane parallel to the face *a*. The appearance of the twins is, however, not always very regular. Sometimes they are joined by their sides, in a manner somewhat analogous to the twins of felspar found near Carlsbad in Bohemia.

Generally several crystals are joined in an irregular manner, and implanted together, being fixed to their support with one of their sides, so as to produce rose-like aggregations, and globules

with a drusy surface. Massive varieties usually present the appearance of certain kinds of mica.

The crystals subjected to measurement were taken from Mr NEUMANN'S specimen. Owing to the striæ upon the crystalline faces, parallel to the intersections of these faces with the face a , and to the great flexibility of the laminae, the angles could not be ascertained with the utmost degree of exactness. The dimensions of the forms were calculated from the admeasurement of the angle at the base of $P = 118^\circ$, and of the angle abc in Fig. 7., shewing the inclination of two faces parallel to its short diagonal in a twin-crystal, the latter of which was found to be equal to $119\frac{1}{2}^\circ$. The remaining measurements which were taken, agreed with the angles obtained by calculation, as well as could be anticipated from the nature of the substance. There is no mineral, however, which could be confounded with it among those of a similar aspect, if we except, perhaps, the flexible sulphuret of silver, first described by Count BOURNON *, a substance which I never had an opportunity of examining. The angles given by Mr BROOKE † being 125° instead of $119\frac{1}{2}^\circ$, and the character of symmetry itself, since he considers a rhomboidal prism, and not a rhombic one, as the type of the forms of the species, sufficiently establish a crystallographic difference between the two substances. The difference among them is strengthened even by the difference in the shade of colour, said to be black in the flexible sulphuret of silver, whereas Sternbergite is decidedly brown, although the characters of flexibility and hardness pretty nearly agree. The remaining properties, particularly the specific gravity, which would be of great importance, have not been ascertained in the flexible sulphuret of silver.

* *Catalogue*, p. 209.

† *Phillips' Mineralogy*, p. 289.

The flexible sulphuret of silver was found by Dr WOLLASTON to contain silver, sulphur, and some traces of iron. In this respect Sternbergite is very nearly allied to it, only the iron forms a much more considerable part of the composition, as appears from the experiments with the blowpipe.

In the glass-tube it gives off a strong odour of sulphurous acid, loses its lustre, and becomes dark-grey and friable. Alone on charcoal, it burns with a blue flame; and sulphurous odour, and melts into a globule, generally hollow, with a crystalline surface, and covered with metallic silver. The globule acts strongly on the magnetic needle, and before the blowpipe it has all the properties of sulphuret of iron. It communicates to fluxes the ordinary colours produced by iron, red while hot, and yellow on cooling, in the oxidating flame, greenish in the reducing flame. Borax very readily takes away the iron, and leaves a button of metallic silver.

The characters observable in Sternbergite, and its great resemblance to the black tellurium, to the flexible sulphuret of silver, to the rhombohedral molybdena-glance, unequivocally assign it a place in the order Glance of the system of Professor MOHS. Whether it should form a genus of its own, or be comprised within one genus, with one or several of the above-mentioned species, remains doubtful, as long as those species themselves are so imperfectly described. No systematic name, therefore, can at present be applied to it.

In proposing a single name for this mineral, I cannot find a more appropriate one than that of *Sternbergite*, in honour of Count CASPAR STERNBERG; and I know, that, in doing this, I concur with the feelings of my friends NEUMANN and ZIPPE, who so liberally furnished me with the specimens examined. I could not forego the pleasure of thus paying a just tribute to a man in his exalted station in life, equally high in scientific attain-

ments and in patriotic zeal, who has been most forward in establishing the National Museum at Prague, an establishment eminently calculated to be useful to travellers, who thus find means to examine at once the productions of the country; but still more important for the inhabitants, to whom it affords an opportunity of acquiring information in various branches of knowledge, and among whom, in particular, it diffuses a taste for the natural sciences.

II. *A Description of some Remarkable Effects of UNEQUAL REFRACTION, observed at Bridlington Quay, in the Summer of 1826.* By the Reverend W. SCORESBY, F. R. S. S. Lond. & Edin. M. W. S., and Corresponding Member of the Institute of France.

(Read January 22. 1827.)

IN the session of 1820–21, I had the honour of communicating to the Royal Society, a description of some remarkable atmospheric refractions observed in the Greenland Sea. Since that period, additional opportunities for observation, under circumstances peculiarly favourable, afforded a great number of other examples of a similar kind, along with some still more singular. Among these, the most extraordinary was the inverted image of a ship, which appeared in the lower part of the atmosphere, so distinctly and beautifully defined, that I could venture to pronounce it to be the representation of my father's ship, as, indeed, it proved to be, though we were then distant from each other about 28 miles, and some leagues beyond the limit of direct vision. But an account of the principal* of these extraordinary appearances is already before the public, and I merely allude to them, in consequence of their similarity to the refractions I have now to describe, that occurred upon our own coasts.

These phenomena occurred during the last summer about Bridlington Bay, and were seen from my residence at Bridlington Quay.

I shall first describe the appearance of the shipping in the Bay, as represented in Plate II. Fig. 5.

* Voyage to Greenland in the Summer of 1822.

REMARKABLE EXAMPLES OF UNEQUAL REFRACTION seen from the QUAY, BRIDLINGTON.

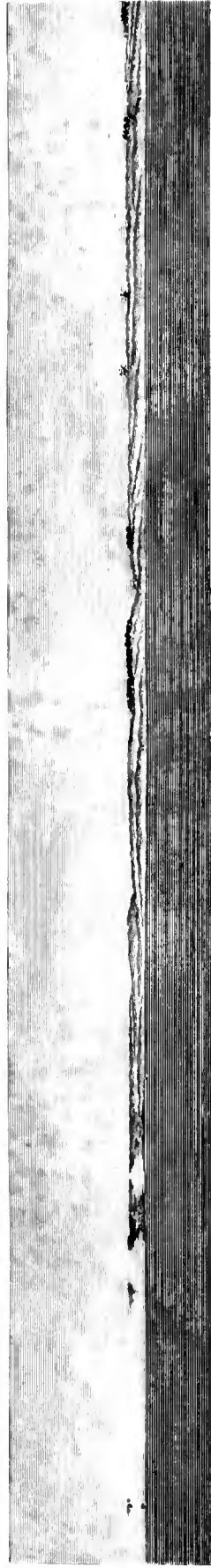

1. Appearance of the HOLDERNESS COAST as seen by the naked eye, from the altitude of 60 feet above the level of the Sea. June 21st U.A.M. 1826.

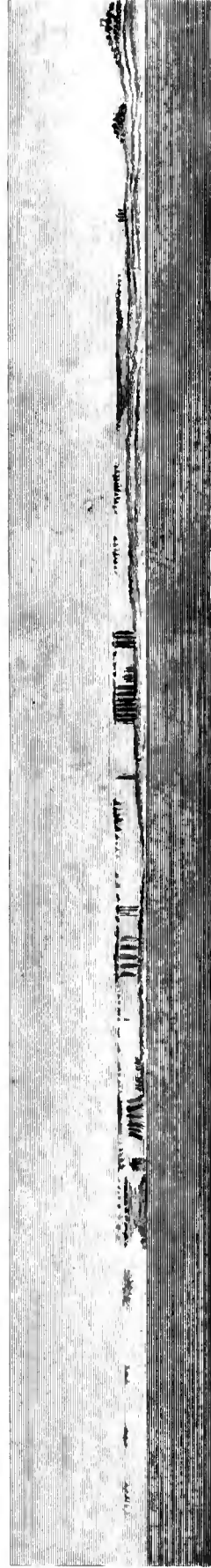

2. The same Coast seen at the same time, from the height of 40 feet.

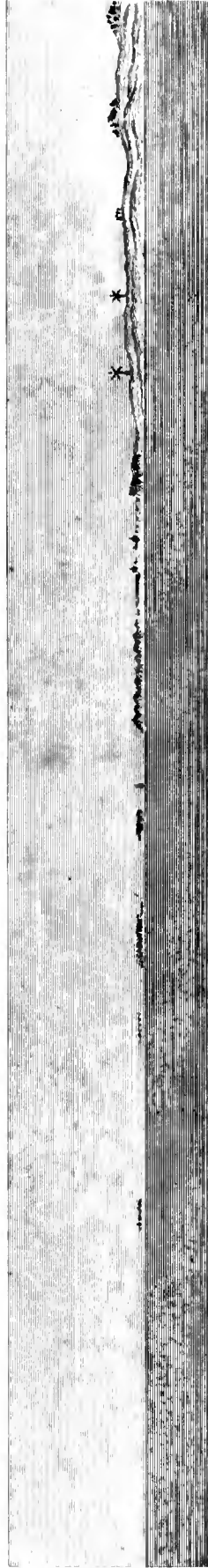

3. The same Coast seen at the same time, from the height of 20 feet.

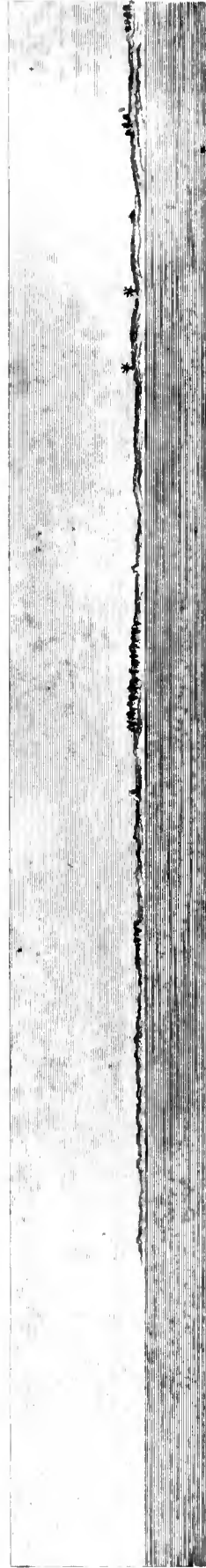

4. The ordinary appearance of the same Coast as seen, from the height of 40 feet.



5. Telescopic Appearance of the Shipping in the offing of BRIDLINGTON BAY, on the 12th, 24th, 25th and 26th of June 1826.



In the afternoon of the 12th of June, about five o'clock, after a clear hot day, the phenomena were first observed. All the shipping, at a sufficient distance, began to *loom*, and were variously distorted, and many vessels, when examined by the telescope, exhibited inverted images immediately above them. A portion of the extreme verge of the sea seemed to separate, as by a transparent fog-bank, and, between the real horizon and this refracted horizon, all the distortions and inverted images occurred. Some of the ships were of their natural proportions, with an inverted *fac-simile* above. Others, at distances, or in situations such, that the top of the masts reached more than one-half the height of the refracting interval, were abridged of their upper sails. One brig, nearer than the rest, only exhibited its hull and courses, with an inverted resemblance of the same over the top; and what gave it a still more curious appearance, was, a narrow clear space between the vessel and the image, as if there were in that place (in the line of the top-sails of the brig) a perfect void. In one or two cases, besides the inverted image, there was also an imperfect erect image, placed upon the upper line of the horizon. Most of the vessels figured, though they appear situated upon the true horizon, were, in reality, greatly more distant, and many of them altogether beyond the limit of ordinary vision. Hence, whilst the eye was fixed upon them, owing to the perpetual changes of the atmosphere, one or other of them would frequently disappear, and remain for some time invisible, and then suddenly start into sight as before. Objects within the horizon (about six miles distant) were scarcely, if at all, affected by the refraction. The upper or refracted horizon was often irregular in its outline, and sometimes broken. It was generally dark, and well defined; but the interval between it and the real horizon was frequently more faint in its shade, as if by attenuation. Sometimes there was a treble horizon exhibiting parallel streaks. The low coast of Holderness (forming the south-

ern part of Bridlington Bay) was slightly influenced by the same refraction. The air on this occasion was clear and calm,—occasionally there was a gentle sea-breeze.

Twelve days after this (June 24th), the phenomena were repeated with several new peculiarities, especially in regard to the land, as hereafter noticed. The interval between the true and refracted horizons (measuring between one and two minutes of a degree) was, as before, of a bluish-grey colour, and resembled a thin mist. But, besides the usual appearances of the ships, there were many erect images perched, as it were, upon the upper line of the horizon, and belonging to vessels that were evidently far out of sight! This occurred at noon, when the temperature was 80° in the shade. In the afternoon, the temperature becoming more equable, most of the phenomena disappeared; but in the evening, with the change of temperature, they were renewed in their principal varieties. On this day the sky was again cloudless, with a slight breeze from the eastward, though occasionally it was quite calm.

The following day there were very beautiful repetitions of the phenomena. The upper horizon was occasionally double and broken. A second erect image, of some of the ships, appeared between the two upper lines.

Again, there was a renewal of these interesting appearances on the 26th of June. The day was, as before, clear and hot; but with a smart sea-breeze. The horizon began to separate about 10 A. M., and between 11 and 12, every object at sea, beyond the distance of six miles, became influenced by the unequal refraction. There were, on this occasion, several instances of a single inverted image of a ship, clearly defined, though the ship to which it referred was altogether out of sight!

Two or three days after this I left the coast, and had no other opportunity of looking out for these phenomena until the middle of August; and after that time I could never perceive any recurrence of them.

All the representations of ships in Plate II. (Fig 5.), it should be observed, are telescopic, being taken from a view obtained with an ordinary spy-glass. With the naked eye, the looming of the vessels could be readily perceived; but it required a magnifying power to resolve the apparently confused and enlarged outline into the ship and its images. The images were, in most respects, very similar to what I have formerly observed in the Arctic Regions; though scarcely so distinct and well defined. In high latitudes, indeed, I have seen them as sharp and definite as if cut with a graver.

On June the 24th, a day already referred to as one distinguished by unequal refractions, the Holderness Coast was most singularly affected by the state of the atmosphere. The ordinary appearance of this coast, as seen from the window of my sitting-room, which commands a view of all the southern part of Bridlington Bay, is that represented in Plate II. Fig. 4. But in the forenoon of this day, the sun having intense power, this low and uninteresting part of the promontory, terminating at the Spurn, assumed the appearance of Fig. 2. to the naked eye. Slight hummocks and knolls, on the ridge of the land, were raised into parallel vertical pillars, resembling immense detached columns of basalt; and the whole range, for a considerable extent, seemed to be surmounted by a horizontal and almost continuous platform! This platform or causeway, which it resembled, seemed in many places entirely unsupported; the clear view of the sky being obtained beneath it. But this apparent platform was in reality the refracted image of the stratum of land beneath, forming continuous columns, where the land was highest and the image joined the protuberances; but leaving vacant interstices, where the land was low and the resemblances more remote.

Having made a sketch (Fig. 2.) of the appearance of the coast from my window, which is at the height of about 40 feet above the level of the sea at low-water, (the state of the tide at

the time), it occurred to me that there might possibly be a difference of appearance at another level. And, on ascending to the attic story (about 60 feet above the sea), I was surprised to find the phenomena altogether changed (see Fig. 1.), and the natural form of the land almost restored. Having made a sketch of this appearance, I returned to the sitting-room, and found the refracted state before observed from thence remaining unchanged.

I next descended to the cellar-flat (about twenty feet above the sea), where, on a level platform, by the side of the house, there was a clear view of the same coast. Here, again, I experienced another surprise, in finding the appearance almost perfectly what it ought to be at that level (see Fig. 3.), scarcely any remains of the refractive influence being observable; yet at the middle position, in the sitting-room, the phenomena continued unaltered! No material change, indeed, occurred in the general character of any of the views, whilst I was making the three first sketches given herewith. The last view (Fig. 4.) was taken on a subsequent day, and all the four were arranged in the same vertical plane, and adjusted to the same proportions, by marking on the sketches the position of a regular series of posts on the side of a wooden pier, which fortunately lay extended beneath the whole line of coast. This renders the comparison between the effects attributable to the refraction, and the natural state of the view, quite certain.

On this occasion, objects within four miles of the observer, were slightly influenced by the refraction, though the greatest effects occurred, in respect to objects six to ten miles distant. The phenomena continued to preserve their character, as seen from the three different levels, for above an hour, and then the appearance of Fig. 2. began to descend; so that eventually, as the heat of the day increased, or rather became more general and uniform, the view from the sitting-room became nearly that of Fig. 1., whilst Fig. 2. was seen from a level ten or fifteen feet

lower. Shortly after mid-day, it appeared so striking from the level of the street, (ten feet below the sitting-room), that it began to attract the notice of all the inhabitants in the neighbourhood.

From 2 until 5 P. M., the phenomena were more indistinct, and less interesting; but as the heat began to abate (towards 6 P. M.), the appearances observed in the morning were in a great measure repeated.

On several other occasions, the coast of Holderness was seen through unequally refractive media; but there was no appearance so interesting as the one above described.

No other cause requires to be sought for, in explanation of the phenomena, than that of different parallel strata of air, of unequal density, so ably demonstrated and illustrated by Dr WOLLASTON (*Phil. Trans.* for 1810); and so strikingly exemplified by Dr BREWSTER, in his experiments resembling the very effect in nature, with hot and cold strata of water or glass.

Nor is the striking peculiarity observed on the Holderness Coast, of the phenomena being confined to a particular level in the position of the observer, of difficult explanation. In this case, it is perhaps only necessary to suppose, (I speak doubtfully, however), that the distant coast, observed from the upper altitude, was seen altogether through an upper stratum of air, of pretty uniform density; and also observed from the lower station, that it was either seen chiefly through a lower stratum, or through different strata, amid which the rays of light passed from the distant coast converging, but not having arrived at a focus; but that from the middle altitude, the rays from the land passed so obliquely out of one medium into the other, that a part was refracted back again into the former medium, so as to double the object, by presenting an inverted image.

The occasion of the frequency of these phenomena, during the last summer, and of their extraordinary character, may, per-

haps, be accounted for, from a remarkable and sudden change in the temperature of the air. The cool weather of the preceding spring had continued down till the beginning of June. The sea, even near the coast, was, in consequence, at its winter temperature, whilst the air became quickly heated, by the fervent glare of an unclouded sun. When, therefore, the air near the surface of the earth became greatly warmed, the stratum immediately in contact with the sea was chilled by its coldness, whereby media of unequal density and refracting power were produced. And through these unequal media, the rays of light both from the shipping and the Holderness Coast, had to pass to the eye of the observer,—an uninterrupted surface of water, in all cases, lying between the objects and myself. The passing of the rays of light, at an extremely small angle, through these different strata of different refracting powers, would sufficiently account, on the principles already referred to, for most of the phenomena observed.

BRIDLINGTON QUAY, }
 December 1. 1826. }

III. *On a New Combustible Gas.* By THOMAS THOMSON, M. D.
F. R. S. Lond. & Edin. Professor of Chemistry in the
University of Glasgow.

(Read April 16. 1827.)

IT has been generally known for several years, that, when the acetic acid formed by the distillation of wood is rectified, there is obtained a transparent spirituous liquor, analogous in many respects to alcohol, though very different in others. This liquid has received the name of *pyroxylic spirit*. It is manufactured by MESSRS TURNBULL and RAMSAY of Glasgow. I have been in the habit for several years of employing it for combustion in lamps instead of alcohol. It is a good deal cheaper, and raises just as good a heat as alcohol; for I can make the small platinum crucible, which I use for drying the products of analysis, red-hot by means of a pyroxylic spirit lamp in a few minutes.

Pyroxylic spirit is as limpid and colourless as alcohol. Its specific gravity, when well rectified, is 0.812. It has an agreeable smell, not, however, quite free from that of naphtha. Its taste is very disagreeable, owing, I believe, to a small portion of naphtha, or empyreumatic oil, which it holds in solution, and from which we cannot free it by any known process. A set of experiments on pyroxylic spirit by MESSRS MACAIRE and MARCET was published in the *Bibliothèque Universelle* for October 1823. These gentlemen have described several of its properties, and subjected it to an analysis, from which it appears that, like alcohol, it is composed of hydrogen, carbon and oxygen, though the atomic proportions are different.

My object, in this short paper, is to give an account of a new gaseous substance which I accidentally obtained about a year

ago, when I attempted to substitute pyroxylic spirit for alcohol in some processes which I had occasion to perform during a set of experiments on protoxide of chromium, in which I was at that time engaged. The gas in question may be easily procured by the following process.

Put into a flask a mixture of $1\frac{1}{2}$ ounce of muriatic acid, half an ounce of the nitric acid of commerce, and half an ounce of pyroxylic spirit, all by measure. By means of a perforated cork insert a bent glass-tube into the mouth of the flask. The cork must fit so tight, that nothing can escape from the flask except through the tube. Heat the mixture over a spirit lamp till it begin to effervesce, and till the colour of the liquid changes to red. The flask must then be withdrawn from the lamp, and the extremity of the bent tube plunged into a mercurial trough. The gas issues in torrents for five or six minutes, and may be collected in any quantity, in glass jars, previously filled with mercury, and inverted on the trough. From the quantity of materials stated above, I think at least 200 cubic inches of the gas are extricated.

The gas, as it comes over, acts with considerable energy on the mercury; both calomel and corrosive sublimate being formed in abundance. But this is owing to the presence of some chlorine, with which the gas, as it issues from the flask, is mixed. For when we transfer the gas into a clean jar, it may be left for any length of time on the trough, without acting in the least on the mercury, or changing its volume.

The gas thus obtained possesses the following characters:

1. It is transparent and colourless, and possesses the mechanical properties of common air.

2. Its smell is exceedingly pungent and disagreeable; but so peculiar, that I can compare it to nothing else. It acts with

considerable energy upon the eyes and nose, occasioning a flow of tears, and exciting considerable pain in the eyes.

3. It is combustible, and burns with a lively bluish-white flame.

4. Water absorbs it pretty rapidly: one volume of water, in my trials, absorbed five volumes of the gas. The water acquires a pungent taste, and the peculiar smell of the gas. But it does not alter the colour of litmus or cudbear paper.

5. One volume of oil of turpentine absorbs thirty volumes of the gas; the oil assumes a light-green colour, and resembles cajepu; but still retains its peculiar odour.

6. The gas is neither absorbed by acids nor alkalies. Hence it possesses neither acid nor alkaline properties.

7. When common air or oxygen gas is mixed with this gas, the usual red fumes of nitrous acid appear, and the volume of the mixture is diminished. It is not, therefore, a homogeneous substance, but contains mixed with it a considerable proportion of nitrous gas. I endeavoured to determine the proportion of nitrous gas in 100 volumes, by mixing it with determinate quantities of oxygen gas over mercury. The diminution of volume was noted, and two-thirds of that diminution reckoned as nitrous gas. This method of proceeding is not susceptible of perfect accuracy, because the nitrous acid formed acts upon the mercury. But as the action is not rapid, and the time of each experiment short, I do not think that the error thence arising could amount to so much as 5 per cent. Five experiments made in this way did not absolutely agree with each other. But the discordancy did not exceed 4 per cent. A mean of the whole gave the amount of nitrous gas in 100 volumes of the new gas, 63 volumes, or rather more than three-fifths of the whole.

I tried to determine the proportion of nitrous gas over water, by causing the water to absorb the new inflammable gas, and then agitating the residual gas in a solution of protosulphate of iron. But this method yields no good results. The new in-

flammable gas has the property of greatly increasing the absorbability of the nitrous gas in water; so much so, that a gas, which, when analysed over mercury, was found to contain 63 per cent. of nitrous gas, if it was agitated in water, as long as that liquid continued to absorb it, left no more than 7.5 per cent. of nitrous gas. I abide, therefore, by the analysis over mercury, which, from numerous comparative experiments, cannot deviate very far from the truth.

100 volumes of the gas, after being washed in water, and in a solution of protosulphate of iron, left 8 per cent. of azotic gas.

Thus it appears, that the gas extricated from a mixture of aqua regia and pyroxylic spirit, is a mixture of

New inflammable gas,.....	29
Nitrous gas,.....	63
Azotic gas,.....	8

100

Whether these proportions be constant, I cannot venture to determine. But I analysed gas obtained in ten different processes, without finding any deviation in the proportions of its constituents. I found the specific gravity the same in gas from two different processes.

8. The specific gravity of the gas was taken in a flask which had been twice exhausted, and filled each time with hydrogen gas. It was 1.945, the specific gravity of common air being reckoned unity.

It is easy to calculate the specific gravity of the pure inflammable gas in this mixture.

Let A = volume of nitrous and azotic gas ;

a = specific gravity of a mixture of 63 volumes nitrous
and 8 azotic gas ;

B = volume of inflammable gas ;

x = specific gravity of inflammable gas ;

c = specific gravity of the mixed gas.

We have, from a well-known hydrostatical property of gases,

$$x = \frac{(A + B) c - A a}{B}.$$

In the present case,

$$A = 71 ; a = 1.03384 ;$$

$$B = 29 ; c = 1.945.$$

$$\text{Consequently, } x = \frac{(100)1.945 - 71 \times 1.03384}{29} = 4.1757 ;$$

4.1757 considerably exceeds the specific gravity of chloro-carbonic acid, or the phosgene gas of Dr DAVY, which is 3.4722.

9. I found by repeated trials, that the new inflammable gas, (the nitrous gas being removed by means of oxygen gas and potash), requires for complete combustion twice its volume of oxygen gas. The mean of five experiments gave 12 volumes inflammable gas, and 24.38 volumes of oxygen gas consumed, when an electric spark was passed through the mixture over mercury. The only products after the combustion were calomel and carbonic acid gas.

When the detonation of the mixture of the inflammable gas and oxygen was made over a little water, holding nitrate of silver in solution, the liquid became milky, owing to the formation of chloride of silver. It is obvious from these facts, that two of the constituents of the gas are *chlorine* and *carbon*.

A mixture of 12 volumes of gas, and 24.38 volumes of oxygen, left, after detonation over mercury, 15.43 volumes of carbonic acid gas. This is a mean of four experiments, which did not agree very well with each other; two of them giving only 13.89 volumes of carbonic acid, and the other two 15.98 volumes. I made twelve additional experiments, with a view of getting results more to be depended on. But the mean of the whole scarcely differed from 15.43, and the same discordancy appeared in the new as in the old experiments.

The result of the analysis seems to be, that 12 volumes of the gas consume 24 volumes of oxygen, and form 16 volumes of carbonic acid gas.

The 16 volumes of carbon would require 16 volumes of oxygen to convert them into carbonic acid gas. The 8 remaining volumes of oxygen, must have united to hydrogen; and they would require 16 volumes of hydrogen gas to convert them into water.

Thus it appears, that the gas contains equal volumes of carbon vapour and hydrogen gas; 1 volume of the gas requires for complete combustion 2 volumes of oxygen, and it forms $1\frac{1}{3}$ volume of carbonic acid gas. The remaining 0.66 volume of oxygen must have combined with $1\frac{1}{3}$ volume of hydrogen, and formed water. Hence a volume of the gas contains

$1\frac{1}{3}$ volume of carbon vapour, }
 $1\frac{1}{3}$ volume of hydrogen gas, } condensed into one volume.

Specific gravity of $1\frac{1}{3}$ volume of carbon vapour,	0.5555	
_____ $1\frac{1}{3}$ volume of hydrogen gas,	0.0926	
Total,	-	_____ 0.6482

This subtracted from 4.1757, (the specific gravity of the gas), leaves 3.5275; which must be the weight of chlorine gas contained in a volume of the combustible gas. Now the specific gravity of $1\frac{1}{3}$ volume of chlorine gas is 3.3333.

The gas seems to be a compound of

$1\frac{1}{3}$ volume carbon vapour, }
 $1\frac{1}{3}$ volume hydrogen gas, } condensed into one volume.
 $1\frac{1}{3}$ volume chlorine gas, } These added together make
a specific gravity of 3.9814.

This is lighter than the gas was found by experiment by about $\frac{1}{21}$ st part. But there is some uncertainty about the actual

specific gravity, as it depends upon the proportion of nitrous gas, a proportion not determined with perfect accuracy.

I am disposed to consider it as not unlikely, that the proportion of nitrous gas may have been rather underrated. On that supposition, I think it very probable, that the true constituents of a volume of the gas are,

1 volume carbon vapour,	0·4166
1 volume hydrogen gas,	0·0694
1½ volume chlorine gas,	3·7500
	4·2361

This would make the specific gravity of the gas 4.2361 ; which only exceeds the specific gravity found by about $\frac{1}{70}$ th part. A difference certainly not greater than might be looked for in determining the quantity of nitrous gas mixed with it.

The gas, then, is a compound of

1 atom hydrogen,	0·125
1 atom carbon,	0·750
1½ atom chlorine,	6·750
	7·625

and its atomic weight is 7.625.

It contains only half the carbon and hydrogen, but 1½ times the chlorine which exists in a volume of chloro-carbonic acid.

As it will be requisite to distinguish this new inflammable gas by a name, perhaps the term *sesqui-chloride of carbo-hydrogen*, may be employed as giving an accurate idea of its composition.

The discovery of this gas was gratifying to me, for a reason which it may be worth while to explain. In the "*First Principles of Chemistry*," vol. i. p. 249, I pointed out a remarkable property of the compound of one atom carbon and one atom hydrogen. This compound we may distinguish by the name *carbo-hydrogen*, since the appropriate term *carburetted hydrogen* has been un-

luckily applied to a different combination: Carbo-hydrogen has the property of forming a variety of gases and vapours, differing from each other in the number of integrant particles of carbo-hydrogen, which a single volume of the gas or vapour contains. The gas described in this paper (abstracting the chlorine), contains only one integrant particle of carbo-hydrogen in a volume; olefiant gas contains two integrant particles. One of the oleaginous liquids obtained by condensing oil-gas, which has been examined by Mr FARADAY in an insulated state, but which had been previously detected in oil gas, in the state of vapour, by Mr DALTON, contains three integrant particles. Sulphuric ether vapour (abstracting the water) contains four integrant particles; while the vapour of naphtha contains six integrant particles. The following table exhibits the atomic weights, and specific gravities, of these gases and vapours.

	Atomic Weight.	Specific Gravity.
Simple carbo-hydrogen gas, -	0.875.....	0.4861
Olefiant gas, or deuto-carbo-hydrogen,	1.75	0.9722
Oil-gas vapour, or trito-carbo-hydrogen,	2.625.....	1.4583
Ether vapour, or tetarto-carbo-hydrogen,	3.5.....	1.9444
Naphtha vapour of hexa-carbo-hydrogen,	5.25	2.9166

The existence of the simple carbo-hydrogen was merely hypothetical, till the discovery of sesqui-carbo-hydrogen has given us an example of its actual existence. Thus the only doubtful part of this reasoning has been shewn to be actually correct. This circumstance gives an importance to the discovery of sesqui-carbo-hydrogen, to which it would not otherwise be entitled.

IV. *Some Experiments on Gold.* By THOMAS THOMSON, M. D.
F. R. S. Lond. & Edin. Professor of Chemistry in the Uni-
versity of Glasgow.

(Read April 16. 1827.)

IN the first volume of my "*Attempt to establish the First Prin-
ciples of Chemistry by Experiment,*" p. 442, I give the analy-
sis of the sodium chloride of gold, and find the constituents to
be

2 atoms chlorine,	-	9
1 atom gold,	- -	25
1 atom common salt,	-	7.5
8 atoms water,	-	9
		50.5

But I state at the same time, my uncertainty whether the gold in the salt was in the state of a chloride or muriate. This uncertainty raising a doubt, whether the peroxide of gold contained two or three atoms of oxygen, I thought it highly necessary to clear it up. In this paper, I shall state the experiments which I have made with that object in view.

The whole weight of evidence is in favour of peroxide of gold containing 3 atoms of oxygen. We have the analyses of BERZELIUS repeated at two different times, and at a considerable interval, and, in both, that most skilful and accurate chemist found gold in the peroxide united with three atoms of oxygen. This analysis has been confirmed by M. JAVAL, who informs us, that he obtained the very same results as BERZELIUS had done.

The authority of these philosophers is deservedly of the greatest weight, and has, I believe, induced chemists, so far as I have had an opportunity of judging of their opinions, to consider the peroxide of gold as a ter-oxide.

1. In order to determine the quantity of oxygen combined with gold, when in the state of peroxide, I dissolved a known quantity of pure gold in nitro-muriatic acid, and rendered the solution as neutral as I could, by evaporating it to dryness in a very moderate heat, and then dissolving the crystallised salt in distilled water.

It has been long known, that proto-sulphate of iron has the property of precipitating gold from its solution in muriatic acid, in the metallic state, and that the salt is at the same time converted into persulphate of iron, obviously by uniting with the oxygen previously in combination with the gold.

I have shewn in my "*Attempt*," vol. i. p. 343, that an atom of iron weighs 3·5, and that the oxides of this metal are composed as follows :

Protoxide of	1 atom iron,	+	1 atom oxygen,
Peroxide of	1	+	$1\frac{1}{2}$

If the atomic weight of gold be 25, as I have shewn it to be, and if peroxide of gold contain 3 atoms of oxygen, then, in order to reduce 1 atom of peroxide of gold to the metallic state, it is obvious that we must employ 6 atoms of protoxide of iron ; so that to reduce 28 grains of peroxide of gold, we must employ 27 grains of protoxide of iron. To see how far this supposition was well-founded, 50 grains of gold were dissolved in nitro-muriatic acid ; 208·5 grains of newly crystallised protosulphate of iron were dissolved in warm distilled water, and the two solutions were mixed.

To understand the reason for taking 208·5 grains of protosulphate of iron, the reader has only to call to mind, that this salt is composed of

1 atom sulphuric acid,	5
1 atom protoxide of iron,	4·5
7 atoms water,	- 7·875
	17·375

so that 17·375 grains of this salt contain the equivalent of 1 atom of protoxide of iron. As 2 atoms of peroxide of gold were to be reduced, it was necessary to employ 12 atoms of protoxide of iron. Now, $17·375 \times 12 = 208·5$. So that 208·5 grains of protosulphate of iron, contain the equivalent of 12 atoms of protoxide of iron.

The gold, precipitated by 208·5 grains of protosulphate of iron, was collected on a filter, washed and dried, and exposed to a red heat. It weighed 48·04 grains, or 1·96 grain less than the quantity originally dissolved. An additional dose of protosulphate of iron being poured into the original gold solution, a farther precipitate of gold was obtained, which weighed 1·67 grains. Thus all the gold was recovered, with the exception of 0·29 grain, which I believe was lost, in consequence of the improper method taken to wash the gold. This was done by decantation. Now the films of gold were so extremely fine, that they were very apt to swim on the surface of the liquid. And though I was at great pains to avoid throwing any of the gold away, a few of these flocks might have escaped my observation. And as the decantation was repeated a good many times, I think a loss of 0·29 grain might have been sustained.

The gold precipitated by 208·5 grains of protosulphate of iron was almost 2 grains less than it ought to have been. I was prepared to expect this diminution of weight before I weighed

the gold. For I had tried the iron solution before mixing it with the muriate of gold, by means of prussiate of potash, which had struck with it a pretty strong blue, shewing, that the iron was not at all in the state of protoxide, but had been at least partially peroxidized; for protoxide of iron is precipitated white, and not blue, by prussiate of potash. This partial oxydizement had been induced by the air existing in the distilled water, and partly also by the air adhering to the crystals, when they were put into the water. For when I let fall a small crystal of protosulphate of iron into prussiate of potash, the precipitate was not quite white; but had a very sensible blue tinge.

2. The preceding experiment was repeated with additional precautions, to prevent the peroxydizement of the iron in the protosulphate. 25 grains of gold were employed in the experiment, and 104.25 grains of protosulphate of iron; the distilled water was boiled for half an hour before it was used, and the protosulphate of iron crystals were thrown into the boiling-hot liquid, which was added to the solution of gold as quickly as possible. The gold solution in this second experiment was not neutral, but had an excess of acid, from a notion that this excess might have a tendency to prevent so much air from being contained in the liquid as seemed to have been the case in the preceding experiment. The gold obtained weighed 24.9 grains; so that the loss was only 0.1 grain, which is little more than one-tenth of the loss sustained in the first experiment.

Even in this experiment, the iron was not absolutely in the state of protoxide; for the solution gave a whitish blue precipitate with prussiate of potash.

This last experiment coming within $\frac{1}{250}$ th of the theoretic quantity, I was satisfied with it. We see that the 25 grains of gold, dissolved in the muriatic acid, had been combined with 3 grains of oxygen. For six times 4.5 grains of protoxide of iron

had been converted into peroxide, and had, therefore, united with 3 grains of oxygen. I consider it demonstrated, therefore, that peroxide of gold is composed of

1 atom of gold,	-	25
3 atoms of oxygen,		3
		—
		28

3. I was curious to know the composition of muriate of gold. It was exceedingly probable, from the facts stated in the "*Attempt*," vol. i. p. 440, that muriate of gold is a compound of two atoms muriatic acid, and one atom peroxide of gold. But a direct analysis seemed more satisfactory. It was executed in the following manner.

Twenty-five grains of pure gold were dissolved in nitro-muriatic acid; the solution was cautiously evaporated, till it assumed a brownish-red colour. It was then allowed to cool. When cold, it was solid, had a most disagreeable, astringent, and metallic taste, and possessed the usual corrosive qualities which characterize muriate of gold. It weighed 42.8 grains. When this salt was dissolved in water, a small quantity of matter remained, which had a dirty-greenish colour, was easily reduced to metallic gold, by the application of the heat of a spirit lamp, and weighed, when thus reduced, 0.8 grain. Thus a quantity of muriate of gold, containing 24.2 grains of gold, weighed 42 grains.

To determine the quantity of muriatic acid in this salt, it was necessary, in the first place, to get rid of the gold. For, when nitrate of silver is dropt into the undecomposed salt, both the gold and the muriatic acid precipitate along with the silver. I therefore put a clear plate of copper into the solution, and left it till the whole gold had been precipitated in the metallic state. The copper was then precipitated by caustic potash, and after

the excess of potash had been neutralized by nitric acid, nitrate of silver was added to the solution, till it ceased to produce any farther precipitate. The chloride of silver being collected on a filter, washed, dried, and fused, weighed 34.65 grains, equivalent to 8.543 grains of chlorine, or 8.78 grains of muriatic acid.

Thus it appears, that 24.2 grains of gold, in the state of peroxide, had been combined with 8.78 grains of muriatic acid. Consequently, 25 grains of gold in the state of peroxide, must be united with 9.11 grains of muriatic acid. This is only 0.14 grain less than 9.25, the equivalent for 2 atoms of muriatic acid. From this result it is obvious, that muriate of gold is a compound of 2 atoms muriatic acid, and 1 atom peroxide of gold. The weight of the dry salt having been 42.8 grains, it is clear that it must have contained 5 atoms of water, and that muriate of gold is composed as follows :

2 atoms muriatic acid,		9.25
1 atom peroxide of gold,		28
5 atoms water,	-	5.625
		42.875

The precipitation of the gold by protosulphate of iron, seems to show, that the gold in this salt is in the state of oxide, and consequently combined, not with chlorine, but muriatic acid. It is equally clear, that, in the sodium chloride of gold, that metal is not oxydized, but in the metallic state, and united to chlorine. Hence the reason why it is so difficult to reduce the gold from the sodium chloride by heat, while it is so easy, by a very moderate heat, to reduce the gold from the muriate.

4. Gold furnishes a striking example of the want of coincidence in the proportions of oxygen and chlorine, which unite with bodies, and of the danger of being misled, when we infer the

composition of a chloride from that of an oxide. The peroxide of gold, containing 3 atoms of oxygen, one would have been disposed to infer, that the chloride would also contain three atoms of chlorine. Yet it contains only two atoms. This want of coincidence between the peroxide and chloride of gold, is probably the reason why the muriate of gold cannot be converted into a chloride by heat; at least all my attempts to obtain a chloride by that process, have ended in disappointment. In what manner the change takes place in the atomic proportions, when common salt is added to the muriate, it is not easy to conceive; but the experiments which I have related in this paper, and in my "*Attempt,*" leave, I conceive, no doubt that the conversion from muriate to chloride actually takes place.

5. There is an analogy visible between the muriate of gold and the hydrocyanate of potash. Both of these salts are very easily decomposed in their isolated state; but when we combine the former with an alkaline muriate, or the latter with a metallic hydrocyanate, they become both very permanent and difficultly decomposed salts.

6. It has been lately maintained by BERZELIUS, that muriatic acid is incapable of combining with metallic oxides; that no muriates exist, but merely *chlorides*, or compounds of chlorine and the metal, united to a certain quantity of water. With regard to the greater number of these compounds, it is a matter of indifference which of the two views we take. Thus we may either consider what is usually called muriate of barytes, as a chloride or a muriate. In the first case, the crystals of it will be composed of

1 atom chloride of barium,	13.25
2 atoms water, - -	2.25
	15.50

In the second case, the salt will be a compound of

1 atom muriate of barytes,	14.375
1 atom water, - -	1.125
	15.500

The atomic weight and the ultimate elements are the same in both views. The only difference is, that, if the salt be a muriate, one of the atoms of water is decomposed, its oxygen being united to the barium, and its hydrogen to the chlorine. While, according to the first view, all the oxygen and hydrogen present are united together, and constitute water.

But considerable difficulty will be experienced in applying this reasoning to the muriate of gold. If this salt be a chloride, it is obvious, from the experiments stated in this paper, that it is a compound of

2 atoms chlorine,	9
1 atom gold, - -	25
	34

The salt contains besides,	5 atoms of water,	= 5.625
	2 atoms hydrogen,	= 0.250
	3 atoms oxygen,	= 3.000
		8.875

Making a total of 8.875, which, added to 34, make 42.875, the atomic weight of the solid salt. But 2 atoms hydrogen, and 3 atoms oxygen, cannot unite together, so as to constitute water. Nor, on the supposition that the salt in question is a chloride, can we easily explain the reason why six integrant particles of protoxide of iron are necessary to precipitate one atom of gold, nor why the protoxide of iron, when employed to precipitate gold from its solution in muriatic acid, is converted into peroxide.

I may mention another example of a muriate, which cannot, without great violence, be viewed as a chloride,—I mean the permuriate of tin.

I have shown, in “*The First Principles of Chemistry*,” that the atomic weight of tin is 7·25, and that it forms two oxides, the protoxide, which is black, and the peroxide, which is yellowish-white. Protoxide of tin is composed of 1 atom tin + 1 atom oxygen, and its atomic weight is 8·25; while peroxide of tin is a compound of 1 atom tin + 2 atoms oxygen, and its atomic weight is 9·25. Muriatic acid combines with each of these oxides, and forms with each crystallisable salts. Both of these salts may be formed by dissolving tin in muriatic acid. And I have got them both in Mr MONTEATH’S Turkey-red work near Glasgow, where tin is dissolved in muriatic acid in large quantities, to prepare the usual mordant for dyeing. Permuriate of tin is the mordant used; but, occasionally, protomuriate of tin crystallizes likewise; and as it does not answer as a mordant, they were in the habit of throwing it away, till I ascertained its nature.

The protomuriate of tin is a white salt, which crystallizes in large oblique four-sided prisms, having usually one of the acute edges of the prism replaced by a tangent plane. It strongly reddens vegetable blues, probably because the crystals always shoot in a solution containing a large excess of acid. Lustre rather silky; but the salt is transparent. The taste is acid, and very acrid and disagreeable. Specific gravity 2·656.

When put into water, the crystals dissolve, with the exception of a few white flocks of hydrated tin. When heated, it melts, and flows like nitrate of silver, quite transparent and colourless; then it becomes dry, and a white matter remains, which is soluble in water. It dissolves in alcohol with the same opalescence as in water. In oil of turpentine it does not dissolve, but becomes yellowish and opaque, and increases in volume. Its constituents were found to be

1 atom muriatic acid,	4.625 + 0.209
1 atom protoxide of tin,	8.25
1 atom water,	- 1.125 + 0.77
	14.000

The excess of acid and water was doubtless derived from the acid solution in which the salt crystallized, and was mechanically lodged between the plates and the salt.

This salt might be viewed as a compound of 1 atom chloride of tin, and 2 atoms of water.

The permuriate of tin has been long known, being prepared on a large scale as the mordant in the scarlet dye. Its crystals are long white needles, seemingly four-sided prisms. The taste is acrid, and slightly acid. It reddens vegetable blues. When put into water, the liquid becomes quite milky. When the salt is heated, it melts, boils, loses its water, becomes yellow, fuses, and is volatilized in a white smoke. When analysed, it yielded

1 atom muriatic acid,	4.625 — 0.034
1 atom peroxide of tin,	9.25
$\frac{2}{3}$ atom water,	- 0.75 — 0.04

It contained also a small trace of protoxide of tin, amounting at most to $\frac{1}{20}$ th of the oxide present. Probably the water was only mechanically lodged in the salt, as it did not amount to an atom.

Were we to view this salt as a chloride, it would consist of

1 atom chloride of tin,	11.75
2 atoms oxygen,	- 2.00
1 atom hydrogen,	- 0.125

Here the oxygen and hydrogen could not form water. Nor, supposing the salt a chloride, could any reason be assigned why the tin is thrown down by an alkali in the state of peroxide rather than protoxide. On these accounts, I am induced to consider this salt, like that of gold, as a muriate, and not a chloride.



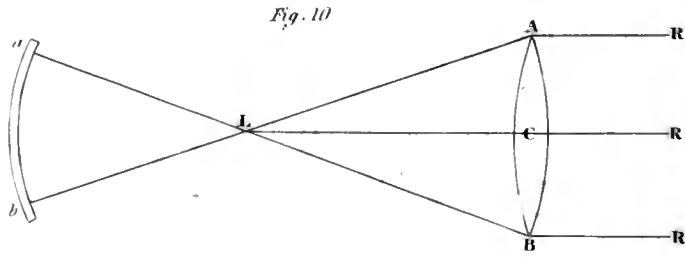
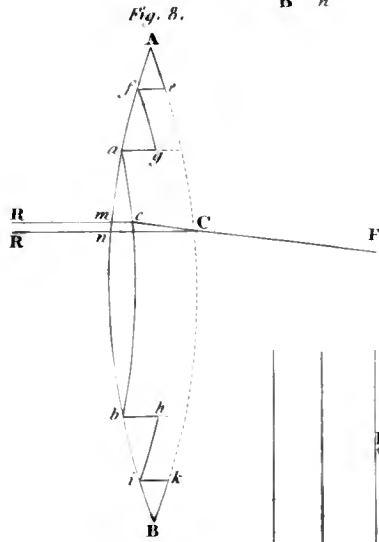
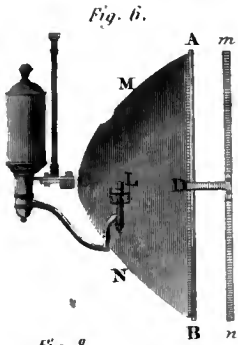
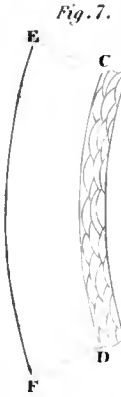
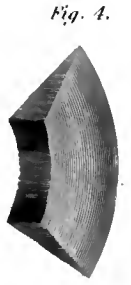
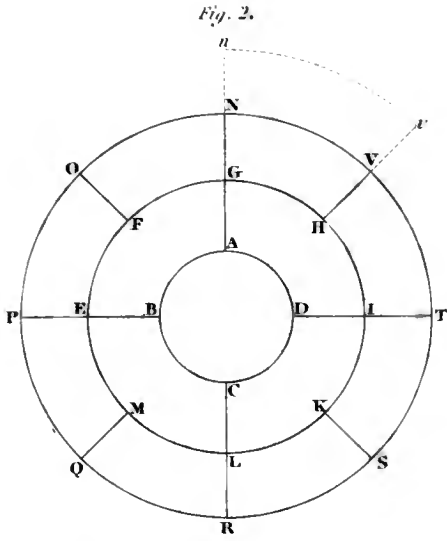

Fig. 5.

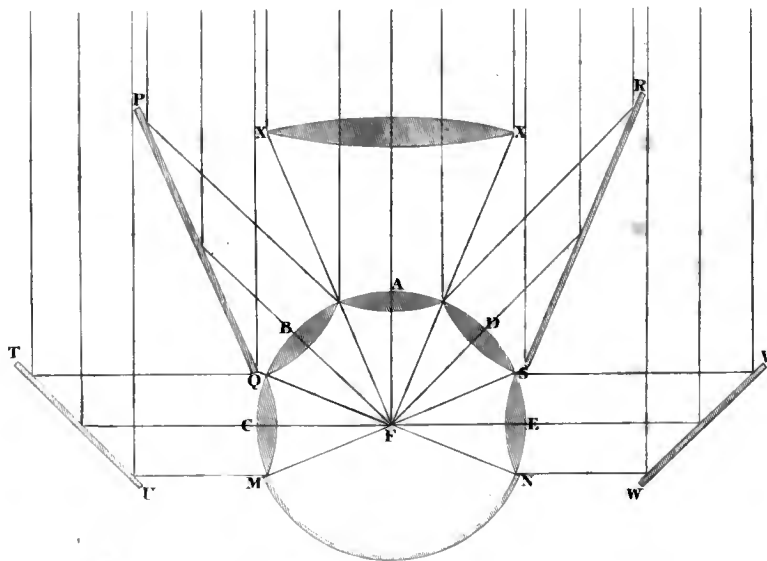
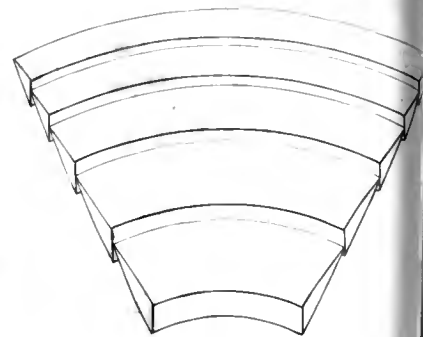

Fig. 11.



V. *On the Construction of Polyzoal Lenses, and their Combination with plain Mirrors, for the purposes of Illumination in Light-Houses.* By DAVID BREWSTER, LL. D. F. R. S. Lond. & SEC. R. S. Edin.

(Read May 7. 1827.)

IN the year 1811, when I was occupied in drawing up an article on Burning Instruments for the *Edinburgh Encyclopædia*, my attention was in a particular manner directed to the construction of Large Lenses, and to the different methods by which they could be combined with plane and spherical mirrors, for the purpose of obtaining an intense heat from the concentration of the solar rays. I was thus led to examine the inventions and contrivances which had been previously proposed by others, for accomplishing the same object; and after giving a historical account of them, I proceeded to describe the improvements and constructions which had occurred to myself.

In this inquiry, my attention was particularly arrested by an ingenious speculation of the celebrated BUFFON, for augmenting the power of Burning Lenses, by grinding out a portion of the glass, and thus diminishing their thickness, without altering their focal length. This idea will be understood by referring to Plate III. Fig. 1., which is BUFFON'S own perspective representation of it, and which he has described in the following words:

“ This method consists in working my piece of glass by steps. To make myself better understood, let us suppose that I wish

to diminish, by two inches, the thickness of a lens of glass 26 inches in diameter, 5 feet in focal length, and 3 inches thick at the centre. I divide the arc of this lens into three parts, and I make each of these portions of the arc approach to each other concentrically, so that there remains only an inch of thickness at the centre; and I form on each side a step of half an inch, to bring together the corresponding parts. By this means, in making a second step, I arrive at the extremity of the diameter, and I have a lens with steps, which is nearly of the same focus, and which has the same diameter, and nearly two times less thickness than the first, which is a great advantage.

“ If we wish, in short, to cast a piece of glass *four feet* in diameter, by *two and a half* inches in thickness, and to work it by steps to a focus of *eight* feet, I have computed, that, by leaving *one and a half* inch of thickness at the centre of this lens, and at the exterior ring of the steps, the heat of this lens will be to that of the lens of the Palais Royal as 28 to 6, without taking into account the difference of thickness, which is very considerable, and which I cannot estimate before hand.

“ This last kind of refracting mirror is the most perfect which can be made of its kind; and even if we should reduce it to *three feet* in diameter, by *fifteen* lines in thickness at the centre, six feet in focal length, which would render the execution of it less difficult, we should always have a degree of heat at least *four times* greater than that of the most powerful lenses that we know of. I venture to say that this mirror with steps will be one of the most useful instruments in physics. I have contrived it more than twenty years ago, and all the philosophers to whom I have spoken of it, are anxious that it should be executed. It might be made highly useful in the promotion of science, and by adapting to it a Heliostate, we might

perform in its focus all the operations of chemistry, as conveniently as could be done in a furnace *.”

There can be no doubt that the lens thus described by BUFFON, would have produced the effect which he ascribes to it, *had it been possible to execute it*; but though he invented it twenty-five years before he described it,—though all the philosophers to whom he mentioned it anxiously desired to see it made,—and though sixty years have elapsed since the publication of his work, such a lens has neither been attempted nor executed. The fact, indeed, recorded on the authority of M. ROCHON and M. CHARLES, that BUFFON had constructed a lens with steps made of *one piece of glass*, and only 12 or 15 inches in diameter, may be regarded as a proof that the principle was not practically applicable to lenses of a large size. So visionary, indeed, did the scheme appear to me, when I read BUFFON’S Memoir, of grinding down a solid lens, five, or even three feet diameter, into three spherical surfaces on each face, the one falling below the other, that I never hesitated to suppose that he proposed his lens to consist of three *separate* rings; and under the influence of this mistake, I drew up my description of BUFFON’S invention. But though the formation of the lens by means of three separate rings, would remove in a great measure the difficulty of grinding and polishing the successively descending surfaces, yet, even with this improvement, the scheme is just as visionary as before, since the difficulty and expence of casting, grinding, and polishing a ring of glass, *five* or even *three* feet diameter, is as great as to execute a solid lens of the same size.

But, however this may be, the lens actually proposed by BUFFON, ingenious as it is, must be ranked among those visionary contrivances which never find a practical application.

* *Supplément à l’Histoire Naturelle*, tom. ii. 12^{mo} Paris 1774.

Perceiving, therefore, that a limit was necessarily set to the construction of lenses of one piece, by the difficulty of procuring colourless homogeneous glass, and by the trouble and expence of casting and grinding it into its proper form, without flaws and impurities, I conceived the idea of *building a lens* with a number of separate pieces, and, in 1811, I printed in the *Edinburgh Encyclopædia* the following method of carrying it into effect.

“ In order to remove these evils, and at the same time to diminish the expence, and simplify the construction of dioptric burning instruments, the following construction has been proposed by Dr BREWSTER. If it be required, for example, to construct a burning lens 4 feet in diameter, it should be composed of different pieces, as represented in Plate III. Fig. 2., where ABCD is a lens of flint-glass, 18 inches in diameter. This lens is surrounded by several segments, AGID, AGEB, BELC, CLID, ground in the same tool with ABCD, but so formed with respect to their thickness at AB and GE, &c. that they may exactly resemble the corresponding portions of a solid lens. These different thicknesses can be easily calculated, and there is no difficulty in giving the segments their proper form. This zone, consisting of separate segments, is again surrounded with other segments, GNOF, FOEP, PEMQ, QMLR, RLKS, SKIT, TIHV, VHGN, each of which is six inches broad in the direction of the radius. The section of this lens is represented in Fig. 3. where DE is the central portion, DC *n*, E o F the second zone, and CA *m*, FB *p* the external zone. One of the segments is shewn separately in Fig. 4. By this combination of segments, a lens four feet in diameter will be formed, and will obviously possess the same properties as if it consisted of solid glass. The advantages of this construction may be very shortly enumerated.

“ 1. The difficulty of procuring a mass of flint-glass proper for a solid lens, is in this construction completely removed.

“ 2. If impurities exist in the glass of any of the spherical segments, or if an accident happens to any of them, it can be easily replaced at a very trifling expence. Hence the spherical segments may be made of glass much more pure and free from flaws and veins than the corresponding portions of a solid lens.

“ 3. From the spherical aberration of a convex lens, the focus of the outer portion is nearer the lens than the focus of the central parts, and therefore the solar light is not concentrated in the same point of the axis. This evil may, in a great measure, be removed in the present construction, by placing the different zones in such a manner that their foci may coincide *.

“ 4. A lens of this construction may be formed by degrees, according to the convenience and means of the artist. One zone, or even one segment, may be added after another, and, at every step, the instrument may be used as if it were complete. Thus, in Fig. 3. the segment $NV v n$ may be added to the lens, without the rest of the zone to which it belongs, and it will contribute, in the proportion of its area, to increase the general effect.

“ 5. If it should be thought advisable to grind the segments separately, or two by two, a much smaller tool will be necessary, than if they formed one continuous lens. But, if it should be reckoned more accurate to grind each zone by itself, then the various segments may be easily held together by a firm cement.

“ 6. Each zone may have a different focal length, and may therefore be placed at different distances from the focal point, if it is thought proper.”

Although the method now described enables us to construct lenses without any other limit to their magnitude, but that

* “ The burning focus lies a little beyond the red rays, and is therefore at a greater distance from the lens than the luminous focus.”

which arises from the difficulty of keeping the segments in their place, yet, when used for lighthouses or burning-instruments, the very purpose to which they are applied, we are confined to diameters of a moderate size. Under these circumstances, it may be desirable to introduce into the parallel or convergent beam a greater quantity of light than what passes through the lens. This may be effected by a catadioptric combination of lenses and mirrors, which I described in 1811, and which, when applied to lighthouses, possesses the advantage of throwing into one parallel beam almost every ray of light which diverges from the luminous source.

For the purpose of applying these, or lenses of any form, to produce powerful effects as burning instruments, I proposed the subsequent combination, under the name of a *Burning Sphere*. The following is the passage from the *Encyclopædia* :

“ In order to construct a burning instrument which shall, in a great measure, be unlimited in its power, we must combine the principles both of reflection and refraction. We are not aware that any instrument of this kind has ever been proposed ; and we are the more surprised at this, as the proper combination of lenses and mirrors must naturally suggest itself to any one who considers the limits which are set to the construction of single lenses, and the disadvantages, either of a theoretical or a practical nature, to which they are liable.

“ The lenses A, B, C, D, E, Plate III. Fig. 5., which may be of any diameter and focal length, are so placed in the spherical surface AMN, that their principal foci exactly coincide in the point F. If any of the lenses have a different focal length from the rest, the coincidence of its focus with that of the other may be easily effected, by varying its distance from F. The whole spherical surface, whose section is AMN, except a small opening for admitting the objects to be fused, may be covered with lenses,

having all their foci coincident at F; though it will, perhaps, be more convenient to have the posterior part MN without lenses, and occupied by a mirror of nearly the same radius FA as the sphere. The object of this mirror, is to throw back upon the object at F the light that passes by it without producing any effect. Each of the lenses, except the lens A, is furnished with a plane glass mirror, which may be either fixed to the general frame of the sphere, or placed upon a separate stand. When this combination is completed, the sphere is exposed to the sun, so that its rays may fall at right angles upon the lens A, which will, of course, concentrate them at F, and produce a pretty intense heat. The plane mirror PQ, when properly adjusted, will reflect the sun's light perpendicularly upon the lens B, by which it will be refracted accurately to the focus F, and produce a degree of heat fully one-half of what was produced by the direct refracted rays of the sun through the lens A. A similar effect will be produced by the mirror RS and lens D, the mirror TU and lens C, the mirror VW and lens E, and all the other mirrors and lenses which are not seen in the section. The effect may be still farther increased by the addition of a large lens at XX. As the angle which the surface of each mirror forms with the axis of its corresponding lens, is a constant quantity, the mirrors may be all fixed to the general frame of the sphere, and therefore the only adjustment which the instrument will require, is to keep the axis of the lens A parallel to the direction of the solar rays.

“ In order to estimate the advantages of this construction, let us compare its effects with those of a solid lens, which exposes the same area of glass to the incident rays.

“ 1. In the burning sphere, almost the only diminution of light is that which arises from reflection by the plane mirrors, and which may be estimated pretty accurately at one-half of the incident light; but this loss can be amply compensated by adding a few more lenses.

“ 2. In the solid lens, a great diminution of light arises from the thickness of the central portions, and from the obliquity of the parts at the circumference ; which, we conceive, will be fully equal to the light lost by reflection in the burning sphere.

“ 3. In the burning sphere, the lenses may be obtained of much purer glass than can be got for a solid lens ; and therefore, *cæteris paribus*, they will transmit more light.

“ 4. Owing to the small size of each lens in the burning sphere, the diminution of effect arising both from spherical aberration, and from the aberration of colour, will be very much less than in the solid lens.

“ 5. In the burning sphere, the effect is greatly increased, in consequence of the shortness of the focal length of each lens, and the greater concentration of the incident light.

“ 6. In the burning sphere, all kinds of lenses may be combined. They may be made of any kind of glass, of any diameter, and of any focal length ; *and the lenses belonging to different individuals may be combined for any occasional experiments in which a great intensity of heat is requisite.*”

To those who are acquainted with the laws of the distribution of light which passes through lenses, or which falls upon reflectors, it is scarcely necessary to say, that the very same apparatus which is best fitted for producing combustion from the solar rays, is also best fitted for producing the column of illumination in lighthouses. The only difference between the two operations is, that, in the one case, the parallel rays of the sun pass through the lens, and are refracted to its focus ; while, in the other case, the rays pass from the focus, and are refracted by the lens into a parallel beam. Hence, the *Polyzoal Lens*, and the *Burning Sphere* above described, are peculiarly applicable for the illuminating apparatus of lighthouses. This application of these contrivances early presented itself to me ; and some time between 1818 and 1820, I was in communication with Mr STE-

VENSON, the Engineer to the Scottish Lighthouse Board, on the subject of introducing the lenses into the Northern Lighthouses. The origin and history of this communication is as follows.

Between the years 1818 and 1820, some experiments had been made in France, with the view of fitting up lighthouses with *Lenses*, a method which had been in use in England in the Lower Lighthouse of the Island of Portland since 1789*. The French had proposed to use Lenses in connection with a very powerful lamp, the particulars of which were communicated in a letter from Major COLBY to Mr STEVENSON. On the receipt of this letter, Mr STEVENSON stated to me his intention of investigating the subject, in reference to the use of lenses in lighthouses. I immediately pointed out to him the improvements in the construction of lenses, and the method of arranging them for the purposes of illumination, which I had suggested in the Edinburgh Encyclopædia; and he proposed that we should make some experiments, with the view of introducing them into the Northern Lighthouses. Before proceeding, however, to this inquiry, Mr STEVENSON was anxious to obtain an account of what had been done in France; and having afterwards understood that the Cordouan Lighthouse on the French coast was to be fitted up with lenses, he stated it to be his intention to make personal observations upon it, whenever the alteration on that lighthouse should be completed.

Unfortunately, however, the years 1820, 1821 and 1822 passed away, without any thing being done to ascertain the merit of my invention for lighthouse illumination. In the beginning of November 1822, Mr STEVENSON and I received copies of a memoir by M. FRESNEL, entitled, *Memoire sur un Nouveau Systeme d'Eclairage des Phares*. This memoir was read at the Academy of

* The lenses in this lighthouse, which are two in number, are *twenty-two* inches in diameter.

Sciences on the 29th July 1822; and the *New System of Illumination for Lighthouses* which it describes, is, with the exception of the lamp* (which is a combination of the inventions of Count RUMFORD and M. CARCEL), the very same as mine. The compound lens which M. FRESNEL gives as an invention of his own, is the same as that which I had invented *eleven* years before; and the combination of lenses and lateral reflectors for widening the main column of light, is exactly the same as mine. In 1815, I had transmitted to the Library of the Institute of France, and also to M. BIOT, one of its most distinguished members, a copy of the EDINBURGH ENCYCLOPÆDIA, containing the article *Burning Instruments*, in which these inventions were not only described, but distinctly engraven; and it certainly seems strange, that, during the seven years which preceded the publication of M. FRESNEL's memoir, the eyes of none of his colleagues in the Institute should ever have fallen upon the above article, or upon the engravings by which it is illustrated. M. FRESNEL, however, has the honour of being the first who actually applied the built up lenses to lighthouse illumination; and M. BECQUEY, Rear-Admiral HALGAN, Baron ROSSELL, M. PRONY, M. ARAGO, and the other Commissioners for French lighthouses, are entitled to no slight praise for the liberality with which they seconded his views, and the promptitude with which they have adopted the valuable improvements which he submitted to their consideration.

Under these circumstances, I lost no time in calling the public attention to the history of these lenses, and to their great utility for lighthouses †; but although this appeal was made in December 1822, it excited no notice, and the compound lenses

* This lamp has been brought to a high degree of perfection by MM. ARAGO and FRESNEL, and is a most valuable addition to the apparatus for lighthouses.

† See *Edin. Phil. Journ.* vol. viii. p. 165.

seemed destined to share that fate which too frequently befalls British inventions that are beyond the sphere of individual enterprize.

In the year 1825, the Engineer of the Northern Lighthouse Board went to Paris, and brought over to Edinburgh one of the compound lenses as manufactured by M. SOLEIL. Although this invention had been ascribed to another, it was no slight satisfaction to find that it had been distinguished by the approbation of the most eminent French philosophers. It had occupied the attention of the Institute itself; and after repeated trials, and a careful comparison with the large parabolic reflectors of M. LENOIR, *thirty-one inches* in diameter, and certainly not inferior to any manufactured in this country, the Commissioners of Lighthouses for France, consisting of mathematicians, civil engineers, and officers of the navy, have adopted the compound lens, and the combination of lenses and mirrors, as a new system of illumination; and a definitive arrangement has been made for bringing it into immediate operation on the English Channel, the Bay of Biscay, and the Mediterranean Sea.

But notwithstanding all this testimony in its favour, the compound lens has never yet been put to a public trial in Scotland. In the course of last winter, it was carried to the Tower of London, and exhibited to a number of gentlemen distinguished by their rank and talents; but it was exhibited as a foreign invention, and some of those who witnessed its effects transmitted descriptions of it as such to the newspapers of Edinburgh, where it had long before been described, in two widely circulated works. Another of these lenses was brought from France as a Burning Instrument; and both it and the Compound Lens purchased by the Engineer to the Lighthouse Board, have been exhibited as a French contrivance in our own University.

Under these circumstances, I resolved to address myself directly to the Commissioners of the Northern Lighthouses; and the

reception I have experienced from that liberal and enlightened body, has convinced me, that if I had made this application in the year 1819, I should now have had the satisfaction of seeing the new method of illumination introduced into our own lighthouses. The Commissioners have allowed me opportunities of explaining to them, both personally and in writing, the construction and advantages of the new apparatus ; and I have been authorized to have one of the Polyzonal Lenses constructed under my own superintendence. This work has been entrusted to Messrs GILBERT of London, who are now executing one of the lenses in flint-glass, with a diameter and a focal length of three feet. I have no doubt that the Trinity-House of London, and the Corporation for Improving the Port of Dublin, the two bodies who have the superintendence of the English and Irish Lighthouses, will also concur in putting the new method to the test of direct experiment ; and I do not hesitate in expressing my conviction, that, in a few years, it will be established in every maritime country where the preservation of life and property has become an object of public concern.

Having thus given a brief account of the origin and history of the new system of illumination, I shall now proceed to point out its superiority to that which is at present in use. In doing this, I shall adopt the following arrangement.

- I. On the imperfection of the present system of illumination by Hammered Reflectors.
- II. On the construction and properties of the Polyzonal Lenses.
- III. On the combination of Lenses with Plain and Spherical Mirrors, for Fixed and Revolving Lights.
- IV. On the Construction of Distinguishing Lights.
- V. On the occasional exhibition of Powerful Lights in Lighthouses.
- VI. On the introduction of Gas into Lighthouses.

I. On the Imperfection of the present system of Illumination by Hammered Reflectors.

The best constructed lighthouses in Great Britain are fitted up with parabolic reflectors, like that represented in Plate III. Fig. 6. The dimensions of these reflectors are

Diameter AB,	- - - - -	24 inches.
Depth CD,	- - - - -	10½
Centre of wick from apex, or LC,	- - - - -	4
Circumference of wick from apex C,	- - - - -	3½
Circumference of glass-chimney from apex C,	- - - - -	3

The reflecting material, before it is hammered, is a flat disc of copper plated with silver, which, by repeated hammering upon a polished steel anvil, is beaten into the form of a paraboloid, by the assistance of a gauge, which the workman constantly applies to the hammered surface. When the reflector is brought as nearly to the concavity required as the gauge and the eye of the workman can determine, it is then polished *with the hand*, by rubbing it with a piece of leather and the usual polishing material*. It is then fitted up, as shewn in the figure, with an argand-burner placed in the focus of the paraboloidal surface, and supplied with oil by the lamp behind.

* "The reflectors," says Mr STEVENSON, "consist of a circular sheet of copper, measuring, when flat 26¼ inches in diameter; weighing 11½ lb. on an average, and plated with silver in the proportion of 6 oz. to each pound avoirdupois of copper. These plates are formed into the parabolic curve by a very nice process of hammering, and afterwards set into a bezil or ring of brass."—*Account of the Bell Rock Lighthouse*, p. 527.

The apparatus now described, is executed in a very admirable manner for the Northern Lighthouses; but no excellence in its execution, and no care in its application, can compensate for its numerous imperfections and disadvantages, which we shall now particularly explain.

1. *On the Imperfection of the Material employed.*—Of all reflecting substances, a silver surface, not produced by hammering, is the best. The effect of hammering is to give different densities to different parts of the hammered surface; and as it is proved *, that part of the light reflected from metals penetrates the reflecting surface, and that surfaces polished by hammering act upon the light in a different manner from a surface not hammered, and ground and polished upon pitch, it is manifest, that the light which enters a reflecting surface of unequal density, or upon which that surface produces a physical change, will not be reflected in lines determined by the form of the reflecting surface itself, but will be to a certain degree scattered in all directions. This effect will be understood by examining Fig. 7., where ABDC is the silver-plate highly magnified, and CDFE the copper, the intersecting arches shewing the effect produced by hammering.

2. *On the Imperfections of the Surface.*—The imperfections of the external surface of the present reflectors, arises from two causes: 1st, From its being a surface produced by hammering; and, 2dly, From its being covered with innumerable scratches and circular lines. From the *first* of these causes, the surface cannot possibly reflect a diverging pencil of light into a parallel pencil, even if the general surface were mathematically exact.

* See Art. OPTICS, *Edinburgh Encyclopædia*, vol. xv. p. 607.; and Biot's *Traité de Physique*, tom. iv. p. 579.

SIR ISAAC NEWTON has himself remarked, “ *That every irregularity in a reflecting superficies, makes the rays stray five or six times more out of their due course, than the like irregularities in a refracting one ;*” and we may therefore easily conceive what a scattering and dispersion of the rays must take place from a surface hammered into a parabolic curve. This dispersion may not appear so conspicuous, when we examine the reflected beam near the reflector itself ; but at moderate distances even, it must exercise an enormous influence, in weakening the intensity, disturbing the parallelism, and consequently destroying the uniform density of the reflected column of light. The *second* source of imperfection of surface, namely, the scratches and striæ, will be easily understood by those who have examined the beautiful Iris ornaments of MR BARTON. All the light which falls upon the scratches on a metallic surface, is reflected in coloured pencils to a distance from the direction of the rest of the light ; and this distance increases with the number and closeness of the scratches. Not a single ray of this coloured light can ever enter the main beam of a lighthouse reflector, so that it is entirely lost. By standing in front of one of these reflectors, it will be seen, that these scratches are so numerous, that the surface has the appearance of being covered with the finest hair. If the surface had been regularly ground and polished upon pitch, like the specula of telescopes, no such effect would be produced ; but this cannot be done with parabolic reflectors.

3. *On the Imperfection of the Parabolic figure.*—The practical execution of a parabolic surface for optical purposes, has long been regarded as a very difficult operation, even when effected by the nicest machinery. Hence, the operation of forming a parabolic surface by a gauge and a hammer, directed solely by the eye of a workman, is not likely to be successful. Had such a surface been intended for that of a solid for ornamen-

tal purposes, where the eye alone is to be the judge, the operator's eye would be sufficiently accurate for directing such a process; but when we consider, that the object is to reflect divergent rays into a beam of light, which is required to preserve its parallelism and its density for 30 or 40 miles, we cannot but wonder that such inadequate means should have been so long employed to produce this effect.

Even if the light in the focus of the hammered reflector were a mathematical point, the most favourable of all suppositions, it would, after reflection, be thrown into divergent pencils a short way beyond the mouth of the reflector, and the resulting column would soon cease to preserve its density and its parallelism.

4. *On the Disadvantages arising from the size of the Argand-burner.*—As the argand-burner now in use cannot admit of diminution, it may seem strange that its magnitude should be ranked among the disadvantages of the present system. If a burner an inch in diameter were placed in the focus of a lens, or even in the focus of a large spherical mirror, it would not produce the same imperfections in the reflected column as it does in the focus of the hammered paraboloid. In a reflector 2 feet in diameter, the circumference of the wick is only $3\frac{1}{2}$ inches from the apex C of the curve; but as the glass-chimney which surrounds the flame is nearly 2 inches in diameter, and as the rays from the wick are refracted by the irregularities of this glass, we may safely assume that the virtual diameter of the mass of light, which is the source of illumination, is nearly 2 inches. Now, as the nearest point of the luminous body is only *three* inches from the apex C, while the most remote is *five* inches, it is manifest, that no parabolic curve can reflect such pencils into a parallel beam; nay, it is quite clear, that these two pencils must quit the reflector in a divergent state, and must, at no great distance, be thrown into the sea, or scattered upwards in the atmosphere.

This remark applies particularly to the back portion MCN, Fig. 6. Plate III. of the reflector, which includes a whole hemisphere of the rays which radiate from KL; and as all the rays included between LA and LB are not incident upon the reflector, its main effect must be produced by the action of the zone corresponding to the rays between MLA and LNB, which will render the column most luminous near its circumference, and least luminous along its axis.

The reader who has followed us in these observations, must have anticipated the conclusion, that a parabolic reflector shaped by the hammer, and furnished with an argand-burner, whose flame is only three or four inches from the back of the reflector, cannot possibly afford a parallel and dense beam of light, capable of penetrating space, and forcing its way through the haze even of an ordinary atmosphere. That this conclusion is well founded, may be readily proved by examining the distribution and intensity of the light in different sections of the reflected beam, taken at considerable distances. In one of the best reflectors which I have seen, I observed, even at the distance of *twenty* feet from it, a large dark spot on its surface. This opening, or space destitute of light, must have been so enormously great at the distance of five or six miles, as to diminish very considerably its penetrating power.

But, independent of the dispersion of the light by imperfect reflexion, and its deviation from the axis of the parallel beam, there is a great portion of the light lost by the use of hammered reflectors. The loss of light arises from two causes, namely, the absorption of the light by the metallic surface, and the loss of light by the collision of the rays at their points of intersection. All metallic surfaces, even when highly polished and perfectly smooth, absorb on an average *one-half* of the light which falls upon them; but while the hammered reflectors are peculiarly liable to that imperfection, the convergency of the pencils which they reflect, occasions a loss of light almost equally great. Cap-

tain KATER has shewn, that the intensity of a pencil of light, after its rays have crossed one another in a focus, is reduced nearly *one-half**; and though the cause of this is not fully ascertained, yet it is obvious, that a beam of light, composed of rays imperfectly reflected, crossing one another in every part of its section, must, from this cause, undergo a great diminution of intensity.

In addition to the disadvantages now explained, we may mention two others, which merit particular notice.

1. *The Parabolic Reflectors do not admit of any augmentation of the light in cases of emergency.*—In dark and hazy weather, when the mariner requires to be warned of his danger by the ringing of bells, it would be most desirable to double, or even quadruple, the intensity of the light. One reflector, however, cannot, in such cases, be made to augment the effect of another, and the introduction of a larger burner, in place of producing an increase of light, would actually occasion a diminution of it †. It will be seen, however, in the sequel of this paper, that the polyzoal lenses possess this advantage in a peculiar manner.

2. *The Parabolic Reflectors are peculiarly unfit for the production of distinguishing lights.*—In order to form a distinguishing light, by difference of colour, it is necessary to interpose a plate of red glass, *two feet* in diameter, in front of the reflector. This method is not only an expensive one, but it is very limited in its resources. In the case of a lens, a piece of glass a few inches square is sufficient, and from this cause we can avail ourselves of various coloured media, which could not be used in the present system.

* See EDINBURGH ENCYCLOPÆDIA, Art. OPTICS, vol. xv. p. 67.

† A burner with two concentric wicks should be immediately introduced into the lamps now in use.

In consequence of the weakness of the column of light, *Red* is the only colour which has been used for distinguishing lights; but when the column of light is rendered strong by an improved system of illumination, several other colours may be used with great effect, and the power of varying the lights may be thus widely extended.

The only advantage which parabolic reflectors possess, as a compensation for their numerous defects, is, that they receive a very large part of the sphere of light which radiates from the burner; but this advantage is more nominal than real, for we shall afterwards see that a smaller portion of the sphere well reflected, or well refracted, into a parallel beam, will produce a much more useful effect.

If any partiality for reflectors should still exist, they ought to be made much larger, and should be built up of separate zones and segments, like the polyzonal lenses*. The material should be speculum metal, ground and polished upon pitch. The central portion should be a spherical mirror of considerable radius, and the other zones might be ground with annular surfaces, so adjusted as to afford a parallel beam of light. As such reflectors, however, would still possess several of the inconveniences of the present system, we shall content ourselves with merely alluding to them, and shall proceed to the description of the New Lenses.

* That the reflectors for lighthouses are considered by competent judges to require improvement, appears from the following passages: "It is greatly to be desired," says the Editor of the *Bibliothèque Universelle* for July 1826, "that the perfection to which optical instruments have been brought, should be extended to that branch of the science which has for its object the illumination of lighthouses."

"From certain experiments now in progress," says Mr STEVENSON, "the writer is in expectation that considerable improvements may be introduced in the construction of reflectors; and that additional modes of distinguishing the lighthouses on the coast will be obtained."—*Account of the Bell Rock Lighthouse*, p. 527.

II. *On the Construction and Properties of the Polyzonal Lenses.*

As the construction and properties of common lenses are well known, I shall merely give a section of a common plano-convex lens, and of a double convex lens, made of one solid piece of glass, in order that they may be more readily compared with the new lens shewn in Plate IV.

- Fig. 1. Is the section of a plano-convex lens of solid glass.
- Fig. 2. Represents a section of one of the new plano-convex polyzonal lenses, in which the continuous surface is convex. It consists of a single lens in the centre, surrounded with five zones, each of which zones is composed of separate segments, as shewn in the plan, Fig. 7.
- Fig. 3. Represents a section of another plano-convex polyzonal lens, in which the continuous surface is plane.
- Fig. 4. Is the section of a double convex lens of solid glass.
- Fig. 5. Is the section of a double convex polyzonal lens.
- Fig. 6. Represents another form of the double convex polyzonal lens.
- Fig. 9. of Plate III. is a perspective view of a portion of the five zones of a Double Convex Polyzonal Lens.
- Fig. 7. Represents a plan of the polyzonal lens, *three feet* in diameter, in which the central lens is *fourteen* inches in diameter*.

In examining these figures, it will be seen, that the polyzonal lenses differ from the common lens, in having, as it were,

* A central lens of this size may be easily executed in flint-glass, free from any considerable imperfections, for the late M. FRAUNHOFER undertook to execute a flint lens for achromatic telescopes, *eighteen* inches in diameter; and M. GUINAND actually made one of that size.

Fig. 1.

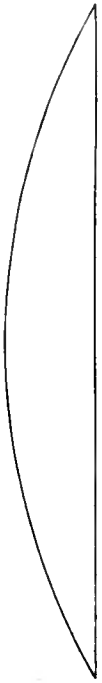

Fig. 2.

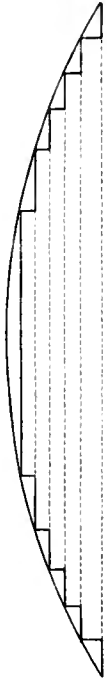

Fig. 3.

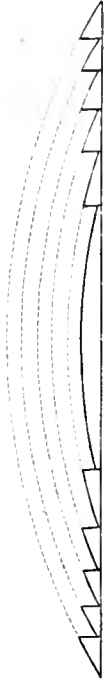

Fig. 4.



Fig. 5.



Fig. 6.



Fig. 7.

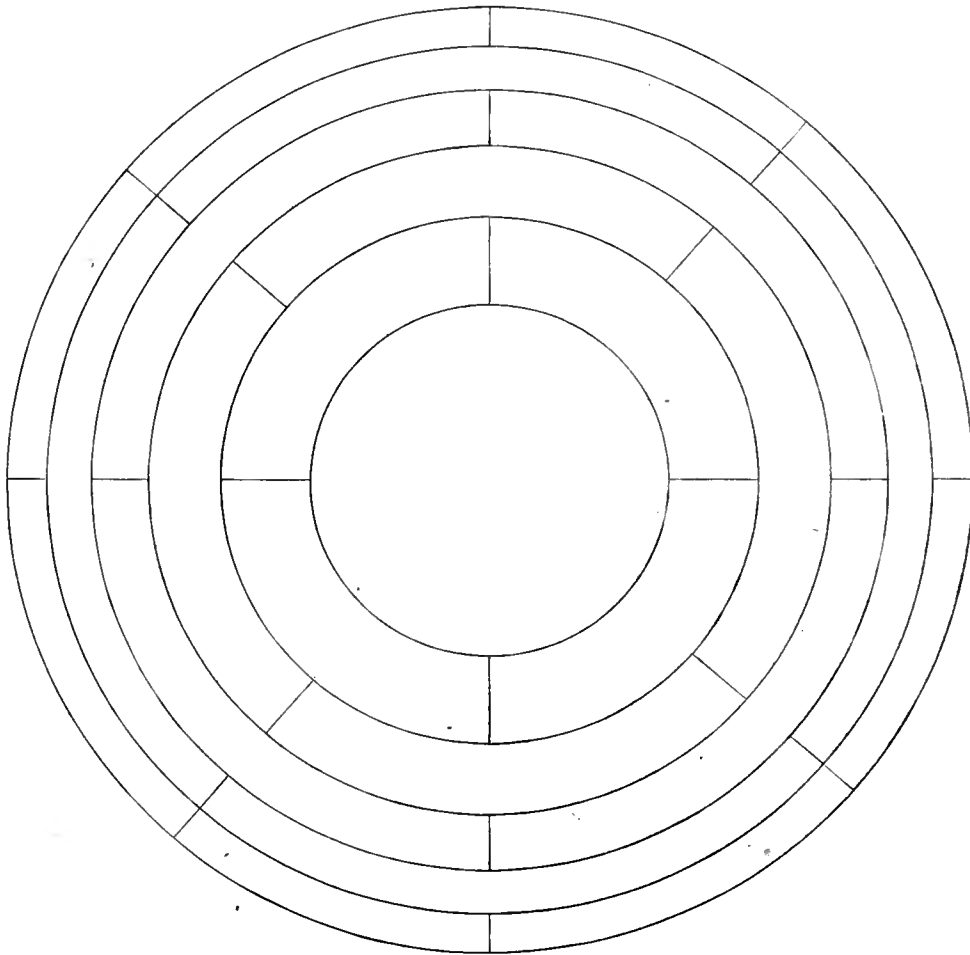



removed from them a great portion of the solid glass, and that, as the surfaces of the glass which is left, are parallel to the surfaces of the glass which is removed, the rays of light will suffer nearly the same refractions in the one lens as in the other. Let $ACBbmA$, Plate IV. Fig. 8., for example, be the section of a large solid lens, from which the great mass of glass $efgacbhikCe$ has been removed, the polyzonal lens which is left, will refract light nearly in the same manner as the solid lens, in consequence of the surfaces fg and acb being parallel to eCk . A ray of light FC falling on the solid lens at C will be refracted into the line Cn , and will emerge in the direction nR . In the polyzonal lens, the ray Fc will be refracted at c into a line cn , nearly parallel to Cn , and will consequently emerge at m , in a direction Rm , nearly parallel to nR . I have said nearly, because there is a slight difference between the refraction in the two cases, but this difference, as will afterwards be seen, is in favour of the polyzonal lens, which is actually a more perfect lens than the solid one. The following are the advantages of the new lenses, compared with those of the common form.

1. The polyzonal lenses are much more transparent than common ones made of the same glass. As the finest glass has a decided colour above certain thicknesses, and as the transparency of different masses is inversely proportional to their respective thicknesses, the polyzonal lenses must, from their very nature, have a superior transparency to common ones made of the same glass.

2. As it has been hitherto found impracticable to cast large lenses free of veins, flaws and impurities, which scatter and obstruct the refracted light, the formation of them, in separate zones and pieces, enables us not only to construct them of pure and homogeneous glass, but to make them of a size which has been hitherto deemed impracticable. When it is impossible to obtain 300 lb. of good homogeneous glass for a solid lens, it may

be quite easy to obtain 50 or 100 lb. for a polyzoal one. It is not, however, necessary that the lens be made of one kind of glass. Let us suppose that we have *six* different kinds of glass, with six different refractive powers, we have only to form the central lens of the least refractive glass, and the other zones of the other kinds of glass, so that the refractive power of the glass of any one zone is greater than that of the zone within it. Nay, it is not necessary even that each zone be made of the same kind of glass. If the glass of any segment has a different refractive power from the rest of it, we can make its focus coincident with the rest in three ways, 1. By a slight variation of its distance from the burner; 2. By a change in the curvature of its surface, or imperfectly by a slight variation from its proper position. It can seldom be necessary to have recourse to such expedients; and they are mentioned here chiefly to shew the number of resources which are within our reach.

If any segment, when finished, is imperfect, we may, without replacing it, remove the imperfection in the following manner: Let ABC, Plate III. Fig. 9., be a section of the segment, having an air-bubble, or other impurity, as *mn*, then we have only to cut out the portion *defg*, as shewn at A'B'C', taking care to make the surface *ef* concentric with AC, and to give the lines *ed, fg*, the same convergency as the rays which pass through that part of the segment.

3. The construction of lenses in separate zones, enables us to diminish the spherical aberration, which, as I shewed in 1811, may be done by various means. 1. Each zone may be made of different kinds of glass, so as to refract the rays which they receive to the same focus, the radius of curvature of each zone being the same. 2. Each zone, though made of the same glass, and having the same curvature, may be so placed relatively to each other, as to have one common focus. In Fig. 2. and 6. of Plate IV., for example, if the radiating point is on the left

hand side of the lenses, the aberration will be greatly less than it is in the solid lenses, Fig. 1. and Fig. 4. 3. When the zones are placed, as in Fig. 1. and Fig. 4., the aberration may be corrected by diminishing the curvature of the zones, as they recede from the central lens, or by varying the inclination of their surfaces to the axis of the lens, till the middle line of each zone is nearly in the surface of a hyperboloid. By any of these arrangements, it is easy to construct the lens, so that parallel rays shall be collected within a space not exceeding the magnitude of the flame from which the parallel beam of light is to be obtained, which is all that is required for the purposes of lighthouses. But, when the lens is to be used as a burning instrument, the accurate correction of the spherical aberration is, as Mr HERSCHEL has found, a matter of the first importance.

Having thus described a method of constructing lenses superior in transparency, in homogeneity of substance, in size, and in their action upon light to solid lenses, we shall now point out their superiority to hammered parabolic reflectors for the purposes of lighthouses.

Let AB, Plate III. Fig. 10., be a lens which forms a parallel beam of light AR, BR, by means of a lamp at L placed in its focus. By comparing Fig. 6. with Fig. 10., it will be seen that the reflector ACB, Fig. 6., throws into the parallel beam $A m B n$, all the light which radiates from L, excepting what is contained between LA and LB; whereas the lens AB, Fig. 10., throws into its parallel beam only what is contained between LA and LB. The loss of light, however, in the reflector is more than *one-half* of what falls upon it, while in the lens it is only about *one-tenth*. This circumstance alone compensates, to a certain extent, for the smaller portion of the sphere of rays which falls upon the lens; and it will be afterwards seen that we can actually avail ourselves of the rest of the sphere of light

in Fig. 10., in strengthening and widening the main beam AR , BR . But, though the reflector throws much light into the beam, it reflects it in a very imperfect manner, from the causes which we have already explained. In the lens, on the contrary, the light is refracted into the beam by a highly polished and regular surface; and when we consider, that, in a lens, *three feet* in diameter, the distance LC is *three feet*, while in the reflector, the distance LC is little more than *three inches*, we must see at once how peculiarly the lens is adapted to collect the cone of rays LAB into a dense and regular beam, capable of penetrating space, and forcing its way through the fogs and mists of the ocean.

From the nature of a parabolic reflector, we are prevented from using a very powerful lamp, and hence a common argand burner is the only light which has been hitherto used in Great Britain. The proximity of the focus to the back part of the mirror, renders it impracticable to increase the flame, without at the same time diminishing the parallelism and density of the reflected column. In the case of the lens, however, we may use the powerful lamp recommended by Count RUMFORD with 2, 3, 4, or even 5 and 6 concentric wicks; and we can thus throw a much greater quantity of light into the refracted beam, than we can possibly throw into the beam formed by reflection. In the present system of illumination, it is out of our power to increase the light in cases of emergency, when the lighthouse ceases to be visible at short distances; but, in the system of illumination by lenses, we may increase the light *tenfold* of what is necessary in a favourable state of the atmosphere.

In this comparison, we have supposed, that all the rays which flow from L , Fig. 10. are lost, excepting those between LA and LB ; but while we retain the lens AB , we can enlarge the cone of rays LAB , by placing a small lens between L and C , and we can increase its intensity, either by throwing back through L



a similar cone Lab , by a mirror ab , or by obtaining a converging cone of much greater size, by means of a contrivance which will afterwards be described.

IV. *On the Combination of Lenses with Plain and Spherical Mirrors, for Fixed and Revolving Lights.*

From the comparison which has now been made of lenses and parabolic reflectors, it appears that, when the lens is used singly, a very large proportion of the light of the flame is not rendered available. In revolving lights, where two or more lenses are combined, this light may be very advantageously employed; but in fixed lights, or in lights where only one lens is to be used, it requires to be combined with smaller lenses, and with plain and spherical mirrors, in order to enable us to throw into the parallel beam all or most of the rays which flow from the lamp.

The contrivance which occurred to me for this purpose, and which I published in 1812, has been recently adopted in the new system of illumination introduced into the French lighthouses. It is represented in section, in Plate V. Fig. 1., where F is the lamp or source of light, whose rays it is required to throw into one parallel beam. More than one-half of the sphere of light which radiates from this lamp, viz. $GCABDE$, is intercepted by lenses AB , AC , CG , BD , DE . The cone of rays incident upon the lens AB , which is larger, and has a greater focal length than the rest, fall diverging upon the large lens LL , and are refracted into a parallel beam of light $LRLR$!*. This beam of light is rendered more intense by the cone FMN , which, falling on the concave mirror $GMNF$, whose centre is F , is made to converge again to F , from which, diverging a second time, it

* By the interposition of the second lens AB , a much larger cone of rays is thrown into the main beam by the lens LL than could have been done without AB .

is refracted by the lenses AB and LL, and thus strengthens every part of the main column of light LRLR.

The cone of rays FAC, and FBD fall upon the lenses AC, and BD, and are refracted into parallel beams, which are thrown into horizontal directions $aRbR$, $fReR$, by the plane mirrors ab , ef . In like manner, the cones FCG, FDE are thrown into the parallel beams $cRdR$, $hRgR$. The cone of rays FGM being reflected back to F by the mirror GM, will pass through the lens BD, and strengthen the beam $fReR$, as if it had radiated from F, and in the same way, the cone FNE, reflected by NE, will add to the intensity of the beam $aRbR$. All the other mirrors and lenses not seen in the section, will, in like manner, refract and reflect the light which falls upon them into horizontal beams, so that the main column LRLR will be surrounded on all sides with a concentric cylinder of light. The beam might be still farther widened by another zone of lenses, and another set of mirrors, which would throw the cones FGM, FEN into a horizontal line, but it is decidedly preferable to throw that light into the beams $aRbR$, and $fReR$.

By the construction now described, we have obviously the power of throwing into one horizontal beam all the sphere of light which radiates from a luminous source, with the exception of what falls between the lenses, which cannot amount to two-tenths of the sphere. In parabolic reflectors only six-tenths of the sphere of light falls upon the reflecting surface, so that the combination of lenses and mirrors, has, in this respect, a remarkable superiority, arising from the luminous focus being actually enveloped by the refracting and reflecting surfaces.

The allowance of two-tenths of the whole sphere of light for what is lost between the lenses, is sufficiently large; but it may be reduced even to one-tenth, if, instead of making the lenses circular, we form them into a real zone, each lens, placed on the surface of the sphere, being comprehended between two parallels of longitude and two parallels of latitude. In this way the

first zone of lenses will be close to the circumference of the lens AB, Plate V. Fig. 1.; and the second zone of lenses will be close to the first zone, without any space whatever between them.

The preceding apparatus is intended to be a substitute for a single parabolic reflector; but when the light is to be seen in several directions, or is required to revolve, then two or more parabolic reflectors are united, back to back. Each of the reflectors thus united has necessarily a separate lamp; but if two or more lenses are used, the same lamp will serve for them all,—an advantage of no slight consideration.

The method of uniting two or more lenses will be understood from Plate IV. Fig. 2., which, if the number of large lenses is only two, will be a horizontal section of the apparatus; but if the large lenses are *four, six, or eight* in number, it will be a vertical section of the apparatus, room being left at D for admitting the lamp, and at C for the chimney. The parallel beam of light formed by the small lens AB, and the large one LL, is widened by means of the lenses AC, BD, and the mirrors *ab, ef*, while the opposite parallel beam, formed by the small lens GF, and the large one LL, is widened by means of the lenses CG, DF, and the mirrors *cd, gh*. In this manner, by increasing the number of large lenses, we may, by means of one powerful lamp at F, throw any number of parallel columns of light into a horizontal plane, and increase the width of these beams, by employing small lenses and mirrors to reflect horizontally the light that would otherwise be cast into the sea, or thrown up into the atmosphere.

IV. *On the Construction of Distinguishing Lights.*

“ The methods resorted to for distinguishing one light from another, on the coast, in cases where the distance and bearings by the compass may be so trifling as to render some method of distinguishing them necessary, till of late, was only effected by

shewing double and single stationary lights, exhibited from separate lighthouse towers. This description of lighthouse is sufficiently characteristic : it is, however, not only expensive, but, from the frequent repetition, such lights have at length become so general, as to be no longer a distinguishing guide to the mariner. The next idea which suggested itself, was the revolving light, exhibiting the alternate effect of light and darkness, by the periodical revolution of a *frame* or *chandelier* with reflectors, kept in motion by machinery. The revolving light has also been constructed as single and double ; and even treble revolving lights, as at the Casket Rocks, in the British Channel. But this mode, from the increasing number of lighthouses, it has also been found necessary to vary ; and revolving lights are now distinguished from each other by shades of glass stained of a red colour, which are interposed between the eye of the spectator and the reflector. Upon the first suggestion of this plan, it was expected that a great *range of colours* might be made use of ; but after many trials with glasses coloured red, green and blue, and also by means of coloured fluids, introduced between plates of *white glass*, it has been found that *red* shades only were calculated to answer the purpose effectually, of distinguishing and characterising *sea lights* *. To complete the lighting of the coasts of Great Britain and Ireland, however, many lighthouses must still be erected ; and the distinguishing of the new lighthouses from those already in use, becomes an object of the first consideration with persons engaged in these useful and important works."

* In his *Account of the Bell Rock Lighthouse*, p. 322., Mr STEVENSON adds, " that, after the most full and satisfactory trials, the red colour was found to be the only one applicable to this purpose. In tolerably clear weather, the light of one reflector tinged red was easily distinguishable, at the distance of *eight* or *nine* miles ; while the other colours rendered the light opaque, being hardly distinguishable to the naked eye at more than *two* or *three* miles."

This description of distinguishing lights, which we have taken from Mr STEVENSON'S excellent article on *Lighthouses*, in the *Edinburgh Encyclopædia*, indicates very distinctly the defects of the present methods, the great importance of resuming the subject, and the particular points which demand the attention of the scientific inquirer. In the construction of distinguishing lights, three methods may be adopted :

1. The first method consists in making one or more lights disappear and reappear in regular succession, by their revolution round a vertical axis.
2. The second consists in tinging the columns of light with the different colours of the spectrum.
3. And the third consists in the combination of these two methods.

If the lighting apparatus consists of two large lenses, of which Fig. 2. Plate V. is a section, and if it is made to revolve round a vertical axis thirty times in an hour, the brilliant column of light LRLR will be seen every minute, and it will be preceded and followed by the other columns which surround it. If the large lenses are four in number, the same effect will be produced by a rotation of fifteen times in the hour; or, by making the velocity of rotation the same as before, the disappearance and reappearance of the lights will follow each other with greater rapidity. If a zone of eight equal lenses is used, an eclipse and a brilliant light will be seen eight times during every revolution; and this may be varied, by making each alternate lens of inferior power, so that there will be a transition to total darkness by two different intensities of brilliancy.

In constructing a distinguishing light on this principle, I propose that the lenses shall have the form of a parallelogram, and shall be arranged so as to form the faces of an eight-sided

prism, as shewn in Plate VI. Fig. 1. (of which Fig. 2. is a section) where $ABB'A'$, $CD D'C'$, $EFF'E'$, $GH H'G'$, are the larger lenses, having the form shewn in Fig. 3. Plate II., and having equal segments on each side of the centre, cut off by vertical lines AA' , BB' , &c. The other lenses BC , DE , FG , and HA , have the same height, but less width, and consequently must be ground to a longer focal length than the others, in order to be placed on the faces of the same prism.

When the lamp L , Fig. 2., is placed in the centre of this octoedral prism, the whole zone of light which is contained between the upper and under edges of the prismatic faces, will be concentrated into eight parallel and horizontal columns of light, every alternate column having a different intensity. If the whole now revolves in *four* minutes, we shall have a bright flame from the large lenses recurring every minute, and a fainter one from the smaller lenses every minute, so that there will be a reappearance of the light every thirty seconds, and an eclipse every thirty seconds. By removing one or more of the lenses, variations in the character of the light may be introduced to a considerable extent.

The advantages of the preceding construction may be thus enumerated.

1. The whole zone of light which flows from the lamp between the terminal edges of the prism is rendered available.
2. The lenses may be much more easily, and accurately fitted up, in the form shewn at $ABB'A'$, Fig. 1. Plate VI. than if they had a circular or a square form, as the edges of the segments may be fitted into grooves in the vertical bars AA' , BB' , and easily adjusted.
3. Though, for a burning instrument the horizontal sides of a lens, which are cut off in Fig. 1., are as useful as

Fig. 2.

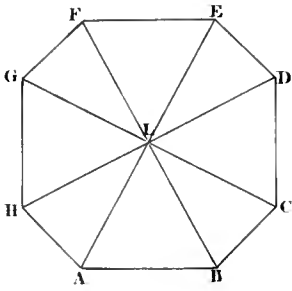

Fig. 1.

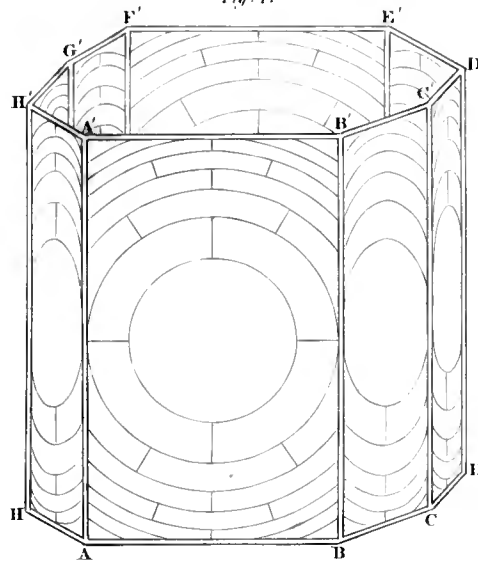

Fig. 6.

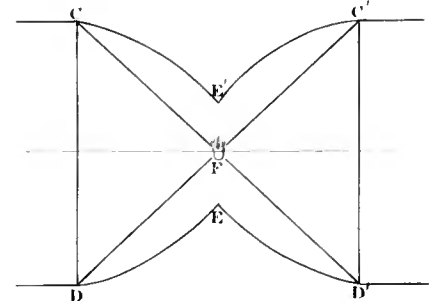

Fig. 4.

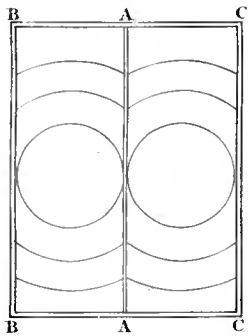

Fig. 5.

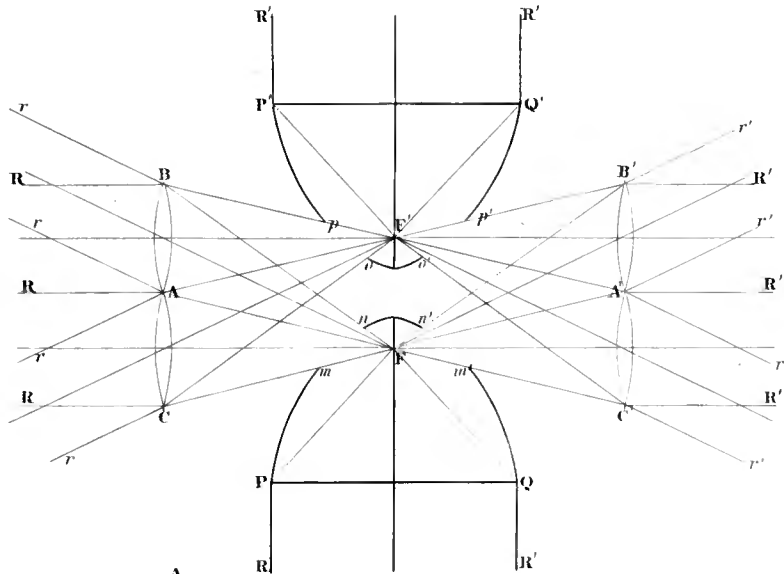

Fig. 8.

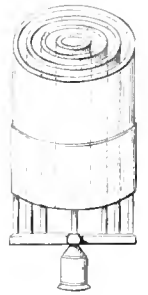

Fig. 7.

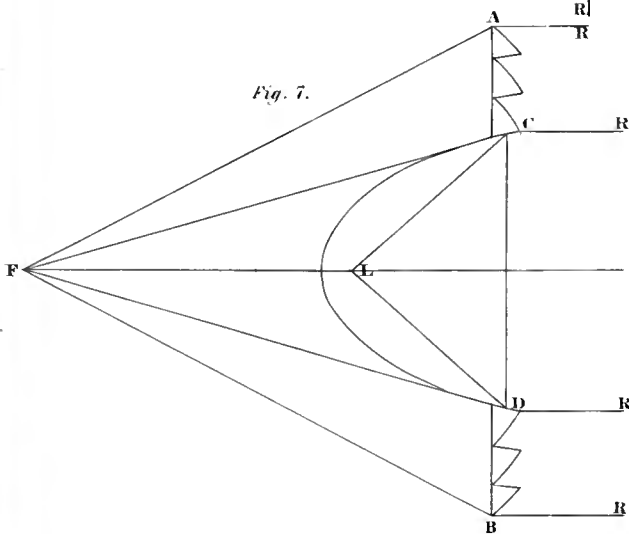
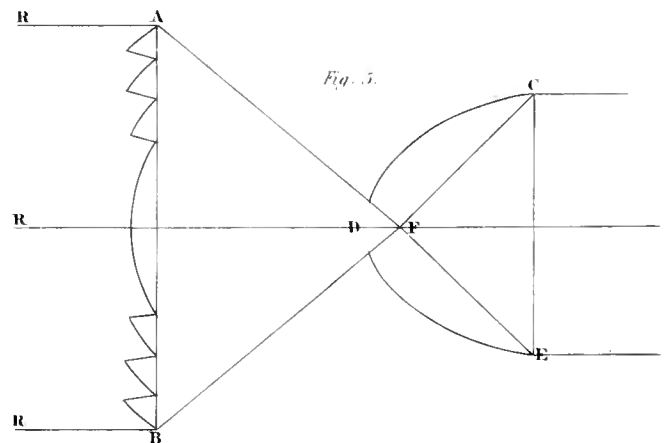

Fig. 5.





the vertical ones which remain, yet in lighthouses, they are of less use, as the width of the column, in a vertical plane, is necessary to embrace a wider extent of sea.

4. From the very mode of fitting up the lens $AB B'A'$, it is obvious that we can give it a much greater diameter in a vertical direction, and at less expence, than could be done while it has either a square or a circular form.

In lighthouses where it may be convenient to employ the reflectors, and Argand burners of the old system, the following arrangement of them with lenses will be found to constitute a cheap and effective apparatus for distinguishing lights. In Fig. 3. $AB, AC, A'B', A'C'$, are the sections of two truncated polyzonal lenses, the elevation of which is shewn in Fig. 4. Argand burners F, F' , are placed in the foci of the four lenses, and each of the two burners is surrounded with a parabolic reflector $P m n' Q, P' o p' Q'$, having openings $mn, m'n', op, o'p'$, sufficiently large to afford a passage for the cones of rays to the lenses $AB, AC; A'B', A'C'$. By this arrangement we shall have *eight* beams of light, namely *two* powerful columns $BRRC, B'R'R'C'$, produced by the lenses, *two* columns $PQRR, P'Q'R'R'$, produced by the reflectors, and *four* of much inferior intensity $ABrr, ACrr, A'B'r'r', A'C'r'r'$, produced by the oblique passage of the cones $F'AC, F'A'C', FA'B', FAB$, through the lenses. These last columns, will have a slight convergency, as the burners which produce them are placed a little without the principal focus of the lenses; but this evil may be remedied, by bringing the burners F, F' as near as possible, and placing the lenses $AB, AC, A'B', A'C'$, at an angle. The effect of this will be to divide the columns $BCRR, B'C'R'R'$, into four, so that we shall thus have ten columns of

light, and ten eclipses, during each revolution of the apparatus*.

2. In order to produce distinguishing lights, by altering the colour of the rays, it is necessary, under the present system, to cover the whole mouth of the reflector with a plate of coloured glass mn , Plate III. Fig. 6. two feet in diameter; and in the passage already quoted, we are informed by Mr STEVENSON, that no other colour but *red* has been found to answer. This colour, however, is the worst that can be employed, as it is the very colour which white light assumes in passing through a dry hazy atmosphere, or through a long tract of even clear air. Hence occasions will often occur, when such a colour will cease to be a distinctive mark of any individual lighthouse.

When it is admitted that *red* shades only have been found to answer the purpose of characterising sea-lights, it is a virtual admission of the total incompetency of the present system of illumination, for nothing can be more certain, than that other colours may be introduced as characteristic of sea-lights, provided the intensity of the illuminating columns is sufficiently strong to allow of that additional loss by absorption, which takes place in passing through various coloured media.

* In order to render available the reflectors of the old system, the following combinations may be adopted with advantage in many cases.

As the back part of the reflector is almost useless, an aperture two or three inches in diameter may be cut away at D , Fig. 5., so as to give free passage to the cone of rays FAB , which, falling upon the lens AB , will be reflected into a parallel beam $ARBR$.

Two reflectors $CDEE'$, $C'DEE'$ may be coupled together, as in Fig. 6., so that the lamp F may be exactly in the focus of each, and in this manner we shall have two beams of light in place of one.

Or we may give additional power to the reflector, as in Fig. 7. by using another lamp F , and surrounding the reflector with the external zones of a lens AB , in whose focus the lamp F is placed. The column of light $CDRR$, thrown out by the reflector, will be widened on all sides by a hollow cylinder of light, whose section is $ACRR$, $DBRR$.

The system of illumination by lenses, may therefore be considered as absolutely necessary to the proper construction of coloured distinguishing lights, in so far as this system will alone enable us to dispense with the use of red light, the very colour which the atmosphere itself can produce. But there is another most important consideration, which renders the lenticular system peculiarly adapted to coloured lights. While a large sheet of coloured glass is necessary for colouring the column reflected from a parabolic reflector, we may accomplish the same purpose in lenses, by means of a small plate of coloured glass three or four inches square, placed as close as can be conveniently done, to the illuminating flame, which will colour the whole column of light as effectually as if it had been of the same diameter as the lens. This facility of applying coloured media, will enable us to avail ourselves of natural and artificial substances, which could not possibly be procured in large plates*. Yellow orpiment, for example, or sulphate of copper, and various other substances, might be placed, in thin pieces, between two plates of glass, so as to form a square-coloured plate, sufficiently large to receive

* This advantage is strikingly pointed out by the following fact stated by Mr STEVENSON: "After having corresponded with all parts of the kingdom in endeavouring to procure red glass of the finest quality, by having it coloured in the furnace, it was mortifying to find, that its manufacture was wholly impracticable, *excepting in the production of small pieces not more than three or four square inches*, similar to those in the compartments of cathedral windows, which, in the process of shading a reflector, must have induced a number of minute divisions, and necessarily obstructed much of the light. The writer at length resolved on confining his attention to plates of crown-glass stained by repeated application of the litharge of gold, laid on after the manner of gum or paint, which was afterwards subjected to a strong heat in a muffled furnace of a peculiar construction, forming altogether a very nice and difficult process. * * * * * Although the effect produced in this way cannot be so perfect as if the glass were uniformly coloured in the pot, yet, when applied to the purposes of a distinguishing light, its effects are highly characteristic and beautiful."—*Account of the Bell Rock Lighthouse*, p. 392.

the cone of rays near the lamp, and colour the whole of the illuminating column.

3. The two methods of forming distinguishing lights, which have now been described, might in some cases be advantageously combined, so that in places where lighthouses are numerous, we may, at little additional expence, produce many well-marked variations in revolving lights.

In particular cases, where the lighthouses are exposed only on one side to the ocean, a motion of the apparatus through the arch of a circle is all that is necessary, and there are situations where a slight angular motion of the illuminating column in a vertical plane might be desirable.

V. *On the occasional exhibition of powerful Lights in Lighthouses.*

In the present system of illumination, no provision whatever has been made for the occasional exhibition of intense lights, when the atmosphere is so hazy and foggy as to absorb entirely, at moderate distances, all the rays which proceed from the reflectors. At the Bell-Rock Light-house, two large bells, each weighing twelve hundred weight, are tolled night and day during foggy weather, so as to warn the mariner of his approach to the rock. This contrivance is certainly better than none, though there are cases in which it may mislead the mariner to his ruin.

No fact in physics is better established, than the inability of the ear to judge of the direction of sound; and, indeed, the whole deception of the ventriloquist is founded upon this fact. In some conditions of the atmosphere, the sailor may err in his judgment of the direction of the sound several points of the compass, and he may thus be cast on the very rock which, under the guidance of other data, he might have avoided.

Admitting, however, as must be done, the absolute necessity of improvement in this point, it may be asked, How are strong lights to be procured? The answer to this is by no means difficult. In using reflectors, we cannot by any union of a number, enable them to penetrate a fog, for twenty Argand burners, placed separately, will disappear nearly at the same distance as one; but by the introduction of lenses, we can adopt various methods of obtaining *ten* times the light in hazy weather. Some of these methods have been already described; but another may be mentioned, which is suited only to short distances. In place of having only *one* large lamp in the focus of the lens, we may surround it with *five* or *six* of the same size. All of them, but one, will be out of the focus, and they will therefore form slightly diverging, and slightly converging, columns of light; but as the distance through which they are required to penetrate is necessarily small, they will all add powerfully to the intensity of the main beam, and cause it to penetrate through a considerable tract of hazy atmosphere*.

The circumstances of the case, however, seem to demand even a more powerful light than can be obtained from oil or gas. Many years ago, Sir WILLIAM HERSCHEL suggested the idea of using in lighthouses the powerful, and almost unsupportable, light developed during the deflagration of charcoal by galvanic action. The suggestion scarcely excited notice, from the enormous expence of maintaining such a light, and from the difficulty of applying it to reflectors; but though it would be extravagant and unnecessary to maintain such a light for common occasions, there would be no absurdity in its occasional exhibition, when all other means of illumination fail.

* If gas were used, we might, on such occasions, employ a burner ten inches in diameter, and having many concentric flames.

In the year 1820, I prepared a very *thin slice of chalk*, and having exposed it to the heat of the blowpipe, I found that it emitted a white and brilliant dazzling light, not much, if at all, inferior to that which arises from the deflagration of charcoal by the action of galvanism *. The idea afterwards occurred to Lieutenant DRUMMOND of obtaining this intense light from a ball of chalk a quarter of an inch in diameter, by directing upon it three alcohol flames, by means of a stream of oxygen. The light thus produced he found to be *eighty-three* times more intense than the brightest part of the flame of an Argand burner. Dr HOPE produced the same effect, by directing upon a ball of lime the flames of oxygen and hydrogen proceeding from separate vessels; and Dr TURNER has accomplished the same object by oxygen and compressed oil gas.

In certain lighthouses, therefore, we would strongly recommend such a light to be used, on great emergencies, when the risk of human life, and of valuable property, would authorise such an additional expenditure.

VI. *On the Introduction of Gas into Lighthouses.*

Ever since the introduction of gas-light, its application to the purposes of a lighthouse has been often suggested; but though the suggestion has been in some cases taken into consideration, it has been invariably rejected, and there is not a lighthouse under the superintendence of the English, the Scottish, or the Irish boards, in which gas has been used, or in which there is at present the slightest intention of using it †.

* See *Edinburgh Journal of Science*, No. X. p. 139.

† Since writing the above, I have learned that gas has been used in one or more lighthouses.

Although, therefore, I cannot claim the merit of first recommending its introduction, I am desirous of having the greater honour, of being the means of bringing it into general use, by placing before the public eye its numerous and palpable advantages.

There can be no doubt that oil-gas is preferable to coal-gas ; but the methods of manufacturing and purifying the latter have been brought to such perfection, that its cheapness far more than compensates its inferior illumination. I shall therefore suppose, that the gas to be used is made from cannel coal, purified by the most approved methods.

Mr STEVENSON informs us, that, about 1810, it was proposed to alter the lighthouse of Inchkeith, from an oil to a gas light : “ But upon inquiring into the state of the expence of the apparatus, and other circumstances connected with this plan, it was found that the adoption of the proposed alteration would not be an object in point of economy. The gas-light, in this instance, was disapproved of by the Scotch Board, chiefly from the apparent uncertainty which seemed to attend the regular and constant exhibition of those lights.” Whatever may have been the character of these objections in 1810, they have now no force, as the economy and regularity of gas-lights have been established by the experience of thousands. A single lighthouse-keeper is perfectly able, in the time that he would spend in cleaning his lamps, to manufacture the best coal-gas from cannel-coal, at the expence of less than *five shillings* for every 1000 cubic feet, whereas the same quantity of oil-gas is now sold from the pipe at *fifty* shillings, and compressed oil-gas at *eighty* shillings *. Economi-

* The economy in oil, in wicks and in lamps, must be very considerable, and, were it necessary, might be easily valued. In lighthouses which are near towns where gas is compressed, and to which it could be sent by sea-carriage, portable gas might be introduced with the most obvious advantage.

cal as coal-gas must necessarily be, it is not in this respect that I wish at present to consider it. It is to its power of producing a more intense light, and a more effective system of illumination, that I am anxious to direct the attention of the Society. The advantages arising from the use of this gas may be thus enumerated.

1. *By the use of Gas, we may in many situations dispense entirely with the use of Reflectors and of Lenses.*—It has been found by the French Commission, that the oil-lamp with four concentric wicks gives a light fully equal to 22 good Argand burners. I have constructed a gas-burner with four concentric flames, which I consider equal to that number of Argand burners; but if it should be inferior, we have only to add another flame to the four. In 1759, when the Eddystone Lighthouse came out of the hands of the celebrated SMEATON till the year 1803, and probably later, it was lighted with 24 large tallow candles, without any reflectors or concentrating apparatus. Now, it cannot be doubted that 22 Argand burners are fully equal to 24 large tallow candles; so that a single gas burner, with four or six concentric flames, is sufficient to produce the same light which was exhibited for 35 years at the Eddystone lighthouse, and which Mr STEVENSON informs us *, was seen at the flag-staff of the fort near Plymouth. If this single burner, however, should not be found sufficient, we have only to place beside it a second, a third, and even a fourth, and we may convert it into a distinguishing light by the revolution of coloured, opaque, and lenticular screens.

The expence of this flood of gas-light, emanating from four burners, with from *four* to *six* concentric flames, or from one burner with from 12 to 15, will, from the cheapness of coal-gas, be not much, if at all, greater than that of 24 tallow candles.

* *Edinburgh Encyclopædia*, Art. LIGHTHOUSE, Vol. XIII. p. 10.

2. *By the use of Gas, we may greatly improve the present system of Illumination by means of Reflectors.*—In all our lighthouses, an Argand burner with one wick is used, because an enlargement of its size would cause a great divergency of the reflected light, and consequently a greater diminution of its intensity, than there would be an increase from the augmentation of the flame. By the use of gas, however, we can introduce a burner with *two* or even *three* concentric flames, which will not occupy more space than a single Argand burner, and which will, therefore, greatly improve the present system of illumination.

3. *The use of Gas is peculiarly adapted to the new system of Illumination by means of Lenses.*—As the lenses employed in lighthouses will in general vary from two to three feet in diameter, the distance of the lamp will also vary from two to three feet, which allows us to use a flame from two to four inches in diameter. In oil lamps with concentric wicks, it is necessary to supply the flame with superabundant oil, by means of a piece of clock-work; and the lamp and machinery for this purpose cost £45. A gas burner, producing the same intensity of light, may be executed for £3 or £4, and has, besides, the great advantage of never going out of repair; whereas the French lamp would require to be under the superintendence of a person well acquainted with mechanism. Independent, therefore, of the great saving of expence, the substitution of a gas burner is peculiarly applicable in lighthouses, where the machinery is not only liable to go wrong, but where it cannot easily be repaired.

I have thus endeavoured to explain, as briefly as possible, the new system of illumination for lighthouses. Discouraging

as its first reception has been, it requires no prophetic spirit to anticipate its early and complete triumph. I am aware of the prejudices, and, I grieve to add, the sordid interests with which it must contend ; but these are not the days in which the tide of knowledge and improvement can be thus stemmed. The force of reason will gradually dispel the one, and before the frown of public opinion the other will disappear.

It is in Great Britain, if any where, that the lighting of her shores ought to be an object of national concern. Her naval and commercial pre-eminence, the sum of human life, and the amount of valuable property which are risked at sea, call loudly for every aid which science can confer. The ingenuity which has been already exhausted, the humanity which has been already roused, and the national liberality which has been already freely dispensed, in devising and promoting every scheme for saving the shipwrecked mariner, cannot now receive a nobler direction, than in rendering more effective those beacons of mercy which light the seafaring stranger to our coasts, and warn him of the wild shelves with which it is defended.

VI. *On the Parasitic Formation of Mineral Species, depending upon Gradual Changes, which take place in the Interior of Minerals, while their External Form remains the same.*
 By WILLIAM HAIDINGER, ESQ. F. R. S. EDIN.

(Read 19th March 1827.)

EVERY mineralogist is conversant with some of the facts relative to the subject of this paper. Some of the observations enumerated, are comparatively new, as the attention of naturalists has been only of late more particularly directed towards these facts. Others, which I have had an opportunity of collecting myself, I trust will not be considered uninteresting, as they tend materially to rectify certain ideas connected with the determination of the mineralogical species, the most important branch of natural-historical research.

The mutual attraction of the elements of mineral bodies, cannot at present enter into play on so extensive a scale, as during the period of the formation of those enormous masses of rocks, particularly those having a crystalline character, which form a great portion of our globe; for these bodies are the result of the very action of the elements on each other, by which they have arrived at a settled state. There are some agents, however, which we every day observe to affect, more or less considerably, the constitution of certain minerals, more prone than others to decomposition. Many species of the class of salts are continually destroyed by their solution in water, and regenerated by its evaporation. Iron-pyrites, exposed to the alternating influence of water, the oxygen of the atmosphere, and the changes of temperature produced in the natural course of the seasons, or by the

decomposition of the substances themselves, will effloresce, and yield sulphate of iron. Heat, and the disengagement of powerful acids, in the neighbourhood of active volcanoes, and burning coal-seams, give rise to the formation of a number of new substances, while those which existed before are destroyed. Usually even the last trace which could lead us to discover, from what source the new substances draw their origin is lost; but there are examples in which the form, peculiar to the crystals of the decomposed substances, is entirely preserved, while the rest of their properties undergo more or less notable changes. The consideration of these constitutes the especial object of this communication.

Mineral productions of the description alluded to, have been comprised by most authors under the idea of *pseudomorphoses*, a name expressive of their nature, if we attend only to the etymology of that word, since, indeed, the form is not the one belonging to the substance; but not agreeing with the definition given of them, which requires that they should be produced by the deposition of crystals in an empty mould, left in the surrounding mass, by a decomposed crystal of another species. The names proposed by HAÜY, *épigénies*, and by BREITHAÜPT, *metamorphous* crystals, are more objectionable than the usual denomination, if we regard etymology; and as they were neither circumscribed by accurate definitions, nor applied exclusively to this kind of formation of substances, we need not be over careful in making use of any of them, by preference, particularly since difficulties might arise from the circumstance, that the effect of the decomposition is not always the same, and that only some cases will be found, in which the entire form is preserved, while it is considerably impaired, though still recognizable in others, and frequently altogether lost. If we were to select a particular word for this kind of formation, the most appropriate expression would be *parasitic*, to denote the

intrusive nature of the new compounds, in prejudice of those which existed before.

The facts met with in nature, are at all events highly interesting, and deserve the particular attention of naturalists, who should have an opportunity of ascertaining the circumstances under which they take place; this may eventually complete the series in which they are here considered, beginning with the simplest case, when the substance formed has the same chemical composition as the one destroyed, and terminating in those where the composition of the two is so different, that even the analogies of the cases will not suffice for removing every doubt concerning their formation in the manner described. One remarkable result, however, we obtain by this comparison, that a new species is always produced, though its individuals be so small, that they are beyond the reach of natural-historical examination.

I. Changes in substances having the same composition.

The chemical mixture, essential to the common vitriol of zinc, is a dimorphous one, or one of those which are capable of crystallizing in two different kinds of forms, incompatible with each other. The most common of them is derived from a scalene four-sided pyramid, which has its three axes perpendicular to each other, and is comprised in the prismatic system. It is deposited from solutions not sufficiently concentrated to form a crystalline skin on their surface, and at temperatures below 126° Fahrenheit. Above that temperature, a highly concentrated liquid yields crystals of another species, whose forms are derived from a scalene four-sided pyramid, having its axis inclined on the base, and belonging to the hemi-prismatic system. The chemical composition of both

substances is expressed in the formula by BERZELIUS, of $Zn \ddot{S}^2 + 14 Aq$, which is derived from MITSCHERLICH's analysis of the prismatic species, giving oxide of zinc 27.67, sulphuric acid 27.57, and water 44.76.

To Professor MITSCHERLICH we are likewise indebted for the following curious fact*. When a crystal of the salt, with a form belonging to the prismatic system, is heated above a temperature of 126° , we may observe certain points at its surface become opaque, and then bunches of crystals shoot out from these points in the interior of the original specimen. Since this is transparent, and the newly formed crystals almost opaque, or of a milky whiteness, they are easily distinguished from the surrounding mass, while they continue to grow. In a short time, the whole is converted into an aggregate of those crystals, diverging from several centres, that are situated on the surface of the original crystal. No water escapes during this process, except what may have been accidentally included in the lamellæ of the specimen. This circumstance proves the identity of the chemical composition of the two species, one of which is formed within that space, which is occupied by the other up to the very moment of the decomposition of the latter, which gives rise to the new substance.

I have obtained crystals of the hemi-prismatic species, more transparent than usual, by exposing, on a warm stove, a highly concentrated solution of the salt, well covered and wrapt up, to crystallization. The remaining liquid having been decanted, the crystals obtained were dried and slowly cooled in the same manner. If they are taken out of the solution singly, and cooled rapidly, they soon lose their transparency, and, when broken, frequently present an aggregate of crystals of the prismatic species, which is likewise immediately produced by drops

* *Edinburgh Journal of Science*, vol. iv. p. 301.

of the solution remaining on the surface of the hemi-prismatic crystals. Change of temperature is the only agent upon which, in both cases, the change of the position of particles within the solid mass depends.

The isomorphism of zinc and magnium, is remarkably distinct in the regular forms, with all their peculiarities, and in the cleavage, of their sulphates. But it extends even to the phenomena, described above of sulphate of zinc. They both give exactly the same results.

The specific gravity of the hemi-prismatic species has not been ascertained. It is very probable that it does not materially differ from that of the prismatic species, as the change from one to the other takes place without producing a considerable change in the appearance of the shape of the crystals. When arragonite is exposed to heat, it becomes opaque, and splits violently into multitudes of small particles, previous to its giving off any of its carbonic acid. It is highly probable that it is thus transformed into common calcareous spar, which requires more space to exist in than arragonite, nearly in the ratio of 29 to 27, their contents of carbonate of lime being equal, and no attention given to the accidental and variable contents of carbonate of strontia. Perhaps the separation of the particles is assisted by the unequal expansion of the rhombohedral individuals in the direction of their axis, and perpendicular upon it.

I must mention here another example of the formation of crystals in the place of a solid mass, consisting of the same chemical ingredients, as a product of the power of crystallization, though the substance in which it occurs, is not comprised within the generally received idea of a mineral. M. BEUDANT, I believe, first called the attention of naturalists to the fact, that the whitish coat with which barley-sugar is covered, when it is kept for some time, shews a fibrous structure, the direction of the

fibres being perpendicular to the surface of the specimens. When the decomposition, which here only affects the form and arrangement of particles, is allowed to proceed farther, crystals of sugar-candy are formed in the space formerly occupied by a homogeneous mass which presented the most perfect conchoidal fracture, and not a trace of crystalline structure.

II. *Changes dependent upon the presence of Water.*

HAÜY'S *Chaux sulfatée épigène*, is a substance familiar to every mineralogist, as it is found in great quantities, and is to be met with in almost every collection. His view of it is perfectly correct: it was anhydrite, and is changed into gypsum, by combining with a portion of water. The original cleavage planes, still discoverable in the white, opake, and faintly glimmering masses, would give no argument of weight for uniting the two species into one; and yet considerations of this kind have induced some mineralogists to join blue copper and malachite into one species. These traces are not, however, produced by cleavage, which is the mere tendency of the particles of anhydrite to separate more easily in certain directions than in others; but they are owing to actual fissures in the direction of the planes of cleavage, visible in every fresh or not decomposed variety of the species. On these fissures, and still more distinctly on some larger irregular ones traversing the masses, distinct crystals of gypsum are formed. Of the latter, I have seen several specimens from Aussee in Stiria, in the collection of Gratz. The decomposed individuals are much smaller in these than in the varieties from Pesay in Savoy, described by HAÜY.

The absorption of water from the atmosphere, in saline substances, is usually attended with a solution of the latter in the water so attracted; that is to say, they *deliquesce*, and change

their form, in passing from one state of aggregation into another. The reverse also very frequently takes place. Crystals *effloresce* by losing their water, and are converted into a loose mass of a pulverulent consistency, which retains the original shape, but readily gives way to the pressure of the finger, and falls into powder. Prismatic glauber-salt, prismatic natron-salt and others, are familiar examples of this change. Many more might be quoted of the numerous cases of what chemists call *spontaneous decompositions*, depending upon loss of water, oxidation, &c. Among a great many facts of a similar nature, observed by Professor MITSCHERLICH, during my stay in Berlin in the winter of 1825, I shall mention here a very interesting one, in which a crystallized substance was formed within another, by the application of heat, and a loss of water thereby occasioned. He exposed crystals of hemi-prismatic vitriol-salt, the ordinary hydrous protosulphate of iron, immersed in alcohol, to a degree of temperature equal to the boiling point of that liquid. Decomposition ensued, though the external shape of the crystals remained unchanged. On being taken out of the liquid, and broken, each of them was found hollow, and presented a geode of bright crystals, deposited on the planes of the original ones. The crystals had the form of low eight-sided prisms, belonging to the prismatic system, and were proved by analysis to contain exactly half the quantity of water which is required in the mixture of the original species.

III. *Changes in Minerals containing Copper.*

Mineralogists are very generally acquainted with the crystals from Chessy in France, having the form of blue copper, but consisting of fibrous masses of malachite. Such varieties are found in that locality, as well as perfect homogeneous crystals; but

only extensive collections, or the large quantity gathered and preserved on the spot, both of which I had the good fortune to examine, will allow of observing perfect and continuous passages from one extreme to the other. The series begins with such crystals as not only possess the shape of the blue copper, but likewise consist of that substance, with the exception of small particles of the green fibrous malachite, which appear like something foreign, accidentally imbedded in the otherwise homogeneous mass. It terminates in such varieties as scarcely betray the original shape of the hemi-prismatic crystals, the last blue particles having disappeared, and the fibres grown out even beyond the original surface of them, and shewing disengaged crystalline terminations. The intermediate members distinctly possess the shape of crystals of the blue copper, nay, they have occasionally even particles of the original substance here and there distributed over their surface, which, to the last, preserve a parallel position. These particles are not displaced by an increase of bulk of the newly formed species. The chemical difference between the two species is not considerable. Several analyses published by KLAPROTH, VAUQUELIN and PHILLIPS, agree very nearly with the formulæ proposed by BERZELIUS, which are, $\text{Cu Aq}^2 + 2 \text{Cu C}^2$, for the blue copper, and $\text{Cu C} + \text{Aq}$ for the malachite. The proportions of the ingredients are,

		Blue Copper.	Malachite.
Oxide of Copper,	-	69·16	71·89
Carbonic Acid,	-	25·61	19·96
Water,	-	5·23	8·15

The change effected during the process of decomposition is the loss of a portion of carbonic acid, which is compensated by an additional quantity of water. If the formulæ above mentioned are resolved into their constituent parts, as given separately in the analysis, the blue copper is composed of three

atoms of oxide of copper, two of water, and four of carbonic acid, while malachite contains three atoms of each. One atom of carbonic acid is therefore exactly replaced by one of water.

HAÜY does not consider the crystals formed by aggregated masses of the green filamentous malachite as *épigénies* of the blue copper, as he unites the two species into one, and rejects the slight difference in the results of the chemical analysis as irrelevant. BEUDANT seems to be the first naturalist who viewed this process of decomposition in a proper light*.

Not only the blue copper, but also the imbedded octahedrons and dodecahedrons of octahedral copper-ore, are found in that locality in a state of incipient decomposition, resembling it in so far as the form of the crystals is not altered. There is one curious difference, however, in the progress of this decomposition. In the octahedral copper-ore, the surface first turns green by the absorption of oxygen and water, since the protoxide is converted into a hydrate of the peroxide, and then the decomposition penetrates deeper into the mass, whereby a more or less considerable coating of compact malachite is formed; whereas the reverse takes place in blue copper, the surface of the crystals being the last portion which is converted into malachite, since the decomposition begins from the point of support. There are crystals of an octahedral form, which consist, near the surface, of fibrous malachite, of the same kind as that which often constitutes the body of crystals, having the shape of blue copper; they generally contain a nucleus of octahedral copper-ore, not decomposed. A dodecahedral crystal of octahedral copper-ore, changed into blue copper on the surface, is preserved in Mr ALLAN'S cabinet; but such examples are rare.

The *cuiivre hydro-siliceux* of HAÜY, comprehending chrysocolla, is a species not yet well established, as the crystals

* *Traité de Minéralogie*, p. 158.

usually observed in collections are not in a determinable state. They are for the greater part converted into malachite, but their angles shew, that, in their original state, they have not been blue copper. I have seen crystals in Mr ALLAN'S cabinet, pretty distinctly pronounced, in the shape of compressed six-sided prisms, the narrow faces meeting at angles of about 112° ; and the narrow with the broad faces at angles of about 122° and 126° ; from which it appears that the original substance; as to form, belongs to the hemiprismatic or tetartoprismatic systems. There is an angle in HAÜY'S description of $122^\circ 19'$, situated like the one of 122° ; but the fundamental prism being supposed to be a right rhombic one, the other two angles of the derived six-sided prism follow to be $115^\circ 22'$, and $122^\circ 19'$. Besides, HAÜY gives a specific gravity of 2.733 to his crystals, while the varieties of chrysocolla never go beyond 2.2. I know only of one specimen, with crystals apparently homogeneous, and resembling chrysocolla, engaged in a pale-brown clayey substance. It forms part of the magnificent collection of Mr BERGEMANN of Berlin, who intended to subject it to a chemical analysis, while Professor GUSTAVUS ROSE was to examine its mineralogical, and particularly its crystallographic characters. We have therefore to look to the ability and zeal of the Berlin mineralogists and chemists, for more accurate information regarding this remarkable substance.

The blue copper, ground to an impalpable powder, is employed as a blue paint, of a very bright tint, paler than the mineral itself. It is not, however, highly valued, because it is apt to lose its original colour, and to turn green. This is mentioned by HAÜY, who quotes authorities as old as WALLERIUS and BOETIUS DE BOOT, for the colour obtained from the Armenian stone of the ancients*. The decomposition of the blue pigment is a

* *Traité*, 2^{de} edit. t. iii. p. 503.

case exactly similar to that of the blue crystals, as presented by the specimens found in mines.

Copper, in its pure metallic state, when exposed to the action of the atmosphere, variously combines with the elements contained in that fluid. I have seen remains of Egyptian vessels, in the possession of Major STEUART of the Hon. E. I. C. service, which had formerly consisted of copper or bronze, and still presented the exact outline of their original shape, with a pretty smooth surface. Some of the fragments were nearly one-fourth of an inch thick, but so complete was their disintegration, that they could be easily broken across with the hands, presenting on their fracture a compound mass full of small drusy cavities. In these the octahedral crystals of the copper-ore, of which the whole mass consisted, were distinctly visible. The curved surface of most of the vessels was covered with atacamite, sometimes crystallised, particularly on the concave sides. There were some white patches also, which I did not then examine. During his residence in the Ionian Isles, Dr JOHN DAVY* paid much attention to similar changes, which have taken place in antique Greek armour and coins. He found that the substances forming green, red and white spots on the surface of these articles, which consisted of alloys of copper and tin, were carbonate and submuriate of copper, octahedrons of protoxide of copper, and of pure metallic copper, and oxide of tin. In several instances, there was no metallic copper formed, and the protoxide was blackened by an admixture of peroxide. Since it cannot be supposed that the substances formed on the surface of these bronze articles, were deposited from any solution, Dr DAVY infers, that an internal movement of the particles must have taken place, caused by the influence of electro-chemical powers. Dr DAVY's opinion, that such considerations will explain many phenomena, occurring in

* *Philosophical Transactions* for 1826, p. 55.

the mineral kingdom, is shewn to be perfectly correct, by the facts collected in this paper. In the native copper, I never could observe any such changes, though I have examined a great number of specimens with the view of discovering them; probably we have to attribute to the admixture of tin, and the electro-chemical action dependent upon the contact of the two metals, the greater disposition of bronze, to form new compounds with the elements contained in the atmosphere, and in water.

There are several species into the composition of which sulphuret of copper enters as one of the most important ingredients, such as the prismatic copper-glance, or vitreous copper, and the octahedral and pyramidal copper-pyrites, or the variegated copper and copper-pyrites. All of them are more or less subject to successive changes in their chemical constitution, while the form in some cases remains, and in others is entirely lost. Mr ALLAN is in possession of a very interesting and numerous series of copper ores, which he collected chiefly in the summer of 1824, on a journey in Cornwall, in which I had the pleasure of accompanying him. This series has given me an opportunity of noticing several peculiarities, which had not been mentioned before by mineralogists.

Dark-grey crystals of copper-glance, with a bright metallic lustre, are often deposited on low six-sided prisms, which have a tarnished surface. These, in respect to form, entirely agree with the crystals of the other species; their surface, however, is never perfectly smooth, and on breaking them, they do not present throughout a uniform appearance. Generally the portions nearest the surface consist of the reddish metallic substance of variegated copper, having an uneven fracture, while the rest possess the grey colour, and perfect conchoidal fracture of the copper-glance. Often, and particularly in thin plates, the whole shews the appearance of variegated copper, whereas in large crystals, the two species are more or less irregularly mixed up with each

other. These prisms are sometimes more than an inch in diameter, but are usually smaller. The copper-glance, which originally occupied the regularly limited space, has been succeeded by variegated copper. The arrangement of the portions of both species in successive coats, shews that the decomposition has proceeded from the surface.

On breaking some of the six-sided prisms here alluded to, I found a stratum of copper-pyrites, of its usual bright yellow colour, contiguous to their surface, while the rest consisted of variegated copper. The original form had here still been preserved; but a new change in the chemical constitution had converted the variegated copper into copper-pyrites. The peculiar twin-crystals, discernible in groups of six-sided plates, crossing each other at nearly right angles, and the distinct form of the six-sided plates themselves, leave no doubt that two of Mr ALLAN'S specimens, consisting entirely of copper-pyrites, owe their origin to the decomposition of copper-glance. One of them is covered with a black pulverulent oxide; but the surface of the other is perfectly bright, and of a fine brass-yellow colour. It presents to the observer the deceitful and puzzling appearance of copper-pyrites crystallized in nearly regular six-sided plates. No cleavage can be traced; but this being not easily obtained in any of the species, it cannot form, in the present instance, a sufficient distinctive character between the simple and compound minerals.

The variegated copper itself occurs in distinct crystals, mostly small, which are hexahedrons. Some larger ones, but with curved and irregularly formed faces, occur in regular compositions, similar to those of fluor, twins being produced by two individuals, which may be supposed in transverse position to each other, in reference to one of the rhombohedral axes of the hexahedron. Each of these groupes contains in its interior a six-sided prism, whose smooth surfaces may be relieved from the surrounding homoge-

neous mass, merely by breaking off the latter. The position of this prism is such, that its planes, within the angles different from 120° , agree in position with the prism $R + \infty$, which is the limit of the series of rhombohedrons, the hexahedron shewing here the properties of this form in regard to the principal axis of the enveloping twin-crystals of variegated copper. There is a face of the hexahedron contiguous to every lateral face of the six-sided prisms; nay, it is possible that the existence of the twins depends upon that of the prisms, which might exercise a considerable influence in the deposition of the particles of the species of variegated copper. The substance of the prisms themselves is likewise variegated copper; they are divided into thin laminæ parallel to the base of the prisms, having externally a black colour, and scarce any lustre, but presenting the usual appearance of variegated copper, when broken across.

The original form is generally lost, when the decomposition proceeds farther. In this case, what is usually called black copper will remain, a more or less pure peroxide of copper, in pulverulent masses. A specimen in the collection in Gratz, from the Bannat, with crystals of the form of copper-glance, changed into this substance, is the only one I remember ever to have met with, in which the change has proceeded so far, without at the same time altering the form. It is probable that it has taken place immediately, and not proceeded through the stages of variegated copper, and copper-pyrites, though both of them, when decomposed, will likewise yield a black powdery residue.

The prismatic copper-glance is a pure sulphuret of copper, whose composition is expressed in BERZELIUS's chemical formula $Cu S$, the two ingredients copper and sulphur being in the ratio of 79.73 and 20.27. Most analyses give a slight quantity of iron.

According to the analysis by Mr RICHARD PHILLIPS, of a

specimen of variegated copper from Ireland, this species is composed of one atom of protosulphuret of iron, and four atoms of sulphuret of copper, or $\text{Fe S}^2 + 4 \text{Cu S}$. The three ingredients, copper, iron, and sulphur, are in the ratio of 62.67, 13.44, and 23.89.

The composition of copper-pyrites, from the analysis of Professor HENRY ROSE, might be considered as being essentially one atom of protosulphuret of iron, and one atom of a sulphuret of copper, containing twice as much sulphur as the native sulphuret, which forms the species of prismatic copper-glance. Professor ROSE is of opinion, however, that the copper contained in the mineral is in combination only with one atom of sulphur, as in other species, and that the whole mixture should be considered as a compound of one atom of protosulphuret of iron, one of persulphuret of iron, and two of the sulphuret of copper. The chemical formula is $\text{Fe S}^2 + \text{Fe S}^4 + 2 \text{Cu S}$, and the ratio among the ingredients, copper, iron and sulphur, is 34.80, 29.83, and 35.37.

The changes, therefore, can be explained, upon the supposition that the copper contained in the original species has been replaced by iron, in a smaller quantity, however, as every particle of iron required twice the quantity of sulphur to be converted into protosulphuret, in the variegated copper, and four times the quantity for that portion of it in the copper-pyrites, which is in the state of persulphuret. The compound of protosulphuret and persulphuret of iron, which, in the last species, is joined to the sulphuret of copper, is one of those forming the chemical constitution of magnetic pyrites.

When the sulphur is entirely driven off, and the copper attracts so much oxygen as to be converted into the peroxide, black copper remains. During this process, also, some of the carbonate is frequently formed.

IV. *Changes in Minerals containing Iron.*

Through the exertions of the late travellers in Brazil, we have become acquainted with octahedral crystals, often of considerable magnitude, of a particular ore of iron. They afford a red streak, and should seem, therefore, together with other instances of the same kind that had been observed, to form a contradiction to the character given for the species of octahedral iron-ore in the Characteristic of MOHS *, namely, that it should have a black streak. On a more close inspection, however, the octahedral masses are found to be composed of a great number of small crystals, resembling those of the rhombohedral iron-ore, a species, one of whose characters is in fact the red streak observed. A specimen from Siberia, given to Mr ALLAN by Sir ALEXANDER CRICHTON, presents the same change, excepting that in this specimen the individuals of the rhombohedral iron-ore are so minute, that they form a compact mass, contained within smooth planes, having the situation of the faces of a regular octahedron. As in the decomposed anhydrite, these planes are not the remains of cleavage, but they existed in the octahedral iron-ore previous to its decomposition, as fissures parallel to its octahedral cleavage. The chemical change necessary for transforming the mixture of octahedral iron-ore into that of rhombohedral iron-ore, is a very slight one, the former being a compound of one atom of protoxide and two of peroxide of iron, expressed by BERZELIUS'S formula $\ddot{\text{F}}\text{e} + 2 \ddot{\text{F}}\text{e}$, while the latter is the pure peroxide, or $\ddot{\text{F}}\text{e}$. The relative contents of oxygen are 28.215 and 30.66 per cent. There is a group of crystals from Vesuvius in Mr ALLAN'S cabinet, elucidating, by their

* *Treatise on Mineralogy*, Transl. vol. i. p. 439.

coarser texture, the explanation given of the Brazilian octahedrons. The rough form of an octahedron is produced by very distinct flat crystals, united in various positions, of the rhombohedral species, the face perpendicular to the axis of the fundamental rhombohedrons being much enlarged. Some of them have their broad faces in the direction of the faces of the octahedron ; and in some of the octahedral groupings, this circumstance has produced a kind of raised reticulated appearance on the adjoining faces of the original octahedron, which the newly formed crystals intersect, and project beyond them.

The changes which affect the brachytypous parachrose-baryte, or sparry iron, deserve our particular notice, as they are not only highly interesting in themselves, but have been well attended to at all those places where this species forms the predominant ore of iron. The characteristic chemical ingredient of it is the carbonate of iron, Fe C^2 , in which the protoxide of iron and the carbonic acid are in the ratio of 61.47 and 38.53. It contains occasionally an admixture of the carbonates of lime, magnesia and manganese. The colour of the original varieties is usually a pale yellow, inclining to grey : the lustre and transparency are considerable. When left exposed to the action of the atmosphere, the surface soon assumes a brown tint, which by degrees penetrates deeper into the substance of the crystals. Some lustre even then remains, and cleavage is still observable. Specimens bounded by fissures on all sides, or broken out of a solid mass, when examined in this stage of their decomposition, often still contain a nucleus of the yellowish-grey undecomposed substance. When the decomposition has arrived at its end, every trace of cleavage has disappeared, the fracture of perfectly well pronounced crystalline shapes is uneven, or earthy, and the colour a dark brown, which is likewise visible in its streak. The substance now consists of a compact variety of the hydrate of peroxide of iron, whose chemical composition is expressed in the

formula $2 \text{Fe} + 3 \text{Aq}$, and which contains 14.7 per cent of water. One atom of the carbon contained in the original compound will therefore go away in the state of carbonic acid, while the other must be transformed into oxide of carbon, in order to convert the protoxide of iron into a peroxide. The change in those masses has taken place so insensibly, that the action of the power of crystallization was prevented, and the interior presents a pretty uniform texture; but, at the same time, some particles of the hydrate of iron commonly also follow their own innate attraction, and form geodes of brown hematite, that is, of prismatic iron-ore. Hüttenberg in Carinthia has perhaps no equal in illustrating the exactness of this explanation, for the distinctness of the specimens which it affords. The geodes occurring at that place, of various sizes, are very frequently adorned with crystals of arragonite, of calcareous spar, of prismatic manganese-ore, or with the silvery flakes of another manganesian mineral, whose exact chemical composition has not yet been ascertained. With the decomposition of the sparry iron is also intimately connected the formation of those beautiful coralloidal varieties of arragonite known by the name of *flos ferri*, which are found in caverns near the surface of the rocks, as at Eisenerz in Stiria.

The ankerite, or paratomous lime-haloide of MOHS, is also apt to be decomposed in a similar manner. But as it is a compound of the carbonates of lime and iron, in which the former amounts to more than half the weight, only what might be termed a skeleton of the hydrate of iron remains, while the rest of the ingredients disappear by the action of chemical agents. The texture of the remaining mass is much less compact than that of the residue left by the decomposition of the sparry iron.

The product of the decomposition of the two species last mentioned, is exactly the same as the substance which remains, when iron-pyrites suffers a decomposition, without changing its form. Both species, the hexahedral and the prismatic iron-py-

rites, having the same mixture, are also subject to the same change: the sulphur goes away, and the iron takes up oxygen and water; the decomposition proceeds from the surface. We often see crystals covered on the surface with a brown tarnish, and this is the first stage of the change. There are specimens with a thin coat of the hydrate of iron; there are others consisting almost entirely of the latter, with only a nucleus left of the original bisulphuret of iron. Such are found at Wochein in Carniola, where this hydrate of peroxide of iron, produced from the decomposition of the bisulphuret, occurs in such abundance and pureness, that it is melted as a very valuable ore of iron. The iron extracted from it is particularly remarkable for its softness.

V. *Changes in Minerals containing Lead.*

The mineral called *Native Minium* is probably, in every instance in which it has yet been observed, the product of decomposition of some other substance containing lead. Such is the variety which M. BERGEMANN of Berlin found in the lead mines of Kall, in the Eifel in Germany, where the ore, chiefly the sulphuret and carbonate of lead, is dug out in irregular masses, from the loose earth, to the inconsiderable depth of a few fathoms. To him I have been indebted for several distinct crystals, possessing the regular forms of the di-prismatic lead-baryte, not only in regard to the simple prisms and pyramids of which the combinations consist, and the striæ on the surface of some of them, but also in regard to the identical mode of being joined in twin-crystals. The beautiful red colour, which, in these compact masses, much more nearly approaches the colour of vermilion, than in the best varieties of the usual minium in the state of powder, and the apparent homogeneity of the mass in the

conchoidal fracture, together with the external crystalline appearance of it, at first rendered it extremely probable that this was actually a species of original formation; a supposition which proved to be erroneous, on the substance being more accurately examined. In the present case, it is carbonate of lead, or $\text{Pb } \overset{\cdot\cdot}{\text{C}}^2$, according to BERZELIUS's formula, corresponding to 83.52 oxide of lead, and 16.48 carbonic acid, which is changed into the red oxide of lead, or $\overset{\cdot\cdot}{\text{Pb}}$, containing 10.38 per cent. of oxygen. In order to explain this change, we must suppose, that of the two atoms of carbon contained in the original compound, one goes away in the state of carbonic acid, and the other in that of oxide of carbon, one of the atoms of oxygen being employed to convert the yellow oxide contained in the carbonate of lead into red oxide. The best artificial minium is obtained by a change exactly analogous to what we find in nature. Carbonate of lead, in the state of an impalpable powder, is exposed to heat, care being taken to stir it continually, in order to renew the surface exposed to the air. If crystals of the di-prismatic lead-baryte be heated in a glass tube, the first application of heat changes them into a red mass, which, however, at a higher temperature, loses an additional portion of oxygen, and becomes yellow on cooling. It then contains lead 92.83, and oxygen 7.17, and is $\overset{\cdot\cdot}{\text{Pb}}$, or protoxide of lead.

The hexahedral lead-glance, consisting of one atom of lead and two of sulphur, $\text{Pb } \text{S}^2$, in the proportions of 86.55 and 13.45, is very liable to decomposition by means of the natural agents. There are examples of compact varieties of prismatic lead-baryte formed by its decomposition, and still presenting the traces of fissures parallel to the hexahedral cleavage planes of the original species. The prismatic lead-baryte consists entirely of sulphate of lead ($\overset{\cdot\cdot}{\text{Pb}} \overset{\cdot\cdot}{\text{S}}^2$), in which the two ingredients, lead and sulphur, are in the same ratio as in the lead-glance: the two species are chemically distinguished from each other only by the presence

of the oxygen in the sulphate. The form of the hexahedral lead-glance, however, is not always recognizable in the products of its decomposition, though there can be no doubt, that, in many cases, the numerous crystalline species of the genus lead-baryte are formed in this way in the veins. Those who might be still inclined to doubt, should visit the repositories of these species at Lead-hills, a place conspicuous in the annals of the mineral collector for the beauty of the specimens with which his cabinet is adorned. They occur there in a vein in greywacke, filled with a clayey mass, in which nodules of the minerals containing the lead are imbedded. On their outside, they are almost uniformly covered with crystals of the carbonate, more rarely of the phosphate, of lead. In the drusy cavities which they include, are deposited the rarer species of the sulphato-carbonate, the sulphato-tri-carbonate, the cupreous sulphate, and the cupreous sulphato-carbonate, and likewise the phosphates and sulphates of lead. These cavities also are frequently lined with fine crystals of the carbonate itself. A piece of the sulphuret, with bright cleavage planes, is often discovered, engaged among all these species, whose formation so much depends upon its previous existence. In such cases, we find the sulphuret corroded and rounded, presenting a surface nearly similar to that of hexahedral rock-salt, or gypsum that have been exposed to the dripping of water. The space between it and the external coating is often filled with water, when the nodules are found in the mine. Mr BAIRD, then surgeon at Lead-hills, gave a pretty complete account of the changes by which the oxidized species are formed from the sulphuret*.

Miners pretty generally have an opinion, that the contents of metallic veins are not always the same, and that they are often working such as are not yet *ripe*, or would have been more productive, if attacked at a later period. This opinion is founded

* *Memoirs of the Wernerian Natural History Society*, vol. iv. p. 508.

chiefly on a belief, that blende is changed into lead-glance. We are not entitled by observation to admit of such a change; and though in this manner it does not appear that we can come too soon with our mining operations, we see plainly that at least, as at Lead-hills, we may come too late; for that vein which now contains the carbonates, and sulphates, and phosphates, must have been once replete with the much more valuable sulphuret of lead. Evidently, also, those among the Freiberg veins have been opened too late, which now are found to contain the large six-sided prisms of iron-pyrites, produced by the decomposition of that valuable ore, the brittle silver, or prismatic melane-glance of MOHS; this, at least, is the only species to which we can attribute the shape of those prisms, although they themselves remain in some measure problematical.

The changes are not at an end, even with the complete destruction of the sulphuret. I must in particular mention three cases, all of them in specimens from Lead-hills, in the cabinet of Mr ALLAN, in support of this observation. One of them has distinctly the form of large, perfectly recognizable crystals, with a rough surface, however, of the prismatic lead-baryte. The whole of the substance of the crystals is a granular tissue of minute crystals of the di-prismatic lead-baryte. The sulphate, Pb S^2 , containing 73.56 per cent. oxide of lead, has been here converted into carbonate, Pb C^2 , which contains 83.52 per cent. of the same ingredient. The form in the second case is that of the low six-sided prisms of the axotomous lead-baryte, with pretty smooth surfaces. Its substance is an aggregated mass of crystals, likewise of the di-prismatic lead-baryte, but presenting in their distribution much resemblance to the mode in which the individuals of malachite are arranged, which replace the crystals of the blue copper. The sulphato-tri-carbonate has here given way to the carbonate of lead. The third specimen, like the preceding one, has the form of the

axotomous lead-baryte ; but, beside white crystals of the di-prismatic, also yellow ones of the rhombohedral lead-baryte are found to occupy the space originally taken up by the axotomous lead-baryte. Here the carbonate and the phosphate have replaced the sulphato-tri-carbonate of lead.

A very interesting change of the sulphuret of lead into a granular mixture of carbonate and phosphate, was mentioned to me by M. VON WEISSENBACH of Freyberg, who had first observed it, and who likewise shewed me the specimens he had collected on the spot, at the mine called *Unverhofft Glück an der Achte*, near Schwarzenberg in Saxony. The original forms of the lead-glance, regular octahedrons, were still distinctly visible ; but they consisted of a tissue of white and green crystals of the di-prismatic and rhombohedral lead-baryte. There was a black friable residue left, which was considered as friable lead-glance. Such a substance is often left on the surface of decomposing lead-glance, where, even in the portions that yield to the pressure of the nail, and soil the fingers, some traces of cleavage continue. Very good examples of it occur at Mies in Bohemia, along with the well known large crystals of carbonate of lead. SELB also observed black di-prismatic lead-baryte in the shape of cubes, originating from, and containing particles of, lead-glance, from the Michael mine in the territory of Geroldsegg in Swabia*.

The changes described above are not of a rare occurrence in the various mining districts, not only in such where the works are carrying on in actual veins, but also in those which are situated in metalliferous beds. It has been very generally observed, that such mineral repositories yield crystals chiefly in their upper levels, and that they are found more compact when the works are carried to a greater depth. They follow in gene-

*. LEONHARD'S *Handbuch der Oryktognosie*, 2d edit. p. 293.

ral from the oxidation of the original substance. I have seen only one example of the contrary, which was shewn to me by Professor HAUSMANN, in the museum at Goettingen. Impressions, of a hexahedral form, produced by lead-glance, contained a residue, of a very loose texture, of native sulphur. This specimen was found in Siberia.

The mineral usually designated by the name of *Blue Lead*, is in some respects the converse of the changes considered above. Its forms are those of the rhombohedral lead-baryte, namely, regular six-sided prisms. The compound of phosphate of lead and chloride of lead, of which their substance originally consisted, has given way to the sulphuret, which usually appears in granular compositions, filling the crystals. The first varieties that were noticed by mineralogists, were those from Tschopau in Saxony. I remember having seen specimens of it, entirely consisting of compact galena, but I have not had an opportunity of comparing any again, after having examined some of the other varieties of the same substance. At Huelgoet in Brittany, six-sided and twelve-sided prisms are found, often upwards of an inch in length, and nearly half an inch in thickness, which consist of a coarse-grained compound variety of lead-glance, the component individuals being so large that it is very easy to ascertain their hexahedral cleavage. Sometimes these individuals have one of their hexahedral faces of crystallization coincident with the original surface of the hexagonal prism. The stratum of lead-glance contiguous to the surface of the original crystal, is usually separated from the body of it by an empty space, so that it may be very easily broken off. Sometimes only this stratum is in the state of lead-glance, while remains of the original species are still visible in the interior, or part of the crystal only has begun to have a portion contiguous to the surface converted into lead-glance, while the rest presents the adamantine lustre and brown colour of the rhombohedral lead-ba-

ryte. In the six-sided prisms of the same kind of formation met with at Wheal Hope in Cornwall, generally a film of lead-glance is also observed near the surface; but the crystals of the sulphuret in their interior are often much more curiously arranged. Partly they are simply composed of a mass of very compact galena, partly also they present, when broken, the appearance of being cleavable with great facility perpendicular to their axis, and at the same time also parallel to the sides of the six-sided prisms, and parallel also to the planes replacing their edges. The smooth planes obtained in this manner, are actually the faces of cleavage of the hexahedron peculiar to lead-glance. The individuals of the sulphuret namely, gradually formed in the crystal of the phosphate, assume such positions, that two of their faces are parallel to the sides, and two to the terminations of the six-sided prism; the two remaining ones will be perpendicular to the lateral and the terminal faces. The direction of them appears distinctly in the annexed sketch of the transverse section of a crystal, as indicated by the lines parallel and perpendicular to the sides of the hexagon.

On breaking the prisms, we obtain fractures situated like the line *abcd*, which I have sometimes observed, giving a clear demonstration of the actual composition of the crystal in the manner described. Generally the portion adjoining the centre, as it were the axis of the prism, consists of perfectly

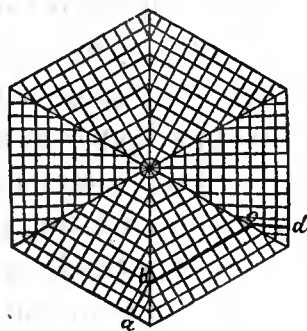

compact lead-glance, provided the original species has entirely disappeared; then comes a more or less considerable stratum of the cleavable mass, which, however, is often wanting; and then a coating of a coarser texture. From the mere arrangement of the particles, it is placed beyond a doubt, that the crystals of the sulphuret have not been formed in moulds from the phosphate. They are probably the product of the gradual decomposition of the latter

by sulphuretted hydrogen, an explanation which was first proposed by ROME' DE L'ISLE, even though the real chemical composition of the rhombohedral lead-baryte was then unknown, to account for the appearances which he so well describes*. Such a decomposition easily takes place even at the common temperature of the atmosphere, if a stream of sulphuretted hydrogen is allowed to pass over the brown variety from Huelgoet, reduced to powder. Both the phosphate and the chloride of lead are decomposed, sulphuret of lead is formed, while the oxygen, phosphorus and chlorine are carried off, forming hydrophosphoric and hydrochloric acid and water.

VI. *Changes in Minerals containing Manganese.*

The ores of manganese have not yet been sufficiently examined, in regard to their chemical composition, to allow us clearly to establish the changes that take place in what may be rightly supposed the decomposition of the prismatic manganese-ore. I have shewn on another occasion †, that the regular forms belonging to that species, are properly found in specimens having a brown streak, a degree of hardness equal or superior to that of fluor, and a specific gravity contained between the limits of 4.3 and 4.4, but that the same form is often united to the character of a black streak, a degree of hardness lower than that of calcareous spar, and a specific gravity often approaching to 4.7. These latter varieties frequently form a coat round the former; and a crystal whose internal particles afford a brown streak, may give a black streak when the experiment is tried with the outward layers. The form remains the same, and even cleavage con-

* *Cristallographie*, vol. iii. p. 400.

† *Edinburgh Journal of Science*, vol. iv. p. 41.

tinues, in those parts whose streak is black ; nay, it seems to be more easily obtained, particularly the faces parallel to the short diagonal of the prism of $99^{\circ} 40'$. From chemical considerations, Professor LEOPOLD GMELIN had formed nearly the same opinion in regard to a change of composition within the crystals or crystalline masses of one of the species. One of them is a hydrate of the oxide of manganese, and that is the prismatic manganese-ore, giving a brown streak : the other is the hyperoxide, formed by loss of water and absorption of oxygen, and it gives a black streak. Hitherto no crystals of the latter substance have been described, that did not depend upon the previous existence of the prismatic manganese-ore. Professor GUSTAVUS ROSE of Berlin shewed me small crystals, having the form of right rhombic prisms, with their acute lateral edges replaced, and measuring $86^{\circ} 20'$ and $93^{\circ} 40'$, a prism not to be found in any of the known varieties of the former species. But the faces not being very bright, and the measurements therefore not quite decisive, inferences drawn from the observed difference in the angles might prove erroneous.

The pyramidal manganese-ore, too, sometimes appears to be a product of the decomposition of the prismatic species. In a specimen in Mr ALLAN'S cabinet, the pyramidal species forms very distinctly the substance of elongated crystals, resembling those of the latter ; but unfortunately the decomposition has proceeded so far, that the surface of the original crystals no longer exists, in a manner similar to what occurs in several instances of malachite in the shape of blue copper. We cannot guess at the chemical change taking place here, as the composition of the pyramidal manganese-ore is entirely unknown. From the preference given to the varieties with a black streak above the pyramidal species by the miners of Ihlefeld, where Professor GUSTAVUS ROSE last summer found the pyramidal species to occur in a particular vein in porphyry, it would appear that this

species contains less oxygen than the product of the other kind of the decomposed hydrate. The pyramidal manganese-ore contains no water, at least not to a considerable extent.

VII. *Changes in Minerals containing Baryta.*

A change analogous to some of those described in the genus lead-baryte, is that which affects baryto-calcite, or the hemi-prismatic hal-baryte, a mineral consisting of one atom of carbonate of lime and one of carbonate of baryta. It occurs not only in perfectly formed crystals, with bright surfaces, but also in such as have lost their original brightness, and are covered with a coating of crystals of sulphate of baryta, constituting the chemical composition of the prismatic hal-baryte. There are varieties, also, which still shew the exact hemi-prismatic form of the baryto-calcite, but, when broken, do not exhibit a trace of the original foliated texture, being altogether composed of a granular tissue of small crystals of heavy-spar. Sulphuric acid and water must have acted jointly to effect this change, but the decomposition must have proceeded slowly. The carbonic acid is expelled by the former, and the latter will carry away the sulphate of lime which is thus formed, leaving only the sulphate of baryta.

The pure carbonate of baryta, also, which constitutes the chemical substance of the species of witherite, is found in all stages of a decomposition of the same kind; that is, from the state of a carbonate, the base enters that of a sulphate. The decomposition proceeds from the surface. Perfectly bright crystals of the substance are rare, and almost entirely confined to some small drusy cavities in the interior of those large globular shapes occurring at Alston-moor, which are white and opaque on the outside, and more translucent and yellowish within. The white coating is not, however, carbonate, but it consists of a number of

minute crystals of sulphate, and is of variable thickness, in some specimens more considerable than in others. Often, too, nothing but the general outline of the original form is left, and large six-sided pyramids or tabular prisms, as we are accustomed to find them in witherite, shewing on their outside a drusy surface of numerous crystals of heavy-spar, are found, when broken across, to consist of the same species in aggregated crystals, generally including cavities, from which the original species has disappeared, and which have not been completely filled up. One of the specimens from Dufton, in Mr ALLAN'S cabinet, deserves a particular description. On a support of crystallized calcareous spar and heavy-spar, the latter in rectangular tables of three inches in length and upwards, are deposited the shapes of isosceles six-sided pyramids, some of them two inches long, with a proportional diameter, which were formerly witherite, but now present a surface rough with crystals of heavy-spar, many of them more than a line in length, and of course easily recognizable. While the process of the transformation of carbonate into sulphate was going on, crystallized portions of the latter were likewise deposited on the surface, and particularly along the edges of the original large tabular crystals of heavy-spar, where they assume a position dependent upon the latter, and may be considered only as continuations of the same individuals. The secondary deposit, being of an opaque milky whiteness, may be readily distinguished from the transparent substance of the original crystals. These crystals themselves do not shew a homogeneous texture throughout. There are cavities inside of them, often in such multitudes, that the remaining mass of heavy-spar assumes a carious aspect, though still, by its cleavage, shewing that it is part of the individual within whose external form it is found. Many of the cavities are filled with small brown crystals of calcareous spar. The crystallization of the calcareous spar, begun in the form of the fundamental rhombohedron R, with

yellowish-white faintly translucent matter, as appears from the delineation of colours, was completed by a brownish opaque matter, in the shape of the combination $R - 1 . R + \infty$, the form *dodécaèdre* of HAÜY. These brown portions have also a carious aspect, as from decomposition, and are studded with small crystals of heavy-spar, of the same kind as that which replaces the crystals of witherite.

VIII. *Changes in Minerals containing Antimony.*

The chemical changes of the minerals containing antimony have not been sufficiently attended to. It is certain that the native antimony takes up oxygen, and then presents a white opaque mass, shewing every peculiarity, in respect of form, of the original substance, as I have seen in a specimen in the museum at York. This is probably the oxide of antimony. The prismatic antimony-glance consists of sulphuret of antimony, a mixture of one atom of the metal and three atoms of sulphur, $Sb S^3$, the ratio of antimony and sulphur being 72.77 and 27.23. It is converted by decomposition into a yellowish opaque mass, of an earthy aspect, which is proved by experiments with the blowpipe still to contain a notable quantity of sulphur, beside water and antimony. In this case the form is preserved. Sometimes, however, as at Bræunsdorf in Saxony, the decomposition is complete, and attended with change of form, in the same manner as the lead-glance. The decomposition begins from the surface, which is corroded, and becomes perfectly smooth. In the cavities thus produced, crystals of the antimony-baryte are deposited, which consist of pure oxide of antimony, one atom of the metal combined with three atoms of oxygen, or $\ddot{S}b$, the two ingredients being in the ratio of 84.32 to 15.68. Each atom of sulphur is exactly replaced by an atom of oxygen.

IX. *Changes in some of the so-called Earthy Minerals, and others.*

The explanation of many of the cases enumerated above, depends upon the ordinary laws, active in our chemical laboratories. Carbonates are changed into sulphates, metallic substances are oxidized, copper is replaced by iron: in general weaker affinities give way to stronger ones. The conversion of sulphates into carbonates, and other cases, may perhaps depend upon some process of mutual decomposition, in which one of the products has been subsequently removed; but the specimens preserved in collections do not usually present any explanations of the facts which they furnish. We must endeavour to ascertain the causes which have contributed towards successive alterations in the chemical composition of minerals, by observing their natural repositories, veins and beds, and mountain masses, exposed to the action of the atmosphere and of water, and to the mutual reaction of the mineral species of which they are constituted.

One of these examples, where the cause of a change in appearance is not so palpable, is the well-known one of the substance usually named the Grey Andalusite. Its specific gravity alone, being above 3.5, while that of the real andalusite never exceeds 3.2, would be sufficient to prove them to belong to different species. But Professor MOHS has found the grey crystals actually to consist of a great number of small individuals of disthene, with an easy cleavage, whenever they are large enough to be distinguished from others, and lying in different directions throughout the mass. Both minerals are found in nodules of quartz engaged in mica-slate. From the analysis by ARFVEDSON, it appears that disthene is a compound of one atom of silica and two of alumina, or $\text{Al}^2 \text{Si}$. Andalusite contains about 83 per cent.

of the same mixture, the rest being a trisilicate of potassa *. The loss of this ingredient sufficiently accounts for the chemical difference between the two bodies; but we are at a loss to conjecture in what manner such a change may have taken place.

Mr ALLAN has in his cabinet several specimens from the trap district near Dumbarton, exhibiting the shape of analcime, but entirely composed of aggregated crystals of prehnite. Mr WILLIAM GIBSON THOMSON is likewise in the possession of several exceedingly distinct and instructive specimens of the same description. There is one, among the former, where prehnite, aggregated in globular shapes, is implanted on icositetrahedral masses, once of analcime, but now likewise converted into prehnite. The implanted varieties are green and translucent; I found their specific gravity equal to 2.885: the portions within the faces of the icositetrahedrons are white and opaque, and give 2.842, both of them rather lower than the usual results obtained, which are a little above 2.9, at least in simple crystals. But the arrangement of the divergent individuals in the reniform shapes, is highly remarkable, and throws some light also on the gradual formation of the new species within the space occupied by the crystals of analcime. The centres of the single globular groups, aggregated in a reniform manner, are situated on the surface of the icositetrahedrons. From these, the fibres diverge, not only towards the surface of the globules, but also on the other side, in the direction of what formerly was analcime. The original surface of the icositetrahedrons may be laid bare, by breaking off the exterior coat of prehnite. Even in those places where there was no coating of prehnite, the decomposition of the analcime has taken place in the neighbourhood of other decomposed crystals. The ingredients of prehnite are silica, alumina, lime, and water; those of analcime, silica, alumina, soda and water. There

* BEUDANT'S *Mineralogy*, p. 333. & 363.

is no similarity between the two in the mode of combination of their ingredients, analcime being considered as a compound of bisilicates of soda and alumina with water, while prehnite is considered as a compound of simple silicates of lime and alumina, with a hydrate of silica.

On another occasion *, I have described a very curious instance of pyramidal forms, agreeing as near as possible with those of the pyramidal scheelium-baryte, which consisted in their interior of multitudes of columnar crystals of the prismatic scheelium-ore. They were found at Wheal Maudlin in Cornwall, and are partly implanted on quartz, arsenical pyrites, chlorite, &c. and partly imbedded in cleavable blende. The chemical composition of the two species is almost identically the same, at least not more different than in the varieties of pyroxene, or other similar substances. The chemical formula of the first is $\text{Ca } \ddot{\text{W}}^2$; that of the second $\text{Mn } \ddot{\text{W}}^2 + 3 \text{Fe } \ddot{\text{W}}^2$, different only in the isomorphous bases of calcium in the one, and manganese and iron in the other, one atom of the protoxide of each of them being united with two atoms of tungstic acid. This curious resemblance of the chemical mixture was then pointed out to me by Professor MITSCHERLICH, who supposed, that, from the isomorphism of the bases, the varieties observed might be genuine crystals, of the same ingredients as wolfram, but with the form of the scheelium-baryte: this was disproved, however, by the observation of the mechanical composition of the masses. Of itself, the hypothesis is plausible enough that such was originally the case, and that the cohesion among the particles was so slight, as to be afterwards overpowered by the greater crystalline attraction of the same particles in hemi-prismatic crystals, subsequently formed, and as they now appear; in a manner analogous to the decomposition of the common hydrous sulphates

* *Edinburgh Journal of Science*, vol. i. p. 380.

of zinc or magnesia by heat, as described above. The other hypothesis, that the lime in the original species has been subsequently replaced by the oxides of iron and manganese, is rendered more likely by the fact, that there are crystals which in part consist of the scheelium-baryte, while near the surface, but within the planes of the original crystals, and where portions of them seem to be wanting, we observe an aggregate of crystals of the scheelium-ore. A specimen of this kind I saw at Schlaggenwald, its native place.

Here we must also consider Haytorite, a substance newly discovered, but which has already given rise to various and contradictory hypotheses, and in connection with it some of the pseudomorphoses of rhombohedral quartz in general. Haytorite has been ascertained by Mr LEVY to have the shape of the species to which he gives the name of Humboldtite. All those mineralogists who have examined it, agree in pronouncing the substance of it to be calcedony, which is itself a granular compound of exceedingly minute individuals of rhombohedral quartz: so much appears from its physical characters. Dr BREWSTER obtained the same result, by ascertaining its action on light. He has also directed the attention of naturalists to the circumstance, that the planes of composition between the different individuals, and which are always so very distinct in datolite, are as distinct as possible in haytorite; and hence he draws the correct inference, that they cannot have been formed in a mould, like the pseudomorphoses. Datolite contains a notable quantity of silica, 36.5 per cent. according to KLAPROTH'S analysis. The successive exchange of its contents of lime and boracic acid for an additional quantity of silica, if it goes so far as completely to destroy the original species, will transform the substance of the crystals into a mass of calcedony. There is no proof, however, that such a process has actually taken place, so long as we do not discover the remains of the former species included in the

other, testifying the progress of the change; and we must be the more careful in establishing hypotheses, if, as in the present case, we are not led by analogous occurrences in other varieties of the same species.

Calcareous spar is one of those species which are very easily acted upon by atmospheric agents. The hollow scalene six-sided pyramids of brown-spar, the macrotypous lime-haloide of MOHS, consisting of imbricated rhombohedrons with parallel axes, form a remarkable instance in this species of the replacement of one substance by another, not sufficiently explained by any of the authors which treat of it, though some of the observations on which the actual explanation of the appearances is founded, may be traced in several of their writings. A specimen of a pale yellowish-grey colour in Mr ALLAN'S cabinet, of the nature alluded to above, and broken across, in order to shew the inside, presents a cavity, the sides of which are lined with small rhombohedrons of brown-spar, forming a surface analogous to the external one of the six-sided pyramid. But it shews, besides, also the remains of what formerly filled up the space altogether, of a crystal of the rhombohedral lime-haloide. The planes of cleavage of this crystal are still visibly in the same position in which they originally existed, as appears from the contemporaneous reflection of the image of a luminous object from the portions of it, now no longer cohering. The surface of these portions has the same appearance as fragments of calcareous spar which have been exposed to the corroding action of acids. Crystals of the brown-spar are likewise deposited on some of those portions disengaged from the rest, and, as it were, pushed off from their original position, by the gradual increase of the crystals of brown-spar. The mass of this latter species forms a coating of pretty uniform thickness over the whole surface of the original six-sided pyramid. Nearly in the middle of the stratum, wherever it is broken across, may be observed a whitish, or only rather more opaque line, of

the same colour as the rest, dividing it into two, without producing the least deviation in the faces of cleavage upon which it is seen. This line is evidently the section of the original surface of the pyramid of calcareous spar, upon which one portion of the brown-spar was deposited, while another portion was formed within the space previously occupied by the calcareous spar, and destroyed in the progress of decomposition. The chemical change is here very distinctly indicated; part of the carbonate of lime is replaced by carbonate of magnesia, so as to form in the new species a compound of one atom of each. How this change was brought about, is a difficult question to resolve, though the fact cannot be doubted, as we have in the specimen described a demonstration of it, approaching in certainty almost to ocular evidence. It is scarcely surprising, that such appearances should be visible in metallic veins, like some of those near Schemnitz in Hungary, the whole nature of which shews that they must have been gradually changed by successive revolutions, the uppermost part being often almost entirely composed of cellular quartz, which is formed in fissures contained in other species or compound masses, subsequently decomposed, and leaving the quartz alone. I shall not enter into an inquiry respecting the probability of such changes in mountain masses, of such an enormous bulk as the dolomite of the Tyrol, to which VON BUCH ascribed a similar origin. The facts observed on a small scale, do not exclude the possibility of such changes, though we are certainly less prepared to expect them, where powerful and momentary revolutions are supposed to have taken place at the same time, than where any period of time, even the most protracted, may be granted for the successive replacement of one particle of matter by another.

Crystals of calcareous spar, previously coated with small individuals of quartz, often entirely disappear, and leave an empty shell. We sometimes observe particles of the calcareous spar

with a corroded surface, still contained within the covering, but much diminished in size. A large pseudomorphosis in the shape of a scalene six-sided pyramid, from the zinc mines in Somersetshire, in Mr ALLAN'S cabinet, from which the original species of calcareous spar has entirely disappeared, is of a particularly interesting nature. Beside the superficial coating, the quartz matter has introduced itself into the fissures of the crystal, parallel to its planes of cleavage, and the interior of it is now not quite empty, but divided into cells by lamellæ of quartz, the cells having the shape of the fundamental rhombohedron of calcareous spar. The formation of what now remains must have begun, therefore, when the original crystal was still perfect, and have proceeded during the decomposition of it. The change was gradual, and so we must conceive these processes to go on in every instance. It is highly probable that the formation of another species, so near, or even within the boundaries of a crystal previously existing, will greatly influence, by its electro-chemical action, upon the arrangement and composition of the particles of that body.

Quartz, more than any other species, is known to fill up the vacuities formerly occupied by crystals of calcareous spar, of fluor, and of gypsum. Such masses of secondary formation are called *pseudomorphoses*, and are usually conceived to have been formed in moulds, arising from a substance which surrounded the original crystals, and was left unchanged, while the latter was destroyed by decomposition, in a manner similar to the process of making first the mould of a bust or statue, and then filling it with plaster of Paris. The cast obtained, from a mineralogical point of view, is a pseudomorphosis of gypsum. We have but rarely an opportunity of observing entire series of specimens illustrative of such a process. Even in extensive collections, it is difficult to bring together a sufficient number of them, in order to give an example of each stage of the gradual formation and decomposition of one species after the other. The moulds in which many of

the pseudomorphoses are supposed to have been formed, never were seen or described by any mineralogist; for instance those of quartz in the shape of fluor from Beeralston; those of hornstone in the shape of calcareous spar from Schneeberg; those of calcedony, in the shape probably of fluor, from Tresztyan in Transylvania. We might be inclined to think, that actually there have never been any, but that the new substance was formed while the old one was disappearing. A film of quartz, deposited on the surface of a crystal, would be the support of any new matter, subsequently added, as we see in many instances, particularly the pseudomorphous hornstone from Schneeberg, that, like the inside, wherever it is not entirely filled up, the outside also often shews the reniform and botryoidal shapes depending upon the undisturbed formation of the component individuals. Water, charged with carbonic acid, and by that means holding silica in solution, may have dissolved the original species, and deposited the siliceous matter in its stead.

In the varieties from Schneeberg, which consist of perfectly compact rhombohedral quartz or hornstone, the original outline of the decomposed crystals of calcareous spar cannot any longer be descried. There are varieties, however, also in the shape of the same species, and consisting likewise of quartz, where this is still possible; and among them I know of none that are more distinct than those from Bristol. The quartz, in well defined individuals, is deposited partly inside the space formerly occupied by calcareous spar, producing as many geodes or drusy cavities, and partly on the outside of the same space, the two sets of deposits being separated by the surface of the original crystal, the only thing still remaining of it. They do not cohere firmly, but the outer deposit may be removed, leaving the inner one in the shape of perfectly formed crystals of calcareous spar, the surface of which is stained brown by oxide of iron. Mr ALLAN has one in his cabinet, which he disengaged in

this way from the surrounding mass, terminated on both ends, and altogether shewing only a small portion of its surface, where it might have been attached to an original support.

In the example just now described, the crystals of quartz are deposited pretty regularly, at least in so far as their axes are nearly perpendicular to the surface of the crystals of calcareous spar. This is not the case in the prismatic manganese-ore from Ihlefeld, which fills up, and at the same time surrounds, the space formerly containing crystals of calcareous spar, and where likewise nothing but the surface of the original crystals has remained. Both masses, however, are perfectly alike, and consist of granular individuals, still easily recognizable. Such component individuals are sufficiently small to withdraw themselves from observation, in the varieties of compact rhombohedral iron-ore from Johanngeorgenstadt in Saxony, and other places, which exactly, like the manganese-ore, include shapes, or rather surfaces of crystals only, of calcareous spar.

A similar explanation no doubt applies also to the steatite from Goepfersgrün in Bayreuth, well known to collectors, but as to the causes which have produced it, still unknown to mineralogists. Their perfectly homogeneous appearance excludes every idea of their being formed by a mixture, however intimate, of steatite, and the species whose forms the crystalline shapes affect; for, on this supposition, they still must retain some of the properties peculiar to those species. The fact that several forms are found, not only incompatible with each other, but evidently belonging to other two or more well known species, as quartz, calcareous spar, and pearl-spar, likewise distinctly proves them not to be actual crystals, belonging to the internal nature of steatite. But if we compare the analogy of such bodies as those described above, which, like the steatite, include only the form of another species, we can have no doubt that all of them must have been formed in the same way. The chemical composition of steatite

is not well ascertained: it is probably a compound of some silicate and of a hydrate of magnesia. Quartz is entirely composed of one of its ingredients; but the other species, calcareous spar, for instance, whose crystals have been replaced by steatite, do not contain so much as a trace of these substances, so that we must suppose them to have been entirely destroyed, even without giving up part of their ingredients to the new mixture, while the latter was forming within and without the space which these crystals occupied.

Earthy and friable masses are often the result of decomposition, that is to say, of a change in the arrangement of particles, which then are so minute, that none of their natural-historical properties can be ascertained. The pale green friable masses, in the form of crystals of pyroxene, from Tyrol and Transylvania, considered by WERNER as crystallized green-earth, by HAÜY as a variety of steatite; the red masses sometimes shewing the forms of olivine, and dependent upon the decomposition of that species, included in some of the rocks of Arthur's Seat, near Edinburgh; porcelain-earth, probably owing to the decomposition of the porcelain-spar of FUCHS*; various kinds of steatite, quoted by authors, some in the form of garnet, others in the form of trigonal-dodecahedrons of an unknown mineral, engaged in the serpentine from Siberia, others in the form of felspar, &c. yield examples of such bodies. They have not yet been examined with that degree of attention which they deserve, not so much perhaps on their own account, as rather for the inferences to which researches of this kind might lead. But it must be allowed, that many of them cannot be instituted in those fragments of the entire series, which, for their more apparent distinctness, are preserved in our mineralogical cabinets. Beside

* *Denkschriften der Akademie der Wissenschaften zu München für 1818 und 1819.*

extensive series of the minerals in question, they require the joint efforts of mineralogical inquiry, for ascertaining the species which have been destroyed, and those which have been formed; of chemical examination, for ascertaining the difference in the ingredients of the two; and of geological observation of the specimens in their natural repositories, in order to establish the causes by which the chemical affinities, balanced by the formation of the original compounds, have again entered into action.

From the preceding enumeration, it is but too evident, that our knowledge of the facts, as well as of their causes, up to this moment is scanty and imperfect. A wide field of research is still open, promising a fair return for the labour, naturalists may bestow upon its cultivation. I have endeavoured to collect only some of the most remarkable and familiar instances of the changes which may take place in the solid body of a crystal, the ulterior study of which, while it illustrates the idea of species, will throw some light also on the causes of such alterations as do not appear conformable to the known laws of chemical affinity, for which we cannot account at least in the present state of our information.

VII. *On the Influence of the Air in determining the Crystallization of Saline Solutions.* By THOMAS GRAHAM, Esq. A.M.

(Read December 17. 1827.)

THE phenomenon referred to has long been known, and popularly exhibited in the case of Glauber's salt, without any adequate explanation. A phial or flask is filled with a boiling saturated solution of sulphate of soda or Glauber's salt, and its mouth immediately stopped by a cork, or a piece of bladder is tied tightly over it, while still hot. The solution, thus protected from the atmosphere, generally cools without crystallizing, although it contains a great excess of salt, and continues entirely liquid for hours and even days. But upon withdrawing the stopper, or puncturing the bladder, and admitting air to the solution, it is immediately resolved into a spongy crystalline mass, with the evolution of much heat. The crystallization was attributed to the pressure of the atmosphere suddenly admitted, till it was shewn that the same phenomenon occurred, when air was admitted to a solution already subject to the atmospheric pressure. Recourse was likewise had to the supposed agency of solid particles floating in the air, and brought by means of it into contact with the solution; or it was supposed that the contact of gaseous molecules themselves might determine crystallization, as well as solid particles. But although the phenomenon has been the subject of much speculation among chemists, it is generally allowed that no satisfactory explanation of it has yet been proposed.

In experimenting upon this subject, it was found, that hot concentrated solutions, in phials or other receivers, might be in-

verted over mercury in the pneumatic trough, and still remain liquid on cooling; and thus the causes which determine crystallization were more readily examined. For this purpose, it was absolutely necessary that the mercury in the trough should be previously heated to 110° or 120° ; for otherwise that part of the solution in contact with the mercury cooled so rapidly, as to determine crystallization in the lower part of the receiver long before the upper part had fallen to the temperature of the atmosphere. In such cases, crystallization beginning on the surface of the mercury, advanced slowly and regularly through the solution. Above, there always remained a portion of the solution too weak to crystallize, being impoverished by the dense formation of crystals below. It was also necessary to clean the lower and external part of the receivers, when placed in the trough, from any adhering solution, as a communication of saline matter was sometimes formed between the solution in the receiver and the atmosphere without. When these precautions were attended to, saline solutions over mercury remained as long without crystallizing as when separated from the atmosphere in the usual mode.

Solutions which completely filled the receivers when placed in the trough, allowed a portion of mercury to enter, by contracting materially as they cooled. A bubble of air could thus be thrown up, without expelling any of the solution from the receiver, and the crystallization determined, without exposing the solution directly to the atmosphere.

The first observation made was, that solutions of sulphate of soda sometimes did not crystallize at all upon the introduction of a bubble of air, or at least for a considerable time. This irregularity was chiefly observed in solutions formed at temperatures not exceeding 150° or 170° ; although water dissolves more of the sulphate of soda at these inferior temperatures than at a boiling heat. Brisk ebullition for a few seconds, however, rendered the solution upon cooling amenable to the usual influence of the air

In all successful cases, crystallization commenced in the upper part of the receiver around the bubble of air, but pervaded the whole solution in a very few seconds. A light glass bead was thrown up into a solution without disturbing it.

It occurred to me, that, since the effect of air could not be accounted for on mechanical principles, it might arise from a certain *chemical* action upon the solution. Water always holds in solution a certain portion of air, at the temperature of the atmosphere, which it parts with upon boiling. Cooled in a close vessel after boiling, and then exposed to the atmosphere, it re-absorbs its usual proportion of air with great avidity. Now, this absorbed air appears to affect in a minute degree the power of water to dissolve other bodies, at least a considerable part of it is extricated upon the solution of salts. When a bubble of air is thrown up into a solution of sulphate of soda, which has previously been boiled and deprived of all its air, a small quantity of air will certainly be absorbed by the solution around the bubble. A slight reduction in the solvent power of the menstruum will ensue at the spot where the air is dissolved. But the menstruum is greatly overloaded with saline matter, and ready to deposit; the slightest diminution of its solvent power may therefore decide the precipitation or crystallization of the unnatural excess of saline matter. The absorption of air may in this way commence and determine the precipitation of the excess of sulphate of soda in solution.

Here, too, we have an explanation of the fact just mentioned, that solutions of sulphate of soda which have *not* been boiled, are less affected by exposure to the air than well boiled solutions; for the former still retain the most of their air, and do not absorb air so eagerly on exposure as solutions which have been boiled.

But the theory was most powerfully confirmed by an expe-

rimental examination of the influence of other gases, besides atmospheric air, in determining crystallization. *Their influence was found to be precisely proportionate to the degree in which they are absorbed or dissolved by water and the saline solutions.*

To a solution of sulphate of soda over mercury, which had not been affected by a bubble of atmospheric air, a bubble of carbonic acid gas was added. Crystallization was instantly determined around the bubble, and thence through the whole mass. Water is capable of dissolving its own volume of carbonic acid gas, and a solution of sulphate of soda as strong as could be employed was found by SAUSSURE to absorb more than half its volume.

In a solution of sulphate of soda, which was rather weak, both common air and carbonic acid gas failed to destroy the equilibrium; but a small bubble of ammoniacal gas instantly determined crystallization.

When gases are employed which water dissolves abundantly, such as ammoniacal and sulphurous acid gases, the crystallization proceeds most vigorously. It is not deferred till the bubble of gas reaches the top of the receiver, as always happens with common air, and frequently with carbonic acid gas, but the track of the bubble becomes the common axis of innumerable crystalline planes, upon which it appears to be borne upwards; and sometimes before the ascent is completed, the bubble is entangled and arrested by crystalline arrangements which precede it.

The number of gases which are less soluble in water than atmospheric air is not considerable, but of these hydrogen gas was found to be decidedly less influential in determining crystallization.

Minute quantities of foreign liquids soluble in water likewise disposed the saline solution to immediate crystallization, as might be expected, and none with greater effect than alcohol. It is known that alcohol can precipitate sulphate of soda from its

aqueous solutions. The soluble gases I suppose to possess a similar property.

These facts appear to warrant the conclusion, that air determines the crystallization of supersaturated saline solutions, by dissolving in the water, and thereby giving a shock to the feeble power by which the excess of salt is held in solution.

Before concluding, I may be allowed to make a remark, on the usual description of the sudden congelation of the solution of sulphate of soda upon the admission of air. It is said that the solution expands in solidifying, in the same way as water does in becoming ice. But the expansion which takes place is merely temporary, and not due to such a cause, but entirely to a momentary dilatation of the whole contents of the phial, both liquid and solid, by the evolution of heat, which occurs on the instant of crystallizing, and which always amounts to 20° or 30° . That the salt does not permanently expand on crystallizing is easily proved, by the sinking of a crystal in the densest solution of the salt which can be formed.

VIII. *Mineralogical Account of the Ores of Manganese.* By
W. HAIDINGER, Esq. F. R. S. E.

(Read December 17. 1827.)

THE mineralogical determination of those species, the chief constituent of which is Manganese, has been for a long time destitute of that precision at which other species had long arrived, whose chemical constitution was better known. Two years ago I published, in a memoir "*On the Crystalline Forms and Properties of the Manganese-Ores**, " the most accurate information I could then collect, partly from some works on mineralogy, partly from my own observations. In the general descriptions which I propose giving here for the mineralogical illustration of Dr TURNER'S account of their chemical properties, I have availed myself of the corrections given in the translation of the same paper in POGGENDORFF'S Annals by Professor GUSTAVUS ROSE, who has corrected or verified the angles given, and compared them again with nature ; so that the statements have gained a considerable accession of authority. I have added the description of that species, which consists of the anhydrous peroxide of manganese, and which, from the difference of its properties from all the rest, whatever may be the mode of its formation, should be considered as a species of its own.

It is attended with considerable difficulty, and offers but little advantage, to collect the synonyms used by the older mineralogical authors, the two names Grey Manganese and Black Manganese, and other ones of a similar cast, having been almost

* *Edinburgh Journal of Science*, vol. iv. p. 41.

indiscriminately applied to every one of the species, or at least to those which most commonly occur in nature. I have again compared, in this respect, some of the treatises on mineralogy, and given the synonyms as nearly exact as I could. Those of HAÜY I have left out, because this author, though of the greatest importance where regular forms can be made out, is remarkably deficient in the particular point of the ores of manganese. The undeterminable varieties, such as black-wad and others, I have thought best to omit altogether from the general descriptions, as their connection with the rest is not quite clear; and I have done so the more willingly, as Dr TURNER has not subjected them to any chemical examination. The authors and works quoted are the following :

- Handbuch der Mineralogie. By J. F. L. HAUSMANN.
 System of Mineralogy; 3d edition. By R. JAMESON.
 Elementary Introduction to the Knowledge of Mineralogy. By W. PHILLIPS.
 Grundriss der Mineralogie. By F. MOHS.
 Treatise on Mineralogy. By F. MOHS. Translated by W. HAIDINGER.
 On the Crystalline Forms and Properties of the Manganese-ores. By W. HAIDINGER, in the Edinburgh Journal of Science.
 Handbuch der Oryctognosie. By K. C. VON LEONHARD.

Four of the species belong to the genus Manganese-ore of the system of MOHS, and they are accordingly provided with systematic denominations. The fifth species differs so materially from the rest, particularly in regard to hardness, that I hesitate to assign it a place in the same genus, or even order, and therefore shall not at present propose a systematic denomination for it. None of them are as yet provided with good trivial names; those phrases and definitions which were used, in general conveying nothing but an imperfect, and often erroneous, allusion to the chemical constitution of the species. Those which I here venture to propose, have at least the property, essential to all good trivial names, that they consist of one single word; and,

though I am aware that to give names of this kind to old species is arrogating to one's self a great portion of authority, yet I believe this to be the only consistent plan, the advantages of which will no doubt overbalance every consideration of difficulty. Their explanation will be given with the description of each of the species.

When I began to collect the information contained in works on mineralogy relative to the localities of the different species, the result was scanty, and on account of the erroneous determination, generally uncertain. I resolved therefore, in enumerating the localities, to mention those only which I knew to be correct either from personal knowledge, or by comparing the localities, attached to specimens in the various collections, with the verbal information of several of my mineralogical friends. With this view, I have examined the mineralogical cabinets of Mr ALLAN and Mr W. G. THOMSON in Edinburgh, of Mr VON STRUVE and Mr HERTZ in Hamburgh, of the Royal Museum and of Mr TAMNAU in Berlin, of the National Museum in Prague, and of Mr VON PITTONI in Vienna, and of the public museums in that city, the Imperial Cabinet, the Brazilian collection, and that of the Polytechnic Institution. I have been indebted to the proprietors of the private collections, and the gentlemen attached to the public ones, for much kindness and many interesting notices of such localities as they had visited themselves, or were otherwise acquainted with; especially to Professor GUSTAVUS ROSE, Professor ZIPPE, Professor MOHS, Mr PARTSCH, Dr POHL, and Professor RIEPL. From Mr VON LEONHARD, Professor BERTHIER, and Mr LEMAN, I also obtained some interesting specimens, and much valuable information.

I. PRISMATOIDAL MANGANESE-ORE.

Manganite.

Grau-Braunstein, in part, *Hausmann*, p. 288.

Grey Manganese-ore, in part, *Jameson*, vol. iii. p. 252.

Grey Oxide of Manganese, in part, *Phillips*, p. 243.

Prismatoidisches Manganerz, *Mohs*, vol. ii. p. 488.

Prismatoidal Manganese-ore, *Mohs*, Translation, vol. ii. p. 419.—Id. *Haidinger*, *Edin. Journ. of Science*, vol. iv. p. 41.

Gewaassertes Mangan-Hyperoxidul, *Leonhard*, p. 239.

Fundamental Form. Scalene four-sided pyramid. $P = 130^\circ 49'$, $120^\circ 54'$, $80^\circ 22'$. Plate, Fig. 1.

$$a : b : c := 1 : \sqrt{3.37} : \sqrt{2.4}.$$

Simple forms.		
1. $P - \infty$ (<i>o</i>).		
2. P (<i>P</i>)	$= 130^\circ 49'$, $120^\circ 54'$, $80^\circ 22'$.	
3. $P + 1$ (<i>m</i>)	$= 112^\circ 35'$, $97^\circ 35'$, $118^\circ 45'$.	
4. $P + \infty$ (<i>M</i>)	$= 99^\circ 40'$.	
5. $(\frac{3}{5} \overset{\vee}{Pr})^3$ (<i>c</i>)	$= 117^\circ 16'$, $144^\circ 5'$, $74^\circ 28'$.	
6. $(\overset{\vee}{Pr})^3$ (<i>n</i>)	$= 95^\circ 4'$, $132^\circ 50'$, $103^\circ 24'$.	
7. $(\overset{\vee}{Pr} + \infty)^3$ (<i>l</i>)	$= 61^\circ 18'$.	
8. $(\bar{Pr} - 1)^3$ (<i>h</i>)	$= 154^\circ 13'$, $116^\circ 10'$, $70^\circ 2'$.	
9. $(\bar{Pr} + \infty)^3$ (<i>r</i>)	$= 134^\circ 14'$.	
10. $(\frac{4}{5} P - 2)^3$ (<i>g</i>)	$= 162^\circ 39'$, $115^\circ 10'$, $67^\circ 42'$.	
11. $(\overset{\vee}{Pr} + \infty)^5$ (<i>s</i>)	$= 76^\circ 37'$.	
12. \bar{Pr} (<i>d</i>)	$= 114^\circ 19'$.	
13. $\overset{\vee}{Pr}$ (<i>e</i>)	$= 122^\circ 50'$.	

Character of combinations hemi-prismatic, with inclined faces.

Combinations.		
1. $P - \infty$. $P + \infty$.	Fig. 2.	
2. $P - \infty$. $P + \infty$. $(\overset{\vee}{Pr} + \infty)^5$.	Fig. 3.	
3. \bar{Pr} . $P + \infty$. $(\overset{\vee}{Pr} + \infty)^5$.	Fig. 4.	

Fig. 1.

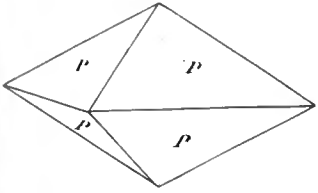

Fig. 2.

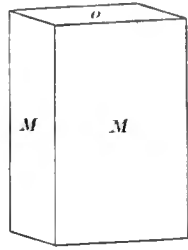

Fig. 4.

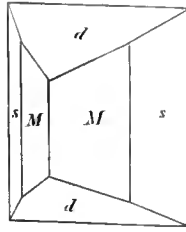

Fig. 3.

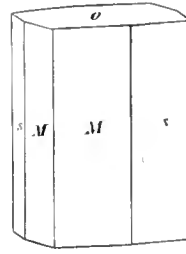

Fig. 5.

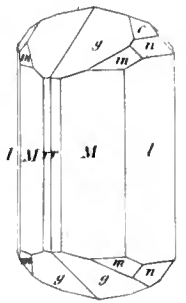

Fig. 8.

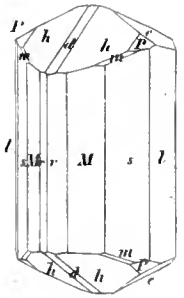

Fig. 9.

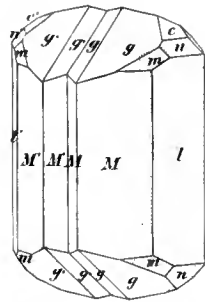

Fig. 10.

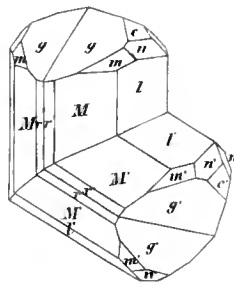

Fig. 6.

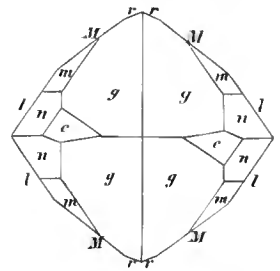

Fig. 11.

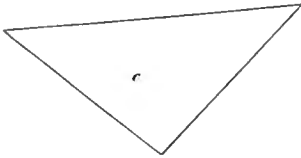

Fig. 12.

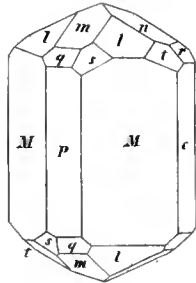

Fig. 13.

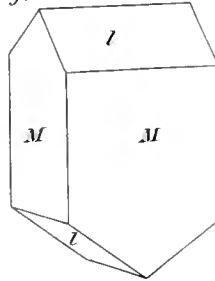

Fig. 7.

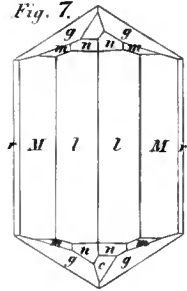

Fig. 14.

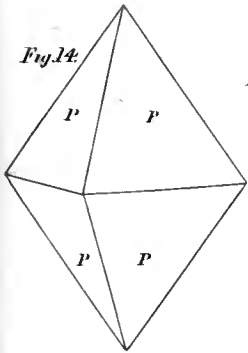

Fig. 15.

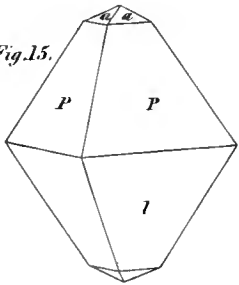

Fig. 16.

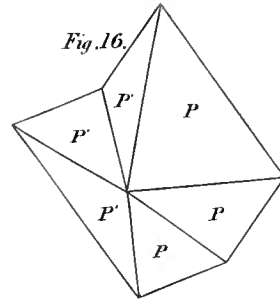

Fig. 17.

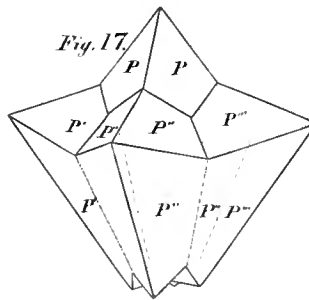

Fig. 24.

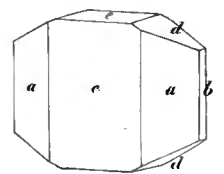

Fig. 18.

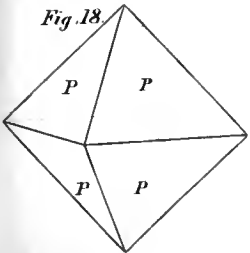

Fig. 19.

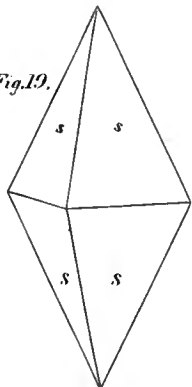

Fig. 20.

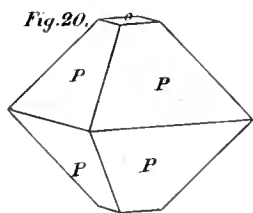

Fig. 21.

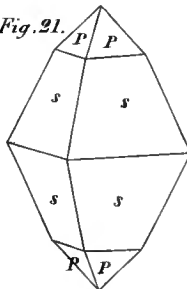

Fig. 22.

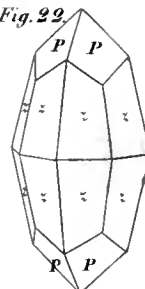
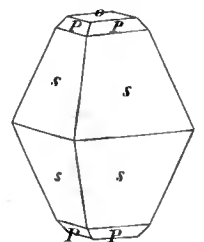

Fig. 23.





These are the most common, and at the same time the least complicated of the varieties of the present species.

$$4. \left(\frac{4}{3}\bar{Pr} - 2\right)^3. \frac{\left(\frac{5}{3}\overset{\circ}{Pr}\right)^5}{2}. (\overset{\circ}{Pr})^5. P + 1. P + \infty. (\overset{\circ}{Pr} + \infty)^3. (\bar{Pr} + \infty)^3. \text{ Fig. 5.}$$

The 6th Figure represents the projection upon $P - \infty$, the 7th Figure the elevation upon a plane parallel to the short diagonal of the prism $P + \infty$. The hemi-prismatic character of the species appears only in the disposition of the faces marked *c*. They form horizontal edges of combination with $(\overset{\circ}{Pr})^5$. These crystals are from two to three lines in thickness, and some of them nearly an inch long.

$$5. \bar{Pr}. (\bar{Pr} - 1)^3. \overset{\circ}{Pr}. P. P + 1. P + \infty. (\overset{\circ}{Pr} + \infty)^6. (\overset{\circ}{Pr} + \infty)^3. (Pr + \infty)^5. \text{ Fig. 8.}$$

Small but very well pronounced crystals of this variety were disengaged from the same specimen which contains the variety 4. They were found in small drusy cavities, which were discovered when the whole was broken up for analysis. The edges between $(\bar{Pr} - 1)^3$ and $P + 1$ are parallel to those between $P + 1$ and $(\overset{\circ}{Pr} + \infty)^3$. The faces of $\overset{\circ}{Pr}$, marked *e* in the figure, are rarely observed in the crystals of this species.

Cleavage, $\overset{\circ}{Pr} + \infty$ highly perfect and easily obtained; $P + \infty$ also perfect, but less easily obtained; traces of $\bar{Pr} + \infty$, and of $P - \infty$. Fracture uneven; surface of the vertical prisms streaked parallel to their common edges of intersection; \bar{Pr} streaked parallel to the edges of combination with P ; $P - \infty$ parallel to those with \bar{Pr} . In general, the faces are smooth, and possess pretty high degrees of lustre.

Lustre, imperfect metallic. Colour, dark brownish-black, inclining to iron-black. Streak, reddish-brown. Opaque, in larger

masses. When broken or cleaved in the direction of $\check{P}r + \infty$, and exposed to the light of the sun, minute splinters are often observed, which, by transmitted light, appear of a bright brown colour, so that the mineral cannot be said to be absolutely opaque.

Brittle. Hardness = 4.0...4.25, a little higher than fluor. Specific gravity = 4.328, of a number of fragments of crystals; = 4.312, in another experiment, of a single crystal of considerable size.

Compound Varieties.—Twin-crystals, formed in two different manners. In the first of them, the axes of the two individuals are parallel, dependant on the hemi-prismatic character of the combinations of the species; in the second, they are inclined.

1. Face of composition parallel to $\check{P}r + \infty$; axis of revolution perpendicular to it. Fig. 9. If we did not give attention to the compound state of this variety, shewn in the present instance by the groove along the place of junction, which is not always visible, we might be induced to believe that it possesses a hemi-prismatic character, referred to an axis inclined upon the base of the fundamental pyramid, which is not the case. One can generally trace the peculiar disposition of the crystalline faces upon each of the individuals. A repetition of this law produces thick prisms, terminating perpendicularly upon their axis by a rough face, which consists of the apices of numerous individuals, or rather of numerous particles of two individuals, alternating with each other. Such faces are not uncommon in the prismatic manganese-ore.

2. Axis of revolution perpendicular, face of composition parallel to a plane of $\check{P}r$. Fig. 10. The disposition of the faces marked *c*, upon which the hemi-prismatic character of the species depends, is such, that a mere revolution of 180° is not sufficient to bring the two individuals into the position required for joining in a regular twin; though the general disposition takes place also in the present instance, the

portions of the two crystals similarly situated being 180° distant from each other, compared to the plane of composition. This peculiarity of the twin-crystals, as Professor GUSTAVUS ROSE remarks, may be shortly explained, by considering that of the hemihedral form c ;—the inverse of what is found in one of the individuals, occurs in the other.

Irregular composition is very common in this species: it is either granular or columnar. The latter occurs much more frequently.

Observations.

The name of *Manganite*, proposed for this species, is formed in allusion to the metal which it contains, in preference to others, as it is the one which occurs most frequently in nature. In most mineralogical works, the characters of manganite and of pyrolusite have been confounded with each other, or rather a medley of the two, neither of them exactly ascertained, was given as the description of a single species. The insufficiency of the descriptions of HAÜY and older authors was felt by many mineralogists, and several of them endeavoured to substitute better ones in their place. The result, obtained by Mr VON LEONHARD, in the first edition of his system, is by no means more satisfactory than that of HAÜY; Mr PHILLIPS, with his usual skill in crystallographic observations, has succeeded much better. The description of the forms given by MOHS agrees very nearly with the latter, at least much more so than any two other descriptions. There are some differences, however, in regard to the absolute measurement of the angles, and in the statement that, according to MOHS, the cleavage parallel to the short diagonal of the prism $P + \infty = 99^\circ 40'$ is more distinct, and more easily obtained than any other cleavage of the species; whereas, according to PHILLIPS, the crystals "cleave readily, and with brilliant surfaces parallel to the lateral planes of a rhombic prism

of 100° and 80° , and both its diagonals." Though, in many varieties, the cleavage parallel to the long diagonal of that prism may in fact be obtained, it is always less distinct than that parallel to the short diagonal, and often not at all observable. It is important to attend to this difference in the perfection of cleavage; the more so, because the cleavage parallel to the short diagonal of $P + \infty = 99^\circ 40'$, is at the same time parallel to the long diagonal of another prism $(\text{Pr} + \infty)^s = 76^\circ 36'$ (the supplement of which is $103^\circ 24'$), which occurs very frequently in the same mineral, and might be, or has actually been, mistaken for it, in a more superficial examination of the crystalline forms of the species.

The most remarkable peculiarity in the series of crystallization of this species, is its hemi-prismatic character, the faces of those forms which assume it being inclined to each other. I have much pleasure in adding here, that the observation of this peculiar character, which I gave an account of from a rather limited number of crystals, has since been repeated, and perfectly confirmed, by Dr CHARLES HARTMANN of Blankenburg. The faces marked *c*, if sufficiently enlarged, would give rise to a form resembling a tetrahedron, like Fig. 11, the planes of which are equal and similar scalene triangles. Among the remaining species whose forms belong to the prismatic system, only the sulphates of zinc, of magnesia, and of nickel, are known to possess an analogous formation. This was first placed beyond a doubt by Professor MITSCHERLICH, who observed the fact, that the faces *s* and *t*, Fig. 12, appear only contiguous to the alternating faces of *l*; although the alternating enlargement of these same faces, represented in Fig. 13, had been previously noticed in the sulphate of magnesia by mineralogists, so far back as the time of ROME' DE L'ISLE and LINNÆUS. Large crystals of this salt generally shew the hemi-prismatic character much more distinctly than small ones.

Manganite occurs in very few places. It is found in great abundance, often beautifully crystallized, in the manganese mines of Ihlefeld in the Hartz, occurring in veins traversing porphyry. Thin crystals and masses consisting of columnar individuals, when rubbed down on a plate of porcelain biscuit, in order to ascertain the colour of their streak, frequently yield a black powder at first, the characteristic brown tint appearing only when a considerable portion of the whole has been rubbed off. At Ihlefeld Manganite is associated with calcareous spar, and heavy-spar, particularly with the latter. The specimens analyzed, which likewise have yielded Figs. 5, to 10, described above, were found at Ihlefeld, and were brought by Dr TURNER from Germany. The same species occurs in gneiss, occasionally traversing it in small irregular veins and mixed with quartz, at Granam in Aberdeenshire. It is found likewise at Christiansand in Norway, and Undenaes in Westrogothia in Sweden. A massive variety of manganite, consisting of small spicular crystals with many drusy interstices, is found in Nova Scotia.

II. PYRAMIDAL MANGANESE-ORE.

Hausmannite.

Blaettricher Schwarz-Braunstein, *Hausmann*, p. 293.

Foliated Black Manganese-ore, *Jameson*, vol. iii. p. 263.

Black Manganese, *Phillips*, p. 381.

Pyramidales Mangan-erz, *Mohs*, vol. ii. p. 484.

Pyramidal Manganese-ore, *Mohs*, Trans. vol. ii. p. 416. Id. *Haidinger*, Edin. Journ. of Science, vol. iv. p. 46.

Schwarz-Manganerz, *Leonhard*, p. 760.

Fundamental form. Isosceles four-sided pyramid.

$P = 105^{\circ} 25', 117^{\circ} 54'$. Fig. 14.

$$a = \sqrt{2.76}.$$

Simple forms. $\frac{4}{3} P - 4$ (a) = $139^{\circ} 56'$, $57^{\circ} 57'$; $P - 1 = 114^{\circ} 51'$, $99^{\circ} 11'$; P (P).

Char. of comb. pyramidal.

Combinations. 1. $\frac{4}{3} P - 4$. P . Fig. 15.

2. $\frac{4}{3} P - 4$. $P - 1$. P .

Cleavage, $P - \infty$ rather perfect; $P - 1$ and P less distinct, and interrupted. Fracture uneven. Surface, $\frac{4}{3} P - 4$, very smooth and shining, P horizontally streaked, and often dull.

Lustre, imperfect metallic. Colour, brownish-black. Streak, dark-reddish, or chesnut-brown. Opaque.

Hardness = 5.0, 5.5, a little higher than apatite. Sp. gr. = 4.722, of a crystallized variety.

Compound Varieties.—Twin crystals: axis of revolution perpendicular, face of composition parallel to a face of $P - 1$, Fig. 16. The composition is often repeated parallel to all the faces of the pyramid, Fig. 17. Generally small particles only of the surrounding individuals are joined to the central one. Massive: composition granular, firmly connected.

Observations.

Professor HAUSMANN, in compliment to whom Dr TURNER and myself propose to call the present species "*Hausmannite*," ranks so high among the professors of his science, that it must appear much more extraordinary, no species should as yet commemorate his name, than that we should pay this tribute of friendship and respect to that distinguished individual. He has been accustomed in his lectures, subsequent to the publication of his work, to point out the present species as a peculiarly remarkable substance, of a nature not yet exactly ascertained.

It would be superfluous to enlarge here on the propriety of considering it as a species of its own, since, besides Mr MOHS, it

has likewise been established as such by Messrs BROOKE and PHILLIPS, and by the Abbé HAÜY. Even in the works of the Wernerian school, the pyramidal forms had been long ago described, in reference to the identical specimen from which the above description was derived. Count BOURNON* mentions an ore of manganese crystallized in regular octahedrons, having their solid angles replaced by low four-sided pyramids; a form which might be explained upon the supposition, that the variety, Fig. 12., appears in the regular composition represented Fig. 14.; at least it would be necessary to have these varieties compared again with each other, for the purpose of fixing the species to which they belong.

Hausmannite is hitherto confined to the porphyry formation near Ihlefeld in the Hartz. It is found in a vein by itself, as was observed by Professor GUSTAVUS ROSE.

III. UNCLEAVABLE MANGANESE-ORE.

Psilomelane.

Dichter Schwarz-Braunstein, *Hausmann*, p. 295.

Compact and Fibrous Black Manganese-ore, or Black Hematite, *Jameson*, vol. iii. p. 261, 262.

Black Iron-ore, *Phillips*, p. 232.

Untheilbares Mangan-erz, *Mohs*, vol. ii. p. 486.

Uncleavable Manganese-ore, *Mohs*, Trans. vol. ii. p. 418. Id. *Haidinger*, Edin. Journ. of Science, vol. iv. p. 47.

Schwarz-Eisenstein, *Leonhard*, p. 734.

Regular forms and cleavage unknown. Fracture not observable.

* Catalogue, p. 395.

Lustre, imperfect metallic. Colour, bluish-black and greyish black, passing into dark steel-grey. Streak, brownish-black, shining. Opaque.

Brittle. Hardness = 5.0...6.0, between apatite and felspar. Sp. gr. = 4.145, a botryoidal variety.

Compound Varieties.—Reniform, botryoidal, fruticose: composition columnar, impalpable; fracture flat conchoidal, even; in a second composition it is curved lamellar, the faces of composition being smooth, rough or granulated. Massive: composition granular, impalpable, strongly connected; fracture, flat conchoidal, even.

Observations.

The name "*Psilomelane*," from ψιλός, *smooth* or *naked*, and μελάς, *black*, is formed in allusion to the black colour and smooth hematitic shapes of this mineral. It is an almost literal translation into Greek, of one of the names applied to this species, in German, "*Schwarzer Glaskopf*;" the latter, though the orthography should seem to say the contrary, being surely much more expressive of a "*bald head*," than of a "*vitreous head*."

This is a pretty common species, among those containing manganese. The specimen analyzed is from the neighbourhood of Schneeberg in Saxony, and agrees perfectly with the preceding description. It consists of alternating layers, having more or less lustre, disposed in reniform coats. The specific gravity of those portions, which possess a rather stronger lustre, and a conchoidal fracture, is = 4.004, while the specific gravity of those without lustre, and an uneven fracture, was found to be = 4.079.

Psilomelane is one of the most widely diffused ores of manganese. It is usually associated with the prismatic manganese-ore, sometimes in a very curious manner. Both of them occur

in botryoidal, reniform, and stalactitic shapes, frequently alternating with each other in layers of different thickness. Specimens of this kind are found at Knorrenberg in the district of Kirchen, county of Sayn, and other localities of the Westerwald in Prussia, at Schwarzenthal in Bohemia, and at Arzberg in Bayreuth. It happens still more frequently that the two species are less regularly intermingled; or that they are disposed longitudinally, the slender crystalline portions of pyrolusite forming ramifications within the botryoidal and stalactitic masses of psilomelane. Particularly fine examples of this kind occur in the mines of Siebenbrüder and St Johannes, near Langenberg in the mining district of Annaberg in Saxony, also at Conradswaldau and Neukirchen in Silesia. Various places in the western provinces of Prussia are productive of most beautiful claviform, stalactitic and botryoidal specimens of psilomelane, as in the Hollert iron-mines; also in the county of Hanau in Hessa, particularly at Pfaffenseifer and Bieber. It is a very common mineral in the Saxon Erzgebürge, chiefly in the veins of red ironstone, which traverse gneiss; and occurs at Schimmel, and other mines near Johanngeorgenstadt, at Raschau, at Vater Abraham near Scheibenberg, at Spitzgleite near Schneeberg, and others. From one of them, I could not learn which, there are pseudomorphous crystals in the shape of the octahedrons of fluor; they are now in the Royal Museum at Berlin, and were brought there in 1813 by Mr STRÖM. Psilomelane is also found at Reinwege in Gotha and Ilmenau in Weimar, as also in the territory formerly belonging to the Elector of Treves, and in the Upper Palatinate. It occurs at Busau, in the manor of Jessenitz in Moravia, in nodules of limestone, and these varieties in particular have a very strong lustre. It was brought by Mr PARTSCH from Arshitza near Jakobeni in the Bukovina. At Rhoniz in Hungary it is met with in brown hematite. At Vondernberg in Stiria psilomelane was found by Professor RIEPL in a vein traversing the decomposed sparry iron.

At Artzberg in Bayreuth also, it appears as the product of the decomposition of the same substance, covering the surface of the cavities left in quartz by the original rhombohedrons of the species.

The English localities of psilomelane are Restormel and Upton Pine near Exeter in Devonshire, and Cornwall.

IV. BRACHYTYPUS MANGANESE-ORE.

Braunite.

Brachytypous Manganese-ore, *Haidinger*, Edin. Journ. of Science, vol. iv. p. 48.
Brachytypous Manganerz, *Leonhard*, p. 759.

Fundamental form. Isosceles four-sided pyramid. $P = 109^{\circ} 53'$, $108^{\circ} 39'$. Fig. 18.

$$a = \sqrt{1.94}.$$

Simple forms. $P - \infty$ (o); P (P), Wunsiedel, Bayreuth; $P + 2$ (s) = $96^{\circ} 33'$, $140^{\circ} 30'$, Fig. 17., Elgersburg, Thuringia; $(P + 1)^3$ (z) = $144^{\circ} 4'$, $128^{\circ} 17'$, $154^{\circ} 25'$.

Char. of comb. pyramidal.

- Combinations. 1. $P - \infty$. P . Fig. 20., Wunsiedel.
2. P . $P + 2$. Fig. 21., Elgersburg.
3. P . $(P + 1)^3$. Fig. 22., St Marcel, Piedmont.
4. $P - \infty$. P . $P + 2$. Fig. 23., Wunsiedel.

Cleavage, very distinct in the direction of the faces of P ; entire forms of cleavage may be obtained from larger individuals. Fracture uneven. Surface, $P - \infty$, possessing less lustre than P , but even, and sometimes faintly streaked parallel to the edges of combination with P ; P often a little rounded; $P + 2$ uneven, rough and horizontally streaked; the eight-sided pyramid $(P + 1)^3$ smooth and even.

Lustre, imperfect metallic. Colour, dark brownish - black. Streak, of the same colour.

Brittle. Hardness = 6.0...6.5, higher than felspar. Sp. gr. = 4.818, large cleavable individuals from Elgersburg.

Compound Varieties.—Massive; composition granular, individuals strongly coherent.

Observations.

The present species is proposed to be named "*Braunite*," by Dr TURNER and myself, in compliment to our mutual friend CAMMERATH BRAUN of Gotha, a gentleman who has pursued the study of mineralogy with much zeal and success, and to whom Dr TURNER and myself are particularly indebted for a number of specimens of this substance, upon which its mineralogical and chemical examination was founded. From him Dr TURNER obtained, when in Germany, the first variety of the species of brachytypous manganese-ore, which I afterwards had the good fortune to examine. Being struck with the facility with which this mineral yields to cleavage in the direction of the faces of a four-sided pyramid, and supposing it to belong to the species of the pyramidal manganese-ore of MOHS, I requested Dr TURNER'S permission to extract the form of cleavage from it, but was much surprised when I could not discover the single cleavage perpendicular to the axis, which is so very distinct in that mineral, and has been likewise indicated by MESSRS BROOKE and PHILLIPS. Though the mineral cleaves very readily, yet its great hardness, being superior to that of felspar, and a strong connection among the particles, render it extremely difficult to obtain the faces sufficiently smooth and even, to reflect a good image even of a single very luminous spot. I was therefore led to suppose, by several approximate measurements, that the regular octahedron should be considered as the fundamental form of the species,

In some of the cavities of the same specimen there were, however, crystals in the form of acute four-sided pyramids, similar to Fig. 19, which did not agree with the symmetry of tessular forms. They were rough, and possessed little lustre, so that they afforded only indistinct measurements of about 140° for the base of the pyramid. Certain varieties from Wunsiedel, in Bayreuth, in the cabinet of Mr ALLAN, engaged in heavy-spar, and associated with pyrolusite in very delicate columnar composition, possess the form of Figs. 18, 20. and 23. The two first of these I also observed in a specimen, procured from Mr HEULAND, in the collection of Mr FERGUSON of Raith, having the following ticket: "*Hydrous oxide of manganese, in the form of an octahedron, with a square basis. Thuringia—is extinct.*" As HAÜY's works contain the pyramidal manganese-ore of MOHS, under the denomination of *Manganèse oxidé hydraté**, this specimen is probably intended for a variety of that species, which, however, is very inaccurately described by HAÜY, who united under one head the physical properties of one species with the physical and chemical properties of two or three others, to form a general description, to which no object in nature corresponds. I had long ago observed crystals of the form Fig. 22. engaged in a specimen of the *épidote manganèsifère* of HAÜY, in the cabinet of Mr ALLAN, but which I believed likewise to be a variety of Hausmannite. Upon measurement, however, for which the small but beautifully formed and bright crystals of this variety are better suited than any of the rest, these also turned out to belong to a species different from the pyramidal one formerly described. The angles which these crystals afforded are given above as the dimensions of the species. The results obtained from the remaining varieties are not sufficiently consistent to be considered different from these, and as, moreover, the colour of their

* *Traité*, 2de ed. t. iv. p. 264.

streak and their hardness coincide, we may safely consider them as belonging to the same species. Some of the octahedral crystals, quoted by Count BOURNON*, for which he proposes the denomination of *Fer oxydulé manganésien*, must also very likely be referred to the brachytypous manganese-ore. He supposes their form to be derived from the regular octahedron, but does not quote in favour of this opinion any decisive proofs, which are rendered necessary, when a species, nearly resembling the varieties alluded to, is found to have for its fundamental form a four-sided pyramid so little different from the regular octahedron. Those individuals which have their solid angles replaced by four faces, may perhaps belong to Hausmannite, as is mentioned in the observations annexed to that species, which was likewise not distinguished as a species of its own at the period of publication of Count BOURNON'S Catalogue.

Braunite is found, both crystalline and massive, at Oehrenstock near Ilmenau, at Elgersburg, Friedrichsroda, and other places in Thuringia, in veins in porphyry, along with pyrolusite and psilomelane. At Leimbach in the county of Mansfeld it was discovered in octahedral crystals by Professor HOFFMANN of Halle, in cavities of white quartz, which appear to have been filled originally with some other substance. The specimens were collected from the masses which were broken for repairing the roads. It occurs also at St Marcel in Piedmont. The locality of Wunsiedel in Bayreuth, given in Mr ALLAN'S cabinet for the varieties of braunite, Figs. 19, and 21, appears to me exceedingly problematical; since, among a vast number of specimens in various collections, I have not seen any from that place, while the specimens in the cabinet possess the aspect of those derived from the mines of Thuringia.

* Catalogue, p. 395.

V. PRISMATIC MANGANESE-ORE.

Pyrolusite.

Grau Braunstein, in part, *Hausmann*, p. 288. Fasriger Schwarz - Braunstein, Id. p. 293.

Grey Manganese-ore, in part, *Jameson*, vol. iii. p. 252.

Grey Oxide of Manganese, in part, *Phillips*, p. 243.

Mangan-Hyperoxid, *Leonhard*, p. 240.

Form and cleavage probably belonging to the prismatic system; the cleavage taking place in several directions.

Lustre metallic. Colour iron-black; in very delicate columnar compositions the colour becomes bluish, and the lustre imperfect metallic. Streak black. Opaque.

Rather sectile. Hardness = 2.0 . . . 2.5. Sp. gr. = 4.94, a specimen from Elgersburg, and another, locality unknown, = 4.819, according to Dr TURNER.

Compound Varieties.—Reniform coats. Both columnar and granular composition is often met with, particularly the former; the individuals often radiating from common centres. If the individuals are very delicate, the masses will soil the fingers, and write on paper.

Observations.

The name of *Pyrolusite* alludes to a property, for which this mineral is reckoned the most valuable one among the preceding species. It is derived from πῦρ, *fire*, and λούω, *I wash*, being employed, in consequence of the large quantity of oxygen which it emits at a red heat, to free glass from the brown and green tints produced by carbonaceous matter and protoxide of iron. The

manganese of commerce has been for this reason facetiously called by the French *le savon des verriers*, or *le savon du verre*.

There can be no doubt that pyrolusite should form a species of its own, if we only attend to the marked differences in its hardness, strength, &c. from all the rest. As yet, however, its regular forms are unknown. For some time past I have endeavoured to collect specimens either of crystals or cleavable masses of this substance, but have not succeeded in getting any fit for measurement. MR VON LEONHARD kindly communicated to me some crystals from Tiefe Kohlenbach, near Eiserfeld, in the province of Siegen, possessing the form Fig. 24., with uneven surfaces, and yielding a black streak. They form a coating on the reniform shapes of the uncleavable manganese-ore. Professor GUSTAVUS ROSE had obtained a similar specimen from the same source; and by some approximate measurements, but which were far from decisive, we found the inclination of a on a , over the small face b , to be $= 86^{\circ} 20'$. The faces of the horizontal prism d , did not admit of measurement at all. There exists cleavage parallel to a and b , but not very perfect. Among the forms of manganite, there is no prism, parallel to the axis, which even comes near the one here mentioned, though the approximation at the angles be ever so rude; and the crystals may be therefore considered as the actual type of the species of pyrolusite, which is likewise the opinion of Mr ROSE. I have observed crystals of the form of manganite, yielding the characteristic brown streak only in the interior portions of the crystals, while that of the exterior strata is black. This may be the result of one of those changes of substance, the form remaining the same, which are recorded in a preceding part of this volume; it may, however, be also one of those curious instances, where two species, of different forms, enter, as it were, into a regular composition with each other, as in felspar and albite, disthene and staurolite, and others; many of which I have

observed, and propose to give an account of, on some future occasion.

Pyrolusite was found by M. GMELIN to be a superoxide of manganese. In most mineralogical works, the descriptions given of the only species that they contain, is made up of the forms and colour of manganite; and the hardness, streak and colour of pyrolusite.

This is at once the most common species, and the most useful one, on account of the large quantity of oxygen which it contains. It is *the* ore of manganese properly so called, in an economical point of view, and is extensively, though not exclusively, worked for in many countries. The principal mines are the ancient ones of Ilmenau, Friedrichsroda, Reinwege, Elgersburg and other places in Thuringia. Almost every one of the varieties, particularly the compound ones, granular and columnar, are found there, consisting of individuals of all sizes. Here, at Oehrenstock, near Ilmenau, are also found the curious shapes of a parasitic formation, which present even the slightest peculiarities of the crystallizations of calcareous spar as to regular form, but consist of a tissue of crystals of pyrolusite, and engaged in a mass of the same description. From the mines of Ehrendorf near Maelrisch Triebau in Moravia, since their discovery in 1798, many thousand hundred weights of excellent ore are annually procured. At Ehrendorf the pyrolusite occurs in large nodules or masses, I could not learn in what rock. It resembles the Thuringian varieties. In Thuringia it forms veins in porphyry, and is often accompanied with heavy spar. It is remarkable that no pyrolusite should have been found at Ihlefeld in the Hartz; at least there was no trace of it in all those collections which I examined, if we except some thin masses in porphyry, and slender crystals, evidently of the form of manganite, the superficial layers of which yield a black streak, a circumstance which has not yet received a satisfactory explanation.

Pyrolusite is very often the product of decomposition of the brachytypous parachrose-baryte, the carbonate of iron of the latter being converted by the natural agents into the hydrate of the peroxide, while the lime which it occasionally contains is deposited in the shape of calcareous spar or arragonite, and the manganese is often found covering the surface of decomposed rhombohedrons of the original species, in the shape of minute crystals. In this manner it occurs in the mines of decomposed sparry iron in beds in gneiss at Hüttenberg in Carinthia, at Schmalkalden in Hessa, and other places. It is likewise found in this manner in the counties of Sayn, Siegen, Salm and Hamm in Prussia, in the veins of sparry iron traversing clay-slate, which are decomposed in the upper levels, and then contain much brown hematite. The localities are chiefly Friedewald and Knorrenberg in the district of Kirchen, Sayn; Streitberg near the town of Siegen, and Horhausen and Herdorf, Siegen; Berge, Salm; the mine Huth, near Hamm. One of the varieties from Horhausen is particularly remarkable for the delicacy of the fibres, which are disposed in small tufts within the geodes of brown hematite, and which greatly resemble the fibrous varieties of prismatic antimony-glance. There are specimens of it in the imperial cabinet in Vienna, and in that of Mr Von STRUVE in Hamburgh. Weyer in the county Wied-Runkel, Hirschberg near Ahrensberg, and Bendorf on the Lower Rhine, are likewise named as the localities of superb specimens of pyrolusite. Krettnich on the Blies, west of the Rhine, is likewise one of its localities. Similar varieties occur in the iron mines of Bayreuth, as at Armenhülfe near Schnärchenreuth, and at Arzberg, in those of Platten, for instance Hilfe Gottes, and of Schwarzen-thal in Bohemia, in those of Johanngeorgenstadt, Eubenstock, Langenberg and others in Saxony, also at Reinerz in the county of Glatz, and at Conradswaldau in Silesia.

The finest crystals of pyrolusite occur at Schimmel and Oster-

freude near Johannegeorgenstadt, and at Hirschberg in Westphalia. These are chiefly short thick prisms, often resembling Fig. 3. or nearly so, terminating on their extremities in numerous fibres. Large flattish crystals of great beauty, terminating in sharp elongated pyramids, with curved faces, occur at Maeskamezö, near Maggar Lapos, south of Kapnik in Transylvania, in geodes of brown hematite, and associated with crystals of quartz. This variety is found in a thick bed, of no great extent, of brown iron-ore in gneiss. A similar one occurs also in a similar position at Gyalár near Vayda Hunyad in the same country. Cleavable individuals of considerable size are found near Goslar in the Hartz, in a mountain called Gingelsberg near the Ramelsberg. They are imbedded in small veins of quartz and calcareous spar in clay-slate, particularly where they cross each other. Distinct though small crystals are met with in many of the mines in the west of Germany, for instance at Tiefe Kohlenbach in Siegen; still smaller ones were found many years ago in the Palfy iron-mines of Haerethof near Frohstorf in Austria, associated with grey quartz. Very small crystals are found imbedded in and alternating with layers of black wad in Bayreuth. A variety much resembling the German ones, found in similar repositories, occurs at the mine of Antonio Pereira near Villa Ricca in Brazil, along with brown hematite and psilomelane, in beds in clay-slate, produced according to Dr POHL's account, from the decomposition of sparry iron.

Small granular pyrolusite occurs at Skidberget in the parish of Lepand in Dalecarlia, Sweden. But the individuals are often much smaller, and appear in the form of a black sooty substance. Such are frequently found in the iron-mines of Raschau and other places in Saxony, also at Platten and other similar repositories in the north of Bohemia; sometimes they include small globules and reniform masses of red hematite, or red iron-ochre. The same pulverulent oxide occurs also at Schladming in Sti-

ria, at Felsöbanya in Hungary, and at Pütten in Austria. Dr POHL observed several localities of it in Brazil, as at St Toão d'el Rey, with brown hematite; on the road between Anta and S^{ta} Rita, in the capitania of Goyaz, and at Banderinha do Caelho in Minas Geraes. In the latter place it includes numerous reddish nodules, or cylindrical and ramified concretions of indurated clay.

The pyrolusite, as was observed above, is very generally found along with psilomelane. In fact, it is seldom found without it. Another species frequently accompanying it, is the brown hematite, and these two species, like the pyrolusite and psilomelane, are often very curiously associated with each other. At Arzberg in Bayreuth crystals of quartz are found, covered with a stratum of brown hematite, upon which is deposited another distinct stratum of pyrolusite. In some varieties from Berge in the county of Salm, thin stalactites of brown hematite are uniformly covered with a stratum of pyrolusite. The same is found also in masses of larger dimensions at Friedewalde in the county of Sayn, and in these the concentric disposition of the brown and black layers of the two species, visible in the cross fracture, gives the whole a particularly elegant appearance. Pyrolusite occurs in England at Upton Pine, near Exeter, in Devonshire, and in Cornwall.

The *manganèse oxidé noir barytifère* of HAÜY, from Romanèche, near Macon, does not appear to be a simple homogeneous mineral. When examined with the magnifying lens, it exhibits distinctly a compact and a fibrous substance mixed up with each other. The latter, as far as the minuteness of the particles will allow, shews the properties of pyrolusite, its colour and general aspect, and its hardness; for even on the fracture newly obtained, this compound soils the fingers, though on the file the hardness appears as high as 5.0 . . . 5.5, that is, superior to apatite. The

compact mass is aggregated into reniform shapes, which leaves numerous interstices between them. The colour is nearly the same as that of the uncleavable manganese-ore, a bluish or greyish black passing into dark steel-grey. The streak is black, with a slight tinge of brown; the place on the mineral, where it has been examined, becomes shining.

IX. *Chemical Examination of the Oxides of Manganese.* By
 EDWARD TURNER, M. D. F. R. S. E. Professor of Chemistry
 in the University of London, and Fellow of the Royal
 College of Physicians of Edinburgh.

(Read 3d and 17th December 1827.)

IT was originally my intention, in entering on this inquiry, merely to ascertain the composition of the ores, the mineralogical characters of which have been so ably delineated by Mr HAIDINGER in the preceding paper. I had advanced however but a short way in the investigation, when my progress was arrested by doubts both as to the manner of conducting the analyses, and as to the mode of calculating their results. In this uncertainty I found it necessary to extend my original plan, with the view of supplying by my own researches what appeared to be not sufficiently established by the labours of other chemists. I have accordingly divided the essay into two parts; attempting in the first division to ascertain the atomic weight of manganese, and the composition of the artificial oxides of that metal; and in the second, applying the facts thus established to illustrate the chemical constitution of the native oxides described by Mr HAIDINGER.

PART I.

ON THE ATOMIC WEIGHT OF MANGANESE.—ANALYSIS OF THE
 CARBONATE OF MANGANESE.

A pure carbonate of the protoxide of manganese was prepared in the following manner. The dark brown mass left in the process for procuring oxygen gas from the common peroxide of

manganese by heat, was mixed with a sixth of its weight of powdered charcoal, and exposed to a white heat for half an hour. The protoxide thus formed was dissolved by muriatic acid, the solution evaporated to dryness, and the residue kept for some time in a state of fusion at a red heat. The resulting chloride of manganese was re-dissolved by distilled water; and after being filtered, was found to contain no impurity except a little lime, which was separated by the oxalate of potash. The manganese was then precipitated by a solution of the bi-carbonate of potash, and the carbonate of manganese was carefully edulcorated and collected on a filter. After removing the upper layer which had become rather brown by exposure to the air, the white carbonate was kept in a vacuum along with a vessel of sulphuric acid until it became quite dry. The salt thus prepared yielded a colourless solution, without any residue, when put into dilute sulphuric acid, and was therefore free from the red oxide of manganese.

Of this carbonate 8.805 grains were heated to redness in a green glass tube, and the water collected in a tube filled with fragments of the chloride of calcium. The quantity of water procured in this way amounted to 0.742 of a grain, equivalent to 8.427 per cent.

The proportion of carbonic acid was estimated by noting the loss of weight which the carbonate of manganese experiences when dissolved in dilute sulphuric acid. This mode of analysis, as commonly performed, is inaccurate; because the liquid retains carbonic acid in solution, while the gas during effervescence carries off with it an appreciable quantity of watery vapour. But when performed with the precautions which I adopted, it yields uniform results, and is susceptible of great precision. A known quantity of the carbonate is placed in a small glass phial fitted with a tight cork, in which two tubes are inserted. One of these tubes descends to near the bottom of the phial and then bends

slightly upwards, so as to admit of the acid being gradually introduced without affording an exit to the gas. The other communicates with a tube filled with chloride of calcium, over which all the carbonic acid gas passes before escaping into the air. As soon as the effervescence has ceased, the carbonic acid retained by the solution is driven off by causing it to boil during the space of a few minutes; and the gas is by the same means expelled from the interior of the phial, into which on cooling the atmospheric air is admitted by the tube for introducing the sulphuric acid. The carbonic acid gas remaining with the chloride of calcium is replaced by atmospheric air, which is introduced by inhaling at one extremity of the tube while the other is open. The upper part of the tube for introducing the dilute sulphuric acid, when not required to be open, is of course closed with a cork in order to avoid loss by evaporation.

It was found by means of the preceding process that 20.68 grains of the carbonate, when dissolved in dilute sulphuric acid, lose precisely 7.18 grains, or 34.72 per cent of carbonic acid. It is accordingly composed, in 100 parts, of

Protoxide of Manganese	56.853
Carbonic Acid	34.720
Water	8.427
	100.000

Regarding 22 as the equivalent of carbonic acid, we have the following proportions:—As 34.72 : 56.853 :: 22 : 36.024.

According to this analysis, 36 may be safely adopted as the combining proportion of the protoxide of manganese; and presuming the elements of this compound to be in the ratio of one equivalent of oxygen to one equivalent of metallic manganese, 28 will be the equivalent of the latter. This result, with respect

to the acid and base, corresponds exactly with the analysis of Dr THOMSON, as mentioned in his *First Principles of Chemistry*. (vol. ii. p. 350.) It differs considerably from the proportions stated by Dr FORCHHAMMER. (*Annals of Philosophy*, N. S. vol. i. p. 54.) According to this chemist 33.05 parts of carbonic acid combine with 51.755 parts of the protoxide of manganese, a proportion which would fix 34.45 instead of 36 as the equivalent of the protoxide. This estimate is certainly erroneous; and Dr FORCHHAMMER appears to have fallen into the mistake by supposing that the carbonate of manganese is converted by a red heat into the deutoxide, whereas according to my experiments the red oxide chiefly is then generated.

It appears doubtful whether the water found by analysis in the carbonate, after being dried *in vacuo* with sulphuric acid, is mechanically retained by it or is in a state of chemical union. As the proportion is not atomic, it is probable that the carbonate is really anhydrous. If the ratio were as 58 to 4.5 instead of 5.337, the salt might be regarded as a compound of two equivalents of the carbonate of manganese and one equivalent of water.

Composition of the Sulphate of Manganese.

The most recent analyses of the sulphate of manganese are by Dr FORCHHAMMER and Dr THOMSON, described in the works already quoted. Dr FORCHHAMMER precipitated the acid of a known quantity of the neutral sulphate of manganese by the nitrate of baryta, and inferred from the weight of the precipitate, that 100 parts of the sulphate of manganese are composed of 54.378 parts of sulphuric acid and 45.622 of the protoxide. According to this analysis, the atomic weight of the protoxide is 33.56, a number which is surely very far from the truth, and is inconsistent with the equivalent of that oxide derived from Dr FORCHHAMMER'S own analysis of the carbonate.

Dr THOMSON analyzed the sulphate of manganese by mixing

that salt in atomic proportion with the muriate of baryta, and finding that, after the insoluble precipitate had subsided, no trace of sulphuric acid or baryta could be found in the solution. From this experiment he infers that 36 is the equivalent of the protoxide. I am of opinion that the number assigned by Dr THOMSON is correct, but I am not so certain that the means by which he arrived at this conclusion are altogether free from objection. The principle of his method is unexceptionable, especially if the quantity of the precipitated sulphate be carefully observed at the same time; but it is essential to accuracy that the atomic weight of baryta be perfectly established. Dr THOMSON supplied this element in the inquiry in the following manner. He dissolved 88 parts or one equivalent of sulphate of potash, and 106 parts, or what he considered one equivalent, of the chloride of barium in separate portions of distilled water, and then mixed the solutions together. After the precipitate had subsided, the supernatant liquid was found to contain no trace either of sulphuric acid or baryta. It hence follows, if no error is committed, that 70 is the true equivalent of barium. But in a recent number of POGGENDORFF'S *Annalen der Physik und Chemie* (vol. viii. p. 5.), BERZELIUS denies the accuracy of the experiment. He declares that after mixing together the sulphate of potash and chloride of barium in the proportions mentioned by Dr THOMSON, $2\frac{1}{2}$ per cent of the chloride of barium remained in the residual liquid; and on repeating this experiment for my own information, I certainly found that the whole of the baryta was not precipitated. I wish it to be distinctly understood, however, that I do not confidently rely on the accuracy of my result, having been hitherto unable, from want of leisure, to examine the subject with that care which I deem necessary before attempting to decide a point in dispute between chemists, for whose analytical attainments I entertain such high respect. Dr THOMSON will doubtless feel the necessity of verifying his conclusions without delay; since an er-

ror in the atomic weight of barium will at once vitiate an extensive series of his most elaborate analyses. My own observation, however, combined with the remark of BERZELIUS, has induced me in the mean time to secure my own researches as much as possible from any uncertainty respecting the atomic weight of barium, and I have been therefore induced to ascertain the composition of the sulphate of manganese synthetically rather than by analysis.

Nine grains of pure protoxide of manganese, prepared from the red oxide by means of hydrogen gas, were dissolved in dilute sulphuric acid, the solution was slowly evaporated to perfect dryness in a platinum crucible, and the dry salt exposed for half an hour to a red heat. It then weighed 19.01 grains; and regarding the increase in weight as owing to the acid combined with the protoxide, the resulting sulphate must consist of 9 grains of the protoxide of manganese and 10.01 grains of sulphuric acid. The atomic weight of the protoxide indicated by this process, is 35.96. The experiment was repeated with 4.855 grains, and the resulting sulphate weighed 10.26 grains, indicating 35.93 as the equivalent of the protoxide of manganese.

As some chemists may doubt the accuracy of this process, I shall attempt to show the grounds on which its merits are to be estimated. Dr THOMSON says it is scarcely possible to expel all the water from the sulphate by means of heat, without at the same time driving off some of its acid. It is indeed very easy to effect the decomposition alluded to by Dr THOMSON; but I found no difficulty, by slow evaporation and raising the fire gradually, to keep the salt at a red heat for an hour or longer without decomposing a particle of it. If the heat should accidentally become so intense as to decompose a little of the salt, the defect is easily remedied by adding a drop or two of acid, and replacing the crucible in the fire.

Dr FORCHHAMMER has judiciously remarked, that in expelling an excess of sulphuric acid, a portion of the salt is very apt

to be carried off mechanically by the acid vapour and lost. This accident has occurred to myself, and always happens when a large quantity of free acid is rapidly expelled. By employing a slight excess of acid, and raising the heat slowly, all loss from this cause may easily be avoided.

The dry salt obtained in my experiments was white, and dissolved readily and completely in distilled water.

Like many other neutral metallic solutions it reddened delicate litmus paper. It was nevertheless quite neutral; for a single drop of a dilute solution of potash occasioned a precipitate which was not in the slightest degree re-dissolved by agitation.

Analysis of the Chloride of Manganese.

In an excellent paper published in the *Philosophical Transactions* for the year 1812, Dr JOHN DAVY states the chloride of manganese to be composed of 54 parts of chlorine and 46 of metallic manganese. The atomic weight of manganese calculated from these data is 30.67, a number which is considerably beyond the truth. Dr DAVY prepared the chloride by heating the muriate in a glass tube communicating with the atmosphere by a very small aperture. I have never failed by this method to decompose some of the chloride, a circumstance which complicates the analysis, and probably gave rise to Dr DAVY's error.

According to the analysis of M. ARFWEDSON (*Annals of Philosophy*, N. S. vol. vii. p. 274.), the elements of the chloride of manganese are in the ratio of 8403 parts of chlorine to 6677 of manganese. This result, in the accuracy of which M. ARFWEDSON does not place implicit confidence, would fix the equivalent of manganese at 28.61. He prepared the chloride by placing the carbonate of manganese in a spherical cavity blown in a barometer tube, transmitted over it a current of muriatic acid gas, and heated the carbonate by means of a spirit-lamp as soon as

the atmospheric air was expelled from the tube. As it is difficult by this, as well as by Dr DAVY'S process, to procure a perfectly pure chloride of manganese, I had recourse to the following method. A solution of the muriate of manganese was evaporated to dryness, the heat being carefully regulated so as not to decompose any of the salt, and the dry compound was placed in a spherical cavity in the middle of a barometer tube about six inches long. Muriatic acid gas was then transmitted through the tube, and heat applied by the flame of a spirit-lamp. The chloride entered into perfect fusion at a low red heat, and on cooling yielded a highly crystalline lamellated mass of a beautiful pink colour. Every trace of acid and moisture was expelled by heat; and while the tube was still hot, its extremities were closed by corks, so that the chloride might be weighed without attracting moisture from the air. In the sense above explained it was quite neutral. Of this chloride 12.47 grains were dissolved in distilled water, and formed a colourless solution without any residue. The muriatic acid was thrown down by the nitrate of silver, and yielded 28.42 grains of the fused chloride of silver, equivalent to 7.008 grains of chlorine. Consequently the chloride of manganese consists of

Manganese	5.462	28.06
Chlorine	7.008	36

It follows from the preceding researches, that 28 is the true atomic weight of metallic manganese, and 36 the equivalent of that oxide of manganese which forms definite compounds with acids, and which I regard as the real protoxide of the metal. It is consequently composed of 28 parts of manganese and 8 parts of oxygen. These numbers agree with the atomic weight of manganese as stated by Dr THOMSON, but not with that given by BERZELIUS, who fixes it at 28.463. This estimate is made from an analysis of M. ARFWEDSON, who finds that the deutoxide of

manganese is composed of 100 parts of the metal and 42·16 parts of oxygen ; but it will appear from the sequel of this paper that the real quantity of oxygen united with 100 parts of manganese to constitute the deutoxide is 42·857 and not 42·16 as ARFWEDSON supposes.

On the Protoxide of Manganese.

By this term I mean the salifiable base of manganese, the only oxide of the metal which appears to me capable of forming regular salts with acids. I am of opinion that in this compound manganese is in its lowest degree of oxidation. The existence of the sub-oxides described by BERZELIUS and Dr JOHN of Berlin has never been satisfactorily demonstrated ; and I have reason to suspect that one or other of them would in some of my experiments have been generated, did there exist any tendency to their formation.

The protoxide may be formed, as was shewn by M. BERTHIER in the 20th volume of the *Annales de Chimie et de Physique*, by exposing the peroxide, deutoxide, or red oxide of manganese to the combined agency of charcoal and a white heat ; and Dr FORCHHAMMER has in the *Annals of Philosophy* described an elegant method of preparing it by means of hydrogen gas at a red heat. ARFWEDSON has likewise had recourse to this method, and I have employed it very extensively during the course of the present investigation. The mode of performing the experiment is as follows. The material for yielding the protoxide was either the red oxide, deutoxide, or peroxide of manganese ; and, occasionally, the carbonate was used. When it was wished to employ a red heat only, the material was placed in a small tray of platinum foil, which was introduced into a tube of green glass, through which the hydrogen gas was transmitted. The heat was applied by means of a pan of burning charcoal. To pre-

vent the tube from bending while softened by the heat, two or three pieces of tobacco-pipe were tied to it longitudinally by means of iron-wire. But when it was wished to prepare the oxide at a very high temperature, the material was put into a small tube of porcelain, and then introduced into a gun-barrel which was exposed to a full white heat in a common wind-furnace. A supply of hydrogen gas was procured in the usual manner from zinc and dilute sulphuric acid ; but before coming in contact with the oxide of manganese, it was purified by being transmitted through a strong solution of potash, and then dried by the chloride of calcium. At the close of the process, the protoxide was of course preserved in an atmosphere of hydrogen gas until it was quite cold.

The abstraction of oxygen commences at a temperature below that of redness ; and when the peroxide is employed, it becomes red hot by the caloric evolved during the formation of water, considerably before the tray which supports it is rendered luminous by the heat of the fire. It appears nevertheless from all my experiments that a strong heat is requisite in order to convert all the red oxide into the protoxide. When the process is conducted at a low red heat, I uniformly found that on putting the product into dilute sulphuric acid, which instantly dissolved all the protoxide, a portion of the red oxide came into view. This affords a sure criterion of the operation being complete ; for the pure protoxide dissolves without residue in dilute sulphuric acid, and yields with it a perfectly colourless solution. There seems to be no risk of decomposing the protoxide by the employment of a high temperature. I have exposed the recently prepared protoxide a second time to the action of hydrogen gas and a long continued bright red heat without the weight being changed in the slightest degree ; and after exposure to the same gas and a full white heat for an hour, it dissolves in dilute sulphuric acid without the slightest effervescence.

The protoxide of manganese is described by FORCHHAMMER as being of a beautiful light-green, and by ARFWEDSON as of a pistachio-green colour. I have seen specimens with a tint very near the pistachio-green, but these always contained an admixture of red oxide. The colour of the pure protoxide is very near the mountain-green.

With respect to the action of air, my observations differ from those of FORCHHAMMER who found that recently prepared protoxide attracted oxygen from the atmosphere before he could weigh it. The protoxide procured in my experiments is far more permanent. I exposed fifteen grains of recently prepared protoxide to the free action of the air during the space of nineteen days, when it was found to have undergone no change either in appearance or weight. If, therefore, it does attract oxygen at all from the air, the operation must proceed very tardily. It absorbs oxygen very slowly even at a temperature of 400° F.; for 7.269 grains of the protoxide, after an hour's exposure to that degree of heat, did not gain in weight more than 0.021 of a grain. At a temperature of 600° F. it absorbs oxygen much more rapidly; and at a low red heat it loses its green tint, and becomes almost black in an instant. I have repeated this process frequently, but in no case did the protoxide take fire, as occurred in the experiments of FORCHHAMMER and ARFWEDSON. I entirely agree with M. ARFWEDSON, however, in the statement, that the protoxide is converted, by simultaneous exposure to heat and air, into the red oxide. This is the uniform result at whatever temperature the oxidation is effected.

I have already mentioned my opinion, that, of the oxides of manganese, the protoxide is the only one which forms definite compounds with acids. It unites readily with this class of bodies, without effervescence, producing with them the same salt which is formed when the same acids act on the carbonate of manganese. When it comes in contact with concentrated sul-

phuric acid, an intense heat is instantly evolved; and the same phenomenon is produced, though in a less degree, by strong muriatic acid. This oxide is likewise the base of the salts which are formed when sulphuric or muriatic acid is heated with the peroxide, deutoxide, or red oxide of manganese. As the accuracy of this statement, as respects sulphuric acid, has been denied by an acute chemist and good observer, I have been induced to examine the question with considerable care. I mentioned in my *Elements of Chemistry*, in explaining the process for procuring oxygen gas by means of sulphuric acid and the black oxide of manganese, that the peroxide loses a whole proportion of oxygen, and is converted into the protoxide, which unites with the acid, forming a sulphate of the protoxide of manganese. The gentleman who has done me the honour to review that work in the *Annals of Philosophy*, I apprehend Mr RICHARD PHILLIPS, has made the following remark on the preceding passage. "This statement is at variance with both Dr THOMSON'S and also with the results of our experiments; for we find that 44 or one atom of peroxide of manganese yield 4.2 of oxygen, which is so much nearer 4 than 8, that there is no question but that the deutoxide, and not the protoxide is obtained by the action of sulphuric acid; that this is the case is farther proved by the deep red colour of the solution of the sulphate, and by its losing that colour, as stated by Dr THOMSON, when mixed with sulphurous or nitrous acid."

To decide this point between the reviewer and myself, it is only necessary to heat the peroxide of manganese with concentrated sulphuric acid, so as to form a solution highly charged with the oxide of manganese, and decant off the solution while hot from the undecomposed peroxide. The liquid on cooling deposits a perfectly white salt, which possesses every property of the protosulphate of manganese. If the acid, which retains an amethyst-tint even when cold, be again heated, the red colour

speedily disappears; because the red oxide, which is dissolved in small quantity by the sulphuric acid, is then also converted into the protoxide with the evolution of oxygen gas. The red colour disappears gradually even without the aid of heat; for the solution will be found after a few days to be almost and sometimes quite colourless, while a minute quantity of red oxide has subsided to the bottom. On applying a very gentle heat, the red oxide is redissolved, and the acid acquires a lively amethyst-red colour. It is easy, by operating in this way, to obtain satisfactory proof, that a minute portion of red oxide suffices to communicate a rich colour to a considerable quantity of sulphuric acid. The acid may be made to retain its red colour, either by diluting it with water, or by keeping it in contact with undissolved oxide.

On the Red Oxide.

I have followed the usage of most chemists in applying the term *Red Oxide* to that compound which ARFWEDSON has described under the name of *Oxidum Manganoso-manganicum*, (*Annals of Philosophy*, N. S. vii. 267), and which is uniformly produced when the nitrate, peroxide, or deutoxide of manganese is exposed to a white heat. In my early experiments on this oxide, I entertained considerable doubt as to the uniformity of its composition. This opinion originated in the remark, that, on exposing the peroxide of manganese to a white heat, the quantity of oxygen lost by different portions of it, though agreeing perfectly in some experiments, differed widely in others; and that, on one occasion, I procured the green oxide almost in a state of purity. I subsequently discovered, however, that the disagreement in the results was occasioned by the want of a free current of air within the furnace. In some of the experiments the draft was unguardedly cut off, and consequently an atmosphere of

carbonic oxide gas, collecting around the heated manganese, reduced it more or less nearly to the state of protoxide. On avoiding this source of fallacy, the results were no longer discordant; and I am now quite satisfied that the red oxide formed at a white heat and with free exposure to atmospheric air, is uniform in its composition. The accuracy of this inference is established by the occurrence of the red oxide in nature, as will appear in the sequel of the present communication.

The red oxide, when formed at a white heat and rubbed in a mortar to the same degree of fineness, is always of a brownish-red colour when cold, and nearly black while warm. The powder of the native red oxide has a reddish-brown tint, and the colour of the red oxide prepared by exposing the precipitated protoxide or the carbonate to a moderate red heat, has most commonly an admixture of yellow, something like rhubarb, though of a deeper hue; but both of these acquire the red colour when heated to whiteness.

The red oxide manifests little tendency to pass into a higher degree of oxidation by abstracting oxygen from the atmosphere, even by the aid of heat. Thus a portion of the red oxide, preserved for an hour at a low red heat, and freely exposed to the air at the same time, did not acquire any appreciable addition to its weight. The protoxide of manganese precipitated from the sulphate by an excess of pure potash, collected on a filter and washed, fully exposed to the air in its moist state for twenty-four hours, and then heated in an open vessel to a moderate red heat, which was insufficient to decompose the deutoxide, lost only 0.218 per cent by subsequent exposure to a white heat. The quantity of deutoxide present, therefore, must have been very minute. The anhydrous protoxide, as already mentioned, always yields the pure red oxide when heated to redness in the open air. The carbonate, also, in similar circumstances, is con-

verted into a red oxide containing but a very small proportion of the deutoxide. It will appear from these experiments that it is unsafe in analyses to heat the precipitated protoxide or carbonate to redness, and consider the product as the deutoxide; a practice which is calculated to lead analytical chemists into considerable errors, and indeed has actually done so. If it is wished to procure the deutoxide, the precipitate should be moistened with nitric acid, and then exposed to heat.

I have endeavoured to ascertain the composition of the red oxide by several methods. The first is by the combined agency of heat and hydrogen gas. In the first experiments 100 parts of pure red oxide, in being thus converted into the protoxide, lost 6.802 and 6.817 parts of oxygen; but as the resulting green oxide, when put into dilute sulphuric acid, was found to contain a little red oxide, the loss in oxygen must be rather below the truth. To avoid this error I exposed 44.256 grains of red oxide to hydrogen gas and a white heat for the space of one hour, when the loss amounted to 3.153 grains or 7.125 per cent.

Judging by the increase in weight which the protoxide acquires when heated in the open air, 100 parts of the red oxide consist of 93.05 parts of protoxide and 6.95 of oxygen. According to a similar experiment made by ARFWEDSON, the red oxide is composed of 93.153 protoxide and 6.847 parts of oxygen.

In an analysis already described, the carbonate of manganese was found to contain 56.853 per cent of the protoxide of manganese. When 100 parts of the same carbonate are exposed to air and a white heat, 61.18 parts of red oxide are obtained. From these data it may easily be calculated that the red oxide consists of 92.927 parts of protoxide, and 7.073 of oxygen.

As a mean of the numbers afforded by these three methods, it follows that the red oxide is composed of 92.951 parts of the green oxide and 7.049 of oxygen, or of 72.291 parts of metallic

manganese and 27.709 of oxygen. According to M. BERTHIER,* who reduced the red oxide to the metallic state by means of charcoal and a long continued intense heat, the oxygen is only 26.6 per cent. But this estimate, as M. BERTHIER himself suspects, certainly renders the quantity of oxygen too small; for though, guided by theoretical views, I am disposed to consider my own number not rigidly exact, yet from the care with which the experiments were made, I am satisfied their result cannot be far from the truth.

From this proportion of manganese and oxygen, we may consider the red oxide a compound either of 80 parts or two equivalents of the deutoxide and 36 or one equivalent of the protoxide, as M. ARFWEDSON supposes, or of 44 parts or one equivalent of the peroxide and 72 or two equivalents of the protoxide of manganese. If, on either of these suppositions, the composition of the red oxide in 100 parts be calculated, it will be found to consist of 93.104 parts of the protoxide and 6.896 of oxygen, or of 72.414 parts of metallic manganese and 27.586 of oxygen. These numbers approximate closely to those furnished by my experiments, and may serve perhaps to correct them.

The red oxide of manganese, when agitated with strong sulphuric acid, is dissolved in minute quantity, without appreciable disengagement of oxygen gas, and the solution is promoted by a slight increase of temperature. If the resulting liquid be separated from undissolved oxide, and exposed to heat, its amethyst-red tint quickly disappears, and the protosulphate of manganese is generated. When the red oxide is briskly heated with sulphuric acid, the protosulphate is formed, and oxygen gas evolved with effervescence.

On boiling the red oxide with an excess of very dilute sulphuric acid (in the proportion, for example, of two measured

* *Annales de Chimie et de Physique*, vol. xx.

drachms of strong acid to five ounces of water), a colourless solution of the protosulphate is obtained; while a portion of peroxide is left, the quantity of which corresponds to the atomic view just given; that is, 116 parts of the red oxide yield 44 parts of the peroxide of manganese.

When the red oxide is mixed with strong muriatic acid, a portion of it is almost instantly dissolved, and communicates a deep red colour to the liquid. But the solution is not permanent. The odour of chlorine is perceptible from the beginning, even at a temperature of zero of Fahrenheit; the disengagement of that gas continues slowly, though without distinct effervescence, until in a few days the solution, if separated from undissolved oxide, becomes quite colourless. The red oxide dissolves in hot muriatic acid with effervescence, owing to the evolution of chlorine.

On the Deutoxide.

This oxide is prepared by exposing the nitrate or peroxide of manganese for a considerable time to a rather low red heat. I have found great difficulty in procuring it artificially in a pure state. After exposing the peroxide for an hour or longer to a moderate red heat, the residue frequently contains too much oxygen for constituting the deutoxide; and on augmenting the temperature slightly, the loss in oxygen is very apt to become excessive. The result is so much influenced by slight differences of temperature, that I do not feel confident in inferring the existence of the deutoxide from such researches. That there is such a compound, however, is demonstrated by its occurring in two different states in the mineral kingdom. My experiments as to its composition, as will afterwards appear, agree with the statement of **BERZELIUS**, **ARFWEDSON**, and **THOMSON**.

It is intermediate between the protoxide and peroxide, consisting of 28 parts or one equivalent of manganese, and 12 parts or one equivalent and a half of oxygen; or rather, to be consistent with the atomic theory, of two equivalents of the former to three of the latter. Its elements, it is obvious, are in such proportion, that it may be regarded as a compound of 44 parts or one equivalent of the peroxide, and 36 parts or one equivalent of the protoxide of manganese; and into these it may be resolved by being boiled in dilute sulphuric acid.

The colour of the deutoxide of manganese varies with the source from which it is derived. That which is procured by heat from the native peroxide or the hydrated deutoxide, has a brown tint; but when prepared from the nitrate of manganese it is almost as black as the peroxide itself, and the native deutoxide is of the same colour.

On heating a mixture of the deutoxide of manganese and concentrated sulphuric acid, oxygen gas is evolved with effervescence, and the protosulphate is generated. In the cold the acid acts upon it slowly, and acquires an amethyst-red colour; but this effect does not take place so readily as with the red oxide. The solution is attended with the disengagement of a little oxygen, a circumstance from which it may be inferred that a portion of deutoxide is resolved into oxygen and the red oxide, and that the latter, on being dissolved, is the cause of the red colour. ARFWEDSON represents the deutoxide as yielding a deep grass-green coloured solution with sulphuric acid; but I have never been able to observe this phenomenon.

Strong muriatic acid acts upon the deutoxide in the same manner as on the red oxide of manganese, excepting that the acid acquires the deep red tint more rapidly with the latter than when the former is employed. It is hence probable that the red colour is really communicated by the red oxide.

Peroxide of Manganese.

To procure a pure peroxide of manganese, a solution of the protonitrate was evaporated to dryness, and the heat continued until the whole of the salt was converted into a uniform black mass. It was then reduced to fine powder, carefully washed with distilled water, and dried by exposure for several hours to a temperature of 600° F. On heating a portion of this peroxide to redness in a glass tube, a little moisture was expelled, which reddened litmus paper powerfully. Consequently the peroxide still retained a little nitric or nitrous acid, which I found it impossible to expel entirely, except by the employment of a temperature bordering on a commencing red heat. The peroxide, after exposure to that degree of heat, was quite free from acid, but still retained a trace of moisture. On exposure to a white heat it lost only 10.82 per cent of oxygen, whereas had the peroxide been pure, it should have yielded 12.122 per cent. It appears therefore that the heat required to expel the last portions of the nitric acid, decomposes some of the oxide itself; and this circumstance induced me not to rely on the analysis of the artificial peroxide of manganese.

From my examination of the native peroxide of manganese, I conclude with all other chemists who have of late years studied the oxides of manganese, that it contains twice as much oxygen as the protoxide. It is accordingly composed of 28 parts or one equivalent of manganese, and 16 parts or two equivalents of oxygen; and in being converted by a white heat into the red oxide, it should yield 12.122 per cent of oxygen gas.

Sulphuric acid acts very feebly on the peroxide of manganese. At first I could observe no action at all; but on employing a considerable quantity of the oxide, and agitating the mixture frequently, the acid after an interval of two or three days ac-

quired an amethyst-red tint, a minute quantity of oxygen gas being at the same time disengaged. The nature of the change which is produced when sulphuric acid is heated with the peroxide of manganese, has already been discussed.

Muriatic acid, as is well known, acts upon the peroxide of manganese at common temperatures, chlorine gas being disengaged with effervescence. If heat and an excess of acid be employed, a colourless muriate of the protoxide is procured; but in the cold, or if the oxide be in excess, in addition to the protomuriate, a deep red coloured solution is formed, similar to that already mentioned in the description of the red oxide.

PART II.

ON THE COMPOSITION OF THE ORES OF MANGANESE DESCRIBED
BY MR HAIDINGER.

Method of Analysis.

PURE fragments of the ores were carefully selected, reduced to fine powder in a mortar of agate, and washed with distilled water. Some of the ores yielded nothing to the action of water; but from some of them, especially from those of Ihlefeld, minute quantities of the muriate and sulphate of lime, and sometimes of soda, were separated by the action of water. It is the accidental presence of the muriates which gives rise to the disengagement of chlorine when sulphuric acid is added to some of the native oxides of manganese, and which induced Mr MACMULLIN to regard chloric acid as a constituent of these ores. For the correction of this error we are indebted to Mr RICHARD PHILLIPS,*

* Philosophical Magazine and Annals, vol. i. p. 313.

with whose observation my own experiments correspond;—none of the native oxides yield a trace of chlorine on the addition of sulphuric acid, provided the muriates have been previously removed by washing.

The ores, before being submitted to analysis, were dried at 212° F., by which means they were brought to the same degree of dryness which they possessed before being washed. The water naturally contained in them was ascertained in every instance by heating a known quantity of the ore to redness, and collecting the water in a tube filled with fragments of the chloride of calcium.

The quantity of oxygen was in most cases ascertained both by bringing the ore to the state of red oxide by exposure to a white heat, and by converting it into the protoxide by means of heat and hydrogen gas. When performed with the precautions stated in the first part of this communication, either of these methods may be relied on with confidence; but the first is more convenient in general practice, because it requires less time and a more simple apparatus. The latter is sometimes very troublesome, owing to the difficulty with which some of the ores of manganese, the native peroxide for example, are reduced by hydrogen to the state of pure protoxide. I have in no instance estimated the quantity of oxygen by means of the deutoxide, the formation of this compound being in my opinion too uncertain to admit of any analytic process being founded upon it.

In searching for the presence of foreign matters I have employed the following processes. The water which was expelled from the ores by heat, was examined with test paper, but was always found quite free from alkaline or acid reaction. The absence of carbonates was ascertained by the entire want of effervescence on the addition of dilute nitric acid. Strong sulphuric acid did not cause the evolution of chlorine or any acid fumes.

On dissolving the ores in muriatic acid and evaporating the solution to perfect dryness, the residue, with the exception of a little siliceous matter and red oxide of manganese proceeding from slight decomposition of the chloride, was always completely redissolved by water. This circumstance demonstrates the absence of phosphoric and arsenic acids, which, if present, would have been left as the insoluble phosphate or arseniate of manganese. By well known methods I satisfied myself of the absence of sulphuric acid, alumina, and magnesia. In several of the ores the oxalate of ammonia detected a trace of lime. It is remarkable that every species, with one exception, contains baryta. In most of them, indeed, it is present only as an impurity; but in two of the ores, the uncleavable manganese-ore or black hematite, and the *manganèse oxidé noir barytifère* of HAÜY, it is an essential ingredient of the mixture. In those species in which this earth exists as an impurity, it is not united with the sulphuric or carbonic acid; but is most probably combined with the peroxide of manganese.

From the frequency with which iron has been found accompanying the ores of manganese, I was led to expect its presence, and employed the ferrocyanate of potash and hydrosulphuret of ammonia as re-agents for its detection. The muriatic solution of the different species yielded a white precipitate with the ferrocyanate of potash, and the characteristic flesh-coloured sulphuret of manganese with the hydrosulphuret of ammonia. It hence follows that all the ores submitted to analysis, even the uncleavable manganese-ore, which has been placed among the ores of iron, are perfectly free from iron, as well as from copper, lead, and similar metallic substances.

Analysis of Manganite or the Prismatic Manganese-ore.

This ore, even when selected with the greatest care, yields to distilled water traces of the muriates and sulphates of lime and soda. It dissolves without residue in muriatic acid, and is free from siliceous earth, lime, baryta, and every other impurity. It is the purest native oxide of manganese which has fallen under my notice. Its powder has a uniform brown tint, and I have been unable to observe in it any tendency to pass into the peroxide by absorbing oxygen from the air. After exposure to the air for six months, during which it was frequently moistened with distilled water, it underwent no change of weight. Cold sulphuric acid acts very feebly on this oxide. M. GMELIN * of Heidelberg states that it is not dissolved at all by this acid in the cold, and I was at first of the same opinion; but by employing a considerable quantity of the oxide, and agitating the mixture frequently, the acid does acquire a red tint in the course of two or three days. In this respect manganite agrees with the peroxide; but differs from all the other species, which communicate a red colour to cold sulphuric acid with much greater facility.

When manganite is heated to redness it gives out 10.10 per cent of water; and the total loss from exposure to a white heat is 13.15 per cent. Deducting from the last number the amount of water, 3.05 remain as the loss in oxygen. The result of this analysis is therefore,

* I regret that I have been unable to obtain a sight of that volume of the *Zeitschrift der Mineralogie*, which contains M. Gmelin's paper on the composition of the oxides of manganese. My knowledge of his labours is solely derived from M. Leonhard's *Handbuch der Oryktognosie*.

Red oxide . . .	86.85
Oxygen . . .	3.05
Water . . .	10.10
	<hr/>
	100.00.

According to this analysis, manganite contains an oxide of manganese, 89.9 parts of which yield 3.05 of oxygen, on being converted into the red oxide. An equal quantity of pure deutoxide, in undergoing a similar change, should lose 2.997 of oxygen.

Exposed to a strong red heat and a current of hydrogen gas, 100 parts of manganite lost 19.09 parts in one experiment, and 19.07 in another. The mean is 19.08, and subtracting 10.10 as water, 8.98 remain as oxygen. According to this analysis the manganite is composed of

Protoxide . . .	80.92
Oxygen . . .	8.98
Water . . .	10.10
	<hr/>
	100.00

Now as 80.92 : 8.98 :: 36 : 3.995.

From the result of both analyses it is apparent that manganite, in relation to manganese and oxygen, is a deutoxide.

Also as 89.90 : 10.10 :: 40 : 4.494.

The fourth number is so near 4.5, half an equivalent of water, that we may safely regard manganite as a compound of 80 parts or two equivalents of the deutoxide of manganese, and 9 parts or one equivalent of water.

The material for the preceding analysis was taken from a very fine crystallized specimen from Ihlefeld. The result of GME-LIN'S analysis of the same variety is as follows:—Red oxide 87.1, oxygen 3.4, water 9.5. The water is here certainly under-rated.

The grey oxide from Undenaes in West Gothland, analyzed by ARFWEDSON, is a similar compound.

Analysis of the Brachytypous Manganese-ore or Braunite.

The colour of this ore, both in mass and in powder, is nearly black. With sulphuric acid it yields no distinct odour of chlorine. It dissolves in muriatic acid, leaving a trace of siliceous matter. The solution gives a precipitate of sulphate of baryta with sulphuric acid, but does not contain any other impurity. Of all the native oxides this is the most easily reduced to the state of protoxide by the action of hydrogen gas. The material for analysis formed part of a specimen from Elgersburg.

As a mean of two closely corresponding experiments, this oxide contains 0.949 per cent of water.

To ascertain the quantity of oxygen, 16.634 grains were exposed for half an hour to the action of hydrogen gas at a red heat. The residue weighed 14.837 grains, and had the light green tint of the protoxide. The total loss was 1.797 grains, or 10.80 per cent; and subtracting 0.949 for water, there remains 9.851 per cent as the loss in oxygen.

The baryta was precipitated by sulphuric acid from a solution in muriatic acid of 42.09 grains of the mineral. The precipitate after being heated to redness amounted to 1.44 grains, equivalent to 0.951 of a grain or 2.26 per cent of pure baryta.

According to this analysis, 100 parts of the ore contain

Protoxide	86.94
Oxygen	9.851
Water	0.949
Baryta	2.260
Silica	a trace.
	<hr/>
	100.000

Now $86.94 : 9.851 :: 36 : 4.079$; and as the presence of water and baryta, from the small quantity of these substances, must be regarded rather as accidental than essential to the mixture, it follows that Braunite is an anhydrous deutoxide of manganese. I apprehend the baryta must be in combination with deutoxide of manganese; since, were it united with peroxide, the loss in oxygen would exceed the quantity above stated.

I am not acquainted with any analysis of this mineral by other chemists.

Analysis of the Pyramidal Manganese-ore or Hausmannite.

Hausmannite, before being washed, yields a faint odour of chlorine by the action of sulphuric acid. When heated to redness it gives off 0.435 per cent of water; and at a white heat the loss is only 0.65 per cent, indicating 0.215 of oxygen. When dissolved in muriatic acid, a small quantity of silica is left, amounting to 0.337 per cent; and on adding sulphuric acid to the solution, a little sulphate of baryta subsides, indicating 0.111 per cent of the pure earth. Hausmannite is accordingly resolved by this analysis into

Red oxide	98.098
Oxygen	0.215
Water	0.435
Baryta	0.111
Silica	0.337
	100.000

This oxide is manifestly an anhydrous red oxide of manganese. The small quantity of oxygen lost at a white heat is probably owing to the admixture of a little deutoxide or peroxide, combined with the baryta.

From some preliminary experiments on Hausmannite M. GMELIN of Heidelberg* inferred that it is a pretty pure red oxide, an inference which entirely agrees with the result of the preceding analysis. This is the only chemical examination of Hausmannite by other chemists, which I have met with. The material for my analysis was part of a specimen from Ihlefeld, for which I am indebted to the kindness of Professor STROMMEYER.

Analysis of Pyrolusite, or the Prismatic Manganese-ore.

The following analysis was made with a compact columnar variety from Elgersburg, which has a specific gravity of 4.94, and the individuals of which have a parallel direction. With sulphuric acid it does not yield a trace of chlorine; and the only impurities which I could discover in it are silica and baryta, the former amounting to 0.513, and the latter to 0.532 per cent.

* LEONHARD'S *Handbuch der Oryktognosie.*

The quantity of water was determined as usual by means of the chloride of calcium, and amounted to 1.12 per cent.

On exposing 23.746 grains of this oxide to a white heat, the loss proved to be 3.064 grains or 12.90 per cent. Subtracting 1.12 for water, there remain 11.78 as the loss of oxygen.

Accordingly, 100 parts of the Pyrolusite were resolved into

Red oxide	84.055
Oxygen	11.78
Water	1.12
Baryta	0.582
Silica	0.513
	100.000

Now, omitting the water, baryta, and silica as accidental impurities, the remaining 97.835 parts lose 11.78 parts, or 12.04 per cent of oxygen in being converted into the red oxide. On the supposition that Pyrolusite is composed of one equivalent of manganese and two equivalents of oxygen, it should lose in passing into the state of red oxide exactly 12.122 per cent of oxygen, a quantity which corresponds closely with the result of analysis. It is therefore an anhydrous peroxide of manganese.

I have analysed another columnar variety of Pyrolusite, which has a density of 4.819, and of which the individuals radiate from a common centre. I brought it with me from Germany, and believed it to be from Ihlefeld, as the ticket indicated; but Mr HAIDINGER, after carefully inspecting several large cabinets in Germany, has been unable to discover any similar specimen which is known to have been found in that place. Its locality therefore is doubtful.

This variety is less pure than the foregoing. Before being washed, it yields chlorine on the addition of sulphuric acid; and

after the muriates have been removed by distilled water, the neutral solution in muriatic acid gives traces of lime with oxalate of potash. It contains silica and baryta nearly in the same proportion as the first variety.

The following is the result of my analysis :

Red oxide	85·617
Oxygen	11·599
Water	1·566
Silica	0·553
Baryta	0·665
Lime	a trace
	100·000

Subtracting 2·784 as impurities, there remain 97·214 parts, which lose 11·599, or 11·931 per cent, of oxygen in being converted into the red oxide. It is therefore an anhydrous peroxide, most probably containing an admixture of some other oxide.

Analysis of Psilomelane, or the Uncleavable Manganese-ore.

This mineral when reduced to powder has a brownish-black colour. With sulphuric acid it does not emit any odour of chlorine. It dissolves completely in muriatic acid, excepting a small quantity of silica which amounts to 0·26 per cent ; and the only substances which I could detect in the solution are baryta and the oxide of manganese. Though this ore has been placed by mineralogists among the oxides of iron, under the names of Black Hematite and Black Iron-ore, pure fragments of it do not contain a trace of that metal.

When heated to redness Psilomelane gives out 6.216 per cent of water. The diminution in weight occasioned by exposure to a white heat is 13.58 per cent ; and on subtracting 6.216 for water, there remains 7.364 as the loss in oxygen.

To ascertain the quantity of baryta 30.028 grains of the mineral were dissolved in muriatic acid, and the baryta precipitated by means of the sulphate of soda, a considerable excess of muriatic acid being allowed to remain in the liquid, to prevent any manganese from adhering to the precipitate. The sulphate of baryta, after exposure to a red heat, amounted to 7.434 grains, equivalent, according to the atomic numbers of Dr THOMSON, to 4.914 grains, or 16.365 per cent of pure baryta.

According to this analysis, 100 parts of Psilomelane have yielded of

Red oxide	69.795
Oxygen	7.364
Baryta	16.365
Silica	0.260
Water	6.216
	<hr/>
	100.000

The precise atomic constitution of Psilomelane is not made apparent by this analysis ; and, indeed, the result is of such a nature as to leave no doubt of this mineral containing more than one oxide of manganese. For it follows, from the quantity of oxygen expelled by heat, that a considerable part of the manganese must be in the form of peroxide ; but it is equally clear that the whole of it cannot be in that state, because 69.795 parts of red oxide require 9.627 instead of 7.364 parts of oxygen to constitute the peroxide. On perceiving this deficiency of oxygen, I at first suspected that the baryta might prevent the usual

quantity of oxygen from being expelled from the peroxide by heat. Accordingly I ascertained the quantity of pure red oxide by the way of precipitation ; but its amount corresponded closely with the number already stated. Psilomelane must therefore, I conceive, be a mixed mineral. I was at first disposed to regard it as a compound of baryta and peroxide of manganese, accidentally containing an admixture of some other oxide in a lower stage of oxidation ; but the fact noticed by Mr HAIDINGER of Psilomelane being frequently and intimately associated with Pyrolusite in the mineral kingdom, appears to justify the inference, that the uncleavable manganese-ore consists essentially of some compound, in proportions not yet ascertained, of baryta and the deutoxide of manganese, and that Pyrolusite is the accidental ingredient. The propriety of this view is further shown by an analysis of the following ore from Romanèche, a mineral which is analogous to Psilomelane in the proportion of its ingredients, and in which an admixture of Pyrolusite may be detected by the eye.

Analysis of the Manganèse oxidé noir Barytifère from Romanèche.

The observations of Mr HAIDINGER leave no doubt of this ore being a mixed mineral ; and according to my analysis it is very analogous to Psilomelane. The specific gravity of some of the purest fragments which I could select, is 4.365 ; and the density of Psilomelane, according to Mr HAIDINGER, is 4.145. The colour of both minerals is similar.

The black oxide of Romanèche yields a very faint odour of chlorine with sulphuric acid. When heated to redness it gives out 4.13 per cent of water. At a white heat it loses 11.39 per cent ; and after subtracting 4.13 for water, there remain 7.26 as the loss in oxygen.

In order to ascertain the quantity of baryta, 32.13 grains were dissolved in muriatic acid; and after separating a small portion of silica, which amounted to 0.953 per cent, I precipitated the baryta by means of the sulphate of soda. The insoluble sulphate, after exposure to a red heat, weighed 8.113 grains, equivalent to 5.363 grains, or 16.69 per cent of pure baryta.

100 parts of the oxide are accordingly resolved into

Red oxide	70.967
Oxygen	7.260
Baryta	16.690
Silica	0.953
Water	4.130
	<hr/>
	100.000

This mineral was analyzed some years ago by VAUQUELIN and DOLOMIEU; but the numbers which they have mentioned, owing to the insufficient mode of analysis employed at that time, are not entitled to any confidence.—(Journal des Mines IX. 778.)

X. *An Account of the Formation of ALCOATES, Definite Compounds of Salts and Alcohol analogous to the Hydrates.* By THOMAS GRAHAM, Esq. M. A.

(Read 17th December 1827.)

IN determining the solubility of salts and other bodies in alcohol, it is desirable to operate with a spirit wholly free from water. But anhydrous or absolute alcohol is formed with difficulty, even by the most improved process—that of RICHTER. In rectifying alcohol from chloride of calcium, as recommended by RICHTER, I have never obtained it under the specific gravity 0.798 at the temperature of 60°, by a single distillation; but upon rectifying this product again from new chloride of calcium, I generally succeeded in reducing it to 0.796, which is the specific gravity of the standard alcohol of that chemist. The following experiment illustrates this process.

Four measures of alcohol of the specific gravity 0.826 were poured into a retort, and a quantity of well dried chloride of calcium, amounting to three-fourths of the weight of the alcohol, gradually added with occasional agitation. Much of the salt was dissolved with the evolution of heat; and the combination was promoted by boiling the whole for a few minutes, the vapour being condensed in the neck of the retort, and returned to the solution. A receiver was then adjusted to the mouth of the retort, and the distillation conducted so slowly that the alcohol was condensed entirely in the neck of the retort, and fell drop by drop into the receiver,—nearly two seconds elapsing between the fall of each drop. The first measure of alcohol which came

over was of the specific gravity 0.800, at 60°; the second measure, 0.798; and the third measure, 0.801: the distillation was then discontinued. These three measures were mixed together, and subjected to a second distillation, which was conducted in the same manner; and two measures of alcohol obtained of the specific gravity 0.796. It was found that farther rectification did not reduce the specific weight of the alcohol below 0.796. From the analysis of alcohol by SAUSSURE, and the determination of the specific weight of its vapour by GAY LUSSAC, there can be little doubt that the alcohol thus obtained is perfectly anhydrous. It is true that such alcohol still contains oxygen and hydrogen to the amount of an atomic proportion of water; but this proportion of oxygen and hydrogen is essential to the constitution of alcohol,—the partial abstraction of it converting alcohol into ether, and its total abstraction converting alcohol into olefiant gas; while the supposition that the oxygen and hydrogen exist in the state of water, is altogether gratuitous.

The process of RICHTER is exceedingly tedious, from the necessity of conducting it so slowly, and the waste of alcohol is considerable. I tried newly burnt quicklime instead of chloride of calcium, and distilled by the heat of a saline water-bath. If it is merely our object to obtain alcohol perfectly free from water, no process could be more effectual. The product was of the specific gravity 0.794; but it contained a trace of ether, to which the extraordinary lowness of its specific gravity is attributable; and had an empyreumatic odour, notwithstanding the moderate temperature at which the distillation was conducted. This likewise is a very slow process.

The process which I preferred is founded on the principle of Mr LESLIE'S frigorific apparatus. The alcohol is concentrated by being placed under the receiver of an air-pump, with quicklime. A large shallow basin is covered to a small depth with recently burnt lime in coarse powder, and a smaller basin con-

taining three or four ounces of commercial alcohol is made to rest upon the lime: the whole is placed upon the plate of an air-pump, and covered over by a low receiver. Exhaustion is continued till the alcohol evinces signs of ebullition, but no farther. Of the mingled vapours of alcohol and water which now fill the receiver, the quicklime is capable of combining with the aqueous vapour only, which is therefore quickly withdrawn, while the alcohol vapour is unaffected. But as water, unless it has an atmosphere of its own vapour above it, cannot remain in the alcohol, more aqueous vapour rises. This vapour is likewise absorbed, and the process goes on till the whole water in the alcohol is withdrawn. Several days are always required for this purpose, and in winter a longer time than in summer. The following cases exhibit the rate, according to which the water is withdrawn. The first experiment was made in summer. Four ounces of alcohol of the specific gravity 0.827 were concentrated. The specific gravity was taken every twenty-four hours, and the following series of results obtained:

0.827
 0.817
 0.808
 0.802
 0.798
 0.796.

In this case the whole water was withdrawn in five days, but occasionally a period somewhat longer is required, although it rarely exceeds a week. In winter the alcohol generally requires to be exposed to the lime for a day or two longer than in summer. The following rate of concentration was observed in one case in winter, the quantity of alcohol and other circumstances being the same as in the former experiment:

0.825

0.817

0.809

0.804

0.799

0.797

0.796.

Quicklime, as a porous substance, appears to be capable of condensing a small portion of alcohol vapour. It is therefore improper to use it in great excess. In one case, in which three pounds of quicklime were employed with four ounces of alcohol, about one-sixth of the alcohol was lost from this absorption. The quicklime should never exceed three times the weight of the alcohol, otherwise the quantity of alcohol absorbed becomes sensible. It should be spread over as great a surface within the receiver as possible.

In RICHTER'S process it is improper to operate upon more than a few ounces of alcohol at a time; as when a large quantity of materials is introduced into the retort, the heat necessary to disengage the alcohol in the centre of the mass inevitably expels the water left in the chloride of lime, at the points where it is more exposed to the heat. In the air-pump also, only a few ounces can in general be concentrated at a time. But in a tall receiver, two or three shallow basins of quicklime can be supported at a little height above each other, each of them containing a small basin of alcohol resting in it. Or the process might be conducted with facility on the large scale, by means of a tight box of any size, furnished with numerous shelves, which might be covered with quicklime in powder, and support a large number of basins of alcohol. The box might be sufficiently exhausted of air by means of a syringe, for it is not necessary that the exhaustion be nearly complete; and indeed more inconvenience

is to be apprehended from a complete than from an imperfect exhaustion. After producing the exhaustion, no farther attention would be necessary; and upon opening the box at the expiration of a week or ten days, the alcohol would be found anhydrous. It is evident that absolute alcohol, procured by this process, could be sold at a price but little exceeding its original cost. It would moreover be of much greater value for the purposes for which it is employed in the arts and medicine. I believe, however, that, by the excise laws as they at present exist, no rectifier of spirits is permitted to concentrate alcohol beyond a certain strength. Licensed apothecaries alone are allowed to prepare and sell absolute alcohol.*

Alcohol may be concentrated in a close vessel with quicklime, without exhausting; but the process goes on much more slowly, at least at the temperature of the air. The experiment was tried at a high temperature, by heating in a water-bath a large bottle with a very wide mouth, containing a quantity of alcohol at the bottom, and quicklime suspended over it in a linen-bag. When the water-bath attained the temperature of 150° , the bottle was corked, and the bath prevented from becoming hotter. Much of the lime was very quickly converted into hydrate, and the alcohol considerably concentrated. But the process is troublesome, and much inferior to that in which the air-pump is employed.

In the place of quicklime, sulphuric acid cannot be substituted in the foregoing process as an absorbing liquid, from a remark-

* Care should be taken that the temperature be nearly equable during the experiment; otherwise, when the atmosphere becomes cold, a condensation of alcohol vapour takes place upon the cooled bell-glass, which runs down upon the plate of the pump. The experiment, therefore, should not be performed in a room with a fire, or near a window, but in a dark closet or press. From the manner in which I performed the experiment, this condensation had never been experienced by myself; but Dr DUNCAN *junior* observed it, on repeating the process.

able property which it possesses. It is capable of absorbing the vapour of absolute alcohol, in the same manner as it absorbs the vapour of water. I was led to make this observation from a consideration of the phenomena which attend the mixing of alcohol and sulphuric acid. Nearly as much heat is evolved as if water had been added to the acid, even although absolute alcohol be employed. Alcohol is also retained by the acid when heated to 500° or 600° , or at a temperature when the alcohol would be decidedly in the state of vapour,—which indicates the possibility of the same relation between sulphuric acid and alcohol vapour, that subsists between water and those gases which it detains in the liquid state, such as ammoniacal gas, when they would naturally assume the elastic form. But besides merely *detaining* such gases, water can condense and absorb them. Sulphuric acid, besides merely detaining alcohol vapour, might therefore condense and absorb it.

As alcohol, like water, occasions cold by its evaporation, it may be substituted for water in Mr LESLIE'S frigorific apparatus, sulphuric acid being retained as the absorbing liquid. In circumstances precisely similar, it was found that a thermometer, the bulb of which was covered with cotton, fell to 7° when moistened with water, but when moistened with absolute alcohol its temperature fell to -24° . Continuance of the pumping during the experiment, as is done in the case of ether, had a prejudicial effect. But alcohol diluted with a third of water was found to have as great a cooling power as absolute alcohol. The advantage to be derived from the great volatility of alcohol appears to be counterbalanced in part by the small latent heat of its vapour. Probably a mixture of alcohol and water, in certain proportions, would produce the greatest degree of cold attainable by this process. Sulphuric acid loses its power to absorb alcohol vapour by being diluted with water. When impregnated with alcohol vapour, the acid becomes of a pink colour; but no appreciable

quantity of gas is emitted at the temperature of the atmosphere, even in the vacuum of an air-pump.

From one experiment, water appears to have the power to induce the evaporation of alcohol by absorbing its vapour, as sulphuric acid does, but much more feebly. Two cups, one containing alcohol and the other pure water, were enclosed together in a tin canister which was nearly air-tight, and set aside in a quiet place for six weeks. The cups were not in contact, but a little apart from each other. At the expiration of that period it was found, on opening the canister, that the cup which originally contained pure water, now contained a mixture of water and alcohol, while the alcohol remaining in the other cup was of diminished strength. PROFESSOR LESLIE informs me, that he performed a similar experiment a considerable time ago, although no account of it was published. But the absorption of alcohol-vapour by water is so feeble as not to occasion a sensible reduction of temperature in the alcohol.

Chloride of calcium is disqualified as an absorbent of aqueous vapour in the purification of alcohol, for the same reason as sulphuric acid. I find that chloride of calcium absorbs the vapour of absolute alcohol, and runs into a liquid, or it *deliquesces* in alcohol-vapour. A small quantity of this substance was suspended in a little capsule, at the height of two inches above a quantity of absolute alcohol, in a close vessel. In the course of twenty-four hours it was entirely resolved into a liquid, just as if it had been suspended over water. The liquid proved to be a solution of chloride of calcium in absolute alcohol. The experiment was frequently repeated. As salts which deliquesce from the absorption of aqueous vapour are always capable of forming hydrates, I was led from the observation of this fact to attempt the formation of analogous compounds of alcohol and salts,—to which I now proceed.

These solid compounds of salts and alcohol, which are definite and imperfectly crystallizable, may be denominated *Alco-ates*,—a designation which is not unexceptionable, but appeared to me preferable to the name *Vinate*, as there is a sulpho-vinous acid, or to any other name that might have been imposed upon them.

The alcoates which I succeeded in forming are not numerous. They were formed simply by dissolving the salts, previously rendered anhydrous, in absolute alcohol, with the assistance of heat. On cooling, the alcoates were deposited in the solid state. The crystallization was generally confused, but in some cases crystalline forms appeared of a singular description. The crystals are transparent, decidedly soft, and easily fusible by heat in their alcohol of crystallization, which is generally considerable, amounting in one instance to nearly three-fourths of the weight of the crystals.

1. *Alcoate of Chloride of Calcium.*

Pure muriate of lime was dried as much as possible on a sand-bath of the temperature of 600° or 700° , and then slowly heated to redness, and retained for some time at that temperature. The dry chloride of calcium thus obtained dissolves in absolute alcohol at 60° with great facility, and with the production of much heat, sometimes occasioning the boiling of the solution. The quantity of chloride taken up increases with the temperature; and at 173° , the boiling point of alcohol, 10 parts alcohol dissolve 7 parts chloride of calcium. This solution is thick and viscid, but perfectly transparent, provided the chloride be pure. It boils at 195° , alcoholic as well as aqueous solutions boiling at higher temperatures than the pure liquids. The viscosity of the solution of chloride of calcium increases greatly as it cools. Bright crystalline stars soon appear on the surface and on the

sides of the vessel, which have been moistened by the solution. The solution, however strong, never crystallizes instantaneously, but gradually, in thin transparent and colourless plates, the forms of which cannot be made out, except on the surface of the solution and sides of the vessel.—To obtain the alcoate in a state of absolute purity, it is necessary to form a solution so weak, that, while hot, it will pass through thin filtering paper; and afterwards to concentrate the filtered solution by heat. A solution of one part chloride of calcium in five parts alcohol passes through the filter. It is remarkable that the most distinct crystalline forms are not obtained from the slow crystallization of comparatively weak solutions; but in solutions which have been fully saturated, or nearly so, at the boiling temperature. In the former case, the crystalline plates are large, but confused, and nothing but angles can be made out; while in the latter, the forms, under which the plates appear on the surface of the solution, and to the greater advantage, on the sides of the vessel, are generally distinct. These plates are always small, often beautiful, and delicately striated; and they always present the form of isosceles triangles. In general, four of these triangular figures are grouped with their apices together; and if similar, they form a square. But, as more frequently happens, the opposite pairs of triangles only are similar; and the figure presented is a rectangular parallelogram; divided by two diagonal lines into four triangles. The resolution of the rectangle into triangular figures is rendered perceptible by the discontinuance of the striæ, and the formation of clear diagonal lines, which have a beautiful effect. These crystals cannot be removed from the phial in which they are formed without injury, from their softness. Exposed to the air, they speedily deliquesce from the absorption of hygrometric moisture. The heat of the hand is sufficient to melt them. The whole of the alcohol is expelled by a heat amount-

ing to 250°, and pure chloride of calcium remains, which emits nothing else upon being heated to redness.

A quantity of this alcoate was dried, first by strong pressure between many folds of linen, and then by pressure between folds of blotting paper. The alcoate, carefully dried in this way, had a white appearance much resembling bleached wax, and was soft, but without tenacity.

Ten grains were heated in a glass capsule, till the whole alcohol was driven off. There remained 4.1 grains chloride of calcium. The atomic weight of chloride of calcium is 7, and that of alcohol 2.875. In the alcoate, 4.1 grains chloride of calcium were combined with 5.9 grains alcohol.

$$4.1 : 5.9 :: 7 : 10.0731.$$

In a second analysis, in which 20 grains of alcoate were employed, the result was precisely similar, as 8.2 grains chloride of calcium remained, which is just double what was obtained in the previous case from half the quantity of alcoate. If this alcoate should be considered a compound of one equivalent proportion of chloride of calcium, and three and a half proportions alcohol, the alcohol would amount to 10.0625, which approaches very nearly to the experimental results. But it would be better to express the composition of the alcoate thus :

Two atoms chloride of calcium,	14.
Seven atoms alcohol,	20.125
	<hr style="width: 10%; margin: 0 auto;"/>
	34.125

In the solution of chloride of calcium, no crystallization takes place at the temperature of 50°, when the alcohol exceeds the proportion of 10 parts to 4 parts of the dry salt. But the solu-

tion crystallizes readily when farther concentrated. A solution saturated at 170° , and which consisted of 10 parts alcohol and 7 parts chloride of calcium, or nearly the atomic proportions of the alcoate, crystallized slowly upon cooling, forming crystals upon the surface of the liquid and sides of the phial, of great regularity and beauty. The whole crystallized during a cold night, leaving no mother liquor whatever.

The injurious effect of the presence of water, in the formation of this alcoate, was evident in alcohol of the specific gravity 0.798, in which the contaminating water did not amount to 1 per cent. A solution of chloride of calcium in alcohol of this strength did not crystallize readily, and the crystals eventually deposited were small and ill formed. Chloride of calcium does not crystallize at all in alcohol of the specific gravity 0.827. The same inconvenience arises from employing chloride of calcium containing a little water.

Although the alcoate of chloride of calcium in a state of purity is entirely decomposed at a temperature not exceeding 250° , yet, when water is present, alcohol can be retained by the chloride of calcium at a much higher temperature. Thus I repeatedly found, that chloride of calcium, from which alcohol had been rectified, and which afterwards had been washed out the retort by water, gave indications of the presence of alcohol, after being exposed on the sand-bath to a heat of 400° or 500° for several hours. Transferred in a crucible to the fire, after it ceased to lose weight on the sand-bath, alcohol-vapour was emitted, which took fire and burned.

2. *Alcoate of Nitrate of Magnesia.*

It is difficult to expel the whole of the water with which nitrate of magnesia is combined, without driving off a portion of

the acid, and decomposing the salt. For this salt may be wholly reduced in a glass-tube by the heat of a spirit-lamp, and yet a sand-bath heat of 600° or 700° is not sufficient to drive off all its water of crystallization. But a partial decomposition of this salt is of no great consequence, as alcohol dissolves the undecomposed portion of the salt, while the magnesia resulting from the decomposition precipitates, and may be separated by decanting the solution, or by filtering.

Four parts alcohol at 60° dissolve one part nitrate of magnesia, and boiling alcohol dissolves more than half its weight of this salt. From the great difference between the solubility of this salt at high and low temperatures, the alcoate is obtained with facility. A hot solution, containing a greater proportion of nitrate than one part to three parts alcohol, became, upon cooling, an irregular dry mass, which could be indented by the point of a glass-rod, but was much harder than the alcoate of chloride of calcium. In solutions considerably weaker crystals were deposited on cooling, which sometimes resembled the crystals of the former alcoate, but were much smaller, and less distinct; but more frequently, the crystals were exceedingly minute, and detached, without any regular form which could be discerned. But the great mass of crystalline matter precipitated in scales of a pearly lustre and whiteness, but apparently made up of the small crystals.

Dried by pressure, in blotting paper, this alcoate much resembled the alcoate of chloride of calcium in external characters. It sank in water, but floated on the surface of a saline solution of the specific gravity 1.1. Heated, it melted readily; boiled, and much alcohol was given off. When boiled violently, red fumes rise with the alcohol-vapour; but when dried slowly, no loss of acid takes place.

Upon cautiously heating 13.4 grains alcoate of nitrate of magnesia to dryness, there remained 3.56 grains nitrate of magnesia.

This gives 9.84 alcohol to 3.56 nitrate of magnesia. But the atomic weight of anhydrous nitrate of magnesia is 9.25. Now,

$$3.56 : 9.84 :: 9.25 : 25.57.$$

In another case, 16 grains alcoate were reduced to 4.2 grains. This gives 11.8 grains alcohol to 4.2 grains nitrate of magnesia.

$$4.2 : 11.8 :: 9.25 : 25.99.$$

On the supposition that this alcoate consists of one atom nitrate of magnesia united with nine atoms alcohol, the alcohol should amount to 25.875, a number intermediate between the two results. This alcoate will be thus represented :

One atom nitrate of magnesia,	.	9.25
Nine atoms alcohol,	25.875
		35.125

3. *Alcoate of the Nitrate of Lime.*

Nitrate of lime may be obtained anhydrous with much greater facility than nitrate of magnesia, as, after being dried on the sand-bath, it may be heated in a glass-capsule by the spirit-lamp without decomposition, although it partially fuses. Boiling alcohol saturated with this salt formed a solution, which became very viscid on cooling, and remained without crystallizing for a whole day. But during a frosty night it was resolved into an amorphous solid, slightly moist, but without any appearance of crystallization. This substance was carefully dried in the usual way.

14.8 grains were reduced by heat to 8.8 grains. This gives 6 grains alcohol to 8.8 grains nitrate of lime. The atomic weight of anhydrous nitrate of lime is 10.25. Now,

$$8.8 : 6 :: 10.25 : 6.98.$$

In another case, 15.6 grains were reduced to 9.2, which gives 6.4 alcohol to 9.2 nitrate of lime. But,

$$9.2 : 6.4 :: 10.25 : 7.13.$$

This approaches 7.1875, or two and a half equivalent proportions of alcohol. The composition of the alcoate of nitrate of lime would be represented on this view, by

Two atoms nitrate of lime,	20.5
Five atoms alcohol,	14.375
	34.875

In another strong alcoholic solution of nitrate of lime, a few irregular crystals were deposited, but the quantity was not sufficient to admit of examination, although they proved that this alcoate is capable of crystallizing.

4. *Alcoate of Protochloride of Manganese.*

The protochloride of manganese, dried in a glass-tube, at a red heat, was light, friable, and of a reddish colour. Alcohol dissolved a very large quantity of it. When the solution was made at a high temperature, the alcoate crystallized readily upon cool-

ing in plates with ragged edges. 14.6 grains of this alcoate, carefully dried by pressure in blotting paper, were reduced by heat to 7 grains. The alcoate, therefore, consisted of 7 grains protochloride of manganese, and 7.6 grains alcohol. The atomic weight of protochloride of manganese is 8. Now,

$$7 : 7.6 :: 8 : 8.686.$$

This slightly exceeds three atoms alcohol = 8.625, but the approximation to the theoretical number is as close as could be expected. The composition of this alcoate may therefore be expressed by

One atom protochloride of manganese,	. 8.
Three atoms alcohol,	8.625
	16.625.

5. *Alcoate of Chloride of Zinc.*

Alcohol dissolves chloride of zinc with great facility, and the solution when filtered is of a light amber colour. This solution may be concentrated to a very great extent without injury, and becomes so viscid when cold, that it may be inverted without flowing perceptibly. It is not till so concentrated that it begins to deposit crystals, which are small and independent, but apparently of no regular shape. A viscid solution, in which crystals formed, was found to be composed 20 parts chloride of zinc, and 7 parts alcohol. The small proportion of alcohol is astonishing; yet no more alcohol was given out when the chloride was heated nearly to redness, and began to volatilize; nor did a portion of the chloride thus heated take fire when exposed directly to the flame of a candle.

The crystalline matter was dried with difficulty by pressure in blotting paper. When dry, it possessed the usual waxy softness of the alcoates, and was of a yellowish colour. Heated, it entered into a state of semifusion, and gave off its alcohol. Nine grains alcoate were reduced by the application of sufficient heat to 7.65 grains. Hence the alcoate consisted of 7.65 chloride of zinc, and 1.35 alcohol. But the atomic weight of chloride of zinc is 8.75.

$$7.65 : 1.35 : : 8.75 : 1.544.$$

1.544 slightly exceeds 1.4375, or half an atomic proportion of alcohol. It is probable that the excess was owing to the difficulty of freeing the alcoate completely from the viscid solution. According to this view, the alcoate of zinc consists of

Two atoms chloride of zinc, . . .	17.5
One atom alcohol,	2.875
	20.375

Besides these alcoates, similar compounds of chloride of magnesium and of protochloride of iron and alcohol were formed, although in quantities too minute to enable me to ascertain their proportions. Alcohol is retained with great force by chloride of iron, and is partially decomposed when heated, as is the case with many metallic chlorides.

As I had it only in my power to present the fixed alkalies to absolute alcohol in the state of hydrates, no alcoate appeared to be formed. The same was the case with the vegetable acids soluble in alcohol.

It is probable that many more alcoates of salts may be formed, particularly of the metallic chlorides. The great obstacle to

their formation is the difficulty, and frequently the impossibility, of rendering the salts perfectly anhydrous, before their solution in alcohol is attempted.

I am not aware of any other compounds in the solid form of the same class as the hydrates and alcoates. But there is an oxide, classed by Dr THOMSON in his *System of Chemistry*, with water and other neutral and unalifiable oxides, the habits of which with certain salts are exceedingly remarkable, and have been looked upon as anomalous, but on which the established properties of hydrates and alcoates appear to me to throw some light. I refer to the deutoxide of azote or nitrous gas. 100 volumes pure water are capable of absorbing only 5 volumes of this gas, according to the experiments of Dr HENRY. But Dr PRIESTLEY and Sir H. DAVY ascertained that certain metallic salts, particularly the protosalts of iron, are capable of absorbing this gas in large quantities; and again emit the greater part of it unaltered, on being heated. That the absorption of deutoxide of azote by these salts, is not dependent upon the oxygen of their bases, or the water which they contain, I have proved in two ways, in the case of protomuriate of iron. By heating this salt to redness in a glass-tube, it is reduced to the state of protochloride of iron. Now, I find that this chloride in the dry state absorbs deutoxide of azote, although in a comparatively small proportion. And the alcoholic solution of the chloride, where neither oxygen nor water interferes, appears to exceed the aqueous solution of the protomuriate in its capacity for deutoxide of azote.

Deutoxide of azote, formed by the action of dilute nitric acid on copper, was conducted into a globular receiver surrounded by cold water, and thence through a glass-tube of two feet in

length, filled with small fragments of chloride of calcium. Thus dried, the deutoxide of azote was passed slowly over carefully prepared protochloride of iron in the state of powder, and contained in a glass-tube of small diameter. The protochloride immediately became darker in colour; and upon being withdrawn, after exposure to the current of gas for some time, was found to retain the smell of nitrous gas, and to have increased in weight. In one case, 30 grains chloride had increased to 31.1 grains; and in another case, 25 grains chloride to 25.5 grains. On being gently heated, the deutoxide of azote was evolved, and the chloride restored to its former colour.

The solution of protochloride of iron in absolute alcohol, absorbed a much greater quantity of deutoxide of azote, and became nearly black. A solution saturated with gas began to boil at 100° , evolving gas in great abundance, which, being collected in the pneumatic trough, proved to be pure deutoxide of azote. The greater part of the gas was expelled before the alcohol rose to its boiling point, and after the solution was in the state of ebullition for a few seconds gas ceased to rise, and the alcoholic solution recovered its original colour, which was generally a chocolate-brown, from the presence of a little bichloride of iron. The quantity of gas evolved from a solution of one part protochloride of iron in five parts absolute alcohol, amounted to 23 times the volume of the alcohol.

I think it probable that the absorption of deutoxide of azote by protochloride of iron, is analogous to the absorption of alcoholic and aqueous vapours by the same body. For I find that protochloride of iron absorbs alcohol-vapour as well as the vapour of water. The absorption of deutoxide of azote may depend upon a tendency of chloride of iron to *deliquesce* in like manner, in an atmosphere of that neutral oxide. At a very low temperature, which it is perhaps out of our power to reach, protochloride of iron would probably absorb this gas in sufficient

quantity to exhibit the appearance of deliquescence, and might form with it a neutral compound, similar to its alcoate or hydrate.

A reason can also be given for the superiority of the aqueous and alcoholic solutions of this chloride over the dry chloride itself, in absorbing deutoxide of azote. We formerly saw that the alcohol of the alcoate of chloride of calcium was completely expelled by a heat of 250°, when no water was present; but that, when a considerable quantity of water was present, alcohol was retained by that chloride at the temperature of 400° or 500°. Now, chloride of iron might be enabled to retain deutoxide of azote more powerfully, by the assistance of alcohol or water, in the same manner. But the *retaining* power we have formerly found in a similar case to be an index of the *absorbing* power. Hence solutions of protochloride of iron might absorb deutoxide of azote more powerfully than the chloride itself.

XI. *An Account of the Tracks and Footmarks of Animals found impressed on Sandstone in the Quarry of Corncockle Muir, in Dumfriesshire.* By the Rev. HENRY DUNCAN, D.D. Minister of Ruthwell.

(Read January 7. 1828.)

THE sandstone quarry of Corncockle Muir is situated between the rivers Annan and Kinnel, about a mile and half above their confluence, and not quite three miles from the town of Lochmaben in Dumfriesshire. It is near the top of a low, round-backed hill, which stretches about half a mile in a westerly direction, almost in the line of the rivers. This hill rises out of a valley of irregular surface, terminated, at the distance of some miles, on the north and north-west, by a mountainous range of transition rock; on the south by an arm of the same range; and on the east, at a greater distance, by lower elevations, consisting, according to Professor JAMESON*, partly of floetz-trap and partly of the independent coal-formation. The valley itself is said by the same authority to be of the independent coal-formation, lying on the transition rock, and contains considerable quantities of sandstone interspersed in various parts, and stretching as far as the bottom of the mountains.

The sandstone of which the quarry in question is composed is, like most other sandstone in the county, of a reddish-brown colour, and is believed to be what is called in England the *new red sandstone*. Its texture is friable, and its strata of very un-

* In his Mineralogical Survey of Dumfriesshire.





Drawings from Chest #21.

Manuscript Library, Be n

equal thickness. It lies in the direction of the greater part of the sandstone of the district, which is from west-north-west to east-south-east, with its dip southerly at an angle of 38° .

The remarkable phenomenon which I am now about to describe as existing in this quarry, is that of numerous impressions, frequently distinct and well defined, bearing, both in their shape and in their position with relation to each other, so close a resemblance to the foot-prints of quadrupeds, as to leave no doubt respecting their identity, which have been found by the workmen on the surface of certain strata, when the superincumbent layers have been removed in the progress of quarrying. This fact, so extraordinary, and I believe *unique*, has not hitherto attracted the share of public attention which it deserves, and indeed has not as yet been noticed in any scientific work, though it is fifteen or sixteen years since the discovery was first made.

The casts and specimens which accompany this will convey an accurate idea of the nature of the impressions; but it may be necessary to mention, that considerably greater variety than I have yet been able to procure, has been observed, not only in their dimensions, but shape, the magnitude varying from the size of a hare's paw to that of a foal's hoof.

Description of the accompanying Casts.

No. I. represents part of a slab *, formerly in the possession of Mr CARRUTHERS of Dormont, who procured it about four years ago from the quarry, and is now built into a summer-house in the garden belonging to the manse of Ruthwell. On the slab, which is 5 feet 2 inches in length, there are twenty-four continuous

* The accompanying engraving (Plate VIII.) is taken from the cast No. 1, and is on a reduced scale.

impressions of feet, forming a regular track, which make twelve of the right feet and as many of the left, being of course six repetitions of the mark of each foot. The impressions of what I take to be the fore-feet, are a little more than two inches in diameter, both from claw to heel and across; and those made by what appear to be the hind-feet are of much the same size, but somewhat differently shaped. The marks of five claws are discernible in each fore-foot, the three in front being particularly distinct. The three front claws of the hind-foot may also be plainly traced, and are placed nearer to each other than those on the fore-foot. There has obviously been no division in the sole of the foot, as is the case in the canine and feline species, as well as in some other quadrupeds; but a gentle convexity of surface may be observed, especially in the fore-paw, occasioned chiefly perhaps, by the act of sinking in the wet sand. The depth of the strongest impression is about half an inch, and it is observable that, in this specimen, the fore-feet have made somewhat deeper marks than those behind,—a fact which may either indicate a considerable length in the animal's neck, or the more than ordinary weight of its head and shoulders; for had it not been for one or other of these circumstances, the chief pressure would have been thrown on its hinder paws; because the surface up which it appears to have been moving was of considerable steepness.

The distance from the claw of the hind-foot to the heel of the nearest impression of the fore-foot on the same side, varies from an inch to an inch and a half. This, however, merely marks the position of the two feet when the hinder one was brought forward in moving; and if we would ascertain the animal's step, that is, the length between the hind and fore foot when the former was thrown back and the latter advanced*, we

* It is not meant that the quadruped has actually been in this position; for the hind-foot would of course be moved forward before the fore-foot was lifted.

must measure from the hind-foot forward to the second impression of the fore-foot on the same side. Now, this gives a distance of between 13 and 14 inches, which is considerably more, however, than would have been the case had the animal been standing still. If we compare this with the distance between the line of the right and left feet (which is as to the fore-feet nearly $6\frac{1}{2}$ inches, and as to the hind-feet something more than $7\frac{1}{2}$ inches), we shall see that an extraordinary thickness of the animal's body in proportion to its length, is clearly indicated.

No. 2. is a cast from another slab of sandstone, which was taken from the quarry under my own eye, and which is also fixed in the wall of the summer-house at Ruthwell Manse. It contains the track of a smaller quadruped, perhaps a variety of the same species; for in some respects a resemblance may be traced. In both of them the sole of the foot is undivided; and in both, a more than ordinary thickness of the body, in proportion to its length, is shewn by an unusual distance between the marks of the right and left feet, before as well as behind. In this specimen, however, the latter peculiarity is not proportionally so great as in that of No. 1. nor do the feet appear to have been of a similar shape, except in the circumstance already mentioned; and indeed the relative proportions of the two are far from corresponding throughout. Nor is it less worthy of observation, that although in No. 1, as has already been remarked, the unusual length of the neck, or weight of the head and shoulders, seems to be indicated by the deep sinking of the fore-feet, the very reverse appears in No. 2, the impression of the fore-feet being in this specimen only very slight, while that of the hind-feet is strong and well defined. Whether or not these differences can be accounted for by a difference of age in two animals of the same family, I must leave to more skilful inquirers to determine.

The measurements are as follow :

Breadth of the impressions across the toes,	1½ inch.
Length of the step, as above explained *,	8
Distance directly across between the line of the right and left foot-marks behind and before, about - - - - -	3
Distance from the claws of the hind-foot to those of the nearest mark of the fore-foot, about - - - - -	2

In both of the specimens already mentioned, the track of the animal was in an upward direction, that is, from the bottom to the top of the quarry, almost in a direct line, along a smooth surface, inclining like the rest of the strata of the sandstone at an angle of 38°. This at least I can aver, from personal observation, to have been the case with No. 2, which I saw removed from its original bed. The track continued along the whole face of the flag as it lay in the quarry till it disappeared in the earth at the top. It had been recently uncovered in the course of working, by the removal of a thick superincumbent layer, which, I was informed, had, in this as in other instances, the *counter* prints distinctly marked in relief on its under surface, these upper projections corresponding to the cavities below as exactly as a cast to its mould. The whole length of the track, which was quite regular, was from 14 to 16 feet, scarcely visible at first, as if the sand had been too dry to receive the impression, but becoming in a few steps perfectly well defined, and continuing so to the very top. The surface on which the footsteps were impressed was what the workmen technically call a *clay-face*, being, from a more copious admixture of clay than ordinary in its outer coat, harder than the rest of the rock, and the seam between it and the upper stratum having less adhesion, and con-

* That is, when the fore-foot was advanced, and the hind-foot thrown back in the act of moving forward.

taining sometimes, though not in the present instance, a thin layer of soft clay altogether distinct from the stone. I was told by the son of the tacksman of the quarry, a person of some intelligence, that the tracks never appeared on a surface not of this kind. Another remark of some importance, derived from the same source, is, that all the tracks are constantly in a direction either up or down, sometimes inclining a very little either to the right or left, but never running across the slope in any considerable degree. This my own observation, so far as it goes, fully confirms.

No. 3. is a cast taken from a block which was also removed from the quarry while I was present, and, like the other two, is in my possession. The impressions it contains seem to be those of an animal's feet in the act of descending the steep face of the moist sand. The inclination of the slab as it lay in the quarry, was I think greater than the ordinary inclination of the rest of the strata, and might be upwards of 40° . It was at all events so steep as to render it necessary for an animal descending the declivity to insert its fore-feet firmly in the sand before it could move with safety; and this the quadruped in question appears to have done, by cautiously sliding one paw downwards, till its footing became secure, and then extending the other in the same way, while its hinder feet, following alternately, rested on the surface of the sand. Assuming this to be the case, we might expect to see the prints of the hind-feet also; and accordingly, in the very places where such marks might naturally be looked for, slight depressions of the stone are discoverable, sufficiently well defined to justify the opinion that they are foot-marks. If it be objected that these depressions are too slight to correspond with the deep cavities supposed to be made by the fore-feet, it must be remembered that the weight of the animal's body would necessarily be thrown much forward, and that the whole of its security would lie on the efforts made with its fore-feet, the hind-feet being

merely used to keep it steady ; so that the comparative slightness of these impressions is just what might have been anticipated. It may be proper to mention, that the block from which this specimen was taken was but a few feet in length, and contained two other sliding impressions, precisely similar to those which I carried away, affording the strongest conviction to my mind that they were a continuation of the same track. I have in my possession other specimens of similar prints, taken from a different part of the quarry, one of which I transmit * ; but these are not so deep, and I have in vain endeavoured to discover any depressions in them corresponding to those which I take to be made by the hind-feet of this animal. It is probable that in these instances the weight with which the hind-feet rested on the surface was too little to make a durable impression on the sand in its half indurated state.

I persuade myself that a simple inspection of the casts and specimens I transmit along with this, will be sufficient to satisfy any reasonable inquirer that the cavities they contain are the actual foot-marks of quadrupeds, and justify me, without farther proof, in having assumed them to be so ; but should any doubts on the subject remain, I must refer to the quarry itself, where several specimens are still left exposed, and others are occasionally uncovered, of a nature to remove all scepticism, though it is greatly to be regretted that so many of the very finest have, by the carelessness of the quarrymen, who regarded them as of no value, been utterly destroyed.

One of the tracks still to be found in the quarry is too remarkable to be passed over without notice, being considerably larger than any of those I have mentioned. The prints are so much filled up, indeed, as to leave the shape of the foot undefined ; but yet the nature of these impressions cannot be mis-

* Specimen marked A.

taken, when they are compared with those which are more distinct. I have unfortunately taken no accurate measurement of this track ; but from an imperfect specimen now transmitted *, it appears that the distance from the hind to the fore foot, when most nearly in contact, was about 1 foot 9 inches, while the breadth across from the line of the right foot track to that of the left, was somewhat more than 7 inches ; and if I might be allowed to speak from recollection, I should say that what I have loosely called the animal's step, for want of a better word, that is, the distance between the fore and hind feet, supposing them to be at their stretch, could not be less than five feet. The layer on which the impressions are made, happens to be only a little more than half an inch thick, and it has naturally no adhesion to the under stratum. In attempting, however, to raise a specimen from its bed, I found that the two strata were so intimately united wherever the prints of the feet occurred, that it was impossible to separate them without breaking. It seemed as if the weight of the animal, or its efforts in ascending, had occasioned the thrusting of its feet entirely through the upper into the under layer ; and on forcing the strata asunder, this supposition was confirmed by the curious fact, that the matter of the under layer, displaced doubtless by the sinking of the feet, was discovered to be heaped up in a ridge-like form round the insertion of the animal's heel, having made way for itself, when forced back, by causing a corresponding concave impression on the under face of the upper stratum.

With regard to the species of animals whose tracks have been so wonderfully preserved, I do not think myself competent to offer any conjectures of my own ; but having been in correspondence with one of the first geologists of the age (to whom I

* Specimen marked B, on which there is also the track of a small animal ascending.

sent casts similar to those now transmitted, besides a small specimen of the rock itself, containing one or two foot-prints), I think it may be interesting to state the opinion with which his politeness has favoured me as to three of the tracks.

Concurring with Mr JAMESON, as he assures me he does, in the belief that the rock is what is called the *new red sandstone*, which is supposed to have been deposited at an era when it is the received opinion that no quadrupeds existed on our earth of a higher order than reptiles, he was induced to look to our present crocodiles and tortoises as the species most nearly resembling those whose footsteps have marked the stone. This led him to make a rough experiment with some live tortoises which he has in his possession, the result of which was to make him conjecture that the impressions must rather belong to the tortoise than the crocodile tribe. He did not, however, speak positively;—not that he thought the prints too indistinct to enable him to form an opinion, but because he had not sufficient time and opportunity for examination*. As to the deep tracks occasioned, as I had sug-

* Since the above was written, I have had the pleasure to receive a letter from Professor BUCKLAND, containing the following account of his experiments:

“ Oxford, 12th Dec. 1827.

“ 1st, I made a crocodile walk over soft pye-crust, and took impressions of his feet, which shew decidedly that your sandstone foot-marks are *not* crocodiles.

“ 2d, I made tortoises, of three distinct species, travel over pye-crust, and wet sand and soft clay; and the result is, I have little or no doubt that it is to animals of this genus that your impressions on the new red sandstone must be referred, though I cannot identify them with any of the living species on which I made my experiments. The form of the footstep of a modern tortoise corresponds sufficiently well, but the relative position of the impressions to each other does not entirely coincide, and this I attribute to the different pace at which the animal was proceeding; for I found considerable variety in these positions as my tortoises moved more or less rapidly; and as most animals have three distinct kinds of impression for their three paces of walk, trot, and gallop, so I conceive your wild tortoises of the red sandstone

gested, by the sliding of the animal, he fully adopted my theory of their origin. The track of the large animal I had not then described to him; and any account of it I am even now able to give, is so vague as to lead to no certain conclusion. The only thing yet discovered which can afford any idea of the nature of the foot, is the ridge formerly mentioned as curling round the animal's heels, on the surface of the under stratum, corresponding to which, but a little above it, there is, in one instance, on the surface of the upper layer, a depressed line of the shape and dimensions marked below :



a fact which contradicts the commonly received opinion of geologists respecting the position of sandstone in its original

age would move with more activity and speed, and leave more distant impressions, from a more rapid and more equable style of march, than my dull torpid prisoners on the present earth in this to them unnatural climate.

“ I found, also, that, on walking down hill on soft sand, my tortoise scooped out long and somewhat oval cavities, like those of which you sent me a cast, leaving no impressions of the toes or heel. Each foot successively floundered forwards to the lowest point of the groove, producing the posterior part of the excavation, and was then dragged out, producing a similar removal of the sand from the anterior part of the groove in question. The difficulty is to explain why sand so soft did not subside and obliterate the cavities, before or during the arrival of the next superincumbent bed of sand, which filled up and preserved these impressions. Elongated excavations similar to those last spoken of are made by hares and other quadrupeds, in moving over soft and half consolidated snow.”

In a subsequent letter of 17th March, Professor BUCKLAND, in relation to the elongated and imperfect impressions, which Dr DUNCAN attributed to the dragging of the animals as they were moving with difficulty down hill, observes, “ The cause of this variety of impressions I would interpret otherwise, and rather refer them to

state, seems to be deducible from the appearances connected with these impressions. It has been alleged that the materials of which sandstone is composed, were accumulated by successive depositions from the sea or other extensive waters, and that therefore the strata must have been, while in a soft state, nearly horizontal. It seems almost demonstrable, however, that the strata must in this instance have been in a greatly inclined position, if not altogether as inclined as at present, when the impressions were made. On this subject an observation or two may suffice. On inspecting the casts and specimens sent, it will be observed that there are evident remains of the matter displaced by the footsteps. This is the case with almost all the impressions I have seen; and wherever such an appearance occurs, that matter is found to have been carried *downwards*, with reference to the present inclination. In the case of No. 2, * for instance, the track of the animal was directly *up* the face of the steep; and it will be seen that the sand is therefore thrown back, immediately behind the foot-marks. In the case of No. 1, however, the track had inclined a little to the right, and this slight variation is indicated by the direction of the displaced sand, which has precisely such a position as this circumstance

the more than usual soft condition of the sand at the time and place where these imperfect marks were made. Marks exactly like those made by my living tortoises, on sand that was wetted too much for a sound impression, viz. holes into which the foot had sunk so deep that it could not be lifted out and moved forward by the advancing animal without displacing by its toes a quantity of the sand that was in front of the line of motion of each foot, and the result being a series of scoopings such as the track of a hare or rabbit exhibits in soft and deep snow. If this idea be correct, the impressions may have been made on horizontal beds of soft sand, ere they had received the high degree of inclination they now possess. Thus the problem will be relieved of some portion of its difficulty, namely, that which attends the hypothesis of all the impressions having been made on the sand-beds whilst inclined at the same angle they exhibit at present."

* The casts and specimens here alluded to are deposited in the Museum of the Society, and may be inspected by application to any of its members.

accounts for ; while in the case of No. 3, the wet sand has evidently run down before the descending prints. It will be observed, too, that the claws and fore-part of the ascending foot have been more deeply inserted into the sand than would have been natural, had the surface been nearly horizontal ; and indeed a slight glance at the *sliding* foot-marks in No. 3, seems to settle the question. But there is another circumstance already mentioned, which can scarcely be accounted for, but on the supposition that the surface of the sand had a very considerable inclination,—I mean the fact that the tracks run all from the bottom to the top of the slope, or *vice versa*, and *never* across. An inclination of 38° is so considerable, that it could only be with extreme difficulty that an animal could make its way across the steep ; but it would obviously find a much less effort necessary in moving up and down.

With regard to the state of the sand, in point of tenacity and moisture, at the time the impressions were made, a few remarks seem to be called for. In the first place, the surface could not have been entirely dry, otherwise the displaced sand would have been rough and uneven, whereas it is quite smooth, indicating a state inclining to mud, which may be explained on the supposition already mentioned, of a considerable mixture of fine particles of clay ; but on the other hand, had the matter been very soft, it could not have retained its precipitous face, nor could the animals have moved over it, without sinking much deeper than they appear to have done, neither could the impressions have remained so distinct as we find them actually to be. There seems to be an indication, too, of a certain degree of toughness in the surface. This is particularly remarkable in No. 2, where it would appear that the clayey sand had already become slightly indurated externally, having been skinned over, as it were, with a stiffening coat ; for it will be observed that the claws of the animal as it ascended, seem to have rent the surface asunder at every step of

its hind-feet, forcing it downwards by the pressure. It may be noticed, too, that, in Nos. 1. and 3, where no such disruption appears to have taken place, a similar tenacity is indicated; for, when the hind-feet of the animals have happened to rest on the sand that had been newly displaced by the fore-feet, their pressure has not altogether obliterated the appearance of superadded matter, but has merely caused a depression of the part rested on. These indications are precisely what would have taken place on a surface composed of stiffening putty or other tenacious matter, and mark with curious precision the peculiar state of the sand.

There is a circumstance not yet adverted to, which cannot fail to make a strong impression on those who are not familiar with the wonders of geology. I allude to the position of these impressions, with relation to the superincumbent strata. In the direction of the dip of the strata, the rock is continuous for at least a quarter of a mile from the quarry where the impressions are found. Now, as the strata in the whole of this extent are nearly parallel to those of the quarry, it is obvious that they must lie upon each other like volumes in the shelf of a library when all inclining to one side; and as these strata rest on others in which the foot-marks are found, they must of course have been deposited since the animals whose tracks they indicate moved on the sand then forming the surface of the ground. This fact leads the mind into the remotest antiquity, and perplexes it in a maze of interminable conjectures as to the state of the earth's materials when these living creatures walked on its surface, and bathed in other waters, and browsed on other pastures, and not less as to the extraordinary changes and convulsions of nature which have since taken place, and which have broken up, overturned, and remodelled all things.

Nor will our surprize and perplexity be lessened, when we attend to other facts connected with this remarkable phenome-

non. The quarry has been worked to the depth of about 45 feet from the top of the rock, and as far down as the labours of the quarrymen have hitherto extended (I speak on the concurrent testimony of several eye-witnesses), similar impressions have been found, and those equally distinct and well defined with such as are nearer the surface. But this is far less remarkable than another fact which I give on the same authority. Although the sandstone at the place where the quarry was originally opened, contained no foot-marks, as it consisted of what is called by the workmen *solid* (*i. e.* imperfectly stratified) rock, yet it soon changed its character, and whenever it assumed the form of regular layers, the impressions began to occur. From this period, as the workmen proceeded in their labours, they have continued to find numerous impressions, particularly in one part of the quarry, and that not on a single stratum, but on many successive strata; that is to say, after removing a layer which contained foot-prints, they found perhaps the very next *clay-face* stratum, at the distance of a few feet, or it might be of less than an inch, exhibiting a similar phenomenon. Since the foot-marks were first discovered, about forty yards of sandstone have been removed in a direction perpendicular to the line of the strata, and throughout the whole of that extent, impressions of precisely the same kind have, at frequently recurring intervals, been uncovered, and are still continuing to be uncovered.

This seems to prove incontestably that the process, whatever it may have been, by which the impressions were buried in the sand, has not been occasioned by any sudden and isolated convulsion of nature, but has been carried on through many successive years, or rather ages. Nor has it been the result of tides on the shore of the sea, which can scarcely be supposed to have flowed to the height of between forty and fifty feet; and, even if they had done so, would certainly have swept away or filled up

any impressions which animals might have made at low water, by moving over the surface of the sands they were depositing.

In the midst of so much difficulty, it is not easy to form even a plausible conjecture as to the manner in which the sand composing the rock was originally accumulated. It might, however, be perhaps worth while to inquire whether or not this successive accumulation could be the effect of the drifting occasioned by violent winds from the south-west. Supposing a sand-hill to be thus formed, a period of rainy weather following the stormy season would soften and diffuse the particles of clay, which may easily be believed to have mingled with the sand-drift, and would not only prevent the sand from being again moved by the wind, but would form it into a substance of some tenacity, resembling mortar, well fitted for preserving any impression it might receive. If, during or immediately after the rainy season, animals were to traverse a hill thus formed, their tracks would be either altogether obliterated, or partially filled up, of which latter state many traces are to be found in the quarry; but when the surface had begun to dry, the foot-marks impressed on it would remain for a considerable time quite distinct and well defined. Now, supposing the stormy monsoon again to commence, the neighbouring sands, which had not yet been fixed by any strong mixture of clay, and which happened, from their situation, to be easily dried by a few days of favourable weather, would be suddenly drifted on the hill in question, forming a layer which may easily have covered over the half-indurated surface, without being incorporated with it, and without in any way injuring the form of the foot-steps imprinted on it. Let the monsoon be now supposed to continue during the whole course of a dry summer: Fresh layers of sand would be drifted, comparatively pure at first, but mingled again towards the close of the season with the clayey dust swept from an arid soil, which mixture would form the materials of what the quarrymen know in

its present state by the name of a *clay-face*, and would once more, when subjected to the operation of the returning period of rain, both fix the sand, and prepare it for the reception of permanent impressions of the tracks of wandering animals. Thus, from year to year, the same round would be continued, and the same appearances would take place, till, after the revolution of many ages, what was originally sand would be converted, by a common process of nature, into sandstone, and being exposed, in common with the rest of our globe, to those mighty but mysterious convulsions of which there are every where such incontrovertible proofs, would at last, by the submersion of the universal deluge, be buried under its present covering of soil.

RUTHWELL, 15th Dec. 1827.

XII. *On the Combination of Chlorine with the Prussiate of Potash, and the presence of such a compound as an impurity in Prussian Blue.* By JAMES F. W. JOHNSTON, A. M.

(Read January 7. 1828.)

IT has been long known that the Prussian blue of commerce contains an admixture, in greater or less quantity, of alumina, sulphate of potash, and common alum, one or all of them being easily detected in every specimen. The sulphate of potash and the alum may be separated by frequent boiling in water, but they are seldom in such quantity as to render this process necessary. The alumina may be removed by digestion in muriatic acid, and the washing consequent upon this mode of treatment will free it from all the soluble impurities.

When the alkalies or earths are digested with Prussian blue, in order to form the common Prussiates, and the yellow solution is evaporated, it almost uniformly happens that after the first or second crop of crystals is separated, there remains a dark brownish-red liquid, which either does not crystallize at all, or gives crystals of the required prussiate of a dirty brown colour, and mixed with a greater or less portion of a red matter, either massive, or in small, red, four-sided needles and prisms. This may be observed in preparing the prussiates of lime or soda by the common process, but has been more frequently taken notice of in forming the cyanide of mercury; because the least colouring matter in this salt is at once perceptible, and because in the preparation of it, a partial loss is of greater consequence. To the presence of a portion of this red salt, particularly in extemporaneous prussiates, I attribute those differences in the colour of

the precipitates which they give with the metallic oxides, and which have led some to doubt the accuracy of their indications. The grounds of this opinion will appear in the sequel of the present paper.

In BREWSTER'S *Journal* (vol. v. p. 247.), Dr TURNER has shown, that, by previously digesting the Prussian blue in dilute muriatic acid, all loss in the preparation of the cyanide of mercury may be avoided; but as he found the acid to have taken up only iron and alumina, he leaves it to be inferred that one or both of these is the cause of the impurity above referred to. What is its true nature, I proceed to show.

To obtain it in a separate state, let the common Prussian blue of the shops be digested in boiling water, a bright greenish-yellow solution will be formed, perfectly neutral, and having the following properties:

With Caustic Alkalies, Sulphate of Soda, Benzoate of Ammonia, Lime-water, and *Salts of Lead*, it gives no precipitate.

Nitrate of Silver, ... it gives a bright brick-red.

Sulphate of Copper, a brown or dirty brownish-yellow.

Sulphate of Zinc, light yellow, sometimes brownish.

Bichloride of Mercury, slight, yellowish, becoming blue.

Sulphate of Nickel, yellow.

————— Cobalt, blood-red.

Nitrate of Bismuth, chrome-yellow.

Muriate of Gold, slight, yellowish.

Sulphate of Cadmium, chrome-yellow.

Muriates of Tin, beautiful white.

Sulphates of Iron, deep blue.

Pernitrate of Uranium, slight greenish-yellow.

Sulphate of Manganese, dirty brown.

Sulphate of Cerium, none.

Muriate of Platinum, yellow, soluble in hot water.

Hydrosulphuret of Potash, ... white powder.

Tincture of Galls, brown.

If several ounces of Prussian blue be digested in this way with repeated affusions of hot water, and the several solutions be

added together and evaporated, a small quantity of a dark thick liquid is obtained, similar in appearance to that occurring in the preparation of the cyanide of mercury, having a peculiar smell, approaching to that of weak chlorine, and being of a blackish by reflected, but of a deep red by transmitted light. By farther concentration, this liquid is partly decomposed, depositing a green sediment, and by slow cooling gives crystals of a deep red colour, in doubly oblique four-sided prisms, terminated sometimes by two or three planes, and not unfrequently acuminate into pyramids. These crystals are insoluble in alcohol, unless considerably diluted, but very soluble in water; and the solution, which, even when very weak, is of a bright greenish-yellow colour, has all the properties above mentioned. Sometimes the crystals are deposited in very minute needles, when they are of a bright golden-yellow colour, and sometimes in beautiful red tables.

If this salt be reduced to powder, and treated with concentrated sulphuric acid, it gives off chlorine, and on the application of heat hydrocyanic acid. Its solution with tartaric acid gives crystals of bi-tartrate of potash; and heated *per se*, in an open crucible, it leaves an oxide of iron. It contains therefore chlorine, cyanogen, potash, and iron. In having the first of these for one of its constituents, it differs from the common prussiate of potash.

Having shown this salt to Dr THOMSON, I was referred by him to a paper by LEOPOLD VON GMELIN in SCHWEIGGER'S *Journal*, N. S. vol. iv. p. 325, in which he describes a salt in red prisms, having properties precisely the same as those above stated. The angles of the rhombus, which I find, by careful measurement, to agree with those of the salt obtained as above, he states at $81^{\circ} 48'$ and $98^{\circ} 12'$, and their diagonals as $2:\sqrt{3}$. The salts are therefore identical, though, as we shall afterwards see, VON GMELIN has mistaken its composition.

To obtain this salt, he passes a stream of chlorine gas through

a solution of the prussiate of potash: the liquor gradually loses its yellow tint, becomes of a *dark greenish-yellow*, and, when fully saturated, of a deep brownish-red colour. From this solution the salt is obtained in regular crystals, though with considerable difficulty, owing to its tendency to decompose, and to deposit a green sediment. I have never been able by this process to procure crystals either so large or so permanent as those I got at first from the Prussian blue. By another process, however, which I shall presently describe, it may be formed with great ease, and in beautiful crystals.

GMELIN calls this salt a *peculiar Cyanide of Iron and Potassium* (besonderes Cyan Eisen Kalium), and gives the following as its composition :

	By Experiment.	
Potassium,	= 35·873	} = 102·093
Iron, -	= 17·22	
Cyanogen,	= 49·0	

taking the mean of his results; and from this he deduces, as its atomic constitution,

Potassium,	= 3 atoms,	= 117·6	= 35·89 per cent.
Iron,	= 2 ...	= 54·0	= 16·49
Cyanogen,	= 6 ...	= 156·0	= 47·62
	1 atom,	= 327·6	= 100·00

which, by correcting the atomic weights, becomes

Potassium, 3 atoms,	= 15·0	= 120	= 36·1445 per cent.
Iron, 2 ...	= 7·0	= 56	= 16·8674
Cyanogen, 6 ...	= 19·5	= 156	= 46·9879
1	41·5	332	99·9

Now from the way in which the salt is formed, it is evident that no such change of composition can have taken place. For we have here the cyanogen (= 6 atoms) and iron (= 2 atoms) of 2 atoms of the common prussiate *, contained in each atom of the new salt in combination with only 3 atoms of potassium; so that to form it we have only to deprive the common prussiate of its water, and of half an atom of potash. Upon what principle of affinity, then, can the action of chlorine produce this separation; and, if produced, what becomes of the potash, since the liquor may be made to crystallize to the last drop? It cannot be in the green powder, which, during concentration, is often deposited; for its quantity is variable, and it is plainly the result of decomposition. The ratio of the atoms, therefore, must be different from what he states it to be, and there is no reason why it should not be the same as in the original salt.

Again, this statement throws no light on the action of the chlorine in forming the new salt. This gas must act in one of

* There are various ways of stating the composition of this salt. According to BERZELIUS, who considers the prussiates as compounds of 1 atom of cyanide of iron + 2 atoms cyanide of another metal, it consists of

Potassium	2 atoms,	= 10.0	}	= 26.625
Iron	1 ...	= 3.5		
Cyanogen	3 ...	= 9.75		
Water	3 ...	= 3.375		

2. According to Dr THOMSON, it is composed of

2 atoms potash,	-	= 12.0	}	= 26.625
1 ...	protoxide of iron,	= 4.5		
3 ...	hydrocyanic acid,	= 10.125		

3. While Mr PHILLIPS states it thus:

1 atom ferro-cyanic acid,	-	= 14.625	}	= 26.625
2 ...	potash,	= 12.0		

BERZELIUS considering the water present to be merely that of crystallization, and Mr PHILLIPS viewing the iron as a constituent of the acid, coinciding in this point with Mr PORRETT.

two ways. Either it must combine with the elements of the salt, or it must decompose the water, imparting to these elements an atom of oxygen, and combining itself with the hydrogen to form muriatic acid. But of the presence of this acid there is no trace, nor does the analysis take account of the addition of oxygen; for it does not allow the presence of a single atom in the salt. The chlorine, therefore, cannot have acted by decomposing the water; it must consequently have combined with the elements of the salt.

This conclusion, which is fairly deducible from the phenomena attending the preparation of the salt, is confirmed by experiments, both analytic and synthetic, which I proceed to state.

1. The dry crystals reduced to powder, and treated with concentrated sulphuric acid, give off chlorine gas. This is abundantly perceptible by the smell, though I have not hitherto been able by this means to obtain satisfactory results as to the quantity of chlorine present.

2. When the same powder, which is of a bright yellow colour, is heated in a glass tube or small retort by means of a spirit-lamp, it is changed into a dark brown colour, giving off during this change a gaseous product, soluble in water, and having the character of the chloro-cyanic acid, accompanied sometimes by a small quantity of cyanogen.

3. By Gmelin's analysis, the salt is anhydrous; and accordingly, when heated to 300° on the sand-bath, it loses nothing, nor, when exposed to a red heat in a tube, does it give off any moisture or trace of ammonia, if the crystals employed have been perfectly dry. We have ascertained two points of difference, then, between this salt and the common prussiate of potash, *that it contains chlorine, and is destitute of water.*

Now the chlorine may either have united itself to the entire elements of the salt, or it may have expelled a portion of the cyanogen, and have taken its place. The whole loss of gaseous matter, which he concluded to be all cyanogen, but which was in reality the sum of the two gases, GMELIN found to amount to 49 per cent. Now 3 atoms of cyanogen = 38.2 per cent. leaving upwards of 10 per cent. for the chlorine *added* to the original constituents. This is not far from half an atom (= 8.82 per cent.), which we shall afterwards see is the true quantity.

4. Failing to satisfy myself by analysis of the true amount of the chlorine, I endeavoured to ascertain how much the prussiate of potash would *absorb*. And first, as the new salt contains no water, 40.3 grs. of the *anhydrous* prussiate,—the three atoms of water being previously expelled by a gentle heat,—were introduced into a glass tube, and exposed for several days to an atmosphere of chlorine: the white powder became of a beautiful bright yellow colour, and had gained 1.4 grs. Dissolved in water, it gave a bright yellow solution, and by evaporation crystals partly red and partly yellow, being a mixture of the new salt and the common prussiate. The powder, therefore, had not been saturated with chlorine.

5. I now introduced 150 grs. of the crystallized prussiate, reduced to a fine powder, conceiving that the presence of the 3 atoms of water might facilitate the combination. And to ascertain if any gas were disengaged from the salt, I caused the one end of the apparatus to terminate in a solution of the prussiate of potash, through which the passage of chlorine would be indicated by a change of colour; while at the other, the chlorine was generated and made to pass over chloride of calcium. As soon as the gas came in contact with the powder, it gave it a deep chrome-yellow colour, and a deposition of moisture took place on

the inside of the tube, opposite the portion whose colour was changed. The deposition of moisture and change of colour proceeded together along the tube (no moisture being deposited at either extremity beyond the amianthus by which the salt was confined), till the whole had assumed the new colour, when the powder was evidently in a moist state. On introducing the chlorine, a portion of common air was expelled, after which no gas came over, the chlorine being slowly generated. That it was in contact with the liquid into which the extremity of the apparatus was plunged, was manifested by the formation of a dark ring at its surface, within the terminating tube.

There being in this process, then, no loss, all increase of weight will be due to the absorption of chlorine. Out of a multitude of experiments with similar results, I select the following :

52 grs.	gained 4.4 grs.	= 2.253	to each atom of 26.625 grs.		
153.2 grs.	... 12.9	= 2.248
277.5 grs.	... 23.5	= 2.254

Now these come all so near 2.25, = half an atom of chlorine, as to leave no doubt that such is the true quantity absorbed.

When the chlorine is passed over the powder very slowly, little *apparent* moisture is disengaged, the water, though freed from combination, remaining in contact with the salt ; but if it be generated with great rapidity, as by the direct action of muriatic acid on peroxide of manganese, the water of crystallization is also rapidly disengaged, and forms on the sides of the tube in very considerable drops ; and if the quantity of powder acted upon be large, there is at the same time a considerable elevation of temperature caused by the condensation of the gas.

6. If the yellow powder thus saturated with chlorine be spread out in the open air, and dried without artificial heat, it loses in weight a quantity exactly equal to 3 atoms of water.

Thus, for example, 56·4 grs. lost 6·6, as near 6·591 which 3 atoms of water amount to as possible; and after this loss, being heated to 300°, it lost only ·08 of a grain. The chlorine, therefore, in combining with the prussiate to form this yellow powder, expels from its previous state of combination the three atoms of water which enter into its constitution.

7. There only remains, then, to ascertain the relation between this yellow powder and the red crystals, which, as mentioned above, are the state in which the salt under consideration occurs. If the *dry* powder be dissolved in a small portion of distilled water, carefully evaporated, and a gentle heat continued till the whole moisture be driven off, the salt will be obtained in beautiful crystals, and of the *same weight* as the powder employed. Or if the *moist* and newly saturated powder be dissolved and crystallized, the loss of weight will amount as before to that of 3 atoms of water.

Thus, 37·7 grs. gave 33·6 grs. of dry crystals.

80 grs.	...	71
30 grs.	...	26·7
50 grs.	...	44·2

The 1st	lost 4·1 grs.,	should have lost 4·4
2d	... 9 9·35
3d	... 3·3 3·5
4th	... 5·8 5·836

in which the approximation is as close as can be looked for in such a process. There is therefore no difference between the yellow powder and the red crystals, except the crystalline arrangement of the particles; the elementary constitution of both is the same.

8. The composition of the salt may therefore be stated as follows :

$$\begin{array}{l} 1 \text{ atom anhydrous prussiate of potash,} = 23.25 \\ \frac{1}{2} \text{ ... chlorine,} \quad \quad \quad \quad \quad = 2.25 \end{array} \left. \vphantom{\begin{array}{l} 1 \text{ atom anhydrous prussiate of potash,} \\ \frac{1}{2} \text{ ... chlorine,} \end{array}} \right\} = 25.5$$

Or,

	Per Cent.	
Chlorine, $\frac{1}{2}$ atom, = 2.25	= 8.8235	} = 47.0588
Cyanogen, 3 atoms, = 9.75	= 38.2353	
Iron, 1 ... = 3.5	= 13.725	
Potassium, 2 ... = 10.0	= 39.215	
	25.5	99.99

or, by doubling the quantities, we shall get rid of the half atom, and the atomic weight will be 51.

In this statement, the *sum* of the chlorine and cyanogen approaches very near to the amount of cyanogen assigned by GME-LIN: in the potassium there is a difference of 4 and in the iron of 3 per cent.

9. There are three different modes of combination, according to which the chlorine may be supposed to have arranged its elementary particles in forming the new compound we have been considering. Either it may have united with the cyanogen contained in the cyanide of iron, forming a *chloro-cyanide*, in which the acid consists of

$$\begin{array}{l} 1 \text{ Chlorine,} = 4.5 \\ 2 \text{ Cyanogen,} = 6.5 \end{array} \left. \vphantom{\begin{array}{l} 1 \text{ Chlorine,} \\ 2 \text{ Cyanogen,} \end{array}} \right\} 11$$

united to two atoms of iron. Or it may have united itself to that which is combined with the potassium, forming an acid containing double the quantity of cyanogen, namely,

$$\begin{array}{r} 1 \text{ Chlorine,} \quad 4.5 \\ 2 \text{ Cyanogen,} \quad 13.0 \end{array} \left. \vphantom{\begin{array}{r} 1 \text{ Chlorine,} \\ 2 \text{ Cyanogen,} \end{array}} \right\} 17.5$$

united to 4 atoms of potassium. Or, lastly, it may have united with the whole of the cyanogen and the iron, as they exist in the ferro-cyanic acid, forming a new acid, composed of

$$\begin{array}{r} 1 \text{ atom chlorine,} \quad = 4.5 \\ 6 \text{ ... cyanogen,} \quad = 19.5 \\ 2 \text{ ... iron,} \quad = 7.0 \end{array} \left. \vphantom{\begin{array}{r} 1 \text{ atom chlorine,} \\ 6 \text{ ... cyanogen,} \\ 2 \text{ ... iron,} \end{array}} \right\} = 31.$$

and our new salt will consist of

$$\begin{array}{r} 1 \text{ atom chloro-ferro-cyanic acid,} \quad = 31 \\ 4 \text{ ... potassium,} \quad - \quad - \quad = 20 \end{array} \left. \vphantom{\begin{array}{r} 1 \text{ atom chloro-ferro-cyanic acid,} \\ 4 \text{ ... potassium,} \end{array}} \right\} 51.$$

forming a *chloro-ferro-cyanide* of potassium.

The last of these views of the constitution of the salt is that which I am inclined to adopt. For this preference various reasons might be stated, but I am mainly influenced by the circumstance, that, when the chlorine combines with the prussiate of potash as above detailed, it expels *all* the water, and therefore seems to combine with the whole assemblage of elements as one compound atom.

10. The acid, as it exists in the above salt, can, it is obvious, contain neither oxygen nor hydrogen. It may be obtained in a separate state by various processes, some of which I shall explain in a future communication. I may here, however, mention, that, when pure, it forms beautiful red four-sided needles, not differing in appearance from those of any of its salts. In this state it contains either water or its elements, and may be viewed as a hydracid, though in the salt of potassium it acts precisely as chlorine does in the chlorides.

I have formed the various salts resulting from the union of

this acid with the bases, and shall conclude this paper with a detail of their general properties, reserving the particular history of each till I shall have more fully explained the nature and composition of the crystallized acid.

1st, They are all of a deep red colour, crystallizing in four-sided pyramids and rhomboidal prisms. In minute needles they assume a golden-yellow colour.

2d, In the moist state, the crystals are liable to decomposition by the agency of heat and light, becoming externally of a greenish colour, and in solution depositing a green sediment.

3d, They are very soluble in water, but insoluble in alcohol, unless considerably diluted.

4th, Their solutions when hot and concentrated have a peculiar smell, approaching to that of weak chlorine, and, with the exception of the salt of lead, they have all a bitterish taste; that of lead has the sweet taste of its other salts.

5th, These solutions are decomposed by sulphuretted hydrogen, becoming green, and depositing sulphur. Some of the hydro-sulphurets have a similar effect, but they are not changed by hydrogen gas.

6th, Treated in powder with sulphuric acid, they give off chlorine gas. From the salts of barytes, strontian and lead, it is also partially driven off by a gentle heat.

7th, Their solutions are also decomposed by metallic mercury, being changed into green, becoming greenish-yellow, and letting fall a blue precipitate; the solution no longer giving a *red* but a *white* with nitrate of silver. They have likewise a strong action upon metallic iron, coating it immediately with Prussian blue.

8th, They all give similar precipitates with the metallic oxides.

9th, When dry, they undergo no change by exposure to the air, the salt of cadmium excepted, which deliquesces.

10th, Most of them decrepitate when heated, and in the flame of a candle are combustible, throwing out bright white sparks, and leaving a dark brown residue. The salt of barytes melts without sensibly burning; and that of lead burns silently like tinder, giving minute globules of metallic lead.

CLAYPATH, DURHAM, }
January 1828. }

XIII. *On a Mass of Native Iron from the Desert of Atamaca in Peru.* By THOMAS ALLAN, Esq. F. R. S. E.

(Read 4th February 1828.)

WHEN in London in spring last year, Mr PARISH had the kindness to show me some specimens which he had just received from his son, Mr WOODBINE PARISH, his Majesty's Consul-General at Buenos Ayres, among which I was surprised and much pleased to find two masses of native iron, exactly similar to the celebrated Siberian block, made known to the scientific world through the exertions of PALLAS, having the same vesicular structure, and containing the same straw-yellow coloured olivine firmly imbedded.

I immediately suggested to Mr PARISH the propriety of losing no time in making this discovery known, and thereby secure to his son the merit of bringing it before the public; and in order to do this in the most effectual manner, I advised him to present one of the masses to the Royal Society of London, and the other to the Royal Society of Edinburgh; and it is with pleasure that I now find myself deputed to carry his wishes with respect to this Society into execution, by presenting one of the masses as a donation to this institution in the name of his son.

Hitherto the Siberian mass has stood unrivalled, and quite unique. A mass found in Poland in 1809, was said to have resembled it, being vesicular, and having the cavities covered internally with a yellowish-green vitreous substance; but it would have required the cavities in the iron to be *filled* with that substance, to have rendered it similar to the Siberian mass. The other native irons, have I believe, uniformly presented a solid

structure, or else, though technically termed spongy, were wholly composed of metallic iron, alloyed as they all are with nickel. It is consequently interesting to find that a mineral so entirely similar to that of Siberia, should have been found abounding in the opposite hemisphere, as appears by the following very curious statement contained in the extracts of two letters from Buenos Ayres, and so abounding as to render it a matter of great astonishment.

“ Account received by Dr REDHEAD ; of the Native Iron from the Province of Atacama.

“ The specimens were taken from a heap of the same nature, esteemed at about three quintals. They exist at the mouth of a vein of solid iron (*barra*), half a yard wide, situated at the foot of a mountain. The opposite plain is strewed with similar fragments. The Indian who brought these, calls them “ *Reventazones*,” supposing them to be produced by explosions from the mines. He had been charged to bring a piece of the vein itself, and some of the rock in which it is imbedded ; but this he says he could not effect for want of tools. He therefore contented himself with picking up some pieces that were at the foot of the hill, where the mouth of the vein opens. If it be true, as, from the probity of the Indian, who is well known from previous information, and from general report, we must believe it to be, that the metal is in a vein, it ought to be considered as the first phenomenon of this nature that has occurred. What MARGRAFF found found in Saxony was probably not of this kind.”.....

Extract of a Letter from WOODBINE PARISH, Esq. Buenos Ayres, April 1827.

The account given by Dr REDHEAD has since been fully confirmed, by other accounts from different persons. This iron

is found in the province of Atacama in Peru, at a distance of about twenty leagues from the port of Cobija, in large masses imbedded in a mountain, in the neighbourhood of the village of San Pedro; and scattered over the plains at the foot of the mountain in question for a distance of three or four leagues, in fragments similar to that sent herewith, but some of them of considerable magnitude."

From this statement it appears that the accounts are yet imperfect, and that we have only the authority of an Indian to depend upon. It was by the same species of authority, obtained from a Cosaque named MEDVEDEF, who was found to be accurately correct, that PALLAS was led to his mass. The apology of the Indian for not bringing a portion of the vein attached to the rock, as he was desired to do, is a very plausible one; but the structure of this iron is so entirely dissimilar from the product of any vein of iron that we are acquainted with, that it is highly probable the scattered fragments will be found to differ entirely from any ore which the veins of that country may produce. It was the theory of the Indian, that these fragments, which, according to Mr PARRISH's subsequent statement, appear to be scattered over a district extending to three or four leagues, were produced by explosions from the veins. He had consequently a theory to support; and we know here something of the difficulty with which geological opinions are abandoned. Our Indian, therefore, who is admitted to be a man of observation, would probably decline to produce specimens calculated to upset his former assertions, as it is very improbable that he would be sent for the purpose of obtaining specimens without the tools necessary to secure the success of his mission.

The Desert of Atacama, as it is termed in the maps, is situated on the shore of the Pacific, between Chili and Peru. The town of Atacama lies in Lat. 23° 30' S., and Long. 69° 30' W.

about half-way between the ocean and the volcanic range which runs along the western edge of the great peninsula.

Connected with, though independent of, this notice, I may mention, that it is also to Mr WOODBINE PARISH that the British Museum is indebted for another remarkable mass of native iron, presented some time ago in the name of that gentleman by Sir H. DAVY. The history of it is unfortunately not given in detail. It is considered by Mr PARISH to be the same mass described in the Philosophical Transactions of 1788 by REUBAN DE CELIS, which was found in the province of Chaco Galamba. But there is a great discrepancy in the weight. It is rather surprising that no accurate description of this mass has as yet met the eye of the public, although it is itself placed under its aspect on the steps of the great stair of the Museum.

Since the Society last met, Dr TURNER has accomplished a chemical examination of this mass, in which he has found nickel, the admitted testimony of meteoric iron, and also traces of cobalt.

Examination of the Specimen presented to the Society by Mr ALLAN in the name of Mr WOODBINE PARISH, his Majesty's Consul-General at Buenos Ayres. By Dr TURNER.

Externally it has all the characters of meteoric iron. The metal in the specimen is tough, of a whiter colour than common iron, and is covered on most parts with a thin film of the oxide of iron. The interstices contain olivine.

The specific gravity of some clean fragments is 6.687; and the density of a portion which has been forged into the form of a nail, is 7.488.

To ascertain if the specimen before the Society is analogous to meteoric iron in composition, as well as in its appearance,

28·77 grains of it were exposed to the action of nitro-muriatic acid, and were completely dissolved by that menstruum. The solution, after being moderately diluted with cold water, was gradually neutralized by the bi-carbonate of potash, with the view of precipitating the iron, and retaining the cobalt and nickel in solution by the excess of carbonic acid.

The hydrated red oxide of iron, after being carefully washed, dissolved without residue in oxalic acid, and therefore did not contain any nickel or cobalt. The peroxide of iron was then thrown down by ammonia, collected, and heated to redness. Its weight was 38·39 grains, equivalent according to the atomic tables of Dr THOMSON, to 26·87 grains, or 93·40 per cent of metallic iron.

The solution from which the iron had been removed by the bi-carbonate of potash, had a green tint; and on expelling the free carbonic acid by heat, the hydrous carbonate of nickel subsided. The precipitation was completed by the aid of pure potash. The precipitate, after being washed, was treated by a solution of oxalic acid, and was thus converted into the granular oxalate of nickel. The acidulous solution of oxalic acid did not strike a blue colour with the ferrocyanate of potash, nor yield a precipitate when neutralized with ammonia, and consequently was free from iron.

The oxalate of nickel was dissolved in pure ammonia; and after it had separated from the liquid by the gradual dissipation of the alkali, the remaining liquid had a pale pink colour, and on evaporation yielded a minute residue, which, after being heated to redness, weighed 0·22 of a grain, and formed a blue bead when fused with borax. Regarding it as the peroxide of cobalt, and as composed of 26 parts of metal and 12 parts of oxygen, the quantity obtained by analysis indicates 0·154 of a grain, or 0·535 per cent, of metallic cobalt.

The oxalate of nickel was decomposed by heat, and yielded

2.49 grains of the protoxide; equivalent, according to the atomic numbers of Dr THOMSON, to 1.904 grains, or 6.618 per cent, of metallic nickel.

I could detect no trace of chromium, manganese, copper, or any other substance; and therefore, the specimen presented to the Society by Mr ALLAN, consists of iron, nickel and cobalt, in the following proportions:

Iron	93.4
Nickel	6.618
Cobalt	0.535
	100.553

The result of this analysis is, I apprehend, decisive concerning the origin of the specimen before the Society; for while it differs from any compound hitherto discovered in the earth, it corresponds exactly both in appearance and composition with other masses of meteoric iron. Professor STROMEYER some years ago detected the presence of cobalt in a specimen of meteoric iron from the Cape of Good Hope; and he informs me, that, in an elaborate investigation of these singular metallic masses, he has detected cobalt as well as nickel in every specimen which he has analysed.



Fig. 1.

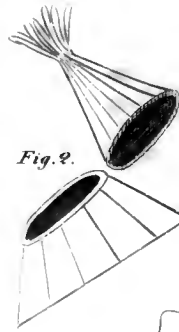
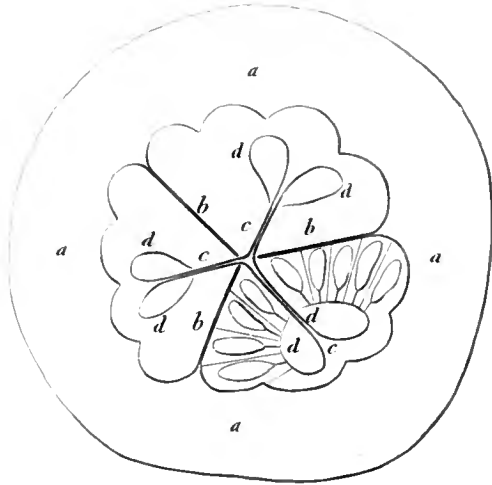

Fig. 2.

Fig. 3.

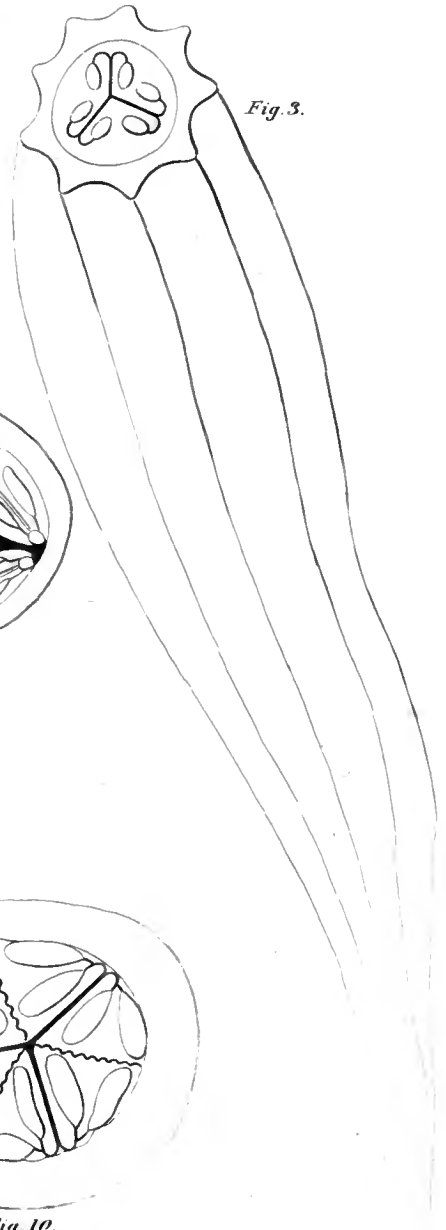

Fig. 5.

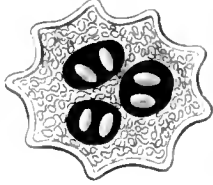

Fig. 4.

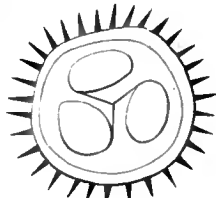
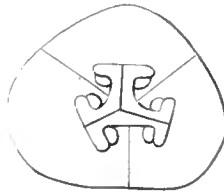

Fig. 6.

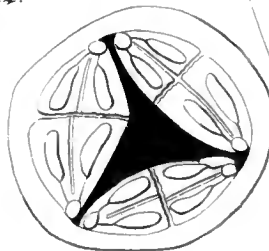

Fig. 11.



Fig. 8.

Fig. 7.

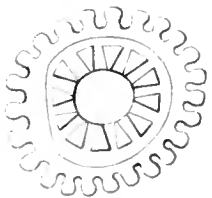
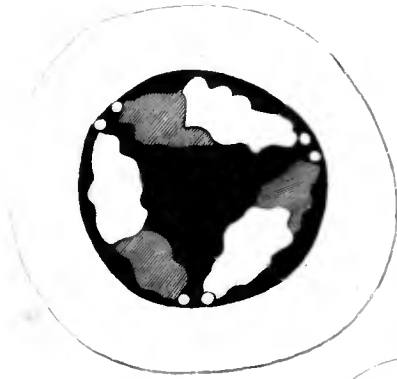

Fig. 12.

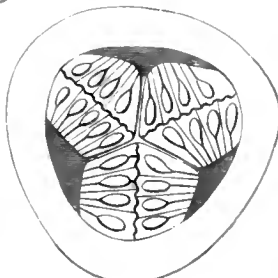

Fig. 9.

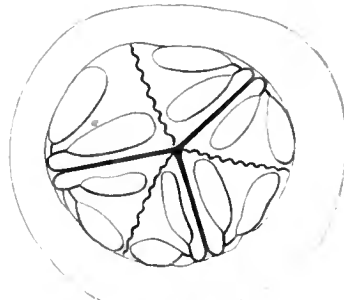

Fig. 10.

XIV. *Observations on the Structure of the Fruit in the Order of Cucurbitaceæ.* By FRANCIS HAMILTON, M. D. F. R. S. & F. A. S. LOND. & ED.

(Read 4th February 1828.)

THE fruit in this natural order does not appear to have been well understood by most botanists; and I shall therefore attempt to give a general view of what appears to me to be its structure; and most of the parts are visible in the section which is here given (Plate IX. Fig. 1.) of the beautiful but insipid Indian Melon (*Cucumis Melo*) called Phuti.

The outer parietes (Fig. 1. *a*.) when young, are thick, fleshy, and undivided by sutures, with an uniform rind, not separable from the fleshy part. As the fruit ripens, the rind in some cases becomes so thin as to be unable to contain the pulpy matter, and bursts either gradually, as in the melon, or with elasticity as in the *Momordica* and *Elaterium* of TOURNEFORT. At other times, the rind hardens either into a thin substance like leather or strong paper, as in the *Luffa*, or into a strong ligneous covering, as in the *Cucurbita leucanthema* or gourd. In these cases, it sometimes opens horizontally, by means of an operculum, which falls off and leaves an aperture for the seeds, as in Fig. 2. representing the summit of the *Luffa* called Picinna in the Hortus Malabaricus.

The fruit is divided into three loculi or cells, by three membranous septa, proceeding from the outer parietes towards the centre (Fig. 1. *b*), and in the young fruit accompanied by a thick covering of parenchymatous substance, like that of the parietes,

only softer, and more gelatinous, especially towards the seeds, which it every where surrounds. In general, the septa entirely disappear before the fruit ripens, as in Fig. 3. representing a section of the picinna in a half ripe state, or at least the septa cannot be readily traced among the thick substance by which they are surrounded, and which originally proceeded from them.

This soft substance consists sometimes of fibres intermixed with juice, and more or less spongy, which, when the fruit ripens, sometimes becomes either a corky mass, in which the seeds nestle, as in the *Cucurbita leucanthema*, or a dry fibrous texture, leaving a longitudinal cavity, in which the seeds are disposed loose, their umbilical cords having disappeared, as in *Luffa* (Fig. 5.). At other times, again, the fibrous pulp, as it ripens, undergoes less change, only it becomes more succulent, as in the *Cucurbita Pepo*, or more fibrous, as in the *Cucumis Colocynthis*. Instead of fibres, again, this soft substance is sometimes divided by membranes proceeding transversely from the septa, so as to form vertical cells, separating from each other the seeds, which appear in the transverse section, and which lie surrounded by a gelatinous fluid contained within the cells, as in Fig. 1. or as better represented by GÆRTNER (t. 33.) in his figure of the *Cucumis sativus*. Finally, this soft fibrous or membranous substance entirely separates from the septa, and a portion of it forms an arillus to cover each seed, as in several species of *Trichosanthes*, and as represented by GÆRTNER in the figure of the *Momordica Balsamina* and *Bryonia laciniosa* (t. 38.)

The fruit has three receptacula, to which the young seeds adhere generally by short umbilical cords, as in the Melon and Cucumber; but they are sometimes sessile, as in a singular kind of *Trichosanthes*, called Theba by the Bengalese, the receptacula of which, so long as discernible, envelope with their fleshy reflected edges the single ovum which each edge nourishes, as in the section (Fig. 4.) of its enlarged germen.

Each receptaculum in these fruits consists (Fig. 1. *c*) of two half membranes, uniting at the centre of the fruit ; so that each membrane, embracing the inner end of a septum in its central fold, has one half in one cell, and the other half in another cell. As these receptacula, consisting thus of a double membrane, are usually thicker than the real septa, and continue longer conspicuous, being less surrounded by the pulpy or fleshy nature of the fruit, they have often been considered as the true septa dividing the fruit into three cells, having entirely that appearance, as in Fig. 3. Still, however, when fully ripe, they often disappear, as even in the fruit now mentioned, the two rows of seeds that adhered to each septum in the half ripe fruit, when this ripens are lodged in a cavity formed by a dry fibrous texture, which succeeds to the fleshy substance secreted from the true septa (Fig. 5.) In other cases, as in the *Momordica Balsamina* (GÆRTNER, t. 32.), all vestiges of both septa and receptacula disappear, and the loose seeds remain floating in a gelatinous fluid, which squirts out when the fruit bursts.

Sometimes the receptacula do not extend to the parietes, but terminate in the middle of the cell, in which case they sometimes have only a single row of seeds annexed to their margin, as in the species of *Luffa* called *Ghoza* by the Bengalese (Fig. 6.), sometimes a double row (as in Fig. 3.) ; and rarely only one seed of each row comes to maturity, as in several species of *Bryonia*, and in the *Trichosanthes* called *Theba* by the Bengalese (Fig. 4.)

In general, however, the receptacula reach to the outer parietes, to which they adhere ; and as the portion between the centre and parietes often disappears before the fruit is ripe, what remains adhering to the parietes is considered as a parietal receptaculum, and the seeds are considered as centrifugal (GÆRTN. tom. i. Præf. xlvii.), directly contrary to fact. This appearance is very plain in the ripe fruit of the *Trichosanthes anguina*, or *Chichingya* of the Bengalese (Fig. 7.), which, when ripe, is per-

fectly unilocular, with three pair of longitudinal receptacula adhering to the parietes.

In some cases, the two membranes of which each receptaculum consists, continue united, until they terminate at the parietes by one or two thickened longitudinal margins, as may be seen in the common cucumber (Fig. 8.), as usually eaten when half ripe. In others, the membranes separate, sometimes before they reach the parietes, and then extending at an angle to each other, leave a surface on each side towards the general cavity of the cell, on which surface the seeds are inserted, as in the *Cucumis* called Gurmi by the Bengalese (Fig. 9.) At other times the membranes do not separate until they reach the parietes, when they are turned back towards the centre of the general cell, and have the seeds inserted either on their sides (Fig. 1. *d*), or on their edges, as in the *Trichosanthes* called by the Bengalese Bhungi kumra (Fig. 10.)

I have said that very often the central parts of the membranes composing the receptacula disappear, leaving only the parts next to the parietes, to which the seeds adhere; but in other cases the whole membranes remain; and, separating from each other in the centre as the fruit ripens, leave there an empty space, with the pulpy matter included in three cells, as it were, between three portions of the parietes and the three membranes of the receptacula. Traces of this structure may be observed in GERTNER'S figure of the *Cucurbita Pepo* (t. 88.); but in sections of the *Cucumis Melo* and *C. sativus*, when fully ripe, it is very remarkable (Fig. 11.) Finally, in other cases, the receptacula and septa entirely disappearing in the ripe fruit, leave the central parts of the parenchymatous matter in form of a columnar receptaculum, having the seeds imbedded among pulp, between it and the external parietes. These rows are sometimes six in number, a row having proceeded from each side of each receptaculum. In other cases, as in the *Momordica* called Khaska by the Benga-

lese (Fig. 12.), there are twelve rows, each edge of such receptaculum having supported two rows.

The seeds, so far as I have observed, are horizontal, except in the *Trichosanthes* called Theba, already mentioned, in which they are placed vertically; but this plant apparently differs a great deal from all the others that I have seen, in having a kind of bilocular nuts in place of seeds, one cell in each nut being empty. Besides, the seeds of this plant are covered with a spongy albumen, unless, from analogy, this may perhaps be considered as a thick inner membrane investing the seeds, while the nut may be called a thick outer integument, several other species having the outer membrane crustaceous and brittle. In general the seeds are flat; but in several there is a thick edging, around which, in the *Bryonia laciniosa*, is enlarged into a ring somewhat like the setting of a reading-glass. The embryo is straight, with thick cotyledons, and a small radícula placed at the end next the receptaculum.

END OF PART I.



XV. *Some Experiments on the Milk of the Cow-Tree.* By THOMAS THOMSON, M. D. F. R. S. L. & E. &c. Professor of Chemistry in the University of Glasgow.

(Read 17th March 1828.)

A PHIAL full of this liquid, one of the first specimens, I believe, that ever made its way to Great Britain, was lately sent to Dr HOOKER by Sir RALPH WOODFORD, Governor of Trinidad. It had been collected in Laguayra by Mr LOCKART, Director of the Botanic Garden in Trinidad. Dr HOOKER having been good enough to put this rare specimen into my possession, I made a few experiments to determine its constituents. The singular nature of the production, rather than any thing very striking in the results which I obtained, led me to suppose that they would not be unacceptable to the Royal Society.

This curious vegetable production was first made known to the scientific world by M. DE HUMBOLDT. But from the very imperfect account which he gives of the *Galactodendron utile**, there is reason to conclude that he had never seen it. It is certain at least that he had never seen it in blossom. The attention of MM. BOUSSINGAULT and MARIANO DE RIVERO was drawn to this important liquid by M. DE HUMBOLDT. They collected it accordingly, and subjected it to a chemical examination. They found its constituents to be wax, fibrin, sugar, a magnesian salt, which was not an acetate, and water. They could neither detect in it casein nor caoutchouc. The ashes after incineration

* This is the name given by HUMBOLDT to the tree which yields the cow-tree milk.

consisted of a mixture of silica, lime, phosphate of lime, and magnesia*.

The *Galactodendron utile* grows abundantly in the mountains situated on the north-west part of Venezuela, in South America, at a height, according to HUMBOLDT, of nearly 10,000 feet above the level of the sea, and consequently in a climate that cannot differ much from our own. The tree, from Mr LOCKART'S account, is a very large one, with leaves similar to those of the fig.

The juice of this tree, obtained by incision, is known by the name of the *milk of the cow-tree*. In the state in which I received it, it was a white opaque liquid, of the consistence of cream. When thrown upon a filter, a small quantity of a reddish-brown transparent liquid passed through, leaving a great quantity of white solid matter on the filter, the surface of which, as it dried, assumed a reddish-brown colour. The filter itself became gradually tinged of the same colour. It was found impossible to wash this solid matter. It attached itself to the filter, and rendered it quite impervious to water.

Another portion of the cow-tree milk was left for six weeks in a state of rest in a tall cylindrical glass. No deposit took place; the milk remained unaltered, excepting that its surface, where in contact with the air, assumed a reddish-brown colour. But after four months, the white matter had separated, and left a little brownish liquid at the bottom of the dish.

It had a sour smell, not the same with that of vinegar, but peculiar. Different individuals formed different opinions respecting this smell: some considering it as offensive, others as rather agreeable. The milk reddened vegetable blues. It had a very slightly acid taste, but in other respects bore considerable resemblance to the taste of cream.

Its specific gravity was found to be 1.01242.

* See an abstract of their experiments in the *Ann. de Chim. et de Phys.* xxiii. 219.

A portion of it was put into a small retort, and left exposed to a heat so regulated as never to exceed 212° . A transparent, colourless liquid gradually distilled over. This liquid had an acid but at the same time a sweetish taste. It reddened vegetable blues, and had the peculiar smell which characterized the cow-tree milk. To determine the nature of the acid, I put the liquid into a flask, with some pure carbonate of lime in powder, and digested the mixture till the liquid had lost the property of reddening vegetable blues. The portion of calcareous-spar which remained undissolved had assumed a reddish-brown colour, and a slimy consistence. The liquid, which was colourless, was filtered, evaporated to dryness, and the saline residue exposed to a heat somewhat higher than 300° , to decompose any vegetable matter with which the calcareous salt might be mixed. The brown residue was again digested in water, and the filtered liquid was a second time evaporated to dryness. A small quantity of white calcareous salt was obtained, on which a little sulphuric acid was poured, and heat applied. A strong odour of acetic acid was exhaled, showing that the small quantity of uncombined acid in the tree milk is the *acetic*.

When the cow-tree milk is mixed with caustic potash ley, or with dilute nitric, muriatic, or sulphuric acids, and then thrown on a filter, a dark brown coloured liquid passes through, and a white substance, not unlike wax, remains on the filter. But I could not succeed by this method in freeing the waxy matter from all impurities.

When the cow-tree milk is exposed to a low heat in an open vessel, the moisture is gradually dissipated, and a solid, grey waxy matter remains. When this matter is digested in water, it becomes white and opaque, while the water assumes a yellow colour, and, when concentrated, acquires the same dark reddish-brown colour which characterizes the liquid which passes through when the cow-tree milk is thrown on a filter. This liquid, how

soever concentrated, possesses no agglutinating properties like those of a solution of gum or sugar. When it was evaporated to dryness, a shining brown coloured matter remained, having an acrid taste, and somewhat altered by the heat. This substance bore a closer resemblance to *ulmin* than to any other vegetable principle, though its properties were different in some respects. Thus, its solubility in water was promoted by acids, which is not the case with *ulmin*. This brown substance is so scanty, that I never could procure more of it than one grain. It was therefore impossible to examine it minutely, or to determine its exact nature.

The white waxy substance left by the water being repeatedly digested in hot alcohol, was all dissolved, with the exception of a few pink-coloured flocks, which, after being thoroughly washed in hot alcohol, and then left to dry in the open air, assumed a dark brown colour. These flocks were tasteless, and insoluble both in water and alcohol. When digested in nitric acid, they swelled up, and assumed the same appearance as a piece of cork would have done, if placed in similar circumstances. By continuing the digestion, a solution was obtained. Being evaporated to dryness, the yellow coloured residue was bitter, and scarcely soluble in water. It was three times successively dissolved and digested in nitric acid; but no crystals of oxalic acid were formed.

In muriatic acid, this substance became soft and spongy like cork, but did not dissolve. In sulphuric acid, it gradually dissolved, blackening the acid, and, when water was added, a black deposit gradually subsided. In caustic potash ley, it became soft, and almost gelatinous, but did not dissolve.

I was more minute in my examination of this substance, because it seems to be what MM. BOUSSINGAULT and MARIANO DE RIVERO have distinguished by the name of *fibrin*. It exists in the cow-tree milk only in small quantity. It approaches much more nearly to *cork* than to any thing else. None of its charac-

ters have any close resemblance to those of *fibrin*. It is not unlikely that it was derived from the inner bark of the cow-tree.

But by far the most abundant constituent of the cow-tree milk is the substance which was dissolved in the hot alcohol. When the alcoholic solution cools, it becomes white and opaque like milk, and gradually deposits abundance of snow-white flakes. If we pour the alcoholic solution upon a filter, these snow-white flakes are retained, and the liquid passes through colourless-like water. When the matter thus retained is exposed to a moderate heat it melts, and on cooling assumes the form of a yellowish-white, opaque, wax-like substance, which I shall distinguish by the name of *gallactin*.

The alcohol thus freed from gallactin was put into a retort, and drawn off at a low heat, till only a small quantity of fluid remained. A transparent liquid substance gradually separated, as the alcohol was drawn off. This liquid was at first of the consistence of oil, and very adhesive. When left exposed to the air, it became gradually more and more viscid, and at length assumed the consistency of turpentine. A cuticle formed on its surface by degrees, which was not in the least adhesive. But the liquid below, when the cuticle was broken, continued as adhesive as ever. Six weeks' exposure to the air produced no farther change; but when I spread it thin on a plate of glass, it gradually assumed the appearance of a stiff, but soft transparent varnish.

The substance to which I have given the name of *gallactin*, has been described by MM. BOUSSINGAULT and MARIANO DE RIVERO, under the name of *wax*, to which it certainly bears a very striking resemblance; but as it differs from wax in some of its most remarkable properties, I have thought it better to distinguish it by a particular name, which I have borrowed from the generic name assigned by HUMBOLDT to the Cow-tree.

Gallactin, after it has been deposited from hot alcohol, and melted into a cake, is a solid substance, having a light yellowish-

white colour, and the opacity and consistence of wax. It is not brittle like bees-wax, but plastic, at least when the temperature is not lower than 60° , which was the heat of my laboratory when I was engaged in examining the properties of gallactin.

Like wax, it becomes a transparent liquid when exposed to heat. This liquid has many of the characters of a fixed oil, rendering paper transparent, and burning with great brilliancy when kindled by means of a wick. As the change from solidity to a state of liquidity takes place gradually, it is not easy to assign the true melting point of *gallactin*. At 117° it was solid, at 137° it was fluid. Between 117° and 137° it passes through an infinite number of different degrees of softness, before it becomes as liquid as possible. When we heat the white flocks which are deposited from alcohol, they emit abundance of aqueous vapour, and the gallactin does not become a transparent liquid till kept for some time in the temperature of 170° , showing that these white flocks consist of water and gallactin united together.

Gallactin is as tasteless as wax; but when put into the mouth it becomes soft and plastic, and adheres strongly to the teeth, having no bad resemblance, in point of consistency, to the gluten of wheat, when just freed from the starch. But the colour of this plastic gallactin is snow-white.

When gallactin is heated on a platinum or silver spoon, it melts, and then frothes strongly. When the frothing is at an end, the colour has become brownish-yellow. On increasing the heat to 640° , the gallactin begins to boil, and the vapour catching fire, burns with a bright yellow flame, giving out smoke, and ultimately disappears, leaving behind a minute quantity of white ashes.

This white residue has no action on vegetable blues, showing that it contains neither a fixed alkali nor lime. It dissolved in nitric acid, with the exception of a very minute portion, which was probably silica, though its quantity was too minute to admit

of examination. The nitric acid solution, so far as could be judged from the action of re-agents, consisted of a mixture of magnesia and phosphate of lime.

Gallactin, at the temperature of 60°, has a specific gravity of 0.969.

It dissolves in considerable quantity in alcohol and sulphuric ether, when assisted by heat. But it is again deposited in fine white flocks, when the solutions are allowed to cool.

Oil of turpentine dissolves it with facility; and when the oil is cautiously driven off, a yellow transparent varnish remains.

Olive oil dissolves it likewise with facility, and in considerable quantity before its consistency is sensibly altered.

In the properties hitherto enumerated, gallactin agrees with wax, excepting that it is more soluble both in alcohol and ether. But in the following properties, there is a marked difference between these two bodies.

1. Gallactin does not combine with the fixed alkalies, and does not seem capable of forming soap; whereas wax, as is well known, combines with facility with the alkalies, and readily forms with them a soap. It is true that MM. BOUSSINGAULT and MARIANO DE RIVERO say expressly that the wax of the cow-tree combines with the alkalies, and forms soap. But I digested gallactin in caustic potash ley for three days, and kept the mixture boiling for several hours, without any appearance of combination. When the ley was allowed to cool, the gallactin was found floating on its surface in the state of a solid cake, not sensibly altered in its properties. When wax is subjected to the same treatment, it forms a milky liquid with the ley in the course of a few minutes, and this liquid may be employed as a detergent, and of course possesses the properties of soap.

2. Cold nitric acid does not act sensibly on gallactin; but when heat is applied, an effervescence takes place, the gallactin assumes an orange colour, and gradually dissolves. If we pour

water into the solution, the gallactin precipitates, apparently little altered except in colour. But if we cautiously evaporate the nitric acid solution to dryness, a yellow, brittle, bitter-tasted substance remains, which is soluble both in water and in alcohol.

The aqueous solution of this substance is not affected by prussiate of potash or infusion of nut-galls; but with nitrate of lead, or nitrate of mercury, it gives a white precipitate. The precipitate with the former is scanty, with the latter abundant.

The alcoholic solution is yellow and very bitter tasted. Water occasions a precipitate, which, however, is re-dissolved on agitating the liquid. It is precipitated by nitrate of lead, nitrate of mercury, sulphate of zinc, sulphate of manganese, muriate of barytes, muriate of strontian, muriate of lime, and muriate of magnesia.

3. When gallactin is put into sulphuric acid, the liquid assumes a fine brownish-red colour, which gradually deepens. The acid appears green by reflected light, and deep brownish-red by transmitted light. The gallactin becomes soft and dark brown. When sulphuric acid is heated in contact with gallactin, it frothes and assumes a black colour, sulphurous acid being given out abundantly.

4. When gallactin is heated in water, it does not float on the top of the liquid, under the form of a transparent oil, as is the case with wax; but it imbibes a great deal of water, and assumes the form of a white, opaque, viscid matter, not unlike the gluten of wheat in its appearance and adhesive nature, but much more fluid.

Some of these characters approach those of the volatile oils; but gallactin is devoid of smell, and likewise of taste, and the temperature at which it boils is certainly not lower than 600° . By my thermometer it was 640° . In combustibility and consistence it resembles wax; but the action of alkalies, nitric acid,

sulphuric acid, and water, is quite different from the action of these bodies on bees-wax.

The transparent liquid matter which remains when the cold alcoholic solution from the cow-tree milk is distilled off in a retort, possesses very nearly all the characters of gallactin, if we except the liquid form under which it appears. It is equally fixed, and equally combustible. It is destitute of taste and smell, stains paper like an oil, does not combine with potash, but dissolves in nitric and sulphuric acids with the same phenomena as gallactin. It is lighter than water, but from its extremely adhesive nature, I could not determine its specific gravity exactly. Perhaps, therefore, it may be only another modification of gallactin. The two most striking circumstances in which it differs from gallactin, are its solubility in cold alcohol, and its liquidity. It remains to be seen whether, by long enough exposure to the open air, it will assume the appearance of gallactin. As far as I can judge hitherto, it never loses its transparency, but dries into a kind of varnish like the drying oils.

BOUSSINGAULT and MARIANO DE RIVERO mention sugar as one of the ingredients of the cow-tree milk. The boiling alcohol, after being freed from the gallactin, both solid and liquid, was found to hold a small quantity of matter in solution. It would not crystallize, neither was it separated by the addition of water. When the liquid was distilled off at a low heat, a white flocky matter remained, having a slightly sweetish taste, and soluble both in water and alcohol. This is probably the substance which these chemists have called sugar. If the property of crystallizing and of sweetening water be considered as belonging to sugar, this substance cannot claim the name. It is probably analogous to sarcocol in its nature.

XVI. *Account of the Constituents of various Minerals.* By THOMAS THOMSON, M. D. F. R. S. L. & E. Professor of Chemistry in the University of Glasgow.

(Read 17th March 1828.)

I HAVE been occupied for about two years past, assisted by the practical pupils in the laboratory belonging to the College of Glasgow, in analysing the most important specimens in my mineral cabinet, which seemed to me to require further elucidation. As my practical pupils are seldom fewer than six, and as they are employed the whole day, from nine in the morning till dinner-time, during the whole year, about six weeks in the summer excepted, which I have been in the habit of spending in the country, the number of analyses which has accumulated within that time, has become so great, and some of the results are so curious, that I have selected a few out of the number, for the gratification of the mineralogical public. It may be requisite to mention, in the first place, that when a pupil comes into my laboratory, the first thing which he does is to transcribe a set of practical rules, which I have drawn up for the benefit of my pupils. He is then set to analyse an easy mineral, with the composition of which I am already acquainted. I either shew him myself the different steps of the analysis, or request some of the farther advanced pupils to superintend the progress of the analysis, and ensure its accuracy. This method of superintendence is persisted in, till the pupil has familiarised himself with the different steps in the analysis of minerals, and till he has become well acquainted with the appearances of the different precipitates, and knows how to determine the complete separation and the purity of the differ-

ent earths, &c. I need hardly remark, that the analysis of the magnesian minerals is the most difficult, and requires the longest practice. As soon as I find that the pupil has acquired sufficient skill, he is left entirely to himself. All the precautions I think necessary to take, is to give him two or three rather difficult minerals, which I have previously analysed myself. This enables me to judge how far I can depend upon the accuracy and sagacity of the pupil. It has sometimes happened, in these cases, that the pupil has detected substances in the mineral which I myself had overlooked. In such cases, I repeat the analysis again myself, and generally find that the analysis of the pupil was more correct than the one that I had originally made. The pupil is always exercised in these kinds of investigations for a considerable time, and I do not give him new minerals (never before investigated) to analyse, till I have had ample evidence of his skill and accuracy.

The minerals of which I mean to give the analysis in this paper, were analysed in the laboratory of Glasgow College, almost all of them since July last. I shall take them up without any order, being guided, in some measure, by the comparative importance of each.

1. *Sillimanite.*

This mineral was found at Petty Pog, in the township of Saybrook, Connecticut. It was described and analysed by Mr BOWER (*Journal of the Academy of Sciences of Philadelphia*, p. 375). For the specimens which I was enabled to subject to analysis, I was indebted to Mr NUTALL.

It occurs in long four-sided prisms, generally bent, in a mica-slate rock ; but the portion in which the Sillimanite is found is quartz ; perhaps a vein.

The faces of the prism are too rough and uneven to admit the application of the reflecting goniometer. By my measurement with the common goniometer, they gave 110° , and 70° for their angles. But Mr BOWER, who probably was in possession of specimens better adapted for examination, states the angles of the prism to be $106^\circ 30'$, and $73^\circ 30'$. The base of the prism, he says, is inclined on the axis at an angle of 113° . In none of the crystals, in my possession, could the inclination of the base be observed at all.

Colour dark-grey, passing into clove-brown.

The crystals have a fibrous structure.

Lustre vitreous.

Brittle, and easily frangible.

Translucent on the edges.

Harder than quartz. It even scratches topaz.

We found the specific gravity to be 3.1636. But the quantity weighed was only 5.64 grains. Mr BOWER states it at 3.41.

Infusible before the blowpipe *per se*, and also with borax. Not acted on by acids.

5.64 grains of this mineral were subjected to a very careful analysis by Mr THOMAS MUIR. He found the constituents as follows :

Silica,	38.670
Alumina,	35.106
Zirconia,	18.510
Protoxide of iron, . . .	7.216
	<hr/>
	99.502

When the zircon was detected by Mr MUIR, I requested him to subject it to a rigid examination, to be sure that it was neither yttria, nor glucina, nor alumina. This was easily done by means of caustic potash, and sulphuric acid.

Mr BOWER'S analysis approaches pretty nearly to that of Mr MUIR, only he confounded together the alumina and zirconia. He obtained

Silica,	42.666
Alumina,	54.111
Oxide of iron,	1.999
Water,	0.510
	99.286

The constituents found by Mr MUIR give us for the chemical constituents of the mineral,

- 15 atoms silicate of alumina,
- 3 atoms silicate of zirconia,
- 1 atom silicate of iron.

Were the silicate of iron to be considered as accidental, Sillimanite would be a compound of

- 5 atoms silicate of alumina,
- 1 atom silicate of zirconia.

2. Cummingtonite.

This mineral, likewise, I owe to the kind attention of Mr NUTALL. It was found at Cummington, Massachussets, where it occurs in a rock composed of quartz, garnet, and Cummingtonite. Mr NUTALL expressed his suspicion that it would prove merely a variety of Sillimanite. But it is much softer, and in its chemical constitution is quite different.

It occurs in fine needles, constituting tufts of crystals, in which the needles diverge slightly from each other.

Colour greyish-white. Lustre silky.

Easily scratched by the knife ; but not by calcareous spar.

Opaque, or only translucent on the edges.

Specific gravity 3.2014.

Infusible *per se* before the blowpipe. With carbonate of soda it fuses with effervescence into a dark glass. Fuses with borax and with biphosphate of soda into a black glass, showing the presence of much iron and manganese.

It was analysed by Mr THOMAS MUIR, who found the constituents to be

Silica,	56.543
Protoxide of iron, . .	21.669
Protoxide of manganese,	7.802
Soda,	8.439
Driven off by red heat, . .	3.178
	<hr/>
	97.631

As the loss in this analysis amounted to almost 2.5 per cent., I requested Mr MUIR to examine the mineral for fluoric acid and phosphoric acid ; but no traces of either of them could be found. If we suppose the loss of weight to be soda, the chemical constitution of Cummingtonite will be

9 atoms tersilicate of iron,
3 atoms tersilicate of manganese,
5 atoms tersilicate of soda.

If the mineral contain no more soda than was found by Mr MUIR, it will be composed of

3 atoms of tersilicate of iron and manganese,
1 atom tersilicate of soda.

I think it most likely that this last view is the nearest the truth.

3. *Corundum.*

The specimen chosen for the analysis was a beautiful white semitransparent crystal from Madras, constituting a six-sided prism of considerable size. It was evidently very pure, and had a distinctly foliated structure. The faces of cleavage were so brilliant, that the specimen approached pretty closely to a sapphire. The specific gravity was 3.9511. This mineral was analysed with great care by Mr THOMAS MUIR. During the trituration in the agate mortar, there was a quantity of silica abraded from the mortar, and mixed with the pounded corundum. The constituents were found to be,

Alumina,	. . .	98.46
Silica,	. . .	1.54
		100.00

But the quantity of silica abraded from the mortar was 1.56. Hence it is clear that the corundum is composed of alumina alone, without any silica whatever. The whole of the alumina, to make sure of its purity, was converted into alum.

4. *Hyacinth from Expailly.*

For the analysis of this mineral, very pure crystals were picked out. I requested Mr THOMAS MUIR, who made the analysis, to heat the crystals to redness, and select those that had become colourless. When pounded in the agate mortar, no loss of weight was sustained by the mortar, showing that the hyacinth

is much softer than corundum. The analysis was conducted by heating the pounded mineral with carbonate of soda, in a platinum crucible. Much of the success depends upon the fineness of the powder to which the hyacinth is reduced. The fused mass was softened by water, and dissolved in muriatic acid. The portion not taken up by the muriatic acid, was again heated with a new portion of carbonate of soda, and the solution in muriatic acid repeated. A third heating with carbonate of soda, and digestion in muriatic acid, furnished a complete solution of the whole mineral. The rest of the analysis was obvious and easy. The constituents were found to be

Silica,	. . .	33.32	
Zirconia,	. . .	66.00	with a trace of iron.
<hr style="width: 20%; margin: 0 auto;"/>			
99.32			

The specific gravity of the crystals analysed was 4.6811.

It is plain from this analysis, that hyacinth is a sesquisilicate of zirconia, or a compound of

$1\frac{1}{2}$ atom silica,	3	
1 atom zirconia,	6	
<hr style="width: 20%; margin: 0 auto;"/>			
9			

5. *Chrysoberyl from Brazil.*

Mineralogists are aware, that two different analyses of this mineral have been laid before the public, within these few years; one by ARFVEDSON, and another by Mr SEYBERT.

According to ARFVEDSON, its constituents are,

Alumina,	81.43	
Silica,	18.73	
	100.16	(<i>Kongl. Vetens. Acad.</i> <i>Handl.</i> 1822, p. 90).

While SEYBERT found the composition in two different specimens as follows :

Alumina,	73.60		68.666
Glucina,	15.80		16.000
Silica,	4.00		5.990
Protoxide of iron,	3.38		4.733
Oxide of titanium,	1.00		2.666
Moisture,	0.40		0.666
	98.18		98.730

The first of these specimens was from Hoddam ; the second from Brazil. (SILLIMAN'S *Jour.* 8. 109.)

M. ARFVEDSON'S analysis was conducted, by fusing the pounded chrysoberyl with caustic potash, and digesting the matter in muriatic acid. This process was repeated, and the portion which ultimately resisted the action of the muriatic acid, he considered as silica. This was very unlikely to be a correct view of the case. The silica, if any be present, ought to be more easily removed by fusion with caustic potash, than any of the other constituents. I analysed chrysoberyl immediately after seeing SEYBERT'S analysis, and found that the portion remaining, after the first fusion of the mineral with caustic potash, and digestion in muriatic acid, is a combination of glucina and oxide

of iron. Mr THOMAS MUIR repeated my analysis last summer and I give his in preference to mine, because I consider it as more carefully made.

Good crystals were selected for the analysis, the specific gravity of which was found to be 3.7112. A portion of silica was abraded from the agate mortar. This silica was detected in the powder; but if it be abstracted, then chrysoberyl contains no silica whatever. Its constituents were found to be

Alumina,	76.752
Glucina,	17.791
Protoxide of iron, . . .	4.494
Driven off by heat, . . .	0.480
	99.517

The last portion, which is so difficult of decomposition, was found to yield to ignition, with a sufficient quantity of carbonate of soda. A good deal of the success depends upon reducing the mineral to a very fine powder. Neither Mr MUIR nor myself found any oxide of titanium, though we looked for it carefully.

If we consider all the constituents found in the chrysoberyl to be chemically combined, it will be a compound of

- 6 atoms sexaluminate of glucina.
- 1 atom sexaluminate of iron.

The alumina in this mineral seems to act the part of an acid.

6. *Brewsterite.*

It is known to mineralogists that Mr BROOKE first constituted this mineral (*Edin. Phil. Journ.* vi. 112) a peculiar species, and named it in honour of Dr BREWSTER, Secretary to this Society.

It had previously been considered as a stilbite, and as an apophyllite. Mr BROOKE, in the paper just referred to, has described the primary form and modifications of its crystals.

Its colour is white ; its lustre vitreous. It is transparent, and has a specific gravity of 2.628. It fuses with great facility before the blowpipe, like the zeolites, to which it has obviously an affinity. This mineral was analysed with much care by Mr WILLIAM MUIR, but he obtained an excess of about $3\frac{1}{4}$ per cent. I therefore requested Mr RICHARD MITCHELL, who was a much more experienced analyst, being in my laboratory for the second year, to repeat the analysis, with every attention to accuracy. The result of his analysis almost coincided with that of Mr MUIR, and there was the same excess of $3\frac{1}{4}$ per cent. Upon examining the silica, I found that it cohered strongly before the blowpipe. It had, therefore, retained a little soda : for the analysis had been conducted by igniting the powdered Brewsterite with carbonate of soda, and dissolving the fused mass in muriatic acid. It was obvious from this, that the excess was chiefly owing to the state of the silica.

The constituents are as follows :

Silica,	58.800
Alumina,	18.912
Lime,	12.384
Potash,	1.500
Water,	11.700
	103.296

If we admit a slight excess in the silica, from the cause above specified, the constituents of the mineral seem to be



or it consists of

2 atoms bisilicate of alumina.

1 atom tersilicate of lime, with some tersilicate of potash.

3 atoms water.

Mr MITCHELL, at my request, tested the alkali for soda in the following manner: The alkaline solution in muriatic acid was mixed with an excess of muriate of platinum, and the mixture was evaporated to dryness on the sand-bath, by a gentle heat. The dry mass was digested in spirits, and the liquid, holding in solution muriate of platinum, was evaporated to dryness in a platinum crucible, having been previously mixed with some sulphuric acid. The dry mass was ignited to reduce the platinum to the metallic state. The matter in the crucible was now digested in water. This liquid being slowly evaporated to dryness, no sulphate of soda appeared; nothing indeed was found but a trace of sulphate of lime, too small to admit of being weighed. Thus it appears that Brewsterite contains no soda.

7. *Amianthus from Sardinia.*

The beautiful white amianthus from Sardinia, composed of threads, which can be easily teased from each other, and admit of being spun, is well known to mineralogists. As it possesses no marked characters, it is only by analysis that we can form an opinion of the mineral species with which it is connected. I therefore requested Mr RICHARD MITCHELL to analyse a specimen of this beautiful amianthus, for which I was indebted to my friend CHARLES MACINTOSH, Esq. of Crossbasket. Its specific gravity was 1.551.

The result of the analysis was as follows :

Silica,	55.908
Magnesia,	27.068
Lime,	14.632
Alumina,	1.820
Protoxide of iron,	6.528
	<hr/>
	105.956

I believe the excess in this analysis to be chiefly owing to the magnesia, which had in all likelihood been mixed with a portion of the double carbonate of potash and magnesia : For the method which I employ to analyse minerals containing lime, magnesia and alumina, is to throw down the alumina and oxide of iron by bicarbonate of potash. The liquid thus freed from alumina, &c. is neutralised by muriatic acid, and the lime thrown down by oxalate of ammonia. The liquid thus freed from lime, is heated to the boiling temperature, and gradually mixed with carbonate of soda, while kept boiling briskly, to throw down the magnesia. If the carbonate of soda be added too rapidly, or if the liquid be not made to boil briskly, the compound salt is apt to make its appearance, in which case, it is exceedingly difficult to get the magnesia in a state of purity.

Whoever will take the trouble to compare the preceding analysis of amianthus with the numerous analyses of amphibole by *BONSDORF*, in the *Memoirs of the Stockholm Academy* for 1821, p. 192, will see at once that it is merely a variety of that very proteus-looking mineral.

One of the most common varieties of amphibole consists of

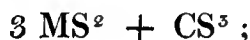

or it is a compound of

3 atoms bisilicate of magnesia.

1 atom tersilicate of lime.

Now, this is the variety of amphibole to which the amianthus approaches nearest.

8. *Nutallite.*

This mineral was brought into this country some years ago by Mr NUTALL. Its locality is Bolton, Massachusetts. It was considered in America as elaeolite. Mr BROOKE examined it in 1824, found the crystals much softer, and obtained by cleavage a right square prism, which he considered as the primary form. He named the mineral after Mr NUTALL, who first brought it to this country. For the specimens in my possession, I am indebted to Mr NUTALL, who was so obliging as to send me two or three pretty pure pieces of it, one of which was submitted to analysis. The crystals are imbedded in a rock composed of calcareous spar, and a green coloured mineral, in grains having the aspect of amphibole.

The crystals of Nutallite in my possession, are eight-sided prisms, which cleave in the direction of the faces of a right square prism.

The colour is white; in some parts of the crystal yellowish; in others bluish or greenish. The yellowish-white parts of the crystal are transparent; the bluish nearly opaque; showing evidently the presence of some foreign matter. Streak white.

Lustre vitreous.

Easily scratches by the knife.

Specific gravity in different specimens was found to vary from 2.748 to 2.758.

By the analysis of Mr THOMAS MUIR, Nutallite is composed of

Silica,	37.808
Alumina,	25.104
Lime,	18.336
Protoxide of iron,	7.892
Potash,	7.305
Water,	1.500
	97.945

Were we to consider these constituents as all essential to the chemical constitution of the mineral, it would consist of

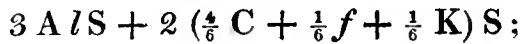

that is to say, of

3 atoms silica of alumina.

1 atom of a triple silicate of lime, peroxide of iron and potash, in the proportions given in the formula : viz.

4 atoms silicate of lime.

1 atom persilicate of iron.

1 atom silicate of potash.

But whether any of these (and how many) be not accidental ingredients, can only be determined when we have an opportunity of analysing Nutallite from other localities.

9. *Pipestone.*

I give this name to a mineral from North America, which the Indians use for making tobacco-pipes. The specimen in my pos-

session, which is of considerable size, I got from my friend and former pupil Dr SCOULER ; who some years ago passed a summer on the north-west coast of America, between Nootka Sound and Columbia River ; and, among many other natural productions of the country, he brought home specimens of this pipestone. He procured it from the Indians, and was ignorant of the part of the country where it occurs, or the kind of rock with which it is associated.

It constitutes an amorphous compact stone, through which a few scales of mica are scattered, having much the appearance of claystone ; but softer.

Fracture earthy.

Colour light-greyish blue. Powder very light smalt blue.

It is rather harder than gypsum ; but soft enough to be scratched by the nail. Sectile. Opaque.

The particles, when scraped off with a knife, feel gritty between the teeth.

Specific gravity, 2.606.

It does not melt *per se* before the blowpipe.

Mr THOMAS MUIR made an analysis of it at my request, and found the constituents to be

Silica,	55.620
Alumina,	17.208
Soda,	12.160
Peroxide of iron,	7.612
Lime,	2.256
Magnesia,	0.112
Water,	4.600

99.568

It consists of four silicates ; namely, of alumina, soda, peroxide of iron, and lime. Were we to consider the bisilicates of iron

and lime to be only accidental substances, then the mineral would be $2 A / S^2 + NS^2$, or it would consist of

2 atoms bisilicate of alumina.

1 atom bisilicate of soda.

There is a slight excess of silica and alumina; but we have no data to determine its chemical constitution with certainty. In its composition, this stone bears some resemblance to the analcime.

10. *Tersilicate of Lime.*

This mineral has been hitherto found only at Gjellebäk, four Swedish miles ($26\frac{2}{3}$ English miles) south from Christiania in Norway, in a transition limestone, which extends to the south along the sea-coast. It was taken for a tremolite, till HISINGER subjected it to an analysis in 1823, and ascertained its real nature. (*Kongl. Vetens. Acad. Hand.* 1823, p. 177.)

When occupied about a year ago in arranging my mineral cabinet, I found among my tremolites a specimen which struck me as peculiar. I requested Mr RICHARD MITCHELL to analyse it. The result was, that it was a tersilicate of lime, in a much purer state than the specimen subjected to analysis by HISINGER. I do not recollect how the mineral came into my possession, and there is no label on the specimen. But probably its locality is the same as that of the tersilicate of lime analysed by HISINGER.

Colour white.

Fracture fine radiated, giving the mineral a good deal of the appearance of tremolite. The specimen is not crystallised.

Phosphoresces strongly when rubbed or struck; but only slightly when heated.

Easily frangible, and reduced to powder.

Opaque.

Dull.

About the hardness of calcareous spar.

Specific gravity, 2.2055.

Does not effervesce in acids. In this respect my specimen differs from that analysed by HISINGER, which effervesces weakly in acids, when in masses ; but strongly when in powder.

Before the blowpipe it fuses with difficulty on the edges (like table-spar), into a colourless, semitransparent glass. With borax it fuses easily, and forms an amethyst-coloured glass.

Its constituents, as determined by Mr R. MITCHELL, are as follows :

Silica,	55.200
Lime,	34.284
Alumina,	4.160
Protoxide of iron,	2.896
Moisture,	3.400
	<hr/>
	99.940

The constituents, as determined by Mr HISINGER, are as follows :

Silica,	43.368
Lime,	38.433
Protoxide of Manganese,	4.962
Protoxide of Iron,	1.434
Carbonic acid,	11.368
	<hr/>
	99.565

If the carbonic acid was combined with lime, as it must have been, it would require 14.46 grains, reducing the lime in combi-

nation with the 43.368 gr. of silica, to about 24 grains. This approaches pretty nearly the ratio of 55.2 to 34.284, found by Mr MITCHELL in my specimen.

In my specimen there is a slight deficiency, and in HISINGER'S a slight excess of silica. It is obvious, from a comparison of the two analyses, that the other constituents are accidental. The mineral is CS^3 , or a compound of

3 atoms silica,	. .	6
1 atom lime,	. .	3.5
		9.5

My specimen of tersilicate of lime was accompanied by a snow-white, amorphous, soft matter, bearing a good deal of resemblance to the tersilicate, but entirely without the radiated structure. Its specific gravity was found to be 2.839. Mr MITCHELL analysed it at my request, and found it composed of

Silica,	56.67
Lime,	39.00
Alumina,	2.355 slightly tinged with iron.
		98.025

There is a slight increase of the lime; but it is obviously the same mineral with the tersilicate of lime, making allowance for the alteration produced on its texture by the action of the weather.

11. *Leelite of Dr CLARKE.*

I got a specimen of this mineral, which occurs at Grythittan in Nerike, many years ago from Mr SVEDENSTJERNA. I had arranged it in my cabinet as a specimen of compact felspar.

Its colour is flesh-red; its structure compact; its fracture splintery, and also conchoidal; its transparency that of horn; its specific gravity 2.606. Mr R. MITCHELL analysed it at my request, and obtained

Silica,	81.91
Alumina,	6.55
Protoxide of Iron,	6.42
Potash,	8.88
	<hr/>
	103.76

Dr CLARKE had analysed it, and he states its constituents to be

Silica,	75.0
Alumina,	22.0
Manganese,	2.5
Water,	0.5
	<hr/>
	100 *

It is possible that the specimen analysed by Dr CLARKE might have differed from mine; but no great confidence can be put in Dr CLARKE'S analyses, as he had not much practice, and was not probably able to determine the purity of the substances

* See *Annals of Philosophy*, xi. 367.

which he separated, with sufficient accuracy to be sure of his results. The art of analysis is soon learnt, when the pupil has previously made himself acquainted with the general principles of chemistry. I have had pupils who could analyze with great accuracy very difficult minerals, after less than a year's practice.

Leelite is obviously a compound of octosilicates, consisting of $2\text{AlS}^8 + \text{fS}^8 + \text{KS}^8$; or

2 atoms octosilicate of alumina,

1 atom octosilicate of iron,

1 atom octosilicate of potash.

It certainly differs from compact felspar.

12. *Bucholzite.*

The first account of this mineral was published in 1819 by Dr BRANDES, in the 25th volume of the first series of SCHWEIGER'S Journal. He had obtained it from Professor WEISS, and its locality was the Tyrolese Alps. BRANDES gives an analysis and very imperfect description, and I have seen no farther account of the mineral in any mineralogical treatise since published. About three years ago, Mr NUTALL was kind enough to send me some minerals from the United States. One of these from Chester on the Delaware, south-west from Philadelphia, he called Bucholzite, on the authority of Mr HEULAND. About a year ago, I got new specimens from him from the same place, which were larger, purer, and better characterized.

The colour of Bucholzite is greyish-white, with a very slight tinge of yellow, not recognizable in the purest specimens.

It is composed of fibres which in some places appear curved, and, when viewed through a glass, assume the appearance of plates or imperfect crystals.

Lustre silky.

Not scratched by quartz, and scarcely by topaz, but easily by sapphire.

Brittle.

Easily frangible ; fragments sharp-edged.

Specific gravity 3.193.

It was analysed by MESSRS HILTON and MITCHELL, and its constituents found to be,

Silica,	46.40
Alumina,	52.92 slightly tinged with iron.
	<hr/>
	99.32

BRANDES'S analysis gave

Silica,	46
Alumina,	50
Protoxide of Iron,	2.5
Potash,	1.5
	<hr/>
	100

It is clear from the analysis, that the American specimens analysed in my laboratory were much purer than those in the possession of Dr BRANDES.

Bucholzite is obviously a silicate of alumina, or a compound of

1 atom silica,	2	or	46.4
1 atom alumina,	2.25		52.2

numbers which approach very nearly to the result of the analysis.

13. *Calcareo-sulphate of Barytes.*

This mineral occurs pretty abundantly in the lead-mine of

Strontian, where it is one of the various substances which serve as a gangue to the ore.

The colour is snow-white.

The mineral is massive. Structure foliated, or at least scaly. Fracture even.

Rather softer than common sulphate of barytes. Indeed it is scratched by the nail.

Sectile.

Lustre pearly.

Translucent on the edges.

Specific gravity 4.1907.

It was analysed by Mr THOMAS MUIR, who found the constituents as follows :

Sulphuric Acid,	34.540
Barytes,	48.945
Lime,	6.605
Silica,	4.140
Alumina,	3.460
Protoxide of Iron,	0.450
Strontian,	0.790
Carbonic Acid,	0.334
Moisture,	0.565
	99.829

The mode of analysis followed was to heat the pounded mineral with carbonate of soda, till complete decomposition was induced. The heated mass was softened in water, and digested in that liquid till every thing soluble was taken up. The alkaline liquid was saturated with muriatic acid, and evaporated to dryness to obtain the silica. The dry mass was digested in water, acidulated with muriatic acid. The silica left behind was edulcorated, ignited, and weighed. The muriatic acid solution was mixed with a sufficient quantity of muriate of barytes to throw

down the sulphuric acid. The sulphate of barytes wasedulcorated, ignited, and weighed.

The carbonates of barytes, lime, &c. were dissolved in muriatic acid, and the alumina and oxide of iron were precipitated by caustic ammonia. The liquid thus freed from alumina and iron, was evaporated to dryness, and the dry salt digested in alcohol, which dissolved the muriates of lime and strontian, and left the muriate of barytes. This last muriate was dissolved in water, and the barytes thrown down by sulphate of soda, and its weight determined in the usual way.

The muriates of lime and strontian were converted into nitrates. The dry nitrates were digested in alcohol, which dissolved the nitrate of lime, and left the nitrate of strontian.

The quantity of carbonic acid was not determined experimentally, but deduced from the quantity of strontian present in the mineral.

It is obvious that the mineral consisted of

Sulphate of Barytes, . . .	{ Acid, 25.100 } { Base, 48.945 }	. 74.045
Sulphate of Lime, . . .	{ Acid, 9.436 } { Base, 6.605 }	. 16.041
Carbonate of Strontian, . . .	{ Acid, 0.334 } { Base, 0.790 }	. 1.124
Silica, Alumina, Protoxide of Iron,		8.050
Moisture,		0.565
		<hr/> 99.825

If we consider the carbonate of strontian, the silica, the alumina, protoxide of iron, and moisture, as accidental substances, then the mineral is a compound of

5 atoms sulphate of barytes,
2 atoms sulphate of lime.

14. *Green Carbonate of Strontian.*

It is well known to mineralogists, that, in the lead-mine of Strontian in Argyleshire, two different varieties of carbonate of strontian occur, the one green coloured, the other yellowish-brown. But though these varieties have been long known, I am not aware that they have hitherto been subjected to a chemical examination, or that their true chemical constitution has been determined. I had, indeed, analysed both several years ago; but the results of my investigation have hitherto lain by me unpublished. Last summer, Mr THOMAS MUIR repeated the analysis of both varieties with very great accuracy, and I shall here state the result of his investigation.

It is well known that the green variety has an asparagus-green colour, and that it is composed of imperfect prisms, slightly diverging from a common centre. The specific gravity is 3.713. The constituents are,

Carbonate of Strontian, . . .	93.493
Carbonate of Lime,	6.284
Carbonate of Manganese, . .	trace.
Oxide of Iron and Alumina,	0.010
	99.787

or almost exactly of

- 1 atom carbonate of lime,
- 10 atoms carbonate of strontian.

To what is the green colour of this mineral owing?

15. *Brown Carbonate of Strontian.*

This variety, judging from the number of specimens in my

possession, seems to be almost as abundant in Strontian mine as the preceding.

Its colour is yellowish-brown.

It is composed of needles much finer than those of the green variety, and, as in it, slightly diverging from a common centre.

Specific gravity 3.651.

Its constituents, as determined by Mr THOMAS MUIR, are,

Carbonate of Strontian, . . .	91.171
Carbonate of Lime, . . .	8.642
Carbonate of Manganese, .	0.099
Oxide of Iron and Alumina,	0.078
	<hr/>
	99.990

It is a compound of

- 1 atom carbonate of lime,
- 7 atoms carbonate of strontian.

16. *Quatersilicate of Alumina.*

About two years ago, I received from Mexico, among a variety of minerals, one which I set aside for a chemical examination. It was ticketed, "Piedran Barras? Dipiro de HAÜY? De Cymophan." It was obvious at first sight that the mineral was neither the Dipyre of HAÜY nor Cymophane; nor could I assign it a place in my cabinet.

Its colour is yellowish-white.

Its structure is radiated; for it is composed of imperfect, oblique four-sided prisms, diverging slightly as from a centre. The surface of the prisms is striated longitudinally; and I could discover no cleavage to lead to any inference respecting the primary form.

Lustre pearly. When pounded, it appears to be partly compact, and partly composed of pearl coloured flakes or scales, having somewhat the appearance of talc. Lustre shining.

Opaque, or only slightly translucent on the edges.

It is softer than calcareous-spar, but harder than gypsum. The nail makes an impression on it with difficulty.

Specific gravity 2.688.

Infusible before the blowpipe.

The specimen was interspersed with iron-pyrites.

I requested Captain LEHUNT to analyse this mineral, which he did with great care, examining both the compact and scaly portion separately; but he found the constituents of both exactly the same, namely,

Silica,	72.52
Alumina,	20.44
Protoxide of Iron,	2.40
Water,	3.40
	98.76

If we exclude the iron and water as accidental ingredients, it is obvious that the mineral is Al_2Si_4 , or composed of

4 atoms silica,
1 atom alumina.

It is therefore a quatersilicate of alumina.

17. *Cinnamon-stone.*

Whoever compares the cinnamon-stone with garnet, will, I think, be under no hesitation about concluding that the two minerals belong to the same species. The crystalline shape of both is the same, the hardness the same, the specific gravity the same,

and the chemical constitution the same. The only difference that can be laid hold of is the shade of colour, which constitutes too insignificant a distinction to be adopted as a specific difference. Whoever will compare the constituents of cinnamon-stone, as determined by KLAPROTH, ARFVEDSON, NORDENSKIÖLD, C. G. GMELIN, with the analyses of the different varieties of garnet by TROLLÉ-WACHMEISTER, will be satisfied that the chemical constitution of both is the same.

Captain LEHUNT analysed at my request a very fine specimen from North America sent me by Dr TORREY of New York, which had the colour of cinnamon-stone, and the crystalline figure and hardness of garnet. Its specific gravity was 3.631. Its constituent parts were as follows :

Silica,	39.826
Lime,	30.574
Alumina,	29.141
Protoxide of Iron, . . .	9.459
	100

My opinion respecting the garnet, founded on a pretty copious induction of facts, is, that there exist in nature three distinct species, composed as follows :

1. { 1 atom silicate of alumina,
1 atom silicate of iron.
2. { 1 atom silicate of alumina,
1 atom silicate of lime.
3. { 1 atom silicate of lime,
1 atom silicate of iron.

The greater number of garnets consists of mixtures or combinations of these three species in various ways. Now, the cinna-

mon-stone obviously belongs to the second species, or it is composed of

- 1 atom silicate of alumina,
- 1 atom silicate of lime.

18. *Marmolite.*

This mineral occurs in veins in the serpentine of Hoboken in New Jersey, and in the same situation in the Bare Hills near Baltimore. It was first described and named by Mr NUTALL.

Its colour is pale green or greenish-grey.

Texture foliated, with the laminae thin, and often parallel, as in diallage.

It cleaves parallel to the sides of an oblique and compressed four-sided prism.

Lustre pearly. Powder unctuous or shining.

Translucent.

Specific gravity, as determined in my laboratory, 2.410. Mr NUTALL states it at 2.470.

Before the blowpipe, it decrepitates, hardens, and slightly exfoliates, without shewing any signs of fusion.

Mr NUTALL analysed it, and found its constituents to be,

Silica,	36
Magnesia,	46
Water,	15
Lime,	2
Protoxide of Iron and Chromium, .	0.5
	99.5 *

* *Silliman's Journal*, iv. 19.

Mr NUTALL was good enough to send me several specimens of it, one of which was analysed at my request by Mr THOMAS STEEL. The result of two successive analyses were as follows :

Silica,	41.256
Magnesia,	41.720
Alumina,	1.000
Peroxide of Iron,	0.400
Water,	17.680
	<hr/>
	102.056

It is therefore a hydrous sesquisilicate of magnesia, or a variety of the precious serpentine, or picrolite of HAUSMANN.

I have already extended this paper to a greater length than I intended. Yet I have been able to introduce but a very small number of the many analyses made by my practical pupils during the course of the two last years ; and I have omitted altogether a pretty numerous set of analyses made by myself during that time. These I may perhaps lay before the public at some future opportunity. Meanwhile it is highly requisite to attend to the adage of TERENCE, "*Ne quid nimis.*"

XVII. *Account of a remarkable peculiarity in the Structure of Glauberite, which has one Axis of Double Refraction for Violet, and two Axes for Red Light.* By DAVID BREWSTER, LL. D. F. R. S. LOND. & EDIN.

(Read 7th January 1829.)

IN the optical and mineralogical classification of crystals which I published in the article Optics in the Edinburgh Encyclopædia, I have arranged Glauberite among those in which I discovered two axes of double refraction. The specimen which I used, however, was so small and imperfect, that I could not measure the inclination of the lines of no polarisation, or ascertain with any accuracy the laws of its action upon light. Mr WILLIAM NICOL, whose ingenuity is already well known to this Society, put into my hands two specimens of Glauberite, which he had skilfully prepared for showing its system of polarised rings; and, by the use of these, I have been enabled to detect a very remarkable property in this mineral.

When examined by common polarised light, the tints of its rings are exceedingly anomalous, and we seek in vain for the two poles where the double refraction and polarisation generally disappear. The cause of this irregularity immediately shews itself, when we expose the crystal to homogeneous rays. In the red rays, we observe the phenomena of two distinct axes, the inclination of the resultant axes being about 5° . This inclination gradually diminishes in the *orange*, *yellow*, and *green* rays, and in the *violet* the two poles coincide, exhibiting the system of rings round a single axis of double refraction. In all these cases, the character of the principal axis is *negative*. It seems to be per-

pendicular to one of the faces P of the primitive form, as given by HAÜY, and the plane of the axes at right angles to a line bisecting the acute angle of the same face.

When Mr HERSCHEL discovered the very remarkable property in Apophyllite, in virtue of which it exercised a negative influence over the red rays, a positive influence over the blue rays, and no influence at all over the yellow ones, I shewed in a paper read before this Society, and printed in their Transactions *, that these apparently irreconcilable actions, related, as they seemed to be, to a single axis of double refraction, could be calculated in the most rigorous manner, by supposing the crystal to have *three* positive axes at right angles to each other, each of which exercises a different dispersive action upon the differently coloured rays. This result, which is of considerable importance in the theory of double refraction, is strikingly confirmed by the phenomena of Glauberite, while these at the same time present us with a new and still less equivocal case of the composition of axes.

In the case of *Glauberite*, observation exhibits to us one *negative* axis A, which is the *single* axis for the violet light, and the *principal* axis for the *red* and the other less refrangible rays; and, at the same time, it presents to us a second axis B, which may be either *negative* or *positive*, but which must be 90° distant from A. If it is *negative*, it must be in a plane perpendicular to the plane passing through the two resultant axes for *red* light; and it must bear to A the ratio of the square of the sine of $2\frac{1}{2}^\circ$ (half the inclination of the resultant axes) to unity. If it is *positive*, it must lie in the plane passing through the resultant axes, and it must bear to A the ratio of the square of the sine, to the square of the cosine of $2\frac{1}{2}^\circ$. But whether it be *positive* or *negative*, it exercises no action whatever upon *violet* light, a

* Vol. IX. p. 317.

supposition so absurd, that it cannot for a moment be received. Since the combination of axes, therefore, indicated by experiment for the *single* system of rings in *violet* light, and for the *double* system in the other rays, involves a physical absurdity, we must seek for a new combination, not liable to such an objection.

If we suppose that the axis A for violet light is the resultant of other axes, and that these other axes are two positive axes B and C at right angles to each other, and also to the apparent axis A, we shall obtain an explanation of all the phenomena. If the axes B, C, exercise the same action on the *violet* rays, they will produce a single *negative* axis at A for *violet* light, as given by observation; and if the relative intensities of their action upon red light are in the ratio of the square of the cosine of $2\frac{1}{2}^{\circ}$ to unity, the intensity of the weakest gradually diminishing to *zero* for the rays between the *red* and the *violet*, then we can calculate, with mathematical precision, all the phenomena of double refraction and polarisation exhibited by *Glauberite*.

The structure of *Apophyllite* and *Glauberite*, therefore, furnishes us with two unequivocal examples of minerals where the real axes of double refraction are not pointed out by observation. Their crystallographic structure does not indicate, with any certainty, the locality of the axes which we have now inferred from the laws of double refraction; but we have no doubt that the results of crystallography and optical structure will ultimately coincide, when our knowledge of the primitive and secondary forms of minerals shall have attained a higher degree of perfection*.

While repeating these experiments on *Glauberite* during a low state of temperature, I was surprised to observe, that the

* The following paragraphs have been added since the paper was read.

tint between the two resultant axes diminished with the heat of the hand. I immediately increased the temperature, and before it reached that of boiling water, the weaker axis for red light disappeared altogether, so that the crystal had only one axis for red light. The axis, however, re-appeared, but the plane passing through the resultant axes was now at right angles to what it was at first.

By the application of artificial cold, a new axis was created for violet light, and the plane of the two resultant axes coincided with the plane of the two resultant axes for red light at the ordinary temperature.

Results analogous to these have been obtained by Professor MITSCHERLICH for other minerals; but I am not aware that he has observed such marked changes produced by such a slight increase of temperature, or that he has made any observation at all upon Glauberite. As the subject belongs to him, I have merely noticed the very singular fact which so unexpectedly presented itself.

XVIII. *Experimental Inquiries concerning the Laws of Magnetic Forces.* By WILLIAM SNOW HARRIS, Esq.

(Read April 1828.)

1. **I**N the following investigation, it has been my endeavour to elucidate some of the complicated phenomena observable in all the known operations of Magnetic Forces : The labours of so many profound inquirers in this important department of physical science, are indeed such as almost to discourage those less gifted with similar powers of research from engaging in the same pursuit ; but knowledge is progressive, and the splendid researches which have displayed the highest efforts of genius serve rather to assist than to deter others in more humble endeavours to promote the advancement of science.

2. Many excellent writers have well observed, that, to arrive at a perfect knowledge of the laws of magnetic action, we should have it in our power to submit magnets and ferruginous bodies to the test of experiment, but that the combined effects which these forces exhibit have at all times rendered such experiments very difficult and precarious ; so that it has been almost impossible to obtain from them simple results.

3. It may not therefore be altogether useless to describe an instrument calculated to obviate some of the difficulties which have thus impeded the efforts of experimentalists in their endeavours to investigate the laws of magnetic forces, in which, by the

application of a very simple principle, aided by an easy and delicate mechanism, I have sought a means of observing the action of one magnet on another, or that of magnetised upon unmagnetised iron or steel, so as to estimate either the final result of the compound action, or the separate forces of which such action is compounded.

4. Plate X. Fig. 1. represents an instrument which may be considered as a species of balance with equal arms. There is a light wheel of brass *abcd*, Figs. 1. & 2. about two inches diameter, whose centre *i* is placed in that of an arc MIN. This arc is the quarter part of a circle, having a radius of between six and seven inches: it is divided into 180 equal parts; 90 in the direction IN, and 90 in the direction IM; the point I being the bisection of the arc, and marked zero. There is a short steel pin which projects at *b* for about half an inch from one of the arms of the wheel, through the circumference: this pin sustains an index *bI*, Fig. 1. formed of a light straw, which being tubular, is easily placed on it, so as to fit sufficiently tight; the distant extremity of this index is cut in the manner of a common writing pen, and is carefully tapered to a fine point. From the opposite arm at *d*, a similar pin projects, on which is screwed a very small brass ball, which being adjusted either nearer to or farther from the centre, is made so nicely to counterbalance the index, that the wheel, when resting on its axis, is almost indifferent as to position, the index remaining on any part of the arc, or nearly so.

5. The axis of this wheel *abcd* is formed for a short distance at each extremity into fine cylindrical pivots, which rest upon the angles formed by four lesser or friction-wheels: these are also about two inches in diameter, are constructed in the lightest way possible, and are placed two of them before, and two behind

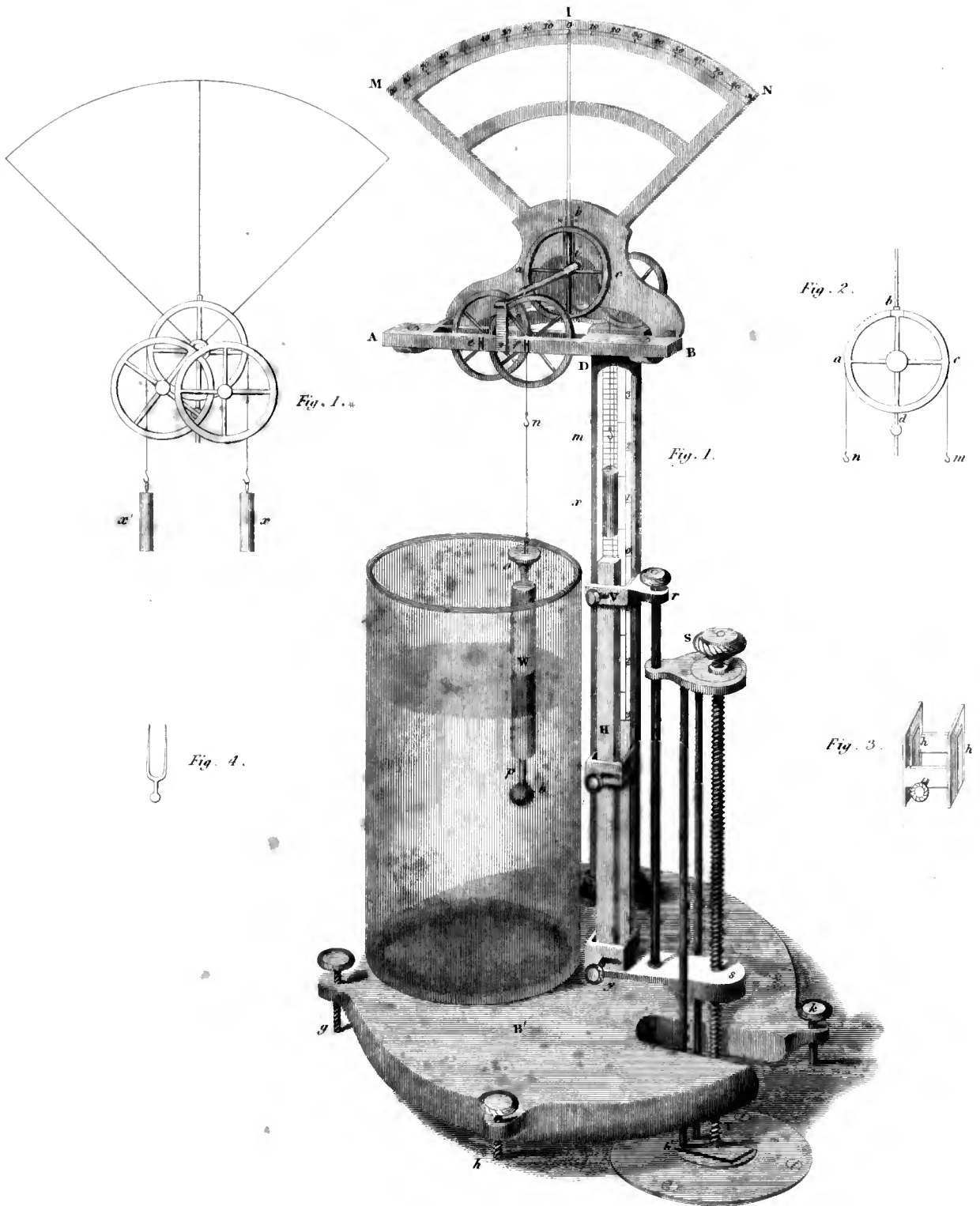



the frame which sustains the graduated arc; they are mounted on very delicate pivots, terminating in fine points*.

6. The five wheels just described, with the graduated arc, are sustained by a projecting frame of brass ABD; and the whole is supported by a vertical column of wood or brass DE, about fourteen inches high. The frame of brass ABD projects six inches from the column, and is united to it at D by means of a small nut and screw. The column DE is screwed, at its lower extremity, into a circular base B', of 10 inches diameter, supported on three adjusting screws, *g, h, k*. There are two lines of silk, each three inches in length, *bcm, ban*, Figs. 1. & 2., which pass from the point *b* in opposite directions, over the circumference of the wheel *abcd*, and terminate in two small hooks *m, n*: these lines are secured close to the point *b* on each side of it, by means of a small knot, and by passing them through holes drilled in the circumference, as in Fig. 2. The circumference is slightly grooved to receive these lines, and prevent them from slipping over the edge of the wheel.

The line *bcm* sustains a small cylindrical piece of soft iron, or otherwise a small cylindrical magnet *x*, Fig. 1., which being first attached to a loop of silk †, is suspended on the hook at *m*. From the opposite hook *n* there is suspended in a similar way a cylindrical counterpoise of wood *W*, the lower half of which is immersed in distilled water. The water is contained in a cylindrical vessel of glass, whose interior diameter is so great that any

* The opposite extremities of the pivot-holes are faced with small portions of fine watch-spring, as at *ef*, Fig. 1. which mark the centres of the two front wheels. Thus all friction which might possibly arise from the occasional contact of the shoulder of the pivot is prevented.

† The loop is formed by a doubled piece of fine silk, inserted in a small hole drilled vertically into the centre of the upper part of the cylinder *x*, and secured there by a small peg of wood passed down into the hole between its two extremities.

change in the altitude of the water, in consequence of the immersion or emersion of a small portion of the cylinder W, does not sensibly influence the indications on the arc MIN.

7. The cylindrical counterpoise just mentioned is made of fine-grained mahogany : it must be turned very accurately, and must be perfectly free from grease or varnish of any kind, so that becoming readily wetted by the water, it moves in it with great freedom. The body of this counterpoise is from two and a half to three inches in length : its lower extremity terminates in a short stem *p*, on which is fastened a brass ferule, having a screw at its lower part, by which means a small hollow ball of brass *b'*, from three to six-tenths of an inch in diameter is attached to it, being previously so loaded as to balance the suspended body *x*, and bring the index *bI* within the range of the arc IN, when the lower half of the cylinder W is about one-half immersed in the water. The upper extremity of the counterpoise terminates also in a short stem at *o*, and in a small hemispherical cup ; this cup is intended to receive the additional weight requisite to bring the index to zero ; and thus, by means of some fine shot, which are very convenient for the purpose, the index may be regulated with great precision*.

8. It appears evident from the nature of this arrangement, that the gravity or weight of the body *x* being as it were destroyed

* It is requisite to have several of these cylinders of different diameters, namely, from 0.2 of an inch, to an inch, each increasing in diameter about 0.1 of an inch. They should be very accurately turned, and, before being used, should be freely wetted throughout their whole length, which is best effected by allowing them to remain for a short time immersed in water as high as the upper stem. They are suspended in their situation by means of a loop of silk, inserted in the bottom of the hemispherical cup into a small hole drilled through its centre into the stem, and secured there with a small peg of wood in the way already described in note on p. 279.

by a contrary and equal force, it may be considered as existing in free space, devoid of weight, and it will therefore remain quiescent, until some new force be applied to it; and thus the action of the force we seek to investigate will become so far evident and unimpeded by any obstacle arising from gravity, except the friction and inertia of the wheels, and the resistance of the air*, which in this case need not be taken into account.

Thus, if an attractive force cause the body x , Fig. 1., to descend, then the index bI will move forward in the direction IN , until a portion of the cylinder W drawn out of the water, ceases to displace as much of the fluid as is equivalent to the force applied; and thus we obtain a constant and known measure of the new force, within a given range, which will be more or less extended, according to the dimensions of the cylindrical counterpoise W , the intensity of the force, and the rate of its increase. In like manner, if a repulsive force act on the body x in a contrary direction to the former, then the index bI will move in the direction IM , until a new portion of the cylinder W becomes immersed in the water; and thus an equivalent to the force of repulsion is obtained in a converse way to the preceding.

9. Previously to suspending the cylindrical counterpoise just described (7.), the body x is to be put in equilibrio with an equal and similar weight x' , Fig. 1*, in order to observe, if when loaded with the whole, the index is indifferent as to position on any part of the arc, or nearly so, after carefully bringing it to rest. (The weight of the silk, which is necessarily transferred from one side to the other by the motion of the wheel, being considered of no value). For this purpose, there is a small hollow cylinder of brass x' , Fig. 1*, about the same dimensions as the

* These weights being placed under the same circumstances as the weights in the celebrated machine of Mr ATWOOD.—See ATWOOD on *Rectilinear Motion*.

cylinder x : it is closed at each end, but has a small hook screwed into the upper part, which can be occasionally removed, so as to load the interior with as much weight as shall make it exactly equal to the weight of the iron or magnet x , when weighed in an accurate balance. The machine, with the iron x , thus put in equilibrio, will be sufficiently delicate, if, when loaded with a weight of 500 grains, about one-tenth part of a grain will set it in motion.

To retain the wheel abc , Fig. 1. in its situation at the time of removing either of the suspended bodies, there is a small brass prong, Fig. 4. occasionally inserted in two holes drilled through the quadrant, so as to enclose the steel point b which carries the index: thus the wheel cannot fall either to one side or the other.

10. In order to regulate the distance at which an attractive or repulsive force may be caused to operate on the body x , there is an adjusting apparatus represented in Fig. 1. by means of which a magnetic bar H , or a horizontal plane AB , Fig. 9. (Pl. XI.), may be elevated or depressed through any required space.

It consists of a vertical screw ST , Fig. 1., eight inches in length, which passes through a corresponding nut at s , resting finally upon the metallic foot at T : this foot is secured to a circular base of a convenient size. The nut at s is fixed to a small horizontal plane of brass, sy , an inch and three quarters in length, and an inch wide: this plane is preserved in its position by the guide Sh , which also assists in supporting the circular top S ; there is a brass rod of about three-tenths of an inch in diameter, and eight inches long, which passes freely through a small projecting ring at S , and is screwed beneath into the brass plane at h' ; the use of this rod is to sustain the square band of brass V , through which passes the magnet H and scale my . The band V is united to the upper part of the brass-rod by a nut and screw at r , and incloses a space an inch wide, eight-tenths of an inch

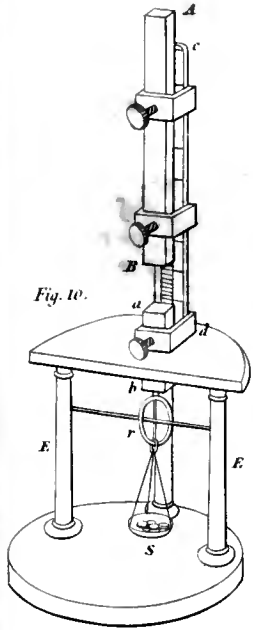

Fig. 10.

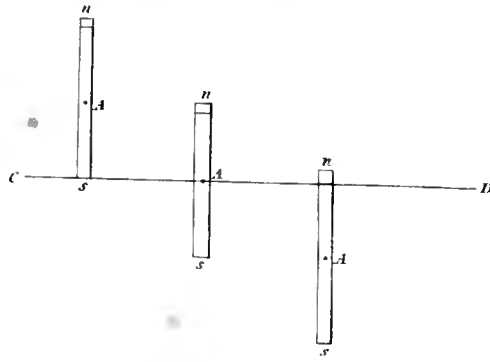

Fig. 6.

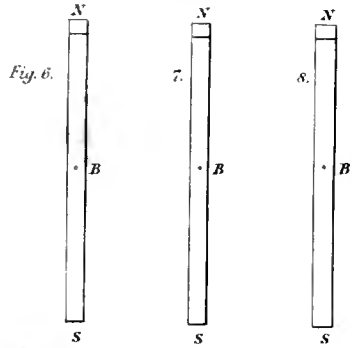

Fig. 7.

Fig. 5.

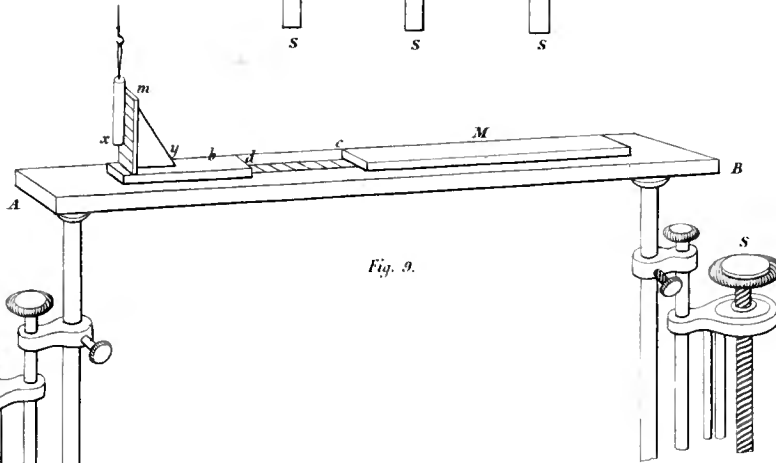
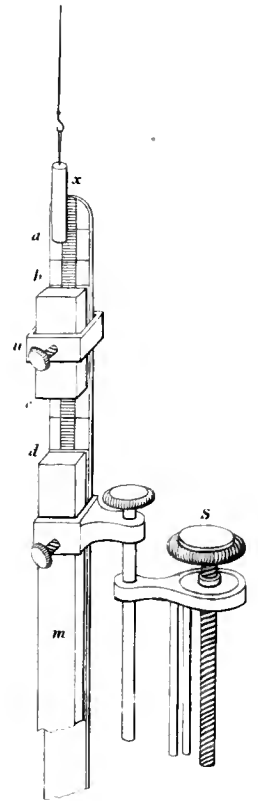

Fig. 9.

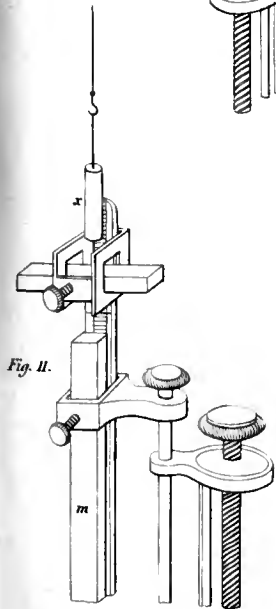

Fig. 11.

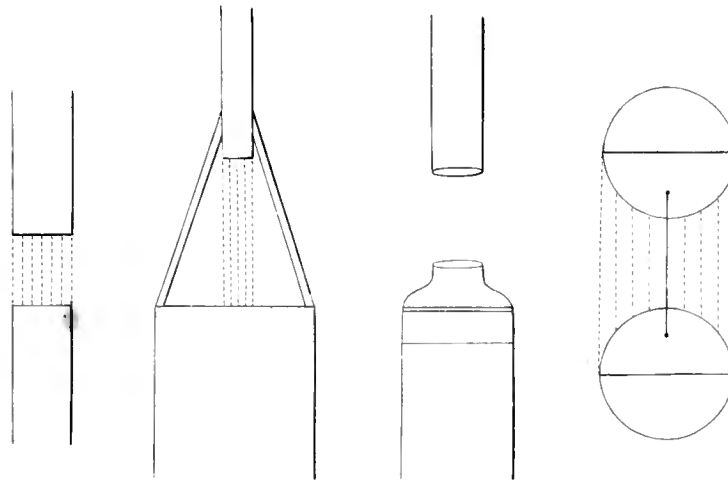
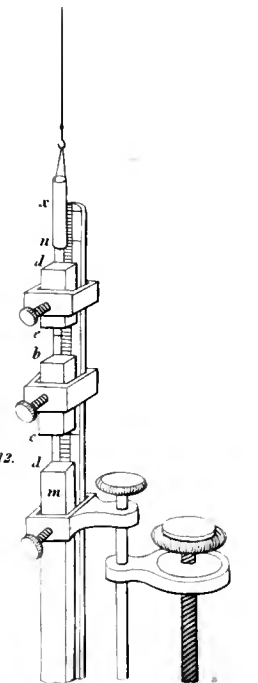

Fig. 12.





long, and about half an inch in depth *. The magnet and scale which pass through this opening rest in a corresponding band *y* below; this lower band being fixed to the brass plane. Each band has two small screws, the milled heads of which are seen projecting at *V* and *y*: these are to retain the magnet and scale firmly in their place by slight pressure. When small magnets are used, they are easily secured in their situation against the scale *my*, by a slight pressure of the screw *V*. The magnet and scale being fixed, we are enabled, by turning the head of the vertical screw at *S*, to raise or depress them through any required interval within the range of the screw, and so adjust the distance between the upper pole of the magnet and the lower pole of the suspended body *x*, with great accuracy.

11. Besides these means of adjustment, there are one or more detached bands of brass, Fig. 3., somewhat similar to the fixed bands already described, which are occasionally applied to any part of the divided scale, so as to fix a magnet, or a mass of iron, at any required distance from each other, as shewn in Figs. 5. & 12., or otherwise allow of pressure being made about the centre of the bar, as at *H*, Fig. 1., by which means it can be elevated on the scale if necessary. These bands also serve to sustain a magnet or a mass of iron in an horizontal position, as in Fig. 11., there being two spaces, *hh*, Fig. 3., through the sides.

12. When it is required to examine the force of a magnet in a vertical position, it is placed in the situation just described (10.), and then transferred immediately under the suspended body *x*, there being a portion of the circular base *B'*, Fig. 1., removed

* The spaces are sufficiently large to receive one or more magnetic bars of a convenient size, the interval, when only one is employed, being filled up by a piece of wood placed behind the scale, to keep it steady. The scale extends about three inches above the magnet, and through its whole extent below: it can therefore be raised between the magnet and wood to any further altitude required.

for this purpose, so that the adjusting apparatus rests on a base independent of that which sustains the rest of the machine; and when it is required to examine the same force, the bar being placed in an horizontal position, it is then laid on the horizontal plane before mentioned (10.), and represented in Fig. 9, the divided scale *my* being now a detached piece of wood or brass, fixed against one of the perpendicular sides of a right-angled triangle, it can thus be transferred to any part of the bar. There is a small spirit-level occasionally placed on the plane AB, in order to indicate, as nearly as possible, the horizontal position, when adjusting the distance by means of the screws S, S, Fig. 9.

13. The iron or magnet *x*, Fig. 1, and the cylindrical counterpoise W, being accurately suspended, and the index adjusted at zero, if the least impulse be communicated to either side, a long continued and delicate oscillation will take place before the index again returns to its point of rest, which it finally does at zero, thus evincing great freedom of motion.

The accuracy of the whole machine should now be finally examined, by placing successively small weights of a grain or more, according to the dimensions of the cylindrical counterpoise, first on the suspended body *x*, and afterwards in the hemispherical cup at *o*. Thus, if one grain moves the index in either direction 5 degrees, two grains should move it 10 degrees, and so on; and the motion on each side of zero should correspond.

Beside the certainty we thus obtain of the accuracy of the instrument, or the error to which it is liable, we are enabled to refer the force indicated to a known standard of weight, which is every where the same, it being only necessary to state the distance at which the force acts, and the dimensions of the body *x*, supposing it to be of soft iron of the ordinary kind. Thus, if the distance should be an inch, and the index marking 25° , we

might say the magnetic bar at an inch distance exerted on our suspended iron *x* a force of 5 grains, supposing $5^\circ = 1$ grain; and thus the indications of such a machine, like the thermometer, become universal*.

14. Experimental inquiries concerning the laws of magnetic forces being, as already observed (2.), much embarrassed by the complicated action which such forces exhibit, we are first led to examine the absolute attractive force exerted between a magnet and a mass of iron, when placed at various distances from each other, in which case, we may consider that a permanent magnetic developement exists only in one substance; but in this inquiry, it is essential to understand clearly the laws and operation of induced magnetism, that is to say, the influence which magnetised steel exerts upon ferruginous bodies not magnetic, so as to induce in them a developement of magnetic properties, such effect being the most simple case of magnetic action.

15. For this purpose, the cylindrical piece of soft iron (13. Note) was suspended from the wheel of the instrument, Fig. 1.: it weighed 123 grains. The cylindrical counterpoise *W* being about three-tenths of an inch diameter, which, by experiment, gave 5° of attraction, equal to one grain. A mass of soft iron, *bc*, Fig. 5., two inches in length, eight-tenths of an inch wide, and three-tenths of an inch thick, was then affixed by means of a brass band *n* to the divided scale; and immediately under this

* There should be several small cylinders prepared of very soft iron, for general use, being about two inches in length, and one quarter of an inch in diameter. The iron-wire of commerce is convenient for the purpose. They should be accurately turned, and great care should be observed in freeing them from any permanent polarity, which is readily done by making them red-hot in a clay tube, or in fine sand in a small crucible, so as to keep them out of contact with the air. They may be considered sufficiently free from polarity, if, when immersed in fine filings of soft iron, there is no tendency to adhesion, or polar arrangement of the filings about their extremities.

was placed a magnet m , nine inches long, and of the same breadth and depth as the iron above; the whole was then transferred under the suspended cylinder x , as in Fig. 5, it being previously ascertained that the magnet m might be alone approximated within two inches of the iron x , without any sensible effect being produced on the index. In this arrangement, therefore, the index could not become influenced, except by the magnetic development induced in the intermediate substance bc ; and thus, by varying the distance cd , and at the same time preserving the distance ab , by means of the screw at S, constant, it was easy to determine the law according to which the magnetic development in the iron proceeded; the force of the magnet m being considered a constant quantity, but its distance from the iron a variable one.

16. For it will be readily admitted, that any polarity which the attracting masses of iron bc and x could be supposed to acquire by position might be considered as invariable and fixed throughout the experiment, and therefore could not affect the result, and must be otherwise a quantity so small in relation to the means by which the other forces were made sensible, that it could not have any assignable value, as the masses of iron x and bc would not alone evince any attractive force, so as to be sensible by the index, however near they were approximated.

17. For similar reasons, the operation of the distant polarities, as they became developed in the attracting masses of iron x and bc , could not be supposed to exert any sensible influence in complicating the result, as will also appear by considering the circumstances under which these polarities are placed. Thus, when two magnets A and B, Figs. 6, 7. & 8. are opposed to each other at their dissimilar poles, then, in a purely theoretical sense, and according to the most evident of magnetic experiments, N attracts

s, but repels *n*; and *S* attracts *n*, but repels *s*; so that the final resultant is very complicated. We may, however, imagine these forces to be so circumstanced in relation to a means by which their action is evinced, and by which they are measured, that at some distance *Ns*, Fig. 6. the action vanishes. Let then the line *CD* represent the limit at which their influence, thus estimated, ceases: in this case, the effect of the polarity of *BN* upon that of *An* must be considered as having no assignable value, until some point in *An*, Fig. 8., upon the other side of the magnetic centre *A* passes the limit *CD*. The same may be said of the influence of the polarity of *BS* upon that of *As*, so long as the points in *BS* remain without the limit *CD*; that is to say, at a distance from the points in *As* greater than *Ns*. If the magnets be only hardened and magnetised about their extremities, or if they be small, and of weak intensity, then there may arise a case in which the action is so weak in every other part except the extremities, that the result is not sensibly deranged until the pole *n* actually arrives at *CD*, Fig. 8. There are some further considerations as to the limit *CD*, not necessary here, which will hereafter be given.

18. Now, in the experiment under examination, the masses of iron *x* and *cb*, Fig. 5, during the time they are operated on by induction, may be considered as two magnets whose intensities increase at each approximation of the bar *m*. It is, therefore, only necessary to determine the limit *CD*, Fig. 6, of their action, when the induced magnetic force is the greatest; and we immediately ascertain if any disturbance arises from the influence of the opposite polarities. This limit, in the present case, was found not to exceed an inch and a half; and it not being requisite to approximate the distant poles within that space, the result might so far be considered free from this source of error.

19. The experiment being, therefore, arranged, as before explained (15), it was observable, that, when the magnet m and iron bc were an inch apart, and the distance ab adjusted to two-tenths of an inch, the index moved forward to 3° ; on diminishing the distance cd between the iron and magnet to half an inch, and again adjusting the distance ab to two-tenths, the index pointed to 6° ; on removing the intermediate iron, the index returned to zero, thereby shewing that it was not acted on except by the magnetic development induced in the iron bc *.

In the following Table is given the results of this experiment in relation to other decrements of the distance between the iron and magnet, in which D signifies the distance cd between the iron and magnet, and F the corresponding force induced in the iron bc , the distance ab being always adjusted to two-tenths of an inch.

TABLE I.

D	F
1.0	3.0
0.8	4.-
0.6	5.0
0.5	6.0
0.4	7.5
0.3	10.0
0.2	15.-

It may be perceived by reference to the above Table, that the magnetic development induced in the iron, increased in an *inverse simple ratio of its distance from the magnet*.

* The distance cd between the iron and magnet is readily varied, either by elevating the magnet m , or depressing the iron bc , the brass bands allowing them to slide beneath with sufficient ease, but yet, at the same time, exerting a sufficient degree of pressure to retain the iron and magnet in the required position.

20. The truth of this result was in a great measure confirmed, by ascertaining the absolute weight required to overcome the attractive force induced in a mass of iron at different distances from a magnet. The requisite apparatus for such an experiment is very easy to be constructed. There is a vertical support of wood *cd*, Fig. 10, sustained at a convenient height on two or three columns *ef*, by means of a horizontal plane *d*, the columns *ef* being screwed into a circular base *s*, of a convenient size. The magnet *AB*, and iron *ab*, to be submitted to experiment, are secured in the required position by the moveable bands of brass before described (11), the iron passing below through the plane at *d*. There is a portion, *aB*, of the vertical support *cd*, divided into inches and tenths of an inch, to mark the relative distances by which the iron and magnet are separated. A ring of soft steel *r*, about an inch and a half in diameter, having a light brass pan *S* attached to it, is suspended from the point *r* by the attractive force induced in the iron *ab*; a slender rod of brass passes through this ring *r*, being supported at each extremity in the columns *ef*, in order to prevent the ring from falling an unnecessary distance when the force of the attraction is overcome by weights placed in the pan at *S* *.

21. A magnetic bar being selected, two feet in length, an inch and a half wide, and half an inch thick, it was placed, by means of this contrivance, at different distances from a mass of iron of the same breadth and thickness, but not exceeding three inches in length. When the magnet and iron were two inches apart, it required, as determined by various trials, between 190 and 210

* The point *r* consists of a very short piece of soft iron, about two-tenths of an inch in diameter. It is screwed firmly into the centre of the iron *ab*, so as to have a perfect contact, and projects vertically for about the one-tenth of an inch from its lower extremity; thus the steel ring *r* becomes always attached in the same place.

grains to separate the ring ; when the distance was an inch and a half, between 250 and 280 grains overcame the contact ; on diminishing the distance to an inch, between 390 and 400 grains were required to separate the ring ; and on again diminishing the distance to half an inch, it sustained a little less than 800 grains. The weights and corresponding distances may be therefore expressed as in the following Table, considering the weights as a fair measure of the attractive force.

TABLE II.

D	F
4	200
3	265
2	400
1	800

The weights, therefore, are in an inverse simple ratio of the distances, or very nearly so*.

Although this mode of experimenting is not so delicate as the former, it is still sufficient to shew that the force induced in the iron was not, in any inverse ratio, greater than that of the simple distance between the iron and magnet.

22. A similar result was obtained when, instead of placing the magnet and iron in a vertical position, as in Fig. 5, they were placed horizontally, as in Fig. 9, the suspended cylinder *x* being immediately over the distant extremity *a* of the iron *ab*. In this form of the experiment, we may consider the attractive force as proceeding from that point (*a*) of the iron, immediately

* The weight of the steel ring and brass pan S, with the silk lines, was just 100 grains. It was consequently taken into the account at each trial ; and the weights finally added before the contact was broken, did not exceed 10 grains at a time, these being placed carefully in the pan.

under the suspended cylinder x ; for it is not difficult to shew, that, in consequence of the other forces being small, and otherwise caused to act at very small angles, the resultant cannot differ materially from that of the force ax , and thus we approximate very nearly to a simple result. Moreover, it could be at all times ascertained experimentally if any other point b , Fig. 9, exerted an influence on the index, by withdrawing the iron and magnet until a arrived at b , the induced force in the iron being the greatest. In this instance, the index was not influenced when the iron ab was withdrawn for a very short distance from under the suspended cylinder x ; so that the force of the attraction might, without any considerable error, be supposed to emanate from the point a , the magnet M being preserved at all times without the attracting limit.

23. The magnet and iron described (21) being placed horizontally, with a small moveable scale my , to indicate the constant distance ax , as in Fig. 9; the same process was repeated as before explained (19). The results are given in the next Table, the distance ax being constantly made equal to two-tenths of an inch.

In this Table, D signifies the distance bc , and F the corresponding forces in degrees, 5° being equal to one grain.

TABLE III.

D	F
1.0	5.5
0.8	7.0
0.6	9.0
0.5	11.0
0.4	14.0
0.3	18.0

The trifling differences observable in some of the numbers are

so very small, as to leave no doubt concerning the law we have endeavoured to investigate. It will, however, be necessary to remember, that, in these experiments, we have not examined the absolute attractive force exerted between a mass of iron and a magnet, at different distances, but merely the law of the influence of a magnet upon a mass of unmagnetized iron, so as to induce in it a development of magnetic action.

24. This simple law of magnetic induction is observed to proceed uniformly from the distance at which the force first becomes measurable, until the iron and magnet are very nearly approximated, but then begins to vary. Thus, in the preceding experiments (19. 23), when the iron and magnet were approximated within the tenth of an inch, the increments in the attractive force began to diminish. It would appear from this circumstance, either that the similar and distant polarities begin in this case to exert a sensible influence in disturbing the result, or that a limit exists, approaching saturation, beyond which the inductive effect on the iron does not proceed with the same facility as before. In either case, this limit may be supposed to vary with the power of the magnet. This was made evident by employing magnets of different degrees of intensity in succession. Thus, it was observed, that, although the induced effects on a mass of iron were at first respectively proportional to the powers of the magnets, yet the increments in the attractive force acquired by approximation began to diminish at a greater or less distance from the magnet, according as the original magnetic force was of greater or less intensity.

25. The attractive force of magnets by induction at their *distant poles* is, all other things remaining the same, inversely proportional to the lengths of the iron, and, as just observed, at

given distances, proportional to the powers of the inductive* magnets; but which will be further shewn.

In the following Table is given the results of some experiments on masses of iron similar to those before employed (15, 21, 22), and whose lengths were equal multiples of each other; the masses of iron being each placed in succession at a constant distance from the inductive magnets, as in Figs. 5. and 9.

The distance *cd* between the magnets and masses of iron was made equal to three-tenths of an inch, and the distance at which the induced force operated on the suspended iron *x*, as *ab*, Fig. 5, made equal to two-tenths of an inch.

In this Table, *L* signifies the length of the iron, and *F* the corresponding force of attraction, each 5° being equal to one grain.

TABLE IV.

Position Vertical, Fig. 5.		Position Horizontal, Fig. 9.	
L	F	L	F
1.0	20	3	18
1.5	14		
2.0	10	6	9
3.0	7		

26. A curious fact here presented itself in the course of these experiments, namely, that, whether the masses of iron were acted on through their lengths, Fig. 5, or through their breadths, as in Fig. 11, still the induced force of the superior pole did not in either case materially differ; and it became further evident, that, although the magnetic bar *m*, Fig. 11, was occasionally approximated within a distance of the suspended cylinder, at which it could alone influence the index, yet the intervening mass appropriated to itself the attractive power; and thus intercept-

* I employ this term to distinguish more particularly the magnets inducing the temporary development of magnetic properties in the unmagnetised iron.

ed all the effect which the bar of itself could otherwise produce ; so that the bar being, as it were, insulated by the intervening iron, the final force of attraction might be considered to depend exclusively on the iron.

27. Although the distant poles of magnets by induction evince an attractive force inversely proportional to the length of the iron ; yet the pole immediately opposed to the inductive magnet would seem to possess the same force in all cases, without any relation to the length of the iron ; since by substituting a small magnet *x*, Fig. 1, for the cylinder of soft iron, and placing immediately under it in succession, at a constant distance, masses of iron of different lengths, the force of attraction indicated on the arc was observed to be in each case the same. The force, therefore, induced in each mass of iron must have been alike, since the total attractive force, as will be further shewn (37), is observed to vary with the force induced in the iron ; the power of the magnet remaining unchanged, and all other things remaining the same.

This result is quite consistent with the general effect observed in opposing a long mass of iron to the pole of a magnet, in which case the distant extremity of the iron does not appear, except by very delicate tests, to be at all magnetic ; whilst shorter lengths, as already shewn (19, 20), exert a considerable attractive force*.

* It may be from this circumstance that some profound investigators of magnetic phenomena have found, that a hollow sphere of iron exerted as much effect on a compass needle as a solid mass of the same dimensions ; which might be reasonably supposed to be the case, as the iron could only become magnetic by induction, in which case the force of the proximate poles would be always the same. The force which such ball or shell, however, could exert on some third mass, not previously magnetic, would probably be found to be very different.

28. As the iron bc , Fig. 5, receives a magnetic developement inversely proportional to its distance from the magnet m , we may consequently, by varying this distance, alter the relative magnetic intensity of bc at pleasure; and thus, by fixing a second mass of iron de , Fig. 12, immediately above bc , at a constant distance eb , this mass de can be caused to operate on the suspended cylinder a , by a sort of second induction; so that, by preserving the distances nd and eb , and at the same time varying the distance ca , we have all the conditions required for determining the law of the inductive influence, when the force of a magnet bc , Fig. 12, is made to vary, but its distance from the iron de preserved constant. The experiment being thus arranged, it was found, as might have been previously anticipated, that the second mass of iron de received an attractive force directly proportionate to the magnetic intensity of the mass bc below.

The same result was obtained when, instead of varying the magnetic force by induction, it was varied by means of magnets, whose forces were to each other in a known ratio, applied successively, at a constant distance cd , under the iron bc , Fig. 5.

The following Table contains the results of these experiments, in which F signifies the relative magnetic intensities; f the corresponding force of induction; the distance dn , Fig. 12, and ab , Fig. 5, at which it operated on the suspended cylinder a , being two-tenths of an inch; as also the distance eb , Fig. 12. The distance cd , Fig. 5, in which the induced force in bc was varied by magnets, being made constantly equal to half an inch, each 5° of attraction, being in both cases equal to one grain.

TABLE V

Force varied by Induction, Fig. 12.		Force varied by Magnets, Fig. 5.	
F.	<i>f.</i>	F.	<i>f.</i>
1	3	1	5
2	6	2	10
3	9	3	15

29. From these experiments, therefore, we may conclude, that the magnetic developement in masses of iron by induction is directly proportionate to the power of the inductive force, and inversely proportional to the distance, all other things remaining the same ; and that the attractive forces which magnets can develope in masses of iron at a given distance, may be considered, within certain limits (24), as a fair measure of their respective intensities.

30. It will be here proper to examine the curious phenomenon of the increased force which a magnet apparently gains at one of its poles, by placing a mass of iron in contact with the opposite one ; so that, in this case, it can sustain a much greater weight, and hence its power is said to be increased. This circumstance, recorded by almost every writer on magnetic attraction, may be readily explained on the generally received hypothesis of magnetic developement, which supposes in every magnet the existence of two opposite forces ; the magnetic centre being a point where these forces are in a state of neutralization, whilst the intensity of the separate forces varies in some direct ratio of the distance as they recede from each other. The intensity of the magnetism thus set free, will, therefore, be the greatest somewhere near the extremities of the bar ; so that, if a portion of the magnetism at one extremity becomes neutralized, the effect is more or less sensible at the other ; and thus a

further magnetic developement is induced by neutralizing a portion of the opposing force.

The force thus neutralized will, from what has been stated (29), depend on the inductive force of the magnet, and its distance from the iron ; so that the increased attractive power of the magnet at its opposite pole, is still a measure of the inductive effect.

31. The fact itself (30) is very well illustrated by placing a short magnetised piece of steel *bc*, Fig. 5, to act on the suspended cylinder *x* at a constant distance ; and, after observing the attractive force ; by subsequently opposing a mass of soft iron *m* very near the inferior pole, in which case the index will be found to advance. The effect is more decided when the iron *m* is brought into contact. The law of this action is, as in the former case, directly proportionate to the power of the magnet, and inversely proportional to the distance. Thus, a small magnetised piece of hardened steel *bc*, Fig. 5, three inches long, eight-tenths of an inch wide, and three-tenths of an inch thick, being caused to act on the suspended cylinder *x* at four-tenths of an inch distance, the indicated attraction amounted to 12° . On approximating a similar mass of iron *m*, within two-tenths of an inch of its inferior pole, the index moved forward 1° ; on diminishing the distance to the one-tenth of an inch, the index moved forward another degree.

32. The effect thus produced by approximating a mass of iron toward the opposite pole of a magnet, has not any relation to the dimensions of the iron, all other things remaining the same ; thus furnishing an additional confirmation of the curious fact before mentioned (27),—that the proximate poles of magnets by induction are of equal intensity.

33. In the experiment just described (31), the increments of the attractive force of the magnet were necessarily very small, since they depended exclusively on the iron, which had no permanent magnetism, and which operated at the distant pole. In order, therefore, to allow of an increased action, and at the same time observe the immediate operation of the iron on the pole to which it was opposed, the experiment was transformed as follows. A magnetic bar m , Fig. 13. (Pl. XII.), being placed in a horizontal position, with one of its extremities immediately under the suspended cylinder x , and the number of degrees of attraction being noted at a constant distance, a mass of iron n was approximated toward the same extremity. In this case such portions of the free magnetism of this extremity would become neutralized as were proportional to the magnet's inductive effect, and this would be evinced by the number of degrees which the index declined. Thus we might come to determine experimentally all the particular cases hitherto considered, a method of experimenting which, although not entirely free from objection, is still useful, and sufficiently accurate to confirm the preceding results.

34. The experiment being arranged as in Fig. 13, the effect of the iron was, as in the former cases, directly proportional to the power of the magnet m , and inversely proportional to the distance $a b$. In the following tables are given the results actually obtained. The magnetic bars and iron employed being similar to those before described (15). In these tables, D signifies the distance $a b$ between the iron and magnet, F the intensities of the magnets, and f the force as expressed by the number of degrees which the index declined. The distance between the suspended cylinder x and the magnet m being, in Table VI., six-tenths of an inch, and in Table VII. eight-tenths of an inch; the constant distance $a b$, at which the variable magnetic forces were applied in Table VII. being two-tenths of an inch.

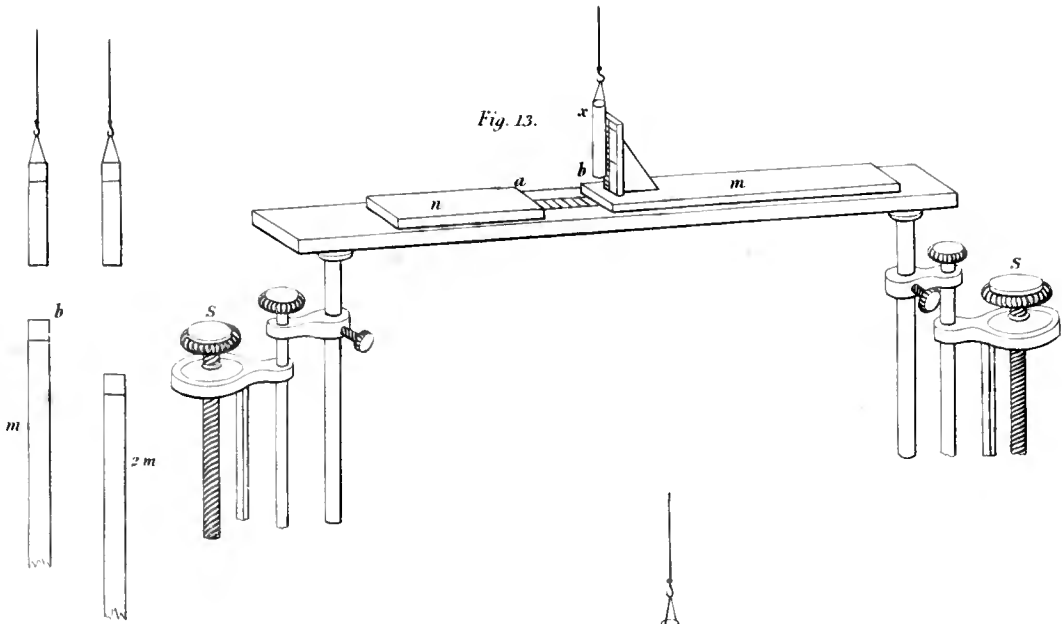

Fig. 13.

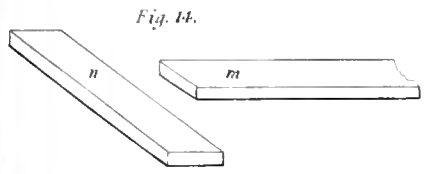

Fig. 14.

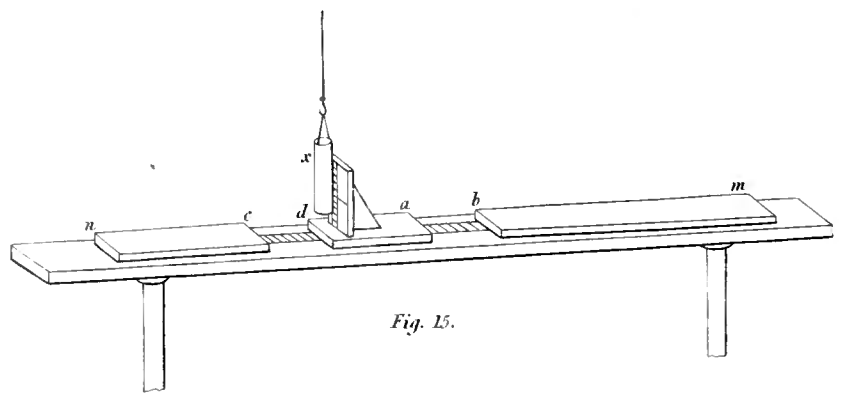

Fig. 15.

Fig. 20.

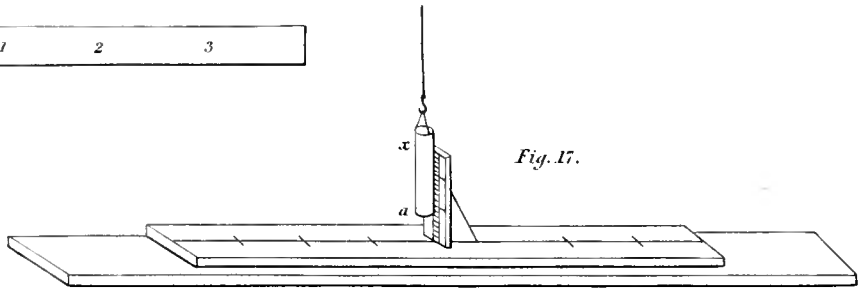

Fig. 17.

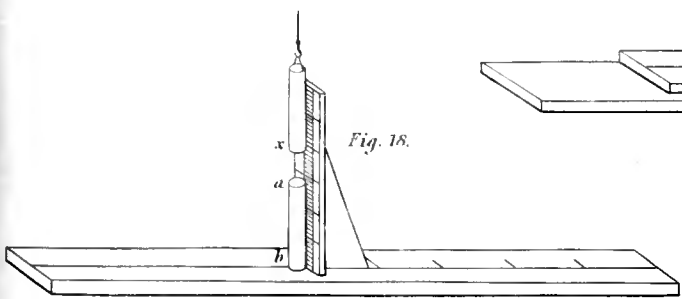

Fig. 18.

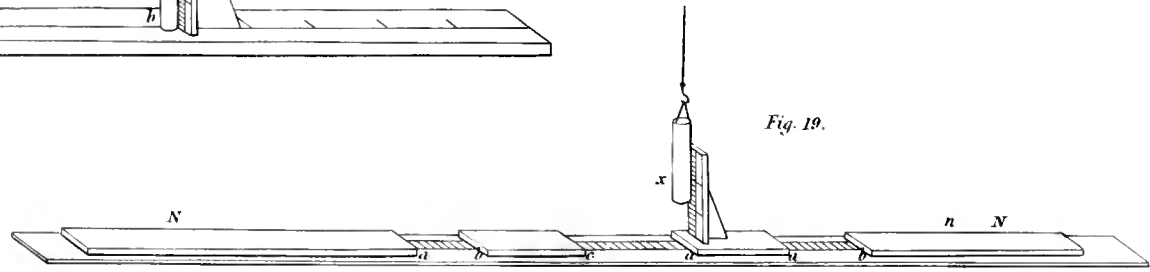

Fig. 19.



TABLE VI.

Magnetic Force constant.	
D.	<i>f</i> .
0.6	3.
0.4	4.5
0.3	6.
0.2	9.

TABLE VII.

Magnetic Force variable.	
F.	<i>f</i> .
1	2
2	4
3	6
4	8

35. In these, as in the former experiments (32. 37), the effect produced on the index was quite independent of the dimensions of the iron, and was observed to be nearly the same, whether opposed to the magnet *m* through its length, as in Fig. 13, or through its breadth, as in Fig. 14, the proximate induced polarity of the iron appearing to be in each case alike. Similar results were also obtained to those before noticed (24), in employing magnets of powerful intensities; it being observable, that, at very near approximations, the effect on the index was not precisely proportional to the powers of the magnets.

36. The general results of the foregoing experiments (34) became further shewn, when the magnetic forces employed were those induced in a mass of iron, as in Fig. 15. Thus, a mass of soft iron *da*, not exceeding three inches in length, being placed with one of its extremities immediately under the suspended cylinder *x*, a magnetic bar *bm* was opposed to its opposite extremity *a*, so as to induce in the iron a magnetic developement; the number of degrees of attraction, and the distance of the cylinder *x*, being noted, a second and similar mass of iron *cn* was then opposed to the induced pole; and thus, by making the distance *ab* always the same, and varying the distance *cd*, the magnetic developement in *da* remained the same, whilst the distance of the opposed iron *nc* became variable; and by making distance *cd* always the same, and varying *ab*, we are enabled to

vary the magnetic developement in da (19), whilst its distance from the opposed iron nc is constant.

The actual results are given in Tables VIII. and IX., the distance of x being made constantly equal to three-tenths of an inch. In Table VIII., D signifies the variable distance cd , and f the corresponding force, as expressed by the number of degrees which the index declined, the constant distance ab being two-tenths of an inch. In Table IX., F signifies the variable magnetic intensities produced by approximating the magnetic bar bm , through the respective distances 0.6, 0.3, 0.2, 0.15 of an inch, in order to obtain the relative forces 1, 2, 3, 4, (9); f is the force of induction as before; the constant distance cd being in this case also two-tenths of an inch.

TABLE VIII.

Magnetic Force by Induction constant. Distance variable.	
D.	f .
0.6	3.
0.4	4.5
0.3	6.
0.2	9.

TABLE IX.

Magnetic Force of Induction variable. Distance constant.	
D.	f .
1	3
2	6
3	9
4	12

37. Having considered some of the principal phenomena of induced magnetism, we may now investigate more particularly the force made up of the reciprocal attraction between a magnet and a mass of iron, when placed at different distances from each other. It may be observed (19), that this combined force exerted between a mass of iron bc , Fig. 5, in a temporary magnetic state, and the suspended body x , which must be considered also in a temporary magnetic state, is, at a given distance, directly proportional to the intensity of the inductive magnet m , and in an inverse proportion to the distance cd , the magnet m remaining unchanged. From which we may conclude, considering

the iron bc as a magnet, that the distance ab between a magnet and a mass of iron being constant, the absolute attractive force will be directly proportional to the power of the magnet bc , and consequently to the force induced in the iron x . Thus, if two magnets, whose separate forces of induction on a mass of soft iron, at a constant distance, have been previously well determined, be opposed to the suspended iron x , as in Fig. 1, then the respective attractive forces, at a constant distance, as shewn by the index, will be observed to vary in the same ratio as before; and if both the magnets be now conjoined and opposed to the suspended iron x , at the same distance, then the indicated attractive force will be the sum of the two former forces, or very near it.

38. That the absolute force of attraction exerted between a magnet and a mass of iron should vary with the power of the magnet, and consequently with the force induced in the iron, all other things remaining the same, is what might have been previously supposed; but the ratio in which this same force of attraction might be expected to vary, when the force induced in the iron x , Fig. 1, is a constant quantity, whilst its distance from a magnet H is variable, the magnetism of H being either temporary or permanent, is not so apparent; nor has such a case, as far as I am aware, been yet contemplated; beside, that the possibility of obtaining satisfactorily all the conditions of such an experiment would appear at first somewhat doubtful. The results, however, before given (19), enable us to investigate experimentally such a case. Thus, by varying the distance cd , Fig. 5, between a magnet and a mass of iron, we can, as before observed (24), within certain limits, obtain any relative magnetic intensity required; and by varying the distance ab between the temporary magnetic pole of the iron bc , and the iron x , we can preserve the force induced in x constant. Thus, if we dimi-

nish cd one-half, we double the force in bc ; and if the distance ab was preserved, the force in x would become likewise doubled (29); but if, whilst we diminish cd one-half, we double ab , then (19) the force in x will remain as before. We may thus preserve the induced force in the iron x a constant quantity, whilst its distance from the inductive magnet bc is a variable one; and hence arrive at the reciprocal force of attraction under these conditions. The experiment being thus arranged, it was clearly shewn, that the absolute force *varied with the distance, the induced force in the iron being a constant quantity*. Thus, by diminishing cd one-half, so as to double the magnetic intensity of bc , and at the same time doubling the distance ab , the number of degrees marked by the index were as two to one. By decreasing cd to one-third, and trebling ab , the observed forces were as three to one; and so on.

This curious fact was not only apparent when the magnetic force was varied by induction, but was also satisfactorily shewn, when varied by magnets whose relative powers of induction were previously ascertained.

Thus, two magnetic bars being selected, whose inductive powers were as two to one, they were placed in succession immediately under the suspended iron x , as in Fig. 1, but in such way that their respective distances from x should, as in Fig. 16, be inversely proportional to their powers of induction, the stronger magnet $2m$ being placed at double the distance; hence the want of power in the weaker bar m was compensated by its diminished distance ab (19); so that the force induced in x was in each arrangement the same; the forces, however, marked by the index were inversely proportional to the distances ab and cd *.

* Although this result, as disconnected with the previous investigations concerning induced magnetism, it may be readily imagined, must happen, admitting the

39. We may conclude from these investigations (37, 38), that the actual force exerted between a magnet and a mass of iron is directly proportional to the force induced in the iron, and inversely proportional to the distance, all other things being the same; and this leads us more immediately to consider the absolute attractive force of a magnet and a mass of iron, the distances between the iron and magnet, and the force induced in the iron, being both variable.

This case of magnetic attraction, which applies immediately to the general law, as determined by the celebrated COULOMBE, and likewise by many other profound inquirers, is readily investigated, by placing a magnet to act directly on the suspended cylinder of soft iron x , as in Fig. 1., at different distances, by which means we vary the induced force in the iron x , and the distance simultaneously. Thus, if we decrease the distance, Fig. 1, one-half, we double the force induced in x (19), whilst we diminish the distance in the ratio of 2 : 1. If we decrease the distance to one-third, we treble the force in the iron x , and at the same time diminish the distance in the ratio of 3 : 1, and so on: the absolute or total attractive forces will consequently, from what has been already stated (37, 38.), be respectively in the ratio of 4 : 1 and 9 : 1; and hence we obtain a final force, which is observed to vary in the inverse ratio of the squares of the distances between the attracting bodies. Thus, when a long cylindrical magnet in Fig. 1. not greatly exceeding the suspended iron x in diameter, was placed immediately under it, the distance being an inch, the force indicated amounted to 5°. On diminishing the distance to half an inch, the index moved forward to 20°.

general law of magnetic attraction about to be demonstrated, namely, that of the inverse square of the distance; yet, on examination, and as will be further shewn, it will be found to depend exclusively on the operation of induction, and that where this operation does not proceed, the law above named no longer obtains.

The following are the results of two series of experiments, in which the distances and forces were compared by decrements of the tenth of an inch, and it will be perceived, that the trifling irregularities occasionally observed in some of the numbers, are not of such importance as to leave any doubt concerning the law we have been endeavouring to determine, and are, besides, in many instances not appreciable by the instrument. In these experiments, two magnets were employed, designated by A and B, and were such as to ensure, as far as possible, accurate results, the conditions before explained (17) being fully considered: D signifies the distance between the iron and magnet, and f the corresponding force of attraction; the distances being adjusted by the apparatus before described (10).

TABLE X.

Showing the Attractive Force of a Magnet and Iron on each other at various distances.

A, north pole.		5° attraction = 1 grain.	B, south pole.	
D.	f .		D.	f .
1.0	4.5		1.0	6.0
0.9	5.5		0.9	7.5
0.8	7.0		0.8	9.5
0.7	9.5		0.7	13.0
0.6	13.0		0.6	17.0
0.5	18.0		0.5	24.0

40. The law observable in the preceding experiments may be generally observed by approximating the pole of any magnet toward the suspended iron x , whether a small cylinder of precisely the same dimensions, or otherwise a powerful magnet of any form and length. The variation in the angles at which the attractive force of the latter may be supposed to act on the suspended iron, where the opposed surface is more extensive, not having for a short distance any material influence in disturbing the uniformity

of the result. The same law may be likewise made evident, in substituting for the suspended iron α a small magnet, and approximating toward it a mass of soft iron, as in the following Table, which are the actual results obtained from an experiment so arranged.

TABLE XI.

Showing the Attractive Force, by opposing a Mass of Iron to a Magnet.

D.	f .
0.6	1.5
0.4	3.5
0.3	6.0
0.2	13. +

41. It has been observed (24) that the ratio of the inductive effect of a magnet on a mass of iron begins to vary when the iron and magnet are very nearly approximated. The precise point depending on the magnetic intensity; we may therefore suppose that a small mass of iron opposed to the pole of a very powerful magnet, would become magnetised, nearly to saturation, even before the magnet and iron were brought into contact, so that, for a short distance, the increments of the force induced in the iron would be so very small, that, in such case, it might be considered as constant; and hence the reciprocal attractive force would, for near approximations, no longer vary in the duplicate inverse ratio of the distances, but in an inverse ratio very near that of the distance only,—the induced force in the iron being considered constant (38); and such is found to be the case, as will be further shown (47.).

42. We have more immediately considered, in the preceding inquiries, the attractive force exerted between a magnet and a mass of magnetized iron, in which case a permanent magnetic de-

velopement is supposed to exist only in one substance: we have now to consider very similar phenomena evinced in the action of one magnet on another, in which case there is a permanent magnetic developement in both substances,—a case of magnetic action somewhat more complicated than the former, but which is still susceptible of a similar experimental examination, the inductive action being observed to proceed, whether the bodies be permanently magnetic or not, or whether opposed at their similar or dissimilar poles*. We have consequently to investigate the operation of this inductive influence when the bodies under examination have a permanent magnetic developement of greater or less extent.

43. In order to examine the inductive action of one magnet on another, a magnetised piece of steel *bc*, Fig. 5. was placed under the suspended iron *x*, and the attractive force at a given distance duly noted. A magnetic bar *m* was then placed under it; first the similar poles, and secondly the dissimilar poles, being opposed, having previously ascertained the force of the magnetized steel *bc* at each pole, and made them equal, and having also equalized the poles of the magnet *m*, and ascertained their force. The results obtained from a series of experiments thus arranged, appeared to show in a satisfactory way that the forces acquired or lost by the magnet *bc*, at its superior pole, in consequence of the inductive action, were, within certain limits, in the inverse ratio of the distance between the two magnets; after which the increments or decrements began to diminish. In the following Table, are seen the results of a series of experiments

* Although by opposing two magnets at their dissimilar poles, we in great measure destroy their permanent magnetism, yet the inductive influence by which this is effected must still be considered as a new force induced in the magnets, since it has been capable of producing a certain effect.

with different magnets, marked 1, 2, 3, 4. D signifies the distance *cd*, Fig. 5.; and *f* the corresponding force of induction, as measured by the increments in the attraction in the case of the opposite poles being opposed, and by the decrements when the similar poles were opposed.

TABLE XII.

D.	DISSIMILAR POLES.				SIMILAR POLES.			
	1.	2.	3.	4.	1.	2.	3.	4.
	<i>f.</i>	<i>f.</i>	<i>f.</i>	<i>f.</i>	<i>f.</i>	<i>f.</i>	<i>f.</i>	<i>f.</i>
2.0	1.0	2 —	2	4	1.0	2 —	2	4
1.5	1.5	2.5	2.5 +	5.5	1.5	2.5	2.5 +	5.5
1.0	2.0	3.5	4	7	2	3.5	4	7.5
0.5	3.5	6.0	7	10	3.5	4.5	5	11 —
0.3	4	7	10		4	5	6	
0.2	5	9.5	11.5		4 +	5 +	7	
0.1	8	11	14.5		4.5	5.5	7.5	

The limits within which the inductive action varied according to a uniform law, would, from these experiments, appear to depend on the magnetic intensities, and on the circumstances before observed (24.); so that the precise distance at which it becomes irregular in its action, is not the same for each magnet; and it may be further observed, that, when the inductive action operates in a contrary sense to the poles of the magnets, the decrements vary at last more rapidly than the increments, supposing in the latter case the induction to operate in the same sense. These are points of great consequence in all experimental researches concerning the reciprocal attractive or repulsive force, as exerted between two magnets.

44. Similar variations from a regular law are observable, when the force of a magnet is made to vary, the distance between the two magnets remaining the same. Thus a magnet of a double force, opposed to the inferior pole of another magnet, circum-

stanced as before explained (42), does not, at all distances, exert an inductive influence proportionate to its power on unmagnetised iron.

In the following Table are given the results of two series of experiments with magnets, whose inductive powers on unmagnetised iron were as 2 : 1 ; and it will be seen that this ratio is not the same at all distances from the magnetised steel. The magnets are denoted by A and 2A, placed over the respective forces of induction ; D being the corresponding distance.

TABLE XIII.

D.	A.	2A.
2.0	2	4
1.5	2.5	5
1.0	4	7.5
0.5	6	11

These experiments shew that a variety of cases may exist in which the intensities of the magnets become so circumstanced, in relation to each other, that the inductive action no longer proceeds.

45. The absolute attractive or repulsive force exerted between two magnets at various distances, will materially depend on the operation of the inductive influence, the induced forces and the distances being both variable ; for we have already seen (39.), that the absolute force exerted between a magnet and a mass of iron, varies with these quantities conjointly. The same may therefore be inferred of the absolute force exerted between two magnets ; for a very little reflection will serve to show, that, in estimating the absolute force exerted between them, it is still the same compound action which we measure (39.). Thus, as already observed, when only one of the bodies B, Fig. 6. is permanently magnetic, the absolute force is directly proportional to

the force induced in A, and inversely proportional to the distance Ns (37, 38.); and this must be still true, though A be supposed also a magnet, seeing that the inductive action still proceeds (43.); and thus the absolute force of B upon A will vary as before (39.); but A being now supposed also permanently magnetic, it exerts a similar force on B, and which will consequently vary in the same way. Therefore, the whole attractive force between A and B will still be found to vary in an inverse ratio of the square of the distance, supposing the inductive action to go on uniformly. And this will be true, whatever be the relative magnetic intensities, the only difference between this action and that exerted between a magnet and a mass of iron, arising from the circumstance, that, in the latter, there is only one primary inductive action in the operation, whilst in the other there are two.

46. In order to investigate the absolute force of attraction or repulsion, as exerted between two magnetised bodies, the distances and induced forces being both variable, it is only necessary to substitute a small magnet for the cylinder of soft iron x , Fig. 1., and observe the attractive or repulsive forces by approximating toward it either the similar or dissimilar poles of another magnet, in the way before described (39.)

We have already considered (17.) some of the circumstances likely to interfere with the accuracy of an experiment thus arranged, and we have shewn that a limit may be determined, without which the action of the other poles may be supposed of no assignable value. It remains, however, still to be considered, what subsequent change is likely to be produced in this limit cd , Fig. 6, 7, 8., by the inductive action of the similar or dissimilar polarities on each other. Now, it was shown (33.), that the inductive influence of dissimilar polarities lessens their free action: the approximation of the polarity N towards s will there-

fore, supposing them of an opposite kind, tend to neutralize each other's force, and thus extend the limit CD. It is therefore extremely probable, that, in some cases, the opposed polarities N and *s* may so neutralize each other's action in regard to the other polarities *n*, S, that the force may be considered as ultimately reduced to that of two insulated points. A similar result may be supposed to follow, when the polarities are of the same kind; for although the approximation of similar polarities would seem to reduce the limit CD, yet the inductive influence (43.) tends to reverse the repelling poles; and thus the forces of the distant polarities become also neutralized. The limit CD may be therefore extended in both cases, and in many instances may vanish altogether.

In the following Table are the results of a series of experiments with the attracting and repelling poles. The magnets employed are indicated by the letters *a, b, c, d, e*, their dimensions being as follows:

- a*, A small cylindrical magnet two inches long, 0.2 of an inch in diameter, and similar in every respect to the suspended magnet *x*.
 - b*, Four and a half inches long, and four-tenths of an inch square.
 - c*, Seven inches in length, and seven-tenths of an inch diameter.
 - d*, Nine inches long, eight-tenths of an inch wide, and three-tenths thick.
 - e*, Fourteen inches long, one inch wide, and half an inch thick.
- D, signifies the distance; whilst the letters *a, b, c, d, e* are placed over the respective forces.

TABLE XIV.

D.	DISSIMILAR POLES.					5° of attraction equal one grain.	SIMILAR POLES.				
	a.		c.	d.	e.		a.	b.	c.	d.	e.
4	3 +	3 +	
3.5	4 +	4 +	
3	6 —	6 —	
2.5	8.5	8 +	
2	2.5	3	13	2	2.5	13	
1.8	3 +	3.5 +	16.5	2.5	3 +	15 +	
1.6	4	4.5 +	21	3	4 +	18.5	
1.5	4.5	5.5	23	4	5	20	
1.4	5.5 —	6 +	28	4.5	5.5	23	
1.2	7	8.5	38	5.5	7	28	
1.0	1.5	2	10	12	49	1.5	2	7	9	33	
0.8	2 +	3 +	15	21	...	2	3	10	11	42	
0.6	4	6 —	25 +	32	...	3 +	5	14	14	56	
0.5	6	8	33	40	...	4	6.5	15.5	14 +	60	
0.4	9	11.5	6	9	17	13 *	58 *	
0.3	15	18	8	11	11 *			

47. These experimental results are quite consistent with the operations of the inductive influence before explained (43.) We immediately perceive, by referring to the attractive forces, that the law of the inverse square of the distance is manifest through all the approximations, except a few of the last, the occasional irregularities observed being very inconsiderable; so that when the magnets are very nearly approximated in relation to their respective intensities (44.), the increments in the forces begin to decline,—a circumstance of considerable importance in our endeavours to investigate the laws of magnetic attraction; for it may be supposed that the inductive influence which thus begins to vary, may at last so far vanish, even before contact, that the absolute force, at near approximations, may, in some instances, as already stated (41.), be in an inverse simple ratio of the distance, and which was observed to happen with the bars marked *d* and *e*.

* At these distances the repulsive force was superseded by attraction.

For although the cylindrical counterpoise employed in these experiments did not admit of the forces being examined at nearer approximations than those marked in the table ; yet, by substituting one of large dimensions, the forces may be carried on nearly up to the point of contact, so as to be estimated in terms of the preceding progression, since the degrees of attraction may be always compared and valued in grains of absolute weight (13.)

In the following Table are the results of the experiments so continued with the magnets *d* and *e* ; the counterpoise employed being one inch in diameter, 1° of attraction corresponding to 10° of the former, and being equal to two grains of absolute weight.

TABLE XV.

DISSIMILAR POLES.		
D.	<i>d.</i>	<i>e.</i>
0.4	6	.18
0.3	8.5	.24
0.2	13	.36

It may be perceived in this table, that the corresponding forces, at near approximations, do not materially vary from a simple inverse ratio of the distance.

48. This deviation from the law of the inverse square of the distance, observed in all the near approximations of the magnets in Tab. 14. may happen, as before observed (24.), either in consequence of the distant polarities having passed a certain limit, or otherwise from the inductive action not going on with the same freedom at some point approaching saturation. The latter would seem to be extremely probable, for it has already been shown (33.), that when two dissimilar polarities are opposed to each other, their free action becomes more or less neutralized. In examining, therefore, the inductive action upon a mass of iron *bc*, Fig. 5. (19.), the polarity *d* would have its free action so much reduced,

that the polarity b may be considered as always without the limit of its influence. If we add, at the same time, the neutralizing effect of x upon b , then the action of b upon d may vanish altogether. With respect to the distant polarity of m , that may, when m is a very long bar, be always considered without the limit of the action. In this case, therefore, the decrements of the inductive force in bc , as already stated, would seem to be altogether independent of any disturbance arising from the action of the *similar* poles, although, in examining the reciprocal force exerted between a mass of iron and a magnet, or between two magnets, both these causes of disturbance may probably be in operation within certain limits; and they sufficiently explain the anomalous results arrived at by different philosophers in their attempts to investigate the law of the absolute force exerted between two magnets, or between a magnet and a mass of iron, when placed at different distances from each other: some asserting that it decreased in the inverse ratio of the squares, and others in that of the simple distance; whilst many concluded, that it followed no regular law whatever, but was different for different magnets.

49. The results of the experiments with the repelling poles, are equally interesting with those of the attracting, as furnishing useful illustrations of the causes which operate in deranging the uniformity of the result. The deviations, as may be anticipated from what has already been shewn (43.), are more considerable than in the former case. It will be perceived, that a few of the first approximations in each case differ very little from the law of the inverse square of the distance; but they soon become very irregular, and afterwards approximate to the inverse ratio of the distance, until, in some instances, the pole of the weaker magnet is apparently changed by the inductive influence, and the repulsive force is superseded by attraction. The most prominent feature, therefore, in these experiments with the repelling poles,

is the circumstance of the force becoming less and less, until the polarity of the weaker magnet appears to be so counteracted by induction, that the repulsion is at length superseded by attraction *. Hence, the repulsive power of one magnet, as measured by its force on the similar pole of another, will never be equal to the attractive power, as measured by its force on the same pole, except the magnets happen to be of very powerful intensities, or opposed to each other nearly at the limit of their action, when the tendency of the inductive influence begins to be felt, without the polarity of the magnets having undergone a sensible change.

50. The curious phenomena of magnetic repulsion, which follow when two similar polarities are opposed to each other, would hence seem to arise from the tendency of the inductive influence to cause a new polar arrangement, which action the established polarities resist ; so that the repulsion will be more or less evident, as the magnets are of greater or less intensity, or are separated by a greater or less distance. Thus, when one of the poles of a weak magnet is opposed to the same pole of a magnet having a great intensity, the pole of the weak magnet, if the distance between them be small, is instantly reversed, and the repulsion is not apparent, but a weak attractive effect is ob-

* Although the polarity of the small magnet in these experiments seemed to be reversed, inasmuch as the repulsion was superseded by attraction even before contact, yet the new polarity by induction did not appear to be permanent, since the repulsion again obtained when the distance was increased. Thus, both the phenomena of attraction and repulsion ensued, merely by varying the distance in a small degree between the magnets. The forces indicated at near approximations with the repelling poles, are only given in illustration of the curious fact, that the pole of the weaker magnet becomes reversed before contact. We cannot consider them as quite accurate for any purpose of calculation, as the suspended magnet, in consequence of the great repulsive force, is thrown out of its perpendicular direction.

served to take place. If the distance be increased, the repulsion is evident; for the strong magnet operating at a greater distance, the inductive effect is diminished (19); so that it now proceeds with less energy, and only to a certain extent. If the magnets be supposed equal, then the repulsive effect will be evident at all distances, and the tendency to a new polar arrangement will never pass the limits of equal distribution in each bar, supposing the opposed poles actually in contact.

The inductive action, therefore, according as it proceeds in the same or in an opposite sense to the polar arrangement already existing in two magnets, will either tend to increase or diminish their force; an effect so well understood practically, that, to preserve the power of the magnets perfect, they are usually arranged with their dissimilar poles in contact.

51. Our observations have been hitherto exclusively directed to the action of a magnet on soft iron, or to that of one magnet on another; but it may not be improper, before concluding them, to consider the law of the magnetic distribution in an artificial magnet of a regular figure; since, in assimilating these phenomena with terrestrial magnetism, it is of great consequence to determine the law according to which the forces are developed in different points of the longitudinal magnetic axis between the centre and poles.

For this purpose, two bars were selected, regularly hardened throughout, and magnetized, the poles of each separate bar being equal, and the magnetic centre or point of indifference equally distant from either pole. The centres and poles were carefully ascertained by means of filings of soft iron, which were sifted immediately over them on a sheet of paper strained tight on a hollow frame of wood. The line which divided the magnetic curves was observed and noted, and equal successive portions were marked off on each side of it toward the poles.

The cylinder of soft iron *x*, Fig. 17, being suspended as in the former experiments, and the bars placed immediately under it in succession, the intensity of different points between the centre and poles were carefully ascertained, by moving along the magnet under examination, so as to bring these points successively under the suspended iron; and the constant distance ascertained and preserved by means of the moveable scale and the adjusting screws, as in the former experiment (23).

In this experiment, it is essential to reduce the action to the point *a* immediately under the suspended iron, a condition which, in a purely theoretical sense, is not possible to be fulfilled; inasmuch as the attractive force will be involved in the combined action of all the other points of the bar. We may, however, under the circumstances already considered (22), approximate so nearly to it, that the resultant will not differ very materially from that of the force at *a*; so that, for a long series of points, we may obtain a uniform law, as appears evident by the following Table, in which D signifies the distance from the centre in half inches, and F the corresponding forces of attraction; the constant distance of the suspended iron *x* being placed immediately after the letters AB, which denote the respective bars.

TABLE XVI.

A 3.		B 2.	
D.	F.	D.	F.
1	1	1	0.5
2	4	2	2.0
3	9	3	4+
4	16	4	8.0
5	25		
6	36		

From these results, it would appear, that the law of the distribution varies directly as the square of the distance from the

magnetic centre ; and this law can always be made apparent in a bar of steel regularly hardened and magnetized throughout. The results, however, are by no means certain in bars whose temperament and texture is irregular, or which are only hardened at the extremities : in the one case the magnetism is irregularly retained, in the other it is only sensible at the poles of the bar.

52. In order to avoid the interference of the angular forces to a still greater extent, so as to have the action reduced as far as possible to that of an isolated point, the attractive force was made to operate through a small cylindrical piece of iron, about two inches long, *ab*, Fig. 18. Thus, the suspended iron *x* was preserved always without the influence of the bar. In this case, we may suppose, from what has been before shewn respecting magnets by induction, that, in consequence of the other points of the bar acting at angular distances upon the cylindrical mass of iron *ab*, the induced force arising from these points would, in certain cases, not exert a sensible influence on its distant extremity ; and thus the attractive force by induction would approximate very closely to that resulting from the point *b* of the magnet in contact with the iron, which would thus, compared with the other points acting at a distance, and under different angles, be very great, whilst a fair measure would still be obtained of the magnetic intensity ; for we have already seen (29), that the masses of iron under the influence of a magnet generally exhibit, at their distant extremities, an attractive force directly proportionate to the magnetic intensities, all other things remaining the same. Now, the successive points of a magnetic bar between the centre and poles, may be considered as so many distinct magnets, varying in intensity : the inductive effect on the iron in contact with them is, therefore, a fair measure of their force. In the following Table are given the results of a series of experiments thus arranged : the magnetic bar be-

ing *regularly hardened and magnetized*, and the centre poles ascertained as before ; it was 17 inches long, 1 inch wide, and 0.2 of an inch thick ; the constant distance ax at which the attractive force acted on the suspended cylinder x , was 0.2 of an inch, and the distances are expressed in inches.

TABLE XVII. *

D.	F.
1	0.5
2	2.
3	4.5
4	8.
5	12 +
6	18.
7	25. —
8	32.

53. As all the known operations of nature are generally of the most simple kind, it is not unreasonable to suppose, that wherever we find a compound law, that law may be resolved finally into two or more elementary ones. Thus, we have found, that the absolute force of attraction exerted between a magnet and a mass of iron, or between one magnet and another, and which has been found to increase in an inverse ratio of the square of the distance, is resolvable into two simple elementary actions (37, 38), one depending on the induced force in the iron, the other on its distance from the magnet. We may, therefore, sup-

* In a series of experiments of this description, where the forces are at first very inconsiderable, but afterwards increase rapidly, it becomes necessary to vary the dimensions of the cylindrical counterpoise W, Fig. 1, by which means we are enabled to examine the force in any point of the bar at a small distance ; whilst the degrees being previously estimated in grains of absolute weight, the whole can be expressed as if the same counterpoise had been employed throughout the experiment, as before explained (47), a certain number of degrees with one counterpoise corresponding to a given number with the other:

pose, that the magnetic distribution in an artificial magnet, the intensity of which increases in a direct ratio of the square of the distance from the centre, is still to be resolved into two simple actions, which may possibly be discovered by a little reflection on the manner of producing magnetic disturbance in bars of steel, and the laws according to which the opposite magnetic forces operate on each other.

54. Without stopping to inquire into the nature of the cause of magnetic phenomena, we shall only assume what is, in fact, evident by the most simple experiments, that in every magnet there are two opposite forces developed, whether we suppose them to be merely different states of the same principle, or whether we imagine them to be separate and distinct agents. These forces are observed to neutralize each other when united, and to exert more or less of free action as they become separated.

Some considerations concerning this free action have been already entered upon (30); but it will be requisite here to determine the free action developed, by separating the two opposite magnetic forces; the original magnetic intensities and the distances being both variable. For this purpose, two masses of iron bc , da' , Fig. 19, 2 inches in length, 0.75 of an inch wide, and 0.3 of an inch thick, were placed under the influence of the dissimilar poles of two magnetic bars N , N' , so as to induce in them the same magnetic intensities, as measured by the attractive force on the suspended iron x , in the way before explained (36), by bringing the opposite polarities c and d of the induced magnets in contact, their free action would be reduced to zero; whilst, by withdrawing them from each other, we could estimate the force of the free action in either of them; 1° when the induced magnetic force was a constant quantity, and the distance cd variable, the distance ab , $a'b'$ from the original magnets being the same; 2° when the distance cd was a constant quantity, but

the induced force variable, the distances ab , $a'b'$ being varied (36); and 3°, when both the distances and forces were varied; that is to say, when the distance cd , and the distances ab , $a'b'$ were varied simultaneously. The experiment being thus arranged, the forces set free, as expressed by the index, at the extremity d of one of the masses of iron, were found to vary with the distance cd , when the induced forces were the same, and with the induced forces when the distance cd was the same; and, finally, with these quantities conjointly, when they were both made variable.

55. Now, by whatever artificial method we suppose a bar of steel to be made a magnet, whether by the single or double touch, it would not be difficult to shew, that the first states of the magnetic disturbance, as measured from the magnetic centre, would be in an arithmetical progression. Thus, if we suppose a bar of steel ab , Fig. 20, to have been magnetized, then the forces impressed on each side of zero may at first be conceived to go on in the arithmetical progression 1, 2, 3, or 1', 2', 3', &c. If we conceive these forces to be all united in the centre, their free action would be zero. Let us now suppose these opposite forces to be withdrawn through the distances 1 1', 2 2', 3 3', &c. successively; then, by the preceding experiments (54), the forces set free in the points 1, 2, 3, &c. 1', 2', 3', &c. would vary directly as the square of the distances from the magnetic centre, since they vary directly with the magnetic intensities, and directly with the distances.

In the few theoretical illustrations found in the preceding observations, it has been my endeavour to wander as little as possible from experimental facts. I have not the vanity to suppose that my researches are such as to defy the scrutiny of a critical examination, or that, in so difficult an inquiry, I have obtained perfection. It is only by examining nature in a great

variety of ways, that we can ever hope to arrive at an accurate knowledge of her laws. I therefore submit the results which I have obtained to the scientific world as matter for candid consideration, having, at the same time, a proper sense of my own limited powers of research*.

PLYMOUTH,)
 July 1. 1827. }

* It may not be improper to state, that, in the preceding inquiries, the attracting or repelling forces have been supposed to act in parallel lines. This appears to be an essential condition of this species of force; since the reciprocal influence of any two points directly opposed to each other, as *ab*, Fig. 21, 22, 24, must be such as to neutralize each other's action in relation to any other point more distant; the action, therefore, between the points immediately opposed to each other is exclusive, being the nearest, and consequently the forces are parallel.

It is, therefore, only when the attracting surfaces are of unequal extent, that it becomes necessary to take into the account any other force, as *cd* and *ef*, Fig. 22, which, in a great variety of instances, are of no assignable value; but to obviate any error which can arise from this cause, it is requisite, when very powerful magnets are employed, to give the attracting extremity of the bar an armature of soft iron, as represented in Fig. 23. A, which, in diminishing from its base, terminates in a cylindrical surface exactly equal to that of the suspended body *x*; by which means the angular forces, as *cd*, *ef*, Fig. 22, are so intercepted and reduced, as to be of no assignable value.

When the attracting surfaces are spherical and equal, it is requisite to determine a fixed point in each opposed hemisphere, as *x* and *y*, Fig. 24, from which the sum of all the attractions would produce the same effect as if those attractions were exerted from every point of the hemispheres; so that, in varying the distances, the intervals may be estimated from these points, and not from the immediate point of contact. These points I have found by numerous experiments fall within the opposed hemispheres, at a distance equal to one-fifth of the radius of the spheres, supposing them equal.

XIX. *On certain new Phenomena of Colour in Labrador Felspar, with Observations on the nature and cause of its Changeable Tints.* By DAVID BREWSTER, LL. D. F. R. S. S. L. & E.

(Read May 20. 1829.)

SIR ISAAC NEWTON'S theory of the colours of natural bodies, is perhaps the most ingenious and lofty of all his speculations. It was devised, however, at a time when the doctrine of light had made comparatively but little progress, and before the discovery of various principles on which the colours of bodies must depend, or by which, at least, they must be extensively modified. The different dispersive powers of transparent substances ;—the irrationality of the spectrum ;—the action of striated surfaces ;—the decomposition of polarised light ;—the reflection of coloured light at the confines of equally refracting media ;—and the absorption of common and of polarised rays,—are principles which embrace within their individual range a great variety of facts to which the Newtonian theory of colours bears no relation. In that theory, indeed, we recognise more the flight of a transcendent genius, than the patient and anxious step of inductive research ; and so firmly has it entrenched itself among the strongholds of modern science, that no regular attempt has been made to unsettle it, or even to submit to a rigorous analysis the various phenomena of colour, as displayed in mineral and vegetable bodies, and in the artificial combinations of the laboratory. Such a task I should not have presumed to undertake ; but in the course of an extensive examination of minerals, the subject has been forced upon my attention, and having extended the inquiry to vegetable bodies, as well as to chemical combinations, I pro-



Fig. 1.

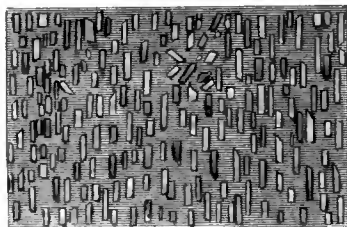

Fig. 2.

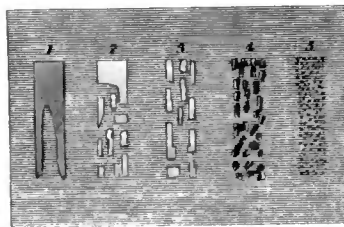

Fig. 3.

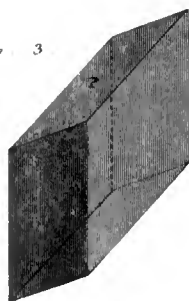

Fig. 1.

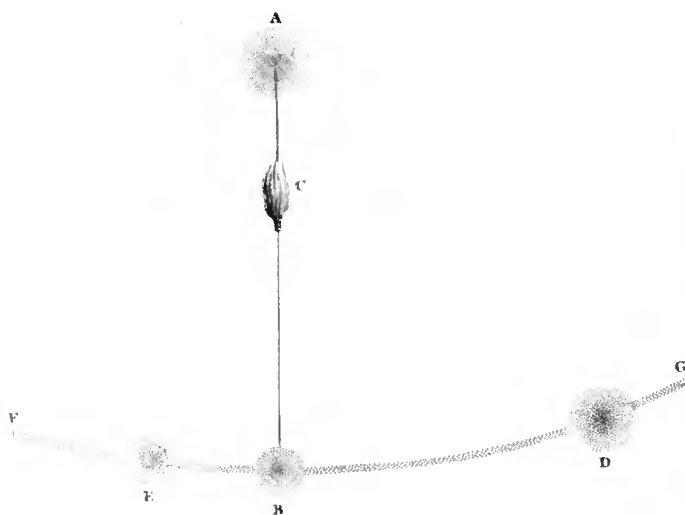
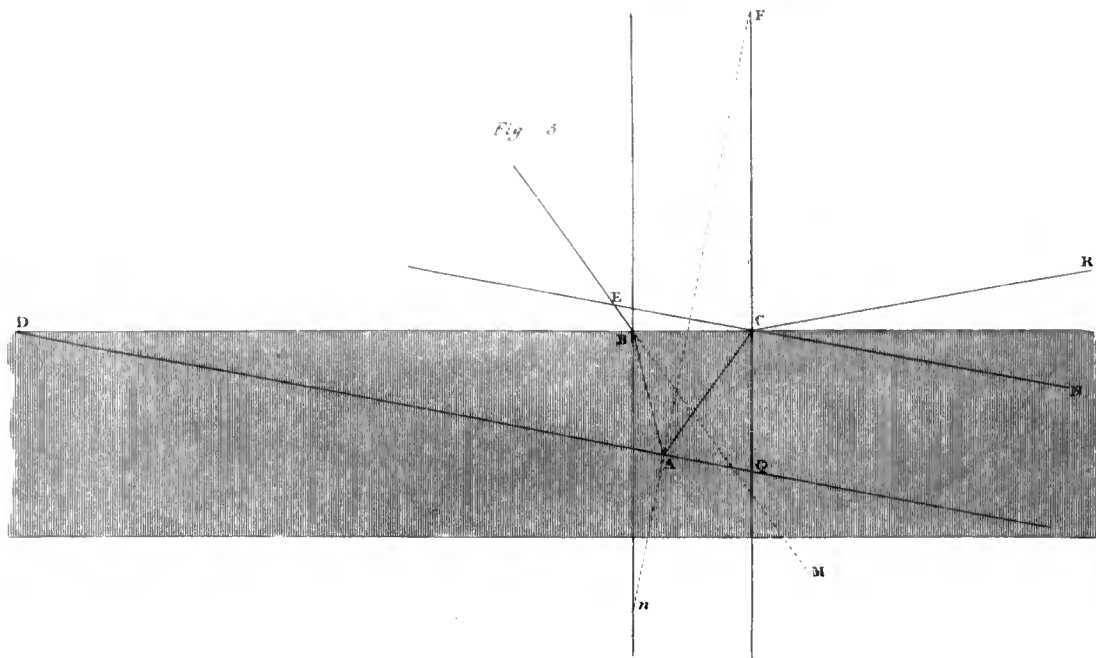

Fig. 5.



pose, in a series of papers, to submit the results to the Royal Society.

In my account of the Cavities in Topaz, and other minerals, I have mentioned the frequent occurrence of strata of cavities, so minute that they are scarcely capable of being resolved by the most powerful microscope. In the larger cavities, their depth is sometimes very small, compared with their other dimensions; but in the more minute pores, as they may be called, there is a greater equality in their length, breadth, and thickness, and I have never been able to recognise any thing like the colours of thin plates reflected from the strata which they compose.

In seeking for the new fluids in Labrador felspar, the fine changeable tints of that mineral could not fail to excite particular attention; and after examining some specimens, I discovered a new set of colours, which seemed to be capable of a distinct analysis. When these colours are seen by a microscope, and under strong illumination, they form a highly beautiful phenomenon, somewhat resembling Fig. 1. Plate XIII.

The coloured portions have the form of parallelograms, sometimes complete, sometimes truncated at the angles, and sometimes so rounded as to have no regular outline. Their longest sides are generally parallel to one another, and they are sometimes arranged in groups, with their homologous lines in different directions. The parallelograms are not distributed in a single stratum. They appear at different depths; and those which are much below the surface have little brilliancy, owing to the imperfect transparency of the mineral. These coloured spaces vary from the 40th or 50th of an inch in length, to the most minute point which the microscope can descry.

The tints reflected from these spaces are generally very brilliant. They are sometimes white, and sometimes all of one colour, but I have never found them below the blue of the second order of NEWTON'S scale. The surface which reflects them,

generally displays throughout the very same tint ; but in some cases, the same parallelogram exhibits different colours at the same angle of incidence, owing sometimes to the mixture of the tints of superposed parallelograms, and sometimes to the variable thickness of the space by which the colours are occasioned.

The parallelograms which produce the colours now described, may be crystallized laminæ disseminated through the felspar, and giving the colours of thin plates ; or they may be slender crystals, which, like the veins of calcareous-spar, develop the tints of polarised light ; or they may be crystallized cavities, either entirely empty, or containing solid, fluid, or gaseous substances.

The exceeding toughness of the mineral renders it impracticable to obtain good cleavage planes, passing through the parallelograms, for the purpose of shewing their interior, or of discharging their contents, as I succeeded in doing while examining the topaz cavities, so that I had no other resource but that of optical analysis.

As it was necessary to examine the light transmitted through the parallelograms, I detached a very thin splinter from the mineral, and placed it in Canada balsam * between two plates of glass. It was so thin at one edge, that it did not give the colours of polarised light, and at its greatest thickness, it developed only the *red* of the third order. It had fortunately only one stratum of parallelograms, so that their reflected and transmitted tints could be observed with the greatest distinctness. The reflected tints were uncommonly brilliant and pure, but the transmitted ones were very faint, and of a yellowish, reddish, or greenish-brown colour, varying with the obliquity of the incident ray. I now placed the splinter on the base of a prism, with Ca-

* Oil of Cassia would have been preferable in other cases, but as it has a colour of its own, and disperses light so powerfully, it was unsuitable where delicate tints were to be observed.

nada balsam interposed, and I found that the tint diminished as the angle of incidence increased, and that the same effect took place in the same degree in all azimuths. This experiment proved incontestibly that the colours were not those of polarised light. That the cavities do not contain a gas or a fluid of any kind, is obvious from the fact, that the felspar does not decrepitate or burst with heat. Hence, it follows, that the parallelograms must be either empty, or must contain indurated matter.

In order to ascertain, upon the supposition of the parallelograms being solid, whether the colour arose from the thinness of the solid matter, or from the thin open space which separated the surface of the parallelograms from the adjacent felspar*, I observed the particular tints which a number of individual parallelograms produced at a given incidence; and upon reversing the specimen, I found, that, in every case, the very same tints were developed at the same angle of incidence. This result clearly proves, that the tints were due to the thickness of the cavity, whether they were empty or filled with indurated matter.

The examination of individual parallelograms presents some instructive peculiarities. While the greater number give an uniform uninterrupted tint, several have the appearance shewn in Fig. 2. In No. 1, the parallelogram is imperfect. In No. 2, it is more so, though the individual patches of colour fill up its outline. In No. 3, they are smaller still, and more unequal. In No. 4, we can still discover the outline of each individual patch; but in No. 5, the patches are so minute, that the surface of the parallelogram produces all the variety of mottled colours. These phenomena indicate a general resemblance to

* It is from this cause that the splendid colours arise which accompany the dendritic crystallizations of titanium in mica, which I have examined with much attention.

indurated matter, but, when minutely examined, this resemblance disappears. The spaces between the individual patches are in almost every case dark, like the adjacent felspar; and when the microscope is capable of separating the individual patches, it becomes quite obvious, that, if they are grains of indurated matter, they are not disseminated through an empty cavity, but are imbedded in the felspar. We have no hesitation, therefore, in concluding, that all these little patches and specks of colour are empty cavities, like the large parallelograms, for the intensity of the light reflected from the small patches in Nos. 3, & 4. of Fig. 2, is the same as that reflected from the parallelograms. This light, indeed, is so strong, that nothing but a metallic substance filling the cavities, and in optical contact with their sides, could reflect it. If this were the fact, the analysis of the mineral could not fail to exhibit it, and I am not aware that any metallic ingredient, except titanium, has been detected in felspar. M. PESCHIER has announced this fact, but whether it was found in common Felspar or Labradorite, I have not the means of ascertaining. Professor ROSE of Berlin, however, who carefully analysed the Labradorite of various localities, has not been able to discover any such ingredient. But even if titanium were a constant element of Labradorite, the parallelograms could not contain that metal; for I have ascertained that titanium in optical contact with mica reflects much less light than the parallelograms; and since mica has a refractive power greatly inferior to felspar, titanium in optical contact with felspar, will reflect much less light than in contact with mica, and consequently much less light than the parallelograms.

Having thus determined that all the colours under our consideration are those of thin plates produced by minute cavities within the mineral, varying in magnitude from the 40th of an inch down to the most minute speck which the microscope can descry, we are entitled to refer the other phenomena of colour in the

same mineral to similar cavities, though we are no longer able to see their individual outline, or to recognise them in any other way but by their united influence.

The coloured parallelograms above described are, in general, parallel to the face P, Fig. 3, of the primitive form, as given by HAÜY; and in no specimen which has come under my examination, have I ever found them coincident with the plane of the common changeable colours which have been so long admired in Labrador Felspar. The largest generally occupy one plane; but I have found another set arranged in another plane, while others have their reflecting edges in a variety of different positions. This effect will be understood from Fig. 4. which represents the images reflected from all the different colorific planes in a specimen in my possession. When we look into the specimen, we see the image C of the candle formed by the ordinary polished surface cut at random. Let the felspar be now turned round till AC, the line joining the candle C, and the great mass of changeable colour A is in the plane of reflection, A being seen by rays incident at a greater angle than C. When this is done, we shall see a series of nearly coincident coloured images of the candle at D, which are the reflections from the parallelograms shewn in Fig. 1. At E, there is another set of nearly coincident images, fainter and less coloured than those at D. At B there is a third set, but they are still fainter and more indefinite. Through these three sets of images there passes an arch of reddish-brown light, extending on each side towards F and G, and formed by minute needle-shaped cavities, which being nearly of equal diameter in every direction except their length, must reflect light in whatever direction it is incident, provided it fall nearly in a plane perpendicular to their length.

We come now to the examination of the changeable colours of the spar, which, so far as I know, have never been submitted

to a physical analysis. So little attention, indeed, have they excited, that HAÜY, MOHS, and other writers, describe them as lying in planes parallel to the faces of cleavage; and in this circumstance HAÜY finds an easy explanation of their origin, by ascribing them to accidental fissures between the natural joints of the mineral*.

Although Labradorite abounds in fissures, I have never discovered any parallel to the general plane of changeable colour, and I possess a specimen in which the colours lie in various curve planes, cutting, at a great angle, all the natural joints of the crystal.

The first point which I was desirous of determining, was the position of the plane of changeable colour. For this purpose, I effected a tolerably good cleavage parallel to P, Fig. 3, and having placed the crystal on the goniometer, I turned it round in azimuth till the white image reflected from the face of cleavage, and the mass of coloured light from the plane of changeable colour, were both in the plane of reflection, the latter being formed by rays nearer the perpendicular. Let the surface of cleavage P, Fig. 3, be represented by DC, Fig. 5, and let RC be a ray of light from a candle incident at C. This ray will be refracted in the direction CA; and if CDQ is the inclination of the plane of changeable colour, the refracted ray CA will be reflected at A in the direction AB, and will emerge from the spar in the direction

* Elles proviennent, comme dans l'opale, des legeres fissures qui interrompent le tissu de la pierre; mais l'opale etant fendillée dans toutes sortes des directions, presente des reflets qui se succedent, à mesure qu'on la fait mouvoir, au lieu que dans le feldspath, dont les fissures coincident sur un seul plan; en sorte qu'ils se montrent tout entiers, lorsque la lumière est reflechie par ce plan, sous l'angle favorable pour la renvoyer à l'oeil, et disparaissent, des qu'on donne à la pierre un inclination differente. J'ai reconnu en observant un morceau de feldspath opalin de Norwege, qui m'a été envoyé par M. ESMARK, que les plans d'ou partoient les reflets dont je viens de parler, etoient dans le sens des faces T qui sont les plus etendues.—*Traité de Mineralogie*, tom. ii. p. 613.

BE. The eye at E will therefore see the reflected image of the candle in the direction ECN, and the mass of coloured light reflected at A, in the direction EBM. By measuring the angles, I found that when FCR was $78\frac{1}{2}^\circ$, the angle NEM, or the distance of the coloured image from the common image, was 57° . Calling this distance D, and making m the index of refraction for felspar, A the angle of refraction at C corresponding to the angle of incidence I or FCR, and B, the angle of refraction for a ray EB incident at B (which is equal to the angle of incidence AB*n*, when the ray passes out of the felspar), and x the inclination of the plane of colour, or CDQ, then we shall have

$$\sin A = \frac{\sin I}{m}, \quad \sin B = \frac{\sin I - D}{m},$$

and

$$x = \frac{A - B}{2}^*.$$

which will give $10^\circ 52'$ for the inclination of the plane of colour to the face of cleavage P, Fig. 3. The common section of these two planes nearly bisects the acute angle of the face P.

The changeable colours of felspar generally vary from the *blue* to the *red* of the second order. In the same specimen, the tint frequently shades off at the edges to the blue of the second order; and when we view it at an oblique incidence, by cementing a prism on the polished surface, they diminish from the maximum tint to the *blue*, and sometimes to the *purple* of the second order. The colours are not produced by a single plane,

* The demonstration of this is very simple. Through C and B draw B*n*, and FCQ perpendicular to DC, and through A draw AF perpendicular to DQ, and meeting B*n* in *n*. Then $x = CDA = AFQ = AnB$, and $BAF = ABn + AnB = B + x$. But $FAC = ACQ - AFC$; consequently, since $FAC = BAF$, and $ACQ = A$, we have

$$BAE = B + x, \text{ and } BAE = A - x. \text{ Hence,}$$

$$B + x = A - x, \text{ and } x = \frac{A - B}{2}.$$

but by an infinite number ; and when we chip off the smallest fragment, it gives the same colour as the thickest mass. If we have been successful in obtaining an extremely thin edge, we shall find that the brightness of the tint suffers an evident diminution, though the colour itself never changes ; and at the very edge of the splinter, we can descry, with a good microscope, the individual specks from which the colour is reflected.

We have already seen, that the light transmitted through the coloured spaces in Fig. 1, does not exhibit distinct complementary tints ; and the same indistinctness takes place in the light transmitted through extremely thin splinters that give the changeable colours. But when the spar is the 10th or 20th of an inch thick, the transmitted complementary tint is exceedingly distinct, and, by varying the incidence, it changes from yellow, the complement of the *blue* of the second order, to *blue*, the complement of the *red* of the second order.

Many of the larger cavities, which have a distinct outline, reflect a *white* tint, or a mixture of all the prismatic colours, an effect analogous to the white reflections of the Moon-stone, or *Feldspath nacrée* of HAÜY. “ Some lapidaries,” says HAÜY, “ give the name of *Argentine* to specimens of this variety whose pearly reflections, in place of proceeding from the interior, emanate from the surface, as in pearls*.” The effect here described I have examined in a specimen from Norway, but the light certainly proceeds from the interior, though, from the imperfect transparency of the mass, it appears to a careless observer to be produced at or near the surface. In this specimen, the white light is reflected from planes parallel, or nearly so, to one of the cleavage planes ; while in another face of cleavage, we observe an infinite number of small coloured specks of irregular outline pervading the whole of the specimen, but all parallel to one another, and inclined to

* *Traité*, tom. ii. p. 606.

the cleavage plane. The pearly light reflected from this specimen seems to be owing to a want of homogeneity in the mineral, in virtue of which portions of different refractive densities are in contact. The existence of such a structure is clearly proved by the great nebulosity that accompanies the images of luminous objects, and by the dimpled surface of its cleavage planes, when examined by the microscope. This variety of felspar differs as widely from the common Labradorite, as Chalcedony does from Quartz, and the distinctive character arising from its heterogeneous structure is as easily appreciated.

In a fine specimen of felspar belonging to Mr ALLAN, there are, besides the plane of changeable colour, two other planes, which reflect a silvery white light from long and narrow parallelograms. Each of these last planes is formed of portions not accurately parallel to each other, and hence the reflected light is divided into separate masses. These masses are bounded by the prismatic colours, which disappear when the trace of the plane of reflection is parallel to the common section of the reflecting plane and the surface of the specimen, and reach their maximum when these lines are at right angles to each other. Hence, the prismatic colours are produced by the prism of felspar bounded by that surface, and by the plane that reflects the silvery tints. By ascertaining the angle of a prism of felspar which connects the maximum prismatic tints, we obtain the inclination of the reflecting plane to the surface of the specimen.

In many specimens of felspar, I have observed with the microscope minute crystals and very small spheres of a metallic substance, which I have no doubt is titanium, and which has probably given rise to the peculiarities of M. PESCHIER'S analysis.

XX. *On the Composition of Blende.* By THOMAS THOMSON, M. D.
F. R. S. L. & E., Professor of Chemistry, Glasgow.

(Read 2d February 1829.)

IT is nearly a century since chemists began to suspect the nature of the well known mineral usually distinguished by the name of *Blende* or *Pseudo-Galena*. BRANDT, in 1735, showed that zinc was one of its constituents*. In 1744, FUNCK demonstrated that it was an ore of zinc †. MARGRAAFF soon after actually extracted zinc from it ‡. It was impossible to subject it to heat in an open vessel, without perceiving that it contained sulphur. But chemists did not succeed in their attempts to combine zinc and sulphur together. This led them to conclude, that in blende the zinc and sulphur were united together by the intervention of iron. This opinion was stated by CRONSTEDT in the first edition of his Mineralogy. In 1779 BERGMAN attempted an analysis of blende, and drew, as a conclusion from his experiments,

* BERGMAN. Opusc. ii. 313.

† KONIGL. Vet. Acad. Handl. 1744, p. 57.

‡ Opuscul. de MARGRAAFF, i. 190.

that it was composed of

Sulphur,	29
Arsenic,	1
Water,	6
Lead,	6
Iron,	9
Zinc,	45
Silica,	4
	100*

But his mode of analysis was so bad, that it is obvious he could draw no legitimate conclusion respecting the constitution of blende from his experiments.

About the beginning of the present century, it was generally admitted by chemists and mineralogists, that blende is a sulphuret of zinc. But the unsuccessful attempts to combine sulphur and zinc together by heat, induced MORVEAU to believe that the zinc in blende was in the state of oxide. PROUST, however, showed, that when blende is mixed with charcoal, and exposed to a red heat, no sulphurous acid whatever is given off †; which led him to conclude, that in blende the zinc is in the metallic state. This opinion, in consequence of the progress which chemical science has made, has been for these twelve or fourteen years universally adopted. Though I am not aware of any modern chemist who has attempted to determine the proportions of its constituents with rigid accuracy except ARFWEDSON, who has given us an analysis of a very pure specimen of blende in the Memoirs of the Stockholm Academy for 1822, p. 438.

ARFWEDSON employed for his analysis yellow-coloured and

* Opusc. ii. 330.

† Jour. de Phys. lvi. 79.

crystallized blende. And his method of proceeding was as follows :

1.758 grammes (27.15 grains) of pulverized blende were digested in aqua regia, which had been previously heated till it began to give out fumes of chlorine gas. When all action was at an end, the undissolved portion was separated by the filter, washed and dried. It weighed 0.393. Being exposed to a red heat a good deal of sulphur was driven off, but a portion of undecomposed blende remained, which, being again heated with aqua regia, was completely dissolved.

The solution thus obtained was diluted with water, raised to the boiling temperature, and mixed with an excess of carbonate of potash. The heat being continued till all excess of carbonic acid was driven off, the precipitated carbonate of zinc was collected on the filter. After being washed, dried, and ignited, it weighed 0.146. It was oxide of zinc, equivalent, according to BERZELIUS's formulas, which ARFWEDSON follows, to 0.117 parts of metallic zinc. From this ARFWEDSON concludes, that the 0.393 parts of residue were composed of

Zinc,	0.117
Sulphur,	0.276
	<hr style="width: 50px; margin: 0 auto;"/>
	0.393

The sulphuric acid in the original aqua regia solution was precipitated by muriate of barytes. The ignited sulphate of barytes obtained weighed 2.288, equivalent, by BERZELIUS's formula, to 0.786 sulphuric acid, or 0.316 sulphur.

The liquid thus freed from sulphuric acid was raised to the boiling temperature, and precipitated by carbonate of potash, the heat being continued till all excess of carbonic acid was driven off; the oxide of zinc obtained, weighed after ignition

1.311, and was pure, with the exception of a trace of iron. 1.311 oxide of zinc, according to BERZELIUS's tables, are equivalent to 1.05 metallic zinc. Thus, by ARFWEDSON's analysis, 1.758 blende are composed of

Zinc,	1.167	or	66.382
Sulphur, . . .	0.592		33.675
	1.759		100.057

When we correct ARFWEDSON's analysis by my formulæ, which I consider as more accurate than those of BERZELIUS, the result is as follows :

Zinc,	1.17947	or	67.091
Sulphur, . . .	0.58523		33.290
	1.76479		100.381

Now, this is equivalent to

Zinc,	4.25
Sulphur,	2.1087

4.25 is the atomic weight of zinc. But 2.1087 exceeds 2 (= atom of sulphur) by rather more than $\frac{1}{10}$ th of an atom. Consequently, if ARFWEDSON's analysis be correct, blende is not a simple combination of an atom of zinc and an atom of sulphur, but contains an excess of this last substance.

There are two circumstances connected with ARFWEDSON's analysis that prevent me from trusting implicitly in its accuracy.

1. The 0.393 of matter which did not dissolve in aqua regia, must have been dried at a very low heat, because sulphur begins to sublime at a temperature considerably under that of boiling

water. But at so low a temperature it is not probable that the powder would be deprived completely of water. Yet ARFWEDSON estimated the weight of the sulphur, by subtracting the weight of the zinc obtained from the original weight of the powder. The remainder he considered as sulphur. Now, certainly, this remainder was not all sulphur; a portion of it must have been water; therefore the quantity of sulphur which ARFWEDSON gives is greater than what was actually present in the blende.

2. From a very great number of experiments which I have made on the various modes of obtaining zinc from its acid solutions, I am satisfied that, by the method employed by ARFWEDSON, the whole of that metal cannot be obtained. It is plain, then, that the blende analyzed by him contained more zinc and less sulphur than he gives. Had the proportions been

Zinc,	68
Sulphur,	32
	100

the blende would be a compound of 1 atom zinc and 1 atom sulphur.

That I might acquire some additional information on the subject, I requested Mr THOMAS MUIR*, of whose uncommon accuracy as an experimenter I had had ample proof, to analyze a specimen of crystallized blende with which I furnished him. The crystals had the diamond lustre, were blackish, and almost

* The premature death of this excellent young man, since this paper was written, is an event very much to be deplored. He had wrought as a practical chemist for several years in my laboratory; and, to much practical knowledge, had added so much neatness and dexterity, joined to uncommon industry, that he would certainly have speedily distinguished himself as a chemist.

opaque. But the powder was light brown. The specific gravity was 4.076. The blende, previously reduced to powder, was digested in aqua regia till a complete solution was obtained. The sulphuric acid was thrown down by muriate of barytes; the peroxide of iron, by benzoate of ammonia; and the oxide of zinc, by adding an excess of carbonate of soda, and evaporating the mixture to dryness. The residual matter was digested in water, and the carbonate of zinc was collected on the filter. The result of the analysis was as follows:

Zinc,	65.280
Iron,	0.748
Sulphur,	33.364
	<hr style="width: 100px; margin: 0 auto;"/>
	99.392

65.28	zinc requires	30.837	sulphur,
0.748	iron requires	0.854,	to form bisulphuret.
		<hr style="width: 100px; margin: 0 auto;"/>	
		31.691	

Thus, there is an excess of sulphur in the blende analyzed by Mr T. MUIR amounting to 1.673 per cent. But there is a loss in Mr MUIR'S analysis, amounting to .608 per cent., and this loss was undoubtedly zinc. If we add it, the quantity of zinc in the blende will be 65.888, which will require 31.123 sulphur. This would reduce the excess of sulphur to 1.387 per cent. This is less than in ARFWEDSON'S analysis, in which the excess of sulphur amounts to 1.986 per cent.

Mr MUIR'S analysis serving to confirm the accuracy of ARFWEDSON'S, I was naturally led to consider it as established that blende contains an excess of sulphur, amounting to about $1\frac{1}{3}$ per cent. Now, such an excess can only exist on the supposition that zinc is capable of combining with sulphur in various proportions. For example, if we were to consider blende as a com-

pound of 24 atoms sulphuret of zinc and 1 atom bisulphuret of zinc, its constitution would agree very nearly with the analysis of Mr T. MUIR. For

24 atoms zinc	=	102
* 1 atom zinc	=	4.25
		106.25
Total zinc -		
24 atoms sulphur,	. . .	48
2 atoms sulphur,	. . .	4
		52

Now,

Zinc,	. . .	106.25	is the same as	67.15
Sulphur,	. . .	52.	32.85
		158.25		100.00

Such a composition would be analogous to what STROMEYER has shewn to be the constitution of magnetic pyrites, which always contains an admixture of bisulphuret of iron. It was with a view to ascertain how far zinc and sulphur are capable of entering into various combinations, that the following experiments were made.

I mixed as intimately as possible 21 grains of pure oxide of zinc with 20 grains of flowers of sulphur. This mixture was put into a porcelain crucible, which, being covered with its lid, was exposed over a spirit-lamp, to a heat at first very moderate, but gradually increased till the crucible became red hot, and it was kept at that temperature till the whole excess of sulphur had been driven off. It was then allowed to cool. The matter remaining in the crucible was a white pulverulent powder, having

a slight tinge of yellow. It was tasteless and insoluble in water, and, when examined before the blowpipe, exhibited precisely the characters of blende. When digested in muriatic acid, it dissolved with effervescence, giving out abundance of sulphuretted hydrogen gas, and leaving a very small quantity of undissolved sulphur. Blende, when dissolved in muriatic acid, gave out the same gas, and likewise left a very small quantity of sulphur undissolved. The weight of the sulphuret of zinc which I had thus formed, was exactly 25 grains.

Now, 21 grains of oxide of zinc are composed of,

Zinc,	17
Oxygen,	4
	21

17 zinc are equivalent to 4 atoms, and 4 atoms sulphur weigh 8. Thus it appears that the sulphuret of zinc formed artificially was composed of

Zinc,	17	or	4.25
Sulphur,	8		2
	25		6.25

This experiment corresponds exactly with those which I had previously made to determine the atomic weight of zinc and of sulphur, and serves to confirm them, if any confirmation had been wanting.

The very same sulphuret of zinc is obtained when oxide of zinc and flowers of sulphur are heated together in a green glass retort.

I made many attempts to form a super-sulphuret of zinc, by heating sulphur and oxide of zinc in various proportions, and at

various temperatures, but all these attempts were quite unsuccessful. I always got a simple sulphuret of zinc, and nothing else, in what way soever the process was varied. When anhydrous sulphate of zinc is decomposed by hydrogen gas, in a glass tube, a portion of the sulphur is driven off, and there remains a mixture of oxide of zinc and sulphuret of zinc, as was first ascertained by ARFWEDSON*. If we substitute the acid sulphate of zinc, which I have described elsewhere †, the result is the same.

My attempts to form a super-sulphuret of zinc, by means of sulphuretted hydrogen, were equally unsuccessful. But it may be worth while to state one or two of the experiments somewhat in detail, on account of the facts which they furnish.

21 grains of pure anhydrous oxide of zinc were dissolved in acetic acid, and a current of sulphuretted hydrogen gas was passed through the solution (which was nearly neutral), as long as any precipitate fell. The precipitate was white and flocky. Being collected on a filter, washed (a tedious process), and dried, it weighed 26.09 grains. The liquid from which this matter had fallen, being evaporated to dryness, left 3.15 grains of a matter quite similar to the precipitate. Thus the whole substance obtained, when a solution of 21 grains of oxide of zinc is treated with sulphuretted hydrogen, amounted to 29.24 grains.

This matter, when dry, assumed a dark green colour. It was tasteless and insoluble in water, but dissolved in acid, with the evolution of much sulphuretted hydrogen gas. When heated to redness it emitted a white smoke, smelling strongly of sulphur, and assumed a yellow colour; but, on cooling, it changed to white. The weight was now reduced to 23.86 grains. It dissolved in muriatic acid without effervescence,

* KONGL. Vetens. Acad. Handl. 1822, p. 346.

† First Principles of Chemistry, i. 55.

though it gave out, at the same time, a perceptible smell of sulphuretted hydrogen; and paper, moistened with acetate of lead, held over it, became brown. Muriate of barytes being dropt into the solution, 2.089 grains of sulphate of barytes were obtained, equivalent to 0.706 grain of sulphuric acid.

The green substance thus obtained was obviously an anhydrous hydro-sulphuret of zinc, composed of 1 atom oxide of zinc, and 1 atom sulphuretted hydrogen. For 21 grains of oxide of zinc being equivalent to 4 atoms, would require 4 atoms of sulphuretted hydrogen, amounting to 8.5 grains; for the atom of sulphuretted hydrogen is 2.125. Thus, we have,

4 atoms oxide of zinc,	21
9 atoms sulphuretted hydrogen,	8.5
	<hr style="width: 10%; margin-left: auto; margin-right: 0;"/>
Total,	29.5

Now, the quantity which I obtained was 29.24; and I find by the notes of the experiment, that a few flocks of the hydro-sulphuret were accidentally lost. Hence, if the whole had been collected, it would have amounted very nearly to 29.5 grains.

This hydro-sulphuret, when heated, gives out almost the whole of its sulphuretted hydrogen, while blende may be ignited in close vessels with very little change. A small portion of the sulphur was acidified by the heat, and a little of the hydro-sulphuret was probably converted into sulphuret of zinc.

The white flocks precipitated by the sulphuretted hydrogen, constituted a hydrated hydro-sulphuret of zinc.

Sulphuretted hydrogen gas does not form a sulphuret of zinc at all, unless it be passed through hot oxide of zinc in a tube; and, in that case, nothing is obtained but common sulphuret of zinc.

Being thus foiled in all my attempts to form a super-sulphu-

ret of zinc, it became necessary to examine the composition of blende again with as much attention to accuracy as possible, in order to ascertain whether the supposed excess of sulphur really exists in it.

An analysis of the crystals of blende, obtained from the specimen which Mr T. MUIR had examined, gave me the following result :

Zinc,	65.7
Iron,	0.740
Sulphur,	32.628
		99.076

The amount of iron was exactly the same as Mr MUIR had obtained ; but the quantity of zinc was 0.42 grains more, while the sulphur was 0.736 grains less than in his analysis. My loss amounted to 0.924 per cent., and was undoubtedly zinc ; for I was at so much pains to obtain all the sulphur, that none of it could well be lost. The real quantity of zinc, then, in 100 grains of the blende, was,

66.629 gr., requiring	. . .	31.352 sulphur
0.748 gr., iron requiring		0.354 sulphur
		Total, . . . 32.206

The quantity of sulphur which I actually obtained exceeds this quantity by only 0.422. Here the excess is less than one-third of that in Mr MUIR's analysis.

I analyzed another specimen of brown blende, having the diamond lustre, and a specific gravity of 3.9779. The constituents obtained were,

Zinc,	65.5
Iron,	1.372
Sulphur,	32.628
	99.500

If we allow the loss to be zinc, we have

66 zinc, requiring . . .	31.0588 sulphur
1.372 iron, requiring . . .	1.5394 sulphur
Total,	32.5982

This exceeds the quantity of sulphur actually found by no more than 0.03 grain, or less than $\frac{1}{10000}$ th of the whole.

Another variety of blende was subjected to analysis. It was opaque, splendent, dark coloured, crystallized, and had a specific gravity of 4.2434. Its constituents were found to be,

Zinc,	64.33
Lead,	5.215
Iron,	1.33
Sulphur,	32.915
	103.79

64.33 zinc require of sulphur, . . .	30.27
5.215 lead,	0.80
1.33 iron,	1.52
Total,	32.59

The quantity of sulphur actually found exceeded this by 0.32 grains.

I analyzed two other specimens of blende ; but the results accord so nearly with those already given, that it seems super-

fluous to state them. The sulphur rather exceeded the theoretical quantity ; but the excess was exceedingly small.

These analyses seem to me to leave no doubt, that the zinc in blende is combined with 1 atom of sulphur only. Blende is a simple sulphuret of zinc, but never entirely free from an admixture of bisulphuret of iron ; but the proportion of this last substance is so small and so variable, that it cannot be considered as a chemical constituent of blende, but rather as a mechanical mixture. In the second of my analyses the blende contains the greatest proportion of iron-pyrites of any of the varieties which I subjected to analysis. It consists of about

52 atoms sulphuret of zinc,
1 atom bisulphuret of iron.

While, in the first variety analyzed, the constituents are nearly

74 atoms sulphuret of zinc,
1 atom bisulphuret of iron.

These variations are inconsistent with chemical combination.

XXI. *Notice regarding a Time-Keeper in the Hall of the Royal Society of Edinburgh.* By JOHN ROBISON, Esq. Sec. R. S. Ed.

(*Read 7th February 1831.*)

THERE being some peculiarities in the construction of the Clock lately set up in this room, which may prove to have considerable influence on the performance of such instruments, and also on their cost and duration, it is presumed that a short notice of them, together with a few preliminary observations, may not be deemed uninteresting to the Society.

An eminent philosopher, in a work recently published, has defined a clock to be “nothing more than a piece of mechanism, for counting the oscillations of a pendulum.” This definition cannot be considered as complete, as besides having to register the oscillations of its pendulum, a clock has to communicate successive impulses to it, to enable it to overcome the friction of its suspension, and the resistance of the air. If a maintaining power were not exerted by the clock, the pendulum would soon be brought to a state of rest.

There are therefore two principal points which require to be attended to in the construction of a good time-keeper. One, that the pendulum shall perform all its oscillations in equal times, in spite of the variations of temperature it may be exposed to; and the other, that the clock or mechanism shall communicate unvarying impulses to the pendulum during long periods of time.

Many ingenious contrivances have been fallen on by men of science, and by mechanics, to attain these ends, but some causes of error, which appear to be inseparable from the materials employed, still remained to be removed. As an endeavour has now been made to get rid of these difficulties, by some changes in the mechanism of the clock, and in the material of the pendulum, I shall proceed to explain the peculiarities in their construction.

The principal circumstances in which this time-keeper differs from the usual constructions are these; 1st, In having an escapement which requires no oil; 2d, In having the pendulum and ball formed of a material not hitherto used for this purpose; and 3d, In having the mechanism entirely secured against the effects of dust, and in a great degree against those of hygrometric changes in the atmosphere.

First as to the Escapement.—It is no doubt known to most persons now present, that, in the usual forms of clock-escapements, the teeth of the scape-wheel act alternately on two pallets, or inclined planes, which are placed at the extremities of branches proceeding from an axis, which axis has a third branch or tail, by which it communicates to the pendulum the impulses which it receives from the wheel-work, through the pallets. Thus in Plate XIV., Fig. 1., which is an enlarged drawing of the most commonly used escapement, A is the scape-wheel, which is urged round, in the direction of the arrow, by the maintaining power of the clock; B B are the two pallets; C is the axis from which they proceed; and D is a part of the third branch or tail, by which the successive impulses are communicated to the pendulum.

The chief cause of irregularity in this, and in all other forms of escapements where the teeth of the scape-wheel act on inclined planes, is the oil which is necessarily introduced to diminish the friction of the rubbing surfaces. In good clocks this

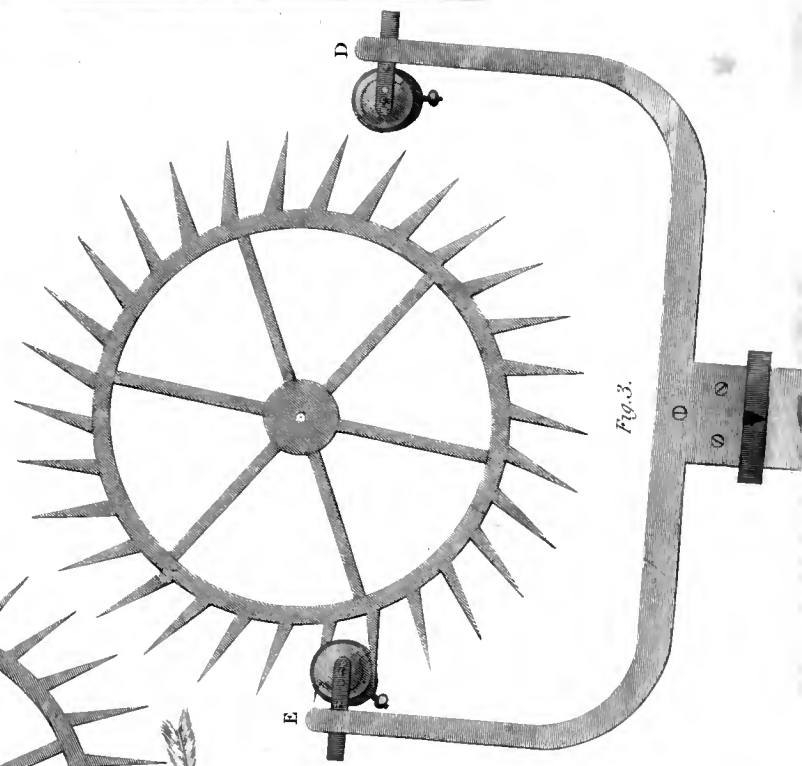
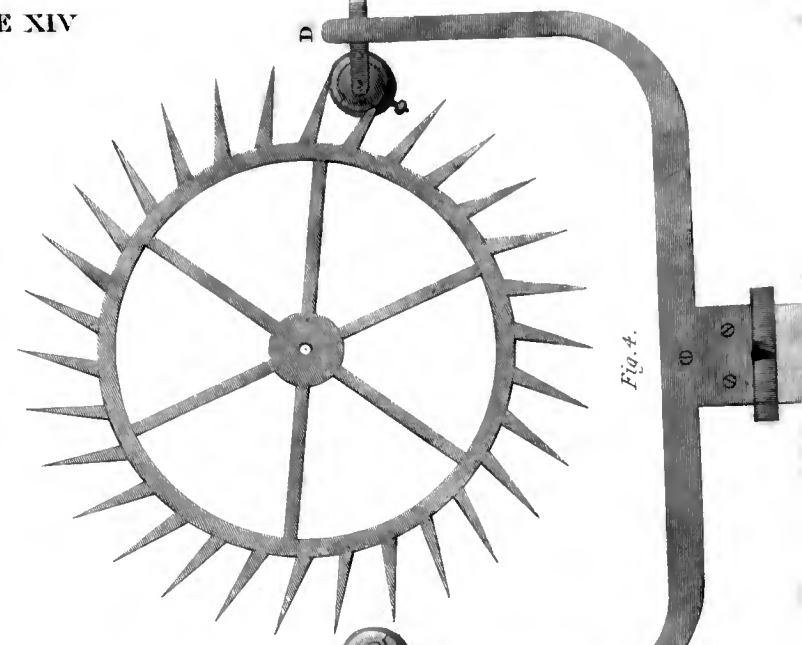
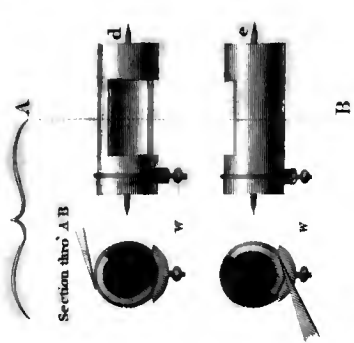
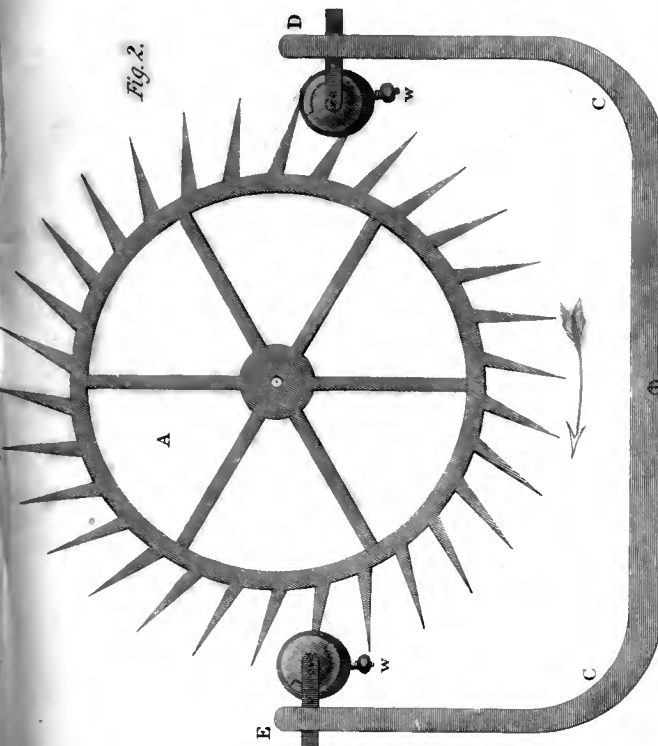
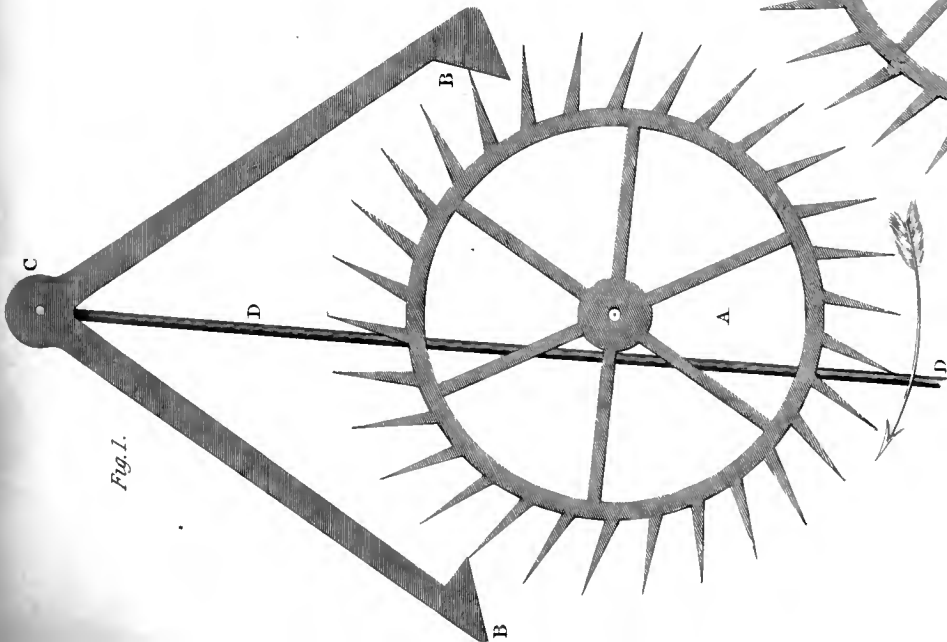



friction is reduced as much as possible, by forming the scape-wheel of steel, and the pallets of jewels; but oil is still necessary, and however pure, it must be liable both to chemical change, and to a gradual admixture with dust; its effect therefore on the rubbing parts must vary, and the impulse given to the pendulum must vary with it.

The escapement, which I shall now proceed to describe, is the invention of Mr WHITELAW, a very ingenious artist in this city, who has been employed to make the clock. His escapement possesses the advantage of not requiring oil in any part of its mechanism, and therefore is free from one great cause of irregularity.

In the drawings, at Figs. 2. 3. and 4., A is a scape-wheel, which need not vary much from the usual form; it acts alternately on the pallets D and E. These pallets are not attached to an intermediate axis, as in the former case, but are fixed to the pendulum itself (by which arrangement some sources of irregularity are suppressed). C C are the branches which carry the pallets; and B is the knife-edge on which the pendulum oscillates.

The pallets D and E, instead of being inclined planes along which the teeth of the scape-wheel would be required to slide while giving impulse to the pendulum, are portions of the surfaces of cylinders which revolve (or rather oscillate) on delicate pivots in ruby holes. When a tooth of the scape-wheel drops on one of these cylinders during the motion of the pendulum, the cylinder is turned partly round by the continued action of the tooth, until the pendulum has swung so far that the tooth escapes past the cylinder, having descended through a space equal to half of its diameter: at the moment of its escape, a tooth on the opposite side of the wheel is arrested by the other pallet, and a similar escape takes place with that tooth on the returning swing of the pendulum.

Here, it will be obvious, there can be no friction between the teeth and the pallets, and that oil would be superfluous. The rubbing has been transferred from the surfaces of the pallets to their centres, where, from the slowness of the motion and the smallness of the space moved through, there can be no appreciable resistance between the pivots and their ruby holes, and therefore no oil can be required.

It will be observed, on inspection of the drawing, that the diameter of the pallets is nearly as great as the distance between the teeth of the wheel; the teeth, however, advance only half of that space at each vibration, and if the pallets were solid cylinders, the returning motion of the pendulum would be opposed by their striking against the teeth on the entering side. In order to prevent this, a portion of the cylinder is cut away in the middle part, leaving only enough of surface for the teeth to act on during their descent of half the diameter. A third part of the circumference is sufficient for this action, and any thing less than a half will leave a free passage for the disengaged tooth. In Fig. 2, at *d e*, the pallets are drawn as detached from their frames, and as if half of the circumference were cut away from the middle part. In Fig. 3. and 4. the pallets are shewn in section in their proper positions: in these figures, *w* is a small counterpoise, to bring back the pallet to its position for receiving the next succeeding tooth, after it has been turned aside by the escaping one.

To persons who have paid attention to the subject of Horology, I need not point out the great value of this improvement, nor the benefits which may arise from it in those departments of science where an exact measure of time is a desideratum*.

* The maintaining power in this clock is a weight of 4 lb. 4 oz., descending through about 40 inches in 7 days; the weight of the pendulum and ball $12\frac{1}{2}$ lb., and of vibration 4.4 inches.

I may mention here, that in Fig. 2. the pendulum is supposed to be in the middle of an oscillation, with a tooth of the scape-wheel pressing on the pallet D. In Fig. 3. the oscillation has been completed to the left; the pallet D has allowed the tooth to escape past it, and a tooth of the opposite side of the wheel has been arrested by the pallet E.

In Fig. 4. the pendulum has swung to the right; the tooth which rested on E has in its turn escaped, and another, on the opposite side of the wheel, has dropped on D.

The next peculiarity in this clock which merits attention, is the material of which the pendulum rod and ball have been made. Marble has been adopted for this purpose, in consequence of a suggestion made to me by Dr BREWSTER, and since repeated by him in the *Philosophical Transactions* for 1830, page 94, where, in speaking of Mr MITSCHERLICH, he says, "This eminent philosopher has found, by direct experiment, that heat expands a romb of calcareous spar in the direction of its axis, and contracts it in directions at right angles to that axis." Dr BREWSTER adds, in a note: "It follows from this fact, that massive carbonate of lime, in which the axes of the molecules have every possible direction, should neither contract nor expand by heat, and would therefore form an invariable pendulum*."

In constructing this pendulum, care has been taken to exclude every thing which could interfere with its principle, and the whole of the pendulous portion, from the point of suspension downward, is continuously of marble, without the intervention of metal, and even the convenience of an adjusting screw at the bottom has been sacrificed to insure this. A method of

* Some experiments made since this paper has been read, seem to shew, that a rod of Carrara marble, on being measured at 32° and at 211° Fahrenheit, will be found to have expanded $\frac{7}{30000}$. A rod of Lucullite marble, $\frac{3}{30000}$.

adjustment has been substituted, which has the advantage of being applied without stopping the vibrations.

If experience shall confirm the accuracy of Mr MITSCHERLICH'S experiment, and verify Dr BREWSTER'S inference from it, an important advantage will have been gained by this application, as a pendulum invariable in its own nature, must have a great superiority over a compensation one, which, however well adjusted to isochronism under differences of temperature, when all its parts are affected simultaneously, must always be liable to derangement from partial currents and changes. The small expense at which such a pendulum can be procured, would, in that case, lead to making good time-keepers come into more general use.

The last peculiarity which I shall notice is of less importance than those above mentioned, but, nevertheless, merits some remark, as it tends to obviate another cause of irregular action in the mechanism of time-keepers, viz. the gradual accumulation of dust in the interior of the case. In order to understand the utility of the contrivance which has been resorted to, to prevent this, it is necessary to explain the way in which the accumulation of dust takes place. If a clock-case be closed up when the air of the apartment is of a medium temperature, air will be drawn into the case through the readiest apertures, as soon as a diminished temperature causes a contraction of bulk in the included air. The air which enters will carry with it a portion of the dust which is always floating (as we see distinctly when a sunbeam shines through a small aperture into a darkened room). This dust is soon deposited, from the comparative stillness of the air within the case, and when, by increase of temperature, air is pressed out of the case, it leaves the dust behind it; by which means a small addition is made to the quantity of dust in the case every time a contraction takes place, and thus, in process of time, the action of the mechanism is impeded by

the accumulated deposit. To prevent this process taking place here, the case has been made carefully air-tight against moderate pressure, excepting in one place, where a short tube is fixed in an opening from which it projects externally about two inches. On this projection a half distended air-bag is made fast*. It follows from this arrangement, that when a contraction takes place within the case, the pressure of the external air will compress the bag, and make a portion of its contents enter the case to make up for it; and when, on the contrary, an expansion takes place, the expressed air will enter the bag and distend it; in this way, if the capacity of the bag be great enough, no foreign air (if it may be so termed) can enter the case, but the equilibrium will be kept up by a circulation of the same air between the bag and the case, like the mercury in the basin and tube of a barometer, and no dust can ever be added to the quantity originally shut up with the clock. It is evident that this must conduce essentially both to regular performance and to the durability of the clock, and as the application of the contrivance occasions little expense or inconvenience, there is no reason why it should be omitted in any observatory clock-case.

* The air-bag is concealed within the pediment of the top of the clock-case.

XXII *On Asbestos, Chlorite, and Talc.* By THOMAS THOMSON,
M. D., F.R.SS.L. & E. &c., Regius Professor of Chemistry in
the University of Glasgow.

(Read 16th February 1829.)

NOTWITHSTANDING the great progress which Mineralogy has made of late years, towards the division of minerals into accurate and well defined species, there are several groups which occur in the oldest mineral systems extant, and which have continued to the present time with very little alteration or improvement. I allude to the minerals classed under the names of Asbestos, Chlorite, and Talc. As these minerals, with the exception of certain varieties of talc, have never been observed in crystals, the important labours of the crystallographer have not been able to throw any light upon them. But, as all mineral species are chemical compounds, and as each species consists of the same constituents united in the same proportions, I thought it not unlikely that an accurate chemical analysis of the different varieties of minerals, at present classed under the names Asbestos, Chlorite, and Talc, would be likely to throw considerable light on their nature, and would inform us whether they constitute peculiar mineral species, or are only varieties of species already well defined and characterized. I propose, in this paper, to give an account of the result of this investigation.

I. ASBESTUS.

Asbestos was known to the ancients. PLINY gives a pretty long account of it. He says, that a "kind of linen is found, which is not consumed by the fire. It is called Vivum, and we see table-cloths of it heated red hot in the fires of convivial parties, and the stains being thus burnt off, they look much cleaner than they could have been made by means of water. Such pieces of cloth are employed to wrap up the bodies of kings, before they are placed on the funeral pile, and thus separate the ashes of the dead body from those of the fuel. This flax is produced in the deserts of India burnt up by the sun, where no rain falls, amidst direful serpents. It becomes accustomed to live by burning. It is rarely found, and is difficult to weave on account of the shortness of the threads*." PLINY mentions the amianthus among stones, says it resembles alum, and that it loses nothing in the fire†. AGRICOLA, in his fifth book, *De Natura Fossilium*, gives a long account of it, chiefly taken from the ancients; but he informs us, that it existed in his time in great abundance in the mines of Noricum, and that it could therefore be obtained at a very cheap rate.

KONIG, in his *Regnum Minerale*, published in 1687, gives a description of amianthus, and says, that it is rendered fit for being spun into thread, by being boiled for a quarter of an hour in an alkaline ley‡. In the first edition of LINNÆUS's *Systema Natura*, published in 1736, amianthus, asbestos, talcum, and mica, constitute the four subdivisions of the order *Apyræ*. CRONSTEDT, in his *Mineralogy*, first published in 1758, introduced the same minerals under the division *Terræ Asbestinæ*. BERGMAN

* Lib. xix. cap. 1.

† Lib. xxvi. cap. 19.

‡ P. 120.

subjected a good many varieties of asbestos to a chemical analysis, shewed that they were not composed of a particular earth, but that they all contained magnesia, and therefore arranged them under *Magnesian Earth**. This arrangement was followed by WERNER, and has in consequence passed into almost all the modern systems of mineralogy.

There are usually reckoned five varieties or subspecies of Asbestos; namely, Amianthus, Common Asbestos, Rock-wood, Mountain Leather, and Mountain Cork.

1. *Amianthus.*

As a specimen of amianthus, I chose a variety from Sardinia, very like the well known Corsican amianthus, which is sufficiently pure, and so abundant, that DOLOMIEU made use of it for packing his minerals. It is composed of very fine threads of considerable length, and easily teased from each other. Its lustre is silky, it has a greenish-white colour, is very soft, and has a specific gravity of 1.551. Its constituents, analyzed in the usual way for treating magnesian minerals, were found to be as follows:

Silica,	55.908	or	35	atoms,
Magnesia,	27.068	.	13½	atoms,
Lime,	14.632	.	5	atoms,
Protoxide of iron,	6.528	.	2	atoms,
Alumina,	1.820	.	1	atom.
	<hr style="width: 10%; margin: 0 auto;"/>			
	105.956			

We see from this analysis, that amianthus contains four

* Opus. iv. 160.

bases, all of which are in combination with silica. The atoms of silica being 35, and those of the bases only $21\frac{1}{2}$, it is clear that some of the bases must be in the state of simple silicates, and others in that of bisilicates. If the magnesia be a bisilicate, while the lime, protoxide of iron, and alumina, are simple silicates, then all the atoms, both of the silica and bases, will be in combination. So that we might consider amianthus as composed of,

$13\frac{1}{2}$ atoms bisilicate of magnesia,
 5 atoms silicate of lime,
 2 atoms silicate of iron,
 1 atom silicate of alumina.

But, if we compare the constituents of amianthus with the numerous analyses of amphibole given by BONSDORF, in his instructive paper upon the chemical constitution of that complicated mineral species, we cannot avoid seeing a very close resemblance. Now, pure amphibole is composed of $C S^3 + 3 M S^2$. But it would appear from the researches of BONSDORF, that part of the silica is occasionally replaced by alumina, and part of the magnesia by protoxides of iron and manganese. If we admit these substitutions in the present case, we shall have,

36 atoms of silica and alumina,
 15.5 atoms magnesia and protoxide of iron,
 5 atoms lime.

This is equivalent to,

7.2 atoms silica and alumina,
 3 atoms magnesia and protoxide of iron,
 1 atom lime.

The ratio between the lime and magnesia is the same as in amphibole; but there is a deficiency of silica amounting to 1.8 atoms. But I believe that deficiency of silica to be only apparent, and to be owing to the excess of 6 per cent. in the weight of the constituents. Such an excess is very apt to take place in the analysis of magnesian minerals, and is chiefly owing to the formation of certain double magnesian salts, unless great care be taken in precipitating the magnesia. I generally precipitate the magnesia by carbonate of soda, and, after boiling the mixture for some time in a flask, to drive off the excess of carbonic acid, evaporate the whole to dryness in a porcelain dish. The magnesia remains when the residue is washed with water. This magnesia isedulcorated, dried, heated to redness, and weighed. Now, I generally begin my analysis of magnesian minerals, by adding to the muriatic solution (formed after fusing the portion of pounded mineral, subjected to analysis with carbonate of soda, and getting rid of the silica), a quantity of bicarbonate of potash, which throws down the alumina and oxide of iron, but retains in solution the lime and magnesia. This method was first practised by VAUQUELIN, during his analysis of the chrysolite. After numerous comparative trials I adopted it as the most effectual method of freeing the magnesia from alumina, and have accustomed my practical students to employ it in their analyses of magnesian minerals. The only objection to it is, that unless care be taken, a double carbonate of potash and magnesia is apt to be obtained, instead of pure carbonate of magnesia, as was first pointed out by BERZELIUS. If we allow the formation of a little of this double salt in the preceding analysis, then the constituents of amianthus will agree exactly with those of some varieties of amphibole. We may represent it as consisting of,

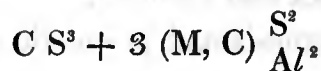

Amianthus, then, appears not to constitute a particular species, but to be merely a variety of amphibole.

2. *Amianthus, from Bleyberg, in Carinthia.*

This variety has a greenish-white colour. Its lustre is somewhat silky, but less so than the preceding variety. It feels soft and unctuous, and consists of fine threads, which are flexible, but too easily broken to be capable of being spun into threads. It is opaque, and its specific gravity is 1.892. Its constituents were found to be,

Silica,	52.512
Magnesia,	19.112
Protoxide of iron,	13.652
Lime,	7.960
Alumina,	4.808
Water,	4.080
	102.124

This is equivalent very nearly to

- 58 atoms silica,
- 17 atoms magnesia,
- $6\frac{1}{2}$ atoms protoxide of iron,
- 5 atoms lime,
- $4\frac{2}{3}$ atoms alumina,
- 8 atoms water.

Now, if we make an allowance for a slight over estimate of the quantity of magnesia, indicated by an excess of $2\frac{1}{8}$ per cent. in the analysis, we shall find that these constituents may be

made to come under the formula for amphibole. We must admit the alumina to replace a portion of silica; and the protoxide of iron partly to replace lime, and partly magnesia: $1\frac{1}{2}$ atoms replacing lime, and 5 atoms magnesia. The formula will be

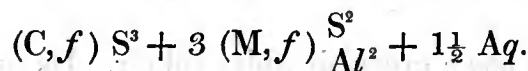

This variety of asbestos, then, like the preceding, is an amphibole. The water is probably only mechanically mixed, and not a chemical constituent of the mineral.

3. *Asbestos, from Irkutzky, in Siberia.*

This specimen had a yellowish-white colour. It was composed of long straight fibres, grouped together so as to give the mineral the appearance of a congeries of imperfect prisms, inclined irregularly to each other.

The fibres were easily separable from each other. They were not elastic, and might be bent somewhat; but were too frangible to admit of being converted into threads. It is this want of flexibility, together with a greater specific gravity, which constitutes the principal distinction between common asbestos and amianthus.

Opaque or nearly so.

Soft enough to be scratched by the nail.

Streak white.

Specific gravity 2.888.

The constituents of this mineral, found by analysis, were as follows:

Silica,	58.804
Magnesia,	28.236
Protoxide of iron,	9.479
Lime,	5.926
	102.445

This is equivalent to

- 34½ atoms silica,
- 13 atoms magnesia,
- 2½ atoms protoxide of iron,
- 2 atoms lime.

If we allow a small surplus of magnesia, indicated by the excess in the analysis, it is evident that the atoms of silica are just double those of the bases, so that the mineral must consist of bisilicates. It would appear at first sight, therefore, to differ essentially from amphibole, which consists of $C S^3 + 3 M S^2$. But the analogy between the constituents and those of amphibole is striking. And, if we were allowed to consider about 1 atom of the protoxide of iron to be accidental, and the rest to replace the lime, we would have

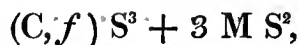

which constitute the constituents of amphibole. I am disposed, therefore, to consider the common asbestos, of which the mineral analyzed was a specimen, as constituting a variety of amphibole; and in this respect agreeing with amianthus.

4. *Asbestous Rock, from the Island of Bernera.*

The colour was light green. The mineral was composed of fibres, having some breadth, and running in general longitudinally, though rather irregularly. When examined by a microscope, it appears to consist of white and green coloured fibres alternating; the lustre of the green fibres being glassy, and that of the white silky. Perhaps these appearances may be owing to different sides of the fibres presenting themselves to the eye.

Scratched by the nail.

Opaque, or nearly so.

Feels rather harsh to the touch.

Streaks white.

Specific gravity 2.984.

On being subjected to analysis, its constituents were found to be as follows :

Silica,	56.430
Magnesia,	23.256
Lime,	13.636
Protoxide of iron,	4.098
Alumina,	0.516
Protoxide of manganese,	0.280
Moisture,	0.250
	<hr/>
	98.466

This is equivalent to

21 $\frac{3}{4}$ atoms silica,
 7.2 atoms magnesia,
 3 atoms lime,
 0.7 atom protoxide of iron,
 0.05 atom protoxide of manganese,
 0.17 atom alumina.

If we take the protoxides of iron and manganese along with the magnesia, it is evident that the atoms of magnesia are almost three times as numerous as those of lime. So far there is an agreement between the composition of the Bernera asbestos and amphibole; but there is a slight deficiency in the silica, even if we add to it the alumina which the mineral contains. For, if we divide the atoms just given by three, we have,

1 atom lime,
 2.65 atoms magnesia, protoxide of iron and manganese,
 7.3 atoms silica and alumina.

But, to judge of the deficiency accurately, we must take a little of the lime, and add it to the magnesia, that the atoms of magnesia may be thrice as many as those of lime. This will give us

1 atom lime,
 3 atoms magnesia, lime, and protoxide of iron and manganese,
 8 atoms silica.

To form tersilicate of lime and bisilicate of magnesia, we would require 9 atoms of silica and alumina; while the mineral contains only 8 atoms. So that, to constitute



there is 1 atom of silica wanting.

In all probability the mineral analyzed was a mixture of amphibole and some other magnesian mineral, containing a smaller proportion of silica.

5. *Rock-Wood.*

The specimen selected for analysis was from the Tyrol. It had much of the aspect of common asbestos. The colour was yellowish-brown; the texture was distinctly fibrous; and the fibres, from their disposition, gave the mineral a good deal of resemblance to wood.

Opaque, soft. Specific gravity, 2.724.

Its constituents were found to be,

Silica,	54.920
Magnesia,	26.084
Protoxide of iron,	12.600
Alumina,	1.640
Water,	5.280
	<hr/>
	100.524

This is equivalent to

- 76 atoms silica,
- 29 atoms magnesia,
- $7\frac{3}{4}$ atoms protoxide of iron,
- 2 atoms alumina,
- 13 atoms water.

The first remarkable circumstance in this mineral is the total absence of lime. Almost all the varieties, both of amphibole and pyroxene, have been analyzed in my laboratory; and we have an ample collection of both analyzed by BONSDORF and ROSE; and not one of either has been met with that did not contain lime as one of its constituents. I think, then, that we are entitled to consider lime as an essential constituent of both of these species. If so, the specimens of rock-wood which I analyzed, can neither be an amphibole nor a pyroxene.

The atoms of the bases added together make 38.75, and the atoms of silica are 76. Now, $38.75 \times 2 = 77.5$. It would appear from this that rock-wood is composed of bisilicates.

Farther, the atoms of magnesia and alumina, taken together, amount to 31, which is just equal to 7.75 (the atoms of protoxide of iron) $\times 4$. Hence the constituents would seem to be

4 atoms bisilicate of magnesia with alumina,
1 atom bisilicate of iron.

The water is $1\frac{1}{3}$ atom; but the $\frac{1}{3}$ atom may be considered as owing to the presence of water mechanically lodged in the interstices of the fibres. According to this view of the constitution of the mineral, it may be represented by the following symbol:

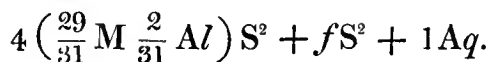

The mineral which resembles rock-wood most closely in its constituents, is hyalosiderite, discovered by Dr WALCHNER, in an amygdaloid in the Kaiserstuhl, near Sasbach, in Brisgau, and which is crystallized in octahedrons with a rectangular base. But hyalosiderite contains less silica, much more protoxide of iron, and rather more magnesia. Its symbol being

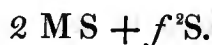

In the present state of our knowledge we cannot avoid considering rock-wood as a distinct species. All my specimens of rock-wood being from the same locality as the one subjected to analysis, no farther light would have been thrown upon the subject, by multiplying analyses.

6. *Mountain-Leather.*

The specimen of this well known mineral, which I selected for examination, was from the lead-mine of Strontian, where it is pretty frequently met with. The colour was light buff. It was composed of exceedingly fine flexible threads, felted together like a hat, and not capable of being separated from each other.

Feel very soft; quite flexible, but tough; imbibes water very readily, and then assumes very much the appearance of wet leather.

Opaque,

Specific gravity 1.334.

Before the blowpipe, curls up and fuses easily into an opaque bead. Fuses with carbonate of soda into a transparent yellow bead. Melts with borax into a colourless transparent glass.

Its constituents were found, by two very careful analyses, to be the following:

Silica,	51.650
Alumina,	9.505
Lime,	10.005
Magnesia,	2.065
Protoxide of iron, with some manganese,	5.805
Water,	21.700
	<hr/>
	100.730

It is obvious at first sight that this mineral is quite distinct from amianthus, asbestos, and rock-wood; for it is almost destitute of magnesia, which in all of them constitutes the most abundant of the bases.

It is not easy to decide whether the water which exists in such abundance in mountain-leather, be chemically combined or not; for it imbibes water as readily as a sponge. It was kept in a dry room, till it ceased to lose any more weight, and in this state was subjected to analysis. When exposed to redness, it altered its appearance very much, and no longer bore its former resemblance to leather. I am disposed, from this, to admit water as a chemical constituent of this mineral.

The constituents of mountain-leather are equivalent to

80 atoms silica,
 13 atoms alumina,
 9 atoms lime,
 2 atoms protoxide of iron,
 1½ atom magnesia,
 60 atoms water.

The four bases taken together amount to 25½ atoms, while the silica amounts to 80 atoms; therefore the alumina and lime must be combined each with three atoms of silica, while the protoxide of iron and magnesia must be in the state of quatersilicates.

Farther, the atoms of quatersilicates being 3½, while those of tersilicates are 21, it is obvious that there exist in the mineral 6 times as many atoms of tersilicates as of quatersilicates. For $3.5 \times 6 = 21$.

The ratio of 1½ to 2 is the same as that of 3 to 4; and that of 9 to 13 approaches very nearly to the same. Hence the

constitution of mountain-leather may be represented by the following symbol :

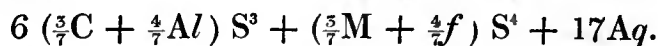

It is obvious that it constitutes a distinct mineral species.

7. *Mountain-Cork.*

The specimen of this mineral, selected for analysis, was from Piedmont ; but I do not know the exact locality.

Its colour was light buff: it was composed of fibres so fine as to be scarcely visible before a common magnifying glass.

It was soft enough to be indented by the nail : it had the same elastic feel which characterizes common cork.

Lustre silky ; nearly dull ; opaque ; very tough. Specific gravity 2.442.

Before the blowpipe fuses into a black glass. When heated to redness it loses 1.2 per cent. of its weight, which is pure water, and assumes a dark brown colour.

Its constituents, after ignition, were found to be as follows :

Silica,	51.75
Lime,	14.05
Magnesia,	10.85
Protoxide of iron,	18.90
Alumina,	1.95
Protoxide of manganese,	1.85
	<hr/>
	99.35

This is equivalent to

- 30 atoms silica,
- 4.5 atoms lime,
- 5 atoms magnesia,
- 4.5 atoms protoxide of iron,
- 1 atom alumina.

The atoms of the bases amount to 15, and those of silica to 30. Hence it is obvious that the mineral is composed of bisilicates. If we admit a little of the lime and of the protoxide of iron to be replaced by alumina, then rock-cork will be a compound of

- 1 atom bisilicate of lime,
- 1 atom bisilicate of magnesia,
- 1 atom bisilicate of iron.

Its symbol will be $CS^2 + MS^2 + fS^2$.

It is therefore most probably a variety of pyroxene.

If any confidence can be placed in the preceding discussion, it follows that the minerals hitherto arranged as subspecies of asbestos, constitute in reality four distinct species.

1. Amianthus and common asbestos are varieties of amphibole.

2. Rock-wood is $4 \left(\frac{29}{39}M + \frac{2}{31}Al \right) S^2 + fS^2 + 1Aq$.

3. Mountain-leather $6 \left(\frac{3}{7}C + \frac{4}{7}Al \right) S^3 + \left(\frac{3}{7}M + \frac{4}{7}f \right) S^4 + 17Aq$.

4. Mountain-cork is a variety of pyroxene.

8. *Nemalite* of NUTALL.

For the specimen of this mineral which I subjected to analysis, I am indebted to the kindness of Professor NUTALL. It occurs in veins in the serpentine rocks of Hoboken, New Jersey, and had always been taken for a variety of amianthus, till its real nature was determined by Mr NUTALL*.

Its colour is white, with a slight shade of yellow, or sometimes of blue. It is composed of long straight fibres, easily separable, and bearing a close resemblance to asbestos.

Soft enough to be scratched by the nail of the finger.

Specific gravity 2.353.

Opaque, or only slightly translucent.

When exposed to a red heat it assumes a brown colour, retains its fibrous texture, but becomes friable, and easily reducible to powder. By this treatment it loses 29.66 per cent. of its weight. The matter driven off is pure water.

It dissolves in nitric acid, without effervescence, leaving behind a little silica.

By a careful analysis I found its constituents as follows :

Magnesia,	51.721
Silica,	12.568
Peroxide of iron,	5.874
Water,	29.666
	<hr/>
	99.829

This is equivalent to

104 atoms water,
25 atoms silica,
4 atoms peroxide of iron,
83 atoms magnesia.

* See SILLIMAN's Journal, iv. 19.

The water, silica, and peroxide of iron, are probably all combined with the magnesia, constituting in all probability

5 atoms silicate of magnesia,
11 atoms bihydrate of magnesia,
1 atom ferrate of magnesia.

Were we to consider the peroxide of iron as replacing a portion of silica, the constitution of nemalite would be

1 atom silicate of magnesia,
2 atoms bihydrate of magnesia; and its symbol would be

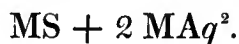

Nemalite, therefore, constitutes a new species of magnesian minerals, which may be distinguished by the name of *hydro-silicate of magnesia*.

The marmolite of NUTALL, found in the same place with his nemalite, would seem, from the analysis of NUTALL, to be a hydrous silicate of magnesia, composed of $MS + 1Aq$. But I find, by a careful analysis of some specimens of it, for which I am indebted to the kindness of Professor NUTALL, that its composition is exactly the same with the picrolite of HAUSSMAN, or the precious serpentine of other mineralogists. Precious serpentine is composed of

$1\frac{1}{2}$ atom silica,
1 atom magnesia,
1 atom water;

Or it is a hydrous sesquisilicate of magnesia.

II. CHLORITE.

THE name *Chlorite* was first introduced into mineralogy by WERNER, and applied by him to a mineral, which preceding mineralogists had confounded with mica, and which HAUY afterwards considered as a variety of talc.

I employed, as a specimen of chlorite for analysis, a very pure piece of common chlorite from the Isle of Bute.

Its colour was very dark green. It was composed of very small scales, attached to each other without any visible cement. These scales were so small, that I could not distinguish their shape by means of a common magnifying-glass. Streak light-green.

Opaque. Soft enough to be scratched by the nail.

Lustre silky, approaching to resinous.

Sectile. Easily frangible.

Specific gravity 2.823.

Its constituents were found to be as follows :

Silica,	27.624
Protoxide of iron, . .	27.544
Alumina,	23.708
Magnesia,	10.960
Water,	9.160
	<hr/>
	98.996

This is equivalent to

16 atoms silica,
 7 atoms protoxide of iron,
 12 atoms alumina,
 5 atoms magnesia,
 9 atoms water.

It is obvious at once that chlorite differs essentially in its chemical constitution from all the varieties of asbestos. For the atoms of silica are to the atoms of the bases, with which it must be united in the mineral, as 2 to 3.

Chlorite is a compound of three subsesquisilicates, and, if we suppose the subsesquisilicates of iron and magnesia to be previously in combination with each other, before they united to the subsesquisilicates of alumina, the symbol for chlorite will be as follows :

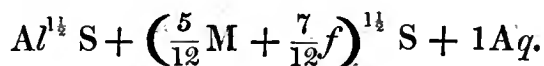

Common chlorite, then, appears to constitute a peculiar mineral species.

2. *Chlorite Earth.*

The specimen of chlorite earth, which I selected for analysis, was given me many years ago by the Rev. Mr HEADRICK of Dunnichen. He had picked it up somewhere in the Highlands of Scotland, but I am not sure of the locality. It consisted of small brown-coloured loose scales, having a silky lustre and a soft feel. The specific gravity was 2.801. The constituents, after a very careful analysis, which was twice made, were found to be as follows :

Silica,	48.166
Alumina,	16.851
Peroxide of iron,	19.100
Potash,	6.558
Magnesia,	2.916
Lime,	2.675
Water,	2.350
	<hr/>
	98.616

A little lead was found in the scales, which was obviously a foreign substance. It was separated with much care; though it is not impossible that it may have affected the weight of some of the constituents a little. From the care taken to separate the lead, and from the repetition of the analysis, I believe that the error resulting from it, if any, must be very trifling.

It is obvious at first sight, that the constitution of this mineral is quite different from that of chlorite. I believe it to be a variety of *rhomboidal mica*. From the analysis of mica by KLA-PROTH and ROSE, there cannot be a doubt, that at least three different species of mineral are at present confounded together under the name of mica. One of the most common of these species crystallizes in oblique rhomboidal prisms, with the following angles :

P on M' 98° 40',
 P on M 81° 20',
 M' on M 60°.

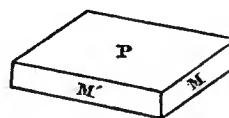

I analyzed a very pure crystallized mica of this kind from the United States, and found its composition as follows :

Silica,	49.380
Alumina,	23.668
Protoxide of iron,	7.312
Lime,	6.134
Potash,	15.292
Lithia,	0.060
	101.846

This is equivalent to

30 atoms silica,
 13 atoms alumina,
 2 atoms protoxide of iron,
 2 atoms lime,
 3 atoms potash.

It is obvious that the atoms of silica are to those of the bases as 3 to 2. Hence all the bases must be in the state of sesquisilicates.

From the analyses of KLAPROTH and ROSE, it appears, that as the protoxide of iron in mica increases the alumina diminishes. If we take the atoms of alumina and protoxide of iron together, as also those of potash and lime, they are to each other as 3 to 1. We may therefore consider the constitution of rhomboidal mica to be

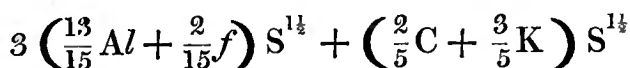

The atomic constituents of the chlorite earth are obviously,

24 atoms silica,
 7½ atoms alumina,
 4 atoms peroxide of iron,
 1 atom potash,
 1 atom magnesia.
 1 atom lime.

Now, these proportions of silica and bases approach those of sesquisilicates. The mineral approaches,

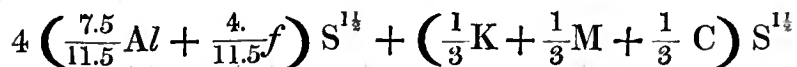

It belongs, therefore, to rhomboidal mica. Whether this be the constitution of all the varieties of chlorite earth I do not know.

III. TALC.

The terms *Talc* and *Mica* seem originally to have been applied indifferently to the same minerals; namely those which could be split into thin layers or plates. When the plates were large, the mineral was called *Talc*, when they were small it was called *Mica*. Common talc, or Venetian talc as it is called, seems first to have been constituted a peculiar species by WERNER. CRONSTEDT has considered it as a variety of mica. HAÜY, in the first edition of his *Traité de Mineralogie*, published in 1801, arranged under talc several other minerals that are probably distinct species; namely, Chlorite, Agalmatolite, Steatite, &c.

1. *Venetian Talc.*

This mineral is found imbedded in serpentine, in the mountains of Salzburg and the Tyrol, and was formerly carried to Venice as an article of commerce, being employed in medicine. Hence the name Venetian Talc. It was chiefly employed as a cosmetic. It was reduced to a fine powder by heating it to redness, and afterwards pounding it in a hot mortar.

Colour apple-green, It is composed of thin flexible plates, having a silvery appearance and a pearly lustre, and easily separable from each other. These plates are not elastic. It varies from semitransparent to translucent. Very sectile. Soft enough to be scratched by the nail of the finger. Specific gravity 2.697. Infusible before the blowpipe *per se*.

I have never seen a specimen of true Venetian talc in crystals.

A very pure specimen of this mineral being subjected to ana-

lysis, the constituents were found to be,

Silica,	62.588
Magnesia,	30.328
Protoxide of iron,	3.848
Water,	3.400
	100.364

This is equivalent to,

- 5.21 atoms silica,
- 2 atoms magnesia,
- 0.14 atoms protoxide of iron,
- 0.5 atoms water.

If we allow for the presence of a small quantity of bisilicate of iron (probably accidental), talc may be considered as composed of

- 5 atoms silica,
- 2 atoms magnesia.

It is, therefore, a compound of,

- 1 atom bisilicate of magnesia,
- 1 atom tersilicate of magnesia.

Thus its chemical constitution differs from that of every other mineral hitherto examined. Venetian talc, then, is entitled to rank as a distinct mineral species.

2. *Talc-Slate.*

The mineral called *Talc-Slate* is obviously closely allied to Venetian talc; though there are many particulars in which the external characters of the two differ.

The specimen which I selected for analysis was from Novarda in Piedmont.

Its colour was white, with a slight shade of yellow. Massive and slaty. Composed of impalpable particles without any cleavage. Fracture flat conchoidal. Opaque, or only translucent on the edges. Sectile. Lustre silky. Hardness about the same as that of gypsum. Specific gravity 2.877.

Its constituents were found to be,

Silica,	57.560
Magnesia,	27.216
Lime,	7.944
Alumina,	1.720
Protoxide of iron,	4.716
Water,	1.600
	<hr/>
	100.756

This is equivalent to,

5 atoms silica,
 2 atoms magnesia,
 0.21 atom silica,
 0.41 atom lime,
 0.14 atom alumina,
 0.19 atom protoxide of iron,
 0.25 atom water.

It is obvious at once, that talc-slate consists essentially of $MS^2 + MS^3$; but that it is mixed also with a small quantity of silica, lime, alumina, protoxide of iron, and water. These bodies, in all probability, are not chemically combined, but merely mechanically mixed with the pure talc; thus disguising its external character somewhat. The slight difference in the specific gravity probably depends upon the laminated texture of the talc.

3. *Potstone from Sweden.*

I got the specimen which I subjected to analysis from my friend Mr LORANG of Gottenburg. It was polished, which prevents me from describing its characters with much accuracy. When examined with a glass, it exhibited a mixture of small silvery plates, like talc, and black-looking crystalline grains. It was opaque; the hardness nearly that of talc; the specific gravity 2.88. It was sectile, and bore a considerable resemblance to a mineral which I have seen described by the Wernerians under the name of Chlorite-slate. Its constituents were as follows:

Silica,	49.01
Magnesia,	30.20
Protoxide of iron,	11.40
Alumina,	6.08
Water,	4.20
	100.89

This is equivalent to,

- 5 atoms silica,
- $2\frac{1}{2}$ atoms magnesia,
- $\frac{1}{2}$ atom protoxide of iron,
- $\frac{1}{2}$ atom alumina,
- $\frac{3}{4}$ atom water.

Thus the composition of Swedish potstone is,

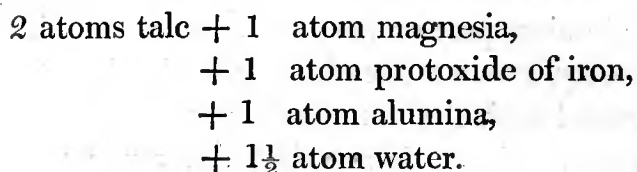

It is probable that the black crystalline grains were composed of,

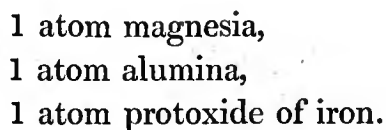

They constitute, therefore, a new mineral species. But I found it impossible to separate them from the white portion of the mineral apparently constituting the talc, or to subject them to a separate analysis.

Swedish potstone would seem, from the above analysis, to be a mixture of pure talc and of a black mineral hitherto unexamined.

4. *Hexagonal Talc.*

The mineral which I subjected to analysis was from Ala in Piedmont. It constituted large six-sided plates in a granular stone, usually distinguished by the name of granular talc.

The colour of the crystals was dark green. The texture foliated. The crystals had the appearance of very short regular six-sided prisms, about an inch in diameter, but the edges were not smooth nor well defined; which prevented the possibility of measuring the angles.

Streaks white. Soft enough to be scratched by the nail. Specific gravity 2.772.

The constituents of these crystals were found to be as follows :

Silica,	29.364
Alumina,	17.808
Lime,	3.092
Magnesia,	12.144
Protoxide of iron,	26.016
Water,	11.200
	<hr/>
	99.624

If we allow a little of the magnesia in this mineral to be replaced by lime, we have its atomic constituents as follows :

- 5 atoms silica,
- 2 atoms magnesia with lime,
- $2\frac{3}{4}$ atoms alumina,
- 2 atoms protoxide of iron,
- $2\frac{1}{2}$ atoms water.

The silica and magnesia exist in the same proportions as in talc. But more than half the weight of the mineral consists of alumina and protoxide of iron and water. The probability is, that these crystals consist essentially of talc; but so much contaminated with foreign matter as greatly to disguise the characters of the mineral.

5. *Indurated Talc.*

The specimen of indurated talc which I selected for analysis was from Sweden, but I do not know the locality.

Its colour was light bluish-green.

The texture was foliated and curved, and the folia were rather thick.

Lustre pearly, or between pearly and resinous.

Slightly translucent on the edges.

Feel soft. Rather sectile.

It does not scratch calcareous spar; but it scratches sulphate of lime very readily.

Has an earthy smell when breathed on.

Specific gravity 2.512.

Its constituents were found to be,

Silica,	39.524
Magnesia,	35.080
Protoxide of iron,	11.528
Alumina,	6.200
Volatile matter (water ?)	8.120
	<hr/>
	100,452

It is obvious at a glance that this mineral differs entirely in its constitution from talc. Its atomic constituents are very nearly,

7 atoms silica,
5 atoms magnesia,
1 atom protoxide of iron,
1 atom alumina,
 $1\frac{1}{2}$ atom water.

Hence it consists of simple silicates, and is obviously a compound of,

5 atoms silicate of magnesia,
1 atom silicate of iron,
1 atom silicate of alumina,
 $1\frac{1}{2}$ atom water.

It is undoubtedly connected with the mineral to which the name of *Nephrite* has been given. I subjected to analysis the well known nephrite, found on the shores of Iona, and which appears to have formed a part of a limestone-bed in that island, long since wrought out. Its specific gravity is 2.595, and its constituents were found to be,

Silica,	40.7
Magnesia,	43.156
Protoxide of iron,	3.528
Water,	13.200
	100.584

This is equivalent to

- 6 atoms silica,
- 5 atoms magnesia,
- 0.2 atom protoxide of iron,
- $3\frac{1}{3}$ atoms water.

Which may be reduced to

- 25 atoms silicate of magnesia,
- 1 atom quintosilicate of iron,
- $16\frac{2}{3}$ atoms water.

While the indurated talc consists of

- 25 atoms silicate of magnesia,
- 5 atoms silicate of iron,
- 5 atoms silicate of alumina,
- $6\frac{1}{2}$ atoms water.

Thus the water in nephrite is just thrice as much as in indu-

rated talc; but the talc contains a quantity of silicate of iron and of silicate of alumina, not to be found in the nephrite.

We may consider what has hitherto been called indurated talc as an impure variety of nephrite.

6. *Cornish Talc.*

This is a mineral which I got many years ago from Cornwall, under the name of Talc. The locality was not given; but I suspect it to have been found in the lode of one of the mines near St Austle.

It has a white colour, with a slight shade of yellow, and contains interspersed through it grains of dark purple fluor-spar, and of another mineral which seems to be apatite.

It is composed of small foliated masses, laid upon each other irregularly. Each of these grains (not above the size of a mustard seed) has an imperfect resemblance to a crystal. I fancy I can distinguish in some of them the rudiments of octahedrons, but this may be imagination.

Lustre rather pearly.

Translucent; sectile.

About the hardness of fluor-spar.

Specific gravity 2.648.

Its constituents, from two careful analyses, are as follows:

Silica,	45.155
Alumina,	40.110
Lime,	4.170
Magnesia,	1.900
Protoxide of iron,	2.430
Water,	4.250
	<hr/>
	98.015

It is obvious at first sight, that this mineral has no connexion either with asbestos, or talc, or chlorite, as it is almost destitute of magnesia, which constitutes an essential constituent of all these minerals. The atomic constituents are,

- 19 atoms silica,
- 15 atoms alumina,
- 1 atom lime,
- 0.6 atom magnesia,
- 0.4 atom protoxide of iron,
- $3\frac{1}{2}$ atoms water.

The atoms of silica amounting to 19, while those of the bases are only 17, it is obvious that the lime, magnesia, and protoxide of iron must be in the state of bisilicates. The constitution of the mineral may be represented thus :

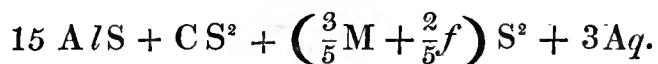

Thus it appears that the Cornish talc is nothing else than a hydrous silicate of alumina, mixed or combined with a little bisilicate of lime, bisilicate of magnesia, and bisilicate of iron. I propose to distinguish this mineral by the name of *Gilbertite*, in honour of Mr DAVIES GILBERT, late President of the Royal Society.

The mineral called Bucholzite, from the Tyrol, imperfectly described and analyzed by Dr BRANDES, is an anhydrous silicate of alumina. I am indebted to the kindness of Professor NUTALL, for very pure specimens of it from Chester on the Delaware.

Its colour is greyish-white. It is composed of fibres often curved, and which, when viewed through a microscope, assume the appearance of flat and rather irregular four-sided prisms. Lustre silky; about the hardness of quartz. Specific gravity 3.193. Infusible before the blowpipe.

I found its constituents to be,

Silica,	46.40
Alumina,	52.92
	<hr/>
	99.32

So that it is a simple anhydrous silicate of alumina. The Cornish specimen differs from bucholzite, in containing water, and in being contaminated with a little bisilicates of lime, magnesia, and iron. Its lower specific gravity and inferior hardness are probably owing to the presence of water. We may distinguish it by the name of *Hydrous Silicate of Alumina*, or *Gilbertite*.

IV. SOAPSTONE.

The mineral called *Soapstone* or *Rocksoap*, occurs in the Peninsula of the Lizzard, partly in a vein in serpentine at the Lizzard Point, and partly near Mullyan Churchtown. The colour is greenish-white, or almost white, often mottled with green and red. The white portion often traverses the red in a kind of irregular veins. When first extracted from the vein, it is soft, but when left exposed to the air, it loses part of its moisture; becomes translucent on the edges, and harder; though it is still soft enough to be scratched by the nail.

Feel unctuous or soapy; lustre resinous.

Sectile: opaque, or nearly translucent on the edges.

I found the specific gravity of a white specimen 2.396: of a red specimen 2.411. Both of them had been about sixteen years in my cabinet.

The following table exhibits the constituents of these two specimens. The first was mottled red and white, the second was white, and consequently purest:

Silica,	42.320	43.884
Magnesia,	25.680	24.144
Alumina,	9.384	9.872
Lime,	4.680	...
Protoxide of iron, . . .	1.083	...
Water,	16.960	21.228
	<hr/>	<hr/>
	100.107	99.128

KLAPROTH's analysis of this mineral approaches very closely to mine. It is as follows :

Silica,	45
Magnesia,	24.75
Alumina,	9.25
Peroxide of iron,	1.00
Potash,	0.75
Water,	18.00
	<hr/>
	98.75*

If we calculate from the second of my specimens, which I consider as the purest, the atomic constituents of soapstone are,

- 25 atoms silica,
- 12 atoms magnesia,
- 5 atoms alumina,
- 21½ atoms water.

It is obvious, at first sight, that the atoms of silica are to those of the two bases as 3 to 2. Hence it follows that soapstone is a compound of two sesquisilicates, namely of magnesia

* Beitrage, v. 22.

and alumina, with a certain quantity of water. We may state the constituents as follows :

12 atoms sesquisilicate of magnesia,
5 atoms sesquisilicate of alumina,
21½ atoms water.

Soapstone thus constitutes a peculiar species. It resembles mica, in being a compound of sesquisilicates. But the number of salts combined in it is much fewer, and mica (at least rhomboidal mica) contains no magnesia, which constitutes so conspicuous an ingredient in soapstone.

2. *Agalmatolite.*

This mineral, which comes from China, usually cut into various figures, and on that account called *figurestone, bildstein*, has been classed along with *soapstone*, though the resemblance which it bears to the characters of that mineral is not very close.

Its colour varies considerably ; but that of the specimen which I subjected to analysis was white, with a shade of bluish-green.

Lustre waxy and nearly dull. It acquires some lustre in the streak.

Fracture splintery ; rather sectile.

Translucent ; tough ; feel soft.

Not scratched by calcareous spar ; but readily by fluor-spar. It seems to have nearly the hardness of calcareous spar.

Specific gravity 2.895.

Its constituents were found to be,

Silica,	49.816
Alumina,	20.596
Lime,	6.000
Potash,	6.800
Protoxide of iron,	1.500
Water,	5.000
	99.212

with a trace of manganese.

If we calculate the composition of agalmatolite from the preceding analysis, we obtain,

- 149½ atoms silica,
- 71 atoms alumina,
- 10 atoms lime,
- 7 atoms potash,
- 2 atoms protoxide of iron,
- 28 atoms water.

We might therefore consider it as composed of,

- 35½ atoms sesquisilicate of alumina,
- 5 atoms bisilicate of lime,
- 3½ atoms tersilicate of potash,
- 1 atom silicate of iron,
- 14 atoms water.

From the analysis of KLAPROTH, and JOHN and VAUQUELIN, it is obvious that the lime and oxide of iron are not always found in agalmatolite. They cannot therefore be essential ingredients. If we leave them out, and consider the silica united with them as in combination with the alumina, agalmatolite will be a com-

pound of,

10 atoms bisilicate of alumina,
1 atom bisilicate of potash,
4 atoms water.

Agalmatolite approaches most nearly to nacrite in its composition. It differs by containing 1 atom bisilicate of potash, and 4 atoms water. Nacrite is an anhydrous bisilicate of alumina, and agalmatolite may be considered as a hydrous bisilicate, mixed or combined with a little bisilicate of potash.

I intended in this paper to have investigated likewise the chemical constitution of *Steatite*; but I have already trespassed so far upon the usual length of papers presented to the Society, that I think it better to delay that part of the subject to a future opportunity.

XXIII. *Observations to determine the Dentition of the Dugong ; to which are added Observations illustrating the Anatomical Structure and Natural History of certain of the Cetacea.*
By ROBERT KNOX, F. R. S. Ed. and Lecturer on Anatomy.

(Read 18th January 1830.)

THE following observations as to the dentition of the Dugong were made rather more than two years ago, and the inquiry as to the succession and character of the teeth in this interesting animal, and as to the exact composition of its skeleton, was then fully gone into, and all the facts to be now stated proved satisfactorily to myself at least. Notices of these opinions and facts more or less perfect, have been in several ways submitted to the public, both in this country and on the continent ; but, as the whole matter was in some measure controversial, tending to call in question the accuracy of a theory as to the dentition of the dugong, promulgated and supported by an anatomist of the highest reputation *, I hesitated whether or not the matter to be discussed merited being brought before this Society. Recollecting, however, that the opinions and statements opposed to my own views, had found their way into the pages of a work †, of such importance and authority in itself, as to impress readily

* Sir EVERARD HOME, Bart.

† The Philosophical Transactions.

in the minds of most readers an easy credence as to the exactness of whatever researches there find a place, I hesitated no longer as to the course to be adopted.

A considerable time ago, Mr SWINTON, to whom this Society owes so many rare and valuable presents in anatomy and zoology, transmitted to this country the head of an apparently full grown dugong from the Indian Seas, clothed with all the soft parts, and seemingly, in every respect, uninjured. Together with the head, which was preserved in strong spirits, and quite fresh when it reached this country, Mr SWINTON had taken the trouble to forward in like manner to the Society the heart*, stomach, and organs of generation, which appertain to the female, from which one may reasonably conjecture that these preparations belonged to the same individual, and, if so, that the cranium of the dugong, now in the possession of the Society, belonged to the female.

Our Secretary and Treasurer, who do me the honour to consult me as to the disposal and arrangement of the anatomical and zoological presents to the Society, were so kind as to inform me early of the arrival of these, and to put them at my disposal, directing me to dissect and prepare them in whatever way I should deem most fit for the interests of the Museum and of science.

This communication afforded me the greatest pleasure. I knew, indeed, that some coarse dissections of the dugong had been made in this and in other countries, and that a theory as to the

* In the excellent anatomical account of the Lamantin, drawn up by DAUBENTON merely from a fetus, preserved for some time in spirits, and under great disadvantages therefore, that careful observer first discovered and described the bifurcation of the heart, and partial separation of the ventricles of that organ from each other. A similar structure was afterwards found to exist in the dugong.

dentition of the animal had been brought forward and supported with great ingenuity by the eminent anatomist and physiologist already named, whose labours have contributed so much to support the cause of comparative anatomy in England; but I knew also that something doubtful was mixed up with these results, notwithstanding their seeming ingenuity; and I was aware also, and was the first to point out, long ago, that the osteology of the dugong, contained in the justly celebrated "*Ossemens Fossiles*," had been drawn up from an imperfect skeleton, sent to its distinguished author by MM. DIARD and DUVAUCEAL*. I felt, therefore, that any well ascertained fact must be a valuable addition to the history of the animal, and such appeared to me, whatever observations should result from a careful inspection of

* There are no proofs whatever that there now exists any where in Europe, a perfect skeleton of the dugong; by perfect, I mean a skeleton prepared under the immediate superintendence of an anatomist. The engraving of the skeleton in the *Ossemens Fossiles*, from which M. CUVIER drew up his account of the osteology of this interesting animal, represents it to be without a sternum. Now, it matters not whether the bones were sent home in this condition to M. CUVIER by the Naturaliste Voyageur, or whether the animal reached him entire, preserved in spirits, or otherwise, and the bones of the sternum were afterwards lost in preparing the skeleton; I insist chiefly on the fact, that the skeleton is, from some cause or other, imperfect. Extensive experience as to those matters has convinced me, that no skeleton can be properly prepared and in a way to be entirely depended on, with a view to anatomical and zoological inquiry, which has not been dissected and prepared under the immediate superintendence of a good anatomist. Mr ROBISON, who did me the honour to convey personally to M. CUVIER a memorandum from me, containing an outline of this inquiry, has since informed me that Baron CUVIER assured him that he now possessed five complete skeletons of the dugong; they must, of course, have come into his possession since the publication of the last edition of the "*Ossemens Fossiles*" in 1825; but it remains to be shewn before we agree to these skeletons being complete, by whom they were prepared, and if the separate bones were sent to Europe, or the entire animals

the head and cranium, put into my hands by the politeness of this Society.

When Mr SWINTON transmitted the preparations and parts of the dugong, to which I have already alluded, to this country, he at the same time sent the separate bones of another dugong, which had been macerated and prepared in the East Indies. These bones, seemingly an entire skeleton of an adult animal, came accidentally into the hands of the curators of the University Museum, and Professor JAMESON, Keeper of that Museum, very readily granted my request, that he would allow these bones to be articulated by my assistant, Mr F. KNOX, who, being much conversant with these matters, would take every care that the workmen employed by him should in no shape injure the skeleton, as had happened to a deplorable extent to the skeleton of a young dugong, at present deposited in the Museum of the University*.

* The animal to which the young skeleton I now speak of belonged, reached this country several years ago, and, as I have been assured, entire. It was the munificent gift of some patron of science to the Museum of the University. I many years ago pointed out, from a cursory and hasty view of the skeleton, when prepared, that a highly blamable neglect had been shewn in its preparation, inasmuch as the bones of the sternum and rudimentary pelvis had evidently been lost or destroyed. My brother, somewhat more than a year ago, having had occasion to re-examine this skeleton, discovered that the original teeth (probably all milk-teeth, as the skeleton must evidently have been that of a young animal) had been lost, and their place supplied by the workman to whom the articulation of this invaluable skeleton was entrusted, who had substituted for the absent teeth those of a variety of other animals, and even pieces of ivory. So that all that remains of this splendid gift is a mutilated skeleton, which ought not to be exhibited in any museum. I trust that nothing contained in this note will be construed by any one into censure of the Curators of a museum, which is really a private collection; on the contrary, we may regret with them that the person to whom they entrusted the dissection was found to be altogether unfit for real anatomical research. I mentioned these facts, first discovered by my brother, to several persons, and they, somehow or other, have got into the public journals; but this was not originally intended.

I had thus before me the crania of two adult specimens of the dugong, for such I presumed them to be, one prepared by myself, and one by some persons abroad. A little dissection brought to light a most unexpected fact, viz. *that the tusks of the crania before me differed from each other in shape and general appearance*; and that, whilst one of these resembled in all respects the tusk which Sir EVERARD HOME had characterised as belonging to the adult or complete animal, the other resembled entirely the tusk which he considered as a milk-tusk. Here, then, were two crania, evidently adult, possessing differently formed tusks, which difference in form could not possibly depend on age, as had been advanced by Sir E. HOME, but must depend on some other cause. Before we consider what that cause may be, I shall take the liberty of briefly and rapidly reviewing what has been done as to the anatomy of the dugong, by those anatomists who have preceded me in this inquiry, stating in the first place, succinctly and briefly, those facts (and the conclusions drawn from them by myself), which may be verified by the Members of this Society and by others, by simply inspecting the two crania, I have had an opportunity of describing.

The cranium of the skeleton at present in the possession of the University, is somewhat smaller than that now before the Society. The length of the skeleton is fully 7 feet 3 inches English; the bones are extremely hard, and the head dense and heavy. In the crania I observed differences as to the shape of various bones, when compared with each other, which, upon the whole, however, hardly amounted to what I should venture to call specific differences. They do not exactly resemble each other. In the upper jaw there are two tusks in the intermaxillary bones, and three molar teeth on each side, opposed to those occupying a similar situation in the lower jaw-bone. The ante-

rior part of this bone slopes greatly, and is of vast strength, and there are cavities for eight rudimentary teeth, which teeth, however, are not present. It will be quite obvious to every one, that the teeth may have been lost by maceration, or have been intentionally removed, or accidentally dropt out ; to me it seems probable that they occasionally remain in the jaw during the whole period of the animal's existence. Upon the whole I do not reckon this a question of any moment. The right tusk of the narwal (which is an incisive tooth) remains always imbedded in the jaw, and seldom shews itself even beyond the gums, and, were it not for this, I should imagine, by what we see take place in man, that the alveolar cavities would be absorbed and disappear, and thus cause a great loss of depth and strength in this part of the jaw. If we apply this reasoning to the jaws and small rudimentary incisive teeth of the dugong, we shall find the natural conclusion to be, that they probably get entangled in the alveolar cavity, and may possibly thereby prevent its absorption and disappearance, which, according to the physiological laws prevalent in other animals, would most certainly take place, were the teeth entirely removed. Those who talk of the filling up of the alveolar cavities, after the removal of the teeth, either by a natural process or otherwise, employ a language exceedingly incorrect, and at total variance with the whole history of dentition, and the changes which take place in the maxillary bones of animals, from a variety of causes.

Without pretending, therefore, to consider it as a view finally settled, I deem it merely probable that the incisive teeth in a rudimentary state are retained, and lodged in the alveolar cavities of the lower jaw-bone, throughout the life of the animal, for the reasons assigned. Should it be afterwards shewn that an opposite law prevails in the dugong, to what takes place in other animals ; should it hereafter be shewn that the alveolar processes of the maxillary bones can and do retain all their depth and

strength, even after the teeth which were lodged in them have been thrown off by the ordinary processes of dentition, I shall not be in any way surprised at this, knowing as I do the infinite power of Nature, which adapts and modifies all structure according to the wants and habits of the animal.

The cranium now on the table of the Society is somewhat larger, and of a different shape, from the one I have just described, and which I presume is still preserved in the University Museum. The tusks or teeth, supported by the intermaxillary bones, correspond in every respect to those which have been described as milk-tusks by Sir E. HOME, and yet they are not milk-tusks. They are as long as the so-named permanent ones of the other head. To suppose them milk-tusks, we should be forced to have recourse to conjectures totally inadmissible in anatomical inquiry. We might suppose them to be milk-tusks, which, by some extraordinary accident, had not been thrown off at the usual time, but had grown up and taken on the functions of the permanent ones, which, in this individual, had not been developed. Now, conjectures of this kind lead to error, and are altogether unnecessary in the present case. The tusks differ as much in form in the two crania, as the tusks of the Asiatic elephant differ from those of the African one, and, therefore, naturalists would say that these animals must be specifically different*. I hesitate, however, in asserting this positively, and would say rather that it amounts with other data, such as the belief, on the part of the Malays, in whose seas these animals reside, that, to a great probability, there are two distinct species of the dugong now inhabiting the Eastern Ocean. I

* The difference in the tusks of the African and Asiatic Elephants is not confined to mere form; Mr ROBISON informs me that the ivory is much finer and more dense in the former than in the latter.

do not at the present moment remember any facts tending to shew that these very obvious differences may be merely sexual; and that they do not depend on difference as to age, I think has been clearly made out by the preceding observations*.

It may be observed, moreover, with a reference to the tusks of the cranium now on the table, that there are no appearances of permanent or other tusks behind these; no vestiges of the roots, or such other appearances as indicate their probable ultimate replacement by others. The molar teeth correspond in both jaws, and in the lower jaw of this cranium we find the alveoli for the reception of the imperfect rudimentary incisive teeth formerly spoken of. These teeth are mostly present, but not all, a circumstance which may either arise from some of them having been thrown off, or by their having become encrusted with bone. All this part of the jaw was covered with a dense and almost horny semicartilaginous substance. A similar substance was found encrusting the palate above, and these substances seemed to me placed there, to supply the deficiency of incisive teeth †.

The dugong seems then to have originally, and, whilst yet

* I observe, in a late number of the *Annales des Sciences d'Observation* that a new species of fossil Hyæna has been established, merely from a slight variety of form occurring in one of the *molar teeth*.

† There is rather a vagueness in what Sir E. HOME says about the *milk-molar teeth in an animal four feet eight inches long*; it seems reasonable to have expected that the molar teeth in such an animal should have been proved to be *milk-molar teeth*, by laying open the jaw and shewing the germs of the *permanent ones below*. The same distinguished anatomist has, besides, from an accidental oversight no doubt, given a representation of the upper jaw of a dugong, which must obviously have been adult, there being two molar teeth on one side, and three on the other, and has described this jaw as belonging to a young one, and has called these teeth *milk-molar teeth*.

young, incisive teeth in both jaws, in addition to the tusks in the upper. Of these incisors, the upper smaller or mesial ones, are thrown off at an early period, and not replaced. The tusks are probably replaced by permanent teeth. No tusks are found in the lower jaw.

As regards the other parts of the skeleton, I found, in the one so often alluded to during the course of this memoir, twenty-six cervical and dorsal vertebræ, and twenty-eight caudal. The sternum is very remarkable; but its appearance cannot be altogether depended on, for this reason, that we know not how the bones were originally prepared, nor what violence, or injury, or loss, they may have sustained. That they are not quite perfect, is obvious from what I discovered had happened to the temporal bone, where, very obviously, the knife or chisel had been at work, to extract the small bones of the ear. Whether this happened previous to the bones being sent from India, or merely prior to their being inspected by me, I shall not take it upon me to determine. The adult sternum, in a perfect state, may not as yet have been seen by any anatomist.

From the hasty glance I had of the soft parts, I will venture to predict, that the arrangement of the hyoid bones, and their connexion with the tongue, have been totally misunderstood; but I am unwilling to bring forward any views as to this part of the animal, until another opportunity shall occur of inspecting these parts.

In the bones of the fore-arm we meet with an unexpected resemblance to the elephant, in a structure hitherto deemed unique. The ulna is the stronger bone at the carpal joint; but it is quite probable that this structure prevails in several pachydermatous marine mammalia.

Zoological Arrangement of the Dugong.

In the inquiry, which, at the Meeting of the 21st December 1829, I had the honour to submit to the Society, the dentition of the dugong was considered. It was shewn in that memoir, that an insuperable objection lay against the views as to the succession of the tusks of the dugong, promulgated first by the distinguished English anatomist, Sir EVERARD HOME, and adopted, so far as I know, by most continental ones. The observations which were then submitted to the Society shewed, that in two *adult* crania of the dugong, there were two kinds of tusks, quite distinct from each other in their form, and that this difference seemed specific, as not being referrible to age. In considering the character I speak of as specific, I do not go beyond the ordinary rule of zoological investigation ; but, whether or not this determination be the correct one, I feel yet assured, *that these differences in the form of the tusks, in the adult crania of the dugong, do not depend on age*, and this is all I contend for at present.

There is a fact to which I beg leave to call the attention of the Society, before I quit this subject. The milk-tusks of the dugong have never been seen by any one ; that is, I have not heard of the existence of any preparation shewing the germs of the milk or permanent teeth, together or in succession, and in such a way as to leave no doubt on the subject. They may exist, inasmuch as there is nothing in the economy of this interesting animal forbidding such a belief ; but I repeat that they never have been seen by any one ; so that it seems to me but right, that, previous to all further speculations as to the natural history of the animal, efforts were made to perfect, in some measure, its anatomy, on which alone can the zoologist found any rational inquiry.

The remarks I have to make as to the zoological arrangement of the dugong, are of less interest than those regarding its dentition, as being a question merely of nomenclature and system. The dugong was first arranged with the walrus. CAMPER, in his natural history work, called in question the propriety of this arrangement. He was followed by others, and, finally, by Baron CUVIER, who determined the dugong, lamantin, and the animal of STELLER, to belong naturally to the Cetacea, and they were accordingly arranged under the head of Herbivorous Cetacea. I confess that, from the time I commenced these inquiries into the anatomy of the dugong, I felt much inclined to question the propriety in their having separated this animal from others to which it seemed naturally allied. The external form, it is true, so far as regards the caudal termination of the body, greatly resembles the dolphin, porpoise, and whales generally; and there are facts in the anatomy of the bones composing the skeleton of this part of the body, such as the form of the bones of the pelvis, the presence of the bones having the form of the letter V, found on the ventral aspect of the caudal vertebræ, which, taken together with the complete enclosure of all the bones of the upper extremity, so as to render the articulations of the limb of probably little use to the animal, are facts, it may be admitted, in favour of its arrangement with the Cetacea; but, when we reflect on the form of the cranium of the dugong, on the structure of the molar teeth and tusks*, on the dentition of the animal generally, on the structure of its stomach, position of the mammæ of the female so different from that of the Cetacea, one cannot but be convinced, reflecting without prejudice on these facts, that the dugong may be more naturally grouped with the walrus, than with any of the whale tribe as yet described by na-

* The teeth in the true Cetacea, when present, are uniform.

turalists. The Scapulæ of the dugong, have no resemblance to those of any of the Cetacea I have examined, but they approach those of the walrus. The great strength of the zygomatic arch, and, indeed, the whole anterior part of the body, shews the natural affinity with the tribe of the walrus; so that here, as in so many other zoological cases, I fear it will be found that considerations, drawn chiefly from external characters, lead only to false conclusions.

True Cetacea.

We owe to Mr JOHN HUNTER most of the best made out anatomical facts in the history of the Cetacea: above all, we owe to him the history of their mode of dentition; and the facts and observations, together with the conclusions drawn from them, have, so far as I know, never been directly questioned by any one. Mr HUNTER, I think, was the first to prove that, in their mode of dentition, whales do not strictly resemble other mammalia. He shewed, as far at least as the field of his inquiry extended, that nothing that had been made out regarding the succession of the teeth in the other mammalia, was at all applicable to the Cetacea. In them we have no permanent teeth following milk-teeth, but one set only which are at once temporary and permanent, that is to say, the anterior ones, together with the small part of the jaw containing them, are constantly worn away and lost during the life of the animal, and these are replaced by others, which grow up from behind, precisely as in the elephant. Now, I had thought that this mode of dentition described by Mr HUNTER, and which I had myself verified in a very considerable number of the Cetacea, might, without venturing on a rash analogy, be held as applicable to all the Cetacea; but it would seem some have thought differently, and, among these, the immediate suc-

cessor of Mr HUNTER, SIR EVERARD HOME, who, in a paper published in the Transactions of the Royal Society of London, speaks familiarly of the milk-tusks of the narwals*. That it was possible, I repeat, that the dentition of this animal might really differ from the other Cetacea, in the having temporary teeth followed by permanent ones, was a circumstance which, in so far as regards its possibility, could not be questioned; but still I doubted the fact, and this doubt seemed confirmed by a note subjoined to the history of the narwal, in the Fossil Remains of Baron CUVIER, which note, though rather obscure in its style, impresses my mind with a belief that that distinguished anatomist holds opinions similar to those I now submit to the Society; and, as the zoology of this remarkable cetaceous animal is as yet extremely imperfect, I shall take the liberty of submitting to the Society a few remarks as to the structure of its skeleton.

Skeleton of the Narwal.

When Baron CUVIER published the last edition of the "Ossements Fossiles," he had not seen a skeleton of this remarkable whale.

* All anatomists will readily admit the possibility that the mode of dentition of the narwal might be found, on inquiry, to differ from that prevailing in the ordinary Cetacea, inasmuch as the anatomical facts, and the inferences from them, cannot, as I had the honour to demonstrate to the Society on a former occasion, be transferred by *à priori* reasoning to any other species, even though that species be strictly congenerous: at least this has been the impression under which I have now, for a very considerable number of years, carried on extensive inquiries into the anatomical structure of animals. And here I may take the liberty of remarking, that this does seem to me to have been the impression under which all anatomists of any reputation have acted, notwithstanding the observations to the contrary which have been lately brought before this Society and the public, by a distinguishea British

If any proofs were wanting that natural science requires protection, that it never has, nor ever can, make any progress in the hands of others than strictly scientific men, it will be found that the facts required to demonstrate this may be best drawn from the history of the Cetacea.

Since the period when the commercial nations of Europe first navigated the icy seas of Greenland, to obtain by the capture of the whale, and others of the tribe Cetacea, whalebone and oil, for the purposes of traffic, hundreds of vessels, admirably equipped, commanded by persons not wholly illiterate, and (I regret to make the avowal) provided with surgeons, whose education ought, assuredly, always more or less, to lead to a fondness for natural historical pursuits, have annually visited these frozen coasts; have assisted in the capture of thousands of whales; have been now, for some centuries past, under circumstances the most favourable for the observation of the peculiar history of these most interesting animals, without the addition of a single well ascertained fact, so far as I can learn, to those published nearly a hundred years ago by a gentleman in no way commercial, the Honourable PAUL DUDLEY, who published, in the Philosophical Transactions for 1730, some Observations on the Natural History of several of the larger Cetacea.

There is something, then, in the spirit of trade and commerce hostile to real science, and to the progress of scientific pursuits; nor do I think this hostility limited to the sciences termed Natural merely, but to every kind of knowledge with which I am acquainted. These remarks I do not make with a view to hurt the feelings of any one, but simply to explain the difficulties which anatomists and naturalists have experienced in

naturalist, Dr FLEMING; an erroneous conception of which, without doubt, must have arisen in his mind from his little acquaintance with anatomical science.

completing the history, or rather, I should say, in obtaining facts sufficient for a mere outline of the structure of these animals *, and as an excuse for wishing to record in the Transactions of this learned body a few facts regarding the anatomy and physiology of whales, which, compared with the mass of unexplored inquiry, must be deemed comparatively meagre and scanty, and of which fact I may venture to presume few can be better judges than myself.

Mr HUNTER, in the work I have just alluded to, says, "From my want of knowledge of the different genera of this tribe of animals, an incorrectness in the application of the anatomical account to the proper *genus* may be the consequence; a tolerably correct anatomical description of each species, with an accurate drawing of the external form, would lead us to a knowledge of the different genera, and the species in each; and, in order to

* Mr HUNTER, whose position in life enabled him more than any other person to investigate the structure of the Cetacea with advantage, has remarked, in those admirable "Observations on the Structure and Economy of Whales," that he has availed himself as much as possible of all accidental opportunities of ascertaining the anatomical structure of large marine animals; "and, anxious to get more extensive information, engaged a surgeon, at a considerable expense, to make a voyage to Greenland in one of the ships employed in the whale-fishery, and furnished him with such necessaries as I thought might be requisite for examining and preserving the more interesting parts, and with instructions for making general observations; but the only return I received for this expense was a piece of whale's skin, with some small animals sticking upon it."—P. 372.

For my own part, I may say that all accidental opportunities of dissecting the larger species of whales in this country have been denied me by a curious arrangement, which I wish I could believe altogether accidental; for, notwithstanding the fact, very generally known, that all my leisure moments were constantly employed in ascertaining the anatomical structure of various animals, it has uniformly happened that the requisite information as to the stranding of any of the larger whales has been brought to me last. And thus has it happened with almost all the opportunities which have from time to time occurred for the anatomical examination of the rarer animals which have reached this country during the last ten years.

forward so useful a work, I propose at some future period to lay before the Society descriptions and drawings of those which have come under my own observations." Mr HUNTER, by these remarks, means, no doubt, to state that he had in his possession anatomical descriptions or monographs of the various individuals of the whale tribe examined by him. These monographs unhappily, so far as I know, have never been communicated to the public *. This is extremely to be regretted, inasmuch as, until the publication of proper monographs of each species, drawn up from dissections made by experienced anatomists, almost every thing said regarding the Cetacea, or of any other tribe of animals, must be matter of pure conjecture.

Delphinus Phocæna.

I am indebted to my brother for certain of the following observations on some parts of the anatomy of the porpoise.

The ribs have always been found to be *thirteen* on each side, when the specimen came uninjured into his hands at first, a fact the more remarkable, I think, that all the artificially articulated skeletons I have seen have twelve only on each side, shewing how easily errors arise when the setting up of a skeleton is entrusted to persons altogether ignorant, or altogether regardless, of anatomical science. In one specimen which is now in the Museum, about the middle of the dorsal vertebræ, there is a

* As I have not the honour of a personal acquaintance with the person into whose hands Mr HUNTER'S Papers came on the demise of that great man, I here take the liberty of suggesting to him the propriety of publishing those Memoirs of the Cetacea spoken of by Mr HUNTER, which assuredly will be found to contain highly important facts and observations.

vertebra which carries no rib, and this fact is undoubted, inasmuch as the skeleton was prepared as a natural skeleton; but this is seemingly only an individual variety, since in the skeleton of several others, and more particularly in that of the foetus of the porpoise, no such appearance is met with.

The skeletons of several specimens, of various ages, of the *Delphinus Phocæna*, prepared with great care by my brother, and whose skeletons are still in the Museum, shew that there are seven cervical vertebræ.

Other specimens of the genus Delphinus.

The want of symmetry in the bones of the cranium of the narwal does not extend to all the Cetacea. We have seen that it scarcely exists in the *Delphinus Phocæna* and *Delphis*. There is in the Barclayan Museum the skeleton of a grampus, which was stranded in the Frith.

Cervical vertebræ, . . .	7
Dorsal and caudal, . . .	56
	<hr style="width: 10%; margin: 0 auto;"/>
	63

Cranium very nearly symmetrical.

Teeth $\frac{22.22}{21.21}$: the two anterior teeth slope much forward; they are small, and solid.

There are twelve ribs on each side: and of these, eight are articulated with the transverse processes of the vertebræ only.

There is the cranium of a large description of grampus in the same museum, in which the want of symmetry is very re-

markable. There are alveolar cavities for six teeth in the upper jaw on each side, and a similar appearance in the lower jaw; these teeth may once have been conical, but, by use, they are much flattened above, and sloped. These anatomical differences, found to exist in animals so greatly resembling each other, are remarkable.

Of the Size of the Fœtus of the Cetacea at the time of Birth.

Naturalists, I presume, must have few well authenticated facts on this point, otherwise it would not happen that so able a naturalist as the author of the *British Zoology* should have described the fœtus of the *Delphinus Phocæna* as being only seven inches in length shortly before birth*. I have put on the table of the Society the skin of the fœtus of a common porpoise, of the usual length (about five feet two inches), and which was caught in the Frith of Forth. It was removed from the uterus, together with its membranes, in presence of a numerous class. The length, even in its present dried state, is two feet six inches, and I see no reason, from the state of the parts, to suppose that the birth of the young was about to happen at the moment of the capture of the mother. The fœtus of the seal is, in like manner, of a disproportionate size to its parent †. Its birth is provided for by a remarkable mechanism connected with the fibro-cartilaginous and ligamentous structure of the symphysis of the pubis, which, previous to, and during parturition, elongates to the extent of nearly two inches. The effects of this, in enlarging

* *British Animals.*

† The fœtus of a seal shortly before birth was found to be about 2 feet 6 inches in length, that of the mother being about 5 feet 2 inches.

the capacity of the pelvic apertures, may be readily judged of by reflecting on the elongated square form of the pelvis of the seal; but it is equally obvious, that the artificial separation of the bones of the human pelvis, by a section of the ligamentous symphysis, cannot produce the same results, by reason of the circular form of the cavity of the human pelvis. The pretended reasoning from analogy, then, on the part of those who have proposed imitating a process of nature, in dividing the human symphysis pubis during laborious or difficult parturition in women, argues merely a want of accurate observation on their part, and is an attempt to supply one animal with a mechanism, which Nature exclusively intended for another, whose structure was originally entirely different*.

The total length of the skeleton of the narwal, apparently that of an adult animal, in the Barclayan Museum, as now articulated, and which is said to have been presented to Dr BARCLAY by Captain SCORESBY, is 16 feet 3 inches. Length of the head 2 feet; of the tusk 6 feet $1\frac{1}{2}$ inches, being that remarkable single tooth which has in all ages characterized this animal; it being also well known that, in the male, the left tusk only is developed so as to protrude beyond the gums, whilst the right remains imbedded in the jaw for life; in the female both tusks remain in this latter state; the part imbedded within the socket

* In an Essay on the History of Whales, by the Honourable P. DUDLEY, Phil. Trans. 1725, the following observations occur as to the bulk of the fœtus of the Whale.

“ WHALEBONE WHALE.—This fish, when first brought forth, is about 20 feet long, and of little value: the full-grown animal is 60 or 70; say as 1 to 3.

“ SPERMACETI WHALE.—The calf, or young whale, has been found perfectly formed in the cow when not above 17 inches long, and white; yet, when brought forth, it is usually 20 feet, and of a black colour.”

10 inches. The tusk is rolled spirally throughout its whole extent, with the exception of about $3\frac{1}{2}$ inches at the point where the tusk is smooth, and resembles strongly the young teeth. On looking into the cavity for the reception of the pulp, we perceive the spiral twisting to be as well marked as on the outside, and we find the tooth to be hollow throughout the whole extent of the cavity for its reception in the jaw. With the exception of a small space in the centre, we are sure that the remaining part is solid.

The animal has a distinct vertebra dentata, almost as large as the atlas, and, in this respect, differs much from the common porpoise of the coast, which has the dentata united to the atlas by bone, and not to be distinguished from it; and the spinous process, which is distinct, is a mere plate of bone. With reference, then, to these two vertebræ, the narwal differs from all the Cetacea I have examined; and of whom it may be said generally, that the vertebræ of the neck run much together, and are so united as not to admit of any motion in this part of the vertebral column. The neck of the narwal is therefore somewhat longer proportionally than in the other whales; and the flexibility of its neck must enable it to be much more agile than others of its kind. In short, we find moveable vertebræ with distinct or peculiar surfaces, appearances which do not exist in this part of the column in any of the other true Cetacea I have seen or read of.

There is no opening for the vertebral artery. The junction of the first and second vertebræ is by two surfaces, as in man and other animals. In looking into the vertebral canal, *no* processus dentatus is seen, so that it presents an appearance as if the processus dentatus had been cut slopingly off on its superior surface, leaving only its articulating surface, as seen in other animals. The dentata and atlas are equal as to breadth, viz. 8 inches. They are almost equal as to strength. The third

vertebra is remarkably thin and anchylosed to the second. There are no openings in the transverse processes. The fourth, fifth, sixth, and seventh cervical vertebræ are distinct, having intervertebral cartilages interposed, and none of these is so weak as the third. There are characters in which the narwal differs from other Cete. No vestiges of openings for the vertebral arteries in any of them. There are eleven dorsal vertebræ, and eleven ribs on each side. But Captain SCORESBY, whose authority in these matters is unquestionable, says, that there are twelve dorsal vertebræ, and, of course, twelve ribs, so that these bones, in the skeleton now under consideration, may have been lost.

In the Cetacea, apparently, the transverse processes of the vertebræ undergo a sudden elongation, about the termination of the dorsal ones, *that is the thirteenth vertebra*. This we find to be the case in the narwal under consideration.

There are thirty-two remaining vertebræ in the Barclayan narwal, and twelve bones in the form of the letter V, which bones may be considered as spinous processes on the ventral aspect of the vertebræ. They are, however, placed upon the vertebral substances, which renders their presence altogether anomalous. There are then in the narwal,

Cervical vertebræ,	7
Dorsal, carrying ribs,	11
Lumbar and caudal,	32
	—
	50

The caudal may not be all present; and as Mr SCORESBY says that there are in the narwal he examined fifty-four vertebræ, it is more than probable that four bones of the Barclayan specimen have been lost.

The length of each pectoral extremity is 17 inches; these are imperfect, however, inasmuch as few of the fingers are present. The bones of the pelvis are entirely wanting; that is, I presume, they have been lost in the original preparation of the animal.

	Feet.	Inches.
Length of head,	2	0
Breadth,	0	17

The tusks are carried in the maxillary bone. The summit at the top of the head is removed to the left side to the distance of about an inch from the mesial plane, so that, looking at the head from behind, it has a singular unsymmetrical appearance, the right side of the occipital bone appearing so much broader than the left side; whilst looking at the face on the upper surface, the left side again preponderates over the right, in consequence of the much greater size of the left maxillary bone, as it requires to carry the fully developed tooth. This difference in breadth and depth does not extend to the inter-maxillary bones, or very slightly; and indeed, superiorly, the inter-maxillary bone of the right side is the larger of the two; so that the want of symmetry follows a different law in the cranium and upper part of the face from what it does in the lower part of the face. The distance between the orbit of the right side and the anterior margin of the blow-hole of the same side, being nearly an inch greater than on the left. The law, therefore, seems to be, that the greater development with regard to the cranium is on the right side, and with regard to the face, on the left side, and the head has altogether a twisted appearance. This singular want of symmetry in the bones of the cranium and face has not been remarked by M. CUVIER, though in the engraving of the cranium of the narwal the appearance I speak of has been very accurately represented by the engraver. The capacity of the cranium is large,

analogous to what we find in the porpoise and dolphin, and the squamous or ascending plate of the occipital bone is imperfectly ossified, and very thin. The jaw where the developed tooth is contained is slightly reticulated on the upper surface. The symphysis of the lower jaw has been originally united by syndroses, and a shallow groove runs along, for a short distance, the upper margin of the lower jaw, obviously analogous to the deep groove in the porpoise, dolphin, and many other Cetacea, containing in them the sharp conical teeth, but, as is well known, there are no teeth of this kind in the narwal. The maxillary bones are loose and spongy; the inter-maxillary firmer and denser, more resembling in structure the inferior maxillary bones.

Mr HUNTER's admirable account of the dentition of the ordinary Cetacea may be corrected apparently in one point; the groove, or elongated cavity for the reception of the young teeth, cannot be formed by the sinking down of the teeth in it, for the teeth are already deeply imbedded in it in the foetus. In many species of animals, moreover, the osseous partitions of the alveolar cavities are by no means complete. It is probable, therefore, that the germs of the teeth are developed in this elongated alveolar cavity, much in the same way as they are in other Mammalia; but, as Mr HUNTER remarks, they do not succeed each other by germs placed above or below each other in the jaw (according to the jaw spoken of), but rather from behind forwards, the anterior ones, together with the portion of the maxillary bone carrying them, gradually wasting away by a law in the economy of the animal. The inter-maxillary bones carry $\frac{1}{1}$ teeth apparently in many of the Cetacea, as in all the porpoises.

In the adult animal, and no doubt in many others of the Cetacea, this elongated groove for the reception of the teeth may,

and does actually become, partially divided into a number of compartments by osseous division or ridges*.

It is, moreover, probable that the inferior dentar canal, which more resembles a great cavity, contains numerous blood-vessels and nerves, calculated to allow of, and supply, the waste of the jaw, and the succession and loss of teeth; and the same structure may prevail even in the narwal, since being of an analogous nature with the other Cetacea, the jaws may waste away in it although there be no teeth present, with the exception of the left tusk and the aborted tooth † of the right side.

Since the period of the earliest voyages to the Arctic Seas, the narwal, from the remarkable projecting and single tooth, carried in the upper jaw, has attracted the attention even of those least interested in zoological inquiries. The facts, that it is the left tooth only which is developed in general—that sometimes the right is also found to extend, more or less, beyond the gums, but more usually remains in the socket, imbedded in the jaw, probably for the whole life of the animal—and that, in the female, both these teeth remain in the jaw, and never shew themselves external to the gums;—these are facts known to every one. But I do not believe that these aborted teeth, which remain imbedded in the jaw, viz. the right tooth in the male and both in the female, are *milk tusks*, or merely temporary teeth; neither is there a single observation in the history of the narwal to shew that there really exists any true succes-

* There is a species of Rhinoceros in which two incisive teeth remain below the gum during the whole period of the natural life of the animal: they are not to be seen then so long as the head is covered with soft parts. Thus the permanent residence of teeth within the alveolar cavities, or not visible beyond the gums, as assuredly happens in the narwal, and, as I supposed, might also occur in the case of the lower incisives in the dugong, is a fact not confined to the Cetacea.

† An expression employed by M. CUVIER.

sion of the teeth as in most of the Mammalia. The crania of two foetuses of the narwhale now before me show no such appearances. On each side of the upper jaw, and in the usual place, there are two hollow teeth, obviously the extremities of the spiral permanent tooth of the male. These teeth are completely imbedded in the jaw in the young narwhale; observation tells us, that if the animal be a male the left tooth continues to grow, the right, after a time, fills up, its central cavity for containing the pulp disappears, and, after attaining a growth of 5 or 6 inches, the jaw elongates, to correspond with the growth of the animal and of the other tooth, and the aborted tooth remains imbedded in the jaw for life.

Digestive Organs *.

Inquiries into this system of organs are by no means so complete as they ought to be. My own very limited field of inquiry has presented but few novel facts, if any; but I feel inclined to view differently from those who have preceded me in this inquiry, that structure in the second stomach of the porpoise and dolphin, which many have considered as glandular merely. That it bears a considerable resemblance to the tubular portion of the kidney of some animals cannot be overlooked, but this, for obvious reasons, does not seem to remove the difficulty we have in considering the whole structure as merely glandular. The

* I have not observed the muscles in any of the whale tribe or Cetacea to stiffen, nor the blood to coagulate after death. Others, however, whose opportunities for observation may have been more extensive, may have noticed these phenomena. The muscles are, compared with other Mammalia, soft and easily lacerated. The anterior filaments of the spinal nerves are greatly more numerous or larger than the posterior.

following are the few brief remarks I have been able to make regarding it.

In accordance with the language of all or most anatomists, I shall speak of this species of the Cetacea as having four stomachs, this being the usual language held with reference to the stomachs termed complex. My own opinion, as explained more fully in a memoir I had the honour to submit to the Royal Society of Edinburgh, on the Structure of the Stomach of the Lama, is, that no animal possesses more than one stomach, divided more or less by compartments, and thus assuming the appearance of one or more cavities, which anatomists have unhappily spoken of as being one or more stomachs. Now, in accordance with this language, which, however inaccurate, demands respect from its universality, I shall speak of the second cavity in the stomach of the porpoise as being the second stomach.

The gullet of the porpoise, composed of the usual membranes or tunics common to it with other Mammalia, terminates in a somewhat elongated, tolerably capacious pyramidal-shaped bag, known by the name of the first stomach. In this we find, externally, and immediately invested by the peritoneal tunic, a strong coat of muscular fibres, spread uniformly over the surface, continuous upwards with the muscular layers of the gullet, and downwards with those which, in a similar fashion, envelope the second stomach, occupying the same situation relatively to the peritoneal tunic in it as in the first. This muscular tunic of the first stomach is composed of two layers, separated from each other by a layer of cellular membrane; the fibres are chiefly longitudinal and circular. Within these there is the usual vasculo-cellular layer, and it has within it a mucous membrane, covered by a strong epidermic covering. By maceration a double epidermic covering may be separated from the mucous surface of the gullet, but one only seems to invest the first stomach.

To this cavity the branches of the *nervi vagi* (which are large and distinct) do not proceed in any great abundance, their course is rather towards the second cavity or stomach, whose structure I shall now endeavour to describe. The capacity of the second stomachal cavity is less than that of the first, and its structure differs remarkably from it. The aperture of communication betwixt these cavities admits readily enough the fore-finger, and here the internal textures of the first stomach suddenly cease; the epidermic covering and subjacent mucous membrane cease, and there is substituted for them a perfectly smooth membrane, without villosities or glandular structures; it has a good deal the appearance of a serous membrane. This closely invests a series of fibres, which externally are covered by an extremely vascular and cellular tunic. These fibres are placed perpendicularly betwixt the two membranes I have spoken of, and quite close to each other. They may be considered, then, as placed on the outer surface of the internal membrane of the stomach like a pile of velvet enclosed by thin laminae or plates*. Outside the vasculo-cellular layer, muscular layers exist, continu-

* I here take the liberty of subjoining a microscopical examination of the structure by Dr BREWSTER. " I have examined the piece of stomach you have sent me of one of the Cetacea. It seems, in its wet state, to consist of tubes or fibres, perpendicular to the two membranes which enclose them, thus:  and the upper surface of one of the membranes is covered with hollows or depressions, corresponding with the extremities of the tubes or fibres. A more minute examination, conducted in a different way, proves these perpendicular portions to be tubes. In order to dry it, I pressed it between folds of paper, and the effect of the compression was, to press together nearly all the tubes, and make the whole one dense mass of a dark brown colour; but when it became dry, and slightly indurated, I drew it out as if it had been India rubber, and the tubes opened and the mass became white, thus* :



* See Edin. Phil. Journal by Dr BREWSTER.

ous, as I have already said, with those of the first stomach, and transmitted over the second, which they, in like manner invest, to the third. The interior of this second cavity, when laid open, presents a series of longitudinal and transverse elevations, which resemble the interlocking of the fingers with each other. To this stomach most of the branches of the nervi vagi are distributed.

The third and fourth cavities have been very carefully described by Baron CUVIER, and by most systematic writers on comparative anatomy. The questions raised by CAMPER as to the *number* of the stomachs in this animal, do not merit notice. The accompanying sketch will perhaps explain in an easier way than I have done, to the non-professional reader, the structures in question. I forbear for the present all speculation as to the nature of these fibres, which are obviously not muscular, and can hardly be considered merely glandular; future observation and experiment will, no doubt, one day determine whether or not I am correct in supposing them analogous to the electric organs of certain fishes.

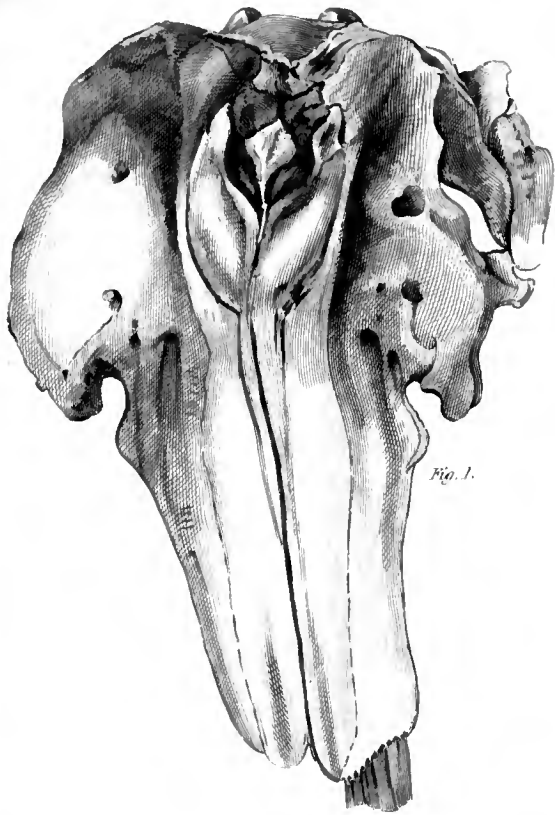

Fig. 1.

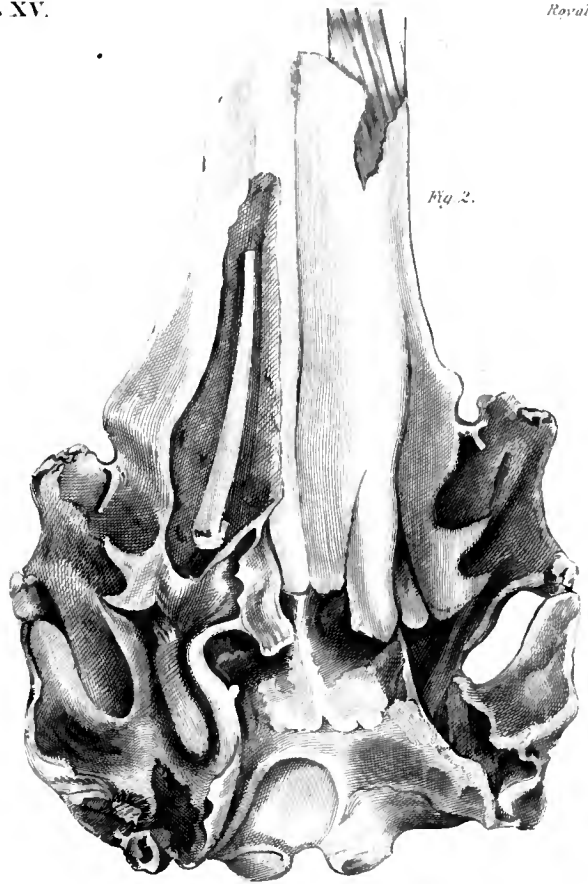

Fig. 2.

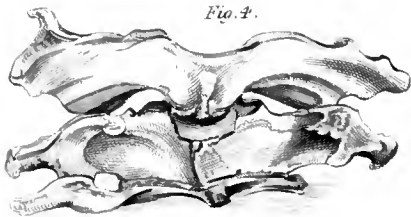

Fig. 4.

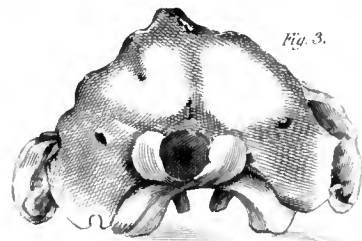

Fig. 3.

Fig. 7.

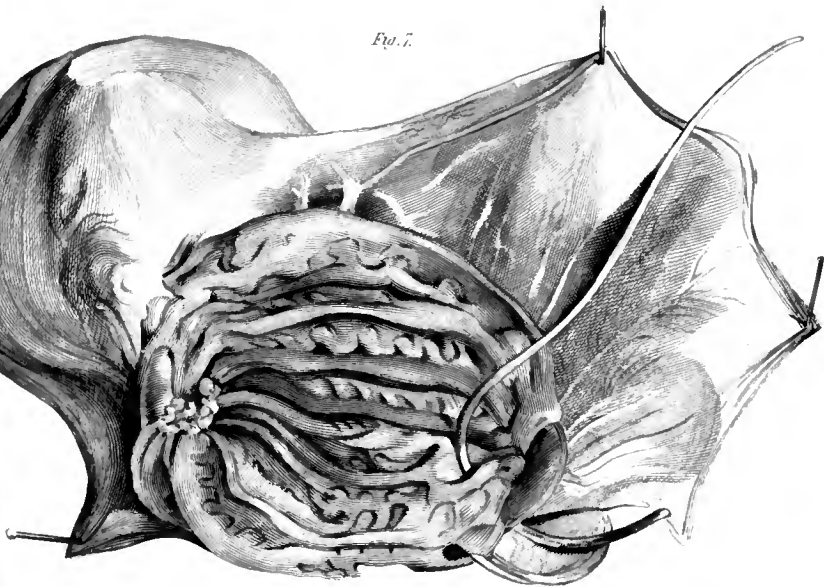
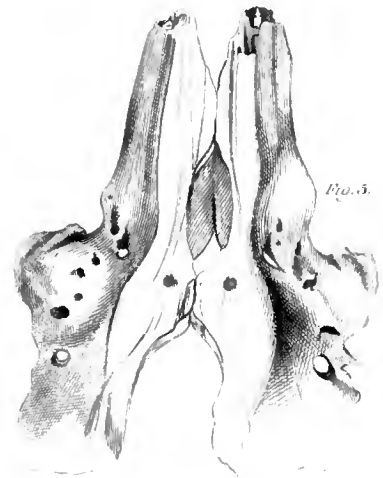

Fig. 8.

Fig. 6.



Fig. 5.



a
b



EXPLANATION OF PLATE XV.

- Fig. 1. Cranium of the adult narwal seen from the upper surface.
- Fig. 2. The same cranium seen from below. These sketches were made with great care.
- Fig. 3. The same cranium seen from behind. The want of symmetry is remarkable.
- Fig. 4. The atlas, dentata, and third cervical vertebra of the same narwal.
- Fig. 5. Cranium of a young narwal (supposed to be a foetus), seen from above.
- Fig. 6. One of the teeth withdrawn from the socket. The young narwal seems uniformly to have two such, of nearly equal length; one only comes to perfection in the male; neither in the female.
- Fig. 7. Inner surface of one of the compartments of the porpoise, in which there prevails a peculiar structure, tubular or fibrous, and perhaps electrical.
- Fig. 8. Figure shewing the remarkable regularity of the tubes or fibres placed between two tunics of the stomach.

XXIV. *Remarks explanatory, and Tabular Results of a Meteorological Journal kept at Carlisle by the late Mr WILLIAM PITT during twenty-four years.* By THOMAS BARNES, M.D. Physician to the Fever Hospital and Public Dispensary at Carlisle, &c.

(Read 1st Feb. 1830.)

THE Royal Society of Edinburgh having taken great interest in meteorological observations, it has occurred to me, that the accompanying Meteorological Journals would be acceptable to the Society. I therefore transmit them, in the hope that they may be of some service, in promoting the laudable object of the Society, the science of meteorology.

These journals include a period of twenty-four years, and were kept by the late Mr PITT of Carlisle, who was long a careful and accurate observer of many atmospherical phenomena. Mr PITT did not avail himself of the new instruments that are used in meteorology, but understood well the nature and application of those he employed. The thermometer, barometer, and rain-gauge, were the instruments he made use of, and they are probably more important than any other. For many years Mr PITT had no particular occupation, and meteorology was his hobby. He devoted a great portion of his time to astronomical and meteorological observations, took great delight in keeping his journals, and was scrupulously accurate. From my personal knowledge of his diligence, of his habits of making correct observations, and the systematic fidelity with which he recorded them, I think I can with great safety vouch for the accuracy of the statements contained in his journals.

These meteorological journals were commenced on the 1st of January 1801, and regularly continued up to the end of December 1824. Observations were made of the thermometer, barometer, quantity of rain, direction and force of the wind, clouds, and the appearance of the sky. These are followed with general remarks on the state of the weather, the occurrence of thunder, of meteors, and of the aurora borealis. In some places there are added the appearance of the country, the height of the neighbouring rivers, the progress of vegetation, and the migration of birds. The state of the barometer and thermometer, and some other phenomena, were regularly observed and entered in the journal three times a-day, with a mechanical exactness. Mr PITT was seldom absent from home; and whenever any unavoidable circumstance obliged him to go to a distance, he always appointed a confidential person to take the observations for him.

At the end of each month, the observations are summed up, the means of each of the three daily observations of the thermometer and barometer are given; the quantity of rain stated; the number of west and east winds; the number of wet days; the highest and lowest degrees of temperature; the mean temperature of all the observations; the highest and lowest state of the barometer; and the mean height of the barometer of all the daily observations are mentioned.

At the end of each year, the yearly results are stated. We have the annual average height of the thermometer, the annual average height of the barometer, the annual quantity of rain, and the number of westerly and easterly winds.

The register contains a daily account of the direction and force of the wind. In the monthly and annual summaries, the winds are arranged into two classes, which are called East and West winds. Mr PITT began with the W. and went round by the S. to the E., and all the winds between these two points he classed with the west winds. He then reckoned from E. to W., and classed the NE. N. and NW. and all the winds from the in-

intermediate points with the east. This classification, though it be not the best, and may be regarded as fanciful and arbitrary, contains a good general division of the winds. It would not be difficult to look over the register, and make any other arrangement that might be thought better. No instrument has been used to measure the force of the wind. Mr PITT has contented himself with a verbal description of it. The winds, it may be proper to state, were registered from the weathercock of the Carlisle cathedral.

During the first three years of the journals, Mr PITT has given daily observations of the state of the hygrometer. Not being aware what instrument he used, I am not able to say any thing respecting it, except from the imperfect state of hygrometers at that period, little or no dependence, I think, can be placed on his observations. If Mr PITT had considered his hygrometer a good one, he would in all probability have continued to use it, and would have entered his observations in the journals.

The description of the appearances of the sky and clouds, is vague and unsatisfactory. Had Mr PITT availed himself of Mr HOWARD'S ingenious nomenclature of clouds, this part of the register would have been more explicit and definite. Mr PITT had probably commenced his observations before the publication of Mr HOWARD'S *Natural History of Clouds*, or before he became acquainted with Mr HOWARD'S nomenclature, and found great difficulty in adapting it to his register.

In order to render the accompanying Journals more intelligible and interesting, it may be proper to give some account of the situation of Carlisle, and the instruments Mr PITT employed.

Carlisle, the county town of Cumberland, is situate on a gentle rise near the conflux of three rivers, the Eden, the Caldew, and the Peterill, and has a fine champagne country stretching out on each side. Its latitude is $54^{\circ} 53' 33''$ N., and longi-

tude $2^{\circ} 57' 30''$ West of Greenwich. The river Eden runs on the east side of the city towards the north, and the Caldew on the west, towards the north, where they unite. The Peterill joins the Eden a little way above the city, towards the south-east. The high mountains of Cumberland are between twenty and thirty miles distant from Carlisle. Skiddaw lies to the SW. and Cross Fell to the SE. Mr PITT resided and took his observations at Shaddongate, which is in the suburbs of Carlisle, and stands on ground rather lower than the city, SW. of Carlisle Castle. Its height above the level of the sea is about 40 feet, and its distance from the sea twelve miles.

Mr PITT was in possession of several thermometers and barometers, which were of a superior kind, and he prided himself much upon their goodness. Though he generally examined them all every day, the observations in his journals were usually made from one thermometer and one barometer.

The thermometer he used latterly was made by CHARLES AIANO. It has been constructed and graduated with great care, and has REAUMUR'S scale on one side, and FAHRENHEIT'S on the other. It hangs upon the garden-wall, in a glass cylinder, which is open at each extremity. It is not in contact with the wall, and is sheltered from the heavens, and the falling vapours. It is placed in a north-eastern aspect, about six feet from the ground. A good situation has been chosen for the instrument. There is at all times a free circulation of air, and it is so placed as to be in the shade the whole day, and cannot be influenced by reflected heat.

The barometer was made by NAIRNE, London, and has an open and capacious cistern. The column of mercury seems very free from air and moisture. It hangs in the stair-case, in a perpendicular position, about twelve feet from the ground, and equally free from the sun's rays and the effects of artificial heat. The temperature of the situation is not liable to any great or

sudden variation, so as to have much influence on the instrument, though Mr PITT, I have reason to know, always made the necessary corrections for the capacity of the cistern and the temperature of the mercury.

During the first six or eight years of these journals (for I have not been able to ascertain the exact period), the hours of registering the thermometer and barometer, in the winter months, viz. January, February, March, November, and December, were 8 o'clock in the morning, 1 at noon, and 10 at night. In the summer months, viz. April, May, June, July, August, September, and October, half-past 7, morning; half-past 1, noon; and half-past 10, night. Since then, the observations of the thermometer and barometer were made three times in the day, viz. at 8 o'clock A.M., 1 o'clock P.M., and at 9 o'clock P.M. These hours are perhaps not the best adapted to obtain the mean temperature and pressure of the atmosphere of a day, month, or year, nor is the form of the register the best calculated to elicit all the advantages of meteorological observations; yet a register containing three daily observations, regularly continued for twenty-four years, without the omission of a single day, or even a single observation, it is hoped, will not be found destitute of interest. It must afford a near approximation to the monthly and annual means, and will give pretty correctly the character of the climate and weather of Carlisle.

The Rain-gauge is a copper vessel, and consists of a funnel inserted into a tube, with a narrow communication, to prevent evaporation. The cylinder is four inches diameter, and the area of the funnel is ten times that of the cylinder, consequently, when there is ten inches of rain in the cylinder, it is one inch of surface. The rain-gauge stands in an open situation upon the garden-wall, about twelve feet above the surrounding ground. The water in the gauge, as appears from the registers, was not measured at regular periods. He measured it more frequently, when he thought it was likely to suffer diminution by evaporation.

In an abstract of the Journal for 1801 *, which was the first year of this series, Mr PITT states, that “ the barometer and thermometer used in keeping this Journal was made by Messrs JONES, Holborn, London. The barometer is of the Torricellian construction ; its scale is not full inches, but something less, owing to the rising and falling of the surface of the reservoir ; the nonius moves by a key, placed in front of the barometer, and it has a floating-gauge, for the purpose of adjusting it to its proper height. The thermometer is divided into half degrees, and is properly graduated. The times of registering were 8 o'clock in the morning, 1 at noon, and 10 at night in the winter months, and half-past 7, half-past 1, and half-past 10 in summer. The rain-gauge is a tin vessel ; the trunk is to the funnel as 9 to 1, and has a floating-index to ascertain the quantity.” At what time he discontinued the use of these instruments, and began to use the present ones, I have not been able to learn ; but I have no doubt that he would take great care to have them constructed and graduated in such a manner as not to affect the continuity and correctness of his journals. Mr PITT, I know, was in the habit of verifying the accuracy of the instruments he used, by comparing them with other instruments made by the best artists.

METEOROLOGICAL RESULTS.

THE results of the Meteorological Journals for twenty-four years, I have arranged into the subsequent Tables. To Mr TAYLOR of Carlisle, I beg to express my obligation for his kind assistance in calculating some of the averages. Should the Jour-

* Monthly Magazine, vol. xiii. p. 8. A brief abstract of the journal was published annually in the Monthly Magazine.

nals and the Tables be found useful in promoting the advancement of the science of Meteorology, I shall feel highly gratified, by having contributed my mite to so desirable an object.

It is not improbable that these meteorological journals might be made useful and valuable, by comparing them with similar journals kept at the same time by other observers, at different and distant places. They would shew the agreement and difference of atmospheric phenomena in different regions of the earth; and perhaps important conclusions may be drawn from their comparison. As I have had few opportunities of examining journals of this kind, I shall not offer any opinion respecting them, neither shall I at present attempt to draw any conclusions from the comparisons I have made. I shall merely observe, that I have met with some instances of remarkable simultaneous fluctuations of the barometer, occurring in places at a considerable distance from one another. Among them, the following may be mentioned. On the 30th of November 1816, the barometer at Carlisle stood uncommonly high. According to the register, it was as high as 30,77, morning; 30,77, afternoon; and 30,80, night,—wind north-west. On the same day, at Edinburgh, there was the greatest elevation of the barometer that had been observed for several years. The mercury, 135 feet above the level of the sea, stood at 30,640 in the morning, and 30,602 in the evening,—wind west*. On the night of the 4th of March 1818, the barometer at Carlisle was unusually low. It was as low as 28,24; the following morning 28,43; in the afternoon 28,60; and at night, 28,81,—wind south-west. The weather had been very stormy, with violent hurricanes, and heavy showers of hail and snow for several days. A hurricane occurred during that night. At Edinburgh, there was similar weather, with hurricanes; and on the 5th of March, at 8 o'clock of the morning, the barometer

* Edinburgh Encyclopædia, vol. xiv. p. 162.

stood at 27,970,—wind south-west. This was the greatest depression of the barometer that had been observed there for many years *. On the 8th and 9th of January 1820, the barometer stood extremely high at Carlisle, and also at London. At Carlisle, on the morning of the 8th, it stood at 30,74; in the afternoon, 30,80; and at night, 30,87. The following morning, 30,94; afternoon, 30,86; night, 30,75. At London †, on the morning of the 8th of January, the barometer was at 30,42; in the afternoon, 30,44; at night, 30,52. On the morning of the 9th, 30,59; afternoon, 30,51; night, 30,32. The mercury had risen at Carlisle at the afternoon observation of the 8th, $\frac{6}{100}$ th of an inch; and at night $\frac{7}{100}$ ths more. At London, it had risen $\frac{2}{100}$ ths in the afternoon, and $\frac{8}{100}$ ths more at night. It rose exactly $\frac{7}{100}$ ths of an inch during the night of the 8th at both places; and fell $\frac{8}{100}$ ths of an inch at both places in the forenoon, which are striking coincidences. The barometer had fallen $\frac{11}{100}$ ths of an inch at the night observation at Carlisle, and $\frac{19}{100}$ ths of an inch during the same time at London;—wind north-east on both days, at both places. The extraordinary height of 30,94, which the barometer attained on the morning of the 9th of January 1820, is higher than has been observed at Carlisle at any other period of the register. On comparing Mr PITT'S journal with Mr DANIELL'S, I find that the barometers used at Carlisle and London generally rose and fell with great regularity at the same time, sometimes in the same ratio, and that the maxima and minima results were often on the same day.

On the 25th of December 1821, a very great depression of the barometer took place at Carlisle. It was so low as 28,26, both in the morning and in the afternoon, and 28,35 at night. It appears that there was a remarkable fall of the barometer,

* Edinburgh Encyclopædia, vol. xiv. p. 162.

† Meteorological Essays and Observations, by J. F. DANIELL, F.R.S. p. 400.

on the same day, both at Geneva and throughout all Scotland*. At the same time, a corresponding fall of the barometer was also observed at London †. During the latter part of November and the first three weeks of December 1821, Carlisle was visited by several violent hurricanes, accompanied with heavy showers of hail, and torrents of rain. On the 18th of December, there was a dreadful thunder-storm, and extremely vivid lightning, followed by hail and rain. On the 20th, a violent hurricane, with heavy rain in the night. During the three or four following days, there were several showers of hail and rain, and snow upon the neighbouring mountains. On the 25th, the day on which the greatest depression of the barometer occurred, the weather was fair and pleasant, and continued fair, mild and pleasant until the end of the month. The average of the barometric pressure of this month, 29,321, is the lowest monthly average in the journals. The average temperature of the month, 42°,1, is higher than the December average of any other year, excepting December 1806, when it was 43°,5. The average height of the barometer of December 1806, was 29,377, which is the next lowest average for December. The barometer also sunk so low as 28,48 in December of this year; and there was great similarity of weather during the month,—a violent storm of thunder, lightning, hurricanes, and showers of hail and rain. The minimum of the barometer occurred on the 2d of December,—wind north-west. During the thunder-storm which took place on the 13th, the barometer stood at 28,55,—wind south. In the intervening days, the mercury was comparatively low. In 1821, the thermometer ranged from 55° to 30°, in the month of December, and the barometer from 30,23 to 28,26. In December 1806, the range of the thermometer was from 54° to 26°, and of the barometer from 30,48 to 28,48.

* Edinburgh Philosophical Journal, vol. vi. p. 383.

† Meteorological Essays, &c. by J. F. DANIELL, p. 416.

TABLE I.

EXHIBITING THE MAXIMUM AND MINIMUM TEMPERATURE OF EACH MONTH FOR 24 YEARS.

Years.	JAN.		FEB.		MARCH.		APRIL.		MAY.		JUNE.		JULY.		AUG.		SEPT.		OCT.		NOV.		DEC.	
	Max.	Min.	Max.	Min.	Max.	Min.	Max.	Min.	Max.	Min.	Max.	Min.	Max.	Min.	Max.	Min.	Max.	Min.	Max.	Min.	Max.	Min.	Max.	Min.
1801,	51°	25°	54°	30°	60°	28°	68°	28 ¹ / ₂ °	68°	36°	70°	32 ¹ / ₂ °	78°	43°	75°	49°	71°	36°	64°	33°	55°	20 ¹ / ₂ °	44°	17 ¹ / ₂ °
1802,	52	12	51	24	58	25	59	34	80	28	65	44	65	45	78	51	71	40	65	35	52	20	51	23
1803,	48	18	50	23	61	24	73	32	68	37	75	41	81	48	81	41	68	32	63	34	52	24	54	8
1804,	55	5	49	18	59	21	64	29	70	39	77	47	77	50	76	50	75	40	63	33	54	27	47	7
1805,	47	23	48	22	55	30	63	37	69	34	70	38	77	53	72	54	76	40	63	23	57	20	52	21
1806,	50	25	51	17	52	21	64	32	72	40	71	43	70	52	75	48	67	40	62	26	56	34	54	26
1807,	49	17	54	21	52	22	71	25	85	36	68	47	73	50	74	50	64	33	65	32	51	18	50	16
1808,	50	17	52	24	51	27	56	25	72	47	76	48	84	46	71	40	67	30	58	31	57	25	52	17
1809,	45	14	50	29	54	30	57	27	76	34	70	39	76	51	70	51	68	33	61	36	51	20	51	31
1810,	51	18	53	14	52	25	68	35	71	27	78	42	71	49	74	49	73	44	66	31	51	28	51	22
1811,	49	18	50	24	57	31	68	26	78 ¹ / ₂	40	77	43	76	50	69	50	73	43	65 ¹ / ₂	34	57	32	53	20
1812,	50	10	52	32	53	23	51	30	72	35	76	46	68	47	68	47	64	38	60	33	53	20	48	15
1813,	50	25	52	34	54	26	64	31	66	42	73	48	73	48	65	42	63	38	59	27	54	24	50	20
1814,	41	-2	47	20	56	24	65	35	62	34	67	38	78	47	69	42	69	37	61	30	53	18	55	21
1815,	45	13	51	31	60	32	73	31	68	44	76	47	68	46	70	47	71	38	60	40	55	13	49	2
1816,	49	21	50	10	50	23	63	28	63	35	71	42	71	44	65	46	62	35	60	36	52	18	49	25
1817,	54	24	50	32	50	22	60	24	62	39	81	43	65	48	62	43	75	35	54	28	57	34	50	16
1818,	52	27	51	18	50	32	60	31	71	41	79	48	79	48	76	43	68	40	65	40	59	36	53	26
1819,	52	30	50	25	57	30	59	34	66	34	64	46	76	47	77	50	68	37	66	22	52	20	53	3
1820,	47	0	52	25	55	11	70	34	73	30	80	42	74	45	66	40	74	37	56	32	55	30	55	29
1821,	55	12	50	24	52	27	71	32	62	32	69	40	76	39	78	50	73	50	63	33	58	30	55	30
1822,	48	24	54	33	53	32	70	35	70	36	80	48	71	46	72	47	66	37	60	35	57	32	46	22
1823,	45	11	48	12	54	25	56	31	71	38	64	39	64	44	66	43	66	35	61	28	54	27	51	24
1824,	52	25	50	28	55	25	68	25	72	30	78	41	75	48	70	41	75	29	63	26	58	25	52	15

The Maximum Temperature that has taken place during 24 years, was at the noon observation of May 25. 1807; thermometer then stood at 85°. In the general remarks for this day, it is stated, the weather was intensely hot; there was distant thunder, and a continued flame of lightning all night.

The Minimum Temperature during 24 years, took place on the morning of January 17. 1814; the thermometer was then 2° below zero, — 2°. Among the general remarks, it is stated, that, at this time, there occurred the most severe frost on record. The thermometer was unusually low during the whole of the month, but particularly on the 4th, 8th, 13th, 17th and 20th. On the morning of the 4th, the thermometer was at 10°, and in the evening at 11°. On the morning of the 8th, it was at 10°, and in the evening at 9°. On the 13th, morning at 15°, and at night 5°. On the 17th, 2° below zero; morning; 14° at noon; and 3° at night. On the 20th, it was 15° in the morning, and 10° at night.

The average temperature of the whole month, 24°47', is the lowest monthly mean temperature during the whole period of the journal.

TABLE II.

CONTAINING THE MEAN TEMPERATURE OF EACH MONTH FOR 24 YEARS, AND THE ANNUAL MEAN TEMPERATURE OF EACH YEAR.

Years.	Jan.	Feb.	March.	April.	May.	June.	July.	Aug.	Sept.	Oct.	Nov.	Dec.	Mean Temp. of each year.
1801,	40,8	41	43,7	46,6	53,1	55,8	59,7	60,8	55,5	49,5	39,8	33,6	48,3
1802,	35,4	37,03	42,48	47,1	50,3	54,8	55,63	61,63	55,93	50,63	41,07	38,47	47,54
1803,	35,17	38,06	42,71	47,15	50,32	55,56	63,40	60,00	52,25	48,55	39,10	37,20	47,456
1804,	41,3	36,9	39,89	43,3	55,7	60,32	60,07	59,4	58,1	51,6	42,7	34,6	48,656
1805,	36,5	38,2	43,67	47	50,66	55,4	61,4	60,78	57,67	45	40,5	38,8	47,965
1806,	37,70	38,37	40,70	45,70	53,40	56,90	59,50	59,38	55,40	51,08	45,70	43,50	48,944
1807,	37,83	37,84	36,24	44,95	51,96	56,05	60,40	61,22	48,20	51,51	35,29	36,08	46,464
1808,	37,4	37	37,43	41,51	55,4	59	64	61,2	53,92	43,92	41,46	36,53	47,8406
1809,	32,6	41	42,95	41,21	54,7	55,07	59,35	57,91	53,6	51,22	40,41	39,83	47,4875
1810,	36,9	37,62	38,7	46,68	48,4	59,35	59,28	59,02	56,29	48,4	39,6	38,2	47,37
1811,	34,98	39,3	43,7	47,5	54,8	57,22	60,6	57,67	55,25	53,4	46,12	37,37	49,00
1812,	36	41,05	36,65	40,97	51,3	55,8	56,81	57,3	54,4	48,5	40,2	34,72	46,142
1813,	35,8	42,41	44,5	45,1	51,4	56	58,15	56,24	53,20	44,72	39,23	37,24	47
1814,	24,47	35	38,21	48,7	47,18	53,32	59,5	57,74	55,7	45,85	40,07	38,1	45,32
1815,	32,85	42,71	43,6	46,8	53,7	57	58	58	55,3	50	36,86	34,08	47,4
1816,	36,4	35,6	37,4	42,4	48,87	53,68	55,3	55,7	51,4	48,86	38,6	36,8	45,085
1817,	40	41,8	40,43	48,1	47	57,8	56,6	55	55	41,3	47,33	35	47,12
1818,	39,3	36,7	38,63	42,4	53	60,3	62,1	57,2	54,1	53,4	48,55	40,06	48,812
1819,	39,53	38,5	43,05	46,5	52,3	54,8	60	63,3	54,5	46,6	37,5	32	47,4
1820,	30,4	38,20	38,40	47,60	51,10	54,70	59,20	56,5	53,3	45,4	41,8	40,8	46,42
1821,	38,2	37	40,8	48,4	47	54	57,1	59,8	57	50	45,4	42,1	48,06
1822,	40	42,45	44	46	53,4	61,14	58,5	58,3	52	49,5	45,8	36	49
1823,	31,7	35,6	40,4	43	52,7	52,3	56	55,3	53	45,5	45,1	40	45,9
1824,	40,50	40,00	39,80	45,60	53,00	56,00	59,70	57,80	55,60	48,00	42,50	40,00	48,21

The annual means of the thermometer for 24 years, divided into periods of six and twelve years each, give the following results :

The average or mean temperature of the first six years, viz. 1801, 1802,	
1803, 1804, 1805, 1806,	48,1435
The mean temperature of the second six years, viz. 1807, 1808, 1809, 1810,	
1811, 1812,	47,3336
The mean temperature of the third six years, viz. 1813, 1814, 1815, 1816,	
1817, 1818,	46,7895
Mean temperature of the last six years, viz. 1819, 1820, 1821, 1822, 1823,	
1824,	47,4983
Mean temperature of the first twelve years, ending 1812,	47,7635
Mean temperature of the last twelve years, ending 1824,	47,144
Mean temperature of the twenty-four years,	47,4537

TABLE III.—CONTAINING THE MAXIMUM AND MINIMUM HEIGHT OF THE BAROMETER OF EACH MONTH FOR 24 YEARS.

Years.	JANUARY.		FEBRUARY.		MARCH.		APRIL.		MAY.		JUNE.		JULY.		AUGUST.		SEPTEMBER.		OCTOBER.		NOVEMBER.		DECEMBER.	
	Max.	Min.	Max.	Min.	Max.	Min.	Max.	Min.	Max.	Min.	Max.	Min.	Max.	Min.	Max.	Min.	Max.	Min.	Max.	Min.	Max.	Min.	Max.	Min.
1801,	30,14	29,07	30,19	28,96	30,33	28,66	30,43	29,22	30,21	29,57	30,25	29,83	30,17	29,37	30,34	29,6	30,32	29,48	30,27	28,91	30,17	28,98	30,16	28,65
1802,	30,32	28,54	30,27	29,13	30,57	28,98	30,35	29,34	30,38	29,54	30,34	29,25	30,20	29,06	30,31	29,44	30,83	29,03	30,40	29,06	30,20	29,09	30,35	28,97
1803,	30,43	29,00	30,37	29,00	30,53	29,55	30,51	29,01	30,41	29,00	30,55	29,60	30,44	29,81	30,32	29,32	30,47	29,29	30,44	29,45	30,48	28,45	30,39	28,89
1804,	30,18	28,65	30,57	28,95	30,10	28,96	30,25	29,17	30,40	29,43	30,42	29,44	30,33	29,35	30,37	29,26	30,55	29,76	30,10	29,12	30,55	29,33	30,65	28,79
1805,	30,28	28,61	30,30	28,82	30,30	29,38	30,33	29,52	30,42	29,02	30,42	29,25	30,24	29,22	30,25	29,21	30,66	29,00	30,53	29,37	30,81	28,97	30,33	28,64
1806,	29,93	28,20	30,26	29,11	30,43	29,06	30,49	29,39	30,48	29,03	30,48	29,18	30,16	29,42	30,10	29,10	30,27	29,54	30,31	28,82	30,25	28,78	30,48	28,48
1807,	30,71	28,85	30,68	28,88	30,66	28,93	30,25	28,92	30,52	28,88	30,33	29,44	30,30	29,48	30,21	29,53	30,20	29,08	30,16	29,20	30,23	28,67	30,36	28,80
1808,	30,50	28,74	30,86	29,20	30,54	29,55	30,28	28,82	30,23	29,44	30,34	29,60	30,23	29,60	30,27	29,30	30,36	29,38	30,43	28,77	30,40	28,77	30,35	28,93
1809,	30,11	28,46	30,40	28,50	30,50	29,18	30,54	28,85	30,32	29,41	30,57	29,60	30,28	29,63	29,94	29,37	30,15	29,20	30,32	29,76	30,48	28,12	30,04	28,07
1810,	30,36	29,70	30,45	28,86	30,14	28,95	30,28	29,24	30,43	29,47	30,44	29,76	30,17	29,36	30,27	29,34	30,48	29,60	30,44	28,88	30,38	28,90	30,70	28,67
1811,	30,59	28,90	30,22	28,80	30,67	29,10	30,16	29,10	30,33	29,37	30,42	29,35	30,30	29,60	30,31	29,47	30,44	29,01	30,25	28,77	30,45	29,06	30,32	28,95
1812,	30,35	28,85	29,95	29,00	30,42	29,11	30,27	29,30	30,34	29,31	30,53	29,17	30,51	29,37	30,30	29,62	30,31	29,75	29,94	28,13	30,35	29,28	30,63	29,25
1813,	30,58	29,75	30,47	28,66	30,53	29,45	30,49	28,75	30,13	29,27	30,41	29,60	30,32	29,41	30,46	29,54	30,48	28,97	30,41	28,81	30,33	29,03	30,51	29,01
1814,	30,30	28,75	30,45	29,12	30,58	28,72	30,34	29,15	30,64	29,60	30,46	29,71	30,28	29,56	30,47	29,37	30,48	29,45	30,41	29,14	30,26	29,12	30,21	28,72
1815,	30,51	29,00	30,47	29,16	30,35	28,71	30,45	29,21	30,33	29,38	30,37	29,47	30,35	29,65	30,34	29,48	30,28	29,33	30,45	28,95	30,71	28,71	30,51	28,75
1816,	30,37	28,71	30,37	29,17	30,38	28,96	30,27	29,15	30,24	29,33	30,17	29,36	29,92	29,16	30,26	29,41	30,24	29,03	30,17	29,24	30,80	28,75	30,71	28,58
1817,	30,57	28,43	30,61	29,22	30,45	28,51	30,74	29,84	30,37	29,17	30,33	29,09	30,11	29,20	30,17	29,03	30,27	28,87	30,47	28,91	30,54	29,23	30,16	28,57
1818,	30,37	28,96	30,25	28,90	30,52	28,24	30,62	29,05	30,51	29,33	30,51	29,40	30,37	29,74	30,37	29,57	30,28	29,27	30,37	29,21	30,27	29,40	30,71	29,31
1819,	30,51	28,77	30,10	28,94	30,32	29,15	30,28	29,07	30,20	29,66	30,31	29,32	30,36	29,38	30,46	28,91	30,61	29,30	30,40	29,35	30,30	29,12	30,31	29,01
1820,	30,94	28,82	30,42	29,36	30,52	28,80	30,75	29,23	30,37	29,11	30,48	29,27	30,31	29,34	30,24	29,37	30,36	29,30	30,66	28,60	30,38	29,41	30,31	29,60
1821,	30,84	29,04	30,77	29,33	30,31	29,00	30,20	28,79	30,30	29,15	30,53	29,70	30,35	29,36	30,30	29,12	30,21	29,11	30,33	28,74	30,25	28,77	30,23	28,26
1822,	30,35	29,43	30,65	28,70	30,53	29,10	30,46	29,14	30,44	29,56	30,37	29,72	30,20	29,43	30,25	29,35	30,41	29,43	30,06	29,07	30,13	28,65	30,65	28,47
1823,	30,31	28,91	30,40	28,76	30,51	28,77	30,44	29,10	30,51	29,17	30,41	29,32	30,21	29,34	30,14	29,37	30,35	29,11	30,46	28,75	30,66	29,03	30,39	28,65
1824,	30,67	28,62	30,50	28,90	30,30	28,61	30,58	29,10	30,66	29,61	30,47	29,40	30,53	29,43	30,48	29,42	30,32	29,20	30,21	29,00	30,13	28,33	30,33	28,66

The maximum height of the Barometer during 24 years, took place in the morning of January 9, 1820; wind NE.; thermometer 25°, 30,94 inches. During the early part of this month, the thermometer was remarkably low. On the morning of the 1st, it was as low as 3°; at noon 14°; and at night 10°. On the 3d, in the morning, 2°; at noon, 20°; and at night, 7°. On the morning of the 22d, the thermometer was at zero, the lowest temperature that has occurred during the period of the register, with the exception of January 17, 1824. The barometer fluctuated between 30,94 and 28,82.

The minimum height of the barometer during 24 years, took place in the morning of December 15, 1809; wind S.; thermometer 36°, 28,07 inches. For two or three days preceding the 9th of this month, the weather was stormy, the wind S. violent and strong. In the night of the 9th, there was a hurricane from the south; barometer stood 28,83. In the night of the 14th, another hurricane came on from the south, and continued on the morning of the 15th, when the barometer was at 28,07. The words in the register are, "a dreadful hurricane, with heavy snow and sleet till noon, moderate afterwards. In the night, much lightning, which was extraordinarily vivid." The barometer fluctuated between 30,04 and 28,07.

TABLE IV.—SHEWING THE MEAN HEIGHT OF THE BAROMETER EACH MONTH DURING 24 YEARS, AND THE ANNUAL MEAN OF EACH YEAR.

Years.	Jan.	Feb.	March.	April.	May.	June.	July.	August.	Sept.	Oct.	Nov.	Dec.	Barometric mean of each month.
1801,	29,71	29,70	29,71	30,02	29,85	30,03	29,81	30,08	29,91	29,71	29,64	29,38	29,796
1802,	29,83	29,65	29,97	29,83	30,05	29,74	29,72	29,94	29,98	29,67	29,73	29,70	29,8175
1803,	29,766	29,782	30,052	29,809	29,903	29,998	30,135	30,010	30,121	30,070	29,500	29,595	29,895
1804,	29,512	30,09	29,66	29,763	29,871	30,0817	29,858	29,853	30,132	29,644	29,935	29,906	29,8619
1805,	29,632	29,721	29,86	29,88	29,937	29,859	29,859	29,853	29,907	29,95	30,2	29,579	29,859
1806,	29,345	29,679	29,750	30,123	29,990	30,064	29,772	29,753	29,952	29,855	29,590	29,377	29,7706
1807,	29,94	29,631	30,03	29,874	29,833	29,9787	29,858	29,843	29,742	29,794	29,491	29,816	29,8192
1808,	29,704	30,07	30,20	29,82	29,86	29,96	29,951	29,838	29,842	29,632	29,82	29,804	29,875
1809,	29,516	29,613	30,090	29,868	29,908	29,905	29,932	29,692	29,706	30,150	29,988	29,438	29,817
1810,	30,086	29,777	29,681	29,8453	29,97	30,12	29,782	29,865	30,0617	29,93	29,50	29,6573	29,8563
1811,	29,856	29,405	30,083	29,75	29,794	29,91	30,032	29,875	29,986	29,587	29,862	29,631	29,81425
1812,	29,818	29,53	29,811	29,972	29,887	29,932	29,969	30,0453	30,04	29,407	29,842	30,012	29,856
1813,	30,067	29,59	30,114	29,976	29,767	30,074	29,87	30,105	30,034	29,714	29,688	29,84	29,903
1814,	29,646	30,02	29,807	29,837	30,087	30,0873	29,923	29,91	30,091	29,80	29,676	29,631	29,8763
1815,	29,90	29,71	29,618	29,964	29,895	29,892	30,091	29,88	29,933	29,823	29,966	29,74	29,8676
1816,	29,60	29,80	29,748	29,75	29,86	29,94	29,66	29,933	29,857	29,82	29,744	29,628	29,78
1817,	29,697	29,77	29,676	30,31	29,783	29,84	29,77	29,677	29,97	30,04	29,865	29,55	29,83
1818,	29,63	29,615	29,453	29,778	30,00	30,02	30,065	30,097	29,75	29,846	29,80	30,04	29,841
1819,	29,621	29,56	29,89	29,818	29,953	29,88	30,04	30,054	29,95	29,87	29,74	29,71	29,84
1820,	29,863	29,98	29,88	30,00	29,74	29,955	29,97	29,80	29,935	29,60	29,861	29,943	29,877
1821,	29,874	30,247	29,56	29,61	29,863	30,17	29,923	29,933	29,68	29,827	29,64	29,321	29,804
1822,	30,08	29,87	29,843	29,94	30,02	30,101	29,83	29,858	29,98	29,60	29,534	30,03	29,89
1823,	29,72	29,37	29,72	29,87	29,85	29,916	29,74	29,807	29,90	29,70	30,06	29,58	29,77
1824,	30,00	29,80	29,79	29,88	30,02	30,00	29,99	29,92	29,86	29,61	29,49	29,62	29,83

The annual mean heights of the barometer of each year for 24 years, divided into periods of six and twelve years, similar to the annual means of the Thermometer, give the following results:

The average or mean height of the barometer of the first six years, ending 1806, 29,8333 inches.

The mean height of the second six years, ending 1812, 29,8396

Mean height of the third six years, ending 1818, 29,8496

Mean height of the last six years, ending 1824, 29,8351

Mean height of the first twelve years, ending 1812, 29,8364

Mean height of the last twelve years, ending 1824, 29,8423

Mean height of 24 years, 29,8393

TABLE V.—EXHIBITING THE QUANTITY OF RAIN OF EACH MONTH FOR 24 YEARS, AND THE ANNUAL QUANTITY OF EACH YEAR.

Years.	Jan.	Feb.	March.	April.	May.	June.	July.	August.	Sept.	Oct.	Nov.	Dec.	Annual quantity of each year.
	Inches.	Inches.	Inches.	Inches.	Inches.	Inches.	Inches.	Inches.	Inches.	Inches.	Inches.	Inches.	Inches.
1801,	3,000	2,456	2,874	0,862	1,931	0,325	5,627	0,908	4,804	4,702	1,496	2,481	31,466
1802,	1,970	2,623	0,840	2,566	0,470	2,343	5,308	2,509	2,344	4,420	0,670	2,441	28,504
1803,	1,042	3,556	1,472	1,980	2,940	2,524	0,755	3,694	2,322	2,030	2,450	2,775	27,520
1804,	5,335	1,995	2,400	1,885	2,475	2,660	3,275	6,270	1,010	5,500	2,040	1,000	35,845
1805,	1,950	2,455	2,300	0,630	1,740	2,380	5,060	3,130	2,170	0,470	0,460	3,610	26,355
1806,	3,26	2,10	0,77	0,89	1,47	1,26	3,21	5,57	3,50	1,25	5,32	2,94	31,54
1807,	0,80	3,17	0,76	1,88	2,41	1,59	2,45	1,93	5,37	3,36	2,53	1,50	27,75
1808,	2,10	1,57	0,20	1,20	2,86	0,82	3,90	4,48	1,84	3,95	3,06	1,88	27,86
1809,	3,50	2,53	0,56	1,20	3,75	2,85	1,84	5,19	4,95	0,38	1,84	3,18	31,77
1810,	1,84	1,22	3,80	1,01	0,53	1,60	3,24	3,22	1,70	3,12	3,15	4,30	28,73
1811,	1,30	3,80	2,20	1,60	6,02	2,25	2,40	2,88	2,35	2,47	4,00	3,26	34,53
1812,	1,41	4,62	2,75	1,12	1,71	2,81	1,61	2,58	2,91	2,72	2,02	0,61	26,87
1813,	2,02	3,67	0,81	1,68	4,01	1,00	3,11	1,08	1,98	3,12	2,23	0,97	25,68
1814,	0,44	1,12	0,93	4,31	0,51	1,50	3,61	2,09	0,96	3,01	4,16	4,92	27,56
1815,	0,82	1,54	4,05	0,86	3,86	3,13	1,66	2,54	3,38	3,77	2,22	3,93	31,76
1816,	1,85	0,78	1,88	1,38	2,31	1,51	4,57	1,33	3,32	2,36	2,04	2,44	25,77
1817,	1,57	3,20	2,13	0,31	2,71	3,06	3,64	5,71	1,46	1,17	2,80	2,75	30,51
1818,	3,51	1,67	6,10	2,56	1,11	1,75	4,11	1,85	3,66	3,49	3,30	1,60	34,71
1819,	3,62	3,10	1,58	1,68	1,87	2,11	3,66	1,60	2,27	5,15	3,28	3,34	33,26
1820,	2,25	1,80	2,47	1,00	3,40	3,64	2,02	4,01	3,11	2,45	1,60	2,42	30,17
1821,	1,65	0,75	3,68	2,74	1,26	1,11	1,55	1,74	3,45	4,67	4,70	4,63	31,93
1822,	1,53	2,87	4,01	1,90	1,34	1,05	5,33	5,33	1,33	4,06	4,31	2,35	35,38
1823,	2,68	2,02	1,96	1,64	4,61	1,57	5,12	5,18	3,80	2,84	1,62	2,47	35,51
1824,	1,63	0,77	2,50	0,85	1,23	2,23	2,55	2,95	3,85	3,01	5,53	5,63	32,73
Total,	51,077	55,385	53,026	37,433	56,526	47,072	79,605	77,771	67,840	73,472	66,826	67,427	733,71

The following are the mean results of the Fall of Rain during 24 years, divided into periods similar to those of the Thermometer and Barometer :

- The mean quantity of rain of the first six years, 1801—1806, 30,205 inches.
- Mean quantity of rain of the second six years, 1807—1812, 29,585
- Mean quantity of rain of the third six years, 1813—1818, 29,33
- Mean quantity of the last six years, 1819—1824, 33,163
- Mean quantity of the first twelve years, 1801—1812, 29,895
- Mean quantity of the last twelve years, 1812—1824, 31,246
- Mean for the first eighteen years, 1801—1818, 29,706
- Mean of twenty-four years, 1801—1824, 30,571

The highest annual mean height of the barometer that has occurred is 29,903. This was in the year 1813, and the quantity of rain during that year, 26,87 inches, was the least that has fallen in one year during the period of the journals.

The lowest annual mean of the barometer, 29,77, was in 1823, and the quantity of rain of that year, 35,51 inches, the greatest in the journal, except in the year 1804, when the quantity was 35,845; barometer 29,8619.

It may be remarked, that an unusually large quantity of rain fell at Carlisle during the last seven years.

The greatest fall of rain in one month during 24 years, took place in August 1804; mean barometric pressure of the month, 29,89, 6,270 inches.

The least fall of rain in one month during 24 years, was in March 1808; mean barometric pressure of the month 30,20, 0,20

TABLE VI.

SHewing THE QUANTITIES OF RAIN DURING THE 6 SUMMER AND 6 WINTER MONTHS OF EACH YEAR FOR 23 YEARS.

Years.	From beginning of April to end of September.	From beginning of October to end of March next following.	Years.	From beginning of April to end of September.	From beginning of October to end of March next following.
	Inches.	Inches.		Inches.	Inches.
1801,	14,457	14,112	1813,	12,860	8,810
1802,	15,540	13,601	1814,	12,980	18,500
1803,	14,215	16,965	1815,	15,430	14,430
1804,	17,575	15,245	1816,	14,420	13,740
1805,	15,110	10,670	1817,	16,890	18,000
1806,	15,900	14,240	1818,	15,040	16,690
Mean for } 6 years, }	15,466	14,139	Mean for } 6 years, }	14,603	15,028
1807,	15,630	11,260	Mean for } 18 years, }	15,139	14,568
1808,	15,100	15,480			
1809,	19,780	12,260			
1810,	11,300	17,870	1819,	13,190	18,290
1811,	17,540	18,510	1820,	17,180	12,550
1812,	12,740	11,850	1821,	11,850	22,410
Mean for } 6 years, }	15,348	14,538	1822,	16,250	17,380
			1823,	21,920	11,830
Mean for } 12 years, }	15,407	14,338	Mean for } 5 years, }	16,078	16,492
			Mean for } 23 years, }	15,344	14,986

The Average or Mean Quantity of Rain of each month for 24 years:

The mean quantity of rain of the month of January for 24 years, 2,128 inches.
February for do. 2,308
March for do. 2,209
April for do. 1,560
May for do. 2,355
June for do. 1,960
July for do. 3,317
August for do. 3,240
September for do. 2,827
October for do. 3,061
November for do. 2,784
December for do. 2,809

XXV. *On Mudarine, the Active Principle of the Bark of the Root of the Calotropis Mudarii, Buch.; and the singular influence of Temperature upon its solubility in Water.* By ANDREW DUNCAN, M. D., F. R. S. Ed. Professor of Materia Medica in the University of Edinburgh.

(Read 20th December 1830.)

TO the professional zeal and liberality of my lamented friend Dr ADAM, late Secretary to the Medical Board at Calcutta, I am indebted for many interesting specimens of the Materia Medica of Hindostan. Among these was a large supply of the powder of the bark of the Mudar or Mudhar, the *Calotropis Mudarii* of Dr HAMILTON, which, with a nearly allied species, had been formerly referred to the genus *Asclepias*, under the trivial name of *gigantea*.

The high reputation which the Mudar Powder enjoyed among the natives of India, as a specific for the cure of various cutaneous diseases, induced Mr PLAYFAIR, Mr ROBINSON, and Dr Vos, to investigate its action as a medicine. These gentlemen gave favourable reports of its effects in India, in cutaneous diseases, syphilitic affections, and tape-worm.

Dr ADAM was desirous that it should be tried in the diseases of this country, and that it should be subjected to chemical analysis, in order to ascertain the nature of its active constituent principles. I lost no time in proceeding with both investigations. The results of my first experiments were accordingly communicated to the public, in a paper published in the Edinburgh Medical and Surgical Journal in July 1829. Since that time, greatly

enlarged experience has satisfied me, that mudar possesses no specific virtue ; but that it is infinitely more valuable, from its common medicinal properties, which correspond in every respect, both in kind and in degree, with those of ipecacuan. Indeed, I have no doubt, that, from the facility with which any quantity may be supplied from the province of Bahar, the use of the Brazilian root may be altogether dispensed with in our East Indian settlements, and that mudar may even become, in a commercial point of view, a valuable export from Bengal to Europe. As such I feel myself justified in recommending it to the notice of the Honourable East India Company, and to the private merchants trading with India.

In the paper to which I have already alluded, I gave an account of the analysis of mudar, so far as I had then carried it. I merely indicated the singular property possessed by one of its constituents, *Mudarine*, which it is the object of this paper to explain more fully. In a note, I mentioned that I had discovered it to possess the very singular property of being very soluble in cold water, and gelatinizing when the solution was heated to 85° or 90° Fahrenheit.

Since that time I have frequently repeated and varied my experiments upon the mudar powder ; but I have not yet completed my general analysis, which, upon the whole, coincides with what I published from my first experiments in 1829. Having, however, satisfied myself that the principle to which I gave the name of *Mudarine* possesses a property which has not been observed in any other principle, organic or inorganic, and constitutes a very striking exception to the general law of the power of solvents being increased by increase of temperature, I have thought it deserving of being communicated to the Royal Society, and, through the medium of its Transactions, of being made known to scientific chemists; as it is not improbable that it is possessed, in a greater or less degree, by some other

organic principles, and that its discovery may lead to considerable modifications in our methods of analyzing organic substances.

Mudarine is very easily obtained, in a state of considerable purity, from the tincture of mudar, made by macerating the powder of the root in cold rectified spirit. The greater part of the spirit may be recovered by distillation, and the remaining solution, which acquires a much deeper colour, but remains perfectly transparent, is then allowed to cool. As the temperature declines, a white granular resin is deposited by a species of crystallization, from a transparent coloured solution. The whole is now allowed to dry spontaneously, that all the resin may congregate. The dry residuum is then treated by water, which dissolves the coloured portion, and leaves the resin untouched. It is to this principle, dissolved by cold water from the resinous extract, that I have given the name of Mudarine.

By exposure to the air, it dries readily, forming a mass of a pale-brownish colour, perfectly transparent and homogeneous in appearance, having no tendency to crystallize, but becoming full of cracks, diverging from the centre, exceedingly brittle, and having no adhesion to the capsule containing it, from which it peels off spontaneously. It has no smell, and is intensely bitter, with a very peculiar nauseating taste.

It is exceedingly soluble in cold water, at the ordinary temperature of the atmosphere. On the contrary, it is insoluble in boiling water. It is also soluble in alcohol, but the power of this solvent is increased by increase of temperature. It is insoluble in sulphuric ether, oil of turpentine, and olive-oil.

It is in the solution in water, when nearly saturated, that the peculiar property of mudarine is most easily exhibited.

At ordinary temperatures this solution is quite fluid and transparent. When heat is gradually applied, already at 74°, a change in its constitution begins to be observable, indicated by

a slight diminution of transparency and limpidity. As the temperature is raised, these changes increase, and at 90° it has in a great degree lost its transparency, and has acquired the consistence of a tremulous jelly.

If the heat be now withdrawn, and the vessel allowed to cool, the jelly gradually, but very slowly liquefies, so that a day or two elapses before it has entirely recovered its original limpidity and transparency.

If, instead of withdrawing the heat when it has risen to 90° , we continue to raise it, further changes occur.

At 95° it is fully gelatinized, and now there appears to be a separation taking place into two parts, a soft brownish coagulum and a liquid nearly colourless, not unlike the separation of the serum from the crassamentum of the blood, as it spontaneously contracts.

At 98° the coagulum is evidently contracted in size, while the fluid increases in proportion.

At 130° the coagulum seems to dissolve; probably, however, it only is reduced in size by contraction.

At 185° the coagulum is very small, and has a tenacious pitchy consistency.

At 212° little further change.

The alterations which in this state it undergoes on cooling, are next to be observed.

At 140° the fluid is very turbid. The coagulum has not diminished in size, and is now very hard and brittle.

At 110° fluid less turbid, coagulum remarkably brittle, with a resinous fracture.

At 100° , fluid more transparent, with thin detached pellicles on the surface. When cooled down, even to the freezing temperature, the coagulum remains unaltered, and very much resembles colophony; but, after the lapse of several days, it gra-

dually liquefies in the portion of fluid in contact with it, without passing through the intermediate form of a jelly.

The coagulum, when separated from the fluid, is a transparent brown mass, exceedingly brittle, not deliquescent, fragments angular, lustre resinous, taste bitter, nauseous, adhering to the teeth.

In this state it seems at first not to be soluble in distilled water, but after some days it is dissolved in it, with the same phenomena as in the fluid from which it was separated by boiling, and the solution has acquired its original properties. The dry *mudarine* is readily soluble in rectified spirit, and is not precipitated from the alcoholic solution by the addition of water. As long as any considerable proportion of spirit remains, it is not coagulated by increase of temperature, but, on allowing the spirit to evaporate by exposure to the air, it remains dissolved in the water, and has reacquired its original properties.

It would therefore seem that its tardy solubility, after being contracted, is owing to the state of increased aggregation, for when this is removed by alcohol, its solubility is quickly restored.

Mudarine is also extracted, by the action of cold water, from the powder, but it is not so easily separated from a gummy matter, also dissolved, as from the resin extracted along with it by rectified spirit.

Its presence is, however, sufficiently demonstrated by the cold infusion gradually losing its transparency as its temperature is increased, and in this case it regains its former transparency, even after having been subjected for some time to the boiling temperature.

We therefore see, that, in this instance, a very active principle is more readily dissolved by cold than by boiling water; and it is probable that there are other instances in which heat is improperly employed, with the view of extracting the active principles of vegetable substances.

The influence of temperature upon the power of solvents is exceedingly curious and interesting. It has long been recognized as a general law, that the proportion of solid principles which are dissolved in fluids, is more or less increased by the assistance of heat. Hence water, by decoction and digestion, commonly dissolves more speedily and more abundantly, than by cold maceration; the soluble principles of compound bodies.

Various exceptions, however, to this general rule, have successively been discovered. Sea-salt has long been known to be equally soluble in cold and in boiling water. Afterwards, it was found that lime and magnesia were actually more soluble in cold than in boiling water; and a still more remarkable relation between the solubility of certain saline substances and heat has more recently been discovered. Sulphate of soda, and the nitrate and muriate of barytes, by successive augmentations of temperature, have their solubility first slightly increased, then greatly diminished, and again very rapidly increased. This phenomenon is the less likely to be soon explained, that each salt follows in this respect a different law, or that the curve of their solubilities in relation to temperature in each is different. All the known exceptions to the general law have been observed in the mineral or inorganic kingdom, and from analogy we may conjecture that many others exist in similar bodies, although not yet detected. It is also necessary to remark, that when, in consequence of the diminished power of the menstruum, whether by increase or diminution of temperature, the solvend is separated by precipitation or crystallization, its nature is not altered, and it is equally soluble in the menstruum as before, by diminishing or increasing the temperature, or by adding an additional quantity of the solvent.

But, in regard to the organic kingdom, the law of increased solubility, by increase of temperature, has been hitherto held to be universal, except when the nature of the solvend is altogether

altered by heat, so that it has become no longer soluble in the menstruum, either by restoring the original temperature, or by increasing the quantity of the menstruum. Thus albumen, once coagulated by heat, is rendered permanently insoluble in water. In all other instances, the solubility of organic principles is supposed to be increased by increase of temperature. By heating the menstruum, it commonly acts more quickly and more completely, the soluble principles are more speedily extracted from organic compounds, and in larger quantity, and the solution is more liquid and perfect; while, on the contrary, on cooling, the principle dissolved separates from a hot saturated solution either by precipitation or crystallization, or by becoming viscid, or forming a jelly, and in all these cases the principle thus separated is redissolved by again increasing the temperature, shewing that its nature is not altered, and that they are simple examples of the rule that the solubility of bodies is increased by increase of temperature. The relative solubility of animal gelatine and of pectic acid, at different temperatures, may be specified with peculiar propriety as forming a striking contrast with the subject of this paper. Gelatine is sparingly soluble in water at the ordinary temperature of the atmosphere, so that cold water is incapable of extracting it from bones, horn, membranes, tendons, or even flesh. By increase of temperature, it becomes rapidly more soluble, and most of these substances yield it very readily to boiling water. Nay, by increasing the temperature of water above the boiling point in PAPIN'S Digestor, it becomes progressively still more soluble; and, accordingly, this method is employed by D'ARCET to extract gelatine from the hardest bones. On cooling, the water is no longer capable of retaining the whole gelatine dissolved, and the solution, by reduction of temperature, forms a tremulous jelly, more or less solid in proportion to its concentration, which is again readily dissolved into a fluid by the application of heat, properties very nearly the reverse of those

I have stated to belong to mudarine. Nearly the same phenomena are observed with regard to pectic acid.

I must postpone to another opportunity the changes which mudarine undergoes from various chemical re-agents, as well as the general analysis of the mudar powder, because I think, that, by limiting the present communication to the singular exception which mudarine presents to the solubility of organic principles being increased by increase of temperature, it is more likely to attract the notice of scientific chemists, and to lead to the inquiry, whether other vegetable principles possess any analogy in this respect.

XXVI. *Description and Analysis of some Minerals.* By THOMAS THOMSON, M. D., F. R. S. L. & Ed. &c., Professor of Chemistry, Glasgow.

(Read 21st April 1828.)

1. *Anhydrous Silicate of Iron.*

THIS mineral was given me for examination by PATRICK DORAN, an Irish mineral-dealer, who discovered it in Slavcorrach, one of the Morne Mountains, on the north-east coast of Ireland, forming so conspicuous an object at the southern extremity of the county of Down.

The colour is dark brown, with something of the metallic lustre.

The mineral is foliated, and breaks easily into four-sided prisms, seemingly right; though the summits are very obscure.

The fragments are strongly attracted by the magnet, but they have no poles.

Hardness 4.

Opaque.

Easily frangible.

Specific gravity 3.8846.

When heated in a glass-tube, it gives out ammoniacal vapours, and loses 1.97 per cent. of its weight.

Infusible *per se* before the blowpipe, but in the reducing flame acquires the metallic lustre, and assumes very much the appearance of magnetic iron-ore.

In muriatic acid it dissolves by the assistance of heat, without effervescence, leaving behind a quantity of silica in fine flocks,

but not gelatinous ; 20 grains being treated in this manner, left a quantity of white siliceous matter, which, after ignition, weighed 5.535 grains. This matter being fused with twice its weight of carbonate of soda, dissolved in muriatic acid, and treated in the usual way, was found composed of,

Silica,	4.861
Peroxide of iron,	0.290
Red oxide of manganese,	0.384
	<hr style="width: 100px; margin: 0 auto;"/>
	5.535

The muriatic solution was evaporated to dryness, and the dry residue digested in water, acidulated with muriatic acid, till every thing soluble was taken up. There remained undissolved a quantity of silica, which weighed after ignition 1.059 grains.

Suspecting the presence of manganese in the muriatic acid solution, I neutralized it with ammonia, and threw down the iron (it had been peroxidized by digestion with nitric acid), by benzoate of ammonia.

The benzoate of iron, after edulcoration and drying, was burnt in an open crucible, and kept red hot till the iron was brought into the state of peroxide. It weighed 14.95 grains, equivalent to 13.46 grains of protoxide of iron.

The residual liquid was mixed with an excess of carbonate of soda, and boiled in a flask. Nothing was obtained except a trace of alumina too small to be weighed.

Thus the constituents of the mineral, by this analysis, are,

Silica,	9.92	or	29.60
Protoxide of iron, . . .	13.460		67.30
Peroxide of iron, . . .	0.290		1.45
Red oxide of manganese,	0.384		1.92
	<hr style="width: 100px; margin: 0 auto;"/>		<hr style="width: 100px; margin: 0 auto;"/>
	20.054		100.27

There is a slight excess, which would be diminished by reducing the peroxide of iron and the red oxide of manganese to protoxides ; for that is the state in which they probably exist in the mineral. This reduction being made, the constituents of the mineral will be

Silica,	29.60
Protoxide of iron, . . .	68.605
Protoxide of manganese, . . .	1.857
	100.062

This is equivalent to

- 14.8 atoms silica,
- 15.24 atoms protoxide of iron,
- 6.40 atoms protoxide of manganese.

If we admit the 0.4 oxide of manganese to have been united with 0.4 protoxide of iron, there will remain

- 14.8 atoms silica,
- 14.8 atoms protoxide of iron.

It is obvious from this that the mineral is a simple anhydrous silicate of iron, composed of

1 atom silica,	2
1 atom protoxide of iron, . . .	4.5
	6.5

This mineral adds another species to the family of silicated iron already so numerous ; though there can be little doubt that many more species will be added hereafter. The following

enumeration of the species at present known may not be unacceptable to mineralogists :

1. Sp. *Sideroschisolite*, or disilicate of iron, discovered in Brazil, and described by Dr WARNEKINK*. It is composed of

1 atom silica,	2
2 atoms protoxide of iron, . . .	9
1 atom water,	1.125
	12.128

2. Sp. *Chamoisite*, occurring in beds at Chamoisin, in the Valois, and described and analyzed by Berthier †. Its constituents are,

1 atom silica,	2
2 atoms protoxide of iron, . . .	9
2 atoms water,	2.25
	13.25

3. Sp. *Cronstedtite*, discovered at Przibram in Bohemia, described by ZIPPE, and analysed by Professor STEINMANN ‡. Its constituents are,

1 atom silica,	2
1 atom protoxide of iron, . . .	4.5
1 atom water,	1.125
	7.625

* POGGENDORFF'S Annalen, i. 387.

† Ann. des Min. V. 393.

‡ SCHWEIGGER'S Jahrbuch, ii. 69.

4. Sp. Anhydrous silicate of iron from the Morne Mountains, described and analyzed in this paper.

5. Sp. *Hedenbergite*, found at Tunaberg, in Sodermanland, Sweden, and described and analyzed by HEDENBERG*. Its constituents seem to be,

3 atoms silica,	6
1 atom protoxide of iron, . . .	4.5
2 atoms water,	2.25
	12.75

6. Sp. *Chloropal*, discovered by JOSEPH JONAS, near Unghwar, in Hungary, along with the opal, and described and analyzed by BERNHARDI and BRANDES †. Its constituents are,

3 atoms silica,	6
1 atom protoxide of iron, . . .	4.5
2½ atoms water,	2.8125
	13.3125

7. *Arfwedsonite*, so called by Mr BROOKE, but formerly known by the name of *Ferruginous Hornblende*, brought from Kargardluarduk in Greenland, by Sir CHARLES GIESECKE'. It was analyzed several years ago in my laboratory, and found composed of

15 atoms silica,
4 atoms peroxide of iron,
1 atom deutoxide of manganese.

* *Afhandlingar*, ii. 154.

† SCHWEIGGER'S *Jahrbuch*, v. 29.

It is therefore a compound of

4 atoms pertersilicate of iron,
1 atom tersilicate of manganese.

8. Sp. *Hisingrite*. This mineral was discovered in the iron mine of Gillinge, in Södermanland, and was first described and analyzed by HISINGER in 1810*.

Its constituents are,

4 atoms persilicate of iron,
1 atom silicate of alumina,
4 atoms water.

9. Sp. *Knebite*. This is a name given by DOBEREINER to a mineral of unknown locality, which he described and analyzed †. Its constituents are,

1 atom silicate of iron,
1 atom silicate of manganese.

10. Sp. *Pyrosmalite*. Discovered in the iron mine of Bjelke, Nordmark in Wermland, Sweden, described by HAUSSMANN, and analyzed by BERZELIUS and HISINGER ‡, is composed of,

14 atoms sesquisilicate of iron,
5 atoms sesquisilicate of manganese,
1 atom sesquichloride of iron.

* *Afhand.* iii. 304.

† SCHWEIGGER'S *Journ.* xxi. 49.

‡ *Afhand.* iv. 317.

Or, if we consider the sesquichloride as replacing a certain portion of sesquisilicate of iron, then the constituents will be,

3 atoms sesquisilicate of iron,
1 atom sesquisilicate of manganese.

11. Sp. *Nontronite*. Discovered at Nontron, in the Department of Dordogne, France, and described and analyzed by BERTHEIR* Its constituents are,

7 atoms terpersilicate of iron,
2 atoms bisilicate of alumina,
1 atom silicate of magnesia.

It might be considered as a compound of two distinct minerals.

The first composed of

1 atom terpersilicate of iron.
1 atom silicate of magnesia.

The second of

3 atoms terpersilicate of iron.
1 atom bisilicate of alumina.

One integrant particle of the first of these, combined with two integrant particles of the second, would constitute nontronite. On this view of its constitution, nontronite might be represented by the following formula :

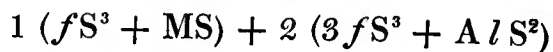

* Ann. de Chim. et de Phys. xxxvi. 22.

2. *Hydrolite.*

This mineral seems to have been first discovered by LEMAN, in the cavities of amygdaloidal rocks, in the Vicentine. These specimens were analyzed by VAUQUELIN, under the name of Sarcolite; and HAÜY considered them as mere varieties of analcime. Some years ago the mineral was discovered in the county of Antrim, Ireland, lodged in amygdaloidal rocks, precisely as in the Vicentine. The specimens in my possession were procured from PATRICK DORAN, an Irish mineral-dealer, who had collected them in this locality. Dr BREWSTER gave an account of the physical properties of this mineral in his scientific Journal*, under the name of *Gmelinite*; and HAIDINGER has described it under the same name, in an appendix added to his English translation of MOHS' Mineralogy †.

Colour snow-white.

All the specimens which I have seen, are in double six-sided truncated pyramids, with a short six-sided prism between them. The inclination of y on y' , according to Dr BREWSTER'S measurement, is $83^{\circ} 36'$.

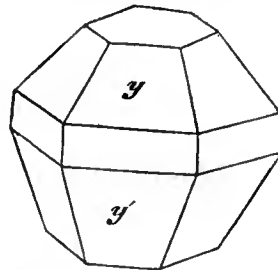

Translucent.

Hardness 3.5. Scratches calcareous spar, but not fluor-spar.

Lustre vitreous.

Specific gravity 2.054.

Very easily frangible.

Before the blowpipe, swells out and assumes the appearance of an enamel; but does not fuse into a transparent glass.

* Vol. ii. p. 262.

† Vol. iii. p. 174.

When exposed to a red heat, it gives out water, and nothing else, and loses 29.866 per cent. of its weight.

I subjected it to analysis; but, as the quantity of it in my possession only amounted to 5.3 grains after ignition, it will be necessary to state the steps of the analysis, to enable the reader to judge of the degree of confidence to which my experiments are entitled.

The 5.3 grains of the ignited mineral, after having been reduced to a fine powder, were intimately mixed with 30 grains of carbonate of barytes, in a platinum crucible, and the mixture was exposed to a strong red heat, and kept at that temperature for an hour. The whole was then dissolved in dilute muriatic acid. The undissolved portion having the appearance of hydro-lite undecomposed, was mixed with 30 grains of carbonate of barytes, and kept in a strong heat for two hours. It was then dissolved in dilute muriatic acid. A few flocks remained undissolved; but they were light and loose, indicating that they had been acted upon by the barytes. The two solutions were mixed together, and evaporated to dryness in a porcelain basin. The dry mass was digested for some time in water acidulated with muriatic acid. The whole was then thrown on the filter, to separate the undissolved silica from the solution. The silica on the filter being washed, dried, and ignited, weighed 4 grains. It was laid aside for examination.

The muriatic acid solution was neutralized by caustic ammonia added slightly in excess. A brown precipitate fell, weighing, after ignition, 1.08 grains. Being digested in muriatic acid, it left undissolved 0.055 grains of a grey matter, which, tested by the blowpipe, proved to be silica very slightly tinged with iron.

The muriatic solution thus freed from silica was mixed with potash-ley in considerable excess, and heated in a flask. There was precipitated a quantity of peroxide of iron, weighing, af-

teredulcoration, drying, and ignition, 0.44 grain. The potashley had dissolved the alumina of the precipitate, which obviously amounted to 0.585 grain. Thus the brown precipitate thrown down by caustic ammonia, was composed of,

Silica,	0.055
Peroxide of iron,	0.440
Alumina,	0.585
	1.080

The muriatic solution was now mixed with a sufficient quantity of carbonate of ammonia, to throw down the whole of the barytes. The filtered liquid was evaporated to dryness, and exposed to a graduated heat, to drive off the ammoniacal salts. The residue was found to contain lime derived from the filter. To get rid of it, I added some carbonate of ammonia, heated the liquid in a flask, then left it in a small glass cylinder till the carbonate of lime subsided; drew off the clear supernatant liquid by a sucker,edulcorated the carbonate of lime by distilled water, which was drawn off in like manner by a sucker. The liquid was evaporated to dryness in a platinum vessel, and the ammoniacal salt driven off. There remained behind a little saline matter, which weighed, after ignition, 0.84 grain. It was soluble in water, and the aqueous solution was abundantly precipitated by muriate of platinum. Hence the salt was chloride of potassium, and contained 0.41 potassium, equivalent to 0.53 potash.

The 4 grains of silica, obtained at the beginning of the analysis, were mixed with thrice their weight of anhydrous carbonate of soda, and exposed to a strong heat in a platinum crucible. The mass, which had undergone fusion, was dissolved in muriatic acid, and the solution was evaporated to dryness. The dry residue was digested in dilute muriatic acid, and thrown upon a filter, to se-

parate the silica. The silica, after edulcoration, drying, and ignition, weighed 2.96 grains. It was a fine white powder, and was perfectly pure.

The muriatic solution, thus freed from silica, was mixed with caustic ammonia slightly in excess; a greyish-brown precipitate fell, weighing, after ignition, 0.58 grain. By solution in muriatic acid, and mixing the solution with caustic potash in considerable excess, it was resolved into

Peroxide of iron,	0.185
Alumina,	0.395
	<hr style="width: 100px; margin: 0 auto;"/>
	.580

Thus, from the 4 grains of the siliceous-looking matter, separated from the hydrolite, when it was treated with carbonate of barytes and muriatic acid, were obtained,

Pure silica,	2.96
Peroxide of iron,	0.155
Alumina,	0.395
	<hr style="width: 100px; margin: 0 auto;"/>
	3.54
Loss,	0.46
	<hr style="width: 100px; margin: 0 auto;"/>
	4.00

This loss could have been owing to nothing but the presence of a little potash in the siliceous matter (the liquid was carefully examined, but nothing found), which I could not obtain, because I had fused the 4 grains of siliceous matter with carbonate of soda.

If we now add together all the constituents, we shall find that 5.3 grains of anhydrous hydrolite are composed of

Silica,	3.015
Alumina,	0.980
Peroxide of iron,	0.625
Potash,	0.530
	<hr/>
	4.95

As hydrolite contains 29.866 per cent. of water, it is obvious, that if the 5.3 grains analyzed had retained their water, the weight would have been 7.53 grains. Consequently the constituents, according to the preceding analysis, considering the loss as potash, and converting the peroxide of iron into protoxide, are as follows :

Silica,	3.015	or	39.896
Alumina,	0.980	.	12.968
Protoxide of iron,	0.5625	.	7.443
Potash,	0.7425	.	9.827
Water,	2.2050	.	29.866
	<hr/>		<hr/>
	7.5050		100.

This is equivalent to

14 atoms silica,
 4 atoms alumina,
 1 atom protoxide of iron,
 1 atom potash,
 18 atoms water.

We may therefore consider hydrolite as a compound of

4 atoms bisilicate of alumina,
 1 atom bisilicate of potash,
 1 atom quatersilicate of iron,
 18 atoms water.

So that every integrant particle of the mineral is combined with three atoms of water.

III. *Supersulphuretted Lead.*

The first specimen of this mineral which I had an opportunity of seeing, was one said to have been brought from Caithness by Sir JOHN SINCLAIR. This was more than twenty years ago. I had no opportunity of analyzing it; but, when held in the flame of a candle, it burnt with a blue flame, and emitted a strong odour of sulphurous acid. I have been told by the overseers of the lead mines in the north of England, that this kind of ore is not uncommon in their district; but I never was so lucky as to get a specimen of it till August 1828, when Captain LEHUNT brought several pieces of it from Ireland, which he got from a mineral-dealer in Dublin; but unluckily the locality of these pieces is unknown; though I am in hopes soon of getting some accurate information on the subject.

The mineral has much the appearance of fine grained galena.
Colour blue.

Lustre metallic.

Texture fine granular; opaque.

Scratches common galena; but, as it is not free from grains of quartz, it may owe its apparent hardness to these grains.

Sectile.

Specific gravity 6.713.

Before the blowpipe, burns with a blue flame, decrepitates, melts, and, on charcoal, is reduced to a button of lead.

100 grains, when heated, gave out sulphur, and were reduced to 98.206 grains.

20 grains of this mineral, as free from impurities as possible, were digested in nitro-muriatic acid, till every thing soluble was

taken up. The undissolved matter, after ignition, weighed 0.25 grain. It was white and transparent, and, when viewed through a glass, proved to be small grains of quartz, which had been mechanically mixed with the mineral.

The solution, while hot, was mixed with an excess of bicarbonate of potash, previously dissolved in water, and the mixture was digested on the sand-bath for 24 hours. The precipitated carbonate of lead was then separated by the filter: after being washed and dried, it was exposed to a red heat. It melted, assumed a yellow colour, and weighed 18.52 grains. Being digested in nitric acid, it dissolved, with the exception of a few white flocks, which weighed, after ignition, 0.44 grain, and proved, when examined by the blowpipe, to be silica. Hence the oxide of lead was 18.08 grains, equivalent to 16.79 grains of metallic lead.

The alkaline solution, from which the carbonate of lead had been thrown down, was evaporated to dryness, and the residue digested in water. A small white powder remained undissolved. By ignition it became yellow. It dissolved completely in nitric acid, and the solution was precipitated orange by chromate of potash. It was therefore oxide of lead. It weighed, after ignition, 0.48 grain, equivalent to 0.445 grain lead.

The alkaline solution was supersaturated with nitric acid, and the sulphuric acid thrown down by muriate of barytes. The sulphate of barytes, obtained afteredulcoration and ignition, weighed 21.254 grains, equivalent to 2.881 grains of sulphur.

Thus the constituents of the ore were,

Lead,	17.235	or	86.175
Sulphur,	2.881	14.405
Silica,	0.690	3.450
	<hr/>		<hr/>
	29.806		104.030

I do not know to what the excess is to be ascribed in this analysis. I repeated the analysis, and obtained similar results, and an excess which amounted to 2.5 per cent. The silica is an accidental impurity. The ore is obviously a compound of

Lead,	86.175	or	78	or	156
Sulphur, . . .	14.405	. .	13.04	.	26.08

The atom of lead being 13, and that of sulphur 2, it is obvious that 156 lead is equal to 12 atoms; while 26.08 sulphur is almost exactly equal to 13 atoms. The supersulphuret of lead, therefore, which I analyzed, is a compound of

12 atoms lead,
13 atoms sulphur.

This is an unexpected combination, nothing similar to which I have met with before. I have not made any experiments to ascertain whether lead be susceptible of combining with sulphur in various proportions. Analogy would lead us to suppose that it is; for we generally find, that oxygen and sulphur enter into the same number of combinations with most of the metals. There probably, then, exists a sesquisulphuret of lead; if so, we may consider the supersulphuret of lead just analyzed, as a compound of

5 atoms sulphuret of lead,
1 atom sesquisulphuret of lead.

This at least would accord with the results obtained.

V. *Chabasite.*

This mineral, as is well known to mineralogists, exists rather abundantly in the neighbourhood of Glasgow. The finest spe-

cimens have been found at Kilmacolm in Renfrewshire ; and I am indebted to my friend and pupil Mr BROWN, for a very fine collection of chabasites from that locality. It is in large transparent rhomboidal crystals, constituting the well known primary form of this mineral. Chabasite has been analyzed thrice by BERZELIUS, and once by ARFWEDSON. The following table exhibits the results of these analyses :

Silica,	50.65	48.30	48.00	49.17
Alumina,	17.00	19.28	29.00	18.90
Lime,	9.73	8.70	8.35
Magnesia,	0.40
Potash,	1.70	2.50	0.41
Soda,	2.75	12.19
Water,	19.50	20.00	19.30	19.73
	98.58*	98.78 †	99.21 ‡	99.99

The last analysis in the table was made by BERZELIUS upon a specimen from Scotland. It is very remarkable, from the total absence of lime, which occurs as a constituent in every other chabasite hitherto subjected to analysis. BERZELIUS informs us, that under the soda a little potash is included.

It was this last analysis that induced me to introduce chabasite into this paper. BERZELIUS has given no other locality except Scotland. Nor has he favoured us with any description of the mineral subjected to analysis ; both of which would have been very desirable. That the chabasite of Scotland is not always composed, as BERZELIUS has found it in the specimen which

* BERZELIUS ; Afhadl. vi. 190. The specimen was from Jutland.

† ARFWEDSON ; Kong. Vet. Acad. Handl. 1824, p. 356. From Faroe.

‡ BERZELIUS ; *Ibid.* The variety called Leveyne, and from Faroe.

he analyzed, will appear from the following table, exhibiting the constituents of a very fine specimen of chabasite from Kilmaccolm, which I subjected to a very careful analysis :

Silica,	48.756
Alumina,	17.440
Lime,	10.468
Potash,	1.548
Water,	21.720
	99.932

The potash was carefully examined for soda, but none was found in it. It will appear from this analysis, that the Kilmaccolm chabasite, so far from containing no lime, contains in fact a greater proportion of that substance than any other specimen hitherto analyzed. Is it not possible that the Scottish specimen analyzed by BERZELIUS may turn out to be a new species ?

The formula for chabasite seems to be,



Or it is composed of

- 1 atom bisilicate of lime, with some potash,
- 3 atoms bisilicate of alumina,
- 6 atoms water.

The excess of lime in the Kilmaccolm chabasite, prevents this formula from applying quite accurately to its constituents*.

* Since this paper was read to the Society, I have analyzed a flesh-coloured chabasite from the north of Ireland, and found it composed of

V. *Wollastonite.*

This name was given by LEMAN to a mineral which occurs in the lava of Capo di Bone, near Rome. I have never seen a specimen of it; but Mr W. PHILIPS informs us, that, by mechanical division, it yields a crystal precisely the same with the primary form of table-spar or bisilicate of lime, of which it can scarcely be said to be a variety*. But there is a mineral which occurs in the rock of Edinburgh Castle, to which the Edinburgh mineralogists have given the name of Wollastonite, probably from a notion that it is the same with LEMAN'S mineral. I had an opportunity of seeing and examining some specimens of this mineral last September, and was surprised to find it to be a mineral very different indeed from table-spar, being in fact very pure *prehnite*. The total want of the shade of green which usually characterizes prehnite, seems to have prevented the true nature of this mineral from being recognised. But abundance of prehnite, quite free from every tint of green, is met with in the neighbourhood of

Silica,	48.988
Alumina,	19.774
Soda,	6.066
Lime,	4.068
Peroxide of iron,	0.404
Water,	20.700

100.

This approaches BERZELIUS' specimen, and shews us, that the lime in chabasite may be replaced by soda. The formula is,



* PHILIP'S Mineralogy, p. 211.

Glasgow. The following comparison between the Castlehill mineral and prehnite will leave no doubt about its nature.

It is composed of fibres slightly diverging, so is fibrous prehnite.

Translucent, so is prehnite.

Lustre vitreous, so is that of prehnite.

The hardness is the same as that of prehnite.

Specific gravity 2.900. I found that of a fine specimen of prehnite from Kilpatrick 2.901.

Before the blowpipe it behaves exactly as prehnite.

Captain LEHUNT, at my request, analyzed the Castlehill mineral. The following table contains the result of his analysis. I have placed, in a second column, the analysis of a pure specimen of prehnite from the hills behind Port-Glasgow, which I made some years ago, to show the identity of the two minerals.

	Castlehill Prehnite.	Kilmacolm Prehnite.
Silica,	43.084	42.22
Alumina,	23.840	23.68
Lime,	26.164	23.52
Protoxide of iron,	0.640	3.06
Protoxide of manganese, .	0.416
Potash and soda,	1.028
Water,	4.600	5.58
	<hr style="width: 50%; margin: 0 auto;"/> 99.772	<hr style="width: 50%; margin: 0 auto;"/> 98.06

Potash and soda had been already found in prehnite by LAUGIER. They probably existed in the specimen analyzed by me. The loss being only 2 per cent. I did not suspect the presence of an alkali, and, therefore, did not search for it. In the specimens of prehnite analyzed by GEHLEN, the lime amounted

to 26 per cent., as well as in the Castlehill specimen analyzed by Captain LEHUNT.

If we admit a small excess of silica, and consider the oxides of iron, manganese, and the potash and soda, as accidental ingredients, the composition of prehnite will be

10 atoms silicate of alumina,
7 atoms silicate of lime.

Reckoning from the Castlehill variety, all the other Scottish prehnites, so far as I have analyzed them, contain rather less lime. The surplus of silica amounting to about one-seventh of the whole, is probably, in the mineral, united to the oxides of iron and manganese, and to the potash and soda. How far these may be essential ingredients remains still to be discovered*.

* The name *Wollastonite* was given by HAVY to *table-spar*, or *bisilicate of lime*; but mineralogists in general have refused to adopt this appellation. I have been induced, therefore, in order to commemorate the many obligations which mineralogy owes to Dr WOLLASTON, to apply the term *Wollastonite* to a mineral which I believe to be new, and which has a very close relation to the species which HAVY designated by that name.

It occurs in veins in a greenstone which is situated near Kilsyth, on the banks of the Forth and Clyde Canal, and possesses the following characters:

Its colour is white, with a slight shade of green. Its texture is fibrous, and the fibres are in tufts diverging from a centre, thus exhibiting marks of an imperfect crystallization. The mineral is translucent on the edges, and has a lustre inclining to silky. The fracture is splintery, and the fragments are sharp-edged.

The hardness is intermediate between that of selenite and calcareous spar. Its specific gravity is 2.8760.

Before the blowpipe it melts with some difficulty into a white enamel. This fusion is not accompanied by any froathing. With borax it fuses into a bead-yellow, while hot, but becoming colourless on cooling. With biphosphate of soda in considerable excess, it fuses into a colourless bead, leaving a silica skeleton. With carbonate of soda it effervesces, and fuses into an opaque bead, with a reddish-blue colour.

VI. *Sulphate of Alumina.*

The specimen of this mineral in my possession comes from Rio Soldana in South America. I am indebted for it to the kindness of CHARLES MACINTOSH, Esq. of Crossbasket, who had got it from the late Sir RALPH WOODFORD, Governor of Trinidad. There is a notice respecting it in the *Annales de Chimie et de Physique* *, by M. BOUSSINGAULT, from which we learn that it occurs in the transition-slate of the Andes of Columbia, either in a state of efflorescence or in crystallized masses. HUMBOLDT observed it in the clay-slate of Araya near Cumana. It is found also in the clay-slate of Socono, and in many other places of South America. It occurs in commerce, in spherical masses, and in the

The constituents of this mineral I found to be,

Silica,	52.744
Lime,	31.684
Soda,	9.600
Magnesia,	1.520
Peroxide of iron,	1.200
Alumina,	0.672
Water,	2.000
	99.420

If we suppose the magnesia to have replaced a little lime, this mineral is a compound of

- 4 atoms bisilicate of lime,
- 1 atom tersilicate of soda.

Thence its symbol is $4CS^2 + NS^3$, and it differs from table-spar, by containing 1 atom of tersilicate of soda united to 4 atoms bisilicate of lime; whereas table-spar is pure bisilicate of lime.

* Tom. xxx. p. 109.

country is called *alumbre* (alum), and applied to the same uses as that salt. BOUSSINGAULT has analyzed a specimen from the same locality as mine. He gives its constituents as follows :

Sulphuric acid,	36.4
Alumina,	16.0
Water,	46.6
Oxide of iron,	0.4
Lime,	0.2
Clay,	0.4
	100.0

The colour of the specimen is white, here and there tinged yellow, obviously from external impurities.

In fine crystalline scales.

Lustre silky.

Taste that of alum, but stronger.

Translucent.

Very soft.

Specific gravity 1.6606.

Before the blowpipe behaves like alum.

Being subjected to a careful analysis, its constituents were found as follows :

Sulphuric acid,	35.872
Alumina,	14.645
Water,	46.375
Peroxide of iron,	0.500
Soda,	2.262
Mechanical impurity *,	0.100
	99.754

* It was very ferruginous silica.

This does not differ very far from the analysis of BOUSSINGAULT. It is equivalent to

1 atom sulphate of alumina.

6 atoms water.

$\frac{7}{100}$ atom sulphate of soda.

$\frac{1}{80}$ atom per-sulphate of iron.

If we allow the small quantity of sulphate of soda and per-sulphate of iron found in this mineral to be accidental ingredients, then the salt is composed of

1 atom sulphate of alumina,	. . .	7.25
6 atoms water,	6.75
		14.

VII. *Sulphate of Alumina*—From Campsie.

MR MACINTOSH has an alum-work at Campsie, near Glasgow. The alum is obtained from the shale of the old abandoned coal beds in the neighbourhood. At first, nothing more was necessary than to lixivate the shale; concentrate the liquid, and add sulphate or muriate of potash in order to obtain alum. This process being continued for a considerable number of years, a great quantity of shale thus washed had accumulated in the neighbourhood of the work. MR MACINTOSH found, that, by burning this washed shale, it might be made to yield a new crop of alum. In one of my visits to this manufactory, MR MACINTOSH pointed out to me thin white bands, which occasionally present themselves in this burnt shale, and he mentioned how very productive these bands were when employed in the manufac-

turing of alum. After having examined the sulphate of alumina from Rio Soldano, it occurred to me that the white bands at Campsie bore a certain resemblance to it. I, therefore, requested Mr MACINTOSH to procure me a specimen of it for examination, which, with his usual polite kindness, he speedily did.

Its colour is greyish-white, intermixed with portions having a yellow colour, and which are unequally distributed.

Fracture earthy.

Opaque.

Friable.

Taste acid, astringent, and sweet.

Specific gravity 1.887.

When digested in water it dissolved, with the exception of a white powder, which amounted to 15.31 per cent. of the whole. This white powder proved, on examination, to be a subsulphate of alumina.

When heated, it melts somewhat like alum, and gives out pure water. When heated to redness, it swells up like alum, and finally leaves a yellowish-white, porous, tasteless matter, nearly similar to what would be left by alum, making allowance for the colour.

Being carefully analyzed, its constituents were found to be,

1. Matter insoluble in water 15.31, composed of

Sulphuric acid,	10.2
Alumina,	5.11

2. Matter soluble in water composed of

Sulphuric acid,	30.225
Alumina,	5.372
Peroxide of iron,	8.530
Potash,	1.172
Water,	36.295
	<hr/>
	81.594
Insoluble matter,	15.310
	<hr/>
Total,	96.904
Loss,	3.096
	<hr/>
	100.000

This loss was doubtless water. For the 36.295 per cent. of water were obtained by simply exposing the matter to heat on the sand bath. I had ascertained, by previous experiments, that it is impossible to deprive sulphate of alumina of the whole of its water, without at the same time driving off some of the sulphuric acid.

The constituents thus found are equivalent to

24 atoms sulphate of alumina.

9 atoms bipersulphate of iron.

1 atom bisulphate of potash.

42 atoms water.

The American sulphate of alumina differs from that of Campsie in three remarkable particulars. It contains soda, while the alkali in the Campsie mineral is potash. The Campsie mineral contains a notable quantity of bipersulphate of iron, while, in the American mineral, the quantity is trifling. In the American mineral, all the saline contents were neutral, while in the Campsie mineral almost one-half of the saline contents are in the state of bisulphates.

VIII. *Soda-Alum.*

Some years ago Dr HOOKER received several specimens of native alum from Dr GILLIES, who resided at the time at Mendoza, a city near the foot of the Andes, and about 800 miles west from Buenos Ayres. Dr HOOKER was so good as to put some of the specimens into my possession that they might be analyzed, and their constitution determined. The specimens were ticketed, "Native alum from the province of St Juan." They are in irregular nodules, rather smaller than a hen's egg. From the rocky fragments occasionally attached to them, they seem to have been imbedded in a slate, having a blue colour, very soft, and bearing some resemblance to the slate-clay usually accompanying the coal beds in this country. But these stony fragments are too minute to enable us to determine with accuracy the true position of the rock to which they belong.

The alum is white, and composed of fibres adhering longitudinally, and having some breadth, but very little thickness. It bears some resemblance to fibrous gypsum, but is much harder, not being scratched by the nail, though it is readily enough by the knife. It is sectile, the outer fibres are white and opaque, as if they had lost a portion of their water. But internally the fibres are transparent, and have a glossy or rather silky aspect, shewing that they retain a good deal of water of crystallization. The specific gravity of the transparent portion is 1.88. It tastes precisely like alum, but is much more soluble in water. For 100 parts of water, at the temperature of 62° , dissolve 377.3 parts of it, and boiling water takes up any quantity of it whatever. When heated it behaves precisely like common alum. 100 parts of it exposed to a red heat lose 46.55 parts of their weight. But this is not pure water, but water holding some sulphuric acid in solution.

By a careful analysis, I found that 53.25 grains of it could be resolved into the following constituents.

Sulphuric acid,	20.000
Alumina,	6.360
Soda,	4.000
Water,	22.209
Silica,	0.012
Lime,	0.136
Peroxide of iron,	0.110
Protoxide of manganese, with a little magnesia,	0.423
	53.250

It will be observed that the sulphuric acid corresponds exactly with four atoms. Hence it is probable, that the bases which saturate this acid in the salt amount also to exactly four atoms. Four constitutes an atom of soda. But the atom of alumina being 2.25, three atoms of that earth will amount to 6.75; whereas only 6.36 were found in the salt. There is, therefore, a deficiency of 0.39 grains of alumina. But the lime, iron, and manganese, (if the magnesia contained in it be reckoned 0.12), are together exactly equivalent to 0.39 alumina. Thus, it appears, that these substances replace a small portion of the alumina in the salt. 22.209 approaches very nearly to twenty atoms of water. We may, therefore, neglecting the minute quantity of silica, lime, iron, manganese, and magnesia, consider the salt as composed of

4 atoms sulphuric acid,	20
3 atoms alumina,	6.75
1 atom soda,	4.0
20 atoms water,	22.5
	53.25

Or we may state the composition this way :

3 atoms sulphate of alumina, . . .	21.75
1 atom sulphate of soda,	9.0
20 atoms water,	22.5
	53.25

The only difference between native and artificial soda-alum is in the water of crystallization. In the former it amounts only to twenty atoms, while in the latter it is twenty-five atoms. Artificial soda-alum crystallizes in regular octahedrons like common alum. But the native seems to crystallize in prisms. At least that is the natural inference from its fibrous structure. I made some attempts to obtain it in more regular crystals, but they were unsuccessful, owing, I believe, to the heat of the weather when the trial was made.

IX. *Siliceous Hydrate of Magnesia.*—From Haboken, New Jersey. *Nemalite* of NUTALL.

This mineral was sent me some years ago by Mr NUTALL, among many other interesting magnesian minerals from the same locality of which he had some time before given an account to the American public.

The mineral which I am going to describe occurs in veins in serpentine, and was taken for amianthus till its true nature was discovered by Mr NUTALL*.

The colour is white, with a slight shade of yellow.

Composed of elastic fibres, easily separable, and bearing a striking resemblance to the fibres of amianthus.

* See SILLIMAN'S Journal, iv. 19.

Soft enough to be scraped by the nail of the thumb.
Opaque.

Specific gravity 2.353.

By exposure to a red heat its colour was changed into brown. It retained its asbestous structure, but had become brittle and easily reducible to powder. 12 grains by this treatment lost 3.56 grains, which is equivalent to 29.66 per cent. This loss was pure water.

It dissolved in nitric acid, without effervescence, leaving a little silica.

On subjecting it to analysis, I obtained the following constituents,

Magnesia,	51.721
Silica,	12.568
Peroxide of iron,	5.874
Water,	29.666
	99.829

This is equivalent to

20.75 atoms magnesia,
6.25 atoms silica,
1 atom peroxide of iron,
26.333 atoms water.

This might be considered as,

20.75 atoms protohydrate of magnesia, mixed with
6.25 atoms silica,
1 atom peroxide of iron,
5.58 atoms water.

But, probably, the silica is in chemical combination with the magnesia. I am disposed to consider this curious mineral as composed of

5 atoms silicate of magnesia,
12 atoms bihydrate of magnesia,
1 atom ferrate of magnesia.

Its symbol, on that supposition, will be,



X. *Brownspar and Pearlspar.*

These names have been applied to a variety of mineral species, which have a considerable resemblance to each other, and the crystalline form of which approaches more or less to that of calcareous spar. MOHS and HAIDINGER have done a good deal to disentangle this chaos, and have constituted several well defined species out of minerals hitherto confounded under the common name of Brownspar. But it is doubtful whether the external characters alone afford sufficiently distinctive marks in all cases, at least, for arranging the different brownspars under their respective species. At any rate, it would be proper to subject them, in the first place, to a careful chemical analysis, in order to discover with accuracy the number of true species under which they should be arranged. It is with a view of forwarding this desirable object that I shall here state the composition of such species of brownspar in my own collection as I have hitherto subjected to chemical analysis.

First Variety.

It is composed of plates which break into rhomboids, similar in appearance to calcareous spar. But the angle, as has been

long ago shown by Dr WOLLASTON, is $106^{\circ} 15'$, instead of $105^{\circ} 5'$ as in calcareous spar.

Colour white, with a shade of red.

Translucent.

Hardness rather exceeds that of calcareous spar.

Specific gravity 2.815.

Dissolves slowly in muriatic acid, unless heat be applied.

A careful analysis of this mineral gave its composition as follows :

Carbonate of lime, . . .	54.256
Carbonate of magnesia, . . .	47.428
Alumina,	0.680
Protoxide of iron, . . .	1.692
	<hr style="width: 10%; margin: 0 auto;"/>
	104.056

Excluding the alumina and oxide of iron as accidental, the mineral is obviously a compound of

1 atom carbonate of lime,	6.25
1 atom carbonate of magnesia, . . .	5.25
	<hr style="width: 10%; margin: 0 auto;"/>
	11.5

I have found several specimens of the magnesian limestone from Sunderland exactly similar in composition. This is the case also with several specimens of Dolomite which I have analyzed.

This variety of brownspar, then, constitutes a well defined species, to which the name of Magnesio-carbonate of Lime may be given. It has been long distinguished as peculiar in mineralogical systems. Yet nothing is more common than to find in cabinets varieties of it arranged under the name of brown spar.

Second Variety.

I got this variety from the neighbourhood of Alston Moor, under the name of *Brown Spar*.

It has a dirty brown colour. Streak brown.

Consists of small irregular rhomboids; with curve faces, and entangled in each other.

Lustre pearly, nearly dull.

Opaque.

Scratched by calcareous spar.

Rather brittle.

Specific gravity 3.404.

The crystals were attached to a thin crust of brown matter, having a pearly and splendid lustre. It was of the same nature as the crystals, but had not like them been altered by exposure to the weather.

This specimen being subjected to a careful analysis, its constituents were found to be,

Carbonic acid,	18.50
Protoxide of iron, . .	30.27
Peroxide of iron, . . .	37.65
Deutoxide of manganese,	4.75
Water,	8.30
	<hr/>
	99.47

If we allow the manganese to be accidental, then the constitution of the mineral will be,

1 atom carbonate of iron, . .	7.25
1 atom perhydrate of iron, .	6.125
	<hr/>
	12.375

It therefore constitutes a new species of iron-ore, which may be distinguished by the name of Hydro-carbonate of iron.

It is unfortunate that the crystals in the specimen which I possess do not admit of measurement. The angle of the rhomboid constituting common carbonate of iron is known to be 107° . Probably the measurement of the present species will deviate somewhat.

Third variety.

This variety is implanted in small sphericles on the points of long crystals of quartz. Its colour is brownish, and its lustre rather inclined to pearly. But in every other respect its characters are those of calcareous spar. Its specific gravity is 2.727. Its constituents were found to be,

Carbonic acid, . . .	44.405
Lime,	56.090
Magnesia,	1.650
Protoxide of iron, . . .	1.465
Alumina,	1.120
	<hr/>
	104.73

The carbonic acid is little more than sufficient to saturate the lime; I have little doubt, however, that the magnesia is also in the state of carbonate. The iron and alumina were probably only accidental. It is obvious that this mineral is not a true species, but merely a variety of common carbonate of lime. Its locality was Transylvania. It was marked *Globular Brown Spar*.

Fourth variety.

It was composed of a congeries of small rhomboids with curved faces.

Lustre pearly.

Surface brown; but the interior of the mineral which had not been exposed to the weather snow-white.

Scratches calcareous spar, but not fluor-spar. Hardness 3.5.

Opaque, or only slightly translucent on the edges.

This mineral was from Traversella in Piedmont. I got it under the name of Convex Rhomboidal Pearl-Spar. Unfortunately the rhomboids are not susceptible of measurement. This puts it out of our power to determine whether its shape be precisely the same with that of the first variety or not.

The constituents of this variety were found to be,

Carbonic acid,	47.
Lime,	29.072
Magnesia,	14.140
Protoxide of iron,	13.392
Alumina,	0.720
	<hr/>
	104.324

This is equivalent to

8 atoms carbonate of lime,
5 atoms carbonate of magnesia,
3 atoms carbonate of iron.

We may consider it as composed of two different minerals, united together. The first mineral is common carbonate of lime; the second a compound of

5 atoms carbonate of magnesia,
3 atoms carbonate of iron.

This compound we may represent thus,

1 atom carbonate of lime,
1 atom carbonate of ($\frac{5}{8}$ magnesia + $\frac{3}{8}$ iron).

This specimen constitutes a peculiar species, not hitherto noticed by mineralogists, which may be termed Calcareo-carbonate of Magnesia-and-Iron.

IX. *Killinite.*

This mineral was discovered some years ago by Dr TAYLOR, in coarse granite veins in fine-grained granite at Killiney, Dublin Bay. In the veins it is mixed with a good deal of spodumene. It was analyzed at the time by Dr BARKER and Dr TAYLOR, who found the constituents as follows :

Silica,	52.49
Alumina,	24.30
Potash,	5.00
Protoxide of iron,	2.49
Lime,	0.50
Oxide of manganese,	0.75
Water,	0.50
	90.53

But I have reason to suspect, both from the description and from the specimens which I saw some years ago in Dublin, that the specimens in the possession of these gentlemen were rather impure.

Captain LEHUNT and Dr STOKES *junior* visited Killiney during the summer of 1828, and procured abundance of very good specimens. Captain LEHUNT was so obliging as to present me with a very pure crystallized specimen of a large size, and seemingly quite pure. This, together with a good many other specimens already in my possession, puts it in my power to describe Killinite with more precision than has yet been done.

The usual colour is brownish-yellow; though occasionally it has a tint of green. I have seen specimens of a green colour, but they are comparatively rare. When heated to redness, some specimens become snow-white, while others assume a reddish

tinge; this may probably depend upon the proportion of iron which they respectively contain.

Texture foliated. Sometimes it is crystallized. I possess a crystal 4 inches long, 1.3 inch broad, and 0.9 inch thick. It constitutes a four-sided prism, which appears perfectly rectangular, by the most careful measurement. But the crystal has no regular summit, nor will it cleave in the direction perpendicular to the axis. We have no means of knowing, therefore, whether the prism be right or oblique.

Lustre waxy, dull, except when particles of foreign matter are mixed with it.

Opaque, or only slightly translucent on the edges.

Hardness 3.5 to 6.

Streak yellowish-white.

Specific gravity 2.598, as determined in my laboratory. Dr BARKER states it to be 2.698.

Before the blowpipe becomes white and friable, and gradually fuses into a white opaque bead, but not nearly so readily as spodumene. With carbonate of soda it fuses into a transparent glass; with borax or biphosphate of soda, into a colourless glass, leaving a silica skeleton.

It was twice analyzed in my laboratory, first by Captain LEHUNT, and then by Mr WILLIAM BLYTHE. The constituents were as follows,

Silica,	49.08	47.925
Alumina,	30.60	31.041
Potash,	6.72	6.063
Protoxide of iron,	2.27	2.328
Lime,	0.68	0.724
Magnesia with some manganese,	1.08	0.459
Protoxide of manganese, . .		1.255
Water,	10.00	16.000
	<hr/>	<hr/>
	100.43	99.795

These constituents are equivalent to

22 atoms silica,

12 atoms alumina,

1 atom potash,

8 atoms water.

Killinite therefore may be considered as a compound of

12 atoms sesquisilicate of alumina,

1 atom quatersilicate of potash,

8 atoms water.

Its symbol is $12A/S^{1\frac{1}{2}} + KS^4 + 8Aq$.

The alkali was examined with great care, and was found to be pure potash. This was requisite, because in the vein, killinite is intermixed with spodumene, the alkali of which we found to be lithia, without any admixture of potash or soda. I was disposed at first to suspect that killinite might be only a variety of spodumene. But the external characters and the constituents are both incompatible with such a supposition. It must therefore be admitted into the system as a distinct species.

The spodumene which accompanies the killinite was analyzed two different times by Captain LEHUNT. The constituents found were almost identical with the specimen from Utö, in Sweden, analyzed by STROMEYER *. I subjoin both, to enable the reader to compare the two.

* Untersuchunger, p. 426.

	<i>Spodumene from Utö.</i>	<i>Spodumene from Killiney.</i>
Silica,	63.288	63.312
Alumina,	28.776	28.508
Lithia,	5.626	5.604
Lime,	0.728
Protoxide of iron, . .	0.794	} 0.828
Protoxide of manganese,	0.204	
Water,	0.775	0.366
	<hr/>	<hr/>
	99.463	99.840

XXVII. *Observations on the Structure of the Stomach of the Peruvian Lama ; to which are prefixed Remarks on the Analogical Reasoning of Anatomists, in the Determination à priori of Unknown Species and Unknown Structures.*
By ROBERT KNOX, M. D., F. R. S. Ed. and Lecturer on Anatomy.

(Read 4th January 1830.)

SECTION I.

THE facts and observations I have now the honour to bring before the Society, were fully made out, and their general correctness ascertained, somewhat more than three years ago. Since that time I have been in the habit of alluding to them, and demonstrating the strictly anatomical part, in my summer course of lectures on comparative anatomy ; so that, in short, they may be considered as having, to a certain extent, undergone the ordeal of public opinion. I have thought it right to mention this circumstance, inasmuch as the statements and opinions to be brought forward this evening are contradictory of others which have been promulgated by some anatomists of high standing, and have been received and admitted by naturalists, and by the non-professional, as observations not to be doubted nor controverted ; as matters of fact which call for no deeper inquiry ; as statements on which unerring doctrinal points might be founded*.

* There are exceptions to this remark. The elegant writer of the Zoological Magazine, whose taste and judgment in every thing affecting zoological inquiry are so correct, did not give credence to the statements I have alluded to regarding the structure of the lama's stomach.

The facility with which an error in observation may be propagated is very great, in consequence of there being so few who make any effort to observe for themselves. A doubt is expressed by a person having some little acquaintance with the matter discussed; and this doubt, as it extends, is changed to "a probability," from which the step to "a certainty" is easy, especially if this third person be altogether ignorant of the nature of the inquiries*. An obscure hint is first thrown out by a distinguished anatomist; a bolder and much more decided statement is made by another; a popular writer and naturalist, of whom it would be unreasonable to expect anatomical knowledge, considers the matter as decided, and the stomach of the lama is declared to be "unlike that of the camel," being unprovided with the peculiar apparatus by which it is enabled to dispense with the necessity of a daily supply of water, even in countries where such supply, from the heat of the climate, may be supposed essentially requisite.

The object of the present memoir is to shew, that the statements denying to the lama a compensating and peculiar structure as regards the stomach, are without foundation in truth; and that errors, for such they assuredly are, have originated in an unwary application of a principle, which I had thought all experienced anatomists employed with great caution, viz. the assuming the structure of the young or foetal state to be analogous or identical with that of the adult †.

Whoever looks into the structure of an animal, is naturally

* GRIFFITH'S Animal Kingdom.

† Sir E. HOME has inferred, from the examination of the structure of the stomach of the young lama, that "the stomach has a portion of it, as it were, intended to resemble the reservoirs for water in the camel; but these have no depth, are only superficial cells, and have no muscular apparatus to close their mouths and allow the solid food to pass into the fourth cavity, or truly digesting stomach, without going into these cells."—*Comp. Anat.* vol. v. p. 249.

led to guess at the functions or the uses of the organs and parts successively displayed by mere handling, or by the more intricate process of dissection. The first, the great object, is a discovery of the use of the parts, there being no inference so natural to the human mind, than that every part of the animal economy must have its use; but of all inquiries, this is one of the most difficult, it being impossible to argue the uses of new parts, which so obviously serve no immediate purpose, and impracticable to apply the laws which regulate the construction of machinery, united and fashioned by human hands, to those regulated by the mysterious principle of life.

If the animal he is examining be altogether foreign to him, if its natural history be unknown, the inquirer can then only guess at the functions of the parts which present themselves to him; and the vagueness of such conjectures will be best understood by remembering that neither ARISTOTLE, nor even perhaps HIPPOCRATES, knew the uses of the common muscular masses composing the greater part of animals highly organized; that they were ignorant of the nature and functions of nerves, tendons, and of all the white fibrous textures of the body; of the brain, of the heart, arteries, veins, lymphatic vessels; and of all those parts which are now known to every tyro in anatomy, and even to the better educated amongst non-professional persons. It is not now as with the anatomists of former times; inquiries so extensive, as to determine the exact nature of almost every natural family of the animal kingdom, enable the anatomist to proceed to the dissection of an unknown animal with an extent of previous knowledge, of which he is not himself at all times conscious. He determines, by what he has already seen and read, the names and nature of all the great and leading organs of the body of the animal; he even goes further,—trusting to analogy, he ventures to predict the probable use of a part he may not have seen before in any animal.

But he is bound to do this cautiously, inasmuch as analogies are deceitful, and previous experience and observation fruitless, when it attempts to bind down to fixed laws and permanent forms, structures which, in the hands of an all-powerful Agent, seem, on most occasions, to be made subservient to function, and are changed and altered, or, as the physiological phrase goes, modified and diversified, to an extent harassing to the mind of the impatient inquirer, and puzzling to all.

To obviate certain of these difficulties, the anatomical inquirer resorts to other sources of knowledge, to other means, in order to come at the desired object. He patiently observes the habits of animals; the effects of climate and of domestication; the kind of food seemingly enjoined them by Nature; in short, their natural history; and, aided by this, he again returns to his previous anatomical investigation, hoping confidently to verify in the body deprived of life the truth of the observations he had made on the living; and, by comparing what he already knows of function with what he sees of structure, to decide on cause and effect; give reasons for absence, alteration, or modification of parts; in a word, to solve the difficult problem of the uses of the parts in animal bodies*.

In this complicated and extended inquiry, which has endured now so many thousand years, it has not unfrequently happened, that the most experienced observers in the field of inquiry have forgot the sources of their knowledge, when they fancied themselves in possession of laws conclusive as to animal structure;

* The presence of certain generative organs in the male and female, and of the hyoid bones, in the Mammalia, together with nearly *all rudimentary organs*, including the swimming-bladder of fishes, urinary bladder in the same animals, &c. have hitherto defied the attempts of all anatomists to explain. Mr HUNTER said that "Nature was fond of analogy;" and so, I presume, in sport, placed organs in animals which seemingly performed no functions; but these explanations will not pass current now, I presume, with any one who pretends to any physiological judgment.

laws regulating the presence or absence of organs, and sufficiently accurate and extended, to enable them to decide *à priori* on structure; or, to state the problem in the language of the mathematician, “from a given part of the structure, to describe the whole.” To me it appears that the question of organization is not to be solved in this way. We may determine, by such means, unknown quantities, and the greater number of questions in physics and mechanics, because their laws are already so well made out, that, generally speaking, there are no real exceptions to these laws, and, above all, every possible combination, if I may so express myself, is already known to the inquirer; but to me it seems quite different with living organized bodies. The possible combinations of form have not been fully determined; exceptions which, though not real, have all the force of reality until they shall be explained, are too numerous; they exist to a degree that the memory can no longer retain them, so that every thing like system and general laws is lost. Let not the anatomist then deceive himself and others. The high authority which would persuade us, that from a small portion of bone we may determine the form, the anatomy, the natural history, the antiquity of an unknown animal, I altogether disregard,—supporting my seeming neglect of such well-earned reputation, by the strong conviction which naturally arises in my mind, from an extent of anatomical inquiry into the structure of almost every kind of animal at present found to inhabit the earth’s surface; an inquiry extended now to rather more than fifteen years.

I shall bring these observations to a conclusion by remarking, that the anatomy and natural history of any species of animal, fully observed, and made out satisfactorily, may enable us to decide on the anatomy and natural history of an animal unknown to us, provided they accord entirely, or nearly so; that, more especially in some natural families, such as the strictly carnivorous tribe, a tooth, a fragment of bone, or other remains of structure,

may enable us to conjecture, with some shew of probability, that the animal, whether fossil or otherwise, may have been specifically or generically allied in a certain degree to those with which we are already acquainted; and we may even admit as certain, that a hoof, such as that of the horse or ox, never yet was combined with other structures implying carnivorous habits. Neither will it require any great stretch of the imagination to believe that animals having the bulk of the mammoth could not possibly subsist amidst the frozen regions of Siberia; nor that plants, having a seeming resemblance to our present inter-tropical vegetable kingdom, could possibly grow and flourish in regions doomed to a comparative absolute sterility, and to a dwarfish stunted vegetable growth. To theories of this kind we may fairly object, that heat is essential to life; and to theorists of another kind, who venture to declare *à priori*, and without having any knowledge of the animal previously, its anatomy, and its natural history, from the observance of a portion of the hide, a fragment of the bones of the foot, a portion of the skull, a tooth, that they cannot produce a single instance of their having ever done so in a way so as not to admit of refutation, or at least of doubt. The claws and nail-bones of the sloth indicate nothing of its peaceful and frugivorous habits; and to assimilate its habits and anatomical structure with certain gigantic fossil remains is, not to use a harsher style of criticism, eminently imaginative and fantastic. The molar teeth of bears are not carnivorous molar teeth; and it is by the observation of the living species only that we have become aware of the frugivorous habits of some, and of the strictly carnivorous habits of the polar species. To speculate from such facts as these as to the anatomy and natural history of the extinct *Ursus spelæus*, must, to every reflecting mind, appear exceedingly ridiculous. The strength of the zygomatic arch of the dugong exceeds that of the lion, and yet how opposed are these animals to each other in their habits and gene-

ral economy. The habits even of genera closely resembling each other occasionally do not accord. Antelopes live in pairs, in small families, or congregated in thousands; the zebra is seen in groups only of two or three; whilst the quagga, resembling it so closely as to be often confounded with it, feeds in flocks on the wide extended plains of Africa. Lastly, by what fact in the internal or external structure of the hippopotamus could the anatomist have decided *à priori* that the animal was aquatic*.

Nor can we decide on the relations of different organs or structures to each other. We cannot predict, for example, that an animal will necessarily ruminate, because we find its upper jaw unprovided with incisive teeth, nor that there is any constant relation between these two circumstances. There is nothing in the anatomy of the skeleton or dentition of the horse which can lead an anatomist to decide *à priori* on the probable form of the stomach of that animal; and, I would ask, where are the data by which we could determine the form of the stomach in the quadrumana, the larger pachydermata, including the pig, the puzzling animals of Australia, and of numerous others, unnecessary to particularize here? Where is the anatomist who would

* Though the camelopardalis has now been known to man for some thousand years, no anatomist in the world could have predicted the form of its stomach previous to dissection.

The stomach of the hippopotamus is complex; that of the rhinoceros simple; yet their food is similar. I know of nothing in the form of the skeleton or other structures which, being presented to the anatomist separately, and unconnected with its other parts, could enable the anatomist to decide on the nature of any of these animals without an exact examination of the whole of the structure, and a knowledge of their habits, drawn from observation of the living species; and if, in the examination of fossil remains, we venture to pronounce dogmatically on a few of the best made out genera, and declare such a bone to belong to the hyæna tribe, such another to the tiger, elephant, and so on, such opinions are after all but probable conjectures, unfitted by their nature to form a basis for a solid theory of animal bodies. Moreover, they cannot go beyond mere generalities.

venture to declare the form of the stomach in any of the Cetacea, unless he had actually seen it, or read its description by others? Surely no one will believe that the mouth of the dolphin, armed with teeth for catching and holding its prey, and that prey obviously animal, would lead any one to conjecture that the dolphin possesses a stomach more complicated than the ox, whose stomach is declared, foolishly enough, to be quadruple, *because of its living on vegetable food.*

If we now advert to the assigned causes of structure, we shall find them equally untenable, equally unphilosophical. The quadruple stomach of the ox and sheep is said to compensate for the deficiency of the incisor teeth; but the camel has teeth of this kind, and its stomach is quintuple. The causes, then, of nearly all structures are concealed, as yet, by an impenetrable veil from human sight, leaving only a few great and general laws applicable to animal nature, but so loosely as greatly to diminish their value. It is not with animal machines as with a watch or other piece of human mechanism, wherein the purpose of its creation is expressly known and understood, and the reason, which, moreover, is purely a mechanical one, for the presence of each wheel and pivot, chain and box, made known to us by the mechanist, or discovered on investigation. The animal machine abounds with structures, the reason for whose presence he cannot guess at, neither can he calculate what might be the result of their absence or destruction. That design generally, in the complex machinery of animal bodies, is too obvious to require even a thought; but the attempts at particularizing the particular design connected with separate individual organs, seem to me hitherto to present a series of the most lamentable failures in human reasoning. I do not hesitate to declare nearly all the systems hitherto built on these opinions as so many systems of false philosophy, of which some are below criticism, and others of a pernicious tendency. There are persons who believe that

the blubber of the whale is placed in the animal by Nature, to render the animal buoyant; and that the rudiments of mammae are placed on the human male breast to warm and cherish the heart, and also for the sake of ornament. I feel, of course, that to persons whose physiology is of this cast, all my previous remarks must appear puzzling and contradictory; but they will not, I trust, appear the less unimportant that they are not fully understood by those whose habits of loose reasoning induce them to grasp at the first explanation of a phenomenon which presents itself to their minds*.

SECTION II.

We are now prepared, divested of the prejudices of ages, and of false dissections, and of popular, and necessarily false, theories, to enter on the inquiry of the physiological character of the stomach in two animals, than which, in many respects, there are none more interesting now inhabiting the globe. The Camel, known to all antiquity,—the ship of the desert, as it has been styled by poets and by poetical writers,—the medium of communication betwixt countries separated by deserts which neither man nor animal could traverse in safety without its aid: patient under fatigue, and temperate in regions where universal aridity, eternal drought, and an almost insupportable heat, demands of every thing living an excess in the use of liquid nourishment; these are the qualities known through all ages as characteristic of this animal. On the other hand, the Lama, performing in mi-

* Mr HUNTER used to explain the presence of parts and structures in animal bodies, whose presence were obviously not requisite, by the highly figurative, and to me unintelligible, phrase, that "Nature placed them there because she delights in analogies."

niature, as it were, to the ancient Peruvians those services rendered in a much more efficient manner by the congenerous animal of the Old World, but still a kind of camel, as I may so express myself,—a camel of the New World,—a miniature of the camel of the desert, as the puma is to the lion,—possessing similar qualities ; patient under fatigue, and temperate beyond what has been told, even in exaggeration, of the ancient animal of the Arabian desert.

This is the *knowledge*, the previous knowledge, drawn from history and observation, with which the anatomist proceeds to search for, in the structure of the animal, the reasons for its temperance. The first essays were to discover the sac or bag (for the early and even late notions on this matter were extremely coarse) in which the animal was supposed to deposite the water drank in large quantities, and at long intervening periods, as if really laid up in store for future use. Now, fluids pass first into the stomach ; and to this organ, therefore, the anatomist first directs his researches, delighted, no doubt, to find that there should exist in it a structure seemingly explanatory of this theory, seemingly conformable to the habits of the animal, unlike what exists in other animals, and referrible, therefore, in this view, to this cause only. It seems to have been forgotten, in this hurry to explain function from structure, that it was first to be proved that a liquid could remain for several days contained within a living organ, adapted apparently for absorption, without being removed or absorbed, agreeably to the laws of mucous membranes. This difficulty, however, was readily overlooked, and yet there are only three experiments recorded, in which it is pretended that any water was found, after the lapse of a few days, in the stomach of the camel : the first by BRUCE, with most questionable authority ; the second by DAUBENTON, who found water in the stomach of the camel ten days after the death of the animal ; the third, too rude I fear to figure as a phi-

losophical experiment, was made in the apartments of the Royal College of Surgeons in London, and is thus detailed : “ A camel, in a dying state, was purchased by the College of Surgeons. The animal gradually grew weaker, and was at length killed, after being excited to drink three gallons of water, having taken none for three days previously. Its death was immediate, for it was pithed, or instantly deprived of sensibility, by passing a poniard between the skull and first vertebra of the neck. Its head was fixed to a beam, to prevent the body falling to the ground after it was dead. The animal was kept suspended that the viscera might remain in their natural state, and in two hours the cavities of the chest and abdomen were laid open.”

It seems hardly necessary to add, that a good deal of water was found in the animal's stomach, just as would have happened in any other animal, treated in a similar way, whatever might be the structure of the organ. Fluids often disappear, in some animals, from the stomach with great rapidity, but they also occasionally remain nearly unaltered as to quantity and quality ; and all this takes place in so capricious a manner, that no anatomist would venture to predict the actual condition of the contents of the stomach after death in any case whatever.

It is obvious, then, that the function of the camel's stomach, if it really be a function appertaining to it, by which the animal is enabled to maintain such sobriety amidst the arid wastes of Africa and Arabia, was not a discovery which flowed from the examination of structure ; but that the structure being peculiar, it was inferred that such must be its function, for the only reason I can discover that no other function could be assigned to it.

Having got rid of these errors, and traced the hypothesis to its source, we shall proceed to examine that structure, first in the camel, and secondly in the lama, proving, I trust, beyond all doubt, that they strictly and exactly resemble each other, and that whatever faculty the one possesses the other also must en-

joy, if there be the smallest truth in the law, that similar and analogous parts must perform similar functions.

The Camel.

The discovery of the peculiar anatomy of the camel's stomach is not a discovery of modern times. PERRAULT, in the *Memoirs of the French Academy*, describes the stomach of the camel with tolerable accuracy; but it was reserved for DAUBENTON to finish a monograph, which, for accuracy of detail and shrewdness of observation, cannot be excelled. The facts discovered by DAUBENTON were re-examined very lately by Sir E. HOME, and found to be strictly accordant with nature. The learned and modest assistant of BUFFON had absolutely omitted nothing. M. CUVIER, indeed, has not deemed it necessary to quote DAUBENTON'S description in his great work on *Comparative Anatomy*, and has given us in its place the dissection of the stomach of the foetus of a lama; but this, I trust, in this country at least, will not be deemed derogatory of DAUBENTON'S merit, more particularly if it be shewn that his monograph on the stomach of the camel is admirable. But, first, with regard to the dissections of PERRAULT and of his coloborateurs, the Parisian dissectors, as they are sometimes called.

“The ventricle,” say they, “which was very large, and divided into parts (39), as in the other animals which ruminate, had not that different structure which is observed in the stomachs of the strictly ruminants, or ox and sheep. They were only distinguished by some straitenings, which made that the first ventricle, if large and bent, produced another very small one, which was followed with a third somewhat less than the first, but much longer, and this was followed by a fourth like to the second.

“At the top of the second ventricle, there were several square

holes, which were the orifices of about twenty cavities, made like sacs, placed between the two membranes which do compose the substance of this ventricle. The view of these sacs made us think that they might well be the reservatories where PLINY says camels do a long time keep the water which they drink in great abundance, when they meet with it, to supply the wants which they may have thereof in the dry deserts, where they are used to travel, and where it is said that those which do guide them are sometimes forced, by extremity of thirst, to open their belly, in which they do find water."

We do not find in this description that remarkable accuracy and minuteness of description, which so very generally characterize their memoirs. They have not stated, as they ought to have done, and was afterwards discovered and perfectly described by DAUBENTON, that the distended stomach presents an appearance of four stomachs, but, when opened, there are found to be five; that the paunch abounds with large cells, as well as the second stomach (which DAUBENTON also called the reservoir); that the third stomach, which was *also discovered by DAUBENTON*, and admirably depicted in his works, is exceedingly small, and forms a kind of rudiment of the king's-hood of the strictly ruminants. Moreover, he explained very beautifully the structure of those deep square cells, with apertures surrounded by bundles of muscular fibres, in which he says he found abundance of fluid, a structure which seemed to retain the water like a sponge. Two or three pints of clear and almost insipid water were found in the cells of the second stomach, ten days after the death of the animal. He concludes, then, that the second stomach, or reservoir, is a stomach superadded to the others in the camel, for the express purpose of a reservoir. To these descriptions of the stomach of the camel, DAUBENTON added drawings of inimitable accuracy. The ingenious and elegant popular writer of the article "Menagerie," in the Library of Entertaining

Knowledge, has fallen into a great error, by not consulting what DAUBENTON has said, and by trusting to the remarks of those who fancied their interests and vanity served by an ill-judged and totally erroneous criticism upon the works of that eminent observer. The transverse contraction of the fourth cavity, whereby it is obviously divided into two stomachs, distinguished by this circumstance, which alone, according to the more generally received views, would entitle us to consider this elongated cavity to be divisible into a fourth and fifth stomach; this transverse contraction was discovered by DAUBENTON, and particularly dwelt on by him; and, when he offered it as his opinion that there exist five stomachs in the animal, he grounded that opinion on views which no real anatomist can possibly call in question.

The Lama.

I come now to describe the structure of the stomach of the adult lama. M. CUVIER and Sir E. HOME have had opportunities of describing only that of the foetus, and if our descriptions differ, as they do most materially, it will not, I imagine, surprise any one, for assuredly it must be known to all zoologists, that the stomach of the foetus and of the adult animal seldom correspond.

The cavity which we may term the first stomach or paunch, is, in the adult lama, of great capacity, and seemed to me to bear the same relation to the bulk of the animal as the paunch does in other ruminating animals; it was, in the instance which came under my notice, filled with oats, on which kind of food the animal had been last fed. In the structure of this cavity there was first the external or peritoneal covering, the muscular tunics more internally, and, still deeper, the cellular and mucous layers. The inner surface, throughout a considerable extent of

surface, is smooth, but there likewise are two very considerable portions occupied by rows of cells, which I shall now describe.

In the larger collection of cells there are sixteen rows, but the rows vary much in length, and, besides, the cells are of varying depth. In some of the rows there are twenty cells, and the depth of each, if the stomachs were distended, may vary from half an inch to about three-fourths. They all open towards the stomach, seem lined by the general mucous membrane of the cavity, altered however somewhat in its appearance and probably texture; the rows are further divided from each other by very powerful bundles of muscular fibres, whilst each pair of cells is separated from those which precede and follow by muscular fibres also, which however, as may be observed in the accompanying delineations, are much weaker than the powerful muscles which separate and divide the *rows of cells* from each other. The action of these muscular fibres must be to shut the mouths of the cells, and to form of them at times, it may be presumed, cavities distinct from the general cavity of the stomach.

The smaller collection of cells is similar in most respects to the larger. There are here twenty rows of cells, but they are much shorter, and the individual cells are obviously much shallower. In other respects their structure corresponds to those already described. Two powerful muscular bands lead in such a way from the gullet towards the third stomach, as to enable the animal at will to cause the food, after remastication, to pass at once (by converting the open groove into a complete canal) into the third stomach—a structure at least altogether like this is found in the stomachs of the ox, sheep, and camel, and this is the function which anatomists have assigned to it.

The first stomach communicates with the second by an aperture, sufficient to allow the hand to pass through. This second stomach, which is of considerable magnitude, is almost entirely composed of cells, but they are scarcely so deep. They differ also

somewhat in structure, and the muscular bands for closing their apertures are not so powerful as in those of the first stomach.

The second stomach opens into the third by an aperture somewhat larger than the finger. The third stomach is, together with the cellular character of the first and second, that which in a peculiar way assimilates the camel and lama. It is a small surface, marked by elevations which cross each other at right angles, and seem to occupy merely the upper part of what I call the fourth stomach, there being no contraction betwixt it and the fourth; but DAUBENTON shewed long ago in the camel, that this *surface* is actually a stomach, and the fact is now admitted by all anatomists*. What its nature or function may be, it seems impossible to conjecture; there is no natural contraction betwixt it and the stomach which follows, which we shall call the fourth stomach.

This cavity is characterized by longitudinal folds in the axis of its tube. They are about twenty in number, and of tolerable regularity. Between the fourth and fifth stomachs there is a natural contraction, and this latter cavity is further characterized by having a smooth, soft, and, as it were, pulpy mucous surface, destitute of cells, furrows, ridges, or prominences of any kind. The pyloric orifice of the stomach resembles that in other ruminants, and the duodenum is at first slightly dilated.

In no part of its anatomy, then, does the lama more closely resemble the camel than in the structure of its stomach.

It may here be asked, what proofs have we that the lama possesses the same power of abstinence from drink as the camel? To this it may be answered, that a similar structure ought to produce a similar result; and although I do not myself consider it as satisfactorily made out, that the mechanism by which the

* The calling it a *rudimentary* stomach, analogous to one found in the ox, sheep, and common ruminants, does not elucidate the matter greatly.

camel and lama can each refrain from drinking for so long a period, depends altogether on the structure of the stomach ; yet it is not improbable that it may in part be connected therewith. Many travellers report that the lama never drinks ; and a foreign writer (Father FEUILLE') is quoted, as describing the stomach to be not only provided with a large reservoir for carrying water, but that, like the stomach of the camel, it has the same machinery for allowing the separation of solid from liquid aliment. I have not been able to find a complete copy of FEUILLE's work, so that I cannot support what I have said by his remarks ; but surely there can be no occasion for this, since the actual structure I now describe at this moment lies before me.

SECTION III.

I HAVE hitherto, in conformity with the language used by anatomists, spoken of single, double, triple, quadruple, and quintuple stomachs, as if there were such in nature ; but I do not believe so. The stomach of all animals is a single organ : it may be divided into various compartments, as in the ruminants, the camels, and in the cetacea, and these may have their specific uses. One may be intended slightly to affect the alimentary mass first received into it ; a second to alter it still further by its juices ; a third may be intended merely to prolong its residence within the canal ; and a fourth finally to convert it into that semifluid condition, into which it is presumed finally to be changed, previous to its passage into the intestinal tube, but still it is but one organ ; nor have I ever heard it affirmed by any one, that the complex quadruple stomach did more than the simple stomach, in affecting the material of our nourishment, or bringing it nearer to perfection. I presume, therefore, that the organ is single in every important sense of the word, and

that the phraseology of two, three, or four stomachs is altogether incorrect. We have seen that no anatomist of ancient or modern times could ever predict what kind of stomach would necessarily be found in any animal previous to its having actually been examined. The stomach of the elephant presents one large cavity ; the elephant has no cutting incisor teeth in either jaw. The stomach of the horse is single, as the phrase goes, if we require that a stomach to be considered double must be divided by a permanent contracted interval into two cavities, communicating with each other by an aperture smaller in diameter than either ; but if to constitute a double stomach, it be merely necessary that its interior should present differently organized surfaces, then the stomach of the horse is double. The hippopotamus has, if I remember right, a kind of three cavities or stomachs, as they are called, judging by the number of culs de sac or compartments ; for I could not observe, in the interior of these cavities, any great difference as to structure ; but it seems to me impossible to say how many stomachs the seal or pig may be considered as entitled to ; externally, indeed, they seem to have but one ; internally they present valvular projections and a diversified structure, setting at defiance all the usual anatomical nomenclature as to this organ.

Man is considered as having a single stomach, but this is not unfrequently found contracted about the middle, so as to divide the cavity, as it were, into two, by means of a narrow contracted portion. If this be constant during the digestion of the food, as some have supposed, we might almost venture to call the human stomach double ; but in truth it is not so, and is a phenomenon which takes place only occasionally and in certain individuals ; it is a deviation from the ordinary human structure, but of the simplest kind,—an irregularity in man, a regular structure in certain of the lower animals, that structure being, as it is so often, persistent in them, which in him is only fugacious.



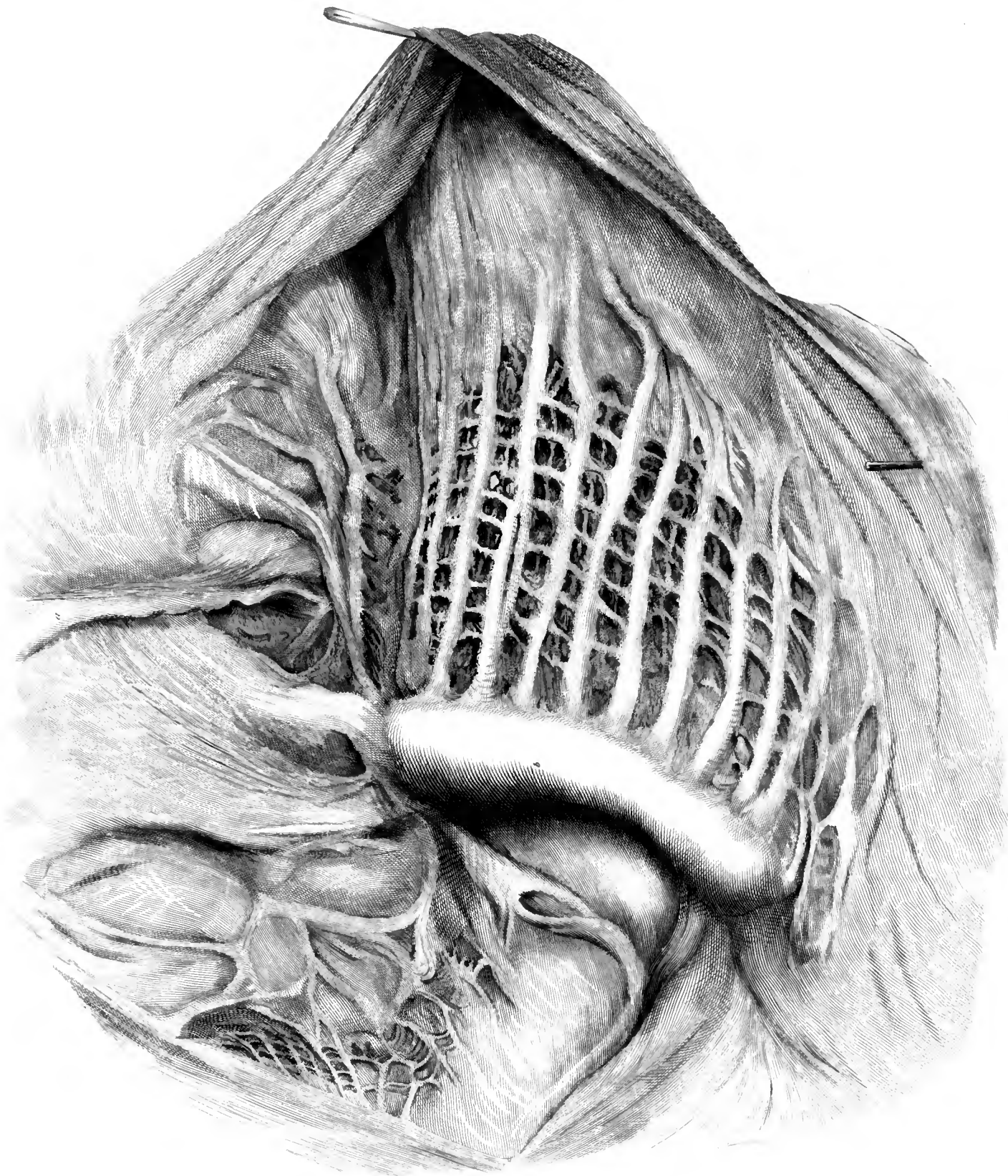

Till anatomists have determined what is to constitute a double, what a single stomach, or until they have corrected their nomenclature, let us consider the stomach in all animals as a single organ, varying with the species, performing a single function, and not to be determined on *a priori*, by any doctrine, anatomical or physiological, nor by any pretended necessary relative dependence upon any other co-existing anatomical structures.

EXPLANATION OF PLATES XVI. XVII. AND XVIII.

PLATE XVI.

Fig. 1. A view of the paunch or first stomach laid open: the larger assemblage of cells is represented with great care, and a portion of the smaller may also be seen; the strong muscular bands dividing the rows of cells from each other, and the cross slips of fibres separating the cells individually and in pairs.

a points out a strong band of muscular fibres, which extends from the gullet to the extreme of the third stomach; and

b marks a still stronger assemblage of muscular fibres, which form, as it were, a base, from whence the numerous bundles of fibres dividing the rows of cells from each other proceed. The extremity of this bundle of fibres may also contribute towards the formation of the channel or groove spoken of in the text at page 15.

PLATE XVII.

- Fig. 1. Shews the larger assemblage of cells in the paunch, drawn with great care, so as to explain their form, size, and, above all, the correct arrangement of the bundles of muscular fibres.
- Fig. 2. Is intended to shew the termination and ultimate course of the muscular apparatus of the cells. Towards the upper margin the fibres gradually widen and separate from each other, sweeping around in concentric circles. They are ultimately lost in the general muscular tunics of the stomach.

PLATE XVIII.

- Fig. 1. The cells of the paunch of the natural size.
- Fig. 2. Points out the structure of the cells in the second stomach, which has been laid open; the narrow contracted passage, leading to the third and fourth stomachs. The third stomach is marked *a*, and the upper part of the fourth is marked *b*. They are distinguished from each other merely by their structure, there not being any contracted portion to form them into distinct cavities.
- Fig. 3. Shews the termination of the fourth stomach, and the whole of the fifth, laid open: the structure of these cavities has been sufficiently described in the text.

Fig. 1.

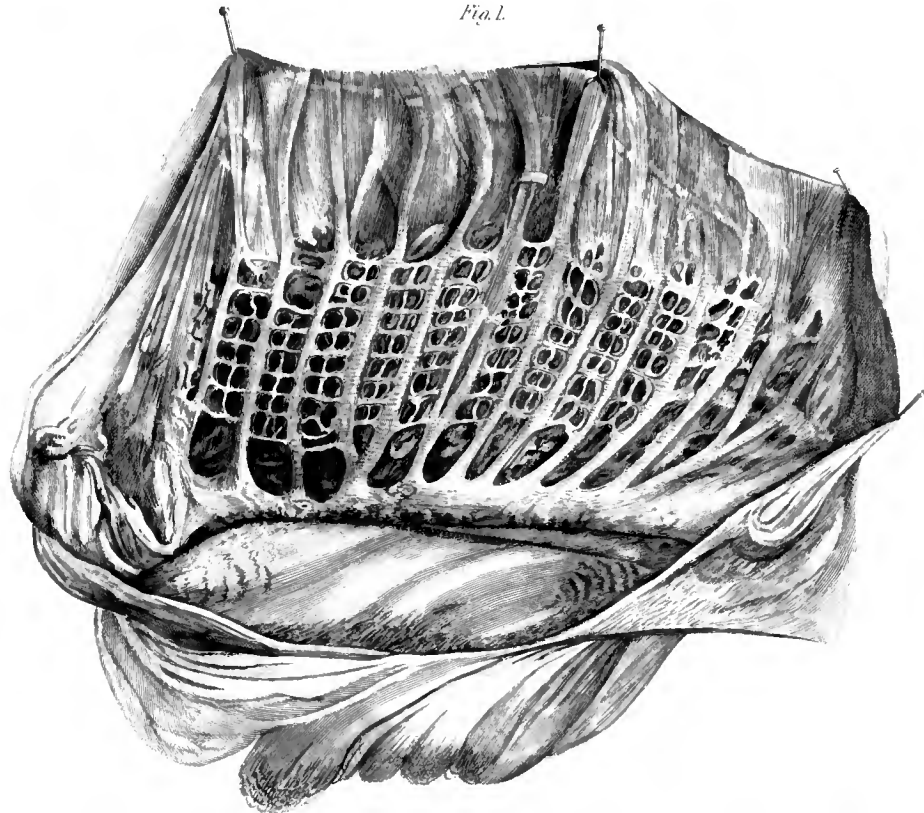

Fig. 2.

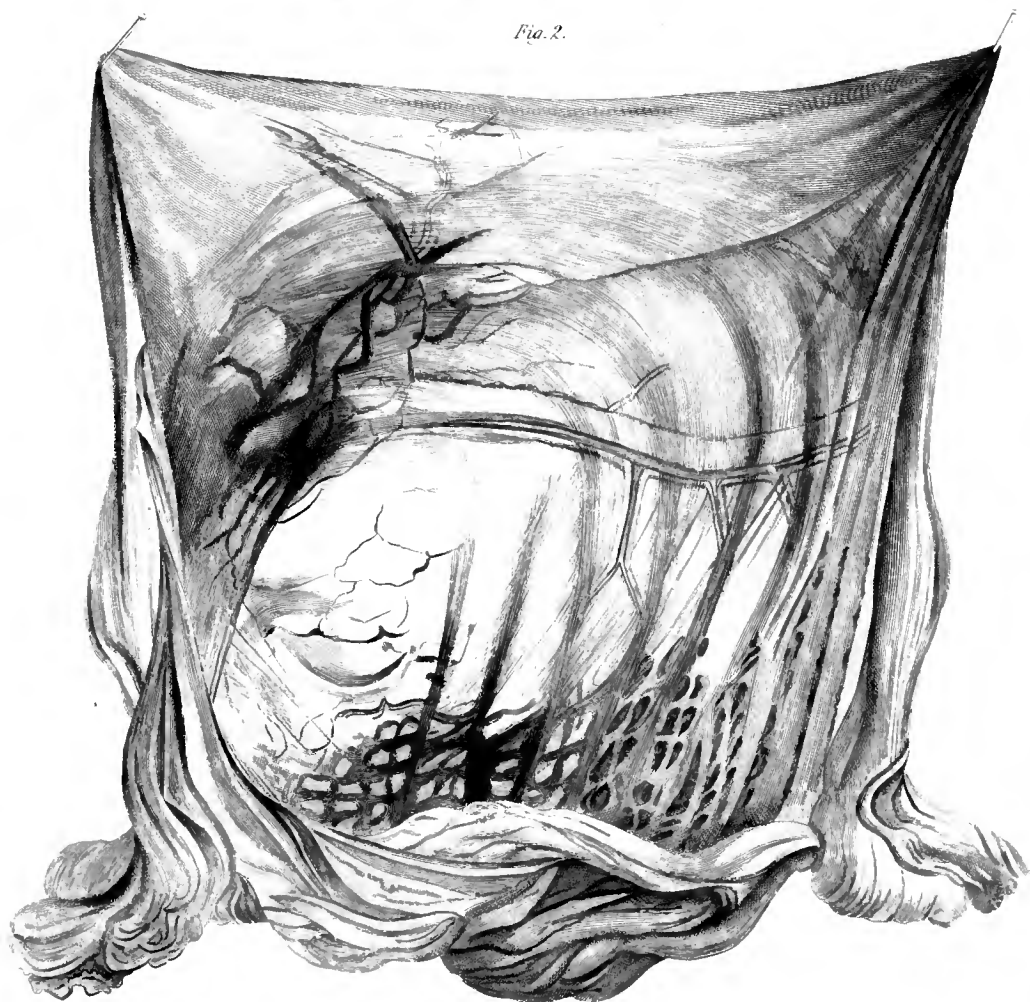



PLATE XVIII.

Fig. 1.

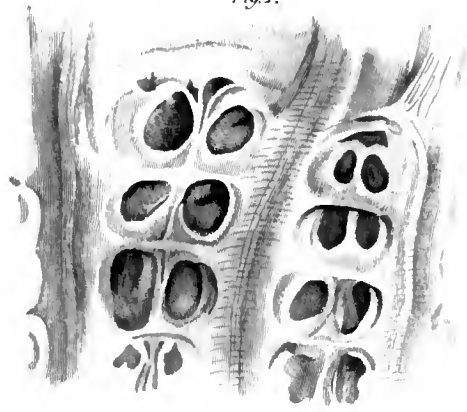

Fig. 2.

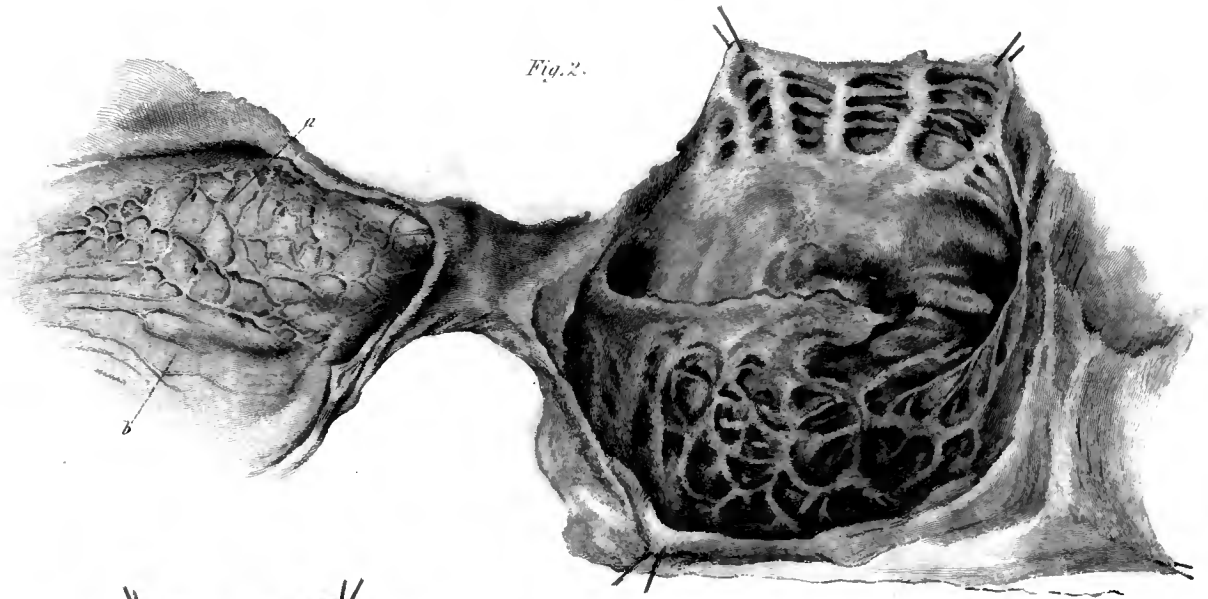
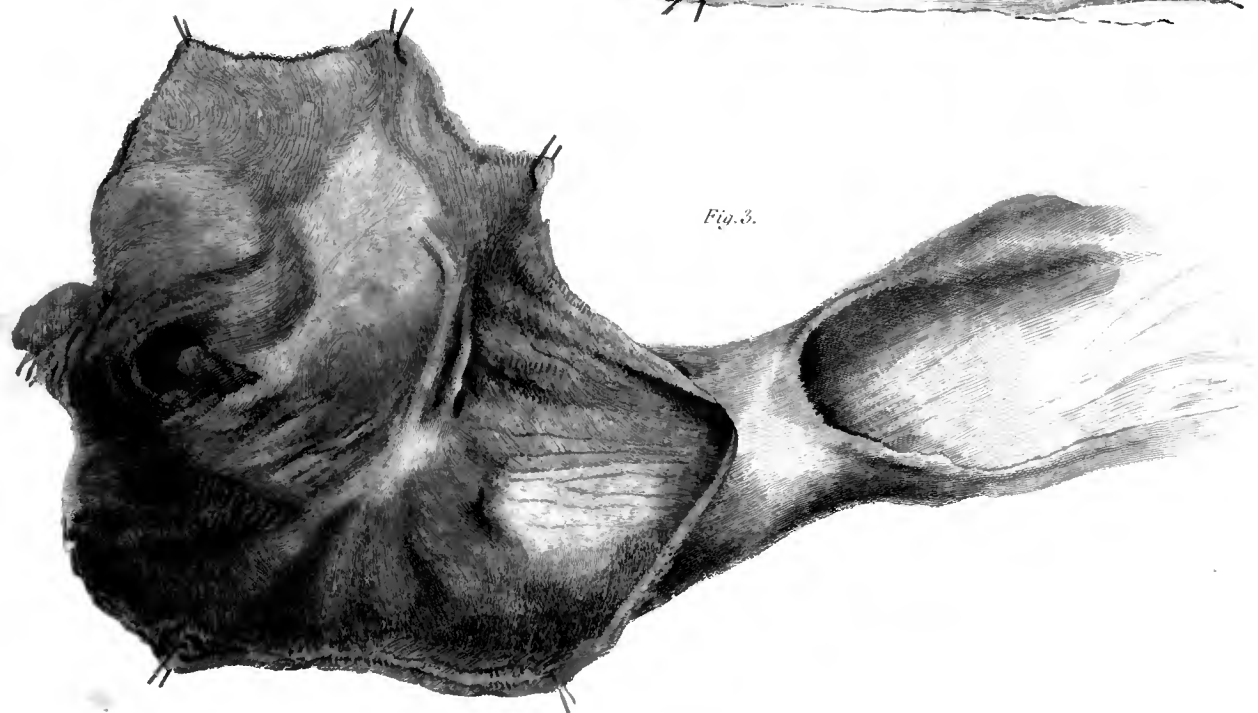

Fig. 3.





PROCEEDINGS

OF THE

EXTRAORDINARY GENERAL MEETINGS,

AND

LIST OF MEMBERS ELECTED AT ORDINARY MEETINGS,

SINCE MAY 1. 1826.

PROCEEDINGS, &c.

November 27. 1826.

At an EXTRAORDINARY GENERAL MEETING held this day, Dr HOPE in the Chair, the following Office-Bearers were elected for the ensuing year :

SIR WALTER SCOTT, Bart. President.

Right Hon. LORD CHIEF-BARON,	}	Vice-Presidents.
Hon. LORD GLENLEE,		
Dr T. C. HOPE,		
Professor RUSSELL,		
Dr BREWSTER, General Secretary.		
THOMAS ALLAN, Esq. Treasurer.		
JAMES SKENE, Esq. Curator of the Museum.		

PHYSICAL CLASS.

Hon. LORD NEWTON, President.

JOHN ROBISON, Esq. Secretary.

COUNCILLORS FROM THE PHYSICAL CLASS.

Sir WILLIAM FORBES, Bart.

Dr TURNER.

Dr HOME.

Sir T. M. BRISBANE, K. C. B.

Professor WALLACE.

Dr GRAHAM.

LITERARY CLASS.

HENRY MACKENZIE, Esq. President.

P. F. TYTLER, Esq. Secretary.

COUNCILLORS FROM THE LITERARY CLASS.

Right Hon. Sir W^M. RAE, Bart.

Dr HIBBERT.

Sir HENRY JARDINE.

LORD MEADOWBANK.

Sir JOHN HAY, Bart.

THOMAS KINNEAR, Esq.

The following Gentlemen were appointed a Committee to audit the Treasurer's Account:

Sir HENRY JARDINE,

Sir WILLIAM ARBUTHNOT, Bart.

On the motion of Mr ALLAN, the Meeting recommended to the Committee already appointed for this purpose, to use all diligence in obtaining payment of the Money due by the College Trustees to the Society.

It was moved by Sir HENRY JARDINE, and unanimously agreed to, that the thanks of the Society be given to the Committee for superintending the furnishing, &c. of the Society's apartments. The thanks of the Society were accordingly given by the Vice-President to THOMAS ALLAN, Esq., JAMES SKENE, Esq., and ROBERT STEVENSON, Esq., the Members of the Committee.

 ORDINARY MEETINGS.

December 4. 1826.

MEMBERS ELECTED.

ORDINARY.

GEORGE MOIR, Esq, Advocate.

JOHN STARK, Esq.

At this Meeting the President announced that the Library would now be always open, and accessible to the Members; but that the privilege of using it must necessarily be confined to the Fellows of the Society.

On the motion of Mr STEVENSON, C. E., the thanks of the Society were unanimously voted to Mr W. H. PLAYFAIR, for the skill and taste he has displayed in the arrangement of their new premises.

February 5. 1827.

MEMBERS ELECTED.

ORDINARY.

JAMES WEDDELL, Esq. R. N.
 JOHN GARDINER KINNEAR, Esq. Edinburgh.
 WILLIAM BURN, Esq.

March 5. 1827.

MEMBERS ELECTED.

ORDINARY.

Dr JAMES RUSSELL, Edinburgh.
 PRIDEAUX JOHN SELBY, Esq.
 HENRY WITHAM, Esq.
 JOHN REDDIE, Esq. LL. D. Edinburgh.
 The Rev. Dr ROBERT GORDON, Edinburgh.
 JAMES WILSON, Esq. Edinburgh.

HONORARY.

J. BERZELIUS, M.D. F.R.S. Lond., Professor of Chemistry at Stockholm.

FOREIGN.

JOHN JAMES AUDUBON, Esq. M. W. S.

April 2. 1827.

MEMBERS ELECTED.

ORDINARY.

The Rev. EDWARD BANNERMAN RAMSAY, A. B. of St John's College,
Cambridge.

JAMES WALKER, D. D. of St John's College, Cambridge.

May 7. 1827.

MEMBERS ELECTED.

ORDINARY.

ALEXANDER COPLAND HUTCHISON, Esq. Surgeon.

GEORGE SWINTON, Esq. Secretary to Government, Calcutta.

November 26. 1827.

At an EXTRAORDINARY GENERAL MEETING held this day, Sir WALTER SCOTT, Bart. in the Chair, the following Office-Bearers were elected for the ensuing year :

Sir WALTER SCOTT, Bart. President.

Right Hon. LORD CHIEF BARON,	} Vice-Presidents.
Hon. LORD GLENLEE,	
Dr T. C. HOPE,	
Professor RUSSELL,	
Dr BREWSTER, General Secretary.	
THOMAS ALLAN, Esq. Treasurer.	
JAMES SKENE, Esq. Curator of the Museum.	

PHYSICAL CLASS.

Hon. LORD NEWTON, President.

JOHN ROBISON, Esq. Secretary.

COUNCILLORS FROM THE PHYSICAL CLASS.

Professor WALLACE.

Dr GRAHAM.

Dr TURNER.

JAMES HUNTER, Esq.

Sir T. M. BRISBANE, K. C. B.

Dr ALISON.

LITERARY CLASS.

HENRY MACKENZIE, Esq. President.

P. F. TYTLER, Esq. Secretary.

COUNCILLORS FROM THE LITERARY CLASS.

Sir JOHN HAY, Bart.

THOMAS KINNEAR, Esq.

Dr HIBBERT.

Sir WILLIAM HAMILTON, Bart.

Hon. LORD MEADOWBANK. Rev. Dr BRUNTON.

Dr BALLINGALL, Dr GRAHAM, and Mr ROBISON were appointed a Committee to examine and report on the Treasurer's Accounts.

Dr GRAHAM gave notice of a Motion to alter the 17th Law, in so far "as to do away the appointment, at future elections, of Presidents to the Physical and Literary Classes, and to add two to the present number of Vice-Presidents."

Dr GRAHAM explained, that, as according to the present practice of the Royal Society, there never were any separate meetings of these Classes, the persons on whom the distinction of being appointed Presidents is conferred, can never be called on to take the Chair, and that it would therefore be better that they should be added to the number of Vice-Presidents, when they would in turn preside in the absence of the President.

The Motion was ordered to lie on the table until the first Ordinary Meeting in January.

Mr ALLAN represented that some means of warming and ventilating the Society's apartments, by heated air, would be conducive to the comfort of the Members, and to the preservation of the property of the Society, and suggested that a small Committee

should be named to consider and report on the practicability of some plan for this purpose. The Meeting, on considering this suggestion, appointed

Dr HOPE,	Mr PLAYFAIR, and
Mr J. JARDINE,	Mr ROBISON,

to be a Committee for this purpose.

Mr ROBISON intimated, that he had received a Letter from Mr WATT, of Soho, mentioning that he was preparing (with the purpose of presenting it to the Royal Society) a copy of Sir WILLIAM BEECHEY'S Portrait of his Father, the late Mr WATT. The Meeting expressed their gratification at this communication, but deferred noticing it until the arrival of the Picture.

Mr ROBISON was directed, in the absence of the General Secretary, to open the Letters, &c. which may be received, and to take the necessary steps for forwarding the business of the Society.

ORDINARY MEETINGS.

January 7. 1828.

MEMBERS ELECTED.

ORDINARY.

Sir FRANCIS WALKER DRUMMOND, Bart.
Sir WILLIAM G. GORDON CUMMING, Bart.

The Vice-President communicated to the Society, that the Council had, after due investigation, adjudged the first Biennial Prize, from the donation of the late Mr KEITH, to Dr BREWSTER, for his Papers on his discovery of two new immiscible Fluids in the cavities of certain Minerals.

.February 4. 1828.

MEMBERS ELECTED.

ORDINARY.

ERSKINE D. SANDFORD, Esq. Advocate.
 DAVID MACLAGAN, M.D. Edinburgh.
 JAMES CRAUFURD GREGORY, M.D. Edinburgh.
 Sir ALEXANDER KEITH, Knight Marischal.

Upon the motion of Sir HENRY JARDINE, it was resolved that the Council shall be empowered to enter into arrangements with the Council of the Antiquarian Society, for making such an exchange of any objects in their respective collections as may appear for the benefit of both.

March 3. 1828.

MEMBER ELECTED.

ORDINARY.

Captain MAXWELL, K. D. Guards.

April 7. 1828.

MEMBERS ELECTED.

HONORARY.

DAVIES GILBERT, Esq. M. P. President of the Royal Society of London.

FOREIGN.

Le Chevalier BOUVARD, F. R. S. Lond. Member of the Institute of France.

ORDINARY.

JOHN FORSTER, Esq. Architect, Liverpool.
 THOMAS GRAHAM, Esq. A. M.
 THOMAS HAMILTON, Esq.
 DAVID MILNE, Esq. Advocate.
 Dr MANSON.
 WILLIAM BURN CALLENDER, Esq.

EXTRAORDINARY GENERAL MEETING.

November 24. 1828.

At an EXTRAORDINARY GENERAL MEETING held this day,

Sir JOHN SINCLAIR, Bart. being called to the Chair,

Resolved,—“ That this Meeting approve of the change in the denominations of the Office-Bearers, recommended by Dr GRAHAM, on the 26th November 1827, and remit to the Council to make such verbal alterations in the Laws as may be requisite to put them in accordance with it.”

The Meeting proceeded to the election of Office-Bearers, when the following were appointed :

Sir. WALTER SCOTT, Bart. President.

Right Hon. the LORD CHIEF BARON,	}	Vice-Presidents.
Hon. LORD GLENLEE,		
Dr T. C. HOPE,		
Professor RUSSELL,		
Hon. LORD NEWTON,		
HENRY MACKENZIE, Esq.		

JOHN ROBISON, Esq. General Secretary.

P. F. TYTLER, Esq.	}	Secretaries to the Ordinary Meetings.
Rev. E. B. RAMSAY,		

THOMAS ALLAN, Esq. Treasurer.

JAMES SKENE, Esq. Curator of the Museum.

COUNCILLORS.

Sir T. M. BRISBANE, K. C. B.	Dr ALISON.
Hon. LORD MEADOWBANK.	Rev. Dr BRUNTON.
Dr GRAHAM.	Dr BREWSTER.
THOMAS KINNEAR, Esq.	Captain BASIL HALL, R. N.
JAMES HUNTER, Esq.	Sir HENRY JARDINE.
Sir WILLIAM HAMILTON, Bart.	Professor JAMESON.

In terms of the 21st Law, the following Committee was appointed to audit the Treasurer's Accounts :

THOMAS KINNEAR, Esq. (Convener.)
 PATRICK NEILL, Esq.
 JOHN ROBISON, Esq.

Sir JOHN SINCLAIR addressed the Meeting, and observed, that it would be improper to allow Dr BREWSTER to retire from the office he has held (with so much advantage to the Society, and honour to himself,) without testifying their sense of his merits; and he therefore moved, " That the Royal Society take the opportunity presented in the resignation, by Dr BREWSTER, of the office of Secretary, to offer him their best thanks for his zealous services, and for the numerous valuable communications with which he has enriched their Transactions, and by which he has contributed materially to maintain the reputation of the Society." This Motion was unanimously adopted.

Mr ALLAN said, that while he heartily concurred in this resolution, he thought that something more substantial than a vote of thanks should be offered to Dr BREWSTER, in return for the labour he had bestowed on the affairs of the Society; he therefore proposed " That the Council be requested to consider and report to a Special General Meeting, to be held in January next, the amount of pecuniary remuneration which they would recommend should be offered to Dr BREWSTER." This motion was likewise unanimously adopted.

Sir JOHN HAY suggested to the Meeting, " That, as it is highly desirable that the Society should possess a portrait of their illustrious President Sir WALTER SCOTT, he should be requested to sit to Mr GRAHAM for that purpose." The Meeting approved of this suggestion, and appointed Sir JOHN HAY, Mr SKENE, and Mr ROBISON to be a Committee for carrying it into effect.

Mr ROBISON intimated to the Meeting, that he intended to offer to the acceptance of the Society, a portrait of his Father, by the late Sir HENRY RAEBURN.

January 5. 1829.

At a Special General Meeting, the following communication was made by the Council:—

“ The Council have to report, that, in compliance with the first part of the remit made to them by the extraordinary General Meeting of the 24th November last, they have made the required alterations in the Bye-Laws, of which they now lay a corrected copy on the Table.”

“ They have further to report, that, after duly considering the second part of the remit, they unanimously agreed to recommend that the same amount, namely L.300, which was granted to the former General Secretary, Mr PLAYFAIR, should be presented to Dr BREWSTER.”

The Meeting unanimously approved of the Report, and adopted the recommendation.

COPY OF THE LAWS, AS CORRECTED BY THE COUNCIL.

I. THE ROYAL SOCIETY OF EDINBURGH shall consist of Ordinary, Foreign, and Honorary Members.

II. Every Ordinary Member, within three months after his election, shall pay Five Guineas as fees of admission, and Three Guineas as the first annual contribution; and shall farther be bound to pay the sum of Three Guineas annually into the hands of the Treasurer. All Members who shall have paid Twenty-five years' annual contributions shall be exempt from further payment.

III. Members shall be at liberty to compound for their annual contribution, by paying at the rate of ten years' purchase.

IV. Ordinary Members, not residing in Edinburgh, and not compounding, shall appoint some person residing in Edinburgh, by whom the payment of the said contribution shall be made, and shall signify the same to the Treasurer.

V. Members failing to pay their contribution for three successive years (due application having been made to them by the Treasurer), shall be reported to the Coun-

cil, and, if they see fit, shall be declared from that period to be no longer Members, and the legal means for recovering such arrears shall be employed.

VI. None but Ordinary Members shall bear any office in the Society, or vote in the choice of Member or Office-bearers, or interfere in the patrimonial interests of the Society.

VII. The number of Ordinary Members shall be unlimited.

VIII. The *Ordinary* Members, upon producing an order from the Treasurer, shall be entitled to receive from the Publisher, *gratis*, the Parts of the Society's Transactions which shall be published subsequent to their admission.

IX. No person shall be proposed as an Ordinary Member, without a recommendation subscribed by *One* Ordinary Member, to the purport below*. This recommendation shall be delivered to the Secretary, and by him laid before the Council, and shall afterwards be read at each of three ordinary meetings of the Society, previous to the day of the election, and shall lie upon the table during that time.

X. The *Foreign* Members shall not be subject to the Annual Contributions, nor to any Fee on admission. They shall be limited to the number of Thirty-six, and shall consist of Foreigners distinguished in Science and Literature.

XI. The *Honorary* Members shall not be subject to the Annual Contribution, nor to any Fee on admission. They shall be limited to the number of Twenty-one, and shall consist of persons eminently distinguished in Science and Literature.

XII. Any *Three* Members may transmit, through the Secretary to the Council, recommendations of Foreign and Honorary Members. Foreign and Honorary Mem-

* "A. B. a gentleman well skilled in several branches of Science (or Polite Literature, as the case may be), being to my knowledge desirous of becoming a Member of the Royal Society of Edinburgh, I hereby recommend him as deserving of that honour, and as likely to prove an useful and valuable Member."

This recommendation to be accompanied by a request of admission, signed by the Candidate.

bers may also be proposed by the Council, and they shall be elected in the same manner as the Ordinary Members.

XIII. The election of Members shall take place on the 1st Mondays of the month during the Session, at the ordinary meetings of the Society. The Election shall be by Ballot, and shall be determined by a majority of at least two-thirds of the votes, provided Twenty-four Members be present, and vote.

XIV. The Ordinary Meetings shall be held on the first and third Mondays of every month, from November to June inclusive. Regular minutes shall be kept of the proceedings, and the Secretaries shall do the duty alternately, or according to such agreement as they may find it convenient to make.

XV. The Society shall from time to time publish its Transactions and proceedings. For this purpose the Council shall select and arrange the papers which they shall deem it expedient to publish in the *Transactions* of the Society, and shall superintend the printing of the same.

The Transactions shall be published in Parts or *Fasciculi* at the close of each session, and the expense shall be defrayed by the Society.

XVI. There shall be elected annually for conducting the publications and regulating the private business of the Society, a Council, consisting of a President; Six Vice-Presidents, two at least of whom shall be resident; Twelve Councillors, a General Secretary, Two Secretaries to the Ordinary Meetings, a Treasurer, and a Curator of the Museum and Library*.

XVII. Four Councillors shall go out annually, to be taken according to the order in which they stand on the list of the Council.

XVIII. An Extraordinary Meeting for the Election of Office-Bearers shall be held on the fourth Monday of November annually.

* An Assistant Curator has since been added by a resolution of the Society on the 18th January 1830.

XIX. Special Meetings of the Society may be called by the Secretary, by direction of the Council; or on a requisition signed by six or more Ordinary Members. Notice of not less than two days must be given of such meetings.

XX. The Treasurer shall receive and disburse the money belonging to the Society, granting the necessary receipts, and collecting the money when due.

He shall keep regular accounts of all the cash received and expended, which shall be made up and balanced annually; and at the last Ordinary Meeting in January, he shall present the accounts for the preceding year, duly audited. At this Meeting, the Treasurer shall also lay before the Council a list of all arrears due above two years, and the Council shall thereupon give such directions as they may deem necessary for recovery thereof.

XXI. At the Extraordinary Meeting in November, a Committee of Three Members shall be chosen to audit the Treasurer's accounts, and give the necessary discharge of his intrusions.

The report of the examination and discharge shall be laid before the Society at the last Ordinary Meeting in January, and inserted in the records.

XXII. The General Secretary shall keep Minutes of the Extraordinary Meetings of the Society, and of the meetings of the Council, in two distinct books. He shall, under the direction of the Council, conduct the correspondence of the Society, and superintend its publications. For these purposes, he shall, when necessary, employ a clerk, to be paid by the Society.

The Secretaries to the Ordinary Meeting shall keep a regular Minute-book, in which a full account of the proceedings of these Meetings shall be entered: they shall specify all the Donations received, and furnish a list of them, and of the donor's names, to the Curator of the Library and Museum: they shall likewise furnish the Treasurer with notes of all admissions of Ordinary Members. They shall assist the General Secretary in superintending the publications, and in his absence shall take his duty.

XXIII. The Curator of the Museum and Library shall have the custody and charge of all the Books, Manuscripts, objects of Natural History, Scientific Productions, and other articles of a similar description belonging to the Society; he shall take an account of these when received, and keep a regular catalogue of the whole, which shall lie in the Hall, for the inspection of the Members.

XXIV. All articles of the above description shall be open to the inspection of the Members at the Hall of the Society, at such times, and under such regulations, as the Council shall from time to time appoint.

XXV. A Register shall be kept, in which the names of the Members shall be enrolled at their admission, with the date.

The above Laws were ordered to be printed and distributed among the Members.

ORDINARY MEETINGS.

January 5. 1829.

MEMBERS ELECTED.

ORDINARY.

ANDREW SKENE, Esq. Advocate.

A. COLYAR, Esq.

March 2. 1829.

MEMBERS ELECTED.

ORDINARY.

WILLIAM GIBSON CRAIG, Esq. Advocate.

CHARLES FERGUSON, Esq. Advocate.

JAMES EWING, Esq. LL. D. Glasgow.

DUNCAN MACNEILL, Esq. Sheriff-Depute of Perth.

Rev. JOHN SINCLAIR, A. M. Pembroke College, Oxford.

ARTHUR CONNELL, Esq. Advocate.

Rev. THOMAS SHEEPHANKS, A. M.

JAMES HOPE VERE, Esq. of Craigie Hall.

April 6. 1829.

MEMBER ELECTED.

ORDINARY.

BINDON BLOOD, Esq. M. R. I. A.

At this Meeting the Keith Prize, lately adjudged to Dr BREWSTER, was presented to him, with an appropriate address from the Chair. The Prize consisted, agreeably to the terms of the donation, of a Medal and a piece of Plate, bearing the devices and inscription of the medal.

November 23. 1829.

At an EXTRAORDINARY GENERAL MEETING held this day, Dr HOPE, Vice-President, in the Chair, the following Office-Bearers were elected for the ensuing year :

Sir WALTER SCOTT, Bart. President.

Right Hon. the LORD CHIEF BARON,

Hon. LORD GLENLEE,

Hon. LORD NEWTON,

Dr T. C. HOPE,

Professor RUSSELL,

HENRY MACKENZIE, Esq.

JOHN ROBISON, Esq. General Secretary.

Rev. E. B. RAMSAY,

Dr J. C. GREGORY,

THOMAS ALLAN, Esq. Treasurer.

JAMES SKENE, Esq. Curator of the Museum.

JOHN STARK, Esq. Assistant Curator.

} Vice-Presidents.

} Secretaries to the Ordinary Meetings.

COUNCILLORS.

JAMES HUNTER, Esq.	Sir HENRY JARDINE.
Dr ALISON.	Professor JAMESON.
Sir WILLIAM HAMILTON, Bart.	Sir DAVID MILNE.
Rev. Dr BRUNTON.	Sir G. S. MACKENZIE, Bart.
Dr BREWSTER.	Dr DUNCAN.
Captain BASIL HALL, R. N.	Professor WALLACE.

The following Committee was appointed to audit the Treasurer's Accounts :

PATRICK NEILL, Esq.	JOHN ROBISON, Esq.
J. G. KINNEAR, Esq.	

 ORDINARY MEETINGS.

December 7. 1829.

MEMBERS ELECTED.

ORDINARY.

JAMES WALKER, Esq. W. S.
 WILLIAM BALD, Esq. M. R. I. A.
 WHITELAW AINSLIE, M.D. M. R. A. S.

January 18. 1830.

At this Meeting, a Motion, of which due notice had been given at the Meeting of the 21st of December 1829, to alter the 16th Law, so far as to add an Assistant Curator to the Office-Bearers in Council, was made from the Chair, and agreed to unanimously.

February 1. 1830.

MEMBER ELECTED.

ORDINARY.

Colonel PITMAN, Hon. E. I. C. Service.

March 1. 1830.

MEMBERS ELECTED.

ORDINARY.

J. T. GIBSON CRAIG, Esq. W. S.

ARCHIBALD ALISON, Esq. Advocate.

April 5. 1830.

MEMBERS ELECTED.

ORDINARY.

Hon. MOUNTSTUART ELPHINSTONE.

JAMES SYME, Esq. Surgeon, Edinburgh.

THOMAS BROWN, Esq. of Langfine.

November 22. 1830.

At a GENERAL MEETING held this day, Dr HOPE, Vice-President, in the Chair, the following Office-Bearers were elected for the ensuing year :

Sir WALTER SCOTT, Bart. President.

The Hon. LORD GLENLEE,	}	Vice-Presidents.
The Hon. LORD NEWTON,		
Dr HOPE,		
Professor RUSSELL,		
HENRY MACKENZIE, Esq..		

JOHN ROBISON, Esq. General Secretary.

Dr J. C. GREGORY,	}	Secretaries to the Ordinary Meetings.
Dr CHRISTISON,		

THOMAS ALLAN, Esq. Treasurer.

JAMES SKENE, Esq. Curator.

JOHN STARK, Esq. Assistant Curator.

COUNCILLORS.

Dr BREWSTER,	Dr DUNCAN.
Capt. BASIL HALL, R. N.	Professor WALLACE.
Sir HENRY JARDINE.	Sir T. M. BRISBANE.
Professor JAMESON.	Dr GREVILLE.
Sir DAVID MILNE.	JAMES JARDINE, Esq.
Sir GEORGE MACKENZIE, Bart.	Dr HIBBERT.

The following Committee was appointed to audit the Treasurer's account.

PATRICK NEILL, Esq.	JOHN GARDINER KINNEAR, Esq.
JOHN ROBISON, Esq.	Mr KINNEAR, Convener.

ORDINARY MEETINGS.

December 6. 1830.

MEMBERS ELECTED.

ORDINARY.

JAMES L'AMY, Esq. Advocate.

THOMAS BARNES, Esq. M. D. Carlisle.

Notice was given, that a Motion would be made on Monday, 3d January 1831, to give power to the Council to dispense with the exaction of the fees of entrance and annual contribution in certain cases.

January 3. 1831.

MEMBERS ELECTED.

HONORARY.

His Royal Highness THE DUKE OF SUSSEX.

ORDINARY.

JAMES D. FORBES, Esq. Advocate.

The following Motion was made by Mr ROBISON:—

“ That in the event of any case occurring, in which it may appear that it would tend to the advancement of science, and to the promotion of the general interests of the Royal Society, it shall be competent to the Council to dispense with the exaction of the usual fees of admission and annual contribution, by a resolution to be proposed at one Ordinary Meeting of Council, and to be passed at a subsequent one.”

It was at the same time explained to the Meeting, that the object of this Motion was to enable the Council to arrange for the admission into the Society of persons whose eminence in scientific pursuits should make their association expedient for the reputation of the Society, but to whom the amount of the fees might be inconvenient.

The Motion having been put from the Chair, and having been seconded by Dr WHITELAW AINSLIE, was carried unanimously.

February 7. 1831.

MEMBERS ELECTED.

ORDINARY.

The Right Hon. JAMES ABERCROMBY, Lord Chief Baron.
JOHN ABERCROMBIE, Esq. M. D.
DONALD SMITH, Esq.
Captain SAMUEL BROWN, R. N.

April 4. 1831.

MEMBERS ELECTED.

ORDINARY.

O. TYNDAL BRUCE, Esq. of Falkland.
DAVID BOSWELL REID, Esq. M. D.
The Rev. W. H. MARRIOT, A. M. Trinity College, Cambridge.
T. S. DAVIES, Esq. Bath.

At this Meeting Dr GREGORY gave notice of a Motion to alter the 9th Law, so far as to diminish the period which at present intervenes between the first reading of the name of a Candidate and the day of his election.

LIST OF THE PRESENT ORDINARY MEMBERS IN THE ORDER OF
THEIR ELECTION.

HIS MAJESTY THE KING PATRON.

Date of
Election.

James Hamilton *senior*, M. D. *Edinburgh*.

Sir William Miller, Baronet, Lord Glenlee.

James Russell, Esq. *Professor of Clinical Surgery*.

The above Gentlemen were Members of the Edinburgh Philosophical Society.

1783. Honourable Baron Hume.

Sir William Macleod Bannatyne, Bart.

The above Gentlemen were associated with the Members of the Philosophical Society at the Institution of the Royal Society in 1783.

The following Members were regularly elected.

1784. Sir James Hall, Baronet, F. R. S. Lond.

Honourable Lord Eldin.

Reverend Archibald Alison, LL. B. *Edinburgh*.

1785. James Hare, M. D. *late of Calcutta*.

1787. James Home, M. D. *Professor of the Practice of Physic*.

1788. Thomas Charles Hope, M. D. F. R. S. Lond. *Professor of Chemistry*.

Right Honourable Charles Hope, *Lord President of the Court of Session*.

1793. Sir Alexander Muir Mackenzie, Bart. *of Delvin*.

1795. The Very Reverend Dr George Husband Baird, *Principal of the University*.

- Date of
Election.
1795. Robert Hamilton, Esq. *Professor of Public Law.*
1796. The Honourable Baron Sir Patrick Murray, Baronet.
Andrew Berry, M. D. *Edinburgh.*
1797. Andrew Duncan, M. D. *Professor of Materia Medica.*
1798. Alexander Monro, M. D. *Professor of Anatomy, &c.*
Right Honourable Sir John Sinclair, Bart.
1799. Thomas Macknight, D. D.
Honourable Lord Robertson.
Sir George S. Mackenzie, Baronet, F. R. S. Lond.
Robert Jameson, Esq. *Professor of Natural History.*
1800. Gilbert Innes, Esq. *of Stow.*
Sir Walter Scott, Baronet, *of Abbotsford.*
1802. Colonel D. Robertson Macdonald.
1803. John Jamieson, D. D.
Thomas Telford, Esq. *Civil Engineer.*
Reverend Dr Andrew Brown, *Professor of Rhetoric.*
1804. William Wallace, Esq. *Professor of Mathematics.*
Honourable Lord Newton.
1805. Thomas Allan, Esq. F. R. S. Lond.
Thomas Thomson, M. D. F. R. S. Lond. *Professor of Chemistry, Glasgow.*
1806. Robert Ferguson, Esq. *of Raith*, F. R. S. Lond.
George Bell, Esq. *Surgeon, Edinburgh.*
George Dunbar, Esq. *Professor of Greek.*
1807. Sir James Montgomery, Baronet, *of Stanhope.*
John Leslie, Esq. *Professor of Natural Philosophy.*
John Campbell, Esq. *of Carbrook.*
Thomas Thomson, Esq. *Advocate.*
William Fraser Tytler, Esq. *Advocate.*
1808. James Wardrop, Esq. *Surgeon Extraordinary to his Majesty.*
David Brewster, LL. D. F. R. S. Lond.
1811. Charles Bell, Esq. *Surgeon, London.*
Alexander Nimmo, Esq. *Civil Engineer.*
Reverend Andrew Stewart, M. D. *Erskine.*
David Ritchie, D. D. *Professor of Logic.*
Major-General Sir Thomas Makdougall Brisbane, K. C. B.
1812. General Dyce.
John Thomson, M. D. *Edinburgh.*
James Jardine, Esq. *Civil Engineer.*
Captain Basil Hall, R. N. F. R. S. Lond.

Date of
Election.

1812. J. G. Children, Esq. F. R. S. Lond.
 Alexander Gillespie, Esq. *Surgeon, Edinburgh.*
 W. A. Caddell, Esq. F. R. S. Lond.
 Macvey Napier, Esq. F. R. S. Lond.
 James Pillans, Esq. *Professor of Humanity.*
 Sir George Clerk, Bart. M. P. and F. R. S. Lond.
 Daniel Ellis, Esq. *Edinburgh.*
13. William Somerville, M. D. F. R. S. London.
 Henry Davidson, M. D. *Edinburgh.*
1814. Sir Henry Jardine, *King's Remembrancer in Exchequer.*
 Patrick Neill, Esq. *Secretary to the Wernerian and Horticultural Societies.*
 Right Honourable Lord Viscount Arbuthnot.
 Reverend John Thomson, *Duddingston.*
 John Fleming, D. D. *Flisk.*
 John Cheyne, M. D. *Dublin.*
 Sir James Macintosh, Bart. *London.*
 Lieut.-Colonel Tytler, *Edinburgh.*
 Alexander Brunton, D. D. *Professor of Oriental Languages.*
 Professor George Glennie, *Marischall College, Aberdeen.*
1815. Gilbert Laing Meason, Esq. *of Lindertis.*
 Robert Stevenson, Esq. *Civil Engineer.*
 Sir Thomas Dick Lauder, Bart. *of Fountainhall.*
 Henry Home Drummond, Esq. *of Blair-Drummond, M. P.*
 Charles Granville Stewart Menteach, Esq. *of Closeburn.*
 William Thomas Brande, Esq. F. R. S. Lond. and *Professor of Chemistry in
 the Royal Institution.*
1816. Colonel Thomas Colby, F. R. S. *Royal Engineers.*
 Leonard Horner, Esq. F. R. S. Lond.
 Henry Colbrooke, Esq. *Director of the Asiatic Society of Great Britain.*
 George Cook, D. D. *Laurcnckirk.*
 Right Honourable William Adam, *Lord Chief Commissioner.*
 Honourable Lord Fullerton.
 Thomas Jackson, LL. D. *Professor of Natural Philosophy, St Andrew's*
 John Robison, Esq. *Edinburgh.*
 Hugh Murray, Esq. *Edinburgh.*
1817. The Honourable Baron Clerk Rattray.
 Right Honourable the Earl of Wemyss and March.
 John Wilson, Esq. *Professor of Moral Philosophy.*
 Honourable Lord Meadowbank.

Date of
Election.

1817. James Hamilton Dickson, M. D. *Clifton*.
 William P. Alison, M. D. *Professor of the Theory of Physic*.
 James Skene, Esq. *of Rubislaw*.
 Reverend Robert Morehead, *Edinburgh*.
 Robert Bald, Esq. *Civil Engineer*.
 Thomas Sivright, Esq. *of Meggetland*.
1818. William Richardson, M. D. *Harrowgate*.
 Right Honourable Lord Napier.
 Harry William Carter, M. D. *Oxford*.
 Patrick Miller, M. D. *Exeter*.
 John Craig, Esq. *Edinburgh*.
 John Watson, M. D.
 John Hope, Esq. *Dean of Faculty*.
 Major James Alston *of Auchendar*.
 William Ferguson, M. D. *Windsor*.
 Sir William Hamilton, Bart. *Professor of Civil History*.
1819. Right Honourable Lord John Campbell, F. R. S. Lond. and M. R. I.
 Dr Shoolbred, *Calcutta*.
 Patrick Fraser Tytler, Esq. *Advocate*.
 Patrick Murray, Esq. *of Simprim*.
 James Muttelbury, M. D. *Bath*.
 Thomas Stewart Traill, M. D. *Liverpool*.
 Mr Alexander Adie, *Optician, Edinburgh*.
 William Couper, M. D. *Glasgow*.
 Marshall Hall, M. D. *Nottingham*.
 John Borthwick, Esq. *Advocate*.
 Richard Phillips, Esq. F. R. S. *London*.
 Reverend William Scoresby.
 George Forbes, Esq. *Edinburgh*.
1820. James Hunter, Esq. *of Thurston*.
 Right Honourable David Boyle, *Lord Justice-Clerk*.
 James Keith, Esq. *Surgeon, Edinburgh*.
 Right Honourable Sir Samuel Shepherd.
 James Nairne, Esq. W. S. *Edinburgh*.
 John Colquhoun, Esq. *Advocate*.
 Lieutenant-Colonel M. Stewart.
 Charles Babbage, Esq. F. R. S. *Lond*.
 Thomas Guthrie Wright, Esq. *Auditor of the Court of Session*.

Date of
Election.

1820. John F. W. Herschel, Esq. F. R. S. Lond.
 Adam Anderson, Esq. A. M. *Rector of the Academy, Perth.*
 John Schank More, Esq. *Advocate.*
 George Augustus Borthwick, M. D. *Edinburgh.*
 Robert Dundas, Esq. *of Arniston.*
 Samuel Hibbert, M. D.
 Robert Haldane, D. D. *Principal of St Mary's College, St Andrew's.*
 Sir John Meade, M. D. *Weymouth.*
 Dr William Macdonald *of Ballyshear.*
 John Hall, Esq. *younger of Dunglass.*
 Sir John Hay, Bart. *of Smithfield and Hayston.*
 Sir George Ballingall, M. D. *Professor of Military Surgery.*
1821. Major-General Straton, C. B. &c. &c.
 Robert Graham, M. D. *Professor of Botany.*
 A. N. Macleod, Esq. *of Harris.*
 Sir James M. Riddell, Bart. *of Ardnamurchan.*
 Archibald Bell, Esq. *Advocate.*
 John Clerk Maxwell, Esq. *Advocate.*
 John H. Wishart, Esq. *Surgeon, Edinburgh.*
 John Lizars, Esq. *Surgeon, Edinburgh.*
 John Cay, Esq. *Advocate.*
 Sir Charles Gieséckè, *Professor of Mineralogy to the Dublin Society.*
 Robert Kay Greville, LL. D. *Edinburgh.*
 Robert Hamilton, M. D. *Edinburgh.*
 Sir Archibald Campbell, Bart.
 Sir David Milne, K. C. B.
 Colonel Mair, *Deputy Governor of Fort George.*
 A. R. Carson, Esq. *Rector of the High School, LL. D.*
 James Buchan, M. D. *Edinburgh.*
 James Tytler, Esq. *of Woodhouselee, W. S.*
1822. Francis Chantry, Esq. F. R. S. London, &c.
 Edward Troughton, Esq. F. R. S. London, &c.
 James Smith, Esq. *of Jordanhill.*
 William Bonar, Esq. *Edinburgh.*
 Rev. H. Parr Hamilton, *Cambridge.*
 Captain J. D. Boswall, R. N. *of Wardie.*
 George A. Walker Arnott, Esq. *Advocate.*
 Rev. John Lee, M. D. *Edinburgh.*

Date of
Election.

1822. John Ayton, Esq. *of Inchnarnie.*
 Sir James South, F. R. S. *London, &c.*
 Lieutenant-Colonel Martin Whyte, *Edinburgh.*
 Walter Frederick Campbell, Esq. *of Shawfield, M. P.*
 George Joseph Bell, Esq. *Professor of Scots Law.*
 Dr William Dyce, *Aberdeen.*
 W. C. Trevelyan, Esq. *Wallington.*
 Robert Abercromby, Esq. *younger of Birkenbog.*
 Thomas Shortt, M. D. *Edinburgh.*
 Dr Wallich, *Calcutta.*
1823. The Right Honourable Sir George Warrender, Bart. *of Lochend.*
 John Russell, Esq. W. S. *Edinburgh.*
 John Shaw Stewart, Esq. *Advocate.*
 Alexander Hamilton, M. D. *Edinburgh.*
 Right Honourable Sir William Rae, Bart. *of St Catherine's.*
 Sir Robert Dundas, Bart. *of Beechwood.*
 William Cadell, Esq. *of Cockenzie.*
 Sir William Knighton, Bart.
 Sir Edward French Bromhead, Bart. A. M. F. R. S. Lond., *Thurlesby Hall.*
 Sir James Stuart, Bart. *of Allanbank.*
 Sir Andrew Halliday, M. D.
 John Bonar, Esq. *of Kimmerghame.*
 Captain Thomas David Stuart, *of the Hon. East India Company's Service.*
 Andrew Fyfe, M. D. *Lecturer on Chemistry, Edinburgh.*
 Robert Bell, Esq. *Advocate.*
 Captain Norwich Duff, R. N.
 Warren Hastings Anderson, Esq.
 Alexander Thomson, Esq. *of Banchory, Advocate.*
 Liscombe John Curtis, Esq. *Ingsdon House, Devonshire.*
 Robert Knox, M. D. *Lecturer on Anatomy, Edinburgh.*
 Robert Christison, M. D. *Professor of Medical Jurisprudence.*
 John Gordon, Esq. *of Cairnbulg.*
- 1824 George Harvey, Esq. F. R. S. Lond. *Plymouth.*
 Dr Lawson Whalley, *Lancaster.*
 William Bell, Esq. W. S. *Edinburgh.*
 Alexander Wilson Philip, M. D. *London.*
 James Hamilton jun., M. D. *Professor of Midwifery in the University of Edinburgh.*
 Admiral Adam, R. N.

Date of
Election.

1824. Robert Grant, M. D. *Professor of Comparative Anatomy in the London University.*
 Claud Russell, Esq. *Accountant, Edinburgh.*
 Rev. Dr William Muir, *one of the Ministers of Edinburgh.*
 W. H. Playfair, Esq. *Architect, Edinburgh.*
 John Argyle Robertson, Esq. *Surgeon, Edinburgh.*
 James Pillans, Esq. *Edinburgh.*
 James Walker, Esq. *Civil Engineer.*
 William Newbigging, Esq. *Surgeon.*
 William Wood, Esq. *Surgeon, Edinburgh.*
 William Crosbie Mair, M. D. *London.*
 John Campbell, M. D. *Edinburgh.*
 George Anderson, Esq. *Inverness.*
1825. Rev. John Williams, *Rector of the Edinburgh Academy.*
 W. Preston Lauder, M. D.
 Right Honourable Lord Ruthven.
 Major Leith Hay *of Rannes.*
 Edward Turner, M. D. *Professor of Chemistry to the London University.*
 Dr Reid Clanny, *Sunderland.*
 John Archibald Stewart, Esq. *younger of Grantully.*
 Sir William Jardine, Bart. *of Applegarth.*
 Alexander Wood, Esq. *Advocate.*
 Rev. Dionysius Lardner, *London University.*
1826. George Macpherson Grant, Esq. *of Ballindalloch.*
 William Renny, Esq. *W. S. Solicitor of Stamps.*
 Elias Cathcart, Esq. *Advocate.*
 Andrew Clephane, Esq. *Advocate.*
 Rev. George Coventry.
 Sir David Hunter Blair, Bart.
 George Moir, Esq. *Advocate.*
 John Stark, Esq. *Edinburgh.*
1827. James Weddell, Esq. R. N.
 John Gardiner Kinnear, Esq. *Edinburgh.*
 William Burn, Esq. *Edinburgh.*
 James Russell *junior*, M. D. *Edinburgh.*
 Prideaux John Selby, Esq.
 Henry Witham, Esq.
 John Reddie, Esq. LL. D. *Edinburgh.*
 The Rev. Dr Robert Gordon, *Edinburgh.*
 James Wilson, Esq. *Edinburgh.*

Date of
Election.

1827. The Rev. Edward Bannerman Ramsay, A. B. of *St John's College, Cambridge*.
James Walker, D. D. of *St John's College, Cambridge*.
Alexander Copland Hutchinson, Esq. *Surgeon, London*.
George Swinton, Esq. *Secretary to Government, Calcutta*.
1828. Sir Francis Walker Drummond, Bart.
Sir William G. Gordon Cumming, Bart.
Erskine D. Sandford, Esq. *Advocate*.
David Maclagan, M. D. *Edinburgh*.
James Craufurd Gregory, M. D. *Edinburgh*.
Sir Alexander Keith, *Knight Marischal*.
Captain Maxwell, *K. D. Guards*.
John Forster, Esq. *Architect, Liverpool*.
Thomas Graham, Esq. A. M., *Glasgow*.
Thomas Hamilton, Esq. *Edinburgh*.
David Milne, Esq. *Advocate*.
Dr Manson, *Nottingham*.
William Burn Callender, Esq.
1829. Andrew Skene, Esq. *Advocate*.
A. Colyar, Esq.
William Gibson Craig, Esq. *Advocate*.
Charles Ferguson, Esq. *Advocate*.
James Ewing, Esq. LL. D. *Glasgow*.
Duncan Macneill, Esq. *Sheriff-depute of Perth*.
The Rev. John Sinclair, A. M. *Pembroke College, Oxford*.
Arthur Connell, Esq. *Advocate*.
James Hope Vere, Esq. of *Craigiehall*.
Bindon Blood, Esq. M. R. I. A.
James Walker, Esq. W. S.
William Bald, Esq. M. R. I. A.
Whitelaw Ainslie, M. D. M. R. A. S.
1830. Colonel Pitman, *Hon. East India Company's Service*.
J. T. Gibson Craig, Esq. W. S.
Archibald Alison, Esq. *Advocate*.
Honourable Mountstuart Elphinstone.
James Syme, Esq. *Surgeon, Edinburgh*.
Thomas Brown, Esq. of *Langfine*.
James L'Amy, Esq. *Advocate*.
Thomas Barnes, M. D. *Carlisle*.
1831. James D. Forbes, Esq. *Advocate*.

Date of
Election.

1831. The Right Honourable James Abercromby, *Lord Chief Baron.*
John Abercrombie, M. D.
Donald Smith, Esq.
Captain Samuel Brown, R. N.
O. Tyndal Bruce, Esq. *of Falkland.*
The Rev. W. H. Marriot, A. M. *Trin. College, Cambridge.*
T. S. Davies, Esq. *Bath.*

LIST OF NON-RESIDENT AND FOREIGN MEMBERS ELECTED
UNDER THE OLD LAWS.

Sir Gilbert Blane, M. D. F. R. S. *London.*
Right Honourable the Earl of Dundonald.
Right Honourable Sir Robert Liston, Bart.
M. Le Chevalier, *Paris.*
Dr S. L. Mitchell, *New York.*
Right Honourable Lord Wallace.
John Gillies, LL. D. *Historiographer to his Majesty.*
M. P. Prevost, *Geneva.*
Rev. Walter Fisher, *Cranston.*
Rev. Bishop Gleig, *Stirling.*
Charles Hatchet, Esq. F. R. S. Lond.
Sir Henry Steuart, Bart. *of Allanton.*
Sir William Blizzard, M. D. F. R. S. Lond.
Thomas Blizzard, Esq.
Sir William Ouseley, Bart.
Sir James Macgrigor, M. D.
Richard Griffiths, Esq. *Civil Engineer.*

LIST OF HONORARY AND FOREIGN MEMBERS ELECTED UNDER
THE NEW LAWS.

CLASS OF HONORARY MEMBERS LIMITED TO 21.

Baron Cuvier, *Secretary to the Institute of France.*
 M. le Baron Humboldt, *Member of the Institute of France.*
 M. Gay Lussac, *Member of the Institute of France.*
 M. Biot, *Member of the Institute of France.*
 M. Arago, *Member of the Institute of France.*
 His Royal Highness Prince Leopold.
 His Royal Highness the Archduke Maximilian.

*The above Members were elected before the New Class of Foreign
 Members was established.*

His Imperial Highness the Archduke John of Austria.
 M. Le Chevalier Joseph Hammer.
 M. Goethe.
 Rev. Dr Brinkley, F. R. S. Lond., *and President of the Royal Irish Academy.*
 Robert Brown, Esq. F. R. S. Lond. &c. &c.
 Jacob Berzelius, M. D. F. R. S. Lond. *Professor of Chemistry, Stockholm.*
 Davies Gilbert, Esq. M. P., F. R. S.
 His Royal Highness the Duke of Sussex, *President of the Royal Society of London.*

CLASS OF FOREIGN MEMBERS LIMITED TO 36.

M. Le Chevalier Legendre, *Member of the Institute of France.*
 M. Poisson, *Member of the Institute of France.*
 M. le Baron de Prony, *Member of the Institute of France.*
 M. Brochant, *Member of the Institute of France.*
 Baron Leopold Von Buch, *Berlin.*
 M. Gauss, *Professor of Mathematics, Göttingen.*
 M. Blumenbach, *Professor of Natural History, Göttingen.*
 Count Volta, *Como.*
 M. J. C. L. Simonde de Sismondi.
 Baron Degerando.

- Baron Krusenstern, *Member of the Academy of Sciences at St Petersburg.*
M. Oersted, *Secretary to the Royal Society of Denmark.*
M. Ampere, *Member of the Institute of France.*
M. Schumacher, *Professor of Astronomy at Copenhagen.*
M. Mohs, *Professor of Mineralogy at Freyberg.*
David Hosack, M. D. F. R. S. *New York.*
Nathaniel Bowditch, Esq. *Salem, Massachussets.*
M le Baron Larrey, *Member of the Institute of France.*
Sir Henry Bernstein, *Professor of Oriental Literature in the University of Berlin.*
M. De Candolle, *Geneva.*
Dr Olbers, *Bremen.*
M. Frederick Munter, *Bishop of Zealand.*
M. Oriani, *Milan.*
M. le Baron Dupin, *Member of the Institute of France.*
M. Brongniart, *Member of the Institute of France.*
The Chevalier Burg, *Vienna.*
M. Bessel, *Konigsberg.*
M. Thenard, *Member of the Institute of France.*
M. Haidinger, *Vienna.*
M. Mitscherlich, *Professor of Chemistry in the University of Berlin.*
M. Gustavus Rose, *Professor of Mineralogy in the University of Berlin.*
G. Moll, *Professor of Natural Philosophy in the University of Utrecht.*
M. Stromeyer, *Professor of Chemistry in the University of Göttingen.*
M. Hausmann, *Professor of Mineralogy in the University of Göttingen.*
John James Audubon, Esq. *M. W. S.*
Le Chevalier Bouvard, F. R. S. Lond., *Member of the Institute of France.*

LIST OF DECEASED MEMBERS, AND OF MEMBERS RESIGNED,
FROM 1826 TO 1830.

(N. B.—This List is necessarily incomplete.)

Sir William Drummond, Bart. *of Logie Almond.*
The Right Honourable the Earl of Traquair.
George Jardine, A. M., *Professor of Logic, Glasgow.*
Andrew Duncan *senior*, M. D. &c.
Charles Stuart, M. D.
Dugald Stewart, Esq.
Honourable Lord Hermand.
Robert Blair, M. D.
General Dirom, *of Mount Annan.*
Rev. Sir Henry Moncrieff Wellwood. Bart.
Sir William Arbuthnot, Bart.
James Bryce, Esq. *Surgeon.*
Robert Allan, Esq. *Surgeon.*
Sir William Forbes, Bart. *of Pitsligo.*
John Barclay, M. D.
Rev. Dr William Ritchie.
John Yule, M. D.
Francis Hamilton, M. D. F. R. S.
Sir John Hay, Bart.
Major-General David Stewart *of Garth.*
Alexander Kennedy, M. D.
John Hennen, M. D.
John Veitch, M. D.
Andrew Waddell, Esq.
Alexander Waddell, Esq.
George Kellie, M. D.
H. W. Williams, Esq.
John Hugh Maclean, Esq.
John Hunter, LL. D.
Right Honourable the Earl of Morton.
Mr Jefferson.
The Rev. Thomas Somerville.
Robert Freer, M. D.

Major Rennell, F. R. S. Lond.
Richard Chenevix, Esq. F. R. S. Lond.
H. H. Blackadder, Esq. *Surgeon.*
Dr James Hare, *jun. late of Calcutta.*
Thomas Kinnear, Esq.
Henry Mackenzie, Esq.
Colin Mackenzie, Esq. *of Portmore.*
Andrew Coventry, M. D. *Professor of Agriculture.*
Rev. William Traill, LL. D.
Sir Humphrey Davy, Bart., F. R. S. Lond.
W. H. Wollaston, M. D., F. R. S. Lond.
M. Vauquelin, *Member of the Institute of France.*
Le Marquis de Laplace, *Member of the Institute of France.*
John Fleming, M. D. M. P.

RESIGNATIONS.

Right Honourable Lord Gray.
Dr Howell.
The Rev. Thomas Sheepshanks.
Alexander Munro, Esq.
James Hall, Esq. *Advocate.*
John Dewar, Esq. *Advocate.*
Dr Macwhirter.

LIST OF PRESENTS, CONTINUED FROM VOL. X. P. 483.

1826.	PRESENTS.	DONORS.
Dec. 4.	Memorie della Reale Accademia delle Scienze di Torino, Tom. XXX. Memoirs of the Academy of Berlin for 1822 and 1823. Renel's Astronomical observations for 1824. Weddell's Voyage to the South Pole. Guiding on the Botanic Garden of St Vincent. Flora Batava, Nos. 68, 69, 70, and 71.	Royal Academy of Sciences of Turin. Royal Academy of Sciences of Berlin. The Author. Ditto. Ditto. His Majesty the King of the Netherlands. The Author. Ditto. Ditto.
	South on Right Ascensions. South on 838 Stars. Hamilton's Analytical Geometry.	Thomas Allan, Esq.
18.	The Scapula of a Whale found in sinking a Coal-Pit in Ayrshire. Historical Notices of the Roman Law, by John Reddie, Esq. LL. D. Specimens of Mineral Waters from St Michael's.	The Author. Lord Napier.
1827.		
Jan. 8.	Transactions of the Horticultural Society of London, Part 3. of Vol. VI.	Horticultural Society.
	23. Transactions of do. Part 4. of Vol. VI.	Ditto.
Jan. 23.	Flora Batava, No. 72.	His Majesty the King of the Netherlands.
Feb. 5.	Memoirs of the Astronomical Society of London, Vol. II. Part 2. Asiatic Researches, Vol. XV. American Journal of Science, Vol. X. No. 2. Analytical Treatise on Plane and Spherical Trigonometry, by the Rev. Dr Lardner.	Astronomical Society. Asiatic Society. Professor Silliman Dr Lardner.

1827.	PRESENTS.	DONORS.
Feb. 5.	The Snout of a Sword Fish.	George Swinton, Esq. Calcutta.
19.	Illustrations of Ornithology, by Sir William Jardine, Bart. and P. J. Selby, Esq.	The Authors.
	Various Specimens of Natural History and Manufactures from New Zealand, New South Wales, &c.	Sir T. M. Brisbane, K. C. B.
Mar. 5.	The Tusk of a Mastodon, with some other Bones, found in Woodhill Quarry, near Kilmarnock.	Thomas Allan, Esq.
	Observations on Surgery, by Mr Copland Hutchison.	The Author.
	On the State of Knowledge in the Highlands of Scotland, by Mr Anderson.	Ditto.
	Memoires d'Experiences Electro-Dynamiques, par M. Ampère.	Ditto.
19.	Memoires de Chirurgie Militaire, par Le Baron Larrey,	Ditto.
	Trigonometrical Survey of Mayo, by W. Bald, Esq.	Ditto.
	Transactions of the Horticultural Society of London, Vol. VI. Part 5.	Horticultural Society.
	Transactions of the Royal Asiatic Society, Vol. I. Part 2.	Asiatic Society.
April 2.	Transactions of the Society for the Encouragement of Arts, Manufactures, and Commerce, Vol. XLIV.	The Society of Arts, &c.
	Scientific Aphorisms, by Robert Blair, M. D., F. R. S. Ed.	The Author.
Dec. 3.	Many Specimens and Objects of Natural History and the Fine Arts, collected in India by George Swinton, Esq. Secretary to Government, Calcutta.	George Swinton, Esq.
	Theorie des Phenomenes Electro-Dynamiques, par M. Ampère.	M. Ampère.
	Eulogium on Mr Jefferson.	American Philosophical Society.
	Transactions of the Geological Society of London, Vol. II. Parts 1. and 2.	The Geological Society.
	Memoires de l'Academie Royale des Sciences de l'Institut de France. Année 1823. Tom. VI.	The Academy of Sciences.

1827.	PRESENTS.	DONORS.
Dec. 3.	Distances of the Moon and Four Planets for 1827. Lecture on the Zopuron, by Dr Reid Clanny. Astronomische Beobachtungen, by M. F. B. Bessel. Hourly Meteorological Observations on 17th July 1827. Illustrations of Zoology, No. 1., by James Wilson, Esq. F. R. S. Ed. Philosophy of the Human Voice, by James Rush, M. D. Monumenti Etruschi, in 10 vols. 4to. Plantarum Brasiliensium Nova Genera, 1 vol. folio. Saggio de Esperienze Electrometriche del Dre. Stefano Marianini. Memoria Sopra la Fiamma. Abhandlungen der Akademie der Wissenschaften zu Berlin 1824. Bericht uber die Natur-historischen Reisen, &c. 1826. Kupfer an Krystallen. Travels from India to England, &c. in 1825-26, by Lieutenant Alexander. Descriptions de quelques-uns de Principaux Observatoires d'Allemagne, by M. Quetilet. Flora Batava, Nos. 73. and 74.	M. Schumacher. The Author. Ditto. Mr Thomson, Belfast Institution. The Author. Ditto. M. Camponi. Ditto. Ditto. G. Libri. Royal Academy of Berlin. Baron Humboldt. Royal Academy of Berlin. The Author. Ditto. His Majesty the King of the Netherlands. The Hunterian Society. The Royal Society of Stockholm.
17.	The Hunterian Orations for 1823 and 1826. Transactions of the Royal Society of Stockholm.	
1828.		
Jan. 7.	Models and Papers connected with the Erection of the Eddystone Lighthouse, which belonged to the late Mr Smeaton, Civil-Engineer.	The Right Hon. the Countess of Morton.
21.	A Treatise on Algebra, by the Rev. Dr Lardner. A Treatise on the Ancient Geometrical Analysis, by the Rev. Dr Lardner. Three Orations before the Medico-Botanical Society of London, by John Frost, Esq.	The Author. Ditto. Ditto.

1828.	PRESENTS.	DONORS.
Jan. 21.	Some Account of the Science of Botany, by John Frost, Esq.	The Author.
	Dissertatio de Latitudine Speculæ Havniensis, by M. H. C. Schumacher.	Ditto.
	Astronomische Nachrichten, Nos. 108. to 120.	M. Bessel.
	Report of the Transactions of the Academy of Natural Sciences of Philadelphia during the year 1824.	The Academy.
Feb. 4.	Memoirs of the Astronomical Society of London, Vol. III. Part 1.	The Astronomical Society.
	A Mass of Metallic Iron, supposed to be Meteoric.—See a Memoir by Thomas Allan, Esq. Vol. XI. Part 1. of Transactions of Royal Society of Edinburgh.	Mr Parish.
	18. Transactions of the Society of Arts of London, Vol. XLV.	The Society of Arts.
Mar. 3.	Physiological Illustrations of the Organ of Hearing, by T. Buchanan, C. M.	The Author.
	17. An Analytical System of Conic Sections, by the Rev. H. P. Hamilton, M. A., F. R. S.	Ditto.
Dec. 1.	Models of the Islands of Clare and Eigg, and Drawings illustrative of Topographical Modelling and Delineation, by William Bald, Esq. M. R. I. A. and F. G. S. Lond. &c.	William Bald, Esq.
	Essay on Light, by J. F. W. Herschel, Esq. M. A. F. R. S.	The Author.
	Illustrations of Ornithology, by Sir William Jardine, Bart.	The Author.
	Transactions of the American Philosophical Society, Vol. III. Part 1.	The American Philosophical Society.
	Transactions of the Linnean Society of London, Vol. XV.	The Linnean Society.
	Sur la Combinaison de l'Oxigène et de l'Eau, par M. Thénard.	The Author.
	Portrait of James Watt, Esq.	Mr Watt of Aston-Hall, <i>his Son</i> .
	Some Proof Sheets of a Map of Mayo.	W. Bald, Esq.
	Transactions of the Horticultural Society of London, Vol. VII. Part 2.	The Horticultural Society.

1828.	PRESENTS.	DONORS.
Dec. 1.	Portrait of Mr Murdoch, who first applied Carburretted Hydrogen to the purposes of Illumination.	Edinburgh Gas Light Company.
1829.		
Jan. 5.	Transactions of the Royal Academy of Sciences of St Petersburg, with a Medal in Silver of the Emperor Nicholas.	The Academy of Sciences of St Petersburg.
19.	An Essay on Comets, which obtained the first of Dr Fellowes's Prizes, by David Milne, Esq. A. M. F. R. S. Ed.	The Author.
Feb. 2.	Elements of Natural History, by John Stark, F. R. S. Ed.	The Author.
	Magazine of Natural History, edited by J. C. Loudon, F. L. S. &c. Nos. 1. to 5. inclusive.	The Editor.
	Some Specimens of Minerals.	Lieut. Smart, R. N.
16.	Various Objects of Natural History.	George Swinton, Esq. Calcutta.
	Flora Batava, Nos. 75. and 76.	His Majesty the King of the Netherlands.
March 2.	Supplement to the Edinburgh New Dispensatory, by Andrew Duncan, M. D. F. R. S. Ed. Professor of Materia Medica.	The Author.
	Cast of the Skull of a White Bear.	Mr O'Neill, Sculptor.
16.	Elements of Chemistry, 2d Edition, by Edward Turner, M. D. F. R. S. Ed., Professor of Chemistry in the London University.	The Author.
	Catalogue of Nebulæ and Clusters of Stars in the Southern Hemisphere, observed at Paramatta, by James Dunlop, Esq.	Sir T. M. Brisbane, K. C. B.
	Approximate Distances of Double Stars in the Southern Hemisphere, observed at Paramatta, by James Dunlop, Esq.	Ditto.
April 6.	An Historical and Descriptive Account of the Suspension Bridge constructed over the Menai Strait, with a Brief Notice of Conway Bridge, from Designs by, and under the direction of, Thomas Telford, Esq. F. R. S. Lond. & Ed., by W. A. Provis, C. E.	Thos. Telford, Esq.
Dec. 7.	Essay on Evergreen Oaks, by Isaac Weld, Esq.	The Author.

1829.	PRESENTS.	DONORS.
Dec. 7.	Abhandlungen der Akademie der Wissenschaften zu Berlin, 1825. De Tabulis Macularum Solis Iconographicis. Astronomische Nachrichten, Nos. 157. and 158. Asiatic Researches, Vol. XV. Memoirs of the Astronomical Society of London, Vol. III. Part 2. Memoir of De Witt Clinton, by Dr Hosack. Transactions of the Linnean Society of London. Transactions of the Royal Society of Literature, Vol. I. Part 2. Six Annual Reports of the Whitby Philosophical Society. Ruppel's Atlas of Northern Africa, Twelve Parts. Transactions of the Royal Society of London,—1827, Parts 1. and 2.; 1828, Part 1.; 1829, Part 1. Travels of Ibn Batuta, translated by the Rev. S. Lee, B. D. Extraits des Annales des Sciences Naturelles, 1828. Flora Batava, Nos. 77, 78, and 79. Rapport sur les Machines à Vapeur, par M. De Prony. Eloge de Marquis de La Place, par M. le Baron Fourier. Eloge de M. Ramond, par M. le Baron Cuvier. Notice Historique sur Perronet, par M. De Prony. Rapport au Roi sur la Navigation Interieure de la France, par M. Becquey. Transactions of the Plinian Society. Two Papers by R. I. Murchison, Esq. F. R. S. Portrait of Sir James Hall, Bart. Memoires de Mathematique et de Physique, par M. G. Libri. Flora Batava, Nos. 80. 81. and 82.	<p>The Academy of Sciences of Berlin. M. Sœmmering. M. Bessel. The Asiatic Society. The Astronomical Society. The Author. The Linnean Society. The Royal Society of Literature. The Whitby Philosophical Society. The Frankfort Institution. The Royal Society. The Asiatic Society. M. Brongniart. His Majesty the King of the Netherlands The Author. Ditto. Ditto. Ditto. Ditto. The Plinian Society. The Author. John Hall, Esq. The Author. His Majesty the King of the Netherlands.</p>

1829.	PRESENTS.	DONORS.
Dec. 7.	Observations on the Genus <i>Unio</i> , by Isaac Lee, M. A. P. S. &c. Transactions of the Horticultural Society of London, Vol. VII. Part 3. Journal of Meteorological Observations made in the Garden of the Horticultural Society at Chiswick, for the Years 1826 and 1827, with Reports of the Garden Committee, and of the Instruments employed in these Observations.	The Author. The Horticultural Society. The Horticultural Society.
Dec. 21.	Experimental Inquiries on Electrical Accumulation, by W. S. Harris, Esq.	The Author.
1830.		
Feb. 1.	The Phrenological Journal, from its commencement to the present date.	Sir G. S. Mackenzie, Bart.
Mar. 15.	Transactions of the Agricultural and Horticultural Society of India, Vol. I. Transactions of the Society of Arts, &c. Vol. XLVII. Mécanique Céleste, by the Marquis de La Place, translated, with a Commentary, by Nathaniel Bowditch, LL. D., F. R. S. L. and Ed., Vol. I. Flora Batava, Nos. 83. and 84. A German Pamphlet, by Baron Alexander de Humboldt, on the Systems of Notation.	The Agricultural and Horticultural Society of India. The Society of Arts. Dr Bowditch. His Majesty the King of the Netherlands. The Author.
April 5.	Remarques sur la Loi de la Force Elastique de l'Air, &c. par le Chevalier Avogadro. Memorie della Reale Academia delle Scienze di Torino, Vol. XXXII. and XXXIII.	The Author. The Academy of Turin.
19.	Microscopic Illustrations, &c., by R. C. Goring, M. D., and Andrew Pritchard, Hon. Mem. of the Society of Arts, Edinburgh. Memoires de l'Academie Royale des Sciences de l'Institut de France, pour l'année 1825, Tom. VIII. Abhandlungen der Akademie der Wissenschaften zu Berlin, 1826. Transactions of the Royal Institute of the Netherlands, Vol. VII.	Mr Pritchard. The Academy of Sciences. The Academy. Royal Institute of the Netherlands.

1830.	PRESENTS.	DONORS.
April 19.	New Transactions of Ditto, Vols. I. and II.	Royal Institute of the Netherlands.
	Transactions of the Geological Society of London, Second Series, Vol. II. Part 3. Supplement.	The Geological Society.
	Memoirs of the Astronomical Society of London, Vol. IV. Part 1.	The Astronomical Society.
	Transactions of the Cambridge Philosophical Society, Vol. III. Part 1.	The Cambridge Philosophical Society.
	Bijdragen tot da Natuurkundige Wetenschappen, Amsterdam, Nos. 1, 2, 3, 4.	The Amsterdam Society.
	American Journal of Science and Arts, Vol. XVII. Nos. 1. and 2.	Professor Silliman.
	Astronomische Nachrichten, Nos. 159, 160, and 161.	M. Bessel.
	Histoire Naturelle des Bélemnites, par M. Raspail.	The Author.
Dec. 6.	Flora Batava, Nos. 85. and 86.	His Majesty the King of the Netherlands.
	Transactions of the Royal Irish Academy, Vol. XVI. Part 1.	Royal Irish Academy.
	Reflections on the Decline of Science in England, by Charles Babbage, Esq. F. R. S.	The Author.
	Transactions of the Royal Asiatic Society of Great Britain and Ireland, Vol. II.	The Asiatic Society.
	Transactions of the American Philosophical Society, Vol. III. Part 2.	The American Philosophical Society.
	Elements of Chemistry, by Edward Turner, Esq. M. D. F. R. S. 1831.	Dr Turner.
	Transactions of the Physical Class of the Asiatic Society of Bengal, Part 1.	The Bengal Asiatic Society.
	Catalogue of the Library of the Royal Asiatic Society, and Third Report.	The Asiatic Society.
	System of Conic Sections, by the Rev. H. P. Hamilton.	The Author.
	Observations in Natural History, by G. J. Mulder, 4 Numbers.	The Author.
	Experiments in Electro-Magnetism, by G. Moll.	The Author.
	Observations on the Tyrolese Alps, by R. I. Murchison, Esq.	The Author.

1830.	PRESENTS.	DONORS.
Dec. 6.	On Spasmodic Strictures of the Colon, by John Howship, Esq.	The Author.
	Gleanings in Science, published at Calcutta, Nos. 1-12.	George Swinton, Esq. Calcutta.
	American Journal of Science and Arts, Vol. XIX. Part 1.	Professor Silliman.
	A cask containing the greater part of the body of a Dugong, preserved in spirits.	George Swinton, Esq. Calcutta.
	Specimens of the Edible Nests, from the Eastern Islands.	Ditto.
	Specimens of Amber, from Assam.	Ditto.
	Specimens of different qualities of Paper made from Vegetable Matter in Nepaul.	Ditto.
	A large case containing 150 pounds weight of the Vegetable Matter in a preparatory state, for the purpose of being tried by Paper-makers in this country.	Ditto.
	Specimens of Lackered Work referred to in the communications published in <i>Gleanings in Science at Calcutta</i> .	Ditto.
	Specimens of the Rocks, &c. of the Diamond Mines in India.	
	Plaster Cast of a Fossil Animal. From M. Herm. de Meyer, Frankfort.	
30.	Materia Indica, by Whitelaw Ainslie, M. D. 2 vols.	The Author.
	Observations on the Cholera Morbus of India, by Whitelaw Ainslie, M. D.	Ditto.
	Observations on the Smallpox and Inoculation in Eastern Countries, by Whitelaw Ainslie, M. D.	Ditto.
	Medical, Geographical and Agricultural Reports of a Committee appointed by the Madras Government, to inquire into the Causes of the Epidemic Fever in the provinces of Coimbatore, Madura, Dindigul, and Tinnivelly, &c. during the years 1809, 1810, and 1811; by Whitelaw Ainslie, M. D.	Ditto.
	Clemenza, or the Tuscan Orphan, by Whitelaw Ainslie, M. D.	Ditto.
	A relation of Proceedings concerning the Affairs	

	PRESENTS.	DONORS.
	of the Kirk of Scotland, from August 1637 to July 1638, by John Earl of Rothes. Printed for the Bannatyne Club, by James Nairne, Esq. W. S.	The Editor.
1831.		
Jan. 3.	Observations on Fossil Vegetables, accompanied by Representations of their Internal Structure, as seen through the Microscope, by Henry Witham, Esq. F. R. S. Ed., &c.	The Author.
	An Experimental Inquiry into the Number and Properties of the Primary Colours, and the Source of Colour in the Prism, by Walter Crum, Esq.	Ditto.
	Part of an Aerolite which fell in the territories of the Madras Government in 1810.	Andrew Berry, M. D.
17.	South African Quarterly Journal, Nos. 1, 2, 3.	The South African Institution.
	On the Utility of fixing Lightning Conductors in Ships, by W. S. Harris, Esq.	The Author.
	Experimental Inquiries on Electrical Accumulation, by W. S. Harris, Esq.	Ditto.
	Letter to the Proprietors of Steam-Vessels connected with the Frith of Forth, and others interested in the trade carried on by Steam Navigation, by Captain J. D. Boswell, R. N.	Ditto.
Feb. 7.	The Edinburgh Journal of Natural and Geographical Science, New Series, Nos. 1, 2, conducted by Henry H. Cheek, Esq. F. L. S., &c.	The Editor.
Mar. 7.	Flora Batava, No. 87.	His Majesty the King of the Netherlands.
	Astronomical Observations of Professor Bessel, Parts 13. and 14.	The Author.
21.	Memoirs of the Royal Academy of Turin, Vol. XXXIV.	The Royal Academy of Turin.
	Major Rennell's Geography of Herodotus, 2d Edit. 2 vols.	The Editor.
	Etudes Administratives sur les Landes, by M. le Baron D'Haussez.	The Author.

1831.	PRESENTS.	DONORS.
Mar. 21.	Souvenirs pour servir à la Statistique du Département de l'Isère. By M. le Baron d'Haussez. Address of Earl Stanhope, President of the Medico-Botanical Society, for the Anniversary Meeting, January 1831.	The Author. The Honorary Secretary of the Society.
April 4.	Account of the Meeting of the Cultivators of Natural Science and Medicine at Hamburg, in September 1830. By James F. W. Johnston, Esq. M. A. Charges against the President and Councils of the Royal Society of London. By Sir James South.	The Author. The Author.
April 18.	Illustrations of Zoology, No. 9. By James Wilson, F. R. S. Ed. Transactions of the Horticultural Society of London, Vol. VII. Parts 4 and 5. Transactions of the Royal Society of London for 1830. Parts 1 and 2.	The Author. The Horticultural Society. The Royal Society.

26
20 r



